

TALES FROM THE
**FORLORN
HOPE**



EIGHT ADVENTURES FOR CYBERPUNK® • BY WILLIAM MOSS

CYBERPUNK®

**R. TALSORIAN
GAMES, INC.**



T A L E S O F T H E
**FORLORN
HOPE**

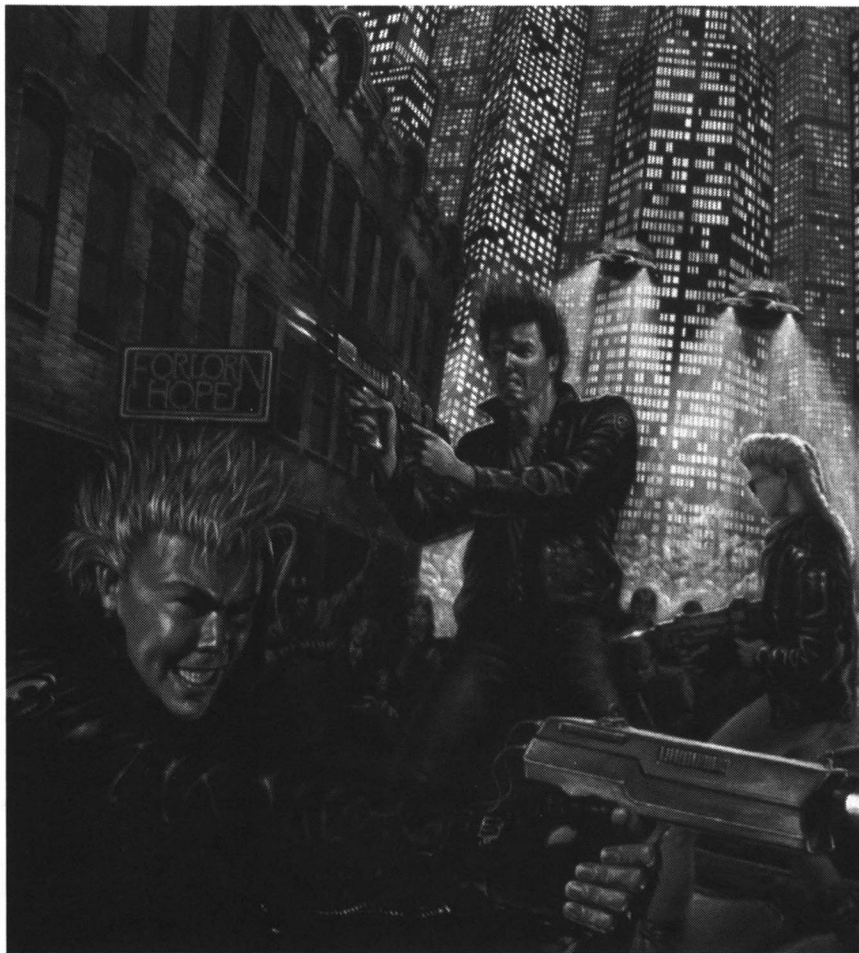

EIGHT ADVENTURES FOR CYBERPUNK® • BY WILLIAM MOSS



INTRODUCTION

2002 The drug problem in the United States has grown to staggering proportions. Although their coca and marijuana crops have been destroyed by specially engineered viruses, the Drug Lords have endured. They have turned the resources of their plantations and empires toward the production of synthetic drugs, many of which are far deadlier than the natural ones they are replacing. Faced with an escalating problem, and political disaster, the U.S. Government struggles for a solution.

2003 The White House, firmly under the control of the Gang of Four, makes an ill-fated decision. All other measures have failed. In a final attempt to destroy the problem at the source American troops are deployed in Colombia, Panama, Northern Venezuela and Ecuador. Their orders are to destroy the plantations, estates, armies and manufacturing capabilities of the drug lords. The press refers to the fighting as the "Central American Action." The name is erroneous, as the bulk of the combat is actually taking place in the South American countries of Colombia and Venezuela.

2005 The fighting has escalated and U.S. forces have bogged down. Not only are they facing opposition from the tough and well organized resources of the Drug Lords, but also from the national armies of the target countries. The Central American Action has become the Central American War. In America, popular sentiment against the war is rising. Not since Vietnam have U.S. forces been in combat for a continuous period longer than four months.

2007 Total cyberwar consumes southern Central America and northern South America. Regional destabilization caused by the fighting has spread the war north into Costa Rica, Nicaragua and Honduras, and south into Peru and Northern Brazil. In this crucible, the original mission of interdicting the drug flow has become secondary. Survival is job one. Opposition to the war rages at home. Congress and the White House clash.

2010 The U.S. admits defeat after seven years of war. Weary and numb, the remaining Cybersoldiers are called home and the painful process of reintegration begins. An entire government is swept out of office in a fury of reform. Nothing was solved. One hundred and fifty thousand Americans are dead. Hundreds of thousands more are physically and emotionally scarred. No one who was there will ever be the same again.

2020 Welcome to the Forlorn Hope.

VETERANS OF THE CYBERWARS

Many American Solos cut their teeth as soldiers in the Central American Wars. They left the U.S. as many things; farm-boys and girls, fresh faced high school graduates, earnest college graduates, blue collar laborers and career soldiers. Upon returning home they found themselves a breed apart. Most had been in country at least two years, some as long as five or six. They were veterans of the toughest combat units; Rangers, SEALs, Green Berets and black ops groups so secret that they had no names. Their reactions had long since adapted to survival under combat conditions in the inhospitable mountains of Central and South America. Some suffered from the aftereffects of combat drugs. Many more had combat cyberware. While their comrades in arms readjusted to the drone of everyday life, these few struggled to find their niche. They were creatures of the edge, addicted to the adrenaline rush, with only one marketable skill. In the end, it was inevitable that they become Solos. And, it was only natural that they seek the company of their own kind.

Forlorn Hope is an adventure pack and source supplement based around a Night City club owned and run by South American veterans and frequented by Solos and Cyberpunks of various backgrounds. The supplement includes a description and history of the bar and detailed backgrounds of the staff and most interesting clients. The bar can serve as a backdrop for any number of adventures and makes a good hangout and rallying point for player characters who are tough enough to prove that they belong there. The people who patronize and work at the club form a useful pool of NPCs to draw from. Use them to cover for weaknesses in player character teams, or just to flesh out your adventures. Remember, if the NPCs seem powerful this is because they are primarily tools to keep adventures moving. If used wisely, they will add to the action without overshadowing the abilities of player characters. Remember also that most of the NPCs are older and more experienced than the average *Cyberpunk* characters.

This supplement contains eight short adventures, each designed to be completed in one play session. The adventures are not connected plot-wise, but each is based around a major NPC from the bar. There are detailed descriptions of all adventure-related NPCs. Feel free to improvise off of the adventures and adjust the power level to fit your group of players. The adventures are designed to be run in sequence, but this can be changed with minor modifications.

When running adventures from *Forlorn Hope*, or when using the bar in your adventures it is important to capture the atmosphere. The patrons of the bar are a close-knit group. Unfamiliar faces will be treated with distrust, reticence or outright hostility. New patrons must prove themselves in some way before they are accepted. But once accepted, a character will have few friends as loyal as those he or she makes at the Forlorn Hope. The first time your characters hang out at the bar, make sure they know that they are not part of the group. The first adventure or two will be their chance to earn the respect of the NPCs.

Now, relax and enjoy yourself as slightly gonzo Media C.J. O'Reilly takes you on a guided tour of the Forlorn Hope and its personalities!

Willam Moss

CONTENTS

THE HOPE

4

AGENCY JOB

27

A HARD ROAD TO GO

34

THE IMPALERS

43

GIRLS' NIGHT OUT

53

COLOMBIAN COOKOUT

64

FALL OF THE AXEMAN

74

TOUGH AS NAILS

85

THE LAST LONG RIDER

94

FORLORN HOPE CLOSEUP MAPS

62,63,72,73

STAFF

TALES FROM THE FORLORN HOPE

Written By William Moss

From an Original Idea By
Frank Frey

Edited By Derek Quintanar
S.E.

Art Direction Matthew Anacleto

Layout Ted Talsorian
Matthew Anacleto

Readers Lisa Pondsmith
Dave Ackerman
Chris Williams
Robin Grey
Janis Sellers

Illustrated By Darrell Midgett
Chris Hockabout

Additional Art Matthew Anacleto
Ted Talsorian

Cover By Doug Anderson
© 1991

R. Talsorian Games
P.O. Box 7356
Berkeley, CA 94707

Copyright © 1992 R. Talsorian Games, Inc. All Rights Reserved. *Cyberpunk* © is R. Talsorian's Trademark name for its adventure game of the dark future. All rights reserved under the Universal Copyright Convention. All incidents, situations, and persons portrayed within are fictional, and any similarity, without satiric intent, of characters living or dead is strictly coincidental.

CP 3121

ISBN# 0-937279-21-8

TALES FROM THE FORLORN HOPE

C.J. O'Reilly

To C. J.
Date 8/3/20 Time 9 AM PM
WHILE YOU WERE OUT
M. John Freeman
of Forlorn Hope
Phone () 554-4673
Area Code Number Extension

TELEPHONED	<input checked="" type="checkbox"/>	PLEASE CALL	
CALLED TO SEE YOU		WILL CALL AGAIN	
WANTS TO SEE YOU		URGENT	

RETURNED YOUR CALL

Message Would like to see rough draft of story. Thank.
(By the way - where were you Tuesday nite!)

Operator _____

AMPAD EFFICIENCY®

REORDER #23-006

*Cathi,
Here's the draft
summe a call w/
changes photos
attached - C.J.*

Solo of Fortune Special Editions.

Solo of Fortune Special Editions returns this quarter with more hard hitting reports on Solos in society. Roving freelance journalist C.J. O'Reilly has been prowling the West Coast for the last few weeks looking for interesting stories and locales. His travels recently took him to Night City, where he discovered an unusual club populated by an unusual cast of characters...

THE FORLORN HOPE—BACK FROM THE FAR SIDE OF CHAOS

Special to Solo Of Fortune By C.J. O'Reilly

-Night City

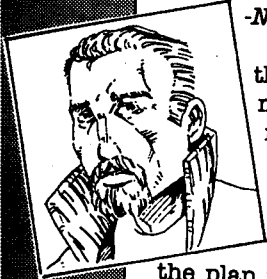

Everybody knows Night City. Spurred into life by the Central California corporate culture of the mid-nineties, it grew from a sleepy, seaside resort town into the United States' youngest metropolis in just twenty-five years. Once home to under thirty thousand people and several farms and ranches, the greater Night City area now boasts a population of over five million people and is one of North America's major corporate and industrial centers.

Night City's accelerated growth was catalyzed by world-famous developer Richard Knight. It was he who lured the mega-corps to the area with the promise of a new technological and business wonderland in the model of the Silicon Valley. Night also created the plan under which the city's growth and economy would be regulated. Night City was to be shaped into a perfect community; molded into an archetype of urban beauty and efficiency by the loving hands of an incorruptible administration, financed by development and corporate dollars. A showcase city for the world.

So sorry, Dick. You know what they say about the best laid plans of mice, men, and development tycoons (who are related to neither). The real Night City is a far cry from the idealized artist's renderings that still sit moldering on the walls of the administration building, next to the portraits of the "City Fathers" (most of whom committed incest with their creation, if you know what I mean). The result was a broke city run first by the mob and then by the corporations, with a corrupt and inept administration. Barely out of its infancy and already in decay.

But there is a good side to this story, hard as that may be to believe. With the death of Night City as the penultimate representation of the ideal American Society came space for those who live outside society. I'm not talking about criminals or gangs, I'm talking about Solos. I'm talking about you and me.

The Forlorn Hope

Just south of the Charter Hill area, near the waterfront, there is a district that has been around since the city was still called Del Coronado, long before the coming of Richard Night. Once it was a lavish tourist area, with Victorian hotels and a board-walk. Now it's given over mostly to warehouses and industrial sites. Tucked away in one corner, among the few remaining buildings from the previous era, there is a bar. It doesn't advertise, not even in the Yellow Pages. It doesn't attract kids or big-hair. It isn't frequented by the corporate power-lunch set. It's not a gang hangout. It's a Solo bar. Its customers are all regulars, and they've all been to the edge . . .and beyond.

Like you and I, they seek the company of their own kind, in a place where the only code of behavior is their own. Where people understand why your eyes are always searching the room, never resting on one thing for more than a few seconds. Where people take the hardware for granted. Where people keep the stories inside the bar. Where people understand what you feel when you get a case of the shakes; they won't condescend or try to make you explain it. They



The Hope

put in sidebar

already know the story, they've been there themselves. Just a nod, a pat on the back and another drink. You'll be there when it catches up with them. Where people *understand*. That's what the customers are looking for. And they've found it here. The neon above the door says "The Forlorn Hope."

The Forlorn Hope is something of a legend among Solos, Nomads, Netrunners, and other edge teasers. It's said that once you've been accepted here, you need never prove yourself again. I was intrigued by what I'd heard, and since I knew I was going to be passing through Night City on this tour, I thought I'd check it out.

The bar may not have an ad in the Yellow Pages, but it is listed in the phone directory. I gave it a call one evening and asked to speak to the proprietor. I was connected with a man who declined to give his name over the phone. I told him who I was, praying that my reputation would make an impression. Heck, everybody needs a little shameless ego gratification. No such luck. When I identified myself, the only response was a clipped "So?" Having crashed and burned with the BIG MEDIA PERSONALITY ploy, I opted instead for humility. I told the nameless man on the other end that I was touring the country for *Solo of Fortune* special editions, taking interesting stories as I could find them.

The Forlorn Hope had a reputation, and I was hoping I could do an article on the place and a few of its regulars. The man said that some of his customers were press-shy and might take a dim view of media exposure. Faced with rejection, I made my final ploy: the old wheedle and concession gambit. I said I would speak only to people who volunteered themselves. Photographs would be taken only with the approval of the management and the subjects. As a fellow veteran, I could understand the sensitivities of his customers. I suggested that he poll them to see what they felt about me dropping by. After some deliberation, he agreed to that proposal. He said he'd call me back.

I spent two hours sitting in my hotel room waiting for the call back. I was beginning to think that I'd been given the brushoff, when the phone finally buzzed. It was the man I'd spoken to. This time he identified himself as Dr. John Freeman, owner and manager of the bar. He said that several regulars had agreed to speak with me, and if it was okay with them, it was okay with him. He wanted to meet me personally first. He suggested that I come down to the bar that night and talk with him. If he liked what he heard, he would give me the run of the place for a couple of days. Not one to argue with an invitation, no matter how guarded, I agreed.

An hour later a taxi dropped me off at the address that Freeman had given. It turned out to be a big, old, four story Victorian hotel left over from the Del Coronado days. A neon sign over the wide, corner doorway gave the name: **Forlorn Hope**. Behind that, the faded remains of the previous sign were visible: Hotel Sierra. That made me laugh. Hotel Sierra . . . Sierra Hotel. I wondered if that was why Freeman chose this building. Music leaked out from behind the double doors. It would have been louder if the ground floor windows weren't bricked up. Only narrow slits remained. That was all right, there wasn't much left to see in that particular neighborhood. I pushed on through the doors.

It didn't take long for me to start feeling uncomfortable. The moment I walked through the door everyone looked at me. If I'd been a regular, I'm quite sure everyone would have gone back to their drinks and jokes. As an unfamiliar face, though, everyone continued to stare. Conversation didn't stop, but there was a noticeable drop in volume. At least the band didn't stop playing. I put on my best casual look and headed for the bar. The Forlorn Hope is in the grand lobby of the old Hotel Sierra, and the bar is where the reception desk once was, at the back of the room, diagonally opposite the front door. It took maybe thirty seconds for me to thread my way through the crowded tables across the room. It felt like a day and a half. As I passed each table, the people sitting there would grow silent, resuming their conversations only once I had passed.

At least I got a good look at the layout in my trek across the room. The lobby had been extensively remodeled to fit the bar. To the left, where once had been a grand staircase, there was a projecting stage just big enough to accommodate the band that was busy jamming away. Further left was a wide hallway leading to new stairs, the backstage area and a couple of restroom cubicles. A line of booths started in the corner and stretched toward the door. The wall to the right of the bar was almost completely lined with more booths. About twenty-five small tables dotted the floor, leaving only enough free space for a small dance-floor. It was impossible to tell what else occupied the upper levels, or lower, if any.

I reached the bar before dying of acute self-consciousness, but only barely. Behind the bar was a large woman dressed in a black outfit that clashed nicely with her shocking pink hair. I flagged her

Forlorn hope. 1539. [ad. Du. *verloren hoop*, lit. 'lost troop' (*hoop* = *Heap*). Cf. *enfants perdus*.] 1. Orig., a picked body of men, detached to the front to begin the attack. Now usually, a storming party. Also *transf.* and *fig.* 1572. b. *pl.* Reckless Bravos 1539. c. A desperate enterprise 1768. 2. With wordplay: A faint hope, a 'hope against hope' 1641.

The Shorter Oxford English Dictionary on Historical Principles, third edition.

down and asked for John Freeman. "Who wants him?" was the terse reply. "C.J. O'Reilly. I spoke to him on the phone this evening." If my name elicited any recognition it didn't show. All I got was a raised pink eyebrow. The barmaid yelled to another woman at the other end of the bar, "Godiva! Go tell the Prof that there's a Mister O'Malley here to see him."

"O'Reilly to see him," she corrected. She gave the counter in front of me a swipe with a rag that looked like it left behind more than it picked up. "Whadlitbe?" I weighed the advantages and disadvantages of staying sober, and ordered a double Jack Daniel's.

John Freeman

I wasn't far into my J.D. when I was joined by a handsome, well-built man in his late forties. "John Freeman. Call me Professor. Everyone does." He offered his hand and I took it. He had a good handshake, firm and brisk. Call me old-fashioned, but that's where I take much of my first impression of a person. Nothing like a limp, clammy handshake to make me reconsider getting to know someone. "C.J. O'Reilly," I offered. "Thanks for talking to me." He nodded.

"Look, why don't we move to a booth. We can talk more easily." He flagged down the pink-haired woman. "Babe, I'm going to talk to O'Reilly for a few minutes. Steer the crowd away for a bit."

"Sure thing, Prof. Take anything with you?" "The usual." The barmaid poured him something pink and fizzy and added a twist. I wondered what sort of high-octane intoxicant it was. "Mineral water and fruit juice," he said, holding it up. "Don't drink no more, myself." So much for my image of the hard-bitten soldier.

Freeman led me over to a booth and we sat. It was a little quieter out of the band's line of fire. I asked if I could tape the conversation for later reference. Freeman agreed. I didn't have to start the conversation. "I don't make a habit out of letting journalists case my club, you know."

"So I gather. Why am I an exception?"

"A few of my regulars have read some of your articles in SOF. You've got several fans in here."

"You wouldn't know it from the reception. I thought nobody recognized me."

"My wife did."

"Your wife?"

"Marianne, the girl with the pink hair."

"She got my name wrong."

"Marianne likes to put the wind up people. It's her hobby. She even does it to me." Freeman paused and downed his drink, then pulled out the twist and chewed on it for a moment before continuing. "The other reason I'm talkin' to you is because you were there. In South Am."

"I was there as a journalist, not a soldier."

"Yes, but you were in combat. That means the folks here can relate to you. And you were a soldier before that. You've been on the edge. That gets your foot in the door. The rest is up to you. It's one thing to be let in here. It's another to actually win the respect of the people you're going to be talking to."

"What am I going to have to do?"

"That's up to them."

The Professor told me a bit about himself. He was a Captain in the Rangers in the Central American War. He led a Long Range Reconnaissance Team for four years. LRT-601 gathered intelligence and ran special operations deep in plantation territory. In 2009 a serious wound forced him out of the Army. He returned to grad-school and finished his Ph.D. in Military History, but rapidly became uncomfortable in the grind of everyday life. Eventually he returned to the people he felt most comfortable with: soldiers and ex-soldiers. If he couldn't fight with them, he would provide for them, and help to maintain the fraternity that he so loved. In 2011, with the help of several people with whom he had served, he bought and restored the Hotel Sierra, and opened the Forlorn Hope in the lobby. It's been thriving ever since.

The Prof met and married his wife, Marianne, during the construction of the bar. I asked him to tell me a bit about her.



← Night crowd at Hope

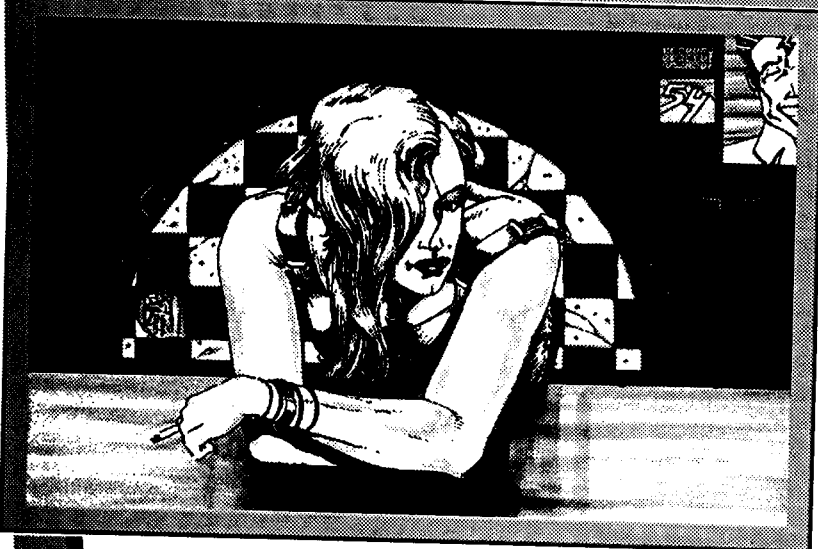

"Marianne's a cut-up. You see, she thinks I'm too serious all the time. She calls me The Straight Man. Her solution is to be comedian enough for the both of us. She's my surrogate sense of humor."

"And she just barmaids?"

"Oh no," the Professor corrected me, "she's the real power down here on the floor. I oversee the management of the bar, but she actually does it. Keeps an eye on the supplies and financing, handles the payroll, all that good business stuff. That leaves me the time to handle the other stuff we do here."

"Any kids?"

"Nope. I'll let you in on a little secret. Marianne's a sex change. She was born male. Got switched in her twenties. It's a

good job. You can't tell that she's a change, except that she can't have kids." Does it ever bother you

"This is a personal question, so don't answer it if you're uncomfortable. Does it ever bother you that your wife was born male?"

"Heck, no! She was a woman when I met her, and that's how I've always thought of her. She's showed me photos, of course, but I've never really been able to associate them with the way she is now."

Behind the Scenes

I asked the Professor to tell me a bit about what goes on in the building. "Well, the bar here, and the rest of the old hotel building serve a variety of purposes. First, it's a place for Solos, Fixers, Netrunners and other freelancers to get together and do business." The Professor gestured out across the room. "I'd say that maybe . . . half of the people out at those tables are discussing deals and planning operations. Course, the rest are just B.S.ing and getting drunk, but everybody needs a holiday. Also, we provide a number of other services here in the building."

"What kind of services?"

"Let's see, we got a weapons maintenance and repair shop. Secure conference and meeting rooms. We've got a job referral service. We've even got a house ripperdoc downstairs." The Prof leaned forward and said in a conspiratorial voice, "He's good too. He ought to be, this gang here needs repairs often enough."

"And you make these services available to all your customers?"

"Certainly, and at far better rates than you could get out on the street. Also, people who come here for services know that they're not going to be ripped off. That makes for good business. One other thing we do, and something that takes a lot of my time. We run a safe house and retreat for soldiers and solos who've been on the edge a little too long, and are getting shaky."

"How's that work?"

"Well, kids who need to get off the street for a while to avoid some heat, or who just need sympathetic ears to talk to and unload some baggage, we'll take 'em in, and if necessary, place them somewhere safe where they can get their act together."

I asked the Professor if he would mind showing me around the club and the rest of the building. We took the short tour. It turns out that the old Hotel Sierra is really five stories: four above ground and one below. The lower level was originally a large storage cellar, but has since been converted into the secure conference rooms and Ripperdoc clinic that Freeman mentioned earlier. I took a look. It's a pretty sophisticated little set up. Other downstairs rooms include secure storage areas and the power and maintenance lockers.

Obviously, the bulk of the ground floor is occupied by the club, but there are some other areas too. There is a backstage area and dressing rooms where the dining room and main kitchen used to be. There is also a new staircase and an elevator to replace the grand staircase that was torn out to make room for the club. (Freeman told me that it hurt to take out the grand staircase, but there was just no other way.) There are also a series of storage rooms that contain supplies, spare furniture and electronic equipment for the club. The main office is located on the first floor, and contains a computer and all the hard-copy and software records for the club.

Marianne 11/14/75
11/14/75

Much of the second floor is cut away to form the high-ceiling room that was once the lobby and is now the bar. Over the stage there is a mezzanine with a long observation window. The window is protected by bulletproof plexiglass, and has a commanding view of the whole club floor and most of the stage. The entire club can be monitored from here, and there are usually one or more security people on station to keep an eye on things below. I also couldn't help noticing that there are slits through which weapons could be fired in an emergency. The security offices and weapons workshop are also located on the second floor, with a small dining room and kitchen for the use of the building residents.

The third floor is the only story that still has its original floor plan. It has twelve guest rooms, several of which are rented out to friends and Solos who need a place to stay. Four of the rooms are reserved for use by employees or close associates of the club who sometimes need a place to crash. Two of the rooms belong to the security chiefs at the club, Icepick and Trigger. They are permanent residents of the building.

The fourth floor has been rebuilt into two large suites, one for the use of William Dolarhyde, and one for the Freemans. The Freemans are permanent residents of the building, and are seldom away for long. Dollar Bill, on the other hand, travels regularly, and stays at his suite only occasionally. He also has an apartment near Night City's corporate center that he uses frequently. The Professor has a secure office in his suite. This is the Professor's usual retreat, and all the records from the various services provided in the club are kept in the files or on the computer in there.

One thing I found interesting: when the Professor remodeled the building, he added a lot of structural reinforcements and sound baffles. Even on a Friday night in full swing, once off the ground floor, it's hard to tell that you're just above or below a club. The sound and vibration is noticeable, but it's been reduced to an unobtrusive level. It must be a great convenience for people staying in the building.

Friends and Associates

Several people from the Professor's old unit work or hang out at the Forlorn Hope. **Gunsights** is a U.S. Marshal stationed in Night City. Back in the war, he was the small arms tech and sniper for LRT-601. He likes to get together and swap stories with the old team-mates, and he spends most of his free evenings at the Hope. He also moonlights in the weapons shop on the second floor.

Hunter Murdoch is a Media now, a Military Affairs correspondent, like yours truly. It turns out that both he and I were studying at the Lazarus Foundation at the same time. Murdoch is good; I've seen his work. He could have sold out to a major corp years ago, but he chose to stay freelance and remain with the people he knows. Ten years ago, in the jungles of Colombia, he was the Professor's psychological operations, propaganda and interrogation specialist.

Icepick is the security specialist at the Forlorn Hope, and director of the six-person security team. He fills the triple duty of electronic security, defense coordination, and plain, old-fashioned bouncing. Icepick was a Navy SEAL. He served as an exchange officer in LRT-601, assisting in maritime operations, heavy weapons and demolitions. When Icepick first joined the unit there was lots of griping from both sides about mudsuckers and Navy pukes. Gradually, mutual respect grudgingly formed, and later, true friendship. Icepick lives in a room on the third floor of the building.

Ringo is among the bartenders at the Forlorn Hope, taking over when Marianne is indisposed. Ringo's a showman, always making noise and drawing attention to himself. He effects an Old-West style, complete with ten-gallon hat and twin six-guns. Rumor around the bar has it that he's pretty fast with the irons. Back in the old-days, he was LRT-601's squad automatic weapons man. Ringo is a good gunsmith, and he often abandons the bar to put in time in the weapons shop with Gunsights.

Sundance is the last member of the unit who works at the bar. She runs waitressing duty with another girl and two waiters. Sundance is very pretty and serene; she always seems to have a smile. She does, however, carry a Ruger Super Redhawk under her vest. According to the Professor, it takes a lot to erase her smile, but when it goes, beware. The gun is liable to come out in a hurry. Sundance was LRT-601's medic and cybertechnician. She is also a member of the Forlorn Hope's house band.

There are several employees at the bar who weren't in LRT-601, although most of them have some kind of combat experience and several were in the war in other units. All are true edge-hawks in one way or another.

William Dolarhyde is a former Army Intelligence officer. During the war he worked closely with the Professor, often coordinating the missions of LRT-601. These days he's a fixer, brokering mercenary missions out of the Forlorn Hope. Known as Dollar Bill to the local crowd, he has a rep as a tough-as-nails bastard and a real hardball player. Some say he has connections in the CIA, KGB and several other international intelligence agencies. It's also said that he will go to great lengths to help a

soldier down on his luck. It's also said that he's well connected into the corporations. Nobody is really sure just how far Dollar Bill's influence extends.

Although John Freeman coordinated the purchase of the building and supervised the construction of the bar, Dollar Bill is the man who put up most of the money. It's his name on the deed. He and the Professor share in all of the major executive decisions. Their relationship is something like that of a CEO and a Chairman of the board. Freeman oversees the day-to-day operation of the bar, and in most ways it's his baby, but Dollar Bill has the ultimate say-so. Fortunately, the two of them are good friends, and seldom disagree with each other.

Trigger is a young woman who helps Icepick with security at the bar. She's a Solo specializing in security penetration and stealth operations. She frequently takes leaves of absence from the bar to run jobs for clients. Trigger is something of an expert on the local crime scene. I was told to ask her if I had any questions about local gangs or crime outfits. Trigger spends a lot of her time with Dollar Bill, although no one seems clear on their relationship; neither would talk about it. Trigger, like her associate, is a permanent resident of the Hotel Sierra building. She lives in a third-floor room.

Godiva is a former Sergeant in the British 22nd SAS regiment. Her unit was wiped out in an IRA ambush. Godiva suspected betrayal, and went snooping around to see what she could find. It turned out that her unit had been sold out by traitorous elements in the British Government. Unfortunately, they caught on to her and turned up the heat. She fled to America, and has been a fixture at the Forlorn Hope since shortly after it opened, tending bar off and on. Like Trigger, Godiva frequently takes leave to run jobs for Dollar Bill and other clients.

Needles is the ripperdoc who works out of the basement of the Forlorn Hope. He was a medic in the Central American wars, but didn't serve in the Professor's unit. Despite his unsettling handle, Needles has a reputation as a good doc, and an expert on the installation and repair of both legitimate and illegal cyberware. He sometimes recruits Sundance for assistance.



The Band

All good clubs have to have a house band, and the Forlorn Hope is no exception. The group is the "**Slaughtered Lambs.**" It doesn't exactly conjure images of romantic ballads and mood music, does it? With a name like that you'd expect to walk into the club and immediately be assaulted by high-tempo chromatic rock at the kind of volumes that would cause massive marine life die-offs in the nearby bay, if it hadn't already been polluted into oblivion. Surprise, surprise! The two women and two men are a tasteful and skilled,

if somewhat over-energetic, R&B and reggae outfit. They play lots of standards (at somewhat accelerated tempos I'm afraid), and also have a catalogue of nifty little songs of their own. Although the Lambs usually go it alone, they have been joined for jam sessions once or twice by the likes of Johnny Silverhand, T.C. McBride and Jamie Waxman. The Lamb's tenure at the Hope is guaranteed, since three of the members are regular bar employees and the fourth is a regular customer. Their performances are frequently impromptu. Someone will suddenly notice that all the members of the band are present and call for a jam. On those nights when the Lambs don't play, other bands from the city are hired to cover the bill. I understand the Hope has a reputation as a rough gig.

Sundance moonlights as a bassist when she's not working. The other woman in the band goes under the handle **Banger**. Naturally, she's the drummer. Waitressing at the bar when the band isn't playing is her "day job." Banger told me that she has every intention of making it to the big time, but meanwhile, the Hope isn't such a bad place to play.

ZZ Destroyer is the guitarist in the band. A few years ago he and his band, Busted Flush, were up and coming street rockers with nation-wide prospects. Until DMS put them out of business by putting two of the members six feet under and one more on permanent life-support. Since DMS seemed intent on finishing the job, ZZ blew New York for Night City. He figures that if he's going to be safe anywhere, it's going to be as an employee of the toughest Solo bar around. When the band isn't playing, ZZ shares table waiting duties with Banger.

The final member of the band is a Jamaican fellow by the name of Robelarde St. James. Robelarde is a member of the New Reformed Rastafarian Church, complete with dreadlocks. Obviously, the band owes much of its reggae feel to him. Robelarde likes to go under the handle **Ras Angabo**. Ras, he told me, means spiritual brother. Angabo was a mythical Jamaican hero who slew the evil serpent Wainaba. Sure thing, Ras. One thing for sure: Ras can lay it down on the keyboards. I am also told that he can lay it down on an interface, and when he's not hanging out at the Hope he's earning a living as a high-demand freelance Netrunner. Ras splits singing duties with Sundance and ZZ. He sometimes takes off for extended periods, leaving the other members of the band to cope as a trio.

The Scene

John Freeman eventually had to get back to business, but he invited me to spend the rest of the evening at the club, and to come back and interview some regulars the following evening. Freeman had been cordial to me, but I was still an unperson to the rest of the bar. I camped out at the back of the booth and watched the evening slide by. I figured I'd make my impression on the locals the following day. The table servers were friendly and fast. I guess they figured that anyone who had received the personal treatment from the Professor deserved good service. I didn't get a discount though, and nobody else made any move to talk to me that evening.

The bar stays active all evening, with a measured but constant flow of people in and out. It looks like many customers come to spend the evening, rather than just dropping in. I guess this is understandable, considering the lack of advertising and the clientele's resistance to new customers. One time drop-ins are not really made to feel welcome. This is not saying that new customers are discouraged, it's just that you have to be willing to put up with some rough treatment the first few visits. New people generally aren't accepted into the fraternity until they prove themselves. They can do this either by standing up to some abuse by the regulars, going out on a mission with them, or proving that they've ridden the edge in some way. Watch out, the crowd is inclined to be skeptical of people who talk big about past achievements, but are unwilling to back their words with action or proof. Empty bragging is probably the worst sin possible in the Hope. All the regulars have danced on the edge for a long time. They know what it's like, and they know that they don't have to explain it to others who know. They certainly don't need some wet-nose wannabe telling them dubious tall tales about world-class accomplishments in combat, netrunning, or streetdealing. The regulars are good at spotting holes in contrived stories.

The younger you are, the more likely you are to get hassled in the Hope. Most of the customers are South Am vets, running toward their mid-thirties. They take a dim view of young hot-shots who think they've seen it all. Conversely, anyone who can prove their status as a South Am combat vet is liable to be accepted very quickly. The positive side to the Hope's exclusivity is that you'll have no closer or more reliable group of friends once you've been accepted. The crowd here doesn't tolerate betrayal, and they don't believe there's any valid excuse for abandoning a comrade. Once you're welcome, you're always welcome, and you'll always be glad to be here.

The club holds about two hundred people, and it looked to me like it was close to capacity all evening. The band kept rolling until about midnight, and then gave up the spotlight to recorded music. Those members of the band who were employees took a half hour break and then started to work and mingle. It stayed loud throughout the night. I noticed a couple of fist-fights during the evening, but they seemed pretty harmless, ultimately. Those that weren't taken outside were rapidly shut down by Trigger, Icepick, or friends of the combatants. I learned later that the Hope has a standing no-weapons-use policy for both blades and guns. You can bring them in, you can show them to your buddies, but waving them around or pointing them at someone in anger makes you an instant target for the security experts. Trigger, Icepick, the other security people, and the table servers are all authorized to use weapons to keep the peace in the bar, and they are all more than ready to do it.

Weekday evenings the Hope closes at two A.M., unless you're an employee or part of the Professor's little clique. These people usually hang around for an hour or two after closing time, swapping stories and getting loaded. On weekends the club tends to rock until daylight, or until people can't take it any more, whichever comes first. There are always a few die-hards who need to be prodded out or put upstairs to sleep it off. I stayed at the club until four A.M. that night, by which time I was finally too cross-eyed with J.D. to people-watch any more. Finally I took a cab back to my hotel to sleep off the booze so I'd be alert for my interviews the following evening.

Forlorn Hope NPC Stats

These are the stats and skills for the characters covered in this section, including our intrepid journalist. There are more NPCs in the next section.

C.J. O'Reilly, Media, Age 40

Stats: INT 9, REF 8, TECH 5, COOL 10, ATTR 7, LUCK 6, MA 8, BODY 7/9, EMP 8/6, SAVE 9, BTM -2.
Skills: Credibility 8, Awareness/Notice 5, Composition 5, Education and General Knowledge 4, Persuasion and Fast Talk 5, Streetwise 6, Photo and Film 6, Interview 7, Personal Grooming 3, Wardrobe and Style 4, Expert: Military Affairs 9, Expert: Journalist 8, Brawling 7, Handgun 5, Rifle 4, Melee 3, Driving 5.
Cyberware: Basic Processor, Smartgun Link, Data Term Link, Interface Plugs, Chipware Socket, Muscle and Bone Lace, Basic Cyberoptic, Targeting Scope, Times Square Marquee, Image Enhancement.
Gear: SP 18 armor jacket, Sternmeyer Type 33 smart-pistol.

The Professor (Dr. John Freeman), Fixer, Age 43

Stats: INT 10, REF 7/8, TECH 5, COOL 8, ATTR 8, LUCK 3, MA 6, BODY 8, EMP 9/7, SAVE 8, BTM -3.
Skills: Streetdeal 8, Awareness/Notice 7, Handgun 5, Judo 5, Melee 5, Intimidate 5, Leadership 6, Personal Grooming 4, Interrogation 4, Streetwise 6, Education and General Knowledge 7, Expert: Military History 8, Expert: Special Operations 5, Expert: Construction 3, Library Search 3, Wilderness Survival 5, Rifle 5, Driving 5, Weaponsmith 3, Heavy Weapons 2.
Cyberware: Basic Processor, Kerenzikov Booster Level 1, Smartgun Link, Interface Plugs, Chipware Socket, Basic Cyberoptic, Targeting Scope, Low-Lite™, Times Square Marquee, Basic Cyberaudio, Radio Link, Amplified Hearing, Level Damper.
Gear: Varies.

Marianne Russell Freeman, Techie/Bartender, Age 38

Stats: INT 7, REF 6, TECH 9, COOL 9, ATTR 6, LUCK 5, MA 5, BODY 7, EMP 8, SAVE 7, BTM -2.
Skills: Jury Rig 5, Awareness/Notice 6, Basic Tech 7, Cybertech 6, Education and General Knowledge 3, Electronics 4, Weaponsmith 5, Expert: Construction 6, Streetwise 5, Persuasion and Fast Talk 4, Expert: Mixology 6, Accounting 5, Management 7, Brawling 6, Melee 3, Handgun 4.
Cyberware: None
Gear: Varies.

Fred Seitz (Gunsights), Cop, Age 40

Stats: INT 7, REF 9, TECH 8, COOL 7, ATTR 6, LUCK 3, MA 7, BODY 9, EMP 6/4, SAVE 9, BTM -3.
Skills: Authority 7, Awareness/Notice 7, Handgun 6, Human Perception 3, Athletics 1, Education and General Knowledge 2, Karate 6, Melee 5, Interrogation 6, Streetwise 5, Weaponsmith 8, Rifle 9, Submachinegun 2, Stealth 2, Leadership 2, Shadow/Track 5, Driving 6, Expert: Law Enforcement: 6, Wilderness Survival 3.
Cyberware: Basic Processor, Chipware Socket, Smartgun Link, Interface Plugs, Basic Cyberoptic, Targeting Scope, Times Square Marquee, RealSkinn™Cyberarm (right) with Thickened Myomar and Microwave/EMP Shielding.
Gear: Usually smart-chipped Militech Avenger, SP 14 jacket and SP 10 T-shirt.

Hunter Murdoch, Media, Age 38

Stats: INT 10, REF 7, TECH 4, COOL 10, ATTR 8, LUCK 5, MA 8, BODY 8, EMP 10/7, SAVE 8, BTM -3.
Skills: Credibility 7, Awareness/Notice 5, Composition 5, Education and General Knowledge 6, Persuasion 6, Human Perception 7, Streetwise 4, Photo and Film 4, Interview 4, Interrogation 8, Expert: Psychological Warfare 7, Expert: Propaganda 6, Rifle 4, Submachinegun 5, Handgun 5, Melee 3, Karate 4, Stealth 3, Driving 5.
Cyberware: Biomonitor, Basic Processor, Interface Plugs, Smartgun Link, Data Term Link, Interface Plugs, Chipware Socket, Audio/Video Recorder, Basic Cyberoptic, Targeting Scope, Times Square Marquee, Low-Lite™, Video Camera (linked to recorder), Basic Cyberaudio, Micro-Recorder Link, Wide Band Scanner, Sound Editing, Radio Link.
Gear: Varies.

Max Johnson (Icepick), Solo, Age 34

Stats: INT 6, REF 10, TECH 6, COOL 8, ATTR 8, LUCK 3, MA 9, BODY 7, EMP 6/3, SAVE 7, BTM -2.

Skills: Combat Sense 6, Awareness/Notice 7, Handgun 7, Tae Kwon Do 5, Melee 5, Weaponsmith 5, Rifle 6, Athletics 4, Submachinegun 4, Stealth 5, Intimidate 6, Expert: Special Operations 5, Swimming 4, Heavy Weapons 6, Electronic Security 6, Demolitions 7, Wilderness Survival 5, Streetwise 3, Driving 3.

Cyberware: Basic Processor, Pain Editor, Smartgun Link, Interface Plugs, Chipware Socket, Adrenal Booster, Basic Cyberoptic, Targeting Scope, Times Square Marquee, Skin Weave.

Gear: SP 18 armor jacket, mono-knife, ArmaLite .44 heavy pistol, Arasaka WMA (Minami) smart-chipped submachinegun.

Johnnie Peterson (Ringo), Solo/Bartender, Age 35

Stats: INT 7, REF 10, TECH 8, COOL 7, ATTR 8, LUCK 6, MA 7, BODY 8, EMP 8/6, SAVE 8, BTM -3.

Skills: Combat Sense 5, Awareness/Notice 4, Handgun 10, Brawling 6, Melee 4, Weaponsmith 7, Rifle 7, Athletics 2, Heavy Weapons 5, Submachinegun 4, Stealth 5, Streetwise 4, Expert: Mixology 5, Seduction 4, Persuasion and Fast Talk 2, Wilderness Survival 5, Hide/Evade 3, Driving 4, Ambidextrous.

Cyberware: Basic Processor, Smartgun Link, Sandevistan Speedware, Interface Plugs, Chipware Socket, Basic Cyberoptic, Times Square Marquee, Targeting Scope, Low-Lite™.

Gear: SP 18 armor jacket, twin smart-chipped Colt Peacemakers in hip holsters, Bowie Knife.

Susan Dahner (Sundance), Medtech/Waitress/Musician, Age 32

Stats: INT 7, REF 8, TECH 10, COOL 10, ATTR 9, LUCK 2, MA 7, BODY 6, EMP 9/7, SAVE 6, BTM -2.

Skills: Medical Tech 7, Awareness/Notice 5, Basic Tech 5, Diagnose 4, Library Search 3, Education and General Knowledge 5, Pharmaceuticals 5, Cybertech 7, Wilderness Survival 3, Athletics 4, Aikido 4, Stealth 4, Hide/Evade 4, Handgun 5, Rifle 5, Submachinegun 3, Streetwise 2, Driving 2, Play Instrument: Bass 5, Perform 2, Singing 2.

Cyberware: Basic Processor, Smartgun Link, Chipware Socket, Interface Plugs, Basic Cyberoptic, Targeting Scope, Low-Lite™, Times Square Marquee.

Gear: Ruger Super Redhawk (.44 magnum) smart-chipped revolver.

William Dolarhyde (Dollar Bill), Fixer, Age 50

Stats: INT 10, REF 6, TECH 5, COOL 10, ATTR 9, LUCK 6, MA 7, BODY 7, EMP 6/5, SAVE 7, BTM -2.

Skills: Streetdeal 10, Awareness/Notice 5, Forgery 6, Handgun 4, Boxing 5, Melee 2, Pick-Lock 4, Intimidate 7, Persuasion and Fast Talk 8, Personal Grooming 4, Wardrobe and Style 6, Streetwise 6, Human Perception 5, Leadership 4, Social 4, Accounting 3, Education and General Knowledge 6, Driving 3, Pilot Vectored Thrust 4.

Cyberware: Basic Processor, Chipware Socket, Interface Plugs, Kiroshi Optishields (See *Chromebook*).

Gear: Varies. Very wealthy.

Annie Capolino (Trigger), Solo, Age 25

Stats: INT 8, REF 10, TECH 4, COOL 7, ATTR 10, LUCK 5, MA 10, BODY 7, EMP 8/4, SAVE 7, BTM -2.

Skills: Combat Sense 6, Awareness/Notice 6, Handgun 6, Tae Kwon Do 5, Melee 5, Weapons Tech 2, Rifle 6, Athletics 5, Submachinegun 5, Stealth 5, Streetwise 4, Seduction 3, Hide/Evade 4, Shadow/Track 2, Dance 3, Motorcycle 5, Driving 2, Weaponsmith 2, Electronic Security 5.

Cyberware: Basic Processor, Smartgun Link, Interface Plugs, Chipware Socket, Adrenal Booster, Basic Cyberoptic, Targeting Scope, Infrared, Anti-Dazzle, Two Realskinn™ Cyberlegs, Rippers.

Gear: Federated Arms X-9mm smart-chipped pistol, Sternmeyer Stakeout 10 (short), SP 18 armor jacket.

Melissa Wellingham (Godiva), Solo/Bartender, Age 33

Stats: INT 7, REF 9/10, TECH 7, COOL 9, ATTR 7, LUCK 6, MA 8, BODY 8, EMP 9/6, SAVE 8, BTM -3.

Skills: Combat Sense 4, Awareness/Notice 5, Handgun 5, Karate 5, Melee 5, Weaponsmith 3, Rifle 6, Athletics 4, Submachinegun 6, Stealth 6, Wardrobe and Style 4, Endurance 3, Streetwise 3, Persuasion and Fast Talk 6, Human Perception 3, Hide/Evade 5, Shadow/Track 4, Wilderness Survival 4, Driving 3, Fencing 4, Electronic Security 3, Expert: Mixology 4.

Cyberware: RealSkinn™ Cyberarm (left) with Hydraulic Rams and Wolverers, Adrenal Booster.

Gear: SP 14 armor jacket, SP 10 T-shirt, Arasaka WSA pistol (P O J C 2D6+3(10mm) 15 2 VR 50m, See Corpbook One), FN-RAL assault rifle.

Andy Chen (Needles) Ripperdoc/Medtech, Age 29

Stats: INT 10, REF 7, TECH 9, COOL 8, ATTR 9, LUCK 1, MA 7, BODY 6, EMP 7/4, SAVE 6, BTM -2.

Skills: Medical Tech 8, Awareness/Notice 3, Basic Tech 5, Cybertech 7, Diagnose 4, Education and General Knowledge 6, Cryotank Operation 5, Library Search 4, Biology 4, Pharmaceuticals 5, Expert: Surgery 6, Expert: Physiology 5, Electronics 2, Wardrobe and Style 3, Streetwise 4, Choi Li Fut 4, Handgun 4, Melee 1, Driving 3, Motorcycle 3.

Cyberware: Basic Processor, Tactile Boost, Machine/Tech Link, Data-Term Link, Interface Plugs, Chipware Socket, Basic Cyberoptic, Times Square Marquee, Micro-Optics, Low-Lite™, Superchrome® Cyberarm (right) with Toolhand.

Gear: Varies. Fully equipped clinic in Forlorn Hope.

Brenda Cannariato (Banger), Rockergirl/Waitress, Age 22

Stats: INT 6, REF 7, TECH 7, COOL 9, ATTR 9, LUCK 5, MA 8, BODY 5, EMP 10/9, SAVE 5, BTM -2.

Skills: Charismatic Leadership 3, Perform 7, Wardrobe and Style 5, Composition 3, Brawling 4, Play Instrument (Drums) 7, Streetwise 5, Seduction 4, Personal Grooming 2, Persuasion and Fast Talk 4, Human Perception 3, Melee 3, Handgun 4, Dance 3, Singing 2.

Cyberware: Basic Processor, Chipware Socket, Basic Cyberaudio, Enhanced Hearing Range, Level Damper, Wearman.

Gear: Varies.

Zeke Daniels (ZZ Destroyer), Rockerboy/Waiter, Age 24

Stats: INT 8, REF 8, TECH 5, COOL 9, ATTR 8, LUCK 9, MA 6, BODY 6, EMP 8/7, SAVE 6, BTM -2.

Skills: Charismatic Leadership 6, Awareness/Notice 2, Perform 7, Wardrobe and Style 4, Composition 6, Brawling 2, Play Instrument (Guitar) 7, Singing 5, Streetwise 4, Seduction 1, Dancing 5, Handgun 3, Motorcycle 5.

Cyberware: Basic Processor, Interface Plugs, Machine/Tech Link, Chipware Socket, Basic Cyberaudio, Wearman.

Gear: Varies.

Robelarde St. James (Ras Angabo), Netrunner, Age 27

Stats: INT 10, REF 10, TECH 5, COOL 10, ATTR 6, LUCK 1, MA 5, BODY 9, EMP 6, SAVE 9, BTM -3.

Skills: Interface 8, Awareness/Notice 5, Basic Tech 3, Education and General Knowledge 4, System Knowledge 4, Cybertech 2, Cyberdeck Design 5, Composition 6, Electronics 2, Programming 7, Play Instrument (Keyboards) 7, Singing 4, Expert: Jamaican History, Culture and Religion 6, Expert: Haitian Voodoo 3, Language (French) 9, Melee 4, Brawling 5, Handgun 1, Dodge and Escape 3.

Cyberware: Basic Processor, Sandevistan Speedware, Cybermodem Link, Interface Plugs, Chipware Socket, Basic Cyberoptic, Times Square Marquee.

Gear: Varies. Kirama LPD-12 Cyberdeck. Programs vary.

CONVERSATIONS AT THE FORLORN HOPE

Back Again

The following evening I was back at the Forlorn Hope. This time, I was pleased to notice that the reaction to my entrance was considerably more subdued. After visibly chatting with the Professor for some time, and spending the better part of the previous night at the bar, I guess people considered me pretty harmless. I expect I still wouldn't have been welcome at all the tables, but I didn't feel like such a pariah anymore. In fact, I hadn't been sitting for too long when a gang of people approached my booth. At first I thought they were going to give me a hard time, but it turned out that they were all people who knew who I was and wanted to hobnob. Several of them were among the people who had agreed to talk with me on tape. It made a nice break from the previous evening's isolation. We knocked a few back, and then I got down to business.



Kronos

Kronos has been a fixture at the Hope ever since it opened. He brokers jobs for other customers of the bar.

C.J.: I'm told that many of the customers here come to you when they're looking for jobs to run.

Kronos: That's right. I've been around for a long time, and I guess I'm tied into more sources than many of the younger Fixers.

How did you amass those sources?

I put in several years in that venerable organization, the CIA. While I was working for them I amassed contacts in several national intelligence agencies, including the KGB, British Secret Service, Mossad, and a few others. I also formed ties with the intelligence services for several major corporations, although most of those were initiated only after I stopped being regularly active in the Agency. You know how poorly corporate and national intelligence agencies get along.

I do. I've reported on the situation more than once. So you're still in touch with both your pre- and post-Agency sources?

Absolutely. I try to maintain contact with any group or individual that I think could either provide useful services, or employment for others.

So as a middleman, what's in it for you? Money?

Well, obviously, but I like to think that I have more of a personal stake in it than that. I spent much of my time doing [pauses]...sort of "morally questionable" things for the Agency. As I got older, and a little less ruthless, many of those past events came back to haunt me. I fancy myself a bit of a champion of the underdog. I try to arrange jobs that I think will ultimately be of benefit to someone somewhere. It's my way of easing my conscience. I arrange interventions and missions for private individuals and little people who are being threatened by corporations or governments.

Yet you said that you had ties to corporations.

Poor word choice. I should have said contacts. Ties sounds like it's official. I get inside information on the sly from personal associates, and use that to arrange jobs, frequently to the detriment of the corps.

Your contacts are in precarious positions.

They are. They run a big risk by dealing with me.

So why do they do it?

Same reason I do. Money and conscience. Also, some of them owe me.

You said before that you were no longer regularly active in the CIA. Does that mean you're occasionally active?

I'm afraid so. From time to time I'm still called in by them to assist in operations that are suited to my talents. I usually contract freelancers to run missions that the CIA wants no direct connection with.

Sounds like you don't really like it. Why do you do it?

It runs counter to what I'm trying to accomplish these days, but . . . [pauses] I guess you never really retire from the agency [shrugs].

Marlo

Marlo is among the few Forlorn Hope regulars who is consistently employed. She's a Militech street rep. She's also a veteran of LRT-601.

C.J.: Tell me a little about what you do.

Marlo: Militech is like other big corporations. They run many jobs that, for one reason or another, they don't want to use company personnel on. I'm a "street rep." When the company wants a freelance team, they brief me on the mission requirements and personnel cap, and authorize a certain amount of funds. I use my street contacts to contact a team, or assemble one that I think can do the mission.

Militech has one of the best black-ops departments in the world. Why on earth would they ever want to hire freelance help?

Oh there's lots of reasons. Militech runs against people with very sophisticated sources and information gathering networks, like Arasaka. Any company team, no matter how experienced, can ultimately be traced back to the parent corporation by someone with eyes and ears in the right places. Even if the team is totally unmarked and never talks, there's always *some* way of tracing it back. It





may be one chance in a thousand, but sometimes that's too much. A freelance team is almost untraceable, especially when they have no idea who they're working for.

So you don't tell your freelancers that they're really earning Militech dollars?

Most of the people in here [gestures to crowd] already know who I work for. But the wetnoses don't. I'm the person who breaks them in. After they've run a mission with me they're more liable to be welcome in the bar.

So why else would Militech use freelance help?

Freelancers are sometimes the best people for the job. No one knows the street better. Sometimes a job needs people who are tight with the street or have the right contacts. A black ops team can do all the research and prep it wants, but it still spends all its time on a corporate reservation, and it shows.

What about throwaways? You know, suicide missions?

[Bristles] I don't know about other street reps, but not through me, mister. We've got a code here. I do high risk, sure, but my teams are well compensated, and I never take them on any mission I don't think we have a reasonable shot of completing successfully.

So you accompany your teams?

Of course! I'm a Solo, not some damn desk jockey! I always accompany the team. That's one of the reasons I won't take suicide missions. Other street reps let teams go it alone. I don't believe in that. 'Course, some teams get uppity and don't want a company person along. That's tough. I got a personal stake in the outcome. I don't want a mission failure on my head.

What happens to you when the mission fails?

I dunno. Ain't happened yet. [Grins].



Wolf

Wolf came to Night City from Europe. His English is a little rough, and he didn't use a chip when we talked. I've cleaned up his English a bit, but some of his faulty syntax remains. He's got a heck of an accent.

C.J.: So, where are you from, Wolf?

Wolf: I'm from Germany . . . the North. But I used to work all over Europe, and even a little in North Africa.

What kind of stuff did you do?

I did all the usual freelance stuff: extractions, bodyguarding and so on. But I was really a specialist in recovering escaped criminals and other fugitives.

Like a bounty hunter?

Exactly! A bounty hunter. I am good at tracking people, both long term and short term. I was very good. I once brought a man back to Switzerland from Argentina, Buenos Aires.

Do you do the same kind of stuff here?

Sometimes. I enjoy it. But I do more work for the private citizens and small groups, less for the corporations and police. I like to track people. It's always like . . . a problem, like a puzzle. I also do other stuff. Whatever pays. Jobs are not as easy to find here. There are more Solos. Americans watch too many movies, everyone wants to be a Solo! In Europe there are less, so there is more demand.

Do you like it here? What I mean is, if work is easier to get there, why not go back?

I had some problems with a corporation. EBM, in my native country. I did a job for them, to recover alive a man who had been extracted by Orbital Air. I tracked him to Kenya. He was going into orbit. I had recovered him, and I was going to bring him back, but there was a policy shift at EBM and they decided that this man was expendable. They didn't want him to work for Orbital Air, but since they didn't want him back either, they didn't like to pay me for recovering him. You see, I was one of the best, and my price was very big. Since this man was in my custody I had fulfilled the first terms of the contract. As soon as I brought him back to Hamburg I would fulfill the whole thing, and EBM would owe me a million Euro.

I take it they solved their dilemma at your expense.

Yes. I turned the man over to EBM, and they killed him. They wanted to kill me too, but I escaped. So to cover up, they said that I had broken the contract and asked for more money. EBM told the news that, when they refused to give me more money, I killed



the man instead of turning him over. My reputation in Europe was ruined. No one would give me jobs, and my money was seized by EBM. So I came here. It is still hard to find work though. Some people over here believe EBM.

Are you trying to clear your name?

It is my biggest dream, but EBM is very . . . hard, very big. It is difficult to fight them. Maybe soon I will succeed.

Roxxi and Kissy

Roxxi and Kissy are two young women who work together as a team. They are nearly inseparable, spending all their time together, on the job and off.

C.J.: I'm told that the two of you are always together. How did this close relationship come about?

Roxxi: Well, we don't do *everything* together [giggles], just almost everything!

Kissy: Except for that once, when that guy from Cleveland . . . you remember, the cute one with the huge...

Roxxi: [elbowing Kissy] Shut up! Yes, we're great friends. We always do jobs together. I think our skills are complimentary. [Kissy giggles] Not like that!

Kissy: Besides, we have fun when we work together. Going solo is soooo boring! Oh, I agree.

Kissy: Silly!

Roxxi: But it's more than that. Kissy's pretty young, just eighteen. We've been working together for about two years. I'm showing her the ropes.

Kissy: [To Roxxi] Oh, miss *old* lady. Big twenty-three!

Roxxi: Older than you, Shorty!

[To Kissy] So, are you learning anything from your big sister here?

Kissy: Well, Roxxi thinks I'm too violent. She's trying to "mellow me out." But I don't like to fool around. I like to take, you know, the direct route.

Roxxi: Last time the direct route involved blowing up an entire office building!

Kissy: So? Some guys were shooting at us. There was no one else around.

Roxxi: Except me!

Kissy: Like you should care! I remember when you sunk an ocean liner!

Roxxi: That was different! It was out at sea. The fire didn't spread.

What kind of jobs do you girls like to do?

Roxxi: Oh, anything that looks like it'll be fun! We don't like jobs where we have to do lots of sitting around, waiting for things to happen.

Kissy: Yeah! We like the exciting stuff. Where we go right in and get to work. Also, we don't like jobs where people get real uptight and start telling us how to do things. [Makes stern face and talks in uptight-corp voice] "No this, no that, no the other thing. And stay quiet, and don't be violent, and don't scratch the paint work, and keep off the grass." Bleagh! If we're gonna do a job, we're gonna do it our way.

Roxxi: [Begins to sing] I did it my way . . . [Immediately silenced by a hail of balled-up, wet napkins and peanut shells.]

So tell me. You two are pretty unusual, considering the crowd in here. How come you hang out at the Forlorn Hope?

Together: Cute guys!

Kissy: Haven't seen any tonight, though. [More napkins and peanut shells.]

Zora

Zora is a native of the ex-Sov Bloc, and a former Russian Highrider. She's been freelancing in the U.S. for some years.

So, Zora, you're from the Soviet Union?

Zora: I guess so, in so far as it still exists. But I was born and raised in the Ukraine, and I think of myself as a Ukranian first and foremost.

That attitude is pretty typical of natives of the separatist republics. Did you ever participate in separatist incidents?

You mean was I Ukrainian terrorist? Well, I suppose so. I was discharged from the VVKV after the Orbital War. I spent about two years blowing up Soviet military posts and army equipment in the Ukraine. Things eventually got too hot there. That's among the reasons why I left to come to America. Also, I think I outgrew my wild stage. The only thing we ever accomplished with our acts was self-gratification.





It's quite a switch, from National Air Force ace to separatist terrorist.

It didn't happen all at once. My rebellious feelings took a year to come to full bloom. So I guess it's fair to say I was only blowing things up for a year. I spent the first year slowly coming to the realization that I wanted to blow things up [laughs]. You see, I left the Ukraine when I was fifteen, and I didn't come back until I was twenty-five. A lot can change in ten years. I had been to college and been six years in the VVKV, being pounded by nationalist propaganda all the while. But things had been getting worse at home, and I was shocked when I finally came back. Seeing your family starving after you've been living well for a decade can break through all the happy propaganda.

I guess so. Tell me a little about your highriding days.

I spent six years as an officer in the VVKV. I was tapped right out of university. I flew orbital assault deltas. You know, combat shuttles. During the war I ran anti-sattelite missions, anti-station missions, and interdictions and interceptions.

That's pretty freaky stuff.

Yes, but I was good at it. I have four confirmed satellite kills, two stations and six American delta, shuttle or LOF [Low Orbit Fighter] kills. And I enjoyed both flying and being in space. Orbital runs are the only thing I really miss about the VVKV.

Does it bother the local crowd that you were on the other side?

It doesn't seem to. I hang out a lot with Ace and Rusty, and we probably fought each other. [Ace and Rusty are other regulars, and former U.S. highriders.]

So what do you do these days?

Freelancing. Any flying work I can get. I'm good in fixed-wing jets and props, rotor wings, and I can make an AV sit up and beg. It's not too difficult to find regular work. I often do the insertion piloting for Dollar Bill's mercenary teams, or for groups hired out of the bar. People like a pilot they know and trust. And it's good for free drinks.

Axeman

Axeman is an interesting character: a real, old fashioned private eye. The dress is different, but the work is the same as it ever was.

C.J.: Your work sets you apart from the other people in the club. Most of them are combat types of one sort or another. True Solos. But you're a detective. Tell me about it.

Axeman: I come from the streets, so it's probably oversimplifying things a little to say

I'm not a combat person.

Granted. But it's not the emphasis of your job.

That's certainly true. But I think it comes from my background. I was born and raised on the streets. I schooled myself while living out of cardboard boxes and cheap airport coffins. In that environment, combat is a day to day reality. You see, most of the people in here are ex-soldiers. They stayed Solos because they're adrenaline junkies. They're addicted to the rush that they get everytime they leaped into a hot LZ, and they all get that rush in any combat situation, even a fistfight. Don't let them tell you different. But I've been in street violence since day one, and I've never felt that kind of thrill. Of course, street violence is a little different from warfare, but it breeds the same results.

So where do you get your thrills?

Puzzles. I do private eye work, investigations, shadowings, things like that. I enjoy the thrill of putting the pieces together, of uncovering something that has been lost or hidden. I think I've also got a bit of a voyeuristic streak in me, because I like trailing people, peeking through windows, taking funny photos.

Real Raymond Chandler stuff, eh?

Hey, you got it. Call me a romantic.

So, you must encounter violence in your job.

Of course, but it's not the object of the job. In fact, if a case goes well I should never have to draw a weapon or get in a fistfight. When a case goes that smoothly, I congratulate myself. It's hard to live up to the plug "Confidential Investigations" if you leave a trail of dead bodies and broken noses behind you.

So, what kind of cases do you get?

I have to admit, most of them are pretty boring. I take everyman cases, you know. I'm not a smooth corporate center investigator. I'm a street private eye. I get a lot of



"My husband is cheating on me" or "I think I've been swindled," and stuff like that. I do get some interesting cases, though.

What kind of cases?

I do lots of south-of-the-freeway work, so people call me to solve cases that the police have no interest in. They don't consider it worth their time to solve another combat-zone murder. When the police won't help out, people come to me. For a lot of folks on the street, I'm the only shot at justice they have.

Can combat zone people afford your rates?

My man, *anyone* can afford my rates!

Nails

Nails is a Federal Marshal, like Gunsights. In fact, she is Gunsights' new partner. I understand that their relationship is still a little rocky.

C.J.: So you're a marshal, huh? Don't take this the wrong way, but you look a little young.

Nails: [Laughing] Don't worry, I'm not going to get insulted. I'm actually twenty-four, but I only just went through the academy. I've had my badge for about...five months.

Just starting out, eh? What's it like?

It's a lot more work than I thought it would be. I mean like paperwork and desk work, but it can be pretty exciting too! I think we have more fun than the regular city cops.

Oh, I can almost guarantee that. So you're glad you decided to do this?

So far. Mr. Seitz [Gunsights] is a really great partner. He's been doing this a long time, and he really knows his stuff. I'm learning so much from him that I can barely remember it all.

What kind of stuff are you learning from Gunsights?

I'm so new at this job, you know, I still try to do everything by the book. I have all the lessons from the academy floating around in my head, and I'm always following The Rules, whether I try to or not. Mr. Seitz said the first thing he was going to do was purge my head of all that "academy garbage" so I could start developing my own style and instincts.

Is it working?

It seems to be. I'm not as stiff as I was a couple of months ago. Of course, the instructors probably would think that Mr. Seitz is ruining all their hard work. But I think I'm becoming a better agent because of his advice.

What led you to want to be a Marshal?

I liked the idea of having some security. It seems so risky to go Solo and be a freelance. You have no organization, no resources to fall back upon. I like knowing that I can draw on those things if I need to.

Some people consider the freedom worth the trade-off.

I suppose so, but we all have to work in the environment that is most comfortable. Also, I put in my time as a soldier. I was two years in the Militech mercenary forces. I wanted a change, a job that wasn't so combat-oriented. Being a Marshal, I get enough excitement to make the job interesting, but I'm not always worried about getting killed.

So what kind of stuff do you and Gunsights do?

Oh, all sorts of things. We do fugitive tracking work. We escort prisoners across the country. We do international extradition missions. Those are really exciting. We also work with the CIA's domestic LawDiv on some missions, like drug stings and crime organizations.

Do you get along with the crowd in here?

Yeah, pretty well. Since I'm not a freelance, I feel a little different sometimes. But Gunsights fought in the war with the Professor, and I think people figure that, if he tolerates me, I must be OK.

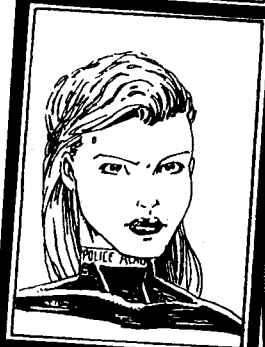

Nails 557-1331
Sat. nite. Alright!

Interview NPCs

These are the stats and skills for the NPCs interviewed by C.J. O'Reilly. Each of these characters is also central to an adventure, so refer to this section when running.

Robert Cronenberg (Kronos), Solo, Age 51

Stats: INT 10, REF 8, TECH 9, COOL 10, ATTR 5, LUCK 3, MA 6, BODY 7, EMP 10/8, SAVE 7, BTM -2.
Skills: Combat Sense: 5, Awareness/Notice 7, Handgun 5, Judo 5, Melee 3, Weaponsmith 5, Rifle 7, Athletics 1, Submachinegun 2, Stealth 2, Personal Grooming 4, Wardrobe and Style 5, Interrogation 5, Streetwise 6, Social 6, Education and General Knowledge 8, Shadow/Track 5, Driving 3, Electronic Security 5, Demolitions 2, Chemistry 2, Expert: Intelligence Agencies 6.
Cyberware: Basic Processor, Smartgun Link, Interface Plugs, Chipware Socket, Basic Cyberoptic, Times Square Marquee, Low Lite™, Targeting Scope, Image Enhancement.
Gear: Varies.

Traci Jo Marlowe (Marlo), Solo, Age 33

Stats: INT 8, REF 10, TECH 3, COOL 10, ATTR 8, LUCK 5, MA 10, BODY 7, EMP 8/4, SAVE 7, BTM -2.
Skills: Combat Sense 6, Awareness/Notice 5, Handgun 6, Karate 3, Dodge and Escape 3, Melee 7, Weaponsmith 3, Rifle 4, Athletics 5, Submachinegun 4, Stealth 4, Streetwise 4, Leadership 4, Hide/Evade 3, Wilderness Survival 3, Driving 5, Militech Rep 3 (acts as Resources 3), Electronics 5, Expert: Communications 6.
Cyberware: Basic Processor, Smartgun Link, Data Term Link, Chipware Socket, Kerenzikov Boosterware Level 2, Basic Cyberoptic, Times Square Marquee, Targeting Scope, Rippers, Basic Cyberaudio, Radio Link, Phone Splice.
Gear: Varies.

Wolfgang Reimann (Wolf), Solo, Age 30

Stats: INT 7, REF 10, TECH 4, COOL 8, ATTR 10, LUCK 1, MA 9, BODY 9, EMP 9/7, SAVE 9, BTM -3.
Skills: Combat Sense 5, Awareness/Notice 5, Handgun 6, Boxing 6, Melee 6, Weaponsmith 4, Rifle 6, Athletics 5, Submachinegun 4, Stealth 5, Personal Grooming 3, Wardrobe and Style 4, Streetwise 1, Interrogation 4, Social 3, Hide/Evade 6, German (Native), English 3, Shadow/Track 7, Driving 3, Fencing 3, Electronic Security 5.
Cyberware: Skinwatch, Shift-tacts, Tech-hair, Basic Processor, Smartgun Link, Chipware Socket, Contraceptive Implant, Muscle and Bone Lace, Enhanced Antibodies, Skin Weave.
Gear: Varies.

Roxanne Colton (Roxxi), Solo, Age 23

Stats: INT 9, REF 10, TECH 4, COOL 8, ATTR 10, LUCK 5, MA 7, BODY 7, EMP 10/7, SAVE 7, BTM -2.
Skills: Combat Sense 6, Awareness/Notice 5, Handgun 7, Karate 6, Melee 5, Weaponsmith 1, Rifle 4, Athletics 5, Submachinegun 6, Stealth 4, Wardrobe and Style 3, Streetwise 2, Seduction 3, Hide/Evade 4, Demolitions 5, Heavy Weapons 6, Driving 5, Motorcycle 4, Electronic Security 4, Pick Lock 2.
Cyberware: Basic Processor, Sandevistan Speedware, Smartgun Link, Interface Plugs, Chipware Socket, Contraceptive Implant, Rippers, Smartgoggles w/ options (Targeting Scope, Times Square Marquee, Image Enhancement, Infrared), Basic Cyberaudio, Wearman, Amplified Hearing, Level Dampers.
Gear: SP 18 armor jacket, a variety of weapons.

Kimiko Sanchez (Kissy), Solo, Age 18

Stats: INT 6, REF 10, TECH 4, COOL 10, ATTR 9, LUCK 5, MA 7, BODY 8, EMP 7/3, SAVE 8, BTM -3.
Skills: Combat Sense 4, Awareness/Notice 6, Handgun 5, Capoeira 4, Melee 7, Rifle 5, Athletics 4, Submachinegun 4, Stealth 4, Personal grooming 3, Wardrobe and Style 3, Intimidate 1, Streetwise 5, Seduction 2, Gamble 1, Hide/Evade 1, Shadow/Track 1, Dance 4, Fencing 2, Demolitions 3, Heavy Weapons 2.
Cyberware: Biomonitor, Skinwatch, Basic Processor, Sandevistan Speedware, Interface Plugs, Smartgun Link, Basic Cyberoptic, Targeting Scope.
Gear: SP 20 armor jacket, Kendaichi mono-katana.

Zora Pleshakova (Zora), Solo, Age 37

Stats: INT 10, REF 10, TECH 7, COOL 9, ATTR 5, LUCK 3, MA 6, BODY 6, EMP 8, SAVE 6, BTM -2.

Skills: Combat Sense 6, Awareness/Notice 6, Handgun 2, Brawling 3, Melee 2, Rifle 2, Athletics 4, Streetwise 2, Education and General Knowledge 5, Russian (Native), English 6, Wilderness Survival 3, Heavy Weapons 2, Driving 1, Pilot (Vectored Thrust) 7, Pilot (Fixed Wing) 6, Pilot (Gyro) 2, Pilot (Delta/Shuttle) 8, Aero Tech 2.

Cyberware: Basic Processor, Sandevistan Speedware, Interface Plugs, Chipware Socket, Contraceptive Implant, Basic Cyberoptic, Image Enhancement, Teleoptics, Infrared.

Gear: Varies.

Axel Mankievicz (Axeman), Solo, Age 40

Stats: INT 10, REF 8, TECH 3, COOL 10, ATTR 6, LUCK 4, MA 8, BODY 9, EMP 8/6, SAVE 9, BTM -3.

Skills: Combat Sense 6, Awareness/Notice 8, Handgun 5, Boxing 5, Melee 6, Rifle 1, Submachinegun 4, Stealth 6, Interrogation 5, Intimidation 4, Human Perception 4, Seduction 3, Persuasion and Fast Talk 5, Streetwise 9, Hide/Evade 3, Shadow/Track 6, Electronic Security 4, Driving 3, Pick Lock 5.

Cyberware: Basic Processor, Chipware Socket, Smartgun Link, Interface Plugs, Basic Cyberoptic, Image Enhancement, Targeting Scope, Digital Camera, Basic Cyberaudio, Sound Editing, Amplified Hearing, Level Dampers, Digital Recording Link.

Gear: SP 10 armor T-shirt, SP 14 Armored trench-coat, Smart-chipped Colt AMT model 2000 in shoulder holster, sap.

Gayle Sigmund (Nails), Cop, Age 24

Stats: INT 8, REF 9, TECH 6, COOL 7, ATTR 9, LUCK 9, MA 10, BODY 7, EMP 10, SAVE 7, BTM -2.

Skills: Authority 3, Awareness/Notice 5, Handgun 5, Athletics 5, Education and General Knowledge 4, Karate 4, Dodge and Escape 3, Melee 5, Interrogation 2, Streetwise 4, Library Search 2, Shadow/Track 2, Driving 4, Rifle 5, Submachinegun 3, Expert: Law Enforcement 5.

Cyberware: Basic Processor, Smartgun Link, Interface Plugs, Chipware Socket, Basic Cyberoptic, Times Square Marquee, Targeting Scope.

Gear: Varies.

LRT-601 IN THE CENTRAL AMERICAN WAR

After the interviews, I was beginning to feel much more comfortable in the Forlorn Hope. Many of the regulars had opened up to me, and spoken candidly of their histories and occupations. I was even beginning to form rudimentary friendships with a couple of people. Unfortunately, I was to be in Night City for only four days, and that meant only one more night at the Forlorn Hope. I asked the Professor if he would devote part of the evening to telling me about LRT-601.

I had already spoken briefly with the Professor about his days in the war, and he had told me a little about his unit and the missions that they had undertaken. I was fascinated by the close attachment that the former members of LRT-601 felt for each other, an attachment that was strong enough to keep several members of the unit together long after the war was over. The crucible of war forms strange and lasting relationships, but it's naïve to think that the continued association of these old soldiers is borne solely of their deep love for one another. That's part of it, to be sure, but at the core of their friendship, there runs something a little darker.

My three days at the Forlorn Hope had given me a chance to better understand the psychology of the veterans of LRT-601, and it became possible to see beyond the surface level of the camaraderie that they are so proud of. The truth is complex. The members of the unit genuinely love one another. They are closer to each other than they are to any of their respective family members. Friendships with non-unit members are shadows of the relationships they have with their wartime associates. Their mutual trust, respect and support transcends almost all

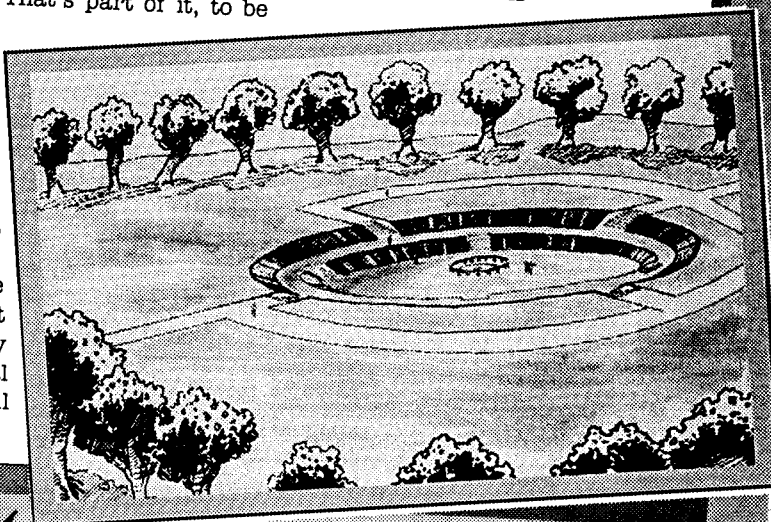

*South Am Vets Mem.
Wash DC. check file photo*

LRT-601
on leave, 2004



other feelings. The dark side is, this results in the exclusion of most other people. The soldiers of LRT-601 were in combat for so long, and in such horrifying and isolating conditions, that they were forced to rely only on one another. Cut off from other American troops for weeks at a time, they were immersed in conditions where anyone who was not part of the unit was an enemy. The war in Central America was not a war of liberation or a war of salvation, it was a war of annihilation. It was total cyberwar. Civilians were an incidental cost: a hindrance at best, bitter enemies at worst. Anyone not wearing your flag was someone to avoid or eliminate.

Under conditions such as these it was only natural for the cyber-commandos to draw exclusively upon each other. The more time the unit spent together, the firmer their attachment to each other. Even when on leave in Mexico, Nicaragua or Florida the group would stick together. The conditioning against reliance, trust or confidence in anyone outside the unit began to apply to everyone, not just the enemy. When combined with the fierce pride and sense of unity the strike teams felt, the result was dramatic. Eventually, there was your unit, and there was everyone else.

For many veterans, these close attachments dissolved once they returned to the States. But for those who had spent longer than a year or two in the jungles, it was not so easy. Many never overcame their distrust of those outside the cadre. They had been so conditioned to relate solely with members of their units that they could never be completely at ease with anyone else. After the war, they found themselves gathering together again, desperate to be with those whom they trusted, whom they understood. LRT-601 was active for four years. It was no wonder that they became victims of this syndrome. Now, ten years later, they are still comfortable only around those who have had similar experiences, and their deepest loyalties are still reserved for each other.

John Freeman Reminisces

The Professor was kind enough to give me some of his time, and we agreed to meet at the Forlorn Hope on my final evening in the city. I was pleased to notice that there was no disruption in the activity in the club when I walked in that evening. A couple of people even gave me friendly waves. I made the rounds of a couple tables, exchanging pleasantries with a few of the freelancers I'd interviewed the previous evening. The Professor joined me presently, and we retired to the booth we'd sat in forty-eight hours previously, on my first uncomfortable evening in the club. The Prof and I talked for over three hours. The following are excerpts from that discussion

C.J.: So tell a little bit about the history of the unit, and how you got started.

Freeman: I was commissioned in the Rangers in 2001, at age twenty-four. I was pursuing a graduate degree in Military History, but I got a little burned out and bored, and decided to try it out first-hand. There was no war on when I joined, and no one seriously believed the rhetoric about using massive military force to intervene in the drug trade. Well, that was a major miscalculation. Two years later, things were in full swing.

But you didn't see combat service until 2005, halfway through the war.

That's right. I was attached to a special, experimental group. We were testing the military applications of cybernetics, which were a brand-new technology at that point. Research continued until they had several functional units incorporating enhanced soldiers. Mine was one of those units. We were dispatched to the combat zone from Fort Bragg. I was a captain by then.

Tell me a little bit about the early days of the unit.

We were very cavalier about the whole thing, full of the romance of war. We were trained in deep, covert strike and reconnaissance, but we didn't receive our official designation of LRT-601 until we were in-country. The day we went active we came up with a nickname for ourselves, "The Long Riders."

That was you guys, huh? When I was a correspondent in Managua, people used to talk about hot units in the bars. I definitely remember hearing the Long Riders mentioned.

Oh yeah? You shouldn't have heard about us. We were supposed to be low profile. But that's the way it works with drunk soldiers, I guess. I can tell you this, there were no leaks out of the unit itself. All the scuttlebutt must have originated out of Company Command. Anyway, we were the Long Riders, and we could go anywhere and do anything, and we prided ourselves on doing it with a minimum of cyberware.

But didn't everybody in the unit have cybernetics?

Yup. But we had lots of low-key stuff, like chipping, smartweapons, optics, communications, and so on. Not many limbs, weapons, and heavy duty stuff like that. We thought we were above it. That was pretty arrogant, but American arrogance was the name of the game in Managua, 2005. The war wasn't a deathtrap quite yet, and many of the cyber-teams had good morale and high hopes. We figured that the cyber-soldiers would tip the balance of the whole thing.

Of course, it didn't work out that way.

No. Hindsight shows that. The cyber-teams were an advantage, but they didn't win us the war.

So who was in LRT-601 at the outset?

Oh, most of the same people who were in it at the end. That's one of the things that made our team unique. No, two of the things. One, we were astoundingly lucky as far as casualties were concerned. We only lost six people in four years. Two, those of us who came in at the beginning and survived the whole thing were down there in combat for four years.

Yet the standard tour was only eighteen months.

That's right, but that was the price of free cybernetics. You stayed down there as long as Uncle Sam wanted you there. You see, in those days, even the most basic modifications were worth tens of thousands, or even hundreds of thousands of eurobucks. The Army couldn't afford to wire us up and then use us for only a year. They were only budgeted for so many cybertroops.

So who made it through all four years of LRT-601?

Myself, the six other LRT vets you've met, and a couple of guys who don't hang around here.

Tell me a little about what each person did.

Well, I was team commander, of course. Hunter Murdoch was my lieutenant. He was also our psychological warfare, interrogation and propaganda man. That was a thankless job. Propaganda never did much good down there. The psy-ops were a different matter though. At least in the early stages of our career, the South Ams were terrified of cybernetics. Murdoch exploited that very nicely. Gunsights was a staff sergeant, and a sniper and weapons tech. Ringo was a private, and hell on wheels with a squad automatic. Sundance was our medic and cyber-tech. Marlo was a communications specialist. And, of course there was Icepick, who was on loan to us from the Navy SEALs. He was among the first Naval officers to be fitted with cybernetics. He was a lieutenant, and had been a team commander, but he was answerable to me, Murdoch and Gunsights when he was attached to our unit. That really gave him no end of frustration. Anyway, he was an advisor on some special ops and an outstanding demolitions and heavy weapons man.

You said you had two members who survived all four years, but don't hang out here.

Yup. One was Thomas "Tango" Thompson, the best vehicle tech, driver and pilot a team could ask for. He extracted us from hairy situations more than once, and he could make a deuce-and-a-half do stuff that would amaze most XC-class road racers. We used to do both HALO parachute and low-altitude AV insertions, and we could always count on Tango to get us to the right place at the right time. I guess he was the only one of us who could get a good job on the outside. He's a consultant for some vehicle-electronics firm in Texas.

Are the other team members resentful of his re-adjustment to nine-to-five living?

Naw. They're just amazed that he can tolerate it. He'll always have a place here if he wants it.

Who was the other one?

The other guy was Rico Estevez. He was a specialist in hand-to-hand combat, knife work, and alternative weapons, like bows. He was a great guy, the team comedian. He disappeared after the team was deactivated. I don't think anyone here has heard from him since then.

So, whom did you lose over the course of four years?

Let's see. We lost a CIA liason who was with us on an intelligence gathering mission. We lost a couple of special weapons people. We lost three security experts. We went through security-breach types like they came by the dozen. You know why? Those guys had the biggest attitudes. They all thought they could get into anything. I saw two of them get killed by booby traps, and one got shot by some peasant guard after spending three hours silently breaching a perimeter security system at this one plantation. I'd've laughed if it hadn't nearly blown the mission.

What kind of missions did you specialize in?

We were a long range reconnaissance and strike team. We would be secretly inserted deep in plantation territory, usually with one of two missions. The first was to investigate the strength of a given plantation or stronghold, in preparation for a larger assault.

Couldn't satellites accomplish that?

In part, but the Keyholes and Snoops had a lot of trouble penetrating jungle cover, even with infrared and other bizarre wavelengths. And some things you just get a better idea of up-close. We could snuggle right up to a plantation or factory and watch who came and who went, twenty-four hours a day, for two or three weeks. Try doing that with a satellite that



makes one pass every hour and a quarter.

So, what was the second type of mission?

Simple surgical strikes. We would go in, penetrate a plantation, or other installation, and either terminate selected personnel, or plant explosives and bring the whole thing down. Occasionally we also would have to recover certain information from plantation files, computers or personnel, for the use of Army Intelligence.

And these missions also required you to spend large amounts of time in enemy territory?

All the time. Usually we would have to insert some distance from our target to avoid detection. Then we would have to stick around long enough to make sure the job got done, and then we would have to hike out to a safe extraction point. That often meant marching deep into the forests or hills while avoiding local civilians, national army troops and plantation enforcers. Sometimes we had to spend two or three weeks at a time in unfriendly territory. Let me tell you, you learn how to live off the land. And then, once we made it back, we might get three or four days liberty and then it was right back in again. That was it, week in and week out, for four years. I don't know how we pulled it off. A lot of other cyber-LRTs got wiped out of existence. A lot of our friends.

The plantation lords weren't exactly famous for their humanity, were they?

Any member of our team would have cheerfully killed themselves rather than be taken alive by the plantation lords. We heard plenty of stories about what went on in the basements of those plantation houses and warehouses. And I've seen the evidence to prove it.

What kind of evidence?

[Pauses] I....we....found plantation torture victims more than once while on raids.

Did you bring them back?

No. There was never...[pauses]...it wouldn't have been possible. Not in their condition. These people had limbs amputated, had been injected with torture drugs, or experimental drugs; many had been blinded and were infected. We killed them to put them out of their misery. It was the hardest thing I ever had to do. I still dream about it—and get the shakes sometimes.

What about the credo? That you never abandon a man?

[Angrily] Reality intrudes on romance occasionally. When your options include moving a soldier and killing them painfully, leaving them there for continued abuse, or ending their torture quickly and humanely, what option do you pick? Leaving them alive would have been abandoning them. Ending it immediately was the hardest and best thing we could do. I believe in my heart that not one of those kids blames me.

And you and the other members of LRT-601 did this kind of stuff for four years?

That's right. We got liberty between missions, and two weeks off each year for personal reasons. The rest of the time was non-stop work. You can see why we formed the bonds we did. When you go through that with a person, when you count on another person's skill and judgement to save your life daily, how can you help it?

You didn't make it through the end of the war, did you?

No, I didn't. In 2009, six months before the U.S. pulled out, I caught a chest full of shrapnel from a Colombian National Army artillery shell. They had to ship me back to the States. I was lucky to make it through alive. At any rate, it ended my military career. The Army tried to keep the team going with several commanders, but none of them could control the group. It wasn't that I had any special talent, it's just that I had been with them for four years. No one else knew how to handle them. It didn't make much difference in the end. Six months later the war was over, and many of the original cyber-troops got their walking papers to make way for newer, younger soldiers.

It didn't take long for the remnants of LRT-601 to coalesce again, did it?

Nope. About three or four years. I got in touch with Bill Dolarhyde, who had been our controller, and was doing well as a civilian. Together we built the Hope. It seemed kind of natural that all our old associates would reappear. I wouldn't have it any other way.

Leaving the Forlorn Hope

Eventually, the Prof and I wrapped up our evening. I lingered briefly in the Hope, enjoying the atmosphere and the band, and then I called it a night. I was sorry to leave the club, I can honestly say that I've never been in a place quite like it. But I think I can see myself passing by this way again down the line. Perhaps I'll see you there.

Until next time. C.J.

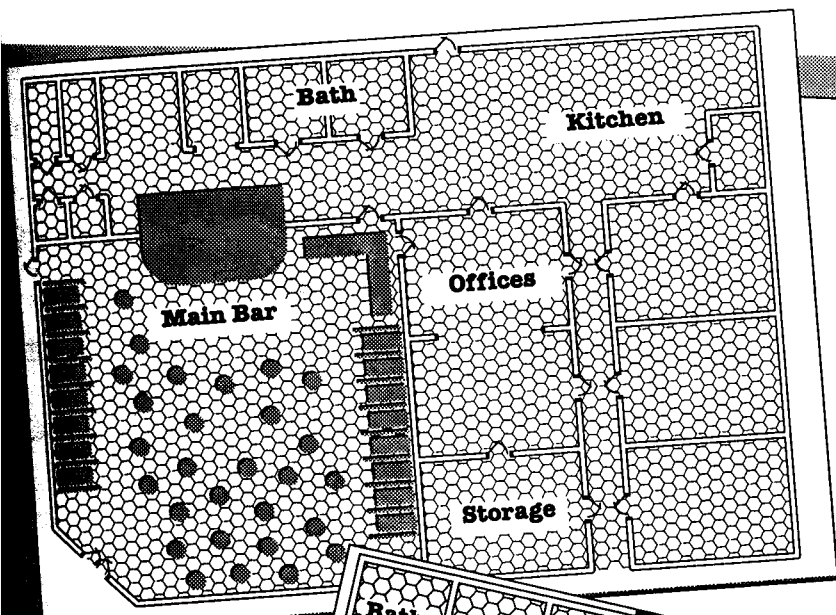

Ground Floor

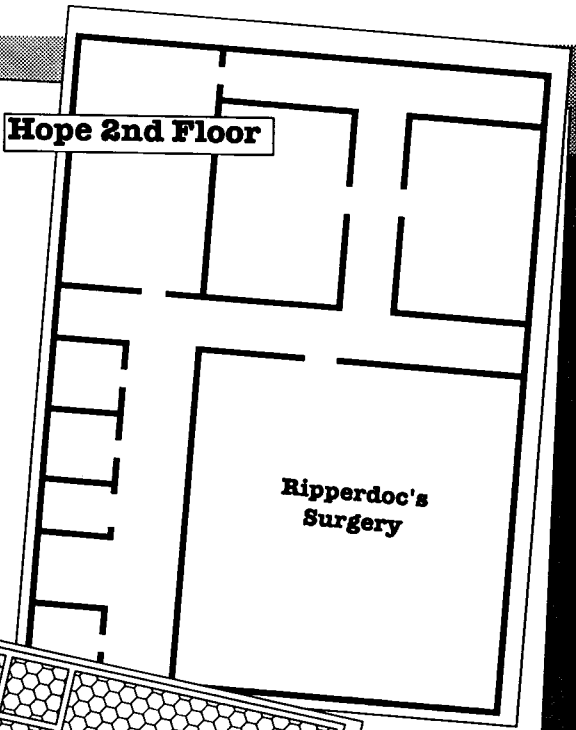

Hope 2nd Floor

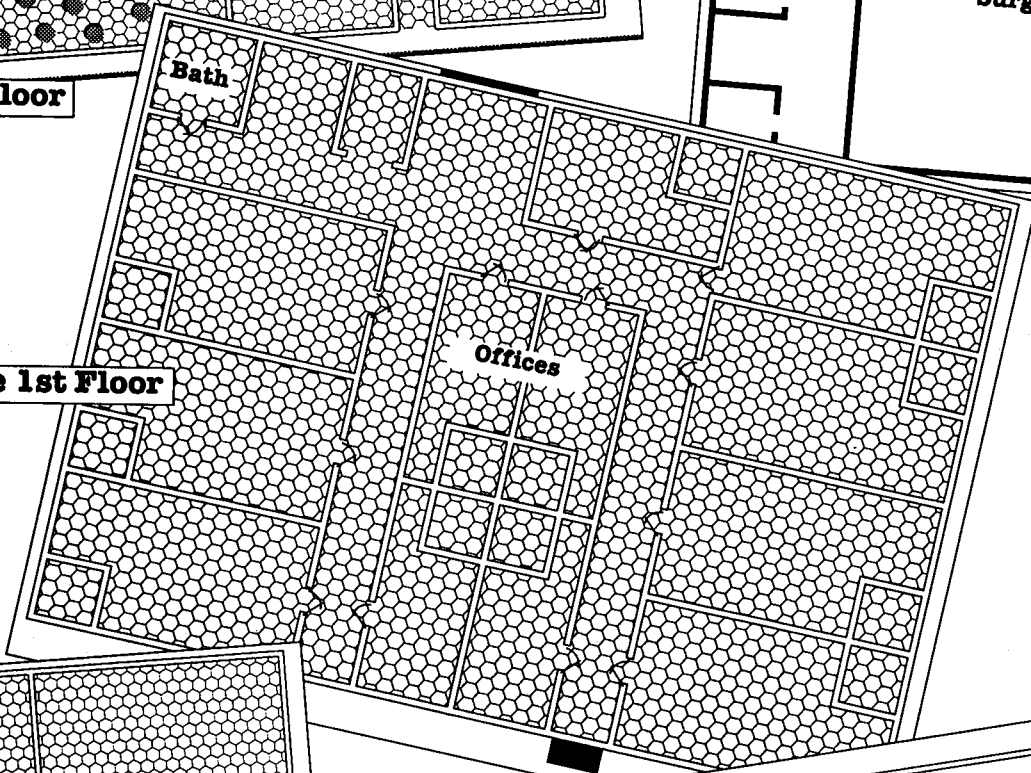

Hope 1st Floor

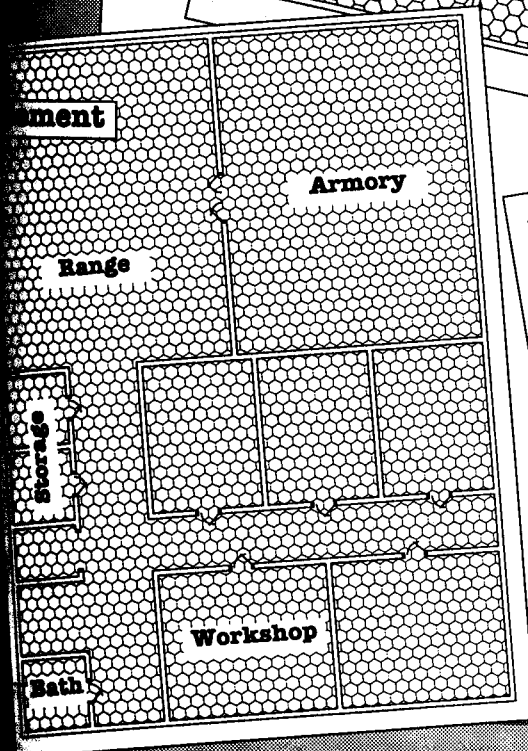

Basement

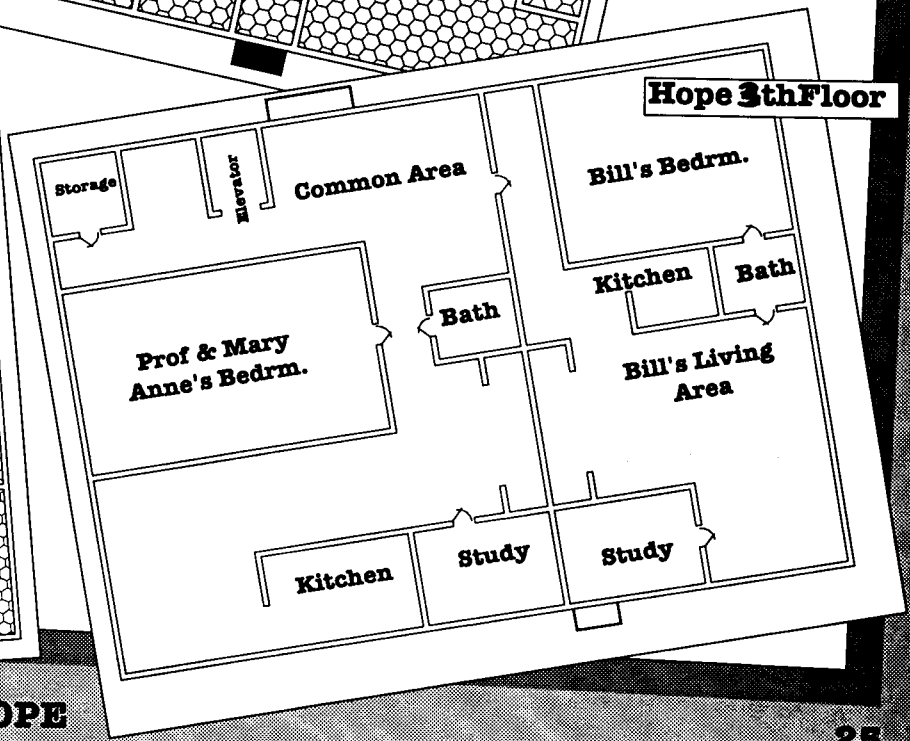

Hope 3rd Floor

WHEN THE GOING GETS TOO TOUGH—

The *Forlorn Hope* is designed for beginning characters; to weld a new *Cyberpunk* team together with some medium-weight action. But, you may like the adventure settings and want to take an already well-developed group through them. Now, we all know that *Cyberpunk* players are some of the most savage PCs ever, and you might be moaning, "They'll rip through these people like a chainsaw through a chicken!" Here's how we fix that:

Honoring the Threat— Your NPCs must match, if not exceed, the players in ability. First, we check **Special Abilities**: the *Forlorn Hope* NPCs must have abilities \geq the PC's **S.A.s**, usually by +1, or +2 at the most. They can't be much help if they're not just as good, can they? The chief villain(s) of each adventure must also have S.A.s = to the players. It's a balance between an easy ride, and Darth Vader every week.

You may be good, but you ain't the Best— Identify the two primary (most often used) skills in both the Hope NPCs, and any bad guys the party might meet. The best way to do this is to look at the Character Skill Packages in CP2020 and decide which skills get constant use (this is really dependant on campaign style). Example: for a Solo—any *Weapon* skill and *Awareness* ; for a Nomad—*Drive* skill and *Brawling*; for a Techie—*Basic Tech* and any one other *tech*, for a Netrunner—*System Knowledge* and *Programming*, and so on. These skills should be equal to the PCs in the case of secondary NPCs, and +2 or higher for the chief villain(s) and NPCs (No pain, no gain!).

One way to do this is to scale the campaign by how tough you (the Ref) want to make it. Using the table below, add this value to the primary skills of the NPC's as described above. The table also has a few suggestions for arming and armoring your NPCs against the typical *Cyberpunk* "power gamer" who is armed to the teeth.

Game Level	Main NPC	Secondary NPC	Weapons/Armor
Tough	+2	+0	Hvy Armor, weapons
Really Tough	+3	+1	Metalgear, Full Auto Weapons
Campaign in Hell	+4	+2	Anything they want

With this sort of tailored response, you avoid "milk runs"; the bane of any *Cyberpunk* ref. The bottom line is: know your player characters, and what's on their character sheets! Ugly surprises are no fun for anyone.

Have Fun!
The RTG Crew

TALES FROM THE FORLORN HOPE #1



In this adventure, Kronos' past comes back to haunt him, as he is contacted by his old organization to run a mission. The mission is to be executed by non-company personnel, and Kronos hires the player characters as a freelance team.

The mission involves the covert penetration of a local consulate and the extraction of sensitive information. The objective is to discover the name of a boat which the CIA suspects is being used to insert foreign black ops teams into the U.S. The boat is believed to be in Night City, and once revealed, it is to be sunk.

The adventure will require three to six Solos with skills in covert penetration, security systems, interrogation and demolitions. A Netrunner, and someone with skills in maritime operations (scuba, marine demolitions, etc.) will be helpful. If necessary, use Ras Angbo and Icepick to round out the team in those areas.

PART ONE: MAKING A SALE

When this adventure begins, the player characters should be new at the Forlorn Hope. They have yet to prove themselves to the regulars. This mission will give them a chance to do that. At the outset, do your best to make the players feel a little uncomfortable. No one is speaking to them; conversation dwindles a little when they walk by tables. They should feel a little relieved when someone finally talks to them. That someone will be Kronos.

Kronos will approach the characters' table and ask if he might be allowed to join them for a few minutes. It's up to the players to decide how they will respond, but Kronos will always remain polite and professional. If the players are friendly, Kronos will immediately dive into business, explaining that he is



AGENCY JOB

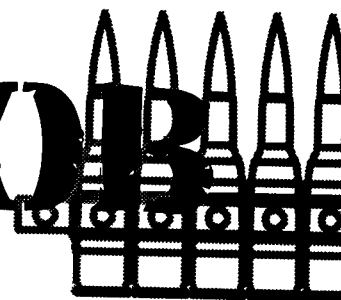

prepared to hire the characters to run a mission that will not only pay well, but will give them a chance to make some points with the crowd at the Hope.

If the characters are interested, Kronos will explain the basics of the mission and offer a fee. His speech will run like this (you may quote directly, or paraphrase, depending on how much you have modified the adventure):

KRONOS' SPEECH

"This mission is a hands-off job for me. It needs to be done, but it must be done by people who can't be traced back to my employers. This enables them to point the blame elsewhere and avoid any messy accusations. After all, everybody knows what a dangerous place Night City can be.

"The situation is this: it seems that the government of Colombia is using a large yacht to insert black operations teams into American coastal cities. These teams are helping to establish the receiving ends of drug pipelines from Central and South America, and are actively working to hinder the operations of American authorities. We have intelligence that indicates that this ship is at anchor in Night City right now. We want to take it out.

"The problem is that there are over thirty major yachts anchored in Pacifica Bay right now, and at least half of them could be our baby. None are registered to Colombia. We've had Netrunners in and out of Colombian government computers for two weeks, but as near as we can tell, the information we want is not stored on any database.

"We did get a break recently, though. The Treat-Davies Act of 2013 re-established diplomatic relations with the South-Ams, and gave them embassy rights in the U.S. It cost us a valuable agent, but we have reason to believe that the information we want is stored in a safe in the office of the Consul-General in Colombia's Night City consulate. Unfortunately, the Consul himself is back in Colombia for two weeks, so we can't wring the name of the ship out of him. That means penetrating the consulate, opening the safe, finding the correct document, getting the name of the ship, and then destroying the ship before she flees."

If the characters ask why the secrecy, Kronos will explain, "The Colombians have moles throughout our country, and our government. By using freelancers to run this mission, there's no paper trail to any

THE GUESSING GAME

Kronos will not name his employers, but, because of his reputation, it will probably not be difficult for the characters to guess that it is the CIA. The characters' inferences won't bother Kronos. A guess, no matter how educated, is still a long way from proof.

official organization. Even if you are captured and interrogated, there is no confirmation anywhere that you are anything but independents. This gives us some insurance against an international incident. After all, international relations aren't about what you do, but how you do it."

If the characters agree to take the mission, Kronos will offer them 1000 ebeach. He can be bargained up to 2000 if the characters are shrewd. He will also provide the characters with maps of the consulate, weapons and demolitions material if necessary. The characters must accomplish the mission within seventy-two hours. How the characters penetrate the consulate is up to them.

PART TWO: CRACKING THE CONSULATE

The characters' first objective is to penetrate the Colombian Consulate building in Night City, crack the safe, find the correct document or file, and either take it with them or get the information they need on the spot.

The Consulate is in an office building in the South City district. The building's lobby is supervised day and night by two guards leased from Arasaka Security. Security on the consulate floor is provided by consular personnel who are assumed to be soldiers. Kronos estimates that there are from five to eight soldiers on duty at any given time. There are workers in the building twenty-four hours, but the night shift is considerably smaller than the day shift.

Kronos will tell the characters that their biggest enemy is likely to be time. The consulate has an account with Arasaka security, and it is hardwired to the local Arasaka office. That means the alarm signal can not be intercepted by a Netrunner. Snipping the line itself will also send an alert to the security company. There are three options: incapacitate the two lobby

guards and everyone in the Consulate so that the alarm won't be raised, execute the entire operation in under four minutes (the projected response time for an Arasaka response team), or accomplish the operation without alerting anybody. The characters can choose any method they feel that they are most suited to. Remember: they have a map of the building, and although they are not sure of the exact location of the safe, they know that it is somewhere in the Consul General's office.

GETTING INTO THE CONSULATE

Although the alarm to the Arasaka regional office is hardwired, the building access and security systems are software-based and can be manipulated by a Netrunner. The team Netrunner should attempt to get into the system before the other characters enter the building. (See the map of the building data-fortress for programs, layout and task difficulties.) Once the Netrunner has control of the building functions, the other characters will have an easier time completing their mission.

There are a number of strategies the players might try.

Bluffing the Lobby Guards: The building has a metal detector built into the

THE COLOMBIAN CONSULATE

The Colombian Consulate occupies the entire fifth floor of a seven floor office block called the Steiner Building. It is in a commercial district, and local traffic is fairly heavy, day and night. Most of the businesses in the building close at night. The neighboring buildings are four and six stories tall, and separated from the Steiner Bldg. by wide, tree-lined walkways. The space behind the building is used for private parking.

The consulate floor has a central lobby and reception area, private offices and interview rooms, sleeping areas, storage lockers, and secure areas. (See the map for more detail.) Players will know only the general layout and which rooms are which. They have no information as to the exact contents of the rooms.

doorway, and the guards will frisk everyone who enters for weapons. People with weapons will be asked to leave them in the lobby unless they have ID certifying that they work in the building. Obviously, the guards will be skeptical of a heavily armed party of five that claims to have legitimate business at the consulate. If the Arasaka guards are threatened, or notice a problem, they will try to trigger the hardwired alarm to the company. All IDs will be checked visually and by magnetic strip, and no one posing as maintenance will be admitted without a work order. (See the sidebar for guard stats.)

SKILL CHECK

The adventures in this book ask for skill checks in the following manner:
 Make a Stat/Skill roll over x. Example: Make a Pick Lock roll over 20.
 Any roll, 20 or over is successful.

Wasting the Lobby Guards: It's direct, efficient and cyberpunk, (if not particularly subtle). The problem with this tactic is that the guards will immediately make triggering the hardwired alarm their top priority if they are under attack. The characters will also run the risk of alerting police or the consular personnel upstairs with gunfire or alarms. (See sidebar for stats.)

Sneaking Into the Building: With the help of the Netrunne, and some Electronic Security rolls, this may be the best way for the characters to go about getting into the building. If the characters can get onto the roof it will be fairly easy to get in. Coming in through the ground floor, they run the risk of alerting the guards. If alarms are tripped at any time, then a four minute count-down will begin. If the characters can't complete their mission in four minutes (game time) they will have to deal with an Arasaka Quick Response Team. If the characters come in at the ground floor they will need a **Stealth roll vs. the guards Awareness/Notice** to sneak past the lobby guards. (See the sidebar for stats.) Getting into the building any other way takes an **Electronic Security roll over 20**. Failed Security rolls will mean alerting the Arasaka quick response team, failed Stealth will cause the lobby guards to investigate.

THE STEINER BLDG. LOBBY GUARDS

These are the two Arasaka contract guards posted in the lobby of the building.

Stats: INT 7, REF 10, TECH 5, COOL 9, ATTR 6, LUCK 5, MAB, BODY 8, EMP 7, SAVE 8, BTM -3.

Skills: Combat Sense 4, Intimidate 4, Awareness/Notice 5, Dodge and Escape 2, Driving 3, Handgun 4, Submachinegun 3, Rifle 3, Melee 4, Karate 3, Stealth 2.

Cyberware: Basic Processor, Chipware Socket, Interface Plugs. One of them has a Smartgun Link and Basic Cyberoptic with a Targeting Sight. The other has a basic Cyberarm.

Gear: Headset radios, Arasaka WMA (Minami) submachineguns with four magazines each, flashlights, mono-knives, handcuffs, access cards, and SP 18 torso armor, Arasaka WSA pistols with four magazines apiece (P O J C 2DG+3(10mm) 15 2 VR 50m).

Note: See *Corpbok One* for more detailed information on Arasaka guards and soldiers.



IN THE CONSULATE

Once in the consulate, the characters will have to move as quickly as possible. Even if the hardwire to Arasaka hasn't been tripped, the police may arrive at any time. The police may not be a major factor in Night City, but they sure can ruin an operation if they show up at the wrong time.

There will be five to eight armed guards in the consulate. Two will be posted in the fifth floor lobby, and the others will be roaming the floor at random. The lobby of the consulate is closed to the public at night, and the door is locked. The guards will unlock the door to speak to people, but they will demand identification from anyone who wants to enter.

In addition to the guards, there will be 2D6 consular personnel on hand. They are not armed, and will interfere with the characters only if presented with a good opportunity. They *will* try to escape and raise the alarm.

GETTING THE INFORMATION

Once safely in the consulate, the characters must open the Consul's safe and find what they're looking for. The Consul's office has no windows, and is not accessible from outside the building. The players' map should indicate which room it is.

The Consul's safe is hidden, and the characters will have to search for it. If the characters make **INT rolls over 20** they will find the small safe hidden behind some books on a large bookcase. The safe has a manual lock and will require either explosives or a **Pick Lock roll over 23** to open. The safe is electronically wired to building security, however, and it will signal a problem if forced open. If the characters decide to blow the safe the Netrunner will have to be on his or her toes to intercept the alarm signal. Intercepting the signal requires an **Interface Roll over 20**. A failed roll means that an Arasaka quick response team is on the way. Begin the four minute count-down. The characters will have to make a **Demolitions roll over 20** to successfully blow the safe. A failed roll means the safe is still shut and the alarm is tripped. A fumbled roll means that the contents are destroyed, and the characters are at an impasse.

Inside the safe are a number of computer disks and files. They are not clearly labeled, and the characters will not have time to examine them all at the site. They should take the contents and check them out somewhere safe, perhaps with Kronos' help.

PART THREE: CHECKING THE INFORMATION

Once the characters have successfully liberated the contents of the safe, they should retreat to someplace secure to check them out. It will be much easier to interpret the information if they return to the Forlorn Hope and show the files and disks to Kronos. One way or another, the characters must move on the boat within the next sixteen hours, or she will flee the bay.

If the Characters Ask Kronos for Help: This will simplify things greatly. Kronos is skilled at interpreting the files, and has the necessary ciphering equipment to break some of the Colombian diplomatic codes. He also has a deck which can access the information on the optical computer disks without destroying them (see below). Kronos will require about one hour with the information. He will then brief the characters on what he has discovered.

- 1) The name of the ship is "*Celeste*," flying the Norwegian flag. A brief netrun into the Coast Guard or US customs database (No ICE, but **Interface rolls over 18**) will reveal that the ship is nominally owned by a Norwegian millionaire by the name of Kjell Onsen. If necessary, Kronos can also get this information through the Agency. There is no record of Onsen being a Colombian sympathizer, but further research will show that he does own a chemical firm which conducts regular business with parties in Colombia.
- 2) Just a few hours ago, the yacht deployed a black ops team attached to the Mendoza Plantation in Colombia. The team has orders to secure a small airfield on the outskirts of Night City and prepare it to receive an aircraft flying a major shipment of synthetic drugs in from the Mendoza Labs. The plane is due in twenty-four hours, after which the team is to rendezvous with the yacht.

If the Characters Try to Interpret the Information Themselves: The information on the boat, including the connection to Kjell Onsen, is all stored on one of the optical disks. There are two problems.

CONSULATE GUARDS

These are Colombian soldiers in civilian clothes, but wearing armor and carrying weapons. Multiple stats are for variation between individuals. The guards are armed with pistols. If attacked, they might, at GMs discretion, attempt to get submachineguns, rifles, or other weapons out of the gun locker (see map).

Stats: INT 6, REF 8 to 9, TECH 5, COOL 8, ATTR 6, LUCK 5, MA 7, BODY 8 to 10, EMP 7, SAVE 8-10, BTM -3 to -4.

Skills: Combat Sense 3, Intimidate 2, Awareness/Notice 4, Hide/Evade 3, Spanish (Native), English 2-6 or chipped, Brawling 5, Dodge and Escape 3, Handgun 3, Submachinegun 3, Rifle 4, Driving 3, Stealth 2.

Cyberware: Two have no cyberware. The rest have Basic Processors, Chipware Sockets and Interface Plugs. Two of those have Smartgun Links and Basic Cyberoptic, with Infrared, Targeting Scopes. Another has a Cyberarm with Thickened Myomar.

Gear: All are carrying Federated X-9mm pistols, with three magazines apiece. Those who are equipped to use them are carrying smart-chipped pistols. There are MPK-9 submachineguns and Fabrica De Armes M-2012 rifles in the gun locker. All are wearing SP 10 armor T-shirts under their suits.

One, as soon as the disk is inserted in a computer, this prompt will appear in Spanish: ¿PASSWORD? Obviously, the characters won't know the password, and they may not even have anyone who speaks Spanish. It will be up to the Netrunner to get into the disk and bypass the password, either through a cyberdeck, or with a keyboard and Computer Programming skill. If the Netrunner doesn't speak Spanish he or she will have to use a Spanish language chip while doing this. A *Decryption* program (see the Netrunner program list in *Cyberpunk 2020*) should be used to bypass the password. Cracking the password requires a **Computer Programming or Interface roll over 22**. Remember the bonus from the *Decryption* program. A failed role means that the data on the disk self destructs. If this happens, then the Netrunner will have one last chance to rescue the data. Use the same skills and **roll over 25**. Using a *Rerazz* program will help (add appropriate bonus). If this fails, then the data is lost and the characters will have to improvise.

If the characters successfully crack the disk, then they will get all the information detailed in option one.

PART 4: THE CELESTE

Once the characters have cracked the consulate, they have sixteen hours to get to the *Celeste* and destroy it. The more time they spend working on the disk, the less time they will have to get to the yacht. The problem: the yacht is anchored out in the middle of the bay, and can only be approached by air, over the surface of the water, or underwater. If the characters decide that they want to go underwater, Kronos will provide them with Maritime Ops/Scuba +2 MRAM chips, and Swimming +3 APTR chips. Getting the chips will require two hours. Icepick, who is an expert in this area, can help out if necessary. Kronos will also provide scuba gear and Zodiac inflatable speedboats (SP 5, SDP 25), courtesy of his network of contacts. If the characters approach by air, Kronos will provide an AV-4. If none of the characters can fly it, then Zora will take the stick. Going by air is *not* the recommended method.

A little recon will reveal that the yacht is anchored well away from any other vessels. There are guards at the railing twenty-

four hours a day, and at night the surrounding water is floodlit. (These are all common practices for the owners of expensive ships in these troubled times.)

**"FOLKS, YOU'RE GOING TO HAVE TO KEEP YOUR WITS ABOUT YOU. THIS JUST ISN'T THE TIME TO BE HARD-CHARGING HEROES, UNLESS YOU WANT TO BE WASHING UP ON THE SHORES OF DEL CORONADO BAY IN A WEEK."
-KRONOS**

SECURITY ON THE YACHT

There are sixteen crewmen on the yacht at all times, including the captain, the mate, six other miscellaneous crewmen and eight security men. If the characters strike during the night, half the men will be asleep. The first mate will be on watch on the bridge, along with two other crewmen. One security man will be stationed on the bow, one on the stern, one on the flying bridge overlooking the ship, and one will be roving. (See the sidebar for stats.) The crewmen are all carrying pistols. The security men have submachineguns.

The yacht is fully wired, including active sonar underwater, radar over water, and television cameras above and below the waterline. There is a small speedboat tied onto the stern and a fifty-caliber machine-gun (HVY -1 N R 4D10 (20mm/.50) 200 10 ST 400m) attached to

a mounting on the flying-bridge railing. The machine-gun is covered by a tarp.

The yacht has an underwater bay for deploying scuba divers. This is how it offloads black-operations teams. The doors are kept shut, and can be opened only from inside the boat. A Netrunner with a cellular deck can get into the boat and trigger the doors remotely (see yacht subgrid map). The yacht itself can be controlled as a vehicle remote, but the crew will immediately take the ship's computer off-line at the first sign of unauthorized control. With the computer off-line, the Netrunner will have no access to or control over any of the ship's systems.

If the Characters Come by Air: there will not be much subtlety involved. It will simply be a matter of raking the yacht with gunfire from the AV's minigun until it catches on fire or sinks. There is not much subtlety to this method, and it should only be permitted if the characters are running short on time. The AV may take some fire from the machine-gun on the ship. If it goes down in the bay, the characters will have to cope however they can. Good luck.

If the Characters Come Over Water: If the Netrunner is not blocking it, the *Celeste's* radar will pick up the Zodiac as soon as it comes within a kilometer of the yacht, but crew won't see it as a threat until it comes within three hundred meters. They will then launch the speedboat with four men aboard. Assuming they come by night, the characters will not be able to get closer than about 100 meters before they become visible in the floodlights. If they have procured some kind of heavy weapon, then

CELESTE CREWMEN (TECHS)

Stats: INT 8, REF 8, TECH 9, COOL 7, ATTR 7, LUCK 3, MA 8, BODY 7 to 10, EMP 8, SAVE 7 to 10, BTM -2 to -4.

Skills: Jury Rig 4, Swimming 5, Leadership 4 (captain, mate only), Awareness/ Notice 4, Expert Marine Technology 5, Expert Maritime Procedure 4, Navigation 6 (captain, mate, navigator only), Norwegian (Native), English (Chipped), Spanish (Chipped), Brawling 3, Melee 2, Handgun 2, Heavy Weapons 2, Pilot Boat 5 (captain, mate, helmsman only).

Cyberware: Varies. Most have Basic Processors and Chipware Sockets. The captain and the helmsman have Interface Plugs and Vehicle Links.

Gear: Federated X-9mm pistols, with 2 magazines each.

THE CELESTE

The *Celeste* is a 40 meter yacht powered by CHOOH2-driven turbine engines. It has a top speed of thirty knots. The *Celeste's* hull is SP 10, and the yacht has 150 SDP total. The ship has 25% chance of sinking for every 15 SP the hull takes below the waterline. The speedboat is SP 5, SDP 30.

that may be close enough. The characters should be careful, though. If they use a weapon with only one shot, they may not be able to sink the yacht; it's pretty large. Also, if they miss, or fail to sink the yacht, they will immediately come under heavy fire, and they may be pursued by the *Celeste's* speedboat. Then the characters will find out how little cover an inflatable Zodiac offers from fifty-caliber weapons fire.

If the Characters Come Under Water:

This is the toughest option, but it is probably the least risky, both in terms of danger and probability of failure. The characters should park the Zodiac several hundred meters away from the yacht. The characters with the highest MAs or the best swimming and demolitions skills should do the underwater work, the rest should stay on the speedboat

to provide backup. Kronos will be able to provide four marine demolitions charges, each with a limpet pack which will adhere to the yacht's hull. The scuba rigs are good for about 70 minutes of air as long as the characters stay at a reasonable depth. Each rig has a diving knife, underwater light, flippers, two tanks, a mask, snorkel, regulator, weight belt, and a buoyancy control/life-vest. There is no dangerous marine life in Pacifica Bay, but if you want to give the characters a bad turn, have a big sturgeon scope out the divers. These harmless fish get up to fifteen feet long, and can be mistaken for sharks in the murky water. **Characters in scuba gear swim 1xMA meters per 10 second turn.**

Note: Scuba tanks are SP 10, SDP 15. If they take full SDP, they have a 50% chance of exploding for 3D10. Explosion damage may be lower if the tanks are depleted.

The water under the yacht is dredged to a depth of thirty meters. The floodlights penetrate only about ten meters, and even then visibility is low. The crewman monitoring the underwater cameras will have to make his **Awareness/Notice roll vs. the characters Stealth** (if any), and he will have a -5 modifier. The characters do have a 50% chance of being discovered by sonar as soon as they come within twenty meters of the yacht. If the Netrunner has pene-

trated the yacht's computer, he may be able to block the operation of the cameras or sonar. See the sidebar for *Celeste* crew stats.

The characters should distribute their four limpets around the hull. They must make **Maritime Ops rolls over 16** and **Demolitions rolls over 18** for the maximum probability of success. If they fail their rolls, then the boat may not sink. If they fumble, the charges may go off in their hands, or at different times, or not at all. If all rolls are successful, the yacht will almost certainly sink. The limpets' timers can be set from ten seconds to ten minutes, but the characters must be at least one-hundred yards away to avoid taking damage from the explosions. (For more about the limpets, see the **Consequences** section.)

If the characters are detected at any time, two to four security men in scuba gear will be dispatched from the *Celeste's* underwater bay to stop them. The men from the *Celeste* will carry knives and spearguns, and will wear sealed helmets with radios. (The characters are using regular gear, and will *not* have this advantage, although they may be able to overhear transmissions if they have Cyberaudio with high-range radio hearing.) It will take two minutes from the time the alarm is given for the yacht crewmen to get into their gear and hit the water.

CELESTE SECURITYMEN/DIVERS (SOLOS)

Stats: INT 7, REF 9-10, TECH 6, COOL 10, ATTR 7, LUCK 3, MA 8, BODY 8 to 10, EMP 6, SAVE 8 to 10, BTM -3 to -4.

Skills: Combat Sense 3, Swimming 4 (divers only), Intimidate 2, Awareness/Notice 4, Expert Maritime Ops/Scuba 4, Spanish (Native), Norwegian (Chipped), English (Chipped), Athletics 3, Brawling 5, Handgun 3, Submachinegun 3, Rifle 2, Melee 4, Speargun 3, Demolitions 4, Heavy Weapons 3.

Cyberware: Varies. All have Basic Processors and Chipware Sockets. Half have Interface Plugs and Smartgun Links.

Gear: Arasaka WMA (Minami) submachineguns with three magazines each. Spearguns (EX-2 NC 2D6 3 1 VR 10m). Spearguns take one action to reload. At any range over 10m they do 1/2 damage. Scuba kits will be identical to the characters except for enclosed helmets and radios.



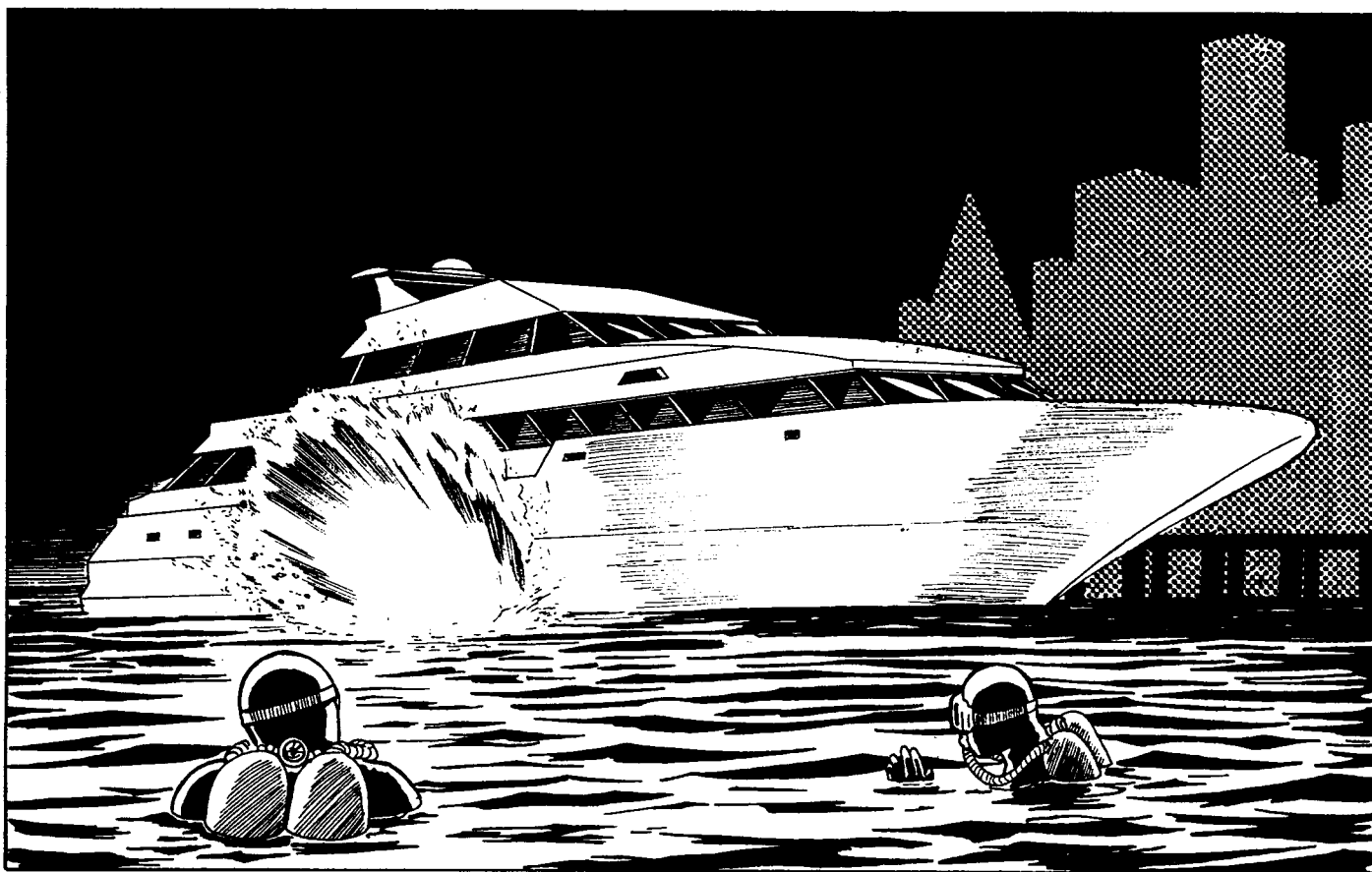

"At 2430 Hours, the mission was a success."

Regardless of the characters' stealth, the *Celeste's* crew will be alerted when the limpets are attached to the hull. The hull alarm system is hardwired, and the Netrunner will not be able to interfere with it. If the hull alarm goes off, a number of things will happen.

- 1) The characters who planted the explosives should be fleeing as fast as possible to escape the explosion range.
- 2) The *Celeste* will launch her speedboat with three security men on board. They will head towards the characters' Zodiac.
- 3) Two to four security men will put on scuba outfits and exit the *Celeste* via the underwater bay. Half are armed with spearguns and knives, and will search for the characters. Two others will search the hull and attempt to find and disarm the limpets. The security men will have to make **Demolitions rolls over 20** to disarm the limpets, and will take a minimum of two minutes for each mine. Failed

demolitions rolls will mean no disarming. Fumbled rolls will mean immediate detonation, with possibly disastrous consequences for any characters who have not yet cleared the area.

CONSEQUENCES

The limpet mines do 4D10 apiece, with the radius of damage extending 100m from the boat. For every 25m distance from the boat subtract 1D10. (Explosions underwater have devastating effects on living organisms). Each mine that goes off at the same time as another mine does a bonus 1D10 damage *to the ship's hull only*. That makes a total possible damage 20D10. If all of the mines go off simultaneously, the *Celeste* will almost certainly sink on the spot. Even one or two may be enough to do the job. Once the explosion goes off, the characters should quit the area as fast as possible to avoid the Harbor Police. If for some reason the boat does not sink, or they are foiled, the players will have to improvise. Once the yacht is sunk the characters have fulfilled their obligation to Kronos, and they can call it a night.

BACK AT THE FORLORN HOPE

If the characters successfully complete this mission they will get a surprisingly warm reception back at the Hope. News of success travels fast. Old regulars may still consider them "the New Guys," but their standing will have risen. One more mission and the characters will be able to con free drinks with the best of them. But perhaps a little holiday first. And a shower. That Pacifica Bay water is pretty grim.

OPTIONAL EPISODES

- ✘ If you want to pursue this adventure a little further, have the characters confront the Colombian black-ops team at the airfield, and try to intercept the incoming drug shipment. Otherwise, Kronos will have another team take care of that.
- ✘ The characters can go to Europe and pursue the Norwegian Connection between Kjell Onsen, the Mendoza Plantation and the Colombian government. ✨

TALES FROM THE FORLORN HOPE #2

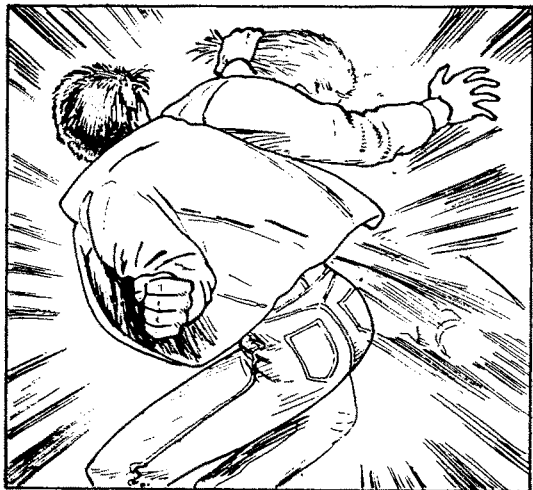
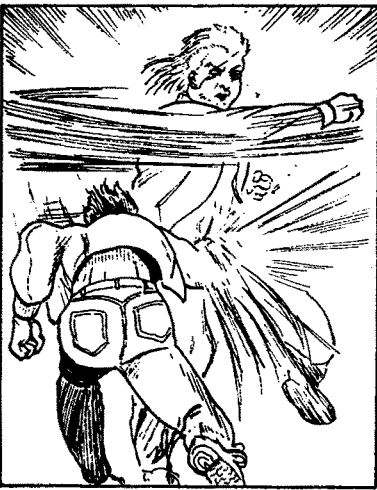
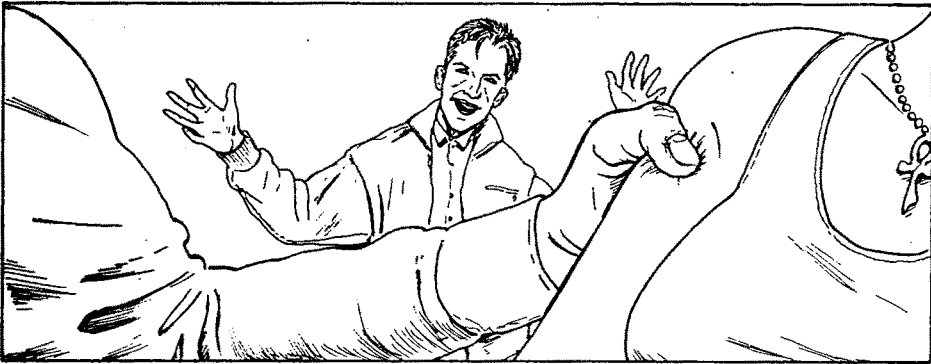

This adventure is a straightforward convoy run, but the characters won't know it until some time after the adventure begins.

It all starts when Marlo asks the characters to help her escort a Militech cargo to a local airfield. There, things will go awry, and the characters will have to run the convoy all the way to El Paso. Along the way to Texas, the characters will face unknown deserts and hills, plus raids from Nomads and unknown aggressors. There will also be a stop in the wild town of Tucson.

This adventure requires four Solos, and will work best with five or six. At least two members of the party should have Driving skill, although the adventure can be run with only one PC driver. Some vehicle tech skills will also help, but they are not necessary.

PART ONE: JUST A LITTLE JOB

It's a night at the Forlorn Hope. The characters will just be recovering from the rigors of the last mission when their next adventure begins. If the characters succeeded on their mission with Kronos, they will be enjoying a new level of respect at the Hope. While still not full-fledged members of the local Solo community, word of their success will have spread through the grapevine. People will be speaking to them, and perhaps even buying them a drink or two. If the characters failed on their mission for Kronos, or if they haven't attempted that particular adventure yet, they will be the same old gang of unappreciated cherries, slouching at a corner table wondering how they're going to make some points without getting into any fist-fights.

One way or another, Marlo will appear at the characters' table. If they have just completed a successful mission, she will say, "So I hear you guys are pretty quick. Kronos says you just pulled off a good one for him. I



A HARD ROAD TO GO

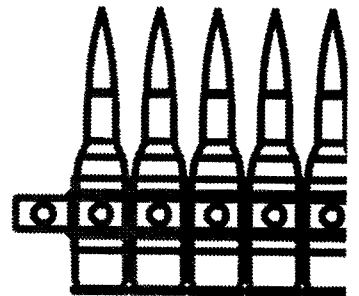

THE CONVOY VEHICLES

Komatsu-Peterbilt KP-10 Ten Wheel Transport

A large, three-axle armored transport with all-wheel drive. Commonly used for military hauling. Powered by an Avco-Lycoming CHOOH2 turbine engine. The truck has railings and running boards outside and on top for outriders, and an auxiliary power unit with batteries and a generator back in the storage trailer. The trailer is accessible from the cab, even while the truck is in motion. Use the Van/Truck line in the combat tables from *Solo of Fortune* and the Truck line from the FNFF control-roll modifier table. Safe maneuvering speeds are for on-road use, and may drop by 25 to 50% off-road.

Speed: 100mph, 30mph off-road. **Safe maneuvering speed:** 30mph. **Acceleration:** ±5mph/phase. **Fuel/Range:** 50 gallons, 500 miles. **Equipment:** Cybernetic link, navigation computer, radio, radar detector, automatic fire extinguisher, active computer controlled suspension, alarm, auto-braking system with

front-mounted radar, sleeper cab with space for four, and a front-mounted powered winch. **Armor:** Tires SP 15, SDP 20 each; Engine SP 25, SDP 25 SDP; Cab and Trailer SP 40, SDP 120; Windows SP 15, SDP 10.

Ford-Mazda Thunderbird IV High Performance Sedan

A fast, maneuverable sedan with room for five adults. Powered by a high-output twin-turbo V-8. Fueled by CHOOH2. An all-track, with full-time all wheel drive and good ground clearance. These models are designed for combat. Use the Compact line on the combat tables in *Solo of Fortune* or +1 on the FNFF control-roll table.

Speed: 120mph, 30mph off-road. **Safe maneuvering speed:** 60mph. **Acceleration:** ±10mph/phase. **Fuel/Range:** 15 gallons/500 miles. **Equipment:** Cybernetic link, navigation computer, alarm, radio, radar detector. **Armor:** Tires SP 10, SDP 15; Engine SP 20, SDP 20; Body SP 25, SDP 60; Windows SP 15, SDP 10.

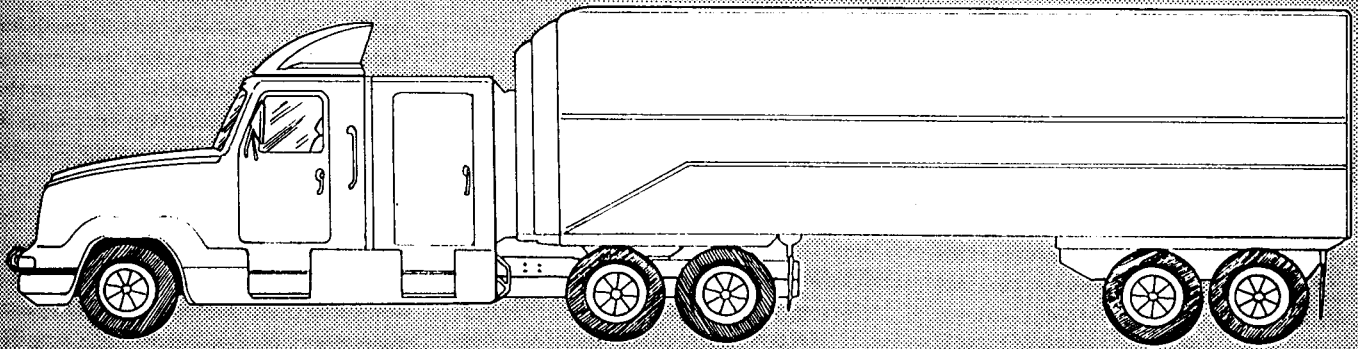

could use a few reliable people. I got a real quickie, good for a couple a' hundred apiece. Just a couple hours work, perfect for folks on the mend, such as yourselves." If the characters failed in their mission, or still haven't tried one, Marlo will take a different approach altogether. "You poor cherries (still) lookin' for a chance to prove yourselves? I got a mission nobody could screw up, even y'all. I'll even pay you for it. It's just a couple of hours, out to the edge a' town and back. Whaddayasay?"

Regardless of how they feel, the characters should jump at the chance to make some extra money on what sounds like a quick and relatively easy mission. If the characters express interest in the job, Marlo will take a seat and lay it out for them. "I'm running a cross-country shipment for Militech. We're running some stuff out across the Southwest. No need to say what or where. Gonna use an old Air Force trans-

port aircraft. The thing's a cow; it needs real runway. Anyway, the only place where we could set it down was on this dirt strip in the Central Valley, about two hours drive away. I need some hired guns to ride with me while I get this cargo to the strip, and to make sure the plane gets off the ground safely. I'm not expecting any trouble, but I've been budgeted to hire the extra help and I'm darn sure gonna do it. What do you think? Two hundred a pop for two or three hours work."

The characters may have some questions concerning the cargo or destination, but Marlo will stay tight-lipped. If the characters agree to the mission, Marlo tells them that she will reveal the cargo if it becomes necessary. She will say that it is nothing indiscriminately lethal, like biotoxins or genetic agents. Marlo will also answer questions about the transportation. (see below) If the characters accept the job,

Marlo will tell them that they should leave immediately, as she is already running an hour late. Everyone will head out the door to find that Marlo has a Ford-Mazda Thunderbird IV waiting (see sidebar).

THE VEHICLES

A short trip to a heavily-guarded warehouse on the nearby waterfront will reveal the other vehicle: an enormous Komatsu-Peterbilt transport truck (see sidebar). If asked, Marlo will explain that the warehouse belongs to Militech. The eight guards are unmarked.

Marlo will assign everybody to jobs based on their skills. The best driver in the group (which may be Marlo) will pilot the Komatsu-Peterbilt. The next best will drive the outrider car. The rest of the player characters will ride shotgun. If there is an odd number of people, the extra person will ride with the truck. When everyone is settled in,

EDDIE "HOLLYWOOD" HENDERSON (SOLO)

Stats: INT 8, REF 10, TECH 7, COOL 8, ATTR 8, LUCK 3, MA 8, BODY 7, EMP 7/5, SAVE 7, BTM -2.

Skills: Combat Sense 3, Streetwise 3, Persuasion and Fast Talk 2, Awareness/Notice 4, Hide/Evade 4, Wilderness Survival 2, Athletics 3, Karate 4, Dodge and Escape 3, Handgun 4, Submachinegun 4, Rifle 3, Melee 5, Driving 5, Basic (incl. vehicle) Tech 5, Heavy Weapons 2.

Cyberware: Basic Processor, Chipware Socket, Smartgun Link, Vehicle Link, Interface Plugs, Basic Cyberoptic, Targeting Scope, Low Lite™.

Gear: SP 4 leather pants, SP 14 armor jacket, knife, Sternmeyer Stakeout 10 shotgun.

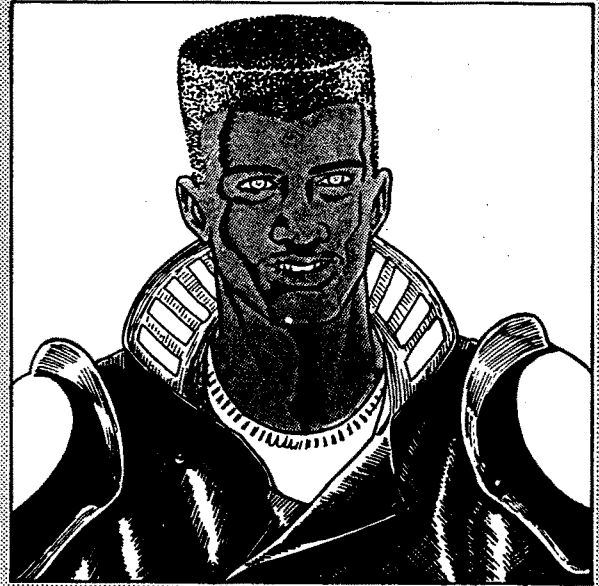

the two vehicles will head for the airfield. The two hour drive will be uneventful. Only after the characters arrive will things get strange.

PART TWO: THE BEST LAID PLANS

The team will arrive at the airfield in the small hours of the morning. The strip is eight-thousand feet of weed-strewn dirt out in the middle of California's San Joaquin Valley. There is nothing but agricultural land for miles around. Parked on one end of the dilapidated runway is an aging dinosaur from the past: an enormous, forty-year old C-130 Hercules turbo-prop transport retrofitted with CHOOH2 engines. At the other end of the runway is a collection of rusting Quonset huts and sheds. There are no other aircraft at the field, and it looks like the strip hasn't seen any use for some time.

Marlo will guide the convoy to a halt in the midst of the Quonset huts. There the characters will see another Ford-Mazda Thunderbird, standing next to which is a lanky, young black man with a pump shotgun. Marlo will signal via the vehicle radio that this man is her contact, and the characters should not be alarmed. She will get out of the truck and give the young man a quick hug, apologize for being late, and then introduce him to the characters as "Hollywood" Henderson, a freelancer working for the people she is delivering her cargo to, and an old friend. After the introductions, Hollywood will

tell Marlo that the plane is ready to roll as soon as its loaded. Marlo will get on a small radio and tell the cockpit crew to wind up the engines, then she'll ask the characters to drive over to the aircraft with her and help her load the contents of the truck onto the aircraft.

**"SO Y'ALL THE DUDES THAT
MARLO'S HANGIN' WITH
THESE DAYS. SHE AINT
BEAT NONE O' Y'ALL UP YET
HAS SHE? SHEEEEEOOT. YOU
SOME LUCKY BASTARDS,
SHE WAS WHIPPIN MY ASS
FIVE MINUTES
AFTER WE MET."
- HOLLYWOOD HENDERSON**

**"WELL, YOU SHOULDA KEPT
YOUR HANDS TO YOURSELF,
HOLLYWOOD!"
- MARLO**

The characters will hear the big turboprop engines coming to life, and will just be climbing onto the Komatsu when the C-130 will be obliterated in a violent explosion. The plane is far enough away so that the characters will take no damage. Anyone (NPCs included) who makes an **Awareness/Notice roll over 20** will see that the explosion originates inside the aircraft, and is not the result of a projectile. Anyone who

makes an **INT roll over 15** will recall that Marlo said earlier that they were running late. If she had been on time, she and Hollywood would be spiralling out of the sky over Arizona right now, along with the entire cargo.

TIME TO IMPROVISE

Quick checks of the surrounding area will reveal that there is still no one around other than Marlo, Hollywood, and the PCs. The aircraft wreckage is burning too hot for close inspection. There are obviously no survivors. Marlo will make the characters a new offer. "Listen, someone back at the company has it out for me. I was supposed to be on that plane when it went. I'm not gonna send for another aircraft. I'm gonna run this cargo the old-fashioned way. But I need some help. If you guys'll convoy with me out to El Paso, I'll pay you well and fly you back to Night City in luxury. We've got good vehicles and we're well-armed. What do you say?"

Marlo is willing to offer the characters 1000eb apiece. She'll also tell them that she's hauling weapons, and she'll give the characters a crack at them. If the characters agree, she'll divide them up amongst the three vehicles now available. One driver and one rider for each car, and anyone else in the truck. Hollywood (see sidebar for stats) can be a driver, or ride shotgun depending on the needs of the team. Marlo will stress that she wants to get away from the airfield before it gets light. Remote as it is, some-

one will eventually come to investigate. She says she'll offer a more detailed explanation of the cargo and destination as soon as they're moving. If everything is go, the characters can top off their tanks from barrels of CHOOH2 stored at the airfield, and then set out.

PART THREE: ON THE ROAD

Once the characters are safely moving, Marlo will get on the radio and explain to everyone a little about the cargo they're hauling. She will also discuss the route they must take and the stops they'll be making along the way. The cargo turns out to be a load of small arms and heavy weapons destined for Nomad troops on the border of Texas and Mexico. The border wars are heating up again, and Militech is covertly supplying the Nomads with weapons that the government won't supply. No one is clear on what Militech has to gain. Probably the support of the powerful Southwestern Nomad families.

Marlo has been checking maps and working with the range of the vehicles. She thinks she's got a good route laid out. It's a couple of hours south to Interstate 10, which stretches all the way from Southern California to El Paso. Parts of it are rough and lawless, but no worse than any other route. They'll drive throughout the day and rest up at Tucson, Arizona. There will be a detour around the population center of Phoenix. The first day's refueling stops will be in Indio, California, and Tonopah, Arizona. Indio is close to corporate-owned Palm Springs and is not particularly rough. Tonopah is a little more of a question mark.

The first leg of travel and the first refueling will go smoothly. There is no trouble crossing the border into Arizona. Once in Arizona, however, traffic on the interstate begins to dwindle. In Tonopah, things will get a little more tense. As the convoy approaches the town, they will see that the highway is blocked and barricaded. There is a smattering of townspeople waiting by the barricade with weapons in hand. Marlo will call a halt to the convoy while they are still several hundred meters away. She will then ask two of the player characters and Hollywood to go parlay with the townspeople. Marlo and the remaining characters will remain with the vehicles.

TONOPAH

The townspeople will wait for the characters to get close. There are about ten of them, and they are all armed. They don't consider three people to be a threat. As the characters get close, one man will step forward to meet them. He will ask what brings them through Tonopah.

As long as the characters are diplomatic the townspeople will be congenial. They will explain that they are on guard because a team of hostile Nomads has been raiding the stretch of I-10 between Tonopah and Phoenix, including the junction with Route 85. (The characters may recall that Route 85 is part of the detour that Marlo was planning to use to bypass Phoenix.) Tonopah has been raided twice already, and the residents are determined to prevent it from happening again. The Nomads are using bikes and light off-road vehicles, and they are well armed and ruthless.

If all goes well, the townspeople will agree to refuel the convoy, although the price will be steep due to the shortfall of supplies caused by the Nomad raids. If the characters explain what they have learned to Marlo, she'll tell them that she would rather take her chances with the Nomads than in Phoenix. Whoever planted the bomb on the aircraft will have learned by now of their escape, and will probably have figured out that the supplies are being driven. The most direct route to El Paso passes through Phoenix, and Marlo believes that the mystery enemy will try to pick up their trail there. Marlo will not change her mind.

PART FOUR: ROUGH RIDE TO TUCSON

Marlo will be anxious to hit the road as soon as possible, but forewarned about the Nomads, she will take the time to show the characters the cargo that they are hauling, and break a few selected items out of storage (see sidebar). Characters can have their pick of weapons they think they might need to defend the convoy. Marlo will tell the player characters to be sparing with the heavy weapons, as some of them should eventually be given to the fighters in El Paso. As soon as everybody is armed and prepped the convoy will hit the road again.

About ten miles before the convoy reaches the turnoff to Route 85, the

Nomads will attack. They have been watching the convoy approach, and have decided that it is a worthwhile target. They are too fast for the convoy to outrun. These Nomads are road raiders, and they should not be confused with the Nomad families fighting the border war. They will come streaming out from behind the low hills. Some will attack from in front of the convoy, some from behind. They will attempt to disable the outrider vehicles before concentrating their attention on the truck. The Nomads' goal is to stop the truck without destroying it. They want any cargo to be intact. They will also try to board the truck from their light off-road vehicles (see below). The Nomads will persist until at least half their number is wiped out. They may keep coming even after taking 50% casualties if they still think they have a chance of success. Remember to take moving vehicle mods into effect when running the combat. Motorcyclists will only be able to use one-handed weapons. The stretch of road where the Nomads attack is in disrepair, but it is fairly flat and straight. There is nothing but scrub and low hills on either side of the highway.

TUCSON

If the characters manage to repel the Nomad raiders, they will find the rest of the trip to Tucson uneventful. The road will be quiet enough for the convoy to pull over and make any necessary repairs. If none of the characters are good vehicle techs, then Hollywood can do the tinkering (assuming he's still alive). Depending on how long the attack delays the characters, it should be sometime late in the evening when the characters pull into Tucson.

The southwestern Nomad culture has caused Tucson to revert to wild lawlessness. The town is well populated, but it is a rowdy place, frequented only by Nomad families, panzer riders, and long-distance freight convoys. People spend time within the city limits at their own risk, living in a modern equivalent of the Wild West. Marlo has never been in Tucson, but Hollywood has, and he will suggest an inn where the characters can put up their feet and get some food and drink. (If Hollywood has been lost somewhere along the line, Marlo or one of the characters can be familiar with the inn.)

A CARGO OF DEATH

Marlo is hauling a cargo of small arms and heavy weapons to Nomads fighting a secret war on the border of Texas and Mexico. It is enough to equip a small army, which is exactly what it's supposed to do.

- ✱ 250 Militech Avenger 9mm Pistols, and ammunition.
- ✱ 250 Militech Ronin Light Assault Rifles, and ammunition.
- ✱ 100 Militech Bulldog Assault Shotguns, with multiple types of ammunition (SHT 0 L C 4D6(00) / 3D6AP(Slug) / 2D6Expl(Grenade) 213/10 ST 50m).
- ✱ 100 Militech Viper Submachineguns (SMG 0 J P 2D6+3(10mm) 40 30 200m)
- ✱ 20 Militech RPC-A Shoulder Fired Anti-Armor Weapons.

- ✱ 20 Militech Mini-Grenade Launchers (HVY O N P See Below 16 2 ST 50m)
- ✱ 20 Pairs Militech Refractix Plus 4x-10x light intensifying Binoculars.

Note: See *Corpbok Two* for more information on the Bulldog, the Viper, and Refractix binoculars, and *Chromebook* for the Mini-Grenade Launcher. The grenade launcher fires several types of rounds and can have a number of each loaded into its drum. When switching to a new load, the ROF drops to 1. HEP round: 5D6, 1/2 real, 1/2 stun only from concussion. Armor has no effect; drops two levels. Frag: 2D6+1, 5m diameter. AP Flechette: 1D6AP for each needle, 2D6 needles hit on a successful attack. Smoke or tear-gas, 5m radius.

THE HAMMERED THUMB SALOON

Hollywood's "inn" is a rambling, wooden building with a large parking lot. The parking lot is filled with dusty cars, bikes, enormous, armored, cross-country hauling vehicles and panzers. There appears to be a fair amount of action in the parking lot. People are gathered around oil-can fires, trading stories and drinks and getting into fights. Many of the people sport western garb. Others are clearly Nomads and truckers. There is light streaming from the windows of the building, and as the characters climb out of their vehicles they will hear music and laughter. A sign over the main entrance says "The Hammered Thumb Saloon". As usual, Marlo will stay with the vehicles. She will send Hollywood and the player characters into the bar to scope out rooms and food. If there is any trouble, she can summon the characters via radio or the vehicle alarm beepers.

The Saloon is crowded and noisy inside. The decor has been designed to reflect the Old-West mystique common to this area. Off in one corner, a dusty old man is working a honky-tonk piano. There are waitresses and working girls circulating throughout the crowd. Behind a long, mahogany bar a pot-bellied man with an apron and a green visor and a young lady in similar attire are busy pouring beers for the patrons.

The bartender will inform the characters that there are no more rooms open this evening. They can sleep in their vehicles. Food, however, is still being served. The characters will be told to take a table. One

of the girls will take orders. The menu for the evening includes beef, pork, beef, chicken, beef and lots o' beans. 15eb a plate. Enjoy. Somebody remember to take Marlo something, or she's going to be steamed.

THERESA

During the meal, a pretty but frantic young woman will approach the characters and ask for protection from her abusive boyfriend and passage to Texas. In return, she is willing to help guide the characters through the treacherous mountains on the highway between Tucson and El Paso. Hollywood will point out that those hills are pretty tricky to navigate, and any help will be good.

**"PLEASE, PLEASE GET
ME OUT OF TOWN. I'VE BEEN
RIDING THESE HILLS FOR
YEARS, I CAN TAKE YOU
THROUGH
PASSES NOBODY ELSE
KNOWS. PLEASE! IF HE
FINDS ME, HE'LL HURT ME!"
- THERESA**

Unfortunately, the boyfriend and three of his trucker buddies will show up and try to take the terrified young lady back. They are willing to try to go through the characters to do it. The fight with the toughs may cause a huge fist-fight to break out in the saloon and spill out into the parking lot. It may eventually turn into a firefight, but

that may bring the sheriff, and nobody wants that. He usually settles disorder with heavy weapons. Brawls such as these are fairly common occurrences in the saloon and Tucson in general.

SEdge LADURAS

Just before they go to sleep, the characters will find Marlo standing by the truck and talking to a handsome young man. Marlo will introduce the man as Sedge Laduras, someone she met when she was in Israel a few years back and "the most mercenary bastard I ever knew." Laduras is using a panzer (a long range, all-terrain armored hovercraft) to run valuable shipments across some of the rougher areas of the Southwest. Laduras is congenial and personable, and will even show the characters his craft if they are interested. He has one other crewman with him, but he is out running some errands. Marlo and Sedge will shoot the breeze for a while, and then call it a night.

Optional: If the characters get into hot water during the fight, you can introduce Sedge by having him come to their aid. The more the characters think Sedge is a good guy, the more astounded they'll be the following day.

PART FIVE: THE FINAL LEG

Marlo will rouse everyone before dawn and the convoy will hit the road for El Paso at first light. With any luck the girl, Theresa, will be accompanying the characters.

THE NOMADS AND THEIR VEHICLES

The Nomads have ten vehicles; four motorcycles, five light off-road vehicles, and one jacked-up pickup truck. Two of the off-road vehicles have two men apiece. The other two and the truck each have three men. The motorcycles have single riders. (If necessary, change the numbers to correspond to your team's strength.)

AMT BAJA BLASTER LIGHT OFF-ROAD VEHICLE

A tough and reliable dune-buggy type vehicle; fast and agile, but offering little protection for the occupants. At low speeds they can roll over completely and still be in functioning shape. Two men can sit up front, and one can stand in back. CHOOH2 fueled. Use the Sports Car line in *Solo of Fortune* or in the FNFF control-roll modifier table. One of these vehicles has a squad automatic weapon mounted on the roll bar and operated by the man standing in back (HVY 0 N R 6D6 (7.62) 200 20 ST 200m).

Speed: 120mph, 60mph off-road. **Safe Maneuvering Speed:** 60mph. **Acceleration:** ±10mph/phase. **Fuel/Range:** 10 gallons/900 miles. **Equipment:** Radio. **Armor:** Tires: SP 10, SDP 15; Engine: SP 15, SDP 15; Body: SP 5, SDP 40. Occupants are shielded only over their lower bodies. The windshield is the only window, SP 5, SDP 10.

MOTORCYCLES

A motley collection. Most are in good running shape, faithfully maintained by their owners. CHOOH2 fueled. Use the Motorcycle/Bike line in *Solo of Fortune* or in the FNFF control-roll modifier table.

Speed: 120mph, 40mph off-road. **Safe Maneuvering Speed:** 60mph. **Acceleration:** ±20mph/phase. **Fuel/Range:** 5 gallons/250 miles. **Armor:** Tires: SP 5, SDP 10; Engine: SP 8, SDP 10; Body/Structural Components: SP 5, SDP 30.

THE NOMAD RAIDERS

Stats: INT 7, REF 8 to 10, TECH 7, COOL 9, ATTR 6, LUCK 4, MA 8, BODY 8-10, EMP 7, SAVE 8 to 10, BTM -3 to -4.

Skills: Family 2, Intimidate 4, Awareness/Notice 5, Hide/Evade 4, Wilderness Survival 3, Brawling 5, Dodge and Escape 2, Driving 5, Motorcycle 5, Handgun 4, Submachinegun 4, Rifle 3, Melee 5, Basic Tech 6.

Cyberware: Varies. Several have Cyberlimbs, many have Cyberoptics and Smartgun Links. A few have no cyberware.

Gear: A variety of weapons including pistols, rifles, submachineguns and shotguns. Most of the weapons are old, but all are in good shape. There are eight grenades divided amongst the Nomads; four concussion and four fragmentation. Several others have molotov cocktails. (See FNFF for grenade and molotov damages and area effects). Most of the Nomads are carrying knives and almost all are wearing SP 4 leather pants and SP 18 armor jackets. Half have helmets.

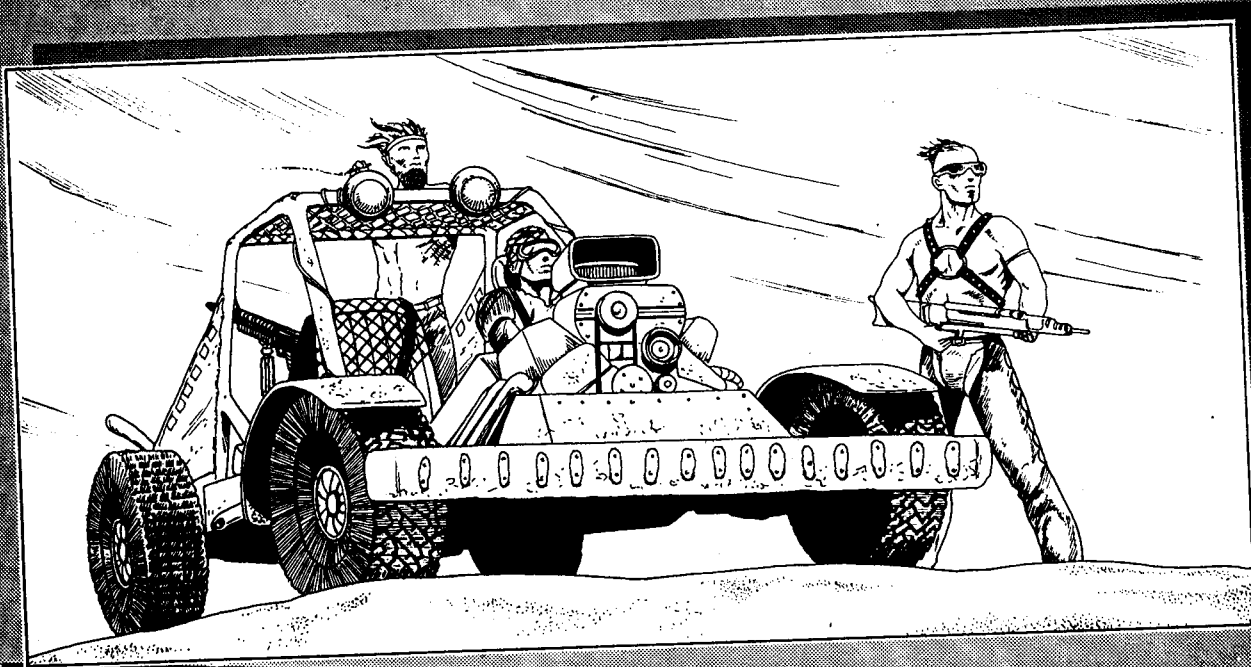

MARAUDERS ARE CONSTANTLY ON THE LOOKOUT FOR VICTIMS...

THE ABUSIVE BOYFRIEND (NOMAD)

Stats: INT 5, REF 10, TECH 7, COOL 10, ATTR 6, LUCK 6, MA 7, BODY 10, EMP 6, SAVE 10, BTM -4.

Skills: Family 4, Intimidate 4, Persuasion and Fast Talk 1, Awareness/Notice 4, Hide/Evade 1, Wilderness Survival 3, Brawling 6, Dodge and Escape 2, Driving 3, Motorcycle 5, Handgun 4, Rifle 1, Submachinegun 2, Stealth 1, Basic Tech 3.

Cyberware: None.

Gear: SP 4 leather pants, SP 18 armor jacket, metal blade knife, BudgetArms Auto 3, Brass Knuckles.

STANDARD SALOON TOUGHS (NOMADS AND SOLOS)

These can be used as both the barfight participants and the boyfriend's buddies. Half are Nomads and half are Solos.

Stats: INT 6, REF 8 to 10, TECH 6, COOL 7 to 10, ATTR 6, LUCK 5, MA 7, BODY 7 to 10, EMP 7, SAVE 7 to 10, BTM -2 to -4.

Skills: Family or Combat Sense 3, Awareness/Notice 3, Hide/Evade 2, Athletics 0-4, Brawling 4, Dodge and Escape 2, Handgun 3, Rifle 3, Submachinegun 3, Melee 3, Driving 4, Motorcycle 4.

Cyberware: Varies. Mostly Basic Processors, Chipware Sockets, Interface Plugs and Vehicle Links.

Gear: Varies. Mostly handguns, melee weapons and leather armor.

THE MOUNTAINS

The road out of Tucson is in poor shape, and it passes through treacherous mountains. Once it was the Interstate. Now it's only slightly more passable than the surrounding countryside. In some areas the road has been blocked by rock slides. Nomads and convoy men have carved new, cross-country short-cuts to bypass those areas, but the passes can be difficult to navigate without experience. If the characters are on their own, they will have to make three **INT rolls over 17** to successfully navigate the passes. Only *one* person can make the rolls, and maps are no help. Every failed roll adds 1/2D6 hours of travel time to the journey. Each hour of delay is equal to 50 miles of travel. From Tucson to the next fueling town is approximately three hundred miles. That means that the characters can only afford four hours of delay before they are in danger of having to beg fuel or abandon one of the outrider cars and siphon off its spare gas. A **fumbled INT roll** may find the vehicles trapped in a box canyon or damaged by the rough terrain. If the characters have Theresa with them, they'll have an advantage. She has an INT of 8, and Expert: Local Routes 6. That means that she has a 70% chance of success for the same roll.

SURPRISE ATTACK

If the characters clear the summit, the road will open up a bit. There are still obstacles and detours, but the road is wider and flatter and the detours are less hazardous and confusing. Unfortunately, there will be a new hazard. Any character who is checking the road behind them will have to make an **Awareness/Notice roll over 19** to see a large trail of dust far behind them. A look through the binoculars will reveal that it is a panzer, rapidly gaining on the convoy. If Marlo gets a chance to look at it (she will have to stop driving), or if one of the other characters describes it well, she will identify the vehicle as Sedge Laduras'. She will assume that there is no danger. She will, however, be perplexed when there is no response to her radio call.

When the panzer closes to within half a mile, any character still watching it with binoculars will get a chance to make an **Awareness/Notice roll over 19**. A successful roll will reveal to that character that all of the panzer's visible weapons are trained on the convoy. If Marlo and the other drivers get that warning they will have time to maneuver to avoid the attack. Based on the success or failure of the drivers' rolls, the referee should decide what modifiers Sedge has to take to his attack roll.

Sedge is out to destroy the truck. He doesn't care about the outriders and he

doesn't consider them a threat. (That may prove to be a mistake if the characters in the outrider cars have any of the grenade launchers or RPG-As from the cargo.) Sedge will slow his panzer down to match the convoy's speed. He will attempt to destroy or stop the truck until he is killed, or his panzer is severely damaged or destroyed. (See sidebar for Sedge's and the panzer's stats.) Marlo will state that her first priority is escape for the team, but she wants Sedge or his buddy taken alive if possible so that she can find out what's going on. If Theresa can make her **Expert: Local Routes roll over 20** she may be able to offer hints as to areas around the road or alternate routes that are large enough for the convoy but too confined for the panzer to enter or fight in effectively.

Sedge Wins: If the truck is disabled or destroyed, Sedge will cease his attack. If Marlo is still alive, he will demand that she be turned over to him. If there are protests he will attack again. Should Marlo be turned over to Sedge or obviously dead, he will leave, abandoning the other characters and any remaining vehicles. There will be no chance of completing the mission. Any surviving characters will have to head back to Night City.

The Characters Win: If the panzer is disabled, Sedge will attempt to hole up inside and defend himself. If characters attempt to get him out of the panzer, they

SEDGE LADURAS (SOLO)

Sedge is at the controls of the panzer.



"I USED TO RUN QUITE A LOT OF SHIPMENTS FROM ISRAEL INTO LEBANON, JORDAN AND THE OCCUPIED TERRITORIES. BUSINESS WAS GOOD, BUT IT GOT BORING, AND HALF THE PEOPLE I DEALT WITH WERE RADIOACTIVE."

- SEDGE LADURAS

Stats: INT 9, REF 10, TECH 6, COOL 8, ATTR 8, LUCK 2, MA 8, BODY 8, EMP 6/4, SAVE 8, BTM -3.

Skills: Combat Sense 4, Wardrobe and Style 2, Streetwise 2, Persuasion and Fast Talk 4, Awareness/Notice 3, Hide/Evade 3, Hebrew (Native), English 8, Shadow/Track 1, Wilderness Survival 2, Athletics 2, Aikido 3, Handgun 4, Submachinegun 3, Rifle 3, Melee 3, Pilot Panzer 5, Heavy Weapons 3.

Cyberware: Basic Processor, Chipware Socket, Interface Plugs, Vehicle Link, Smartgun Link, Basic Cyberoptic, Targeting Scope, Infrared, Times Square Marquee.

Gear: SP 18 armor jacket, monoknife, Militech

Avenger pistol with four magazines, AKR-20 assault rifle with four magazines, three concussion grenades.

CHARLIE "C.G." GOUGH (TECH)

C.G. is Sedge's partner, maintenance man, and weapons operator.

Stats: INT 8, REF 7, TECH 9, COOL 8, ATTR 7, LUCK 4, MA 7, BODY 8, EMP 7, SAVE 8, BTM -3.

Skills: Jury Rig 3, Awareness/Notice 4, Education and General Knowledge 2, Hide/Evade 1, Brawling 4, Melee 3, Dodge and Escape 2, Pistol 3, Rifle 2, Submachinegun 1, Heavy Weapons 4, Basic Tech 5, Aero Tech 5, Electronics 4, First Aid 3, Driving 2, Pilot Panzer 3.

Cyberware: Basic Processor, Chipware Socket, Interface Plugs, Vehicle Link, right Cyberarm with Toolhand, Basic Cyberoptic, Low Lite™, Teleoptics, Times Square Marquee.

Gear: Metal blade knife, SP 14 armor jacket, Arasaka WMA (Minami) Submachinegun with five magazines, two smoke grenades.

MILITECH A-20 AIR CUSHION ASSAULT VEHICLE (PANZER)

A combat hovercraft used for troop and cargo transport. Powered by two IEC Python Mini Turbofans. Powered by J-4 jet fuel. Normally crewed by three (pilot, copilot, gunner). Use the AV-4 line in *Solo of Fortune* and FNFF, but discount flying maneuvers.

Speed: 200mph, 100mph off-road, **Safe Maneuvering Speed:** 100mph. **Acceleration:** ±20mph/phase. **Fuel/Range:** 800 gallons, 600 miles. **Equipment:** Cybernetic interface, navigation computer, sealed environment, ejection seats, radio, radar, sonar, radar detector, terrain following/obstacle avoidance radar, Infrared/Low-Lite™ systems. **Offensive Weapons:** Turret mounted Militech 20mm cannon (HVY-2N R 20mm(4D10+2AP) 500 5 ST 450m), front mounted co-axial 7.62 machine gun (HVY 0 N R 6D6+2(7.62) 500 20 ST 200m), four turret mounted TOW missiles (6D10), hit on 75% if the operator makes a Heavy Weapons Roll over 15 (see *Solo of Fortune*). **Defensive Weapons:** Chaff/Flare dispensers (100 each), 20 smoke dispensers, ECM, Antipersonnel frag grenades (6D6) at 7 locations around the hull. **Armor:** Skirts SP 10, SDP 15 per panel, (the craft can no longer move when 5 of its 20 panels are destroyed), engine nacelles SP 30, SDP 50; turret SP 60, SDP 60; body SP 50, SDP 100, windshield SP 30, SDP 30; plenum chamber SP 40, SDP 50.

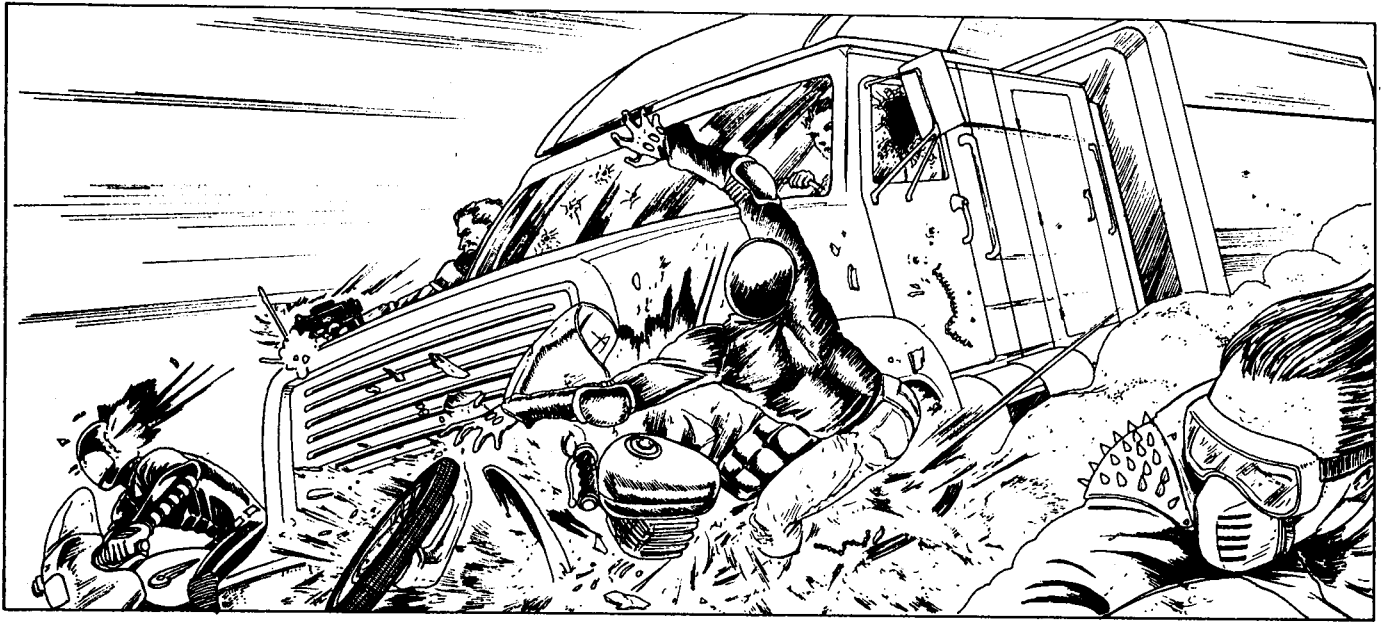

Bustin' through the marauder attack

will have to make Awareness/Notice rolls over 15 to spot the defensive charges and Demolitions rolls over 20 to disarm them. Beware, they can be triggered from inside the panzer if its systems are still operational. If the panzer is destroyed, Sedge will flee if at all possible. If either he or C.G. are captured and interrogated, the

characters will learn that Sedge got a call from Night City shortly after the convoy left. Someone there offered Sedge and C.G. 10,000eb to destroy the truck and kill Marlo. The caller was from Militech, and claimed that Marlo had gone renegade with a company shipment. Sedge received 5,000 in advance in a wire from Night City.

The wire was signed by a woman named Sandra Bonetti.

When Marlo learns this, she will get extremely angry and offer the following explanation to the characters. Sandra Bonetti is another Night City street rep who frequently competes with Marlo for contracts. She wanted this job badly, and Marlo had a confrontation with her before the mission. Marlo never thought that Sandra would do anything like this. She must have also had the bomb planted on the C-130. Marlo will swear revenge.

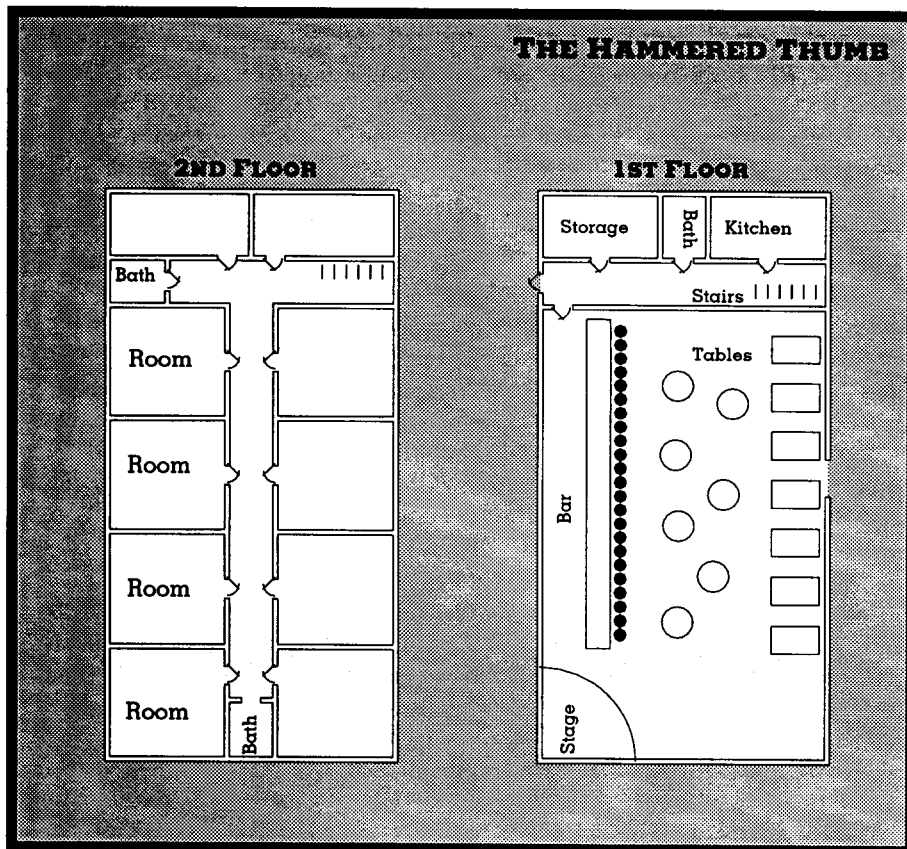

CONCLUDING THE ADVENTURE

The rest of the days' travel will go uneventfully. The characters will reach El Paso and deliver the remaining weapons to the grateful Nomads. True to her word, Marlo will have the characters flown back to Night City first class (with a short stop in Albuquerque). By the following morning, the characters will all be back in Night City, a little richer and a lot more experienced.

OPTIONAL EPISODES

- ✦ The characters may accompany Marlo when she goes to confront Sandra Bonetti. There, they may or may not learn that Bonetti is being bribed by the Mexican Government to interfere with arms shipments to the Southwestern Nomads. ★

TALES FROM THE FORLORN HOPE #3

In this adventure the characters are asked to go to Europe to help Wolf find his brother, Franz Reimann. Franz disappeared while on a trip to strife-torn Romania, and Wolf is worried that he may be in serious trouble. While in Romania, the characters will stumble across a secret society and a plot involving the EBM corporation.

Any assortment of characters can participate in this adventure. Combat effectiveness will be necessary, but the team will also have an advantage if any of the members are experienced in Eurocultures and languages, international or corporate intrigue, or detective skills. Wolf will help to cover those areas if the characters are deficient. Remember, the characters can always use chips to speak the languages.

PART ONE: OVERSEAS HOLIDAY

The characters have probably now gone on multiple missions for regulars at the Forlorn Hope. If they have succeeded, they will be getting a reputation at the bar as a hard-working, hard-hitting team of reliable professionals. Their names are being mentioned by regulars as candidates for more and more jobs. If the team is batting under 1000, then their local reputation may be less generous.

Regardless of the outcomes, the character's efforts have not gone unnoticed by the Professor and Marianne. Marianne has referred the characters to the expatriate German solo, Wolf, who is looking for some people to accompany him to Europe. Wolf will approach the characters with his offer, and open the dealing with the following line: "Hey, how would you guys like to see the world, on me?"

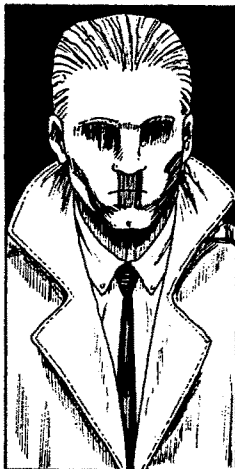

THE

IMPALIERS



EASTERN EUROPE AND INTERPOL IN 2020

Eastern Europe: Eastern Europe has been a region in turmoil for three and a half decades. With the demise of the centralized control of the USSR, political upheaval and rebellion are common occurrences in central Eastern Europe and the Balkans. Many nations have ceased to exist. Others have weak governments and poor internal regulation. Wars between nations occur over things as petty as single power plants. This atmosphere has made the region ripe for corporate exploitation. There is a large pool of cheap labor, and the shaky governments mean that the corporations don't even have to pay

lip service to pollution and safety regulations that are enforced in the mainstream EEC nations. Corporate wars are common in Eastern Europe, and many of the cities are violent, grimy places. Sounds kind of like home, doesn't it?

Interpol: The International Criminal Police Organization is based out of Berlin. It has five directorates. The 1st Directorate is Counter Terrorist operations. The 2nd is Counter Intelligence services. The 3rd Directorate is Netcrime investigation, and the 4th is Corporate Crime. The 5th and final Directorate is the Orbital Branch.

Note: For more information on Europe in 2020, see *Eurosource*, the Eurotheater Sourcebook for *Cyberpunk 2020*.

Wolf will go on to offer this explanation of his proposal. (Characters may have to ask him to repeat words obfuscated by his heavy accent.) "I recently received a letter from my brother, Franz, who works for Interpol's fourth directorate. He told me that he was taking a holiday and going to Romania because he was interested in studying the history of the area and the local legends. That was over three weeks ago. One week after that, I got a card from Romania. It said everything was good, and he was enjoying himself. Nobody has heard from him since then. He was supposed to be back at work a week ago; I think he may be in trouble.

"I am going to Europe to try to find my brother. I need good people to come with me, to help me, and to help cover me because I have many enemies there. I can't pay much, but Dollar Bill has given me a loan of some money. I can provide the tickets, buy what we need in Romania, and give each of you 200eb a day for each day we are there."

At this point the characters may have some questions. If they ask why Interpol hasn't succeeded in uncovering his brother, Wolf will say that the organization isn't looking into it. They have told him that, since his brother was not on assignment, they consider it a local police matter. Wolf will tell the characters that he has talked to the local police, and they consider it an Interpol matter. They place a low priority on rounding up errant foreigners. If the characters ask why Wolf isn't using his own contacts in Europe, he will say that he hasn't got many contacts in Europe any more.

PART TWO: IN EUROPE

If the characters agree to accompany Wolf, they will leave the next day for Europe. Wolf will provide the characters with Romanian Language +4 MRAM chips. Everyone will travel under their own names, but with false Militech passports provided by Dollar Bill. Because of his notoriety in Europe, Wolf will use an assumed name and a false passport. The characters will fly a Lufthansa hypersonic jet nonstop from

Night City to Vienna. Then there will be a connecting flight from Vienna to Timisoara, where the characters will receive permission to enter Romania.

TIMISOARA

In Timisoara, Wolf will explain his plan to the characters. In his post-card, Franz mentioned that he was staying with a Gypsy man he had met in Timisoara. The gypsy's name was Paris Gulachoz. Gulachoz had agreed to guide his brother to the ruins of a monastery near Timisoara where, legend has it, the head of the tyrant Vlad Tepes was embalmed (see sidebar). The only problem: Wolf has no idea whether Gulachoz is still around or where he can be found. He has been unable to locate the man through the phone directory. All he knows is that the postcard came from an open-air bazaar called the Bega Canal Market. That's as good a starting point as any.

The following day, Wolf will take the characters to the Bega Canal Market. It is a crowded conglomeration of open-air stalls and shops arranged along a street fronting the oily Bega Canal. The market is populated with shoppers and unemployed Romanian youths. Wolf will separate the characters into pairs. If there are an even number of characters, Wolf will go solo. He will tell the characters to case the stalls and see if they can get a lead on Paris Gulachoz.

Note: Play up the anti-American sentiment again.

The first team to make a **Streetwise** roll over 20 will find the lead. When asked if they know Paris Gulachoz, the owners of one of the stalls will point to a small shop in a building across the way and say that it

GETTING INTO ROMANIA

The characters will discover, when they go through Romanian customs, that there are disadvantages to being American. Their fake Militech passports will hold up to inspection, as will the sealed Corporate Proprietary Package (the corporate version of a diplomatic pouch) containing their weapons. They will, however, be sneered at, and perhaps subtly berated by the Romanian customs police. Americans aren't too popular in Europe. The only way the characters will actually be discovered on entry is if they blow it themselves. If that happens, its going to be a scramble to get out of the airport in one piece. Hint to the referee: feature the anti-American sentiment in your role-play!

COPS (COPS)

These are the Timisoara Police. Many are corrupt, and they have no love of Americans. If they capture the characters, they will make life very rough for them.

Stats: INT 8, REF 8, TECH 5, COOL 7, ATTR 6, LUCK 6, MA 8, BODY 9, EMP 6/5, SAVE 9, BTM -3.

Skills: Authority 5, Interrogation 3, Intimidate 4, Persuasion and Fast Talk 3, Streetwise 3, Awareness/Notice 4, Shadow/Track 4, Brawling 5, Dodge and Escape 1, Driving 2, Handgun 3, Rifle 2, Submachinegun 2, Melee 3.

Cyberware: Basic Processors, Chipware Sockets.

Gear: SP 20 armored vests, night-sticks, radios, cars (one per pair of officers), knives, cuffs, flashlights, Sternmeyer Type 35 pistols with three magazines each, Sternmeyer Stakeout 10 shotguns with 40 rounds (1 per car).

PARIS GULACHUZ' SHOP

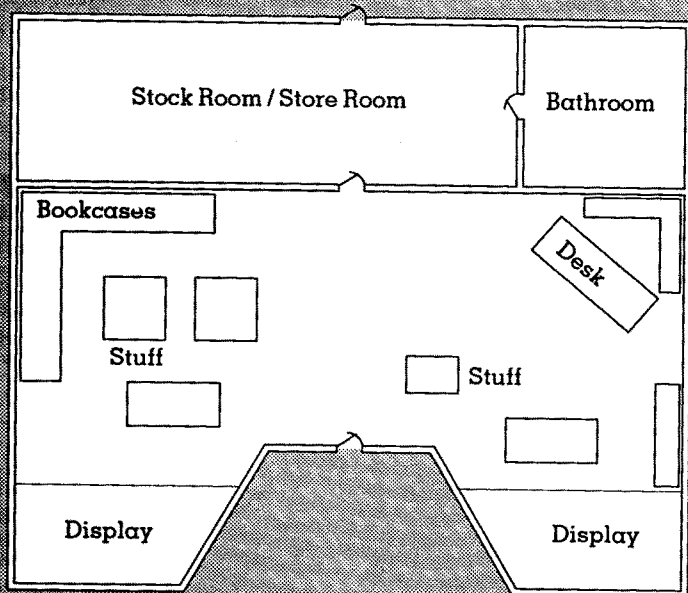

belongs to the Gulachoz family. Unfortunately, the shop is closed and there is no one present. A painted sign over the door says simply "Rare Books and Antiques." A smaller sign on the window says "Specializing in Gypsy Artifacts." A note on the door says: "Closed due to a death in the family." If the characters question the merchants next door or any of the owners of the stalls out front, they will discover that the store has been closed for about five days. Paris Gulachoz normally runs the store, but no one has seen him since it closed. His son, Andres, was in once, but that was three days ago. Nobody has heard anything since. None of the neighbors know the Gulachoz' home address.

With no other solution in sight it will be time for drastic action. If none of the player characters suggests it, Wolf will propose that they break into the shop that night and try to find some document with the owner's home address. If the characters are in agreement, Wolf will set the target time as two am.

BREAKING INTO THE SHOP

At two am the market will be nearly deserted. There are a few people strolling along the canal banks. Most of them look to be kids out on night-time prowls. Occasionally, a car will drive through. All of the stores and stalls are shut. Breaking into the shop without alerting anyone will require an **Electronic Security roll over 20** and a **Pick Lock roll over 20**. If the Electronic Security roll fails, a loud bell will start ringing. If that happens, the police will arrive in 1D10 minutes and 1D6 spectators will gather across the street. If the Pick Lock roll fails, the characters will have to break a window. There is a 20% chance someone will be alerted and call the police. If that happens, the police will arrive without warning 1D10 minutes later.

If the characters successfully break into the store without alerting anyone, they will be able to search for the information they need with little chance of disturbance. (10% chance they are interrupted.) An **INT roll over 15** will reveal a business license with Paris Gulachoz' home address on it. It is, indeed, only a few blocks away. Wolf will suggest they pay a visit during daylight hours. In the course of the searching, anyone who makes an **Awareness/Notice roll over 22** will find traces of dried blood on the floor.

ANDRES GULACHOZ

If the characters call on the Gulachoz residence the following morning, the door will be answered by a very somber-looking, old gypsy woman. When the characters ask for Paris Gulachoz, the woman will retreat into the shadows of the apartment and then return with a swarthy man who looks to be about thirty years old. He will ask why the characters are looking for Paris Gulachoz. If the characters explain that they are investigating the disappearance of Franz Reimann, Andres will invite them in. If the characters offer no explanation or are evasive, Andres will let them stand in the hall. Either way, the characters will hear this: "My father is dead. He was murdered in the shop last week."

Once Andres knows that the characters are connected with Franz Reimann he will invite them in, introduce himself properly, and relate the following details. "I remember Mr. Reimann. He stayed here for two days, meeting my father when he came into our store on the Canal. He was very interested in local lore and history, particularly Vlad Tepes (see sidebar). My father took Mr. Reimann out to some ruins in the countryside and left him there. He was to pick him up two days later. But when father went back, he said all sign of Mr. Reimann was gone, including his tent and supplies. My father thought that Mr. Reimann had hiked back to the main road and hitched a ride to Arad, the next nearest city.

"We thought no more of the matter until father was found murdered in our store. He had stayed late one night, as he often did.

VLAD TEPES THE IMPALER, TYRANT OF WALACHIA.

Vlad Tepes ruled the area of Romania known as Walachia from 1456 to 1462. One of his palaces was near Timisoara, near the border of Walachia and Transylvania. During his reign, Vlad was responsible for the execution of tens of thousands of people. His favored method was to impale people on wooden stakes, along the long axis of the body. Despite his cruelty, Vlad Tepes is revered as a national hero in parts of Romania, where he is considered to have been an effective ruler, and one of the most brilliant military leaders the nation ever produced. Vlad was also known as Dracula, "Son of the Dragon." It is from him that the legend of Count Dracula is drawn. There is an undercurrent of resentment in Romania that one of their revered historical figures was turned into a movie monster by Americans. Vlad was beheaded in 1476 by Hungarian troops. His body was buried in a distant monastery. His head was never found.

But when he did not appear by the next morning, I grew worried and went to the shop. I found his body impaled on a wooden stake, transfixed from belly to head."

"The police think it was a local gang, but I am not so sure. You see, the ruined monastery where my father took Mr. Reimann is rumored to be the final resting place of the head of Vlad Tepes, the Impaler. I told the police this, but they laughed. They do not believe the stories that even today, strange things happen at that monastery. But I can not forget that wooden stake. I went back to the store once after the police were finished. I have not been able to bring myself to return."

At this point, the characters should attempt **Education and General Knowledge** rolls over 16. Anyone who succeeds

will know the information in the sidebar. If none of the characters succeed, Andres will fill in the gaps.

**"THE SPIRIT OF VLAD
TEPES LIVES ON IN THIS
LAND. IF IT IS EVER AWAK-
ENED, DARK TIMES MAY
FALL UPON OUR COUNTRY."
- ANDRES GULACHOZ**

About this time, the players should begin putting the pieces together. Fact: Franz Reimann disappeared while at the monastery where the lost head of Vlad the Impaler is reputed to be. Fact: Paris Gulachoz was murdered in the manner Vlad the

ANDRES GULACHOZ (FIKER)

Stats: INT 9, REF 7, TECH 3, COOL 7, ATTR 8, LUCK 7, MA 9, BODY 7, EMP 9, SAVE 7, BTM -2.

Skills: Streetdeal 3, Streetwise 2, Awareness/Notice 3, Education and General Knowledge 5, Expert: Romanian History/Lore 6, Expert: Antiques 5, Hide/Evade 2, Wilderness Survival 3, Brawling 1, Melee 1, Driving 3, Handgun 1, Rifle 4.

Cyberware: None.

Gear: Knife.



Impaler is known for. Fact: There are rumors, even in the twenty-first century, of strange goings on at the monastery. The next step should be clear to the characters. If it isn't, it will be clear to Wolf. They must go to the monastery. If none of the characters makes the suggestion, Wolf will. Andres, who longs for justice for his father, will offer to guide them. As it is still morning, and the monastery is a day's drive away, Wolf will suggest that the team leave at once. Mrs. Gulachoz will provide some supplies. Andres has a van that the team can use.

PART THREE: THE ZARAND MOUNTAINS

On the drive, Andres will tell the team a little about the monastery and its history. The monastery that the players are bound for is nestled in the Zarand Mountains, foothills of the dark Carpathians. Once the home of the secretive, cloistered Order of St. George, the monastery was founded in 1550. According to one of Paris Gulachoz' ancient volumes, eight of the monks left the monastery in the 17th century, when the Ottomans were marching on Vienna. Only two returned, but they brought with them a jeweled casket the size of a man's head. It is said that the casket contained the head of Vlad Tepes, lost since 1476. The monks planned to reunite the head with the body, but it never happened. A plague swept the town and the monastery in the late 1700s, wiping out nearly everyone. All of the monks died, and the town was abandoned. Both the monastery and the village have been in ruins ever since. To this day, residents of the nearby villages keep away from the area. As far as anyone knows, the head of Vlad Tepes is still there, waiting to be reinterred with its body. Of course, much of this is legend and hearsay.

**"I AM NOT CONCERNED WITH THE HISTORY OF MEDIEVAL MADMEN, I AM CONCERNED FOR MY BROTHER. IF THE SPIRIT OF VLAD HAS RISEN, THEN I WILL SEND HIM BACK TO HELL."
- WOLF REIMANN**

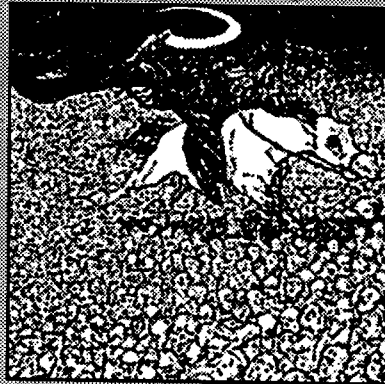

THINGS THAT GO BUMP IN THE NIGHT

There are rumors surrounding the mysterious area to which the characters are journeying. The characters may have encountered some in Timisoara, or Andres may mention a couple.

- ✦ People have been disappearing in the mountains between Timisoara and Arad.
- ✦ In some of the local villages, babies have been spirited away in the dead of night.
- ✦ People have sighted werewolves. Many claim the sightings are the delusions of madmen and drunkards. Some take them seriously.
- ✦ Spirits walk the Zarand woods. Strange lights and sounds have been seen and heard at night by villagers and people driving the roads through the Zarand mountains.
- ✦ It's a load of superstitious claptrap. This is the 21st century. It's probably the army testing equipment in the mountains. Maybe a corporation.
- ✦ Impaled corpses have been found in the area, transfixed in the manner of Vlad Tepes.

As the characters climb into the Zarand Mountains, the isolated road will get worse and worse. Eventually, Andres' aging van will be able to go no further. Andres will explain that it is a brief walk through the woods to the abandoned village. Wolf will suggest that they hike to the village and camp there for the night. The ruins should offer shelter and good defenses, and he's not superstitious. He also wants to check out his brother's campsite and hit the monastery first thing in the morning.

THE VILLAGE

The characters will reach the village after about half an hour of walking. It is almost dark, but there is still enough light to see things clearly. The outlying area is mainly houses and barns. At the center there are larger buildings grouped around a town square. Many of the stone buildings are intact except for roofs and wood trimmings. The remains of furniture are visible in several. One building in particular stands out. It is a small chapel, behind which is an overgrown graveyard. Up on a hill, about a kilometer away, the ruins of the once majestic monastery are visible.

Andres will point out the place where his father said Franz camped. The plot is directly in front of the ruins of the chapel. An inspection will reveal that the weeds have been flattened out, and that there are holes where tent pegs once were. There are also the remains of a fire. Nothing else is immediately visible. Anyone who makes a **Shadow/Track** roll over 20 will, however, notice that there are multiple sets of footprints in the area. One set looks like hiking boots. The rest appear to be deformed human feet; human shaped, but too long and with claws on the ends of the toes. The prints disappear as soon as they leave the town square. After that, it will be too dark for any other investigations. Wolf will suggest that they make camp and bed down for the night.

THE NIGHT

The characters would be well advised to set up a watch. Also, anyone who makes an **INT** roll over 16 will consider this: Franz Reimann built a fire. That may have attracted attention. Perhaps the characters should avoid light and noise. (The characters could arrive at this decision on their own. If you would prefer to make things rough on the characters, don't even

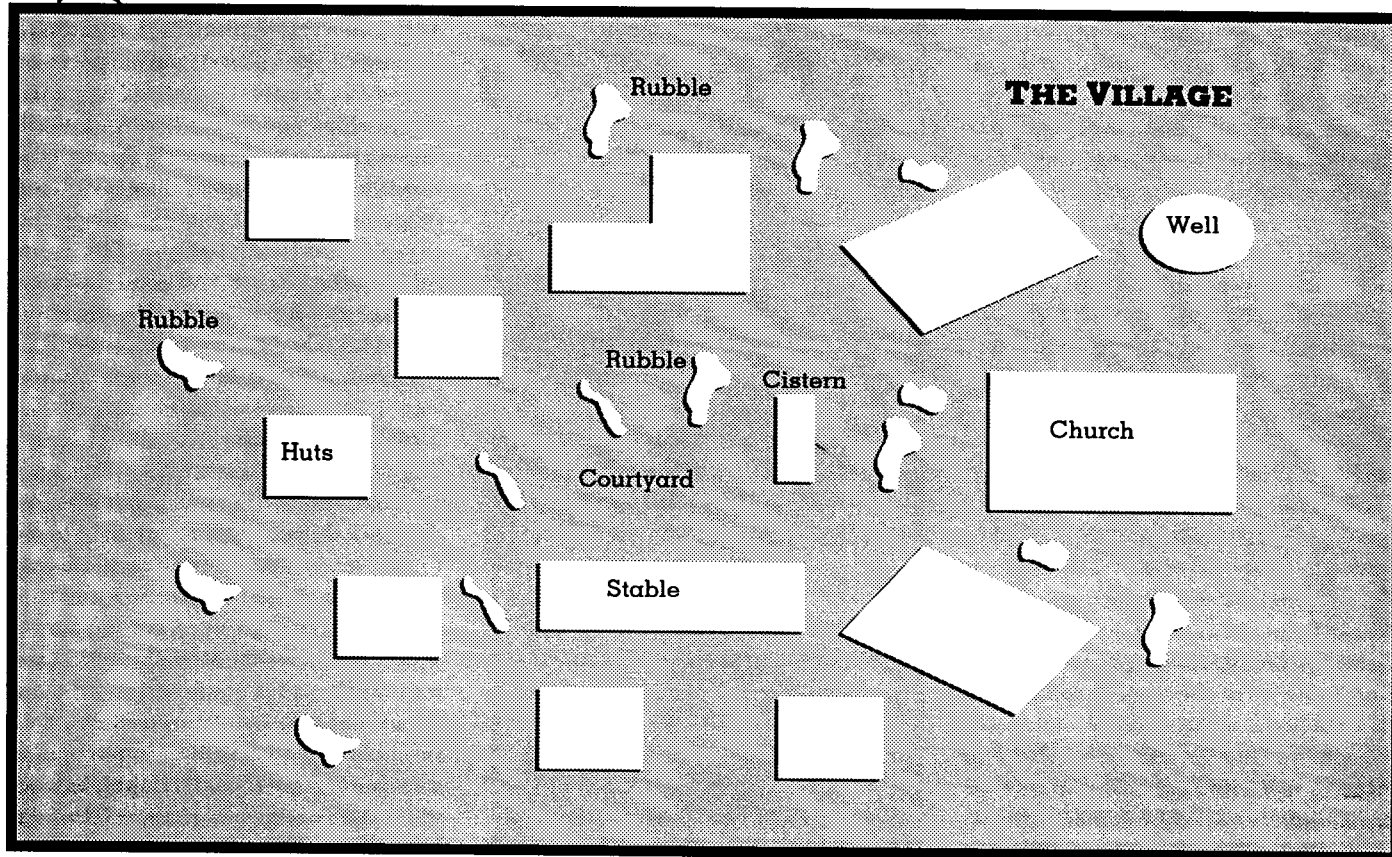

give them the roll. Let them come up with it themselves, or suffer the consequences.)

If the characters don't attract attention to themselves: Most of the night will pass peacefully. It is, however, very dark in the abandoned village. Especially since the characters have built no fire. The misty, Romanian woods are filled with strange noises: crashings, barkings, even the occasional howl. Every player trying to sleep will have to make a **COOL** roll over 15. A failed roll means an hour of insomnia, then another roll. Another failed roll, another hour of sleeplessness. Every character that takes a watch during the night will have to make a **COOL** roll over 15 to avoid waking the others over some trivial noise. Failed **COOL** rolls may also mean that the characters on watch fire their weapons at shadows, blowing their cover of silence. (They could *swear* they saw something!)

If no wolves appear (see sidebar), the night will be uneventful until about two AM. At that point, whoever is on watch will have to make an **Awareness/Notice** roll over 15. Success means that the person sees strange, flickering lights up in the ruins of the monastery. A look through binoculars will reveal that the light appears to be fire-

GET CREEPY

During this section, the referee should play up the atmosphere as much as possible. Do your best to scare the characters and entertain the players. Put on creepy music. Dim the lights in the room. And remind the players that *their characters will be nervous and jumpy*. These are American cyberpunks used to city streets. They are camped in a foreign wilderness 7000 miles from home, surrounded by the lands that gave birth to the legends of werewolves and vampires. Lots of **COOL** and **Awareness/Notice** rolls for everyone, especially to avoid discharging their weapons in a panic at a random squirrel or deer.

light reflected from damp, stone walls. There are no unusual sounds.

If the Characters Attract Attention to Themselves: Things will work out a little differently. A half-hour after the characters do whatever it is that gives them away, they will get a visit from an unusual group of people: four werewolves. Whoever is on watch will have to make an **Awareness** roll vs. the werewolves' **Stealth** to see or hear them coming. They don't look like Lon Chaney in makeup. The wolf men are human sized, and have vaguely human limbs and extremities, but they are distorted. The arms and legs are too long, and the creatures hop rather than run, using

their rear legs to spring and their arms to land. They are entirely covered in hair, but it is thin and wispy, revealing pink, human skin beneath. There are claws on the ends of their fingers and toes. The faces look like they were once human, and they still have human brows and eyes, but the noses and jaws have been stretched into a fanged, canine snout, and the ears are long and pointed. Belying the Hollywood werewolf myth, there is no hair on their heads except the same wispy strands that cover the rest of their bodies.

If the wolf men are vanquished, the characters may make an examination of the bodies. The creatures are real—not

WOLVES!

Werewolves and vampires may be the stuff of legend, but *Canis lupus*, the wolf, is very real indeed. Once the wolf had nearly vanished from the Carpathian foothills. Now, with the collapse of many industrial areas, they have returned. It is possible (referee's discretion) that a pack of three or four wolves could come sniffing around the characters' camp during the night. The characters will be hard pressed to deal with the animals without blowing their cover of silence. If wolves appear, there is only a 50% chance (or referee's discretion) that they will actually attack the character on watch. If they do, the character won't hear them coming unless he or she makes an Awareness/Notice roll vs. the wolves' Stealth. The wolves will retreat if two of their numbers are killed, there is any gunfire, or the referee decides the characters have been rattled enough. Characters beware, gunfire could alert other undesirables!

Wolves

Skills apply to things a dog might notice/see/act on.

Stats: INT 2, REF 10, COOL 4, LUCK 5, MA 10, BODY 7, SAVE 7, BTM -2.

Skills: Endurance 4, Awareness/Notice 5, Hide/Evade 5, Shadow/Track 5, Bite/Claw 4, Dodge and Escape 4, Stealth 5.

Specialties: Bite: 2D6. Claw: 1D6. Perfect night vision. +5 to hearing/smell perception rolls.

A TYPICAL UNDESIRABLE ELEMENT



WOLF MEN

These are genetic constructs, grown entirely in vitro and of limited intelligence only. They do not transform. Their orders are to kill the characters or frighten them off.

Stats: INT 4, REF 10, TECH 1, COOL 6, ATTR 1, LUCK 4, MA 10, BODY 10, EMP 2, SAVE 10, BTM -4.

Skills: Endurance 3, Awareness/Notice 4, Hide/Evade 3, Romanian Language 1 (basic commands), Shadow/Track 3, Wilderness Survival 2, Athletics 4, Brawling 3, Dodge and Escape 3, Stealth 4.

Specialties: Same as real wolves (see previous sidebar).

men in makeup. Anyone who makes an **INT roll over 18** with Medtech, Expert in Physiology, Biology, Biochem, Biotech or Genetic Engineering will recognize the creatures as artificial genetic constructs. The wolf men are all wearing studded collars. Close inspection will reveal that the collars have electronic devices in them. An **Electronics roll over 15** will reveal that the devices are radio trackers and shock collars. Once the wolf men have been defeated, the characters may notice the firelight at the monastery.

PART FOUR: THE MONASTERY

Since the characters have seen the flickering lights in the monastery or fought off the wolf men, they will realize that the further investigation is warranted. Wolf (Reimann) no longer wants to wait until morning. He wants to know what is going on *now*. He will propose that the characters sneak up to the ruins and take a look around.

people dressed in long cloaks, not wolf men. The guards are walking in circles around the ruins, always on opposite sides of the monastery. The characters will need to dispose of them to get into the ruins. Wolf will suggest that they try to do it silently, in order to avoid alerting anyone inside.

**“WAIT HERE IF YOU
WANT; I AM GOING NOW.
WEREWOLVES ARE NOT THE
ONLY CREATURES WHO CAN
HUNT BY NIGHT.”
– WOLF REIMANN**

INSIDE THE RUINS

If the characters make it past the perimeter guards, they will get a clearer look at the ruins, and what is going on inside. The monastery was a four story building, built in a ring around a large courtyard. The inner and outer walls are of stone, and have survived the centuries of neglect.

Once the characters have navigated their way to the inner wall, they will get a clear view of the courtyard. What they will see is a large, open space floored with cobblestones. At one end is a shrine, before which are seated five men in elegant robes and hoods. One man in a particularly ornate outfit is standing at a pulpit, leading a chant. He is holding a jeweled casket the size of a man's head. Seated in wooden pews facing the shrine are about fifty more men in robes. They are echoing the chanting of the man at the shrine. Behind the pews, in a large, open clearing, is an Osprey with EBM markings. Standing next to it is a man in a suit, a pilot and two EBM soldiers. They are all watching the ceremony with some interest. The only people who appear to be armed are the EBM soldiers. The entire affair is lit by torches; the source of the flickering light the characters saw. There are four floodlights under the Osprey, but they are off. Since the characters didn't see the aircraft land, it stands to reason that it has been there for a couple of days.

Two things in the scene stand out. The first is an enormous portrait hanging behind the shrine. Anyone making an **Education and General Knowledge roll over 20** will recognize it as a picture of Vlad Tepes, the Impaler. The second is a large, stone table, to the left of the shrine. On the table lies a bound Franz Reimann. There are two men in robes standing by the tablet. One is holding a large, wooden stake over Franz's body. The other is holding an iron mallet. They are not yet poised to strike, but it looks like it will not be more than a few seconds. The chanting is growing to a fever pitch.

Note: If the characters have not yet faced the wolf men, the creatures will be on the right side of the altar. They have been leashed with chains, and are being held by another robed man.

If the Characters Act: The only armed men are the two EBM soldiers and the EBM corp. They will fight back. The chanting will stop, and the robed men will dive for cover behind the pews or the shrine. If the wolf men are present, they will be released, and ordered to attack the characters. While the fighting is going on, the Corp and the pilot will duck inside the Osprey and try to start it up. Wolf will yell that he wants the Corp taken alive. The robed men are unarmed, and

GUARDS (SOLOS)

These are the cloaked men guarding the perimeter of the ruins. They will be expecting trouble only if they have heard gunshots from the abandoned village. These stats can also be used for the cultists inside the monastery.

Stats: INT 7, REF 9, TECH 4, COOL 9, ATTR 7, LUCK 5, MA 8, BODY 9, EMP 7/4, SAVE 9, BTM -3.

Skills: Combat Sense 3, Intimidate 3, Awareness/Notice 3, Hide/Evade 2, Expert: Romanian History and Lore 4, Romanian Language (Native), Brawling 5, Melee 3, Handgun 3, Rifle 2, Submachinegun 2, Stealth 4.

Cyberware: Basic Processors, Chipware Sockets, Basic Cyberoptic, Low-Lite™, Times Square Marquee.

Gear: Knives, Militech Avenger 9mm pistols, Monoswords.

It is an hour's hike up to the monastery, so it will still be dark when the characters get there. As the characters get closer, the flickering firelight will get clearer, and they will hear chanting from inside. If the characters make an **Awareness/Notice roll over 15** they will see 2 pairs of guards strolling around the perimeter of the ruins. They are regular

Some of the floors are intact, but some have given way. There are the remains of wooden doors and furniture scattered around. Characters climbing through the decrepit structure must make **Awareness/Notice rolls over 17** to spot treacherous areas and **REF rolls over 14** to negotiate them. A failed roll may mean a nasty fall on the slippery stone, and noise.

THE MEN FROM EBM SOLDIERS AND PILOT (SOLOS)

Stats: INT 8, REF 9, TECH 5, COOL 8, ATTR 8, LUCK 5, MA 9, BODY 8, EMP 8/6, SAVE 8, BTM -3.

Skills: Combat Sense 3, Intimidate 1, Awareness/Notice 3, Hide/Evade 2, Athletics 2, Karate 3, Dodge and Escape 3, Melee 3, Handgun 4, Rifle 4, Submachinegun 3, Stealth 2, Driving 4, Pilot Fixed Wing 6 (Pilot only).

Cyberware: Basic Processors, Chipware Sockets, Interface Plugs, Smartgun Links, Basic Cyberoptic, Targeting Sights, Low-Lite™.

Gear: (Soldiers) SP 18 armor vests, Sternmeyer Type 35 pistols with three magazines each, knives, H&K MPK-9 submachineguns with

four magazines each. Pilot only has pistol and vest.

LEIF BERGSTROM (CORP)

Stats: INT 9, REF 7, TECH 5, COOL 9, ATTR 9, LUCK 3, MA 7, BODY 8, EMP 7, SAVE 8, BTM -3.

Skills: Resources 5, Personal Grooming 3, Wardrobe and Style 3, Leadership 2, Persuasion and Fast Talk 5, Awareness/Notice 2, Hide/Evade 1, German (Native), English 6, Romanian (Chipped), Pistol 2, Melee 1, Brawling 1.

Cyberware: None.

Gear: Sternmeyer Type 35 pistol, SP 10 armor T-shirt.

attack only if offered easy opportunities. Most will try to escape into the surrounding woods during the fighting, doing their best to make sure that the small casket goes with them.

If the Characters Wait: Wolf is not going to stand around and watch his brother impaled. He will act. He will charge into the fray. The characters will have little choice but to act, or watch him and his brother killed.

PART FIVE: POSSIBLE OUTCOMES

Once Wolf has rescued his brother, his primary goal will be to capture the Corp and the Osprey intact. He would also like to get one of the men at the altar alive, but that may not be possible. Andres wants the casket, but the hooded man who was at the pulpit will do his best to escape with it.

The Bad Guys Escape, the Characters Save Franz: The characters will have recovered Wolf's brother, and Wolf will be satisfied. The Osprey has taken off and the hooded men have fled into the woods. There is the sound of vehicles starting up on the far side of the hill on which the monastery sits.

Franz will explain that he stumbled onto the gathering quite by accident when he saw the Osprey land and went up to investigate. The cult seems to be com-

posed of many powerful Romanian men, dedicated to preserving the legacy of Vlad the Impaler and using him as the symbol for a coup and the formation of a new, dictatorial government in Romania. EBM's connection is unclear. The guards must have seen Franz and figured out where his camp was, because they sent the artificial wolf men to abduct him and bring him back to the monastery. He thinks that the cult was going to sacrifice him to the spirit of Vlad the Impaler. The characters will encounter no resistance as they flee the ruins and return to Timisoara, but a large part of the mystery will have gone unsolved.

The Bad Guys Escape, Franz Dies: The characters have failed. Wolf will be despondent. He will swear to stay in Romania until he catches the people who did this. The characters will know nothing about the cult other than what they can learn by what they have observed. Wolf will have the characters flown back to the States, unless they want to stay and help him crack the cult.

The Corp is Captured: He will crack if the characters successfully make an **Interrogation roll vs. his COOL roll**. His name is Leif Bergstrom. He is a representative of EBM. EBM is backing the Vlad cult's gamble for power in return for enormous industrial concessions in the "new" Romania. EBM provided the genetically engi-

neered wolf men to help the cultists keep the surrounding area free from meddlers, and have been funneling money into the secret society. The society's members include some of the most powerful military men, industrialists and politicians in Romania, but Bergstrom doesn't know their identities.

If Bergstrom is captured, he will make the characters a proposal. It turns out that he knows Wolf Reimann, and was part of the team that engineered his professional demise. Bergstrom says that the situation in Romania doesn't involve the characters. They have rescued Franz Reimann, and they are welcome to take him. But this operation is worth billions to EBM. Bergstrom will offer to clear Wolf's name if characters will keep their mouths shut about the operation and turn over any evidence they have seized. Bergstrom's offer is sincere, and he is willing to back it up, but the characters will have a moral dilemma. Clear their friend, or stop the cult. Wolf will tell the characters that they must decide. There should be some good role-play between the characters and Franz, who is especially torn between his loyalty to his brother and his duty to Interpol's fourth directorate.

The Characters Capture the Casket: Inside they will find a sealed glass container containing an embalmed human head. The features are unrecognizable. If

THE RUINS OF THE MONASTERY

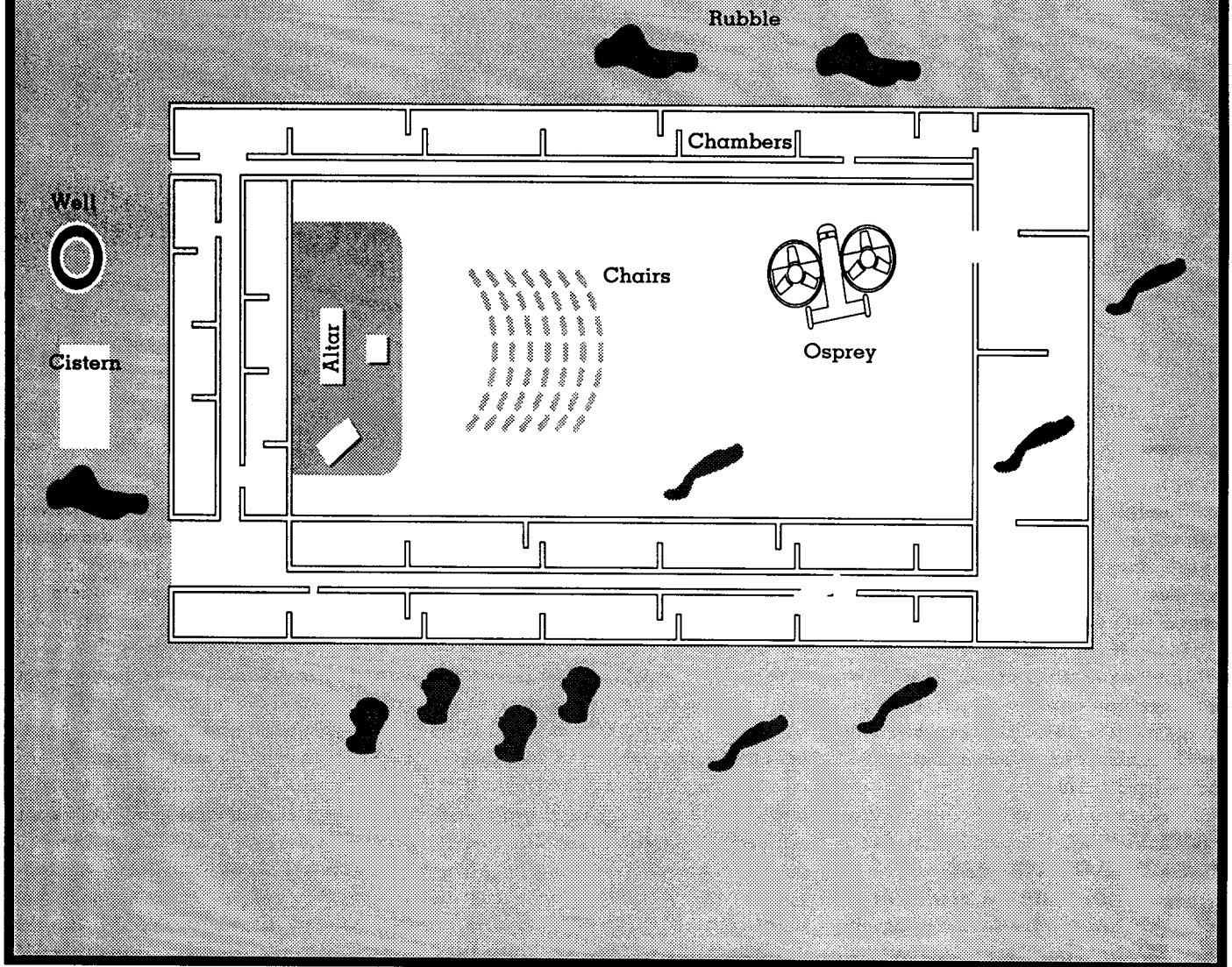

Andres is still alive, he will tell the characters that he will take the head and see that it is placed somewhere safe, where it can not be used as a symbol. He is sincere. If the characters take it back to the States and have it tested, it will prove to be from the right century. Proving the identity is, however, impossible . . .

One of the Head Cultists is Captured: He will crack under an **Interrogation** roll over his **COOL** roll. He will reveal much of the same information that the Corp did. Franz Reimann was captured because he was too close to the monastery. He will also say that Paris Gulachoz was followed back to the city and murdered as a warning.

Apparently it didn't work. They then decided to use Franz as a sacrifice. The captured man is a Bucharest politician known for his anti-government stance.

CONCLUSION: BACK IN THE USA

The characters should return to the U.S. within a couple days of completing the operation. If they have rescued Franz Reimann, then Wolf will be with them. If not, Wolf will still be in Romania, fighting his solitary battle of revenge. If the characters were successful their stock at the Forlorn Hope will go through the roof. And they'll really have some good stories to tell.

OPTIONAL EPISODES

- ✦ The characters stay in Romania and help Wolf crack the cult and/or avenge his brother.
- ✦ The characters bring the severed head back for testing, only to have cultists trail them back to the USA and attempt to recapture it.
- ✦ The characters renege on their deal with Leif Bergstrom, initiating a war between themselves and EBM and causing EBM to retract its exoneration of Wolf Reimann. (Not an advised course of action.) ★

TALES FROM THE FORLORN HOPE #4

In this adventure, the characters accompany Roxxi and Kissy on an extraction that goes awry. The characters will end up with the wrong guy. This will lead to all sorts of chaos as they are pursued by the Yakuza and one of the Night City Tongs.

The adventure can be run with any combination of characters. No special skills are required, but it will be combat-heavy. Steel nerves and a high tolerance for stress will help, as the characters deal with the dual task of saving their skins and preventing Roxxi and Kissy from blowing up everything in sight. The referee should make sure to play Roxxi and Kissy properly. Their solution for almost everything is to detonate it. Run it so that the players have to be the restraining influence on the girls.

PART ONE: DRAFTED

As the characters are walking into the Forlorn Hope one evening they will be accosted by Roxxi and Kissy, the two bubbly, inseparable street samurai. There won't even be time for our heroes to grab a drink as they are herded outside by the energetic women and presented with a proposal. Not a *proposition*, a proposal. And not *that* kind of proposal, either. Get your mind out of the gutter.

The gist of the situation is this: Roxxi and Kissy have been contracted by a certain Li K'o-yung. Li is a lieutenant for the boss of the Golden Lotus, one of Night City's Little China Tongs. It seems that Li has been skimming his boss' coffers for some time. Now he's in trouble, however. The accountant for the Golden Lotus' parent Triad, a Korean man by the name of Kang Ho Jun, has just flown into town. Li is certain that Kang is here to audit the Tong's books. When that happens, Li's duplicity



GIRLS' NIGHT OUT

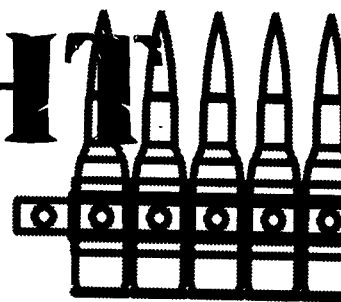

will be discovered, and his life won't be worth a bowl of greasy Chow fun. Li has hired Roxxi and Kissy to extract Kang from the hotel and sit on him for about twelve hours. Then they can release him. By that time, Li will have fled Night City with his ill-gotten booty.

Roxxi and Kissy have contracted for 5000eb, half up front and half when they show Li that they have captured Kang Ho Jun. They are going to enter the hotel and do all the dirty work. All they want the characters to do is drive the van they're using as their get-away vehicle, and provide backup if necessary. It should be no more than a couple of hours' work. They are willing to pay the characters 500eb apiece for the job. It sounds like easy money.

Of course, it never turns out that way.

**"A TRIBE OF HUNKS
LIKE YOU SHOULDN'T BE
WORRIED ABOUT A JOB
THAT TWO SWEET LITTLE
GIRLS LIKE US CAN DO."
- ROXXI**

EVERYTHING A YOUNG GIRL NEEDS

If the characters agree, Roxxi and Kissy will lead them to a van parked outside. The van is Roxxi and Kissy's personal traveling armory, and it is very impressive indeed. Racks in the passenger compartment store two Arasaka WAA assault rifles (RIF+1 N C 5D6(5.56mm) 30 30 VR 400m), Two Arasaka WMA Minami submachineguns, two Arasaka WSA pistols (P O J C 2D6+3(10mm) 15 2 VR 50m), A Barrett Arasaka Light 20, an Arasaka Assault Shot 12, a Militech RPG-A with six rounds, four packages of C-6 explosive, detonators and timers, a Militech grenade launcher with mini-grenades (see the sidebar *Cargo of Death* in the adventure *A Hard Road to Go for stats*), and regular smoke, frag and incendiary grenades (ten each). There are hundreds of rounds for all of the small arms, and ten rounds of each type for the grenade launcher. The side panels of the van are armored. The license plate says BIG HUG 4U.

And people wonder where Roxxi and Kissy get their reputation.

ROXXI AND KISSY'S VAN

The van is a Daihatsu Family Cruiser. It is powered by a six cylinder CHOOH2 engine and can comfortably seat eight adults. Roxxi and Kissy have extensively modified theirs, including armored walls, bullet resistant windows, and weapons racks. Use the truck/van line in *Solo of Fortune* or the FNFF control roll modifier table.

Speed: 100mph. Safe Maneuvering Speed: 30mph. Acceleration: ±5mph/phase. Fuel/Range: 20 gallons/450 miles. Equipment: Radio, weapons racks, radar detector. Armor: Tires: SP 15, SDP 20; Windows: SP 10, SDP 15; Engine SP 25, SDP 25; Body: SP 30, SDP 30.

PART TWO: AT THE HOTEL

Roxxi and Kissy will ask the characters to wait outside the van while they change into their mission clothes. This will only take a couple of minutes. Anyone who tries to peek through the windows will get a gun shoved up his nose.

When the back doors of the van open, the characters will be surprised to see that the "mission clothes" appear to be halter tops, incredibly short skirts, garter belts, stockings and high-heeled pumps. The only place where they could be carrying weapons is in their tiny, jeweled handbags. After socking anybody who makes off-color comments, Roxxi and Kissy will explain that they are going into the hotel dressed as call-girls. Their sources say that Kang is expecting a couple of prostitutes at ten o'clock. Roxxi and Kissy plan on showing up at quarter to ten and giving Kang a big surprise. And it's *not* going to be the best sex of his life.

**"HONESTLY, I LOOK LIKE
SUCH A COW IN THIS OUTFIT.
DON'T YOU GUYS THINK
SO? BE HONEST!"
- KISSY**

Kang's hotel is the luxurious Kuroshita, in Night City's downtown corporate center, about a half-hour drive from the Forlorn Hope. When the characters arrive, Roxxi will park the van in an alley around the side, in front of one of the hotel's ground floor fire exits. The only other things visible in the alley are three dumpsters, a closed loading dock, and four sleeping winos. Roxxi will explain the plan to the characters. She and Kissy are going to go

through the lobby and up the elevators to the twentieth floor. There they will plant some small concussion bombs which will activate the floor's sprinklers and fire alarms, and divert security. They will set the timers on the bombs for five minutes, giving them enough time to reach Kang's room on the fifteenth floor. Once the bombs go off, they will hustle Kang down the stairwell, out the fire door, and into the waiting van. Easy as pie.

The characters are to wait in the van and keep it running. They should only interfere if they get a radio message from Roxxi or Kissy asking for help or if the girls aren't back within eight minutes after the diversionary explosion. Kang's room is 1515.

Once everyone is clear on their responsibilities, the girls will head into the hotel. Chances are that everything will go as planned. (If not, see the sidebar.) If things do go as planned, the characters will hear the explosion on the twentieth floor a few minutes after Roxxi and Kissy go into the building. Glass will rain down from shattered windows. Anyone outside the van has a 10% chance of taking 1D6 damage. A few moments after the explosion, people will begin to stream from the fire exits. About five minutes later, as people are still exiting, Roxxi and Kissy will come through the fire exit leading a very confused-looking Korean man. They will push the man into the van, leap in behind him, and yell at the characters to get out of there before the cops show up.

PART THREE: A FEW MINOR PROBLEMS

Once the characters have escaped the scene with Kang they will head for the apartment where they were to rendezvous with Li K'o-yung. Along the way, they will have to deal with a barrage of questions from a confused Kang. Kang is

DROPPING GRAVEL INTO THE GEARBOX

If things seem a little slow, and you want to get your characters in on the action now rather than waiting for the next section, you can complicate things at the hotel.

- ✱ **Roxxi and Kissy are delayed.** The explosion goes off before they get to Kang's room, and Kang evacuates the building with everyone else. Roxxi and Kissy will get on the radio to the characters and tell them to start casing the crowd out front for Kang (everyone will have been shown a photograph beforehand). The problem: the Kuroshita caters to Asian businessmen, and there are hundreds of Japanese and Korean men in the crowd. Spotting Kang will take an **Awareness/Notice roll over 20**. Once the characters have grabbed him, Kang may yell for help, alerting security or police officers.
- ✱ **The police show up.** The police may appear before Roxxi

and Kissy get out of the building. They may block off the alley, or want to talk to the characters. If that happens, the police may be standing right there when Roxxi and Kissy emerge from the building with the kidnapped Kang.

- ✱ **Roxxi and Kissy get into a battle with security.** The diversion may fail. If that happens, Roxxi and Kissy may get into a battle with hotel security officers anywhere between the fifteenth floor and the lobby. They will radio the characters for help, and tell them their location.
- ✱ **The explosion triggers a catastrophe.** The explosion might start a large fire, or trigger a secondary explosion. If that happens, the police may arrive sooner, the van may be damaged by falling debris, Roxxi and Kissy may need help getting Kang out of the building, or the alley may be blocked.

demanding to know why he has been kidnapped and where he is being taken. According to Roxxi and Kissy, the only things that the characters should tell him is that he will not be harmed and they only want him for a few hours.

While the characters are driving to Li's apartment, anyone who is looking out the windows should make an **Awareness/Notice roll over 20**. This may apply only to the driver and front seat passenger. Anyone who succeeds will notice that the van is being shadowed by a sedan. It is impossible to see who is inside the car without binoculars or teleoptics. If either of those is available, the person looking will see five asian men of indeterminate nationality.

If the characters try to lose the car: The driver of the van must roll **Hide/Evade vs. the auto driver's Shadow/Track** (see sidebar for stats).

If the characters confront the car: If the characters stop the van or open fire on the car, it will speed away and re-acquire them a few blocks later. The characters will have to make new Awareness/Notice rolls to see the car. The people in the car will fight only if their vehicle is disabled and the characters attack.

If the characters destroy the car: Another will pick up their tail at Li K'o Yung's apartment, as the Yakuza are in constant communication with their bosses by cellular phone (see below). Roxxi and Kissy may suggest using heavy weapons on the Yakuza car, but that might cause more problems than it solves.

If the characters ignore the car: The car will follow them to Li's apartment, and then appear to keep going.

LI'S APARTMENT

As the characters pull up to Li's apartment they should attempt an **Awareness/Notice roll over 25**. If they succeed, they will notice a car parked in a small lot across the street. In the car are two Asian men eating some take-out food. They will glance at the characters, but appear to pay them no notice. If the characters approach the car, the men will start up the engine and pull away. If confronted, they will demand to know why they are being bothered and ask if the characters are police. The men are

really enforcers (see sidebar) sent by Hsiang Tsun-shi, boss of the Golden Lotus, to see who shows up at Li's apartment. Hsiang wants to find out if Li has any confederates. If the men are forced to leave, they will continue to observe from some other location. They will report everything they see back to Hsiang. They will avoid a fight at all costs.

If the characters get Kang to Li's apartment, they will stumble across more trouble. There is no answer when the characters knock. Li had sworn to be here. He didn't dare leave until he knew his tracks were covered. If the characters try the door, it will be unlocked. In the living room of the apartment they will find Li

COPS/SECURITY MEN (COPS/SOLOS)

Use these if the characters get involved in the extraction. Use however many are appropriate. (Cops may appear again later in the adventure.)

Stats: INT 7, REF 9 to 10, TECH 6, COOL 10, ATTR 7, LUCK 6, MA 8, BODY 9, EMP 7, SAVE 9, BTM -3.

Skills: Authority (Cops only) or Combat Sense (Security only) 4, Intimidate 3, Awareness/Notice 4, Shadow/Track 3, Athletics 2, Karate 4, Dodge and Escape 3, Melee 3, Handgun 4, Rifle 2, Sub-machinegun 2, Driving 4, Stealth 2.

Cyberware: Varies.

Gear: Nightsticks (Cops only), various pistols, handcuffs, flashlights, SP 14 torso armor.



THE YAKUZA (SOLOS)

The people in the car are four Yakuza men who were staying at the hotel. They saw Roxxi and Kissy extract Kang, and figure that the Korean must be a valuable target. They want to steal Kang from the characters and ransom him themselves. The Yakuza men have already contacted their organization in the city and explained their plan. Use these stats for all Yakuza men in this adventure.

Stats: INT 9, REF 10, TECH 6, COOL 10, ATTR 7, LUCK 3, MA 8, BODY 8, EMP 7/5, SAVE 8, BTM -5.

Skills: Combat Sense 4, Wardrobe and Style 3, Interrogation 4, Intimidate 4, Streetwise 3, Awareness/Notice 5, Hide/Evade 4, Japanese (Native), English 5, Shadow/Track 5, Athletics 2, Aikido 5, Melee 4, Fencing 4, Handgun 4, Rifle 3, Submachinegun 4, Driving 5, Stealth 2.

Cyberware: Varies. Most have Basic Processors, Chipware Sockets, Smartgun Links, Interface Plugs, Basic Cyberoptic and Targeting Scopes. Some have Vampires, Rippers, or Cyberlimbs. One or two have Bioware.

Gear: Monoknives, monokatanas, Militech Avenger pistols, clubs, SP 18 armor jackets, lots of tattoos.

K'o-yung. His throat has been slit and a 100eb bill stuffed into the wound. He is very dead.

Although the characters don't know it, Hsiang Tsun-shi discovered Li's crime on his own and ordered the hit. It won't take a great leap of deduction to guess this, however. Now the characters have got the Korean, but their employer is dead.

AND THAT'S NOT ALL...

About this time, Kang will get very agitated and demand to know what's going on. He's rattled by the sight of the dead body, and claims to have no idea what's going on. Anyone who makes an **EMP** or **Human Perception roll over 15** will be able to see that Kang is genuinely upset. In response to Kang's question, Roxxi or Kissy will say to him, "C'mon. Surely a Triad type like you can handle the sight of one dead body." Kang will protest this loudly. "I am not a criminal! I'm a businessman on holiday. I'm in Night City for the World Tae Kwon Do Tourna-

ment. I demand to know what's going on!"

If none of the characters takes the initiative, Roxxi or Kissy will do it. A brief round of questioning and an examination of Kang's wallet will reveal some very interesting facts. Kang is Kang all right, but not Kang Ho Jun. The man they have seized is Kang Hee Jin, Ho Jun's brother, and a legitimate businessman from Korea. Li K'o-yung panicked, hired the girls, and ultimately got himself killed over the wrong guy. Hee Jin is innocent and, as it happens, completely valueless to the players. Incidentally, Hee Jin knows that his brother is a powerful private accountant, but he has no idea that he works for the Triads.

PART FOUR: BIG TROUBLE

If the characters have left a guard outside the apartment, that person will see a car with five men pull up. Out will climb the five Yakuza that have been following the characters (or five

other Yakuza, if those have been disposed of). They are here to try to grab Kang Hee Jin. They will immediately try to silence anyone outside, then go inside and confront the characters. The Tong men will see the Yakuza pull up and they will report it to Hsiang, but they won't intervene.

If the characters get no warning of the Yakuza approach, they will get an **Awareness/Notice roll vs. the Yakuzas' Stealth** to hear them in the hall or foyer. If they fail, the first warning of attack will be when the Yakuza burst into the apartment and demand that the characters turn over Kang. They will not fire at the characters, but they will be ready to.

If the characters fight: The Yakuza will fight back, but they will do everything possible to avoid harming Kang. They will refuse to believe any claims that Kang is valueless. They saw the extraction, and now they find a murdered man. Kang must be important, and their boss has ordered them to take him. Kang will be panicked,

and he will attempt to run. If the Yakuza need to sacrifice some of their number to escape with him, they will. If the Yakuza escape with Kang, the Tong men outside will follow them. If the fight takes more than a couple of minutes, the police may show up and complicate matters.

If the characters hand over Kang: Kang will protest loudly. The Yakuza will flee with him. Kissy knows where this Yakuza clan is based, and she will suggest that they can organize a hit and run raid on the place when they get back to the van and their heavy weapons. The Tong outside will follow the Yakuza. See *Part Six: The Biggest Trouble of All*.

If the characters run: The Yakuza will pursue them and try to stop the characters with gunfire. Kang is not very mobile, and he will hamper any attempt to flee on foot. The Yakuza will not give up until they are dead or immobilized. The Tong will follow any pursuit at a distance, but they will not get involved.

PART FIVE: BIGGER TROUBLE

If the characters defeat the first group of Yakuza, they may begin to feel safe. Unfortunately for them, there won't be much time to breathe. Hsiang Tsun-shi has learned of the abduction of Kang Hee Jin. He has figured out a way to make some points with the Triad back in Hong Kong. Hsiang has no idea that the characters are planning to save Kang from the Yakuza. Hsiang wants to "rescue" Hee Jin, and return him safely to Korea. If he can do that, he will earn the gratitude of Hee Jin's brother, Kang Ho Jun. Ho Jun is a very powerful man in the Triad, and his favor would go well for Hsiang. Hsiang will have his men follow the characters as long as they still have Kang Hee Jin. The Tong men have been ordered to follow the characters until they stop moving long enough for Hsiang Tsun-shi to send a good sized team along to rescue Kang.

While the characters are driving, the people in the front seats should attempt **Awareness/Notice rolls over 22**. If successful, the characters will see the two Tongs following them. The characters can ditch the Tongs if the driver makes a **Hide/Evade roll over the Tongs Shadow/Track roll**. The Tongs will flee rather than fight. Once again, Roxxi and Kissy may favor putting a rocket-propelled grenade through the

windshield. The characters would do well to discourage this.

Whether or not they notice their pursuers, the characters should be trying to figure out what to do next. Since the characters are still technically in Roxxi and

Kissy's employ, the two street samurai are the bosses. (Of course, due to the tack the evening has taken, the characters may be asking for a little more dough for their continued support. There may be some haggling, but at this point, Roxxi and Kissy

KANG HEE JIN (CORP)

He really is in town for the World Tae Kwon Do Tournament.

Stats: INT 10, REF 6, TECH 5, COOL 6, ATTR 7, LUCK 10, MA 7, BODY 7, EMP 9, SAVE 7, BTM -2.

Skills: Resources 2, Social 3, Persuasion and Fast Talk 3, Awareness/Notice 4, Expert International Business 6, Education and General Knowledge 5, Gamble 3, Hide/Evade 1, Korean (Native), Japanese 4, English 5, Brawl 1, Drive 3.

Cyberware: Basic Processor, Chipware Socket, Dataterm Link, Interface Plugs, Basic Cyberoptic, Times Square Marquee.

Gear: None.

THE TONG (SOLOS)

These are the men of the Tong of the Golden Lotus. They are commanded by Hsiang Tsun-shi. Use these stats for all Tong men that appear in the adventure.

Stats: INT 8, REF 10, TECH 5, COOL 10, ATTR 8, LUCK 5, MA 8, BODY 8, EMP 7, SAVE 8, BTM -3.

Skills: Combat Sense 3, Intimidate 3, Streetwise 4, Persuasion and Fast Talk 3, Awareness/Notice 4, Gamble 4, Hide/Evade 3, Chinese (Native) or 5, English (Native) or 4, Shadow/Track 4, Athletics 3, Fencing 2, Choi Li Fut 5, Melee 4, Driving 5, Handgun 4, Rifle 2, Submachinegun 2, Stealth 3, Fencing 2.

Cyberware: Varies. Most have Basic Processors, Chipware Sockets, Interface Plugs, Smartgun Links, Basic Cyberoptic, Targeting Scopes, Low Lite™, Times Square Marquee. Many have Optishields (grafted sunglasses) and Fashionware.

Gear: SP18 armor jackets, clubs, knives, swords, sawed off shotguns, Dai Lung Streetmaster pistols and Uzi Mini-Auto 9 submachineguns.

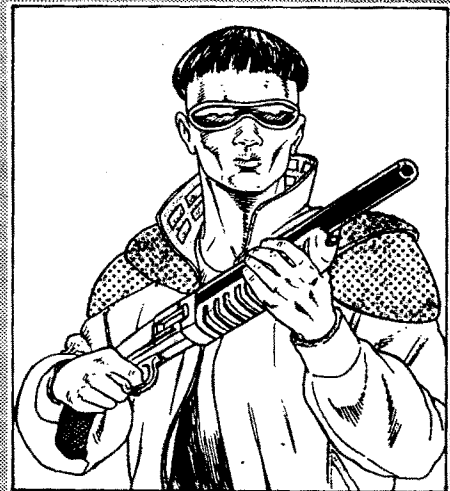

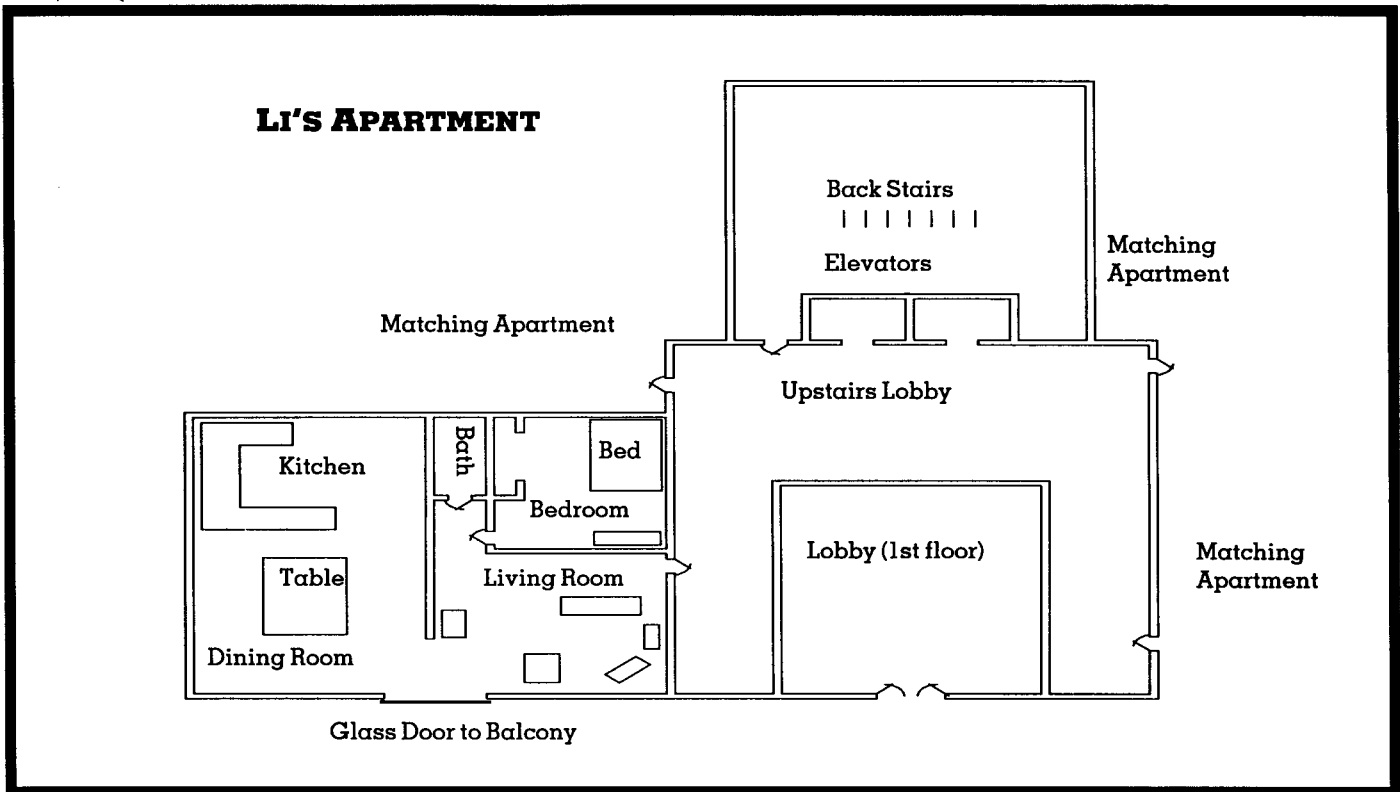

place more importance on having some backup than they do on pinching pennies.) The women will suggest that the characters drive to a nearby bar. From there they can call the Forlorn Hope and ask the Professor or Dollar Bill for some help. The girls are loathe to drive back to the Hope if they are being followed; it's considered poor taste to bring your enemies back there unless necessary. They feel that they'll be relatively secure in a public place downtown, even if they have a tail. Oh well, everyone makes mistakes.

THE ISLANDS

The Islands is a downtown bar where Roxxi and Kissy hang out regularly. As one might guess from the name, it is done in a Hawaiian decor. The music, however, is pure rock and roll. There is quite a crowd of young cyberpunks dancing and drinking the night away. There are some open booths in the back and a payphone off in one corner. Roxxi will plant everyone at the booth, and head back to use the phone.

One drawback to the Islands is that, unbeknownst to Roxxi or Kissy, many of the young men that hang out there are affiliated with the Tongs. Many are not actually members, but hangers-on looking for a way to make points with the bosses. Hsiang will have put the word out on the street for his people

to keep their eyes open for Kang. That means that, even if the characters have shaken the two Tong, Hsiang will find out where they are. He will send a team of six men to try and take Kang Hee Jin from the characters.

"I BROKE A NAIL. I BROKE A NAIL! THOSE GUYS ARE GONNA PAY FOR THAT! TOSS ME A GRENADE."
- KISSY

The team of Tongs will enter while Roxxi is still on the phone. They will come in one at a time and gather at a table across the floor. When all six are in, they will spread out and head towards the characters' table. If the characters make an **Awareness/Notice roll over 20** they will see the Tongs coming. If they fail, the characters will be oblivious until one of the Tongs steps out of the crowd, holding a pistol concealed in his jacket. The Tong will say "Hand over the Korean, and nobody gets hurt. Not even him."

Whether or not the Tongs reach the table, two things are going to happen. A battle is going to break out, and Kang is going to panic. As soon as gunfire or fist-fighting breaks out in the club, a huge

melee will begin to develop. The fight will spread until the characters and the Tongs are only a part of it. Unless one of the characters is holding Kang, or makes an **Awareness/Notice roll over 23**, no one will see him slipping out one of the fire doors. If one of the characters is holding him, they will have to make **BODY rolls vs. Kang's BODY roll** every phase to hold onto the frantic businessman. Once Kang breaks free, he will head for the exit. If any character follows him, they will come through the door just in time to see the Korean being shoved into a car by several Japanese men. The car will scream away at high speed. If the characters don't figure it out on their own, it will only take an **INT roll over 15** to figure that it must have been the Yakuza. Heck, if the Tong could catch up with them again, why not the Yakuza too? That's just the kind of day it's been.

The end result should be that, once the fighting is over and done with, the characters will have no idea where Kang is. They may not have even seen him leave. They should be fairly sure of one thing, however. The Tong doesn't have him. All of the Tong men were involved in the fight. If the characters question people standing around in the street, have them attempt **Streetwise rolls over 20**. A success means that someone will tell the charac-

KICKING AND SCREAMING

The characters may outvote Roxxi and Kissy when it comes to going to the Islands. That's alright. The characters can go anywhere they like, as long as it isn't back to the Forlorn Hope. Freeman will shelter persecuted solos and go to great lengths to help the regulars, but he doesn't want the bar being used as a retreat by every street samurai who has a rough evening. Especially when the hassled solos have no one to blame but themselves.

So what to do if the characters decide to go somewhere other than the Islands? It's a funny thing, but those Tong informants seem to be everywhere. No matter where they go, a Tong enforcer will report the characters' whereabouts to Huang Tsun-shi. Shortly thereafter, the Tong members will show up. The Yakuza will follow the Tongs and, in the course of any ensuing battle, they will try to get their hands on Kang. The plot works out the same. The only thing you'll have to improvise is the new location.

ters that they saw a scared Korean being shoved into a car by a bunch of Japanese guys. The Japanese guys were heavily tattooed, like Yakuza.

Just to add insult to injury, Roxxi will tell the characters that both the Professor and Dollar Bill are indisposed. The Professor said he'd see what he could do, but he couldn't guarantee any help. Of course, it may be too late now anyway. It looks like the characters got themselves into this mess, and they're going to have get themselves out.

PART SIX: THE BIGGEST TROUBLE OF ALL

Once the characters have figured out that the Yakuza have got Kang, there will be only one course of action. Roxxi and Kissy are going to take their van full of heavy weapons and rescue him. Once

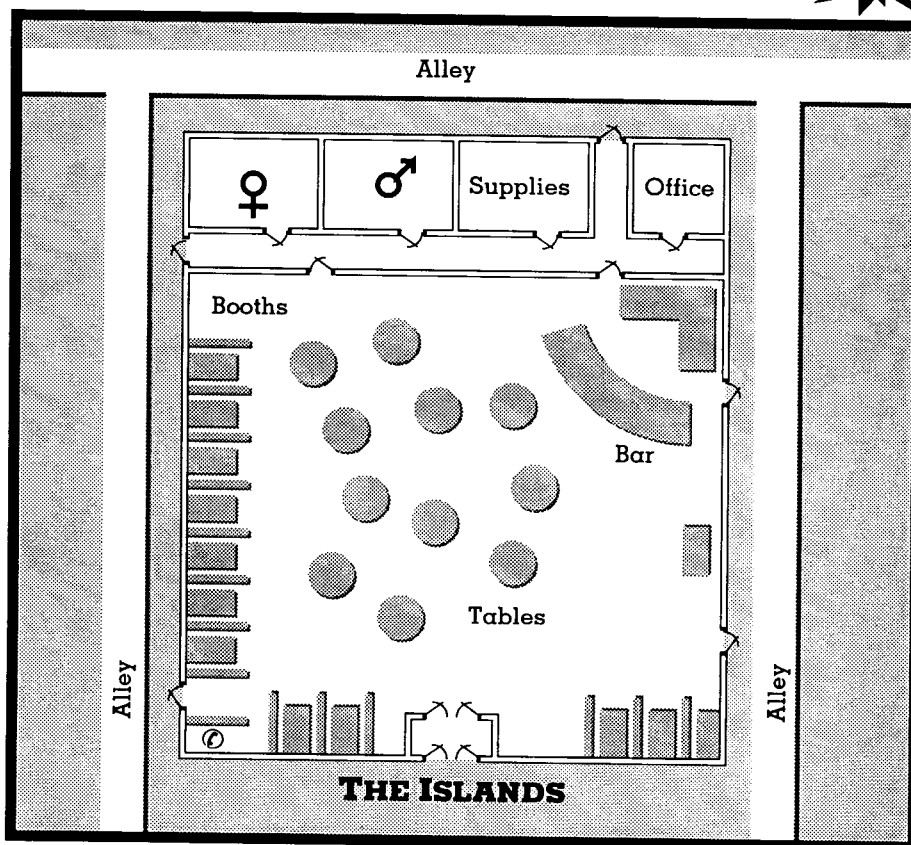

again, they will ask the characters for help. They have no money left to pay the characters any more, but they'd owe the characters a debt. If the characters are reluctant, prod them a bit with a reminder about the philosophy of the patrons of the Forlorn Hope. If word got out that they ignored Roxxi and Kissy's request for help, it might undo some of the hard work they've put into building a reputation for themselves at the Hope. Besides, they have all the weapons they can use. Also, Kissy, who was raised on the mean streets of the City, knows where the members of this Yakuza clan hang out.

THE HOUSE OF THE WINTER DRAGONS

The Yakuza clan in question is called The Winter Dragons. They hang out in a warehouse on the industrial waterfront, not all that far from the Forlorn Hope (see sidebar and map). There, Jigen Kyusho, the local underboss, coordinates the affairs of the Night City arm of the clan. About twenty men hang out at the warehouse at any given time. The warehouse belongs to a Japanese company called Tsuyomi Shipping, and is nominally used for storing steel offloaded from Japanese freighters.

There are two guards in front of the

warehouse. Some foot and vehicle traffic in that neighborhood is normal during the night, so the guards won't be suspicious of anyone unless they are openly carrying weapons or are approaching the warehouse directly. If the characters want to approach the warehouse unobserved, they will have to make **Stealth roles vs. the guards' Awareness/Notice**. See the sidebar in Part Three for Yakuza stats. The guards will have submachineguns in addition to their pistols.

The doors of the warehouse are locked from the inside. If the characters want to go through without raising the alarm, it will take a **Pick Lock roll over 15**. Otherwise, they can go through any way they want. Kang is tied to a chair in one of the upstairs office rooms. There aren't any guards watching over him, but there are about eighteen men scattered around the building. Six are playing cards in one room. A couple may have women with them. The Yakuza are all armed, and will put up quite a fight. Even if the characters can get to Kang without raising the alarm they will have a hard time getting out unobserved.

THINGS GET THICK

Within a few moments after the fighting begins in the warehouse, two vans loaded



with Tongs will pull up. (See sidebar in Part Three for Tong stats.) It seems the Yakuza aren't the only ones with an information net. Hsiang Tsun-shi has also heard that the Winter Dragons have Kang, and he has come along with his men to rescue the Korean. There are about fifteen men from the Tong, including Hsiang Tsun-shi. It won't take long for the whole situation to

dissolve into a free-for-all, with the characters caught in the middle. The innocent Kang Hee Jin is the cause of it all. If the battle lasts very long, two car loads of cops will also show up and add to the confusion.

As amazing as it might seem, it will not be impossible for the characters to get Kang out. When the Yakuza and Tong clash, it won't take long for their focus to shift from

taking Kang to annihilating each other. In the midst of this confusion, the relatively small group of characters should be able to get Kang out. Their main problem will be not getting indiscriminately killed during the battle, or arrested by police. The only other thing that will stand in the characters' way are the two leaders, Hsiang Tsun-shi and Jigen Kyusho. These two men will remember

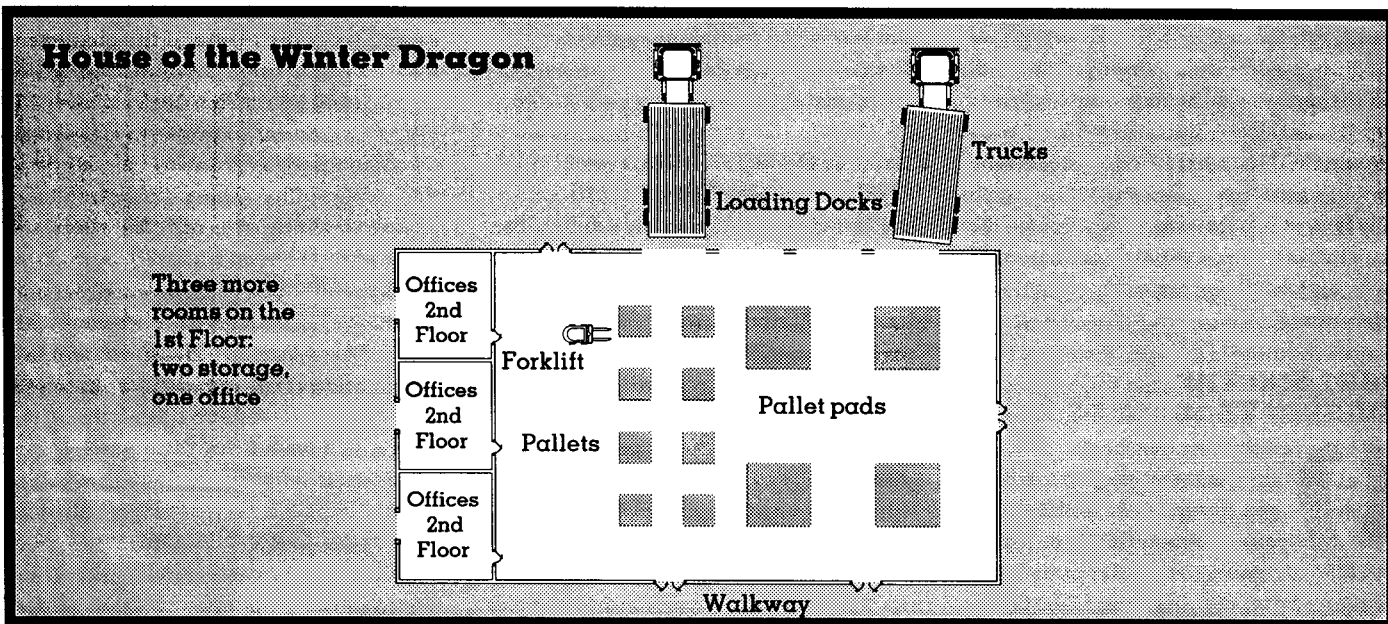



THE GANG LEADERS HSIANG TSUN-SHI (SOLO)

Hsiang is the leader of the Golden Lotus Tong, a branch of the feared Golden Lotus Triad in Hong Kong.

Stats: INT 9, REF 10, TECH 4, COOL 10, ATTR 10, LUCK 1, MA 9, BODY 8, EMP 9/6 SAVE 8, BTM -3.

Skills: Combat Sense 5, Personal Grooming 2, Wardrobe and Style 4, Streetwise 5, Seduction 3, Leadership 2, Persuasion and Fast Talk 3, Intimidation 2, Awareness/Notice 4, Chinese (Mandarin) 8, English (Native), Hide/Evade 2, Athletics 2, Choi Li Fut 5, Fencing 2, Melee 4, Handgun 4, Submachinegun 3, Stealth 4, Motorcycle 4.

Cyberware: Techhair, Basic Processor, Chipware Socket, Smartgun Link, Interface Plugs, Basic Cyberoptic, Infrared, Targeting Sight, Superchrome® Right Cyberarm, Ripperhand.

Gear: SP 18 armored long-coat, Dai Lung Streetmaster with three magazines, Uzi Mini-Auto 9 with two magazines, knife.

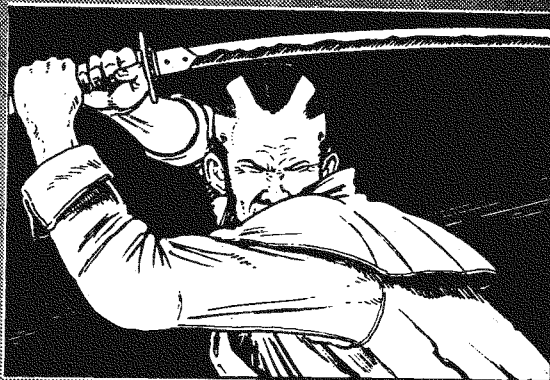

JIGEN KYUSHO (SOLO)

Jigen is the leader of the Winter Dragon Yakuza clan's Night City branch. The clan is based in Tokyo, and is rumored to be connected with the Arasaka Corporation's underworld empire.

Stats: INT 8, REF 9, TECH 5, COOL 10, ATTR 8, LUCK 4, MA 8, BODY 9, EMP 8, SAVE 9, BTM -3.

Skills: Combat Sense 4, Wardrobe and Style 3, Intimidate 3, Streetwise 2, Persuasion and Fast Talk 3, Awareness/Notice 5, Education and General Knowledge 2, Hide/Evade 3, Japanese (Native), English 4, Shadow/Track 2, Athletics 3, Handgun 3, Rifle 2, Submachinegun 3, Fencing 4, Driving 2.

Cyberware: Basic Processor, Chipware Socket, Smartgun Link, Interface Plugs, Basic Cyberoptic, Targeting Sight, Times Square Marquee.

Gear: Monoknife, monokatana, Militech Avenger pistol with two magazines, SP 18 armor.

the primary objective, and, leaving their men to battle each other, they will confront the players. Try to arrange it so that a showdown occurs between the two gang leaders, the characters, and Kang all at the same time. The outcome is anybody's guess, but with any luck the characters will prevail. If they are especially sly, the characters might talk their way out of this one by convincing Jigen that Kang really is valueless, and convincing Hsiang that he'll be better off if the Triad never hears how much trouble his men caused Kang Ho Jun's brother.

BAILING THE CHARACTERS OUT

If things are going very badly, and the team is losing, the referee can bail them out. The Professor came through. He has

tracked down the characters, and scraped together a few people from the Hope. These folks will join the battle and help to get the characters out in one piece. Use standard Hope NPCs.

POSSIBLE CONSEQUENCES

The characters make it out alive with Kang: In all the chaos, they will not be followed or traced to the Forlorn Hope. If they're really on top of things, the characters may even have figured out why everyone was after Kang. It makes for quite a story. See *Conclusion*.

The characters make it out without Kang: They are alive, but they feel guilty for getting Kang into this mess. If the Tong gets Kang he will live, but the characters may never know it. If the Yakuza gets him, it's anybody's guess. He may have been

killed in the battle. It will take a lot of drinks to drown the memories of this evening. Especially for Roxxi and Kissy.

The characters get wasted: 'Nuff said. It is, after all, *Cyberpunk*.

CONCLUSION

If the characters are successful, they will get Kang back to the Forlorn Hope alive and in one piece. Presumably, everyone will expect the businessman to be furious after his long night of terror. To the characters' surprise, that will not be the case. Kang is elated after his adventure. He will tell the characters he never had so much fun on a vacation before. Kang will buy drinks for everyone on the team, and invite them all to visit him in Korea some day. Some evening, neh? ★

THE FORLORN HOPE CLOSEUP UNDERGROUND LEVEL

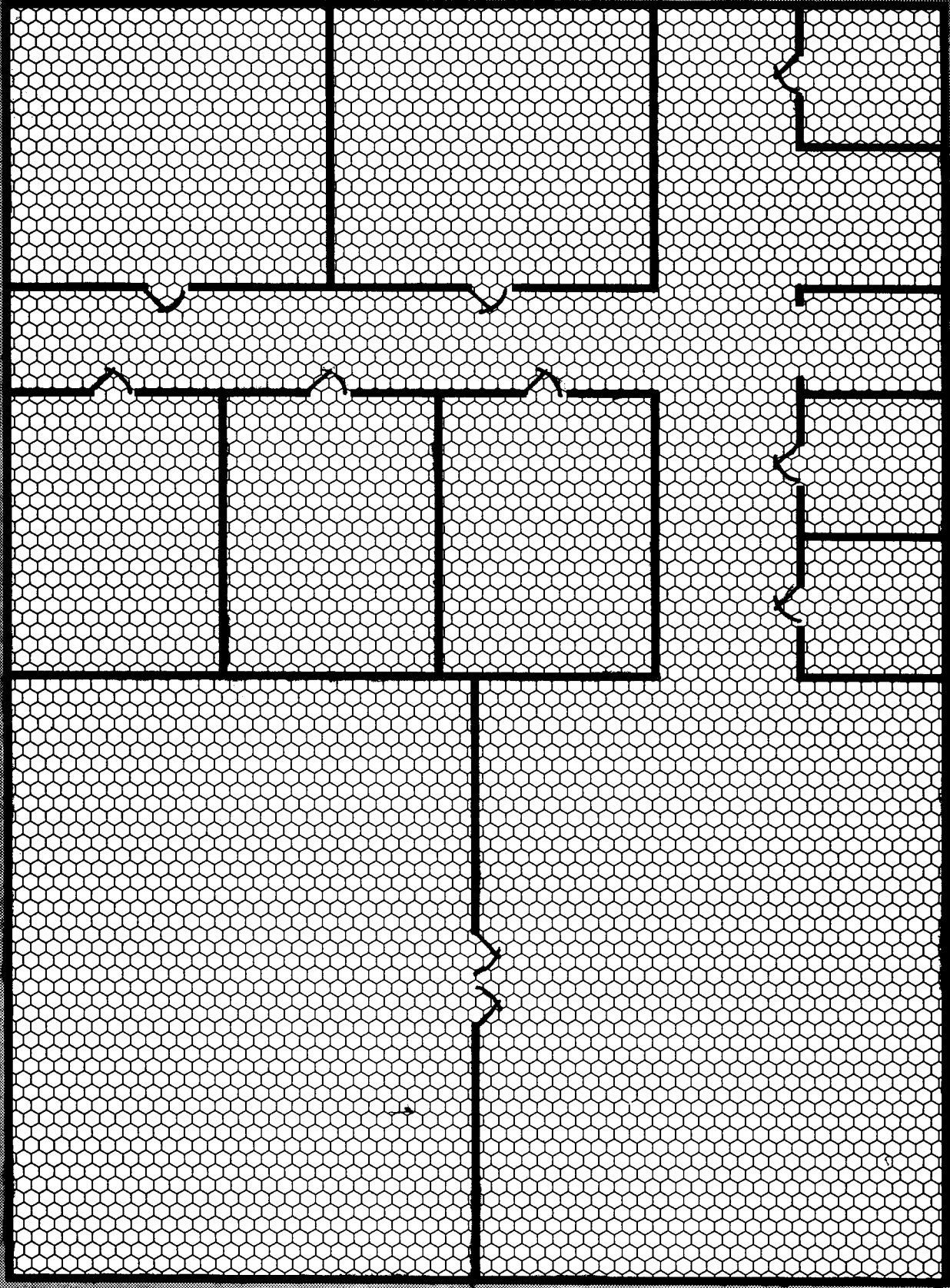

THE FORLORN HOPE CLOSEUP GROUND LEVEL

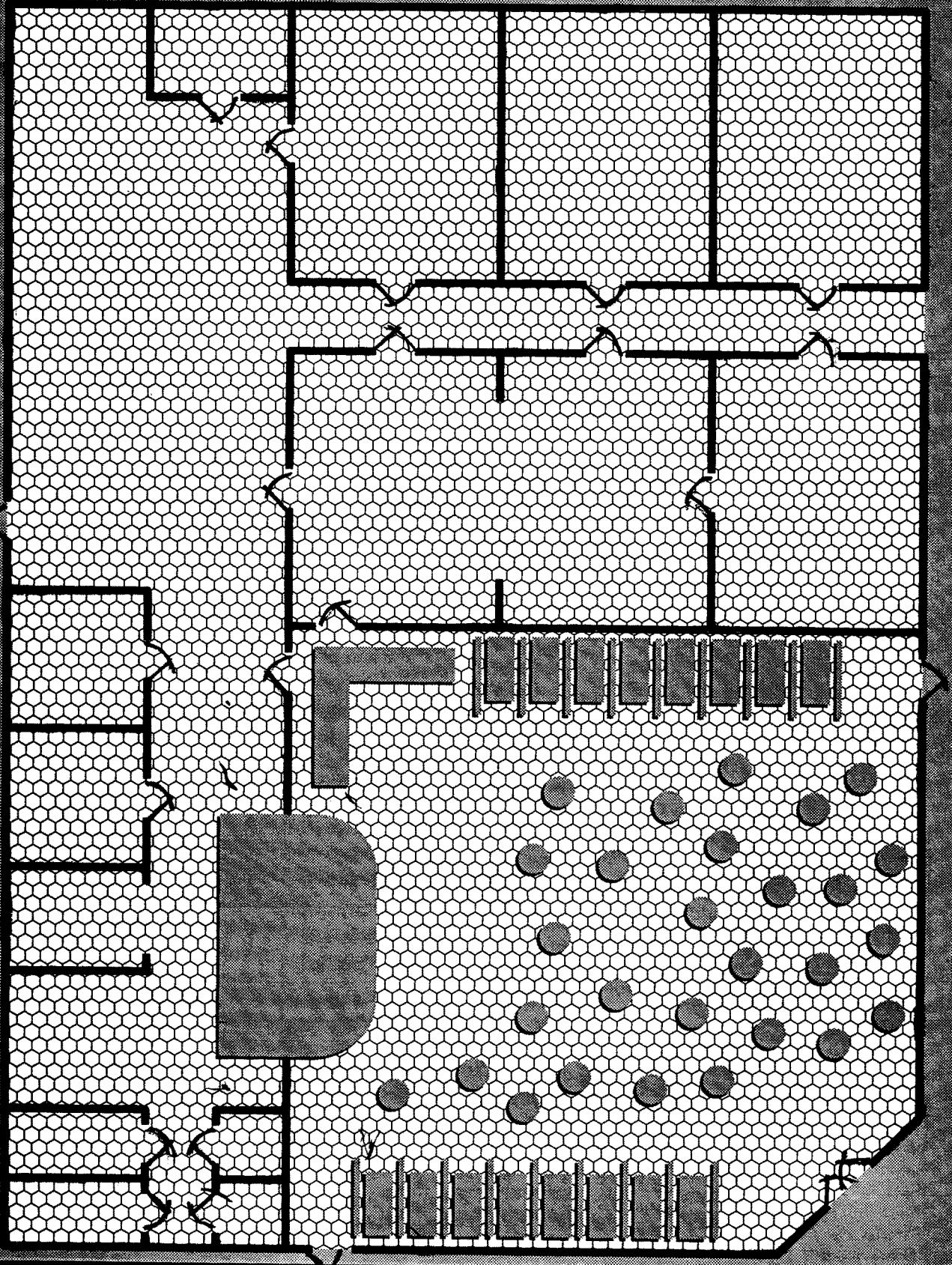

TALES FROM THE FORLORN HOPE #5

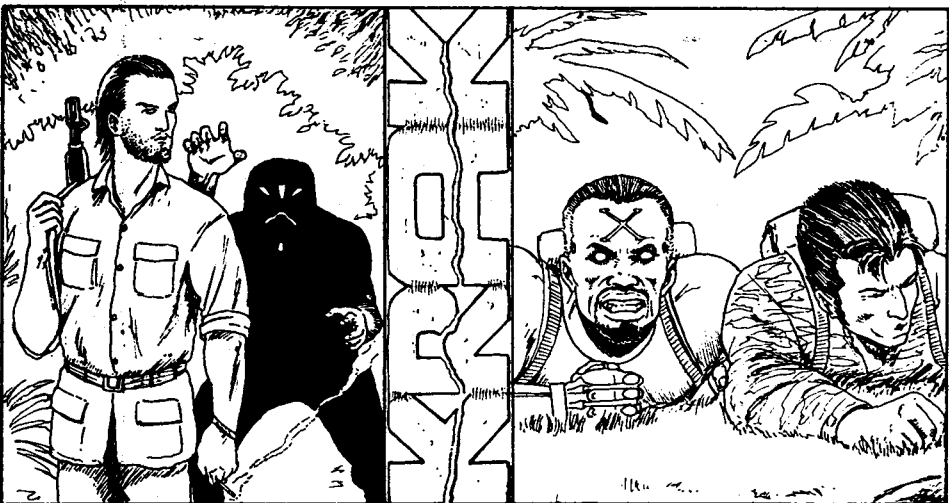

In this adventure, the characters return to South America to destroy an airfield being used by a plantation drug lord. The characters will sail into the Caribbean on a freighter, and insert into Colombia via AV-4. While they are there, they must accomplish their primary objective, plus rescue American MIA's.

Any combination of characters can play in this scenario. The adventure will be combat heavy, however, and the characters will be doing a lot of prowling in the dense forests of the Colombian highlands. A Netrunner will also be useful for penetrating the defenses of the plantation.

PART ONE: IN ON THE DEAL

So far, the characters have been tapped for adventures while they were at the Forlorn Hope. This time, things will go down a little differently. If the characters have a team leader, that person will receive a phone call at home from none other than Dollar Bill himself. Bill will ask the leader if his group is interested in running a high-stakes mercenary mission in South America. If the answer is yes, Dollar Bill will tell the leader to have the characters assemble at the Forlorn Hope at six am the following morning. The bar will be closed then, and only a select few people will be around.

If the characters have no clear-cut team leader, then Dollar Bill will either pick one member at random, call the one who has cut any previous deals for the team, or call each member individually. The message will always be the same: anyone interested in the mission should be at the Forlorn Hope at six am the following morning.

COLOMBIANA
COOKOUT

DOLLAR BILL'S MISSION

At six in the morning, the lower floor of the Forlorn Hope will be practically deserted. It is too late for any of the evening crowd to be around, but too early for most of the building's residents to be up. The club has been cleaned, and the serving crew are at home or asleep upstairs. The only people on the main floor are John Freeman, Dollar Bill, Zora, Icepick, and one man that the players won't recognize. Everyone is sitting around a table in the middle of the floor. A steaming pot of coffee and a tray of mugs are the only accessories. Dollar Bill will wave the characters over, ask them to have a seat, and offer them a cup of java. Small compensation considering the early hour, but it's something.

Dollar Bill will tell the characters that he has been contracted by a secretive client to run a covert hit on an airfield in Colombia. The airfield is owned and used by the nearby Entrada drug plantation. Dollar Bill is willing to pay the characters 1000eb apiece to secretly insert into Colombia via AV-4, hike through the inhospitable Colombian mountain forest, and destroy the airfield by blowing up the runway, cer-

tain key buildings, and any aircraft present. After completing the mission, the characters can radio for AV-4 dustoff.

THE PARTICULARS

Before he says anything else, Dollar Bill will ask the characters if they accept the job. There may be some haggling over the price, but Dollar Bill needs a commitment before he can discuss the mission any further. Once a deal has been hammered out, he will go on.

Dollar Bill is not sure who his client is, but he thinks it's a corporation, most likely one competing with Biotechnica. He believes this because of some strange requests that the client has made. The team is to go in wearing Biotechnica special-ops camouflage. They are to make sure that they are seen by people at the airfield, and the witnesses must live to report to their bosses. The reason for the deception is anyone's guess, but that is why the strike is being carried out with a ground team, rather than from the air.

There will be two people accompanying the team on the mission. One is Zora, the former Soviet highrider who hangs out at the Hope. Zora will be flying the

AV-4 for insertion and dustoff. The other person is a former South-Am commando and plantation specialist by the name of Taylor Czarnecki. Czarnecki speaks Spanish and has experience on plantation raids. He's coming along as insurance, and because he needs the money.

**"LOOKS TO ME LIKE SOMEONE IS TRYING TO SOUR UP A WORKING RELATIONSHIP BETWEEN ENTRADA AND BIOTECHNICA. ANYTHING THAT CAUSES TROUBLE FOR THE PLANTATIONS IS GOOD BUSINESS TO ME. I'D'VE GIVEN THE CLIENT A DISCOUNT IF I DIDN'T THINK THAT THEY WERE JUST AS INVOLVED WITH THE PLANTATIONS."
-DOLLAR BILL**

Once the characters have been briefed, Dollar Bill will pay them the customary half

TAYLOR CZARNECKI (SOLO)

Taylor Czarnecki is a veteran of the Central American War. He served on a team similar to LRT-601, raiding the drug plantations. Czarnecki knows his way around Colombia, and he speaks Spanish. He should be helpful in a crisis. He may also provide the pivot for some later plot elements.

Stats: INT 8, REF 10/11, TECH 7, COOL 9, ATTR 6, LUCK 5, MA 8, BODY 9/11, EMP 8/4, SAVE 11, BTM 4.

Skills: Combat Sense 5, Interrogation 4, Resist Torture/Drugs 3, Awareness/Notice 5, Hide/Evade 4, Expert Plantations 4, Expert Colombia 3, Spanish 6, Shadow/Track 4, Wilderness Survival 5, Dodge and Escape 3, Karate 5, Handgun 5, Rifle 5, Submachinegun 4, Heavy Weapons 4, Weaponsmith 3, Demolitions 3, Driving 2.

Cyberware: Basic Processor, Chipware Socket, Interface Plugs, Smartgun Link, Adrenal Booster, Grafted Muscle, Basic Cyberoptic, Low Lite™, Targeting Sight, Times Square Marquee, Rippers.

Gear: Standard Biotechnica package, rifle option. See sidebar below.

BIOTECHNICA COVERT OPERATIONS PACKAGES

The characters will be wearing Biotechnica uniforms and carrying equipment commonly issued to Biotechnica special-ops troops as part of the deception. The uniforms are Biotechnica's own woodland camouflage fatigues, bush hats and boots. An SP 20 camouflaged armor vest is worn over the fatigues. Each 10kg pack also includes a knife, rope, rations, water canteens, a flashlight, four fragmentation grenades, two smoke grenades, a superlight mylar blanket, binoculars, four flares, maps, a personal headset radio, and a Sternmeyer Type 35 pistol with four magazines. The characters can each pick one of the two other weapons commonly carried by Biotechnica troops: a CG-19B caseless assault rifle (RIF +1 N R 5D6(5.56) 90 2/30 VR 400m) with four magazines, or a Sternmeyer SMG 21 with five magazines. All weapons are smart-chipped. Characters may bring other items of their own as long as they do not exceed their encumbrance limit, but they should remember that they will be carrying explosives too (see next section).

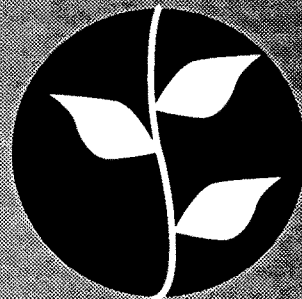

up front. He will also provide each character with a Biotechnica uniform and weapons and equipment package. Everyone will also receive a Spanish Language +5 MRAM chip. There will be a meal on the house, and then the PCs and NPCs will be loaded onto an Osprey and flown to the staging area for the operation.

PART TWO: GOING IN

The characters will arrive at the staging area at about two in the afternoon. The platform will turn out to be a large freighter anchored in international waters off of Colombia's Caribbean coast. The freighter is called the Galveston Star, and it flies the U.S. flag, but has no identifiable corporate markings on it. As the characters are flying in, they will see an unmarked AV-4 tucked in among the huge maritime cargo containers on the deck of the ship. The AV-4 is below the line of the scuppers, and is visible only from the air.

The Osprey will deposit the characters and NPCs on the freighter's empty heliport, and then leave. A mate will escort the characters to a wardroom in the superstructure. There, they will find a woman who will identify herself only as Captain Greer, the vessel's commander. Captain Greer will tell the characters that they should plan on lifting off in the AV-4 at dusk; about nine PM. It will be a one hour flight to the insertion area. The hike from the insertion area to the airfield should take about two hours. The target time for the operation to commence is one am. The dustoff will arrive at one-thirty unless the characters radio and alter the plan. Characters should be forewarned that, if they change the plan, it will be one hour for the AV to arrive after they call for dustoff.

Captain Greer will also provide the characters with the final item for their kits, the demolitions packages for the airport. Each character will carry two kilograms of C-6 and four detonator/timers. Half a kilo will level a small building. A kilo will be sufficient for any large structures. The strongest person in the party will carry the runway det-pack: a special 10kg, shaped satchel charge designed to blast a large crater in concrete. If placed properly, the package should render the runway unusable for several weeks. The characters must be at least a hundred meters away from it when it goes off, or they risk injury.

THE DEMOLITIONS MATERIALS

One half kg of C-6 does 8D10 over a 5m blast radius. When used correctly, the satchel charge fires an explosive projectile through the concrete of the runway. The projectile then explodes under the surface, creating a crater. The initial firing explosion is equal to half a kilogram of C-6. The projectile explodes for 8D10 over a 10m blast radius, but it will throw debris over 100 meters.

Once the characters have been briefed and equipped, Captain Greer will give them the run of the ship. There won't be much to do until mission time, however, and the characters would be smart if they caught a little shut-eye before zero hour. If

ENCOUNTERS IN THE COLOMBIAN FOREST

Despite being stealthy, the characters may run into people while hiking from the LZ to the airfield. Interference from any encounters may delay the mission or cause the plantation to be alerted. Possible encounters include:

- X A squad of Colombian National Militia soldiers. They are likely to be hostile unless the characters pull off a masterful bluff. Use the stats for the airfield guards (sidebar).
- X Colombian plantation peasants. They have a deep-rooted dislike of Americans, but they have few weapons and little equipment.
- X Vehicles on the roads. The characters could be caught in the headlights of a vehicle carrying anything including city socialites, roughnecks, soldiers, native Indians or priests. Almost all, except priests, are likely to be hostile to Americans, though few will try to attack or pursue. The greater danger comes from them alerting the militia or the plantation.

anyone asks Captain Greer about her connection to Dollar Bill, she will say only that she is an old associate who owes him a couple of favors.

PART THREE: THE AIRFIELD INSERTION

The characters, including Taylor Czarnecki, will lift off from the ship at 9 pm, with Zora at the controls of the AV-4. There will be a low, fast flight over water, then over the forested hills of Colombia. The AV-4 has terrain following radar and satellite navigation systems which enable Zora to fly at high speeds and low altitudes through the dark hills. Nonetheless, Zora should make a **Pilot Vectored Thrust roll over 15** to make sure that there are no mishaps. If Zora fails, the characters may get dropped in the wrong place. If she fumbles, the AV-4 may crash (see the sidebar *Stranded in Colombia* in Part Six).

If all goes well, Zora will touch down in a mountain clearing about one hour after lift off. The characters should leave the LZ as fast as possible so that Zora can clear the area before she is detected. Have the characters make **REF rolls over 15**. Anyone who fails may get a face full of jet-wash. Anyone who fumbles, falls while leaping from the aircraft and takes 1D6 damage.

**"BOJEMOI, THESE CANYONS ARE NARROW. STRAP EVERYTHING DOWN BACK THERE. IF ANYTHING GETS IN MY FACE THEY'LL BE PICKING PIECES OF US OUT OF THE TREES FOR WEEKS."
-ZORA**

The airfield is four miles to the south; about a two-hour hike. The distance was necessary to keep the airfield personnel from hearing the AV-4's engine. There is nothing but forest and a couple of roads between the LZ and the airfield. As long as the characters don't get lost, there should be no trouble. Have the characters make **INT rolls over 15** to make sure they stay on the right track. If no one succeeds, the team may be delayed, or get seriously lost (see *Stranded in Colombia*).

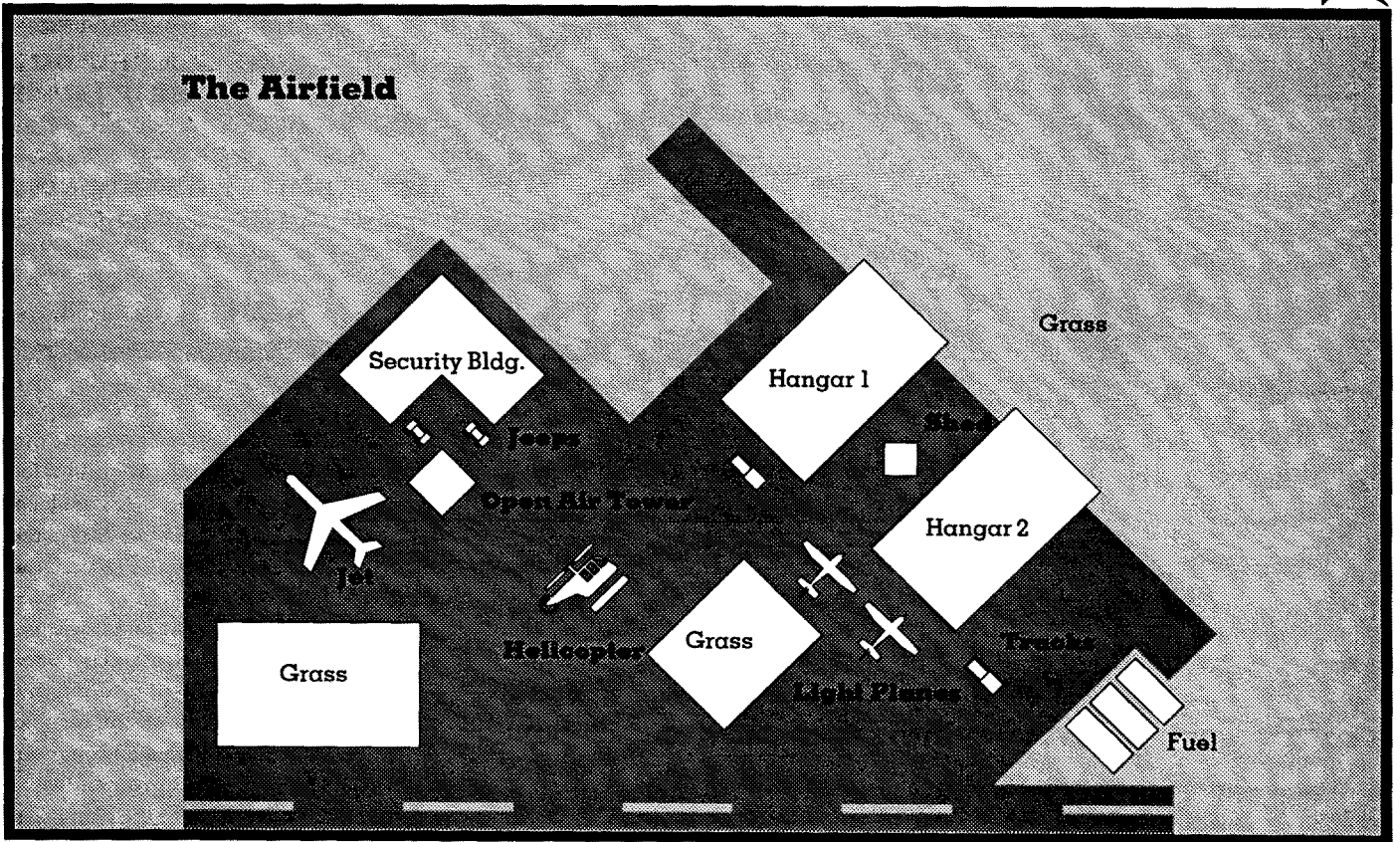

THE AIRFIELD

The airfield sits on a mountain plateau. It has a 5000ft runway and several structures, including a main building and tower, two hangars, a small service building, fuel tanks, and a shed. There are four aircraft parked at the field; a helicopter, two light, prop-driven airplanes, and a twin-engine business jet owned by Diego Entrada, the leader of the Entrada family. Two jeeps are parked near the main structure. There are 10 plantation guards stationed at the airfield. Most are in the main building, but two will be wandering on patrol and two will be guarding Entrada's private jet. The characters will have to disable or eliminate at least some of the guards in order to be able to successfully plant the explosives, but they must remember that they are to leave witnesses alive at the scene. Have the characters make **Stealth rolls vs. the guards' Awareness / Notice** to elude the plantation soldiers. See the sidebar for guard stats. Also see the sidebar for a map of the airfield.

To successfully destroy the airfield, each character planting a det package must make a **Demolitions roll over 15**. Failed rolls may mean explosives that don't go off. Fumbled rolls may mean that the character blows him or herself up. The character planting

PLANTATION SOLDIERS (SOLOS)

These are the guards that the characters will encounter at the airfield, and also at the plantation itself. Use these stats for Militia soldiers too.

Stats: INT 7, REF 8 to 10, TECH 5, COOL 6 to 10, ATTR 7, LUCK 5, MA 8, BODY 8 to 10, EMP 7/7, SAVE 8 to 10, BTM -3 to -4.

Skills: Combat Sense 3, Resist Torture/Drugs 1, Persuasion and Fast Talk 2, Awareness / Notice 4, Hide/Evade 3, Spanish (Native), English 0 to 6, Shadow / Track 3, Wilderness Survival 2, Brawling 5, Dodge and Escape 3, Driving 3, Handgun 4, Rifle 3, Submachinegun 4, Stealth 3, Heavy Weapons 4.

Cyberware: Varies, but minimal.

Gear: Knives, radios, Federated Arms X-9mm pistols with four magazines, Fabrica De Armes M-2012 rifles (RIF 2 N P 6D6+2(7.62 Soviet) 30 30 VR 400m) with four magazines or Fabrica De Armes M-19 submachineguns (SMG 0 J C 2D6+1(9mm) 35 30 ST 150m) with four magazines. Wearing olive drab fatigues.

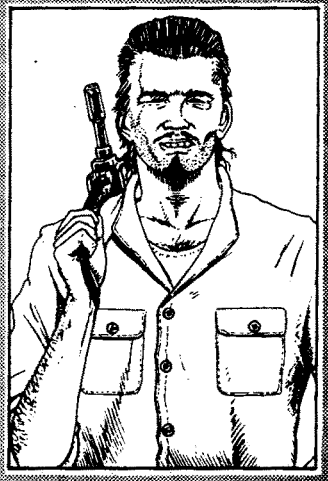

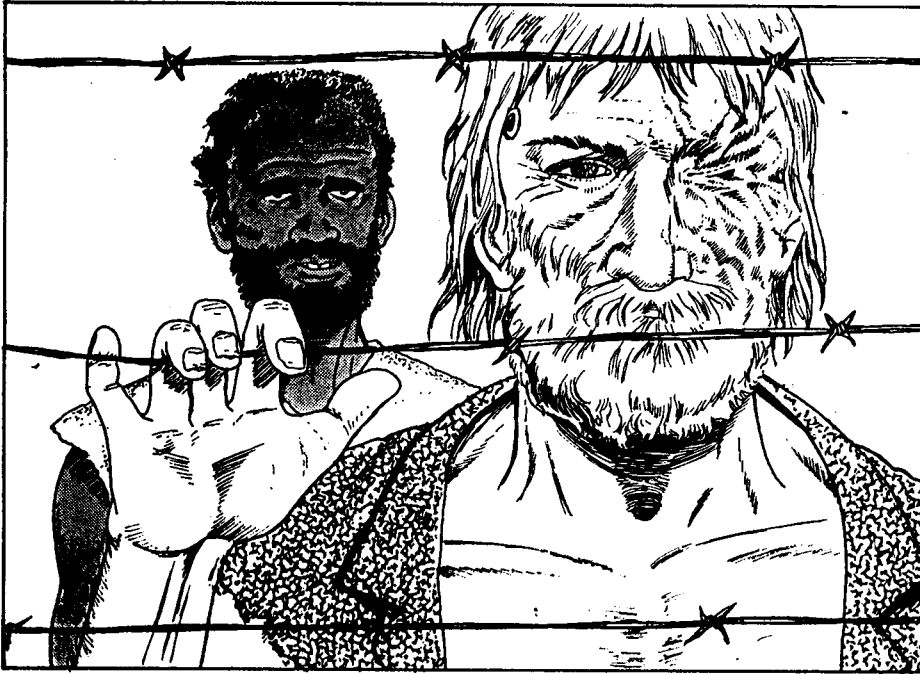

FORGOTTEN CASUALTIES OF A FRUITLESS WAR.

the satchel bomb must make a **Demolitions roll over 20** for the pack to have full effectiveness. Remember the clearance distance. Characters within 100 meters of the runway explosion have a 25% chance of taking 1D6 shrapnel damage. Anyone within 50 meters has a 50% risk of taking 2D6. Anyone within 25 meters has a 75% chance of taking 3D6. Anyone within the explosion radius takes full damage. If the characters detonate the fuel tanks, the resulting explosion will do 5D6 over a 20m radius, and may ignite the other buildings.

PART FOUR: AN UNEXPECTED DISCOVERY

While the characters are raiding the airfield, they will make an astounding discovery: American POWs from the Central American wars are being held at the Entrada Plantation. They must have been there at least since the end of the war, ten years ago. This information will come as a surprise to the characters. As far as they know, all remaining POWs were returned to the US when the Treat-Davies act re-established diplomatic relations between the US and the South-Ams. Of course, the Entrada Plantation is hardly the Colombian Government.

The characters can make their shocking discovery in one of a number of ways. Since they are leaving witnesses alive at the airfield,

one of the frightened guards can start babbling, recognizing the characters as Americans and hoping to save his skin. He will claim that there are other Americans at the estate. Alternatively, one of the characters can stumble across some photographs of the Entrada estate. The photos will be posted on a board in one of the airfield buildings. They will show plantation and airfield guards partying at the estate or out in the fields. In the background of one of the photographs will be some beaten, emaciated looking men in the remains of U.S. military uniforms. The men look like they are being used as field labor. If any of the characters fought in the South American wars, add to the excitement by having that character recognize one of the individuals in the photographs. If none of the characters are veterans, Taylor Czarnecki can fill the bill.

A TOUGH DECISION

The characters should be faced with a dilemma now. They've accomplished their primary mission, and the AV-4 should be due at any time. They could forget what they have seen or heard, take the AV to the ship and head for home. Or they could head for the plantation and try to bust the American POWs out. Taylor Czarnecki will lobby strongly for a rescue. The player characters should agree. Remember the credo of the Forlorn Hope: never leave anyone behind.

**"YOU GUYS CAN SHIP OUT, I'LL GO IN ALONE IF I HAVE TO. NO ONE AT THE HOPE IS GONNA ACCUSE TAYLOR CZARNECKI OF ABANDONING AMERICAN BOYS. I'D SOONER DIE ALONE IN THIS STINKING FOREST."
-TAYLOR CZARNECKI**

If the characters decide to head for the plantation, they will have to radio Zora or the ship and call off their extraction. It's only a few miles to the plantation, and there are jeeps parked at the airfield (assuming the characters haven't destroyed them). The characters should be able to drive to within a few hundred meters of the plantation without being discovered. Two things the characters should consider: 1) The plantation may receive word of the attack on the airfield, even if the characters disabled all communications. 2) The characters probably won't want to use the AV-4 to get to the plantation, but they can call it in for air support when they are busting out with the POWs.

Once the characters have decided to rescue the POWs, they may want to interrogate one of the airfield survivors further. If the characters make **Interrogation rolls vs. the guards' Resist Torture/Drugs roll**, they will learn that five POWs have been at the Entrada plantation since the end of the war. The POWs are used for slave labor in the plantation's coffee fields. At night, the Americans are locked in a guarded concrete bunker outside the main estate walls. There are guards on all of the roads leading into the plantation, and roving guards around the estate. The characters should be sure to be brief. The commotion at the airfield will eventually be investigated by a roving National Militia patrol. The Militia will report the raid to the Entrada compound.

PART FIVE: THE PLANTATION

The Entrada Plantation is a large coffee farm covering several thousand acres of the Colombian highlands, in the mountainous Antioquia province. The nearest town is Ituango, on the Cauca river, ten miles distant. The city of Medellin is 70 miles to the south.

The estate is on the western edge of the plantation. The characters will be able to

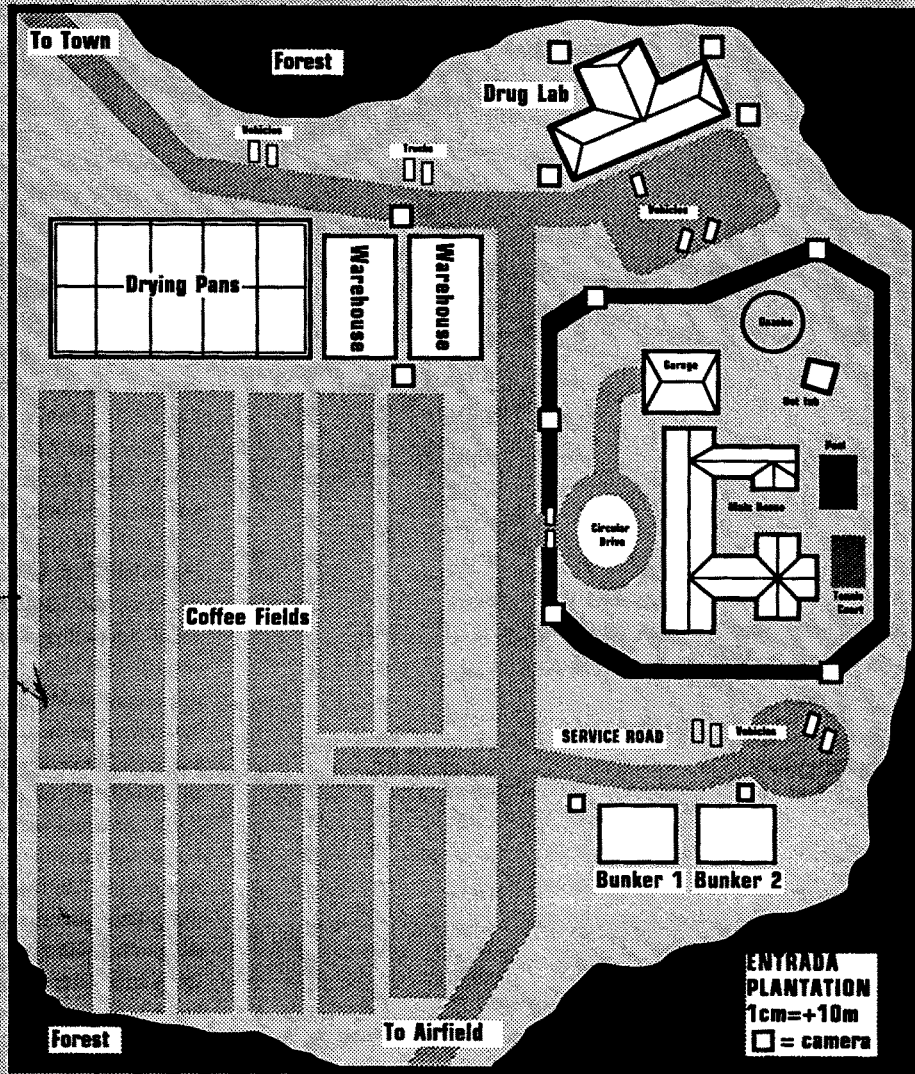

THE DRUG PLANTATIONS

When the drug plantations of Central and South America are mentioned, people tend to think of sprawling fields of coca plants being harvested by cheap labor and processed into cocaine. This is not the case; virtually all coca plants were wiped out by a genetically engineered fungus in 1995. Cocaine is still produced, but it is a rarity. Most plantations produce legitimate crops (bananas and coffee are common). These products are legally sold on the international market. Many of the plantations also maintain laboratories for designing and producing the synthetic drugs that have replaced heroin and cocaine. Some plantations grow genetically engineered plants that produce artificial drugs, components of drugs, or play host to symbiotic bacteria designed to produce drugs.

Drug manufacturing is common to the plantations for a number of reasons. The plantations are usually remote, and easily guarded. Many plantations maintain private armies that

would be prohibited in urban areas. Also, plantation owners are usually the only people with the necessary capital to set up a lab and recruit chemists. Finally, trade in legitimate crops allows plantations to launder drug income in-house, without risking third-party involvement. Some plantations are privately owned, some are owned by banks and corporations. During the war, one of the United States' major objectives was destroying plantations suspected of involvement in the drug trade. Since the plantations employ many people, this tactic did not endear the US to the South American population. Also, many plantations are partly owned by government officials, or pay local politicians and law enforcement officials large bribes to avoid interference.

The Entrada Plantation is a privately owned farm that produces coffee for export. It does not grow any drug-related plants. It does, however, have a large laboratory in which several drugs are illegally synthesized.

THE AMERICAN POWs (SOLOS)

There are five American POWs at the Entrada Plantation: Captain Howard Sawyer, US Army; Sergeant Pete Udall, US Army; Private Danny Infante, USMC; Private Karl Benson, US Army; and Lieutenant Evan Kelcey, USAF. They have been prisoners for between 10 and 12 years. They are confused, brainwashed and emaciated. Due to the POWs poor condition, one set of stats will cover them all. The men are incapable of fighting effectively, and at least two no longer speak English well.

Stats: INT 5, REF 5 to 7, TECH 3, COOL 4, ATTR 5, LUCK 5, MA 6, BODY 4 to 7, EMP 7 to 3, SAVE 4 to 7, BTM -1 to -12.

Skills: Combat Sense 1, Resist Torture/Drugs 1, Awareness / Notice 2, Hide / Evade 1, Wilderness Survival 1, Brawling 1, English 1 (forgotten) to Native, Spanish 7, Stealth 1.

Cyberware: Basic Processors, Chipware Sockets, Smartgun Links, Interface Plugs, possible Basic Cyberoptic.

Gear: None.

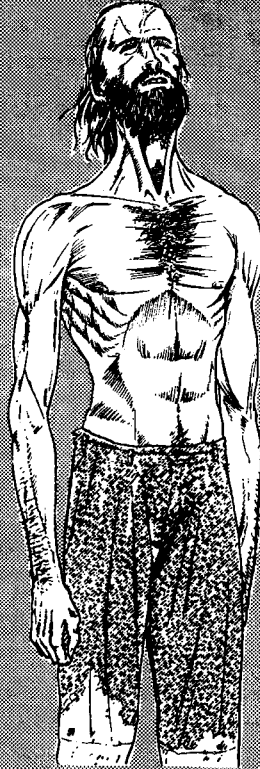

bunker door without alerting the security crew in the estate. If the team has a Netrunner, it will help them to defeat the security.

If the characters set up a diversion: This may be the easier way to do it. One or two characters could plant some of the remaining explosives. The explosion(s) will divert the attention of many of the security guards, allowing the characters to free the POWs with less chance of interference. Alternatively, the characters could call in Zora with the AV-4. The aircraft has a chin-mounted minigun, and will raise hell over the estate. The characters will run the risk of having their evacuation craft shot down or disabled, however.

The characters run a frontal assault: This is ill-advised. There are far more guards than characters (see also below).

POSSIBLE CONSEQUENCES

Alerting the Estate: Once people in the estate know that something is wrong, they are going to send for reinforcements. There is a National Militia garrison in the town of Ituango, and the local Militia commander is in Diego Entrada's pocket. This is part of the reason why the estate guard detachment is so light. As soon as trouble starts to brew, the estate will attempt to place a call to the Militia Garrison in town. Twenty minutes after the call, fifty Militia troops will show up in five deuce and half trucks. The troops will be carrying heavy weapons, and are accompanied by their commander, Fillipe Soto. See the sidebar in Part Three for Militia stats.

The characters can prevent catastrophe by making sure that they are gone within twenty minutes after fighting breaks out. Alternatively, they can have Zora intercept the reinforcement column while it is still in transit. (Zora will risk being shot down if she does this. See below.) A Netrunner might also be able to temporarily block the phone call to Commander Soto.

Losing the AV-4: If the characters call Zora for help in either starting a diversion or intercepting the militia, they run the risk of having their dustoff shot down. The characters will also have to carefully consider the limitations of their air support before they go in. Remember: unless the characters have stated their intentions and timetable to Zora or Captain Greer via radio, it will take an hour for the AV-4 to arrive after the PCs summon it. If the characters tell Zora to land and wait, they run the risk of having the AV discovered by a ground patrol (30% chance). If they keep Zora in the air, she

case the area from the nearby hills. If they have binoculars and Low-Lite™, they will be able to identify the prison bunker near the estate. They will also see one guard at the bunker, and six more patrolling the estate walls. There are vehicle lights from roving patrols cruising the entrance roads and the paths through the coffee fields. On the far side of the estate is a large, low building. It is guarded by six men, and it is the only building with burning lights in the windows. Any character who makes an INT roll over 15 will be able to guess that it is the drug lab. Other noticeable features include several parked jeeps and trucks, coffee drying pans, and a storage warehouse for bagged coffee beans. The characters will notice that three of the vehicles have .50 caliber machine guns (HVY -1 N R 4D10(.50cal) 200 10 ST 400m) mounted on their roll-bars. There are 20-25 total guards on hand at the plantation.

RAIDING THE PLANTATION

There are a number of tactics the characters might try when attempting to free the POWs.

If they attempt to secretly sneak the POWs out: This will be difficult. The characters will have to sneak into the plantation, elude the patrols, quietly deal with the bunker guards, and smuggle five decrepit men back into the woods. The characters will have to make Stealth rolls vs. the bunker guards Awareness/Notice, and may run into patrols or be seen by the estate guards. There are also cameras planted at various locations, wired into a security office on the estate. Once open combat breaks out, it will be difficult for the characters to escape on their own, let alone with five straggling POWs. One of the bunker guards has the keys to the prison, but it will take an Awareness/Notice roll over 15 for the characters to notice that the bunker is wired, and an Electronic Security roll over 21 for the characters to crack the

STRANDED IN COLOMBIA

It is quite possible that the characters could find themselves in the middle of Colombia with no obvious way to get out of the country. This could happen if the characters get lost, miss their rendezvous with Zora, or if the AV-4 is shot down either with or without the characters on board. If the characters are stranded, they will face inhospitable countryside, an angry Militia, hostile civilians, and a drug lord bent on revenge. The only good chance for escape will lie in hiking cross-country and avoiding contact with other people whenever possible. The characters can aim for three possible objectives:

The coast: If the characters get to the Colombian coast, they may be able to steal a boat and rendezvous with an Ameri-

can or European ship somewhere out in the Caribbean Sea. Alternatively, Jamaica is only 600 miles off of the coast, if any one can navigate. The characters may also be able to reach the Pacific Coast, but it is a far longer sail to friendly waters from that side.

Capture an aircraft: The mountains are dotted with small plantation airfields. If they are clever, and if any of them can fly, the characters may be able to steal a small plane and fly either out to the Galveston Star, or to Jamaica, Brazil or Trinidad.

Cross the border into Panama: True, the Panamanians have no love for Americans, but they have no love for Colombians either. Neither the Colombian Militia nor Diego Entrada will be able to pursue the characters across the border. Of course, it's still not home...

may run out of fuel. After an hour of flight, the AV-4 has only 20 minutes of loiter time or it risks running out of fuel on the return trip. Of course, there is fuel at the airfield, but the characters may have destroyed it.

There are three possible ways the characters could lose the AV-4. It could be shot down while providing cover or a diversion for the characters, Zora could crash or get lost (Have her make a **Pilot Vectored Thrust roll over 15** for every trip to and from the ship), or the characters could run out of fuel on their return trip. If the characters are never picked up, they will have to flee into the forest. It will be nearly impossible for them to elude the Militia while they have the five exhausted POWs with them. If the AV-4 runs out of fuel, the characters will have to set down somewhere in Colombia, unless they can make it out to sea or across the Panamanian border before the engines quit. If the characters have to set down in Colombia, see *Stranded in Colombia*. Otherwise, see *Optional Episodes*.

**"AV-4S DON'T GLIDE, GUYS,
NOT EVEN LITTLE BIT. JUST
WARNING YOU."
-ZORA**

PART SIX: POSSIBLE OUTCOMES

Depending on how the characters perform on their rescue mission, they may or may not come out heroes.

The characters come out with the POWs: See *Conclusion*.

The characters come out without the POWs: If the characters took an honest crack at a rescue, no one will hold them accountable for failure. They were outmanned and out-gunned, and the fact that they would even try makes them worthy of praise. Nonetheless, the characters may encounter some friction from veterans at the bar who may suggest that, if they had only tried a little harder, they might have succeeded. This hostility is born of anger and frustration rather than any true bad feelings for the characters.

The characters don't attempt to rescue the POWs: If word ever gets out at the Forlorn Hope that the PCs abandoned American boys in the field, the characters will become objects of scorn. They have broken the most basic credo of the regulars, and there is little chance of forgiveness. The characters might be able to redeem themselves if they arrange to go back into Colombia and try to get the POWs out. See *Optional Episodes*.

The characters don't make it out: See *Stranded in Colombia* and *Optional Episodes*.

CONCLUSION

If the characters escape with the POWs, they will be heroes at the Forlorn Hope. This kind of rescue is one of the few things that can elevate one to glory among the hard-bitten Solos at the Hope. Even if the characters only manage to rescue one of the POWs, they will be treated with a new level of respect and admiration at the bar. John Freeman and Dollar bill will personally thank the characters for taking risks above and beyond the call of the job. Dollar Bill will personally oversee the task of rehabilitating the surviving POWs.

OPTIONAL EPISODES

- X Biotechnica, who designed the drugs being produced by the Entrada Plantation, has learned that someone has soured the deal. They are out to find the people who meddled in their affairs. Suddenly, the characters find themselves hunted by a team from one of the nastiest corporations in *Cyberpunk*.
- X Diego Entrada has had his feathers singed, and he, too, is out for revenge. Agents of the Entrada Plantation will trace the characters back to Night City and attempt to extract a pound of flesh.
- X If the characters failed to extract the POWs, they may run another mission into Colombia specifically for the purpose of conducting a rescue. The question is, will Diego Entrada know that they are coming this time?
- X If the characters set sail across the Caribbean, they may find themselves on an odyssey that will take them through Haiti, Jamaica, Cuba, and possible other points in the tropical ocean. All the while, they may be pursued by agents of Diego Entrada.
- X Petrochem, Dollar Bill's client, and the corporation responsible for attempting to disrupt Biotechnica's operation, wants to destroy all traceable leads. They have targeted Dollar Bill and the characters who accomplished the mission.★

THE FORLORN HOPE CLOSEUP FIRST FLOOR

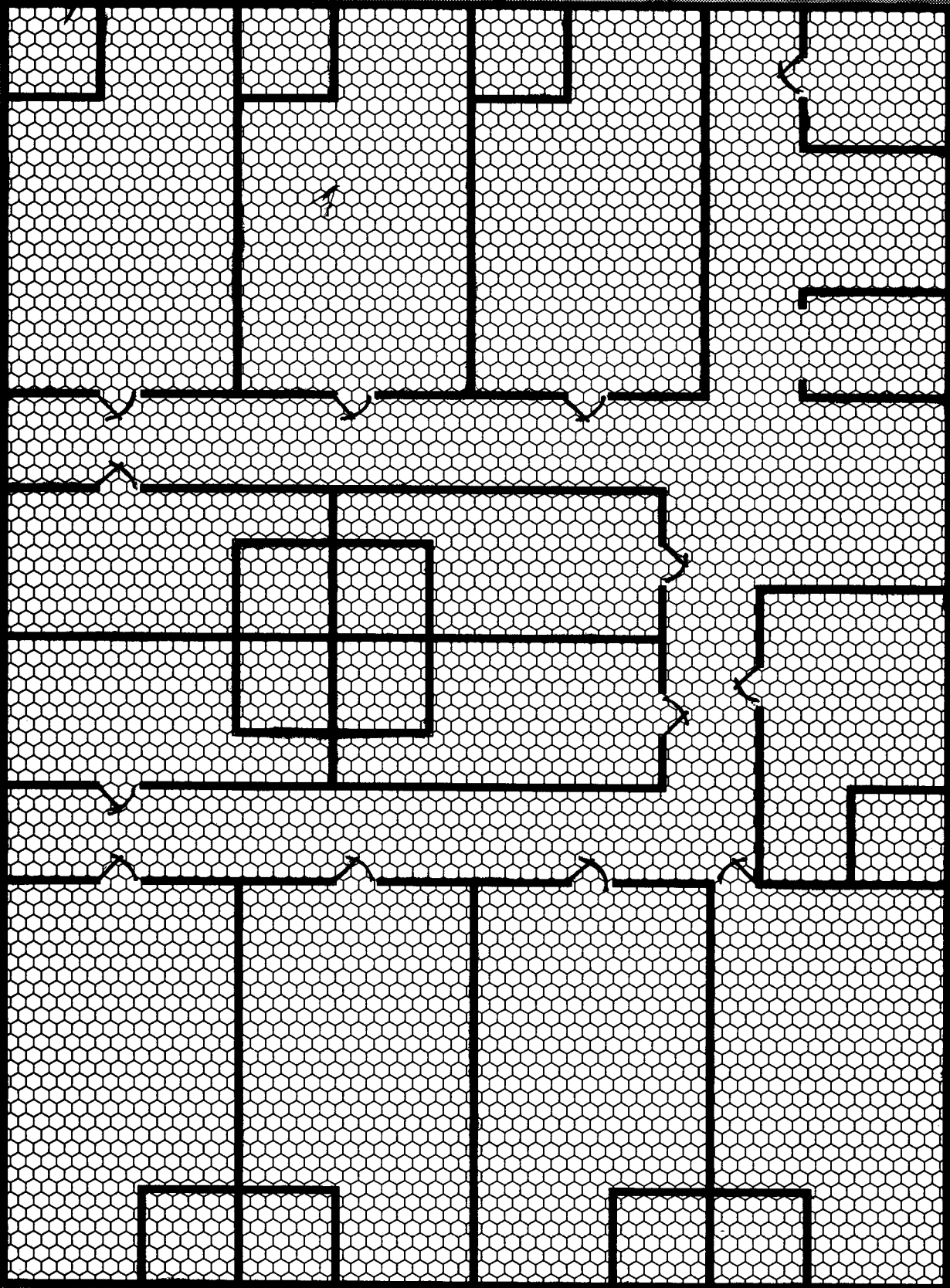

Four
THE FORLORN HOPE CLOSEUP THIRD FLOOR

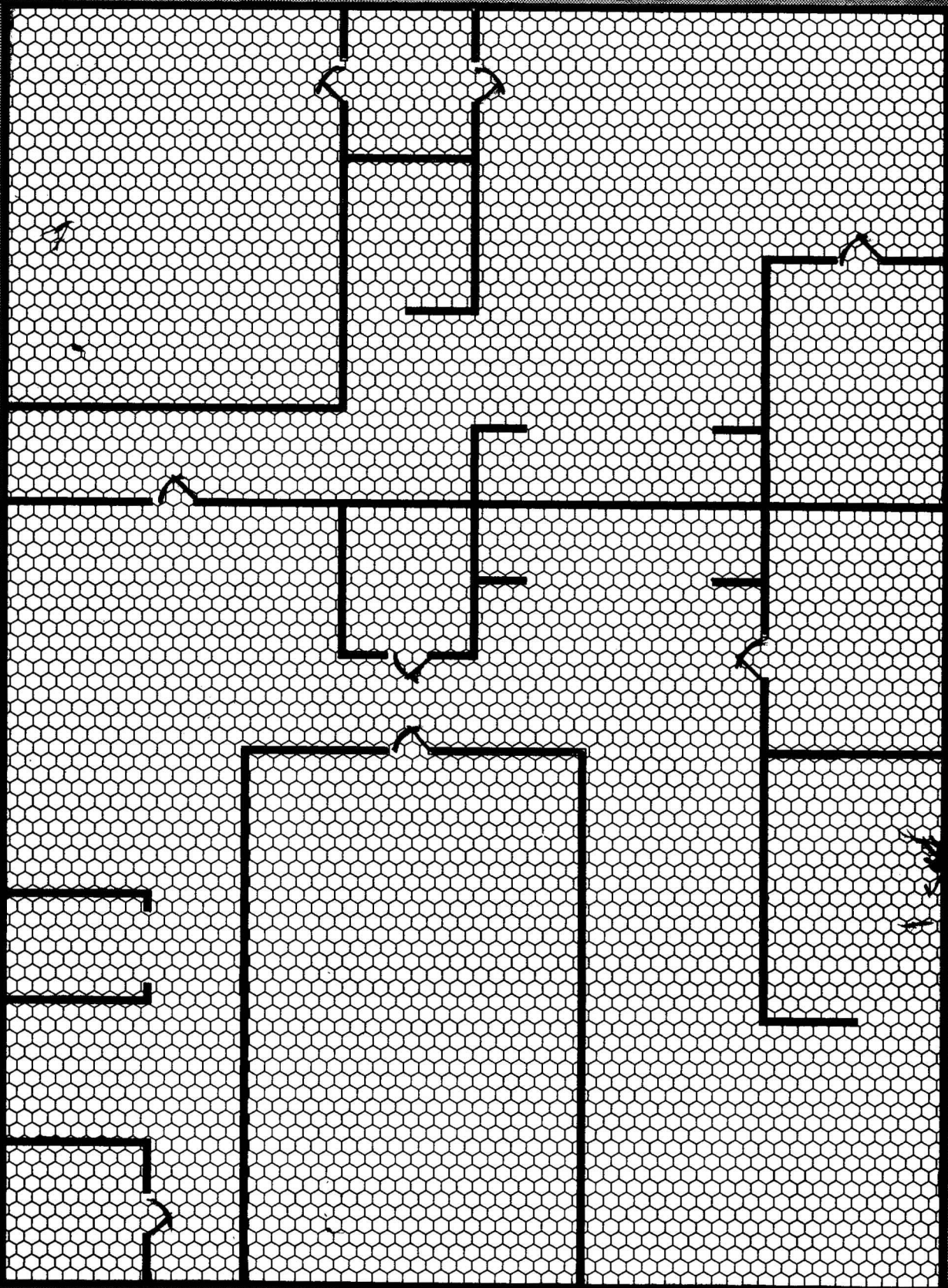



In this adventure, the characters must play detective to find out why the Axeman was the victim of a professional hit. The characters will use Axeman's clues and their own ingenuity and street smarts to trace the case and uncover the perpetrators. Along the way, the characters will encounter the woman who originally hired the Axeman, various cyberpunks, and an unscrupulous Corp who is masterminding a clever scheme.

The adventure requires characters who are tough and smart, with deductive skills and plenty of Streetwise. In order to succeed, the characters will have to use their brains. Merely shooting everything they encounter will only get them in trouble. A Netrunner is also required, although the characters can use Ras Angabo if they need to. Having a well-connected Fixer in the party couldn't hurt either.

PART ONE: AN UNFORTUNATE INCIDENT

This adventure starts with a rumor. As the characters water themselves down at the Forlorn Hope one evening, they may catch one item in particular that is floating along with the usual tall tales and latrine humor that constitute much of the casual conversation at the bar. The rumor concerns the hard-boiled detective, Axeman, a regular customer at the Hope and a friend of manager John Freeman. Axeman is a popular man at the Hope, respected for his past and no-nonsense attitude, and liked for his loyalty, persistence, and wit. His recent absence at the bar has not gone unnoticed, and the scuttlebutt is beginning to circulate.

There are several versions of the rumor floating around. You may have the characters catch one or more of the versions as you



FALL OF THE AXEMAN

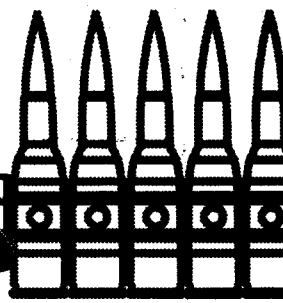

THE RUMORS

- 1. Axeman has been killed in an accident.
- 2. Axeman has been seriously injured in an accident, and is in the hospital.
- 3. Axeman has been murdered.
- 4. Someone has tried to kill Axeman, and he is in the hospital.
- 5. Axeman is deep undercover, and the rumors of his death or injury are exaggerated.
- 6. There's nothing wrong with Axeman. Someone saw him around just a little while ago.

choose, or you may roll a D6 randomly to see what they overhear. This is merely color, and it will not effect the adventure.

Once the characters have been warmed up with one or more of the versions of the rumor, they will be drawn into case personally. Marianne Freeman will bring a message with the characters' next round of drinks. John Freeman would like to speak to characters in his personal office on the fourth floor suite. The characters should come up at their soonest possible convenience.

FREEMAN'S WRATH

When the characters arrive in Freeman's office, they will find him with his feet up on his desk, nursing a cup of coffee. Scattered around the desk are files and computer disks related to his various projects. Freeman will tell the characters to close the door behind them. There are only two other seats in the office, so some of the characters will have to stand.

Freeman will get straight to the point by asking the characters what they may have heard about the Axeman that evening. Depending on which rumor(s) the characters may have heard, the Professor will either confirm or dispute them. Either way, he will fill the characters in on what is actually going on. "Early yesterday, someone tried to put the hit on the Axeman. A building janitor found him in his office at ten AM, bound and gagged, with a

bullet hole in the back of his head. The janitor thought Axe was dead, but broke his Trauma Team card anyway. That's the only thing that saved his life. He's in the hospital now, in a coma. It's a miracle he's alive at all. Doctors say he may regain consciousness, or he may not.

"AXEMAN IS A FRIEND OF MINE, AND HE'S BEEN AT THIS BAR SINCE THE DAY WE OPENED. I'M TAKING THIS HIT PERSONALLY. THE COPS WON'T DO DIDDLY FOR ANYONE IN THIS NEIGHBORHOOD. I WANT SOME PEOPLE TO CHECK OUT WHAT AXE HAS BEEN DOING RECENTLY, AND TRY TO FIND OUT WHO ORDERED THE HIT. SOMEBODY'S GONNA LEARN THAT WE ALL STICK TOGETHER DOWN HERE. FEEL LIKE A JOB?"
- JOHN FREEMAN

The gist is that Freeman wants to know who would put a slick hit on a small-time private eye like the Axeman. Even though the hit was not entirely successful (as long as Axeman is still alive), the method, and the fact that no one saw or heard the hitmen, indicates a high level of professionalism. Freeman is willing to pay the characters 200eb apiece per day to investigate the crime, with a bonus of 500eb each if they successfully discover the culprit.

PART TWO: LEGWORK

Since the Axeman is still in a coma, and the doctors at City Medical Center are not letting any non-medical personnel approach him (you should mention that there's a regular from the Hope keeping watch as well), the next logical step will be for the characters to check out the detective's office, home, or clothing for clues. If there is any indication of the nature of Axe's current cases, that's where they should be. Freeman will provide the characters with the addresses of the Axeman's office and apartment.

If the Characters Check the Axe's Clothes: The bloodstained clothes that the Axeman was wearing when he was hit were

put into storage by the hospital in case the police require them as evidence. Of course, since the crime took place in the combat zone, the police are not likely to take much of an interest. Any items that were in his pockets are also in storage. The items can nominally be released only to family or police, but, if the characters go to the hospital, a **Persuasion** and **Fast Talk** roll or **Bribery Roll** over 15 or some good role-play will be sufficient to get the attendant to produce the items from a locker. The characters will find matches, smokes, the Axe's gun and shoulder rig, his sap, and his wallet with ID and some cash and Magic Wall™ ATM slips. There is nothing to indicate anything about what cases the Axe was working on. No scrawled phone numbers or anything. An **Intelligence** roll over 18 may lead one of the characters to deduce that the body may have been stripped of any clues by the assailants.

If the Characters Check the Axe's Apartment: The Axeman lives in a tiny, one-room apartment at South Williams and 28th, just a few blocks away from the Forlorn Hope. The characters will need a **Pick Lock** roll over 20 to get in without destroying the front door. Inside the apartment the characters will find a mattress on the floor, several bottles of alcoholic beverages, clothes scattered about, and some furniture and kitchen items. There is very little that seems work-related. It looks like the Axe didn't like to bring his job home with him.

If the Characters Check the Axe's Office: This is the most obvious choice, and it is the one that will yield the necessary clues. The Axeman keeps his office in the combat zone, where the bulk of his clients are located. The office is in a dilapidated building on 31st Street, south of the Gibson Freeway. There are still bloodstains on the floor from the Axeman's wound. There are some discarded items from the Trauma Team. The cops haven't even been here. Nothing short of a full-scale firefight, a cyberpsycho, or a downed officer will bring them to this neighborhood.

The Axeman's office looks like it has been cleaned out. All files, phone numbers and records are missing. It is no great leap of deduction to realize that whoever attempted the hit also ransacked the office for any information that could be traced. Fortunately, the assailants were rushed, and they did not get everything. A search

and an **Awareness/Notice** roll over 22 will reveal a secret safe hidden behind one of the large filing cabinets. A **Pick Lock** roll over 25 will get the characters into the safe. Otherwise it may take some Demolitions or other skill to open it. Characters should be careful to avoid damaging the contents if they have to force the safe.

THE CLUES

The Axeman knew that the Combat Zone is a dangerous place to keep sensitive information, so he had the hidden safe installed to safeguard information and clues pertaining to his most important cases. The safe is also where he stores his expensive electronic equipment, including cameras and listening devices. Inside the safe, the characters will find the following items:

- * A roll of photographs.
- * An audio tape.
- * A printout of some computer data.
- * Some optical computer disks.
- * The name and address of a woman living in the Combat Zone, printed on a 3x5 card.
- * A photograph of a nondescript young man.

CHECKING THE CLUES

If the characters research the clues they have uncovered, here is what they will find.

- * The photographs are a red herring. There are a variety of shots, including some surveillance shots of a young man and lady, and some building exteriors. The photos do not pertain to the case the characters are interested in.
- * The audio tape is also a red herring, but it may be useful to the characters later in the adventure. It contains a conversation, perhaps recorded from a bug or phone tap. A man and a woman are plotting the murder of the leader of the Spikes, a combat zone boostergang. Apparently the murder is to take place in four days. At one point, the woman is identified by the name, 'Violet'. The man is never identified.

- * The disks contain the tools and elements that Netrunners and computer programmers use to create secure data fortresses and subgrids, or to modify fortresses. Included is the code for many standard and black programs.
- * The printouts contain information on the construction of a data fortress. A Netrunner who makes a **Computer Programming** roll over 20 will be able to successfully interpret the code. The fortress would allow a person with the correct codes to access secure information in an adjacent data fortress and remove it without giving any warning. It's a tool for stealing sensitive data. There is no indication of who the fortress might have been programmed for, or whether it has even been implemented. One thing worth noting is that the printout contains the complete layout of the data fortress, including the locations of all sensitive data and black programs. A Netrunner armed with this information could penetrate the data fortress with little risk.
- * The 3x5 card has the name Irina Lovodny and a south of the freeway address written on it. No one in the party will recognize the name. The address is easy to get to. See the next section.
- * The young man in the photograph is holding a cyberdeck. He looks to be in his early twenties. He is dressed casually and smiling slightly. The photo looks like it was taken in an apartment. Characters making **Awareness/Notice** rolls over 20 will see a partially obscured neon sign across the street, visible through the window behind the young man. The visible part of the sign says 'EDITERR' in cursive, red neon letters. Any character making a **Streetwise** roll over 20 will recognize the sign as belonging to the Mediterranean Lodge, a cheap boarding hotel in the Combat Zone. Otherwise the characters will have to do a little research to discover the identity of the sign. See the next section.

PART THREE: THE LOVODNY TWINS

The most important clues in the safe are the name and address of the woman, and the photograph. The characters must decide which one they want to pursue first. The characters will have to follow both leads before they have all the information they need. It is possible that the characters will bounce back and forth a bit before they realize that the two leads are connected. Parts 3A and 3B can be attempted in any order.

3A, FOLLOWING UP THE PHOTO

If the characters recognize the neon sign they will immediately know the location where the photograph was taken. Otherwise, it will be a simple matter for them to figure out the complete name. If the players don't make the connection to the word 'Mediterranean' on their own, one of the characters can do it on an **INT** roll over 15. From there, all they have to do is check a phone book for the Lodge's address. The building across the street from the lodge will be the place that the characters are looking for.

Unfortunately for the characters, the building across the street from the Mediterranean Lodge, the Royale Apartments, appears to have burned down, effectively destroying any evidence that might have been inside. If the characters ask around, the operators of the Mediterranean or one of the bums in the area will be able to tell the characters that the Royale caught fire in the early hours of the same morning that the Axeman was hit. The witnesses will say that they saw members of the Wire Cult loitering around the building shortly before the fire started. The Wire Cult is a local boostergang heavy into radical body-piercing, self mutilation and ultra-violence. They are known to run jobs for uptown clients in return for cyberware and money. Anyone making a **Streetwise** roll over 20 will know that the Wire Cult and the Spikes are bitter rivals. (Recall that the team has evidence of a plot against the leader of the Spikes.)

If the characters can locate any former residents of the Royale, they may learn that the man in the photograph is Dmitri Lovodny, of apartment F. See *Apartment F*, below.

THE FIRE

The characters have no proof that the fire was deliberately set. The fire department has come and gone, not wanting to linger in the combat zone. They most likely didn't even bother with an inspection. Any character inspecting the wreckage and making a **Demolitions roll over 25** will, however, recognize telltale signs of arson. The alternative is to find some Wire Cultists and interrogate them. A difficult proposition.

THE WIRE CULT

The only lead the characters have on the fire is the connection to the Wire Cult. The gang members hang out at a nearby burned-out tenement building. They do not take kindly to strangers unless it is to talk business.

There are a few ways the characters might approach the Wire Cultists.

If the characters attempt to talk to the gang: They will get a very cold reception. The gang members will most likely attempt to kill or maim the characters, although they may lead them on for a while first. The Wire Cultists don't like to talk about their business dealings, and are suspicious of people who come prying around. If the characters attempt to talk to an isolated group of gang members they will find 1D6+2 Cultists. If they go the hang-out they will encounter about thirty gang members.

"YOU SKANKS ARE IN FOR A TREAT. THAT THERE'S OUR MAIN MAN, THE SKINNER. IF YOU'RE LUCKY, HE'LL ADD YOUR SKIN TO HIS TROPHY WALL. IF YOU'RE UNLUCKY, HE'LL SKIN YOU JUST FOR FUN AND LEAVE WHAT'S LEFT IN A DUMPSTER. HE'S IN A GOOD MOOD TONIGHT, SO WE THINKS YER LIABLE TO GET LUCKY!"
- WIRE CULTISTS

If the characters attempt to ambush and interrogate a few Cultists: This is a somewhat better plan. If the characters time it right, they may be able to catch a few gang members away from the main hang-out. Be forewarned, the members

never travel in groups of less than three, and the ambushed Cultists will fight bitterly. It will take an **Interrogation roll vs. the gang members' COOL roll** to pry the needed information out of an incapacitated Cultist (see below). There is a 50% chance that the characters will encounter a group of 1D6+2 Wire Cultists if they use this plan. There is a 50% chance that the party will not encounter any gang members. In that case, they will have to try another strategy.

If the characters attack the entire gang without help: They will die. There are thirty Wire Cultists at the hang-out, and they are tough and vicious.

If the characters enlist the help of the Spikes: The characters may remember that they have evidence of a plot against the leader of the Wire Cultists' rival gang, the Spikes. They won't know why the Axeman had this information; it might have been part of another case. Nevertheless, it could be a useful tool. The Spikes hang out in a warehouse loft a few blocks away from the Cultists' base. The Spikes have no love of outsiders either, but they will listen to the characters as long as they're reasonably diplomatic.

If the party plays their cards right they will get an audience with Laugher, the leader of the Spikes. If the characters explain the nature of their visit before they play the tape anyone making an **Awareness/Notice roll over 20** will notice one of Laugher's lieutenants slipping out of the chamber while everyone else is playing close attention. Laugher will react violently when he hears the male voice on the tape, and he will order the seizure of the lieutenant, who's handle is Savage. If the characters play the tape without preamble, Savage will try to flee as soon as he recognizes the tape. If the characters stick around long enough for gang justice, they will learn that Savage was plotting with a woman named Violet Ryker to eliminate Laugher and step into his shoes as leader of the Spikes. The Spikes would then become a tool of Diverse Media Systems, Ryker's employers. Laugher will have Savage killed. He will then offer his help to the characters in repayment. The Spikes are always ready to launch a hit on the Wire Cultists.

With the help of the Spikes, the characters will be able to launch an effective attack against the Wire Cultists, and it will be easy for the party to nab a stray Cultist

for interrogation. The Spikes may even agree to bring one back, freeing the characters to pursue other business. Once again, an **Interrogation roll vs. the gang member's COOL roll** will reveal what the characters wanted to know (see below.)

THE ROLE OF THE WIRE CULTISTS

If the characters successfully interrogate a Wire Cultist, they will learn that the Cultists were hired by a nameless man to burn down the Royale Apartments. The specific target was apartment F on the third floor. If necessary, the whole building was to be razed. The man did not say why. The Wire Cultist will describe the man who hired them as tall and thin, with black hair. He had a long scar running from behind the left ear to the right collarbone, like someone had once tried to cut his throat. The fire was to be set as soon as possible. Payment was 3000eb. The man who did the dealing for the Cultists was their leader, a man called the Skinner.

APARTMENT F

At this point, if they haven't done it already, the characters will want to find out who was in Royale apartment F. A little research will reveal that it was a man named Dmitri Lovodny. That ties the photograph to the name on the 3x5 card. The characters may also find out that Dmitri was not around for the few days preceding the fire. Before that he worked feverishly in his room, day and night, for several weeks. During that period he rarely saw anyone.

3B, IRINA LOVODNY

If the characters follow up the 3x5 card, they have a name and an address to work with. If the characters have already followed up the photograph, they will know that Irina Lovodny is related somehow to the man in the picture. They will not know how this connection is relevant to the case.

The address is in a neighborhood that is nominally part of the Combat Zone, but is not as bad as the burned out areas just south of the freeway. It is populated with low income families and individuals who aren't violent, but can't afford to live north of the freeway or in the suburbs. The house is a run down single-family dwelling built in a pseudo-Spanish style and painted a disturbing banana yellow.

The Gang Hang-Outs

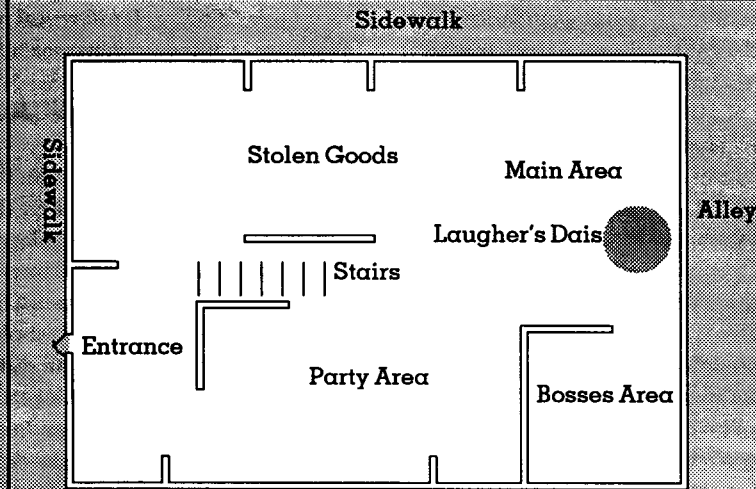

The Wire Cullist Hang Out
Most interior walls have been torn out. The dais is where Laughers displays gang justice. Upstairs are rooms for sex and sleep.

Spike's Warehouse

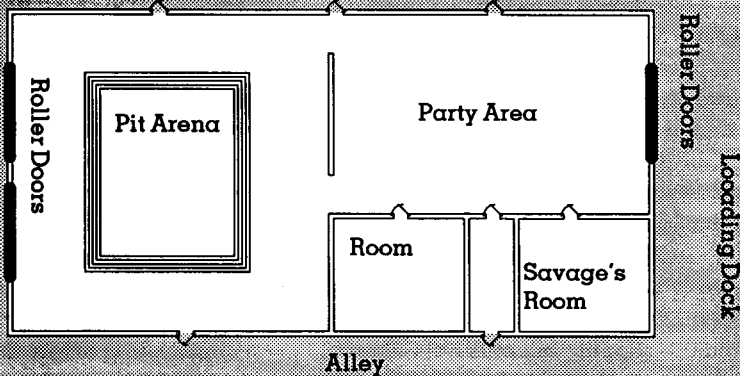

If the characters knock on the door: There will be no answer.

If the characters visibly wait outside the house: No one will enter or exit the house. About every fifteen minutes, some kids will pass by the front of the house singly or in pairs. Anyone making an Awareness/ Notice roll over 15 will notice that it appears to be the same group of teenagers going back and forth. After about an hour, the characters will be confronted by the teenagers. See below.

If the characters stealthily stake out the house: No one will enter or exit the house. As above, kids will periodically pass by the house every ten or fifteen minutes singly or in pairs. Once again, anyone making an Awareness/Notice roll over 15 will realize that it is the same group of ten kids going back and forth. If the characters wait long enough, they may realize that every time the kids pass in front of Irina's house, they look in the windows and check the surrounding street and parked cars. Have the kids roll Awareness/Notice vs. the characters' Hide/Evade. If the characters win, they remain invisible. If the kids win, see below.

If the characters break into the house: Although the house looks peaceful from the outside, it has already been ransacked by someone. Drawers are open and the contents strewn about, and cabinets have been emptied. It appears that no one has been in the house for a couple of days. Anyone making an Awareness/Notice roll over 20 will discover a photograph of a young woman and a young man together. The two look similar, like siblings. The characters will recognize the man as the same one in the photograph they recovered from the Axeman's safe. After the characters have been in the house for a couple of minutes they will be confronted by the youths. See below.

What the characters don't know is that Irina Lovodny's house has been staked out by a group of local teenagers. Irina did a lot to support the local street kids, and they have rallied to her in her time of crisis. Once they realize that the characters have taken an interest in Irina's house they will confront the party. They want to know if the characters have anything to do with the persecution of Irina Lovodny or the disappearance of her brother. There are twelve boys and girls, ages fourteen to twenty. They carry

THE GANG MEMBERS (SOLOS)

These are general stats that can be used for all of the boostergang members in this adventure. Laughers and Skinner may have slightly higher stats.

Stats: INT 5, REF 9/7, TECH 5, COOL 7 to 10, ATTR 5, LUCK 5, MA 10, BODY 8 to 10, EMP 8/3, SAVE 8 to 10, BTM -3 to -4

Skills: Combat Sense 4, Intimidate 6, Streetwise 5, Awareness/Notice 3, Hide/Evade 4, Brawling 7, Dodge and Escape 6, Handgun 4, Rifle 4, Submachinegun 4, Melee 6, Driving 5.

Cyberware: All have Basic Processors, Chipware Sockets and Interface Plugs. Almost all have some sort of reflex booster and Cyberoptics. Most have cyberlimbs and Rippers or Wolver. Many have built in weapons. A few have body plating.

Gear: An assortment of all imaginable firearms and melee weapons. Mostly inexpensive street stuff. Most have armor jackets and leather pants.

only metal knives and clubs, and possibly a couple of polymer one-shots, but they have an attitude and a lot of confidence.

If the characters reason with the kids: The kids are lead by a young man named Miguel. He will do the talking for the youths. He will be skeptical of the characters, but the party should be able to persuade him of their good intentions. He will explain that Irina is in hiding. He will agree to take two of the characters to meet with her.

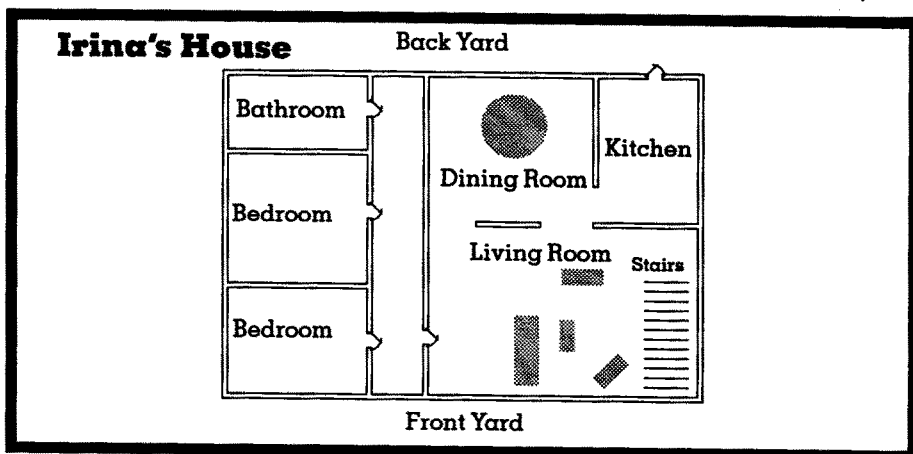

"YEAH, I KNOW WHERE SHE IS MAN, BUT, UH, SHE DON'T WANNA SEE NOBODY, YOU KNOW. SHE'S HAVIN', LIKE, A REALLY BAD WEEK, MAN. WHY DONTCHA TRY A POST CARD."
- MIGUEL

If the characters get into a fight with the kids: The characters will waste the kids. They'll feel guilty for days, and they'll dry up one of their leads.

"I'M SCARED. FIRST MY BROTHER, THEN MR. MANKIEVICZ. THESE CHILDREN ARE ALL I HAVE LEFT. IF SOMETHING HAPPENS TO THEM, I'LL HAVE NOTHING."
- IRINA LOVODNY

THE FINAL CLUE

At this point, the characters know what Dmitri Lovodny was creating, and they can probably guess why he has disappeared and why the Axeman was hit and his and Irina's places searched. Someone is covering their trail. The only thing the characters don't know is who is behind all the chaos. They need one final clue. Irina can provide them with that clue, although she may not know it. (The characters will have to ask the right question before Irina can give them the final piece of the puzzle.)

The secret is in something that Irina did not think worth mentioning to the Axe. The night she had dinner with Dmitri, he gave her a locket with his picture inside. He said if he was ever gone that she could turn to the locket for strength because he

would always be inside it. If the characters check the locket, they will find a ten digit number scrawled on the back of the tiny photograph. A Netrunner will recognize it as a subgrid coordinate for the Net.

Note: If the characters do not connect with the locket clue, have Irina mention it in the course of her conversation with the players. Also, if they don't think to look behind the picture, an Awareness/Notice roll over 22 will turn up the hidden number.

PART FOUR: INTO THE NET

The next logical step will be for the team Netrunner to check out the subgrid coordinates in the locket. The coordinates turn out to indicate a point adjacent to the Infocomp Corporation's Night City data fortress. On casual inspection, the coordinate looks like part of the Infocomp fortress, but if the Netrunner makes an INT roll over 15 he or she will see that, on closer inspection, it is really a separate,

small fortress linked to its neighbor by a narrow conduit. Another INT roll over 15, and the Netrunner will realize that the external configuration of the little fortress matches the structure detailed on the printout that the characters obtained from the Axeman's safe.

THE LEECH

If the Netrunner cracks into the little fortress, he or she will be able to get a closer look at the internal workings. It is definitely the fortress detailed on the papers taken from the Axeman's safe. If the Netrunner has taken the time to study the plans, he or she will be at a great advantage. The 'Runner must make an INT roll over 13 to know the contents of each space encountered in the fortress. A similar INT roll will allow the 'Runner to proceed directly to any spot in the grid without interference. Be forewarned: the Netrunner will still have to use the appropriate programs to crack Data Walls and Code Gates and to elude any black programs triggered.

THE EVELYN STREET KIDS (NOMADS)

These are the street kids looking after Irina Lovodny. They are a ragtag group, and represent no serious threat to the characters.

Stats: INT 7, REF 5 to 8, TECH 4, COOL 7 to 10, ATTR 7, LUCK 6, MA 10, BODY 4 to 8, EMP 9, SAVE 4 to 8, BTM 1 to 3

Skills: Family 2, Streetwise 4, Persuasion and Fast Talk 3, Awareness/Notice 5, Hide/Evade 6, Braving 3, Melee 2, Handgun 1, Rifle 1, Submachinegun 1, Stealth 6

Cyberware: None

Gear: Metal blade knives, clubs, baseball bats, some scrounged leather and high-tech armor. Polymer one-shots.

IRINA'S STORY

The Evelyn Street Kids are hiding Irina in the old tenement building in which they live. They have been providing food for her, and watching her house. If the characters saw the photo in her house, they will recognize her as the girl standing with the young man from the first photo (whom the characters may already know as Dmitri Lovodny).

How Irina responds to the characters will depend on what they tell her. She is eager for news of her brother, and if the characters tell her about his apartment being burned down she will be devastated. If the characters tell her that they are trying to track down the people responsible for hospitalizing the Axeman, she will be more at ease. One way or another, she will tell the characters her side of the story.

Irina's brother, Dmitri, is a hot Combat Zone Netrunner. He was hiring his services out freelance for some time. A few weeks ago he was hired to do a big project for a local Corp. Apparently, it was the biggest contract he had ever received. He refused to say who he was working for or discuss the nature of the assignment. He was excited by the job, and he worked furiously on it for several weeks. One evening, he called Irina to say that he was completing the project. He was going to meet her and take her out to dinner to celebrate before installing the final elements the follow-

ing morning. They spent a pleasant evening together. Dmitri seemed a little agitated, but she put that down to his excitement over completing the biggest job of his young career. He dropped her off at home late that evening.

She never heard from him again. That was a week and a half ago.

Four days after Dmitri disappeared, Irina hired Axel Mankievicz, the Axeman, to look for him. Axel had grown up a street urchin, much like the children she took under her wing, and she thought she could count on his help. Axel worked on the case for five days before things went awry. Three days ago, in the middle of the night, Irina was called away for a medical emergency when one of the kids was hit by a car. When she returned to her house with some of the other children, she found that the place had been ransacked. Irina and the children fled to the tenement, and she tried to reach the Axeman only to find that he had apparently been murdered. She has been in hiding ever since, not knowing what to do.

The clues that the characters recovered from the Axeman's office were all things that Irina had passed on to help him with his investigation. The photo was just so that the Axeman could identify her brother. The papers and disks were things that the Axeman must have picked up at the Dmitri's apartment before it was burned down.

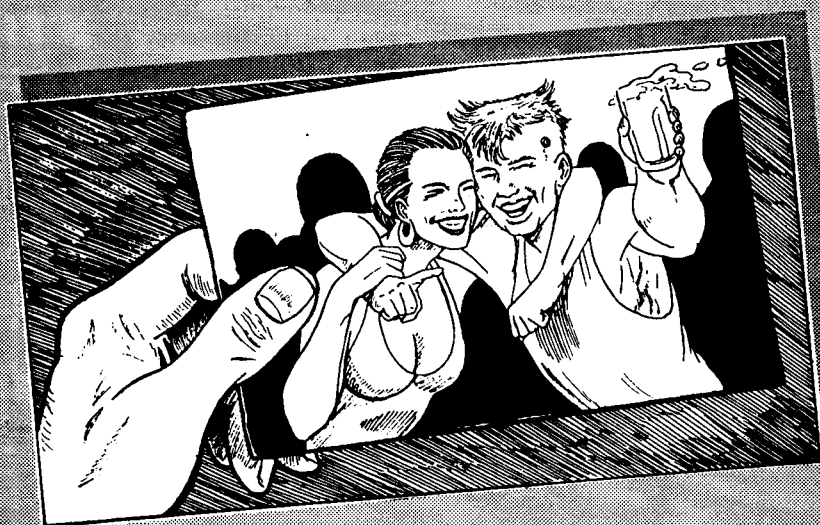

A SCENE OF BETTER TIMES—OR THE FIRST LINK IN A CHAIN?

The purpose of the little fortress is to allow someone to remove sensitive data from the Infocomp memory banks and transfer it out of the Infocomp system with no record of the transaction showing up anywhere. It's a leech for stealing information. The interesting thing is that the leech *must be operated by someone who has access to the main Infocomp computer*. If the characters don't figure it out on their own, an **INT roll over 20** will allow them to deduce the purpose: someone in Infocomp is undercutting their own company. Normally, all information access in Infocomp is strictly controlled and monitored. Also, employees are not allowed to privately sell company information; they must go through the company. Someone is bucking the system, copying valuable information while leaving no record of access, presumably to sell it directly for pure profit while bypassing company records and controls. It's a neat and potentially very profitable operation. Dmitri Lovodny must have created this system for someone, and then been eliminated to destroy the connection.

Unfortunately, from the layout of the system, it's impossible to tell who's using the leech. All the characters know is which company is involved. If, however, they have traced the original photograph of Dmitri Lovodny they will have the description provided by the Wire Cultists: a tall man with black hair and wraparound scar on his neck. If the Netrunner cracks into the main Infocomp data fortress and scans the personnel records, he or she will be able to locate the person matching that description. Unfortunately, the Netrunner has no map of the main Infocomp data fortress. Wing it, cowboy.

PART FIVE: VENGEANCE FOR THE AXE

The man with the scar is named Justin Severick. He is personal security director and bodyguard for Infocomp Regional VP Edison Wright. It is possible that Severick set up the scheme, but it is much more likely that Wright masterminded it and Severick is merely his enforcement tool. It would be much easier and more logical for Wright to set up the scheme with Severick's help than for Severick to engineer it without his boss' knowledge. The employee files list both Severick's and Wright's addresses. Although he has his own place, Severick usually lives with Wright.

GETTING PROOF

If the Netrunner stakes out the leech, it will become obvious that whoever is accessing it is doing so from a cellular terminal to avoid being traced. All usage happens while Edison Wright is out of the office. If the characters stake out Edison Wright at home or on the road they will indeed discover that he is using a cellular computer deck at the same time as the leech CPU shows activity. That should be all the proof that the characters need. Of course, staking out Wright could prove problematic. He is almost always accompanied by his eagle-eyed bodyguard Severick and two to four of Severick's men.

If the characters stake out Wright at home: Wright lives in a walled estate in the

IRINA LOVODNY (TECHIE)

Irina is a pretty young lady known for her philanthropy toward the Combat Zone children. They think of her as an older sister, which she might be considering her youthful age of 24.

Stats: INT 8, REF 6, TECH 9, COOL 7, ATTR 10, LUCK 8, MA 8, BODY 7, EMP 9/7, SAVE 7, BTM -2.

Skills: Jury Rig 5, Streetwise 6, Seduction 3, Persuasion and Fast Talk 3, Awareness/Notice 5, Hide/Evade 3, Russian (Native), English 7, Athletics 4, Brawling 3, Handgun 5, Melee 2, Stealth 3, Driving 4, First Aid 6.

Cyberware: Basic Processor, Chipware Socket, Interface Plugs, Data Term Link.

Gear: Varies.

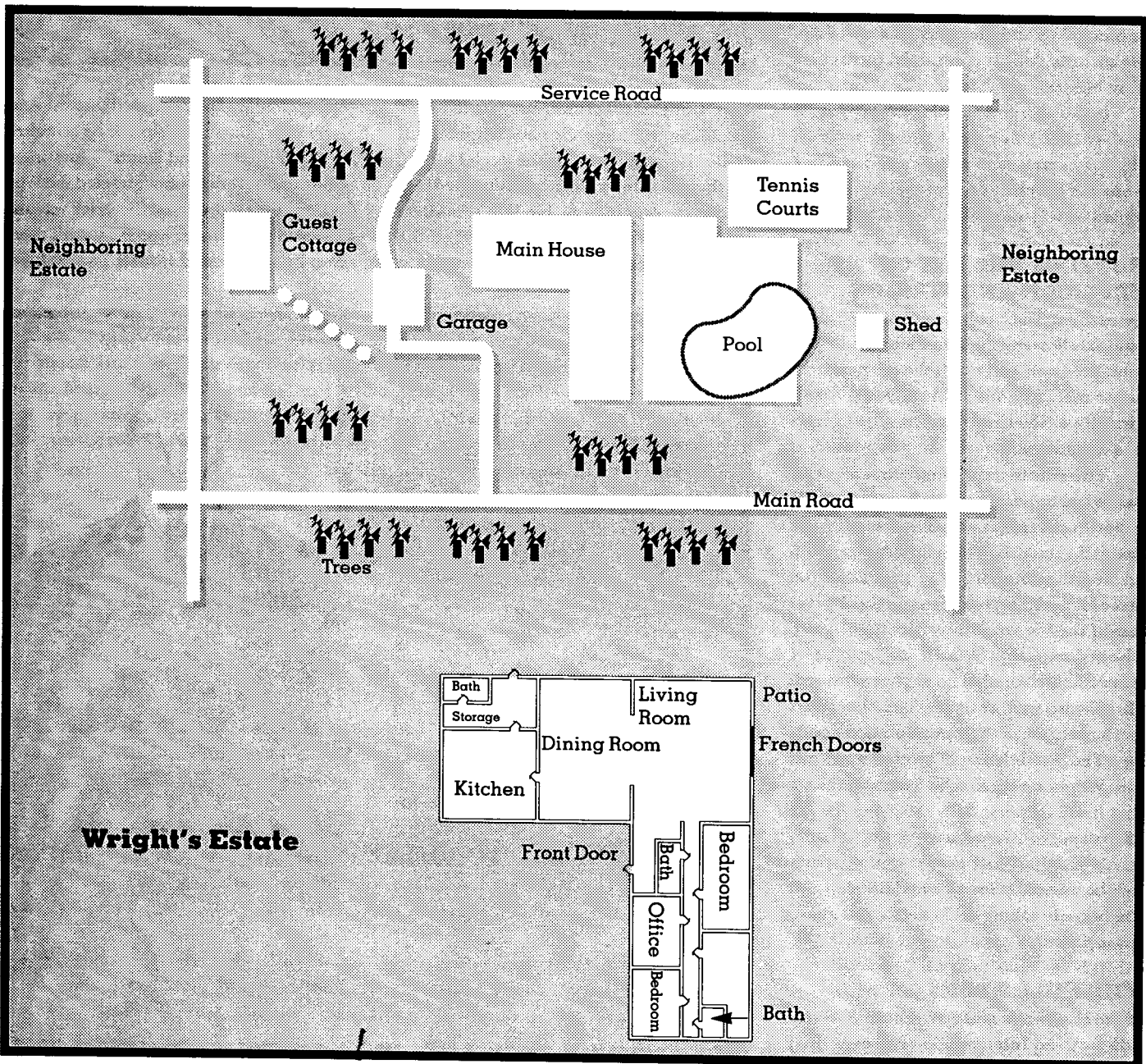

Night City suburb of Pacifica (see *Night City Sourcebook*). Getting by the walls of the compound will require an **Electronic Security roll over 25** and **Athletics over 15**. Better put in some prep time. Coming through the gate requires **Electronic Security over 25** and **Pick Lock over 25**. If the characters want to get into the house itself without being detected they will need an **Electronic Security roll over 22** and a **Pick Lock roll over 20**. They may not want to do this until they are ready to make their move. Characters should be on their guard, as Severick and 1D6 of his men will patrol the grounds regularly. If the characters are clever they may be able to stake out Wright's office from a tree or other elevated point outside the grounds, but they will need telescopes or binoculars and they must beware of roving security patrols contracted by Pacifica from Militech.

If the characters stake out Wright on the road: They will need to roll **Shadow/Track vs. Severick's Awareness/Notice**. If Severick notices that he is being trailed he will warn his boss and bolt.

PUTTING THE HIT ON SEVERICK AND WRIGHT

Once the characters have proof, they need only to follow through on their promise to John Freeman and teach the perpetrators not to mess with the fraternity of the Forlorn Hope. There are two ways the characters can do this.

The subtle way: The characters can deliver proof of Wright's betrayal to his superiors at Infocomp. The benefits are that Wright will be permanently discredited, and the company may undertake the task of liquidating him, freeing the characters of the responsibility. It's also elegant. The risks are that Wright may escape or successfully claim that he has been framed. He will also want revenge. The characters will have to make their presentation good.

The unsubtle way: The characters can bust Wright up personally. The benefits are that it will be personally satisfying for the characters, and they can wring the full story out of Wright. The risks are that the party may be wasted by Severick and his men. See the housebreaking skill checks and guard stats above.

THE FULL STORY

If the characters make Wright or Severick talk (with an **Interrogation roll over their**

EDISON WRIGHT (CORP)

Edison Wright is the Corp responsible for setting up the leech, killing Dmitri Lovodny, and attempting to kill the Axeman.

Stats: INT 10, REF 6, TECH 5, COOL 9, ATTR 7, LUCK 5, MA 6, BODY 7, EMP 7, SAVE 7, BTM -2.

Skills: Resources 7, Personal Grooming 4, Wardrobe and Style 5, Leadership 3, Social 5, Persuasion and Fast Talk 5, Accounting 5, Awareness/Notice 4, Expert: Infocomp 7, Driving 4, Handgun 5.

Cyberware: None.

Gear: Varies. Carries a cellular computer terminal (not a cyberdeck).



COOL or **Resist Torture/Drugs rolls**) their suspicions will be confirmed. Wright hired Dmitri Lovodny to create the leech for him. He then had Dmitri killed and dumped into the bay to cover his trail. He didn't count on Dmitri's sister hiring a PI. He ordered the hit on Axeman when the detective started

getting close. He also ordered that the Axeman's office and Irina's place be searched for stray evidence, and Dmitri's apartment be burned. Severick subcontracted the Wire Cult to commit the arson. Severick was also supposed to kill Irina, but she wasn't there when he went to her house. They waited,

JUSTIN SEVERICK (SOLO)

Severick is Wright's personal bodyguard and chauffeur. He is tough, smart and ruthless. He is personally responsible for the death of Dmitri Lovodny and the attempt on the Axeman.

Stats: INT 9, REF 10/11, TECH 6, COOL 10, ATTR 6, LUCK 3, MA 10, BODY 3/10, EMP 8/5, SAVE 10, BTM -4.

Skills: Combat Sense 7, Interrogation 6, Intimidate 5, Leadership 4, Awareness/Notice 7, Streetwise 5, Hide/Evade 5, Shadow/Track 5, Athletics 4, Karate 4, Driving 6, Melee 6, Handgun 6, Rifle 5, Submachinegun 6, Stealth 5, Electronic Security 5.

Cyberware: Basic Processor, Chipware Socket, Smartgun Link, Vehicle Link, Interface Plugs, Adrenal Booster, Skin Weave, Muscle and Bone Lace, Basic Cyberoptic, Targeting Sight, Low Lite™, Times Square Marquee, Teleoptics, Rippers.

Gear: SP 14 armored long coat, monoknife, smartchipped Armalite 44 with four magazines, smartchipped Arasaka WMA (Minami) submachinegun with four magazines, radio transmitter.



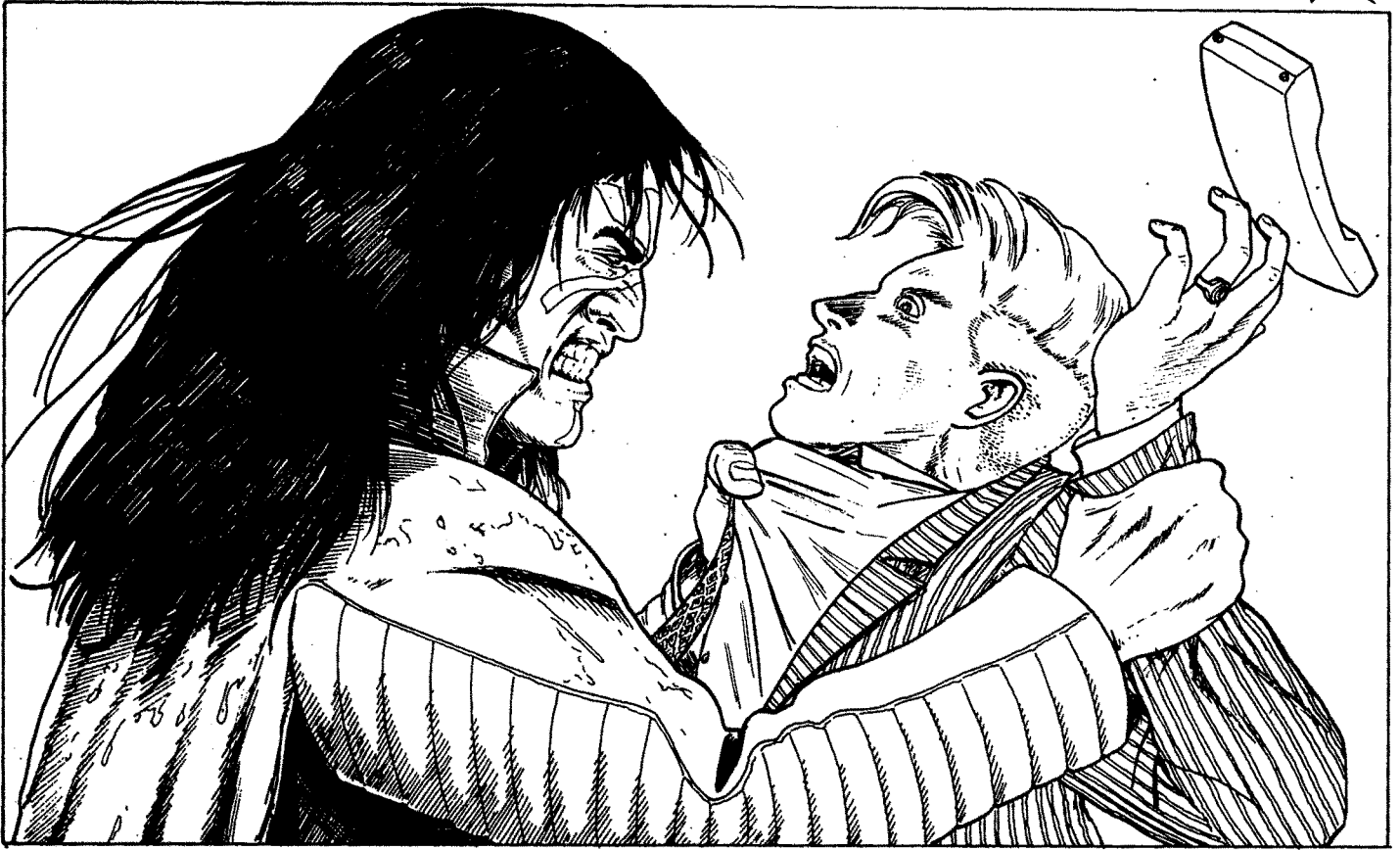

"Listen, suit, there's two things you can do—nothing—and like it!"

but she returned with too many people to make killing her worth the risk of being identified. Dmitri suspected, correctly, that he was being watched at the end. Hence his hidden paranoia, and his secret gift to his sister on the night before he was killed.

CONCLUSION

Once the characters have discredited or killed Severick and Wright, they have accomplished their mission. There is vengeance for the comatose Axeman. In the process, they have helped clear up a mystery for Irina Lovodny. The only downer is that it was too late to save her brother. On the positive side, the Axeman will emerge from his coma a few

days later, and the doctors will predict a full recovery. He is in the characters' debt.

OPTIONAL EPISODES

- ✦ The surviving Wire Cultists are out for vengeance. They want to find the uptown skanks who set them up, possibly with Violet Ryker's help (see below). The characters had better look over shoulders on a regular basis.
- ✦ Violet Ryker of DMS is itching to find the people who destroyed her plot to subjugate the Spikes as her personal hit squad. The characters are thrown into an unlikely alliance with the boosters as they face a vicious corporate enemy. Can be combined with the previous episode.
- ✦ Wright and/or Severick escapes. The characters must pursue him/them, possibly internationally.
- ✦ Dmitri Lovodny isn't dead, just in hiding. The characters learn this when they interrogate Severick and Wright. Now they must locate the young man. ✦

SEVERICK'S MEN (SOLOS)

These are Severick's assistants. There will always be 1D6 of them accompanying Severick and Wright.

Stats: INT 7, REF 10, TECH 5, COOL 10, ATTR 6, LUCK 5, MAB, BODY 9, EMP 8/3, SAVE 8, BTM -3.

Skills: Combat Sense 5, Intimidate 3, Streetwise 3, Awareness/Notice 5, Hide/Evade 4, Shadow/Track 4, Athletics 3, Dodge and Escape 2, Karate 3, Handgun 5, Rifle 5, Submachinegun 5, Driving 3, Stealth 4.

Cyberware: Basic Processors, Chipware Sockets, Interface Plugs, Smartgun Links, Kerenzikov level 1, Basic Cyberoptic, Targeting Sights, Low Lite™, Possible Cyberlimbs.

Gear: SP 14 armored long coats, monoknives, smartchipped Militech Avenger pistols with four magazines apiece, smartchipped Arasaka WMA (Minami) submachineguns with four magazines apiece, radios.

THE FORTRESS AND THE LEECH

Although the Infocomp computer has several processors, it is not an AI. The computer systems of each section are linked by the data fortress, but they are discrete elements.

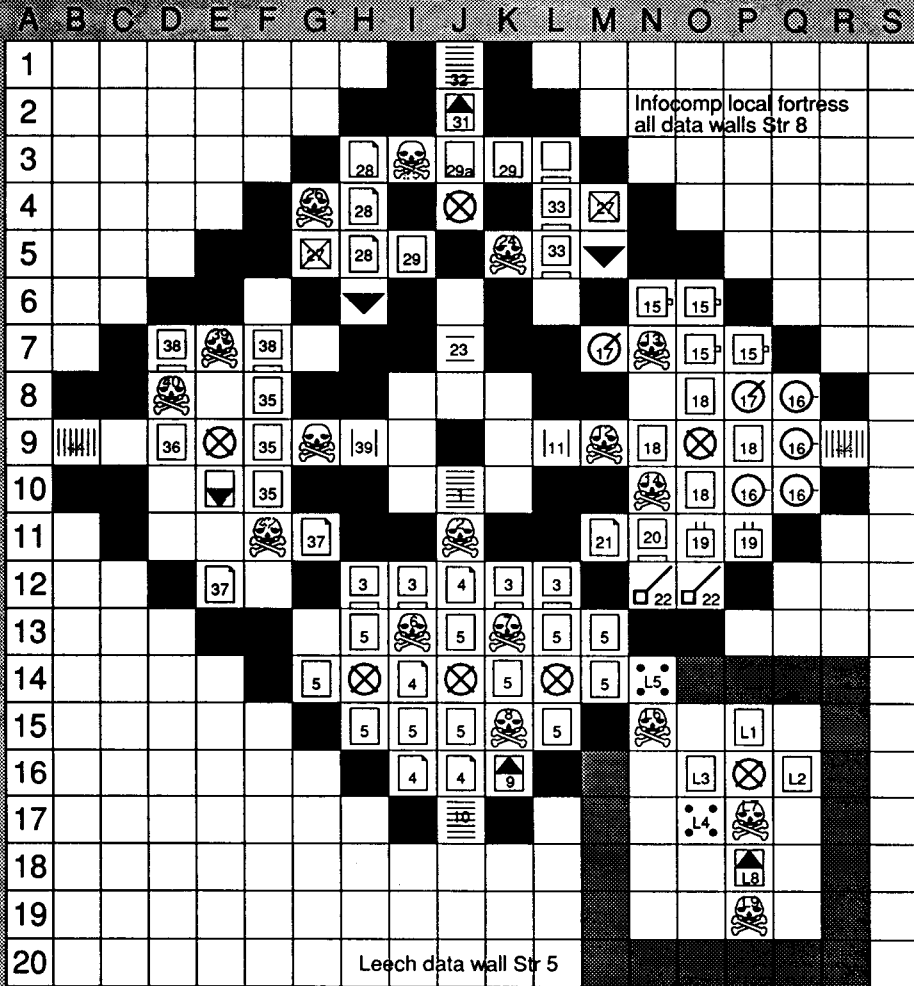

- L1. Leech Memory
- L2. Leech Memory
- L3. Leech Memory
- L4. Leech Special Program: Accesses data silently and transmits
- L5. Leech Special Program: Simulates Datawall, hides info transfer
- L6. Watch Dog
- L7. Hellbolt
- L8. Long Distance Link. Cellular transmission to Wrights cellular terminal
- L9. Zombie

- 1. Code Gate Strength 6
- 2. Zombie
- 3. Secure Access Terminals (Multiple)
- 4. Secure Access Printers (Multiple)
- 5. Database Memory (Proprietary)
- 6. Hellhound
- 7. Dragon
- 8. Watch Dog
- 9. Long Distance Link to Infocomp HQ, Los Angeles
- 10. Code Gate Strength 7
- 11. Code Gate Strength 2
- 12. Hellhound
- 13. Hellbolt
- 14. Bloodhound
- 15. Security Cameras for Office Building (Multiple)
- 16. Security Microphones for Office Building (Multiple)
- 17. Building & Computer Alarms
- 18. Security Data & Programs
- 19. Elevator Control
- 20. Security Terminals (Multiple)
- 21. Security Printers (Multiple)
- 22. Building Doors & Gates (Multiple)
- 23. Code Gate Strength 2
- 24. Firestarter

- 25. Bloodhound
 - 26. Knouckout
 - 27. Video Boards (Multiple)
 - 28. Records Printers (Multiple)
 - 29. Company Programs & Records Files. 29A=Personnel Records
 - 30. Hologdisplays (Multiple)
 - 31. Long Distance Link to Infocomp HQ, Los Angeles
 - 32. Code Gate Strength 7
 - 33. Records Printers (Multiple)
 - 34. Code Gate Strength 2
 - 35. General Company Programs & Memory & VR
 - 36. General Company Memory & VR
 - 37. General Printers (Multiple)
 - 38. General Terminals (Multiple)
 - 39. Dragon
 - 40. Watchdog
 - 41. Glue
 - 42. Sword
 - 43. Long Distance Link to Infocomp HQ in Los Angeles
 - 44. Code Gate Strength 7
- This system is an AI. Stable, Intelligent & Businesslike.
Int 18

TALES FROM THE FORLORN HOPE #7

In this adventure, the characters must fight to help Nails, the young Federal Marshal, clear the name of her friend and partner, Gunsights. Gunsights has been framed and arrested at the order of a crooked Night City police captain. Nails has found a man who can clear 'Sights, but the corrupt commander is on to her and plans to use his men and Organized Crime connections to do whatever is necessary to prevent Nails from delivering her witness into the custody of the Marshals.

This adventure can be run with any type and number of characters, but there will be a lot of combat and the party will be facing tough odds. If the party doesn't have a fair amount of muscle, beef it up with NPCs from the Forlorn Hope.

PART ONE: A KEY WITNESS

It is an uncharacteristic evening at the Forlorn Hope: the bar is closed. The Professor, Marianne and Dollar Bill are out of the country for a couple of days. All three are attending the funeral of an old friend in Brazil. Ringo and Godiva usually manage the Hope when the Freemans are absent, but with the management so far out of touch, the Professor has decided to close the bar. The building will continue to serve its normal boarding purposes and the ripperdoc clinic and weapons shop will be open, but the main room will not be doing business for four days. Most of the waiters and waitresses are on leave, but Icepick and Trigger are on duty and the other regular building residents are still around. Ringo and Godiva are occupying the fourth floor suites until Dollar Bill and the Freemans return. All management problems are to be referred to them.

Unfortunately, this holiday is not going to be very restful. The first clue to the impending chaos will come when the char-



TOUGH AS NAILS

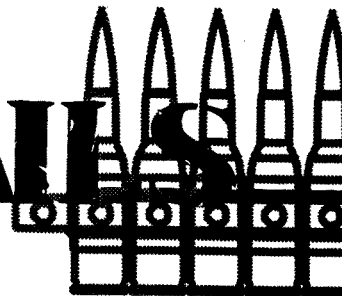

acters encounter a rumor. Everyone is kicking back at the Afterlife, another Solo club popular with the gang that frequents the Forlorn Hope (see the *Night City Sourcebook* for details on the Afterlife). In addition to the characters, there are 1D10 other Hope regulars in the club. Most of the Hope people hang out together, and gossip flows much as it always does. The characters will hear all of the following gossip items:

GOSSIP

Roll randomly for the order in which items are heard:

- * Gunsights has been busted for some reason. Surprising, considering that he's a federal marshal.
- * Police activity has picked up this evening, especially in the third precinct. Increased patrols have been sighted.
- * Mob enforcers have been spotted this evening. The Mob may be out to hit someone. A Mob war may be in the offing.
- * A big shipment of drugs has come into the city this evening, and the Mob and the cops are in a race to get to it.
- * A corporation is behind rising tensions between the Mob and the cops. The corp is planning a big extraction, and it wants the cops preoccupied. Keep your eyes on downtown this evening.

As it happens, the first item is critically important and the next two are related. The last two items are red herrings. If the characters decide that none of the items effect them personally, they'd better guess again, because they're about to get a visit from Nails.

NAILS' REQUEST

Just as the characters are digesting the gossip, Nails will burst in to the level of the Afterlife that they are on. She appears excited and out of breath. Nails will scan the crowd for familiar faces, then make a beeline for the characters. She'll collapse into a seat and exclaim, "Thank god there's people from the Hope here! Have you heard about Gunsights?"

If the characters mention the rumors they've heard, Nails will reply, "Sights is in trouble, alright! I need some major help right now. I can't pay you anything, but it could be Gunsights' life. Please help me out!"

Nails seems pretty desperate, and, as the characters have built quite a reputation for themselves, it is natural that the young Marshal turns to them for help.

If the characters agree to help: Nails will say, "We've got to head for the Rainbow Nights. There's a guy there by the name of Crazy Bob that we have to see. I'll fill you in on the way."

If the characters won't help: What a bunch of shmoes. Remind them that Gunsights is a veteran of LRT-601. Anyone who bails him out is going to be able to collect big favors from any of the other veterans, including John Freeman. Favors from people like that can be worth more than money. Besides, Nails is quite pretty. Your male characters ought to be trying to make points with her.

ON THE WAY TO THE RAINBOW NIGHTS

As she is driving the characters to the Rainbow Nights, Nails will give them the details.

"Yesterday, Gunsights was arrested by the Night City police. It seems someone fingered him for drugs and the police got a search warrant for his apartment. They found a kilo of Blue Glass cut with 'Dorphs. Nothing you couldn't see in any gang pit, but Gunsights is a Marshal...a cop. He's in jail pending arraignment tomorrow. If he's convicted, he's through...for good. He'll be dead in jail inside a week. No isolation for cops anymore. Too expensive.

"You all know, and I know, that Gunsights isn't dirty. That Glass was planted in his apartment, and I know why and by whom. Recently, Gunsights and I were transferring a Federal prisoner who was part of the Cipriani crime family. The Ciprianis have been suspected of smuggling Blue Glass into Night City for some time, but only small-time runners have ever been busted. Well, the guy we were transferring knew why. He told Gunsights and me that the Ciprianis are tied into several officers at the NCPD's Third Precinct, and at least two judges. That's why they've been able to operate so long. Our request to have the guy isolated was denied, and

he was killed in prison by a former Cipriani enforcer, but Gunsights and I followed up the lead and started investigating the link between the mob and the cops. Then, yesterday, Gunsights was busted...set up by the cops.

"The thing is, I know it was a set up. I got a call a few minutes ago from an informer of mine, a guy by the name of Crazy Bob who hangs out at the Rainbow Nights. He says he's got a line on one of the guys who was paid off to plant the evidence in Gunsights' apartment. The guy wants to talk to a Marshal. All I have to do is get him to the Marshals' office...alive. That's where I need your help."

PART TWO: CRAZY BOB

By the time Nails has finished explaining the situation, the car will be nearing the Rainbow Nights. Nails will find a parking space and everyone will head inside. She will pick up the cover charge.

CRAZY BOB

Crazy Bob is an extremely tall, lanky fellow dressed in a moldy green overcoat, and sporting scruffy hair and three or four days growth of beard. His eyes are always wandering, seldom resting on the person to whom he is speaking, and he has a disjointed, somewhat confusing way of talking. He has ears like shells however, and a good memory for important items.

Nails will pay Crazy Bob the 50eb he's demanding for what he knows. Bob will tell the characters this:

"I, um...I know one of the guys who was...who was paid off to plant the Glass in Gunsights' apartment. He's holed up in, um...holed up in an abandoned church near Lake Park. He wants to talk...if, um, if you can protect him. He says two of the other guys who were paid to do the job have disappeared. He..um, he thinks that somebody's out to get him too."

The address of the church is 1345 22nd Street. The name of the man hiding there is Hubie Treadwell. Crazy Bob refuses to come along. He says it's no longer any of his business. He will accompany the characters only if they force him at gunpoint, but Nails will not want to do that, as she considers Bob an excellent informant and she doesn't want to alienate him.

22ND STREET

The Porlorn Hope is also on 22nd street, on the 200 block at the corner of 22nd and Drake. There is a mile and a half between the church and the Hope.

PART THREE: THE CHURCH

The church is on 22nd Street between University and Faren, two blocks southeast of the park. The nearest point of note is a fire station, two blocks to the east. The church is fenced off and boarded up, although many of the boards have come loose or been torn off. The only signs of recent habitation are the cast-off bottles and oil-can fire pits of the local vagrants. This is also Blood Razor turf, and the Razors' insignia has been spray-penned onto the church walls. There is no sign of the gang, however.

If the characters waltz on into the church: They will be ambushed by a young man wielding a shotgun. He is waiting for people to try to kill him, and will shoot first and ask questions later. Only if the characters identify Nails as a Marshal will he stop shooting and reveal himself as Hubie Treadwell.

If the characters stealth into the church: They must roll **Stealth vs. Hubie Treadwell's Awareness/Notice**. If the characters win, they will find a young man crouched in a corner of the upstairs loft. The man is clutching a shotgun and looks nervous and jumpy. Unless the characters are tactful he will blow his cool and start firing. If the characters lose, Hubie will ambush them as above.

If the characters try to signal Hubie from outside the church: Hubie will not reveal himself until Nails throws her badge and ID through an upstairs window so he can check it. Once he is satisfied, he will tell the characters to come on up.

HUBIE'S STORY

Once the characters have made contact with Hubie, he will tell them his story and explain why he is so paranoid, and why he refuses to deal with the regular police.

"A couple of days ago, me and two of my buddies were paid off by this guy to plant a kilo of Blue Glass in an apartment. We took the job. Yesterday, the cops raid-

ed the apartment where we planted the stuff and they busted this guy. I heard he was a Federal Marshal. One of my buddies saw the raid, and he said that the dude who paid us off *was a cop!*

"Well, I knew if we was plantin' stuff for the cops so they could bust one of their own dudes, that somethin' really big was going down. Then, yesterday night, my boys get cut down in a firefight with the cops. I wasn't there, but I know what happened. The cops went gunnin' for us 'cause they figger we can finger 'em. I shoulda just blowed town, but those guys were my friends, and I want payback. That's why I told Crazy Bob where I was, 'cause I knew he informed for the Marshals.

"I'm scared. I want protection. I'll talk if the Marshals can guarantee my safety. Otherwise, screw off."

EARLY TREMORS

As Hubie finishes up his story, have the characters attempt **Awareness/Notice rolls over 20**. If the characters have a guard outside the building, that person will see what happens without having to roll.

If the characters succeed or have a guard: They'll look out the window of the loft to see a medium-sized sedan pulling up. Any character making an **Awareness/Notice roll over 15** will see the computer terminal by the front passenger seat and the two extra antennas that clearly flag the vehicle as an unmarked police car. Five men in plainclothes will get out of the car. If the characters left Crazy Bob at the Rainbow Nights, one of the cops will be dragging him along. Otherwise, the characters will have to assume that the cops had an informer of their own at the club. It looks like Bob is an unwilling participant in the action. One of the cops will stay outside with a gun against Bob's side. The other cops will move stealthily into the church.

If the characters fail their roll: Have them make **Awareness notice rolls vs. the Cops' Stealth**. If the characters succeed, they will realize that someone is in the church. If they look out the window, they'll see the unmarked car and the one plainclothes cop who is holding Crazy Bob. If the characters fail their roll, their first warning will be when the cops burst into the room and announce that they're arresting Hubie Treadwell. They won't say why. Everyone else who is present is under arrest for sheltering a fugitive. The characters had better think fast.



ROBERT "CRAZY BOB" TYSON (FLKER)

Crazy Bob is a low echelon street hustler and information broker. He has been an informer for Nails for some time, and knows her hangouts. Bob is a wanted individual, scratching out a living on the lonely streets, but he can pick the relevant parts out of a conversation from across a crowded club. It's his only gift.

Stats: INT 5, REF 6, TECH 6, COOL 8, ATTR 4, LUCK 4, MA 9, BODY 7, EMP 9/6, SAVE 7, BTM -2.

Skills: Streetdeal 4, Streetwise 6, Persuasion and Fast Talk 6, Awareness/Notice 7, Hide/Evade 6, Brawling 3, Dodge and Escape 2, Melee 4, Pistol 3, Stealth 4.

Cyberware: Basic Processor, Chipware Socket, Basic Cyberoptic, Low-Lite™, Teleoptics, Image Enhancement, Basic Cyberaudio, Amplified Hearing, Radio Link, Phone Splice, Wide Band Radio Scanner.

Gear: SP 18 armored long coat, monoknife.



HUBERT (HUBIE) TREADWELL (STREET PUNK)

Hubie is a low-echelon Street Punk who makes his living hustling, and as a thief and informer.

Stats: INT 6, REF 8, TECH 8, COOL 7, ATTR 6, LUCK 5, MA 8, BODY 7, EMP 8/6, SAVE 7, BTM -2.

Skills: Hustle (Skill for finding quick work on the streets) 6, Streetwise 5, Persuasion and Fast Talk 6, Awareness/Notice 5, Hide/Evade 6, Brawling 6, Dodge and Escape 4, Melee 5, Rifle 4, Handgun 5, Submachinegun 3, Electronic Security 5, Pick Lock 6, Driving 5, Stealth 5, Vehicle Tech 4.

Cyberware: Basic Processor, Chipware Socket, Smartgun Link, Interface Plugs, right Cyberarm with Toolhand and Thickened Myomar.

Gear: Smartchipped Sternmeyer Stakeout 10 shotgun with 10 rounds, SP 18 armor jacket, metal blade knife, lock picking and electronic security tools.

WHAT TO DO

If Hubie sees the cops, he will point out that one of them is the one who paid him off and later busted Gunsights. If he is delivered into the custody of these cops, he's a dead man. There are other clues that these cops are acting outside of normal police procedure. Most obvious is that there is no uniformed backup. Armed with this knowledge, it is likely that the characters will fight rather than be arrested. They must remember that keeping Hubie alive is Job One. If he's killed, there is no hope for clearing Gunsights.

If a firefight breaks out, the cop holding Crazy Bob may cuff him to the car and join the fight. He may also flee in the car if it becomes apparent that his buddies have been killed. He may *not* uncuff Bob before he drives off.

Somehow, the cops also picked up on Crazy Bob and the connection to the Rainbow Nights. The characters may not figure it out unless they interrogate a surviving cop (**Interrogation roll vs. Cop's COOL**), or talk to Nails and put the pieces together, but the situation is this: Crazy Bob called Nails at the Marshals' office in the State Building (remember, California is a free state). Shortly thereafter, Nails and the characters appeared at the Rainbow Nights and talked to Bob. A few minutes after the characters left, the cops showed up. They interrogated Crazy Bob and discovered what he had told Nails. The cops knew about Crazy Bob because they have installed a sophisticated, illegal wiretap on the phone lines to the Marshals' Office. This was done on the order of Captain Geoffrey Hyman soon after the corrupt cops learned of the Marshals' investigation. (If Crazy Bob went with the characters, then the cops got to the club and talked to one of their own informers who overheard the conversation between Bob and the characters.)

If the characters don't make the connection, Nails will. She will also realize that this makes it risky to take Hubie to the Marshals' office. The cops will almost certainly have it staked out. There's only one other place where she and the characters can keep Hubie safe long enough to arrange a transfer to the Marshals: the Forlorn Hope. Normally, the Professor doesn't like people bringing their problems to the Hope, but in order to save a member of LRT-601, Nails thinks it will be forgiven.

PLAINCLOTHES COPS (COPS)

These are detectives who are in on the scam with the Cipriani. None knows much about the overall operation, but all take an under-the-table cut from their crooked commander, Captain Geoffrey Hyman, to do jobs for him and the Cipriani. Use these stats for all plainclothes cops in this adventure, but vary some weapons equipment and cyberware.

Stats: INT 8, REF 10, TECH 7, COOL 8 to 10, ATTR 7, LUCK 5, MA 8, BODY 8 to 10, EMP 8/7, SAVE 8 to 10, BTM -3 to -4.

Skills: Authority 5, Interrogation 6, Intimidate 5, Streetwise 5, Persuasion and Fast Talk 3, Awareness/Notice 6, Hide/Evade 3, Shadow/Track 7, Brawling 6, Melee 5, Handgun 5, Rifle 4, Submachinegun 5, Driving 5, Stealth 4.

Cyberware: Varies. All have Basic Processors, Chipware Sockets, Interface Plugs and Smartgun Links. Many have Cyberoptics/Audio, some have Cyberlimbs.

Gear: SP 14 armored long coats, SP 10 armored T-shirts, monoknives, short truncheons, radios, cuffs, smartchipped Militech Avenger Pistols with three magazines apiece. One officer has a smartchipped, sawed-off Sternmeyer Stakeout 10 shotgun with 40 rounds (sawed off: Con. = L, WA = -3), one has a smartchipped H&K MPK-9 with three magazines.

The Church

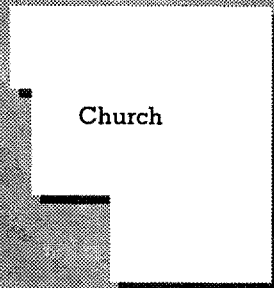
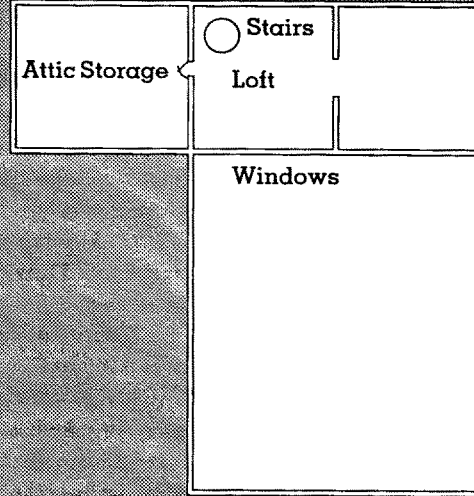
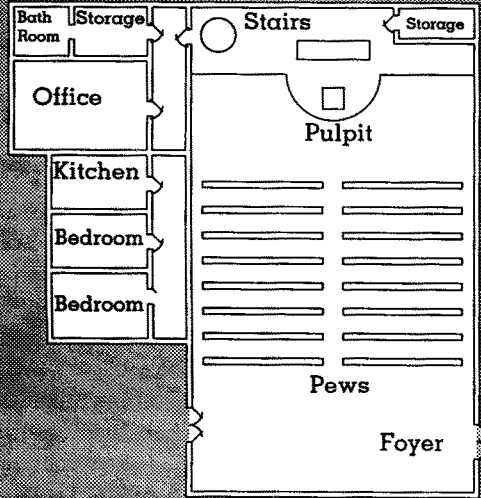

SHOOTING DOWN A GOOD IDEA

It may occur to the characters to do one of two things:

- 1) Hop in their car and head for someplace other than the Hope: If they do this, have a police helicopter shadow them. Eventually, they'll get frustrated and make for the Forlorn Hope. They can cruise the city all night and not find a safe place to rendezvous with MacGruder.
- 2) Break a Trauma Team card and let the medics bail them out: Fine. They'll get themselves in the middle of a firefight between the Trauma Team and the cops. Fun for the whole family.

PART FOUR: GETTING TO THE HOPE

The cops at the church had radios, and it's a safe bet that Hyman knows where the characters are and knows that his

team has been defeated. He's going to send a larger, better-armed force after the characters within a matter of minutes, so time is tight. The characters had better get to a more secure location (i.e. the Hope) as soon as possible. More cops will arrive 1D6+5 minutes after the firefight. (These are the same cops who will pursue the characters in the next section.)

CONTACTING SOMEONE

There are no phones at the church, so the characters can call people only if they have a cellular phone. There are no pay-phones nearby.

If they try to call another police precinct: They will be laughed off as pranksters.

If they call the Marshals office: Nails' boss is Night City Marshal Captain Christine MacGruder. MacGruder will tell the party that she has only a couple of men on hand. She might be able to get hold of an AV-4, but it will take at least half an hour. That's too long for the characters to hold out. Cops are going to be at the church in force in minutes. If the characters can get to the Hope and hold out there, MacGruder will meet them with an AV-4 as

THE UNIFORMED COPS

There are three uniformed officers in each car. They have the same stats and skills as the plainclothes officers from part 3. The difference is that one officer in each car will have a Sternmeyer Stakeout 10 and one will have an MPK-9. The officers will be firing from their cars. Also, these officers are armored differently. They wear helmets and SP 18 armor vests.

soon as she can. Beware: the phone lines at the Marshals Office are bugged! If the characters give away any information, use it against them!

If they call the Forlorn Hope: Ringo or Godiva will pick up. They will try to round up reinforcements if the characters can get there in one piece.

THE MAGIC BUS

If the characters try to take Nails' car back to the Forlorn Hope they're going to have a rough time of it. The tiny Government Daihatsu can barely seat them all comfortably, much less offer any protection or maneu-

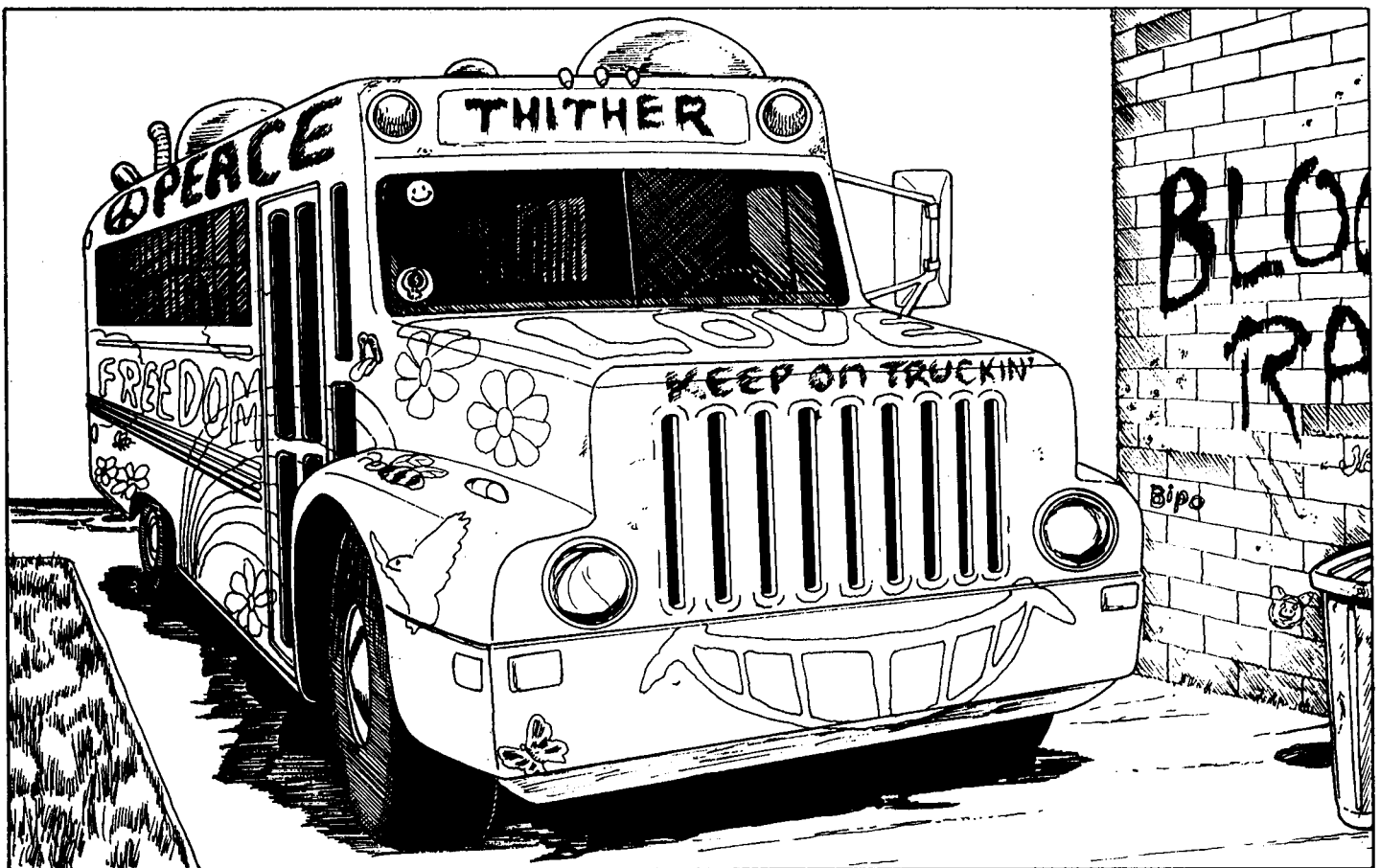

THE MAGIC BUS

A restored 1959 International Harvester schoolbus retrofitted for CHOOH2. It looks weird, but it's a lot safer than a car if the characters are going to be shooting. The size allows the characters to spread out and avoid being hit all at once, and there's plenty of room for maneuvering weapons. The bus can also soak up a fair amount of damage. Many of the seats have been torn out to make room for hammocks, tables, a little kitchen and a bathroom. There is also a wide sun roof. Powered by a V-8 CHOOH2 engine. Use the Van/Truck line in the combat tables from *Solo of Fortune* and the Truck line in the FNEF control roll modifier tables. Three axles, ten wheels.

Speed: 80mph, 20mph off-road. Safe maneuvering speed: 30mph. Acceleration: ±5mph/phase. Fuel/Range: 40 gallons/400 miles. Equipment: Stove, sink, toilet, hammocks, cabinets, two plexiglass domes on roof. Armor: Tires SP 10, SDP 15; Engine SP 25, SDP 25; Body SP 15, SDP 100; Windows SP 5, SDP 5; Interior Walls: SP 5, SDP 20.

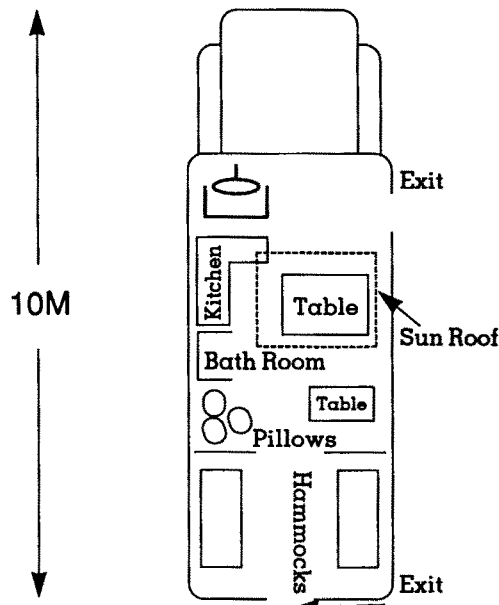

vering room for weapons. The unmarked police car out front (if it is still there) is not much better, as it lacks the armor of a marked car. Salvation is in sight, however. Across the street from the church is a commune inhabited by a gang of peace-loving hippies who can't afford to live in a better

neighborhood. (Fortunately for the hippies, the Blood Razors stick more to the Park, along 21st street.) Parked in the long driveway along one side of the house is a schoolbus that has seen better days. It has been painted in a myriad of rainbow colors, and various domes and protrusions have been welded on to the roof. Curtains obscure the windows, and where a sign over the windshield once said "Heywood High School" there is a new inscription: THITH-ER. If the players don't ask about alternative vehicles, all it will take is an Awareness/Notice roll over 18 for someone to see the bus. It won't take a great leap of intelligence to see that the dilapidated vehicle offers the characters their best chance.

If the characters make their Stealth roll: They will not be disturbed until the engine starts, at which point 1D6+4 disgruntled hippies in tie-dye and woven coveralls will come running out of the house. They have no weapons, but they will hurl many epithets at the characters, and possibly some bottles too.

If the characters fail their Stealth roll: 1D6+4 enraged hippies will come running out of the house. Peace is their credo, so they won't attack, but they might interfere or call yet more cops. It may delay the characters long enough for police reinforcement to show up. Also, the characters may have to listen to a ragged rendition of "We Shall Overcome."

THE POLICE CARS

The police are driving Toyota Saber sedans, the model normally used by the NCPD. There is space for two up front and three in the rear. A plexiglass partition with SP 25, SDP 20 divides the front and rear compartments. Powered by a turbocharged, high output V-6 CHOOH2 engine. This is the same as the unmarked car driven by the cops in the previous section, but it has more armor. Use the Sedan line on the combat tables in *Solo of Fortune* and the Standard Car line in FNEF.

Speed: 100mph, 25mph off road. Safe Maneuvering Speed: 40mph. Acceleration: ±10mph/phase. Fuel/Range: 15 gallons/400 miles. Equipment: Cybernetic link, navigation computer, alarm, radio, radar detector, cellular phone, cellular computer terminal, fire extinguisher, lat aid kit, 10 smoke grenades. Armor: Tires SP 10, SDP 15; Engine SP 20, SDP 20; Body SP 25, SDP 70; Windows SP 15, SDP 10.

**"SURE, WE CAN TAKE MY CAR, AS LONG AS YOU DON'T MIND PUSHING IT THE FINAL HALF MILE THROUGH GUNFIRE."
-NAILS**

HIJACKING THE MAGIC BUS

There are lights on in the commune, but little sign of activity. There is no one outside. The characters should make Stealth rolls vs. The Hippies' Awareness/Notice. Hot-wiring the bus will take a Vehicle Tech roll over 18 and a Pick Lock roll over 18. If no one else can do it, Hubie Treadwell has hot-wired a few cars in his day.

THE ELECTRIC CANNON ACID TEST

Once the characters hit the road, things are going to heat up considerably. Hyman has had two men in a police chopper monitoring the church from high altitude. They are going to see the characters defeat the first cops, steal the bus and leave. They will radio their observations to Hyman, who will dispatch the rest of his bent cops to intercept the characters. He will also mobilize his organized crime connections, the Ciprianis, to intercept the bus once he has an idea of its destination. Three marked police cars will move in and attack as the bus cruises toward the Forlorn Hope. Even if the characters take a back road they will be attacked by the police cars, the occupants

THE CIPRIANI GANG (SOLOS)

These are 20 enforcers from the Cipriani mob that have been sent to try to stop the bus before it reaches the Forlorn Hope. They are pretty dense, but they follow orders.

Stats: INT 5, REF 9, TECH 5, COOL 8 to 10, ATIR 7, LUCK 5, MA 8, BODY 8 to 10, EMP 7/7, SAVE 8 to 10, BTM 3 to 4.

Skills: Combat Sense 4, Intimidate 5, Streetwise 4, Social 3, Persuasion and Fast Talk 5, Awareness/Notice 5, Hide/Evade 3, Shadow/Track 4, Brawling 7, Melee 5, Handgun 5, Rifle 4, Submachinegun 5, Driving 4, Stealth 5.

Cyberware: Varies. All have Basic Processors, Chipware Sockets, Interface Plugs, Smartgun Links and Basic Cyberoptic with Targeting Sights. Some have limbs and weapons.

Gear: SP 20 armor jackets, monokines, smartchipped H&K MP-2013s with 4 magazines apiece, Federated Arms X-9mm pistols with two magazines apiece.

of which are in constant communication with the helicopter.

The characters must remember if they get into a firefight, that the key mission is to keep Hubie Treadwell alive. The bus will keep moving if the tires are shot out, but it won't steer well or go over 30mph. If the engine is destroyed, the characters will have to hoof it and hope for the best.

THE GAUNTLET

If the characters make it to within three blocks of the Forlorn Hope, any surviving police cars will suddenly peel off. Any characters looking out of the front window, the plexiglass domes, or the sun roof should attempt an **Awareness/Notice** roll over 20. Anyone succeeding will see several men with small arms lining the streets along the last block. What the characters don't see is that all the streets within a one block radius of the Forlorn Hope are similarly covered. These are men from the Cipriani crime gang. They are all armed with submachineguns. There are 20 men total. Once they know what direction the bus is coming from, they will arrange themselves so that ten of them can fire on the bus as it approaches the Forlorn Hope.

Hyman had the Ciprianis send their men when it became obvious that his cops were ineffective. Hyman can justify police combat, but he can't justify an illegal police siege, and he has already sent most of his crooked men after the characters. The Forlorn Hope is in Precinct Three territory, however, and Hyman can justify sending his surviving men to "investigate" a mob assault. Of course, the cops may take their time getting to the scene of the crime...

FIRING ON THE BUS

As the bus approaches the Forlorn Hope the men will take cover in doorways and behind mailboxes and draw beads. As soon as the bus is within close range (DIFF 15), they will all open fire. All will be firing on full auto. Make attack rolls to see how many rounds hit the bus. +4 for large target, +3 for 30 rounds at close range, +3 for smartguns and targeting scopes, +1 Weapons Accuracy for their guns. Some of the gangsters may fumble. All the characters inside the bus must make **REF** rolls vs **Suppression** fire. The bus is 10m long. Now they'll be glad they didn't try to use the 4m Government Daihatsu or the 5m unmarked police car.

Example: The 10 firing gangsters have REF 9 and Submachinegun 5. They have +11 in modifiers. $9+5+11 = 25$ base vs. difficulty 15. If none of them fumble, 10×10 (100) rounds automatically hit the bus. If the gangsters roll 7, 3, 5, 9, 2, 4, 6, 7, 2, 10, for a total of 55; $100+55$, or 155 rounds hit the bus. $155\text{rds}/10\text{m} = 15.5$, rounded to 16. Every character in the bus must make a REF roll over 16, or take 1D6

rounds. The body and inside walls of the bus may soak up some damage (50% chance per round hitting a character).

Notes: Normally, the characters could add their athletics skill to a suppression Save, but because the bus is enclosed and moving, the characters will not get that advantage in this situation. Any character lying down will get a +3 to their Save, however. The gangsters are aiming for the passenger compartment, not the tires or engine. Nonetheless, there is a 50% chance of the engine taking 1D6 rounds, and each tire has a 10% chance of taking a round. Also, the characters may use other vehicles as outriders, running interference for the bus, but the Ciprianis will still concentrate their fire on the bus.

SIEGE

If the characters make it into the Forlorn Hope with Hubie Treadwell still alive, they will have to hold out long enough for Christine MacGruder to get there with her commandeered AV-4. MacGruder will arrive at the Hope 1D6+5 minutes after the characters. She will order her pilot to head for the roof. She can't land on it, but she can hover long enough for the characters to get Treadwell and Nails aboard. MacGruder's AV-4 will be accompanied by several carloads of good cops from Precinct Two. The cops will deal with the Cipriani mobsters while MacGruder picks up Hubie (see below).

The characters will have to hold off at least one massed attack from the mobsters while they wait, but they will not be alone. Godiva and Ringo will both be on hand, as will a few other people. Possible other Hope people on hand include Icepick, Trigger and Needles the Ripperdoc (50% chance each). There may also be one or two other Solos who are boarding in the third floor rooms. With any luck, the characters will be able to hold out. The Hope was designed to withstand attacks.

Note: See the **The Forlorn Hope** section for a map of the building and NPC stats.

THE SATIN DOLLS

If things go badly for the characters, or they are heavily outnumbered, all is not lost. There is an all-female street gang that claims part of the area around the Forlorn Hope as its territory: the Satin Dolls. The Dolls started as a womens' protective, and gradually evolved into a combat gang. The

THE SATIN DOLLS (SOLOS)

A womens' combat gang that hangs out at the Forlorn Hope. They will appear if the characters need quick reinforcements. The Dolls do occasional work for Bill, and they turn over good work as bodyguards for Rockerboys and media celebs. Currently, it's all the rage in Night City to have a Satin Doll bodyguard. Heavy into biosculpting and Bioware.

Stats: INT 9, REF 10/11, TECH 6, COOL 10, ATTR 11, LUCK 5, MA 9, BODY 7 to 9, EMP 9/7, SAVE 7 to 9, BTM -2-3.

Skills: Combat Sense 6, Wardrobe and Style 6, Streetwise 5, Seduction 5, Awareness/Notice 7, Hide/Evade 5, Athletics 4, Dance 6, Motorcycle 6, Handgun 6, Submachinegun 5, Rifle 5, Aikido 6, Stealth 4, Weaponsmith 3.

Cyberware: Varies. All have Basic Processors, Chipware Sockets, Interface Plugs, Smartgun Links, Basic Cyberoptic, Low-Lite™ and Targeting Sights. Most have Adrenal Boosters and some sort of Fashionware, such as Techhair, Light Tattoos and such. Many have Skinweaves and Muscle and Bone Lacing. A few have Scratchers or Rippers.



Gear: SP 20 armor jackets, monoknives, smartchipped Sternmeyer Type 35 pistols with three magazines apiece. Half have Arasaka WMA (Minzumi) submachineguns with four magazines apiece.

Dolls have a good relationship with the Forlorn Hope; they trade occasional waitressing and security services for combat and weapons lessons from the veterans. John Freeman is friendly with Jezebel, the leader of the Dolls. If the characters are losing, 1D6+5 Satin Dolls may show up, attracted by the commotion. They will do their best to help the characters hold out until MacGruder arrives.

MACGRUDER TO THE RESCUE

Within a few minutes, MacGruder will show up with her commandeered AV-4. She has managed to pull some strings and get a little help: a detachment of cops from the Second Precinct. The arrival of the AV-4 and four carloads of good cops will convince the remaining Cipriani mobsters that it's time to take a hike. The characters can safely load Hubie onto the AV-4. MacGruder will transfer him to a secure location and arrange for him to testify on Gunsights' behalf. Nails will accompany her. The characters can come if they want, but Treadwell is in good hands now.

CONCLUSION

If the characters keep Hubie alive and successfully deliver him to MacGruder: Hubie will testify before a Federal court within a day or two. The resulting inquiry will result in Gunsights' release and a house-cleaning at the Third Precinct. Based on the testimony offered by the disgraced Captain Hyman, several key members of the Cipriani family and two judges will be indicted. Nails, Gunsights, and several good cops will all owe the characters. When John Freeman returns in a couple of days, he will also be indebted to the characters, but that won't keep him from making them help him fix up the bar.

If Hubie is wasted: The characters gave it their best shot, but they lost their witness. Gunsights is arraigned and will face trial. Nails is despondent. Freeman is honked because the bar has been trashed. The characters are in the doghouse. They can redeem themselves, however. See Optional Episodes.

OPTIONAL EPISODES

✱ There are still crooked cops in the Third Precinct. They get together with

the surviving Ciprianis and come gunning for the characters.

- ✱ Carmine Cipriani, leader of the Cipriani Mob, has been indicted based on testimony provided by Geoffrey Hyman. Before he can be tried, he breaks out with outside help. The characters join Nails and Gunsights on an international manhunt for the fugitive mobster.
- ✱ Along with Nails, the characters pursue the Cipriani's Blue Glass connection in Germany, linking it with a major corporation.
- ✱ Someone is killing Satin Dolls. Is it connected with this case? The Dolls call in the characters' debt and ask them for help.
- ✱ Hubie Treadwell is dead, and Gunsights is going on trial. The only hope is for the characters to conduct their own investigation and prove that the cops set Gunsights up. It's going to be a long, tough job. ★

TALES FROM THE FORLORN HOPE #8



In this adventure, John Freeman asks the characters to help him and the other veterans track down and rescue a former member of LRT-601 who has gone dangerously cyberpsychotic. The characters will be in a race with the police to see who catches up with the cyborg first. Once they find him, the characters will have to protect him from the cops and from a mercenary commander bent on revenge.

Any number and type of characters can play in this adventure. Throughout the adventure, they will have to play cautiously. Not only are cyberpsychotics dangerous and unpredictable, but the Night City 'Borg Squad is a crack unit that brooks no interference from amateurs. It's one thing to get into a war with a few crooked cops (previous adventure), it's quite another to take on one of the toughest units in the city, under the command of one of the hardest and most incorruptible cops ever to patrol the mean streets.

**PART ONE:
DEAD OR ALIVE**

At this point, although not part of the close fraternity of LRT-601 veterans, the characters are part of the Forlorn Hope community. The bar is a second home now, someplace where the characters are accepted and at ease. Their service and loyalty to the Professor and to the other veterans and regulars has elevated them from wetnose rookies to trusted, veteran solos whose friendship and opinions are valued. So it is only natural that the Professor turns to them, among others, when a very personal crisis arises.

It's a pleasant evening at the Forlorn Hope. The time is relatively early and the crowd is still mellow. The band is up on stage, going through a few numbers before

THE LAST LONG RIDER

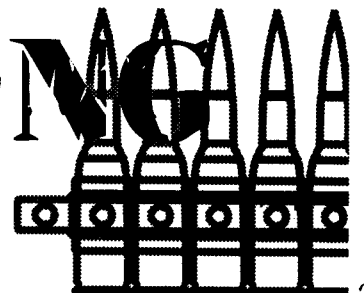

THE 'BORG SQUAD

The Cyborg Suppression Section is an elite detachment of the Night City Police Dept.'s SWAT division. The 'Borg squads are composed of ten man, quick-response Special Purpose Assault/Rescue (SPAR) teams. Each squad has an Emergency Van at its disposal. An E-Van is a heavily armored AV-4 supplied with special anti-Borg weapons. One or more SPAR Teams are assigned to each police precinct.

THE E-VAN

An AV-4 with SP 60 composite armor and 120 SDP. The van holds ten armored SPAR troopers and various extra weapons including two microwavers, two EMP guns, two Militech grenade launchers with various rounds (see the sidebar *Cargo of Death* in the adventure *A Hard Road to Go* for grenade launcher stats), two Barrett-Arasaka Light 20s, two Militech RPG-As with multiple rounds, a squad automatic weapon (HVY O N R 6D6+2(7.62) 200 20 ST 200m) and various grenades. All weapons are smartchipped. The E-Van also has special sensors for tracking 'Borgs.

SPAR TROOPERS (SOLOS)

These are McCarty's 'Borg men. They are tough, loyal and incorruptible. They are technically Solos, not Cops. Their special ability is Combat Sense.

Stats: INT 9, REF 10/11, TECH 6-10, COOL 10, ATTR 6, LUCK 5, MA 9, BODY 10/12, EMP 8/5, SAVE 12, BTM -4.

Skills: Combat Sense 8, Endurance 6, Intimidate 7, Awareness/Notice 8, Hide/Evade 6, Shadow/Track 5, Athletics 5, Driving 5, possible Pilot Vectored Thrust 6, Aikido 3, Handgun 6, Rifle 7, Submachinegun 7, Heavy weapons 7, Stealth 7, Melee 6, possible Demolitions 6, possible First Aid 5, possible Basic Tech or Cybertech 6.

Cyberware: Varies, but all have Basic Processors, Chipware Sockets, Smartgun Links and Cyberoptics/Audio with boosters and targeting capability, Adrenal Boosters and Kerenzikov +1. Almost all have Skinweaves and Muscle/Bone Lacing.

Gear: Sternmeyer Type 35 pistols with four magazines, H&K MPK 11 submachineguns with four magazines, FN-RAL assault rifles with five magazines apiece, plus the special weapons in the van. Monoknives, radios, SP 10 IR defeating armor jumpsuits, SP 25 torso and head armor (EV +1 total).



LT. BUBBA MCCARTY (COP)

Night City's most successful SPAR commander. He has countless 'Borg kills to his credit, and a reputation that spans the city.

Stats: INT 10, REF 10/11, TECH 6, COOL 10, ATTR 7, LUCK 4, MA 8, BODY 10/12, EMP 9/5, SAVE 12, BTM -4.

Skills: Authority 8, Endurance 5, Intimidate 8, Awareness/Notice 10, Hide/Evade 5, Shadow/Track 5, Athletics 4, Driving 4, Pilot Vectored Thrust 5, Aikido 4, Handgun 7, Rifle 7, Submachinegun 7, Heavy Weapons 7, Stealth 6, Demolitions 6, Melee 7, First Aid 5.

Cyberware: Basic Processor, Chipware Socket, Interface Plugs, Smartgun Link, Kerenzikov +2, Muscle/Bone Lace, Skinweave, Basic Cyberoptic, Low Lite™, Thermograph, Targeting Sight, Image Enhancement, Basic Cyberaudio, Amplified Hearing, Enhanced Hearing Range, Level Damper.

Gear: As on troopers.

taking a break to prepare for the late set. It looks like a peaceful night. Until the cops show up.

THE 'BORG SQUAD

Suddenly, the door will burst open and four armed and armored cops will walk in. Any one who has been in the city for any length of time will recognize their leader, Lt. Bubba McCarty of the Night City Police Department's elite Cyborg Suppression Unit...the 'Borg Squad. McCarty has a reputation as one of the toughest cops ever to hit the streets of Night City. His SPAR Squad has the highest kill rate in the city. Lt. McCarty will head for the bar, where he'll trade words with Marianne. The three other cops will circulate among the tables, passing out leaflets. One of the officers will drop four or five of the leaflets on the characters' table.

THE LEAFLETS

On the paper are two photographs. The left-hand one is a picture of a young, Hispanic man in tiger-stripe fatigues. Visible in the background are several military vehicles. The young man's name patch says 'ESTEVEZ.' Any character making an **Awareness/Notice Roll over 20** will notice another small patch on the young man's shoulder, just below the unit flash: 'LRT-601' The Long Riders; the Professor's team in Central America.

The photograph on the right is grainy. It appears to have been transferred from video. It shows a cyborg firing a large weapon in a wide arc. The view is slightly elevated, and the background appears to be a downtown street. A line of video characters at the bottom reads, 'NCPD-SURV-CAM0102-08.31.2020-18:34:02:00.' Any character making an **Education and General Knowledge roll over 15** will recognize the characters as the code bar from a Night City Police Department surveillance camera, otherwise known as a SURVCAM. 0102 is a serial number and location code. It's impossible to tell what location the code indicates without consulting the police computer. 08:31:2020 is the current date, 18:34:02 looks like military time. 6:34 PM; just about an hour ago...

By the time the characters are done looking at the photo, the cops will have finished passing out the leaflets and Lt. McCarty will be heading for the stage, where the band is still playing. Marianne is frantically dialing a phone.

TAKING ON THE 'BORG SQUAD

If the characters try to be sly by rubbing out Bubba McCarty, the NCPD will issue an APB and termination warrants for the characters, and they will be ruthlessly hunted by the cops until they flee the city or are dead.

MCCARTY'S SPEECH

McCarty will jump up on stage and wave the band into silence, an action that will elicit a chorus of jeers and booing from the patrons. He'll grab Ras Angabo's microphone and make the following speech:

"A little over an hour ago, some kind of deal went bad over at the Calypso Club on Betancourt, in the City Center. Surviving witnesses—and there are precious few of them—say that the boy in the photo there instigated the violence. They say that he went full 'Borg. They say that he started detonating the place. And, they say that he fired indiscriminately on innocent bystanders. That makes him a cyberpsycho, and that makes it my business.

"We did a little research, an' our people back at the station house think they got a line on this boy. Records say that his name is Enrico Estevez, and that he's a veteran of South Am. That's him in the other picture. I'm here because I'm told that this here club is popular with South Am vets, including members of Mr. Estevez' old unit. If there's anybody here who knows where this boy is likely to be hidin' out, I suggest that you let us know so that we can stop him before he's responsible for more deaths. Anything you can tell me that makes it easier for me to find this boy makes it less likely that I'll have to kill him when I catch up to him. The longer it takes, the harder it's gon' be."

McCarty will wait. No one will answer his request. If the characters look around, they'll see Icepick and Ringo, both former members of LRT-601, both pointedly keeping quiet.

"I thought so. Well, I want you people to understand something. That boy's gone. He ain't human no more. He ain't your buddy no more. He's over the edge, and he ain't comin' back. And I'm gon' get him, dead or alive. One more thing. In case you

people get any funny ideas about goin' after this boy yourself, let me remind you that I am authorized to use any means I deem necessary in order to apprehend or eliminate a cyberpsychotic individual. That includes usin' lethal force on people who interfere with me. I want you to think about that before y'all get any heroic ideas."

Having said what he came to say, McCarty and his men will leave. Any characters who look will see that the good Lieutenant had six more men and an E-Van outside; the whole compliment of his SPAR squad.

PART TWO: THE PROFESSOR'S PLEA

As soon as McCarty is gone, the Professor will emerge from behind the bar, where he has been since receiving Marianne's distraught phone call. The Prof will leap up on the stage and take a turn on the microphone. "Sorry about the interruption, folks. I'd like to thank you all for not making any trouble while the cops were here. Right now, I'd like to see all of the old team members and a few other people downstairs, please." Freeman will indicate a few people in the crowd, including the characters, and then heads downstairs. Everyone will gather in one of the secure conference rooms. All of the former members of LRT-601 are there, along with the characters and most of the other trusted regulars. There are about twenty-five people in the small room. Freeman will continue.

"Those of you from the unit know this. For the rest of you, the man in the photo on the left is Rico Estevez, a member of my old team in South Am. He disappeared after the war ended, and none of us have seen him since. I've heard a couple rumors that he went international and started working as a mercenary, but nothing concrete. I don't know if that's him in the second photo, but if it is, then we have to find him, and before McCarty does. I'm not going to sit here while a member of my unit is hunted down like an animal and killed. Rico Estevez was one of the most compassionate people I ever met. If that really is him, and there's any piece of him left alive under that metal, then we can reach him. And if he has to die...then I want it to be at our hands.

"Before I go on, I want to find out who's with me. I can't pay all of you for this. Maybe Dollar Bill can kick some in, but I'll have to talk to him. I'm asking you

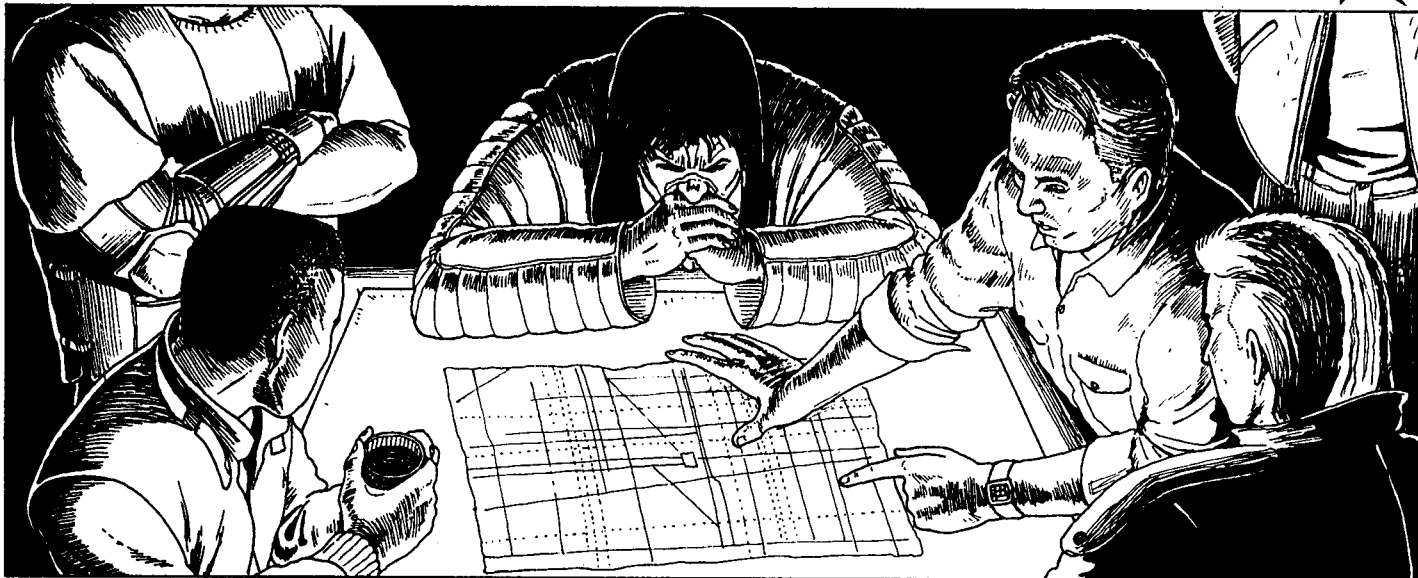

"...WE HAVE TO FIND HIM, AND BEFORE McCARTY DOES."

all as friends and comrades to do this for me. Anyone who wants out can go, and I won't hold it against you. But, believe me, I won't forget anyone who helps...ever."

Freeman will wait to see who sticks around. One or two people will leave, but it won't be anyone the characters know. All of the trusted regulars are standing by Freeman in his time of need. The characters must choose if they, too, will remain. If they leave, there is no adventure, so hopefully they'll stick around. Once the crowd has settled down, Freeman will conclude.

"I'm asking you to risk your lives, but not to throw them away. Don't take any stupid risks. I want Rico alive, but not at the cost of any of your lives. Kill him if you have to, but try to be merciful. And do your best to stay out of McCarty's way. No confrontations! I know him, he'll back up his threat. Now, I'm going to divide us into teams, and then I have a little information that might be useful."

The Professor will divide the group into teams. Naturally, the characters will be together. Every team will be accompanied by one LRT veteran. Ringo will go with the characters (see **The Hope** for stats). If there are less than three player characters, then Freeman will assign one other Hope NPC to join the party. There are five teams.

CLUES

Here's what the professor knows:

- ✦ Rico was from Miami. He has no known family or friends in Night City other than the LRT vets. Rico may not know that many of his old buddies live in Night City.

- ✦ McCarty said a deal went sour. That means that the 'Borg was talking with someone or some team.

- ✦ Three known groups hang out or do business at the Calypso Club. The Blue Angels are a smuggling gang that runs panzers into Southern California and Mexico. The Union Force is a small force of mercenaries that does freelance escort and black ops work for small-time clients. The Morks are a posegang with self-explanatory affectations.

THE PLAN

The Professor's group will check out the Morks at their hangout. Icepick's crew will check out the Blue Angels at their vehicle hangar in the Central Valley. Sundance and her team are checking witnesses at the scene. Gunsights has police credentials, so his team will interview witnesses at the hospital. Ringo and the characters will be responsible for checking out the Union Force.

PART THREE: UNION FORCE

The Union Force has a base in an industrial area in South Night City. That's where the characters will have to head.

THE COMPLEX

Union Force's complex is on 125th St. and Refinery Parkway, near the old Petrochem refinery in South Night City (see the *Night*

City Sourcebook for information on South Night City). It occupies a large block in an isolated industrial area. The refinery is a few blocks to the south, and there are other buildings and industrial parks scattered around.

The Union Force base is two large buildings, several small ones, a large, open-air vehicle park, and a firing range all surrounded by a cyclone fence topped with razor wire. The Union Force logo is on a large sign on the fence. There are lights on in the buildings, but no one seems to be moving around. There is a guard booth by the gate, but it seems empty. If the characters make an **Awareness** roll over 20 they'll see a couple of bullet holes in the booth's glass. Whether or not it involves Rico, it looks like the Union Force has run into a little trouble this evening. A peek into the booth will reveal two bodies huddled on the floor. The bodies are cooling, but not yet cold. The blood is fresh. Both men had weapons, but neither has been fired. A **Medtech** roll over 15 will reveal that the men have been dead for about an hour. Once the characters are on their guard, a look with teleoptics will show some broken windows and bullet holes in the large buildings inside.

If the characters try to hail someone: No response.

If the characters try to call someone: There is a phone inside the booth. The internal lines will ring, but no one answers.

If the characters enter the base: The characters can open the gate from inside the guard booth, but it may register inside.

Getting through the gate without raising the alarm will take an **Electronic security roll over 20**. Climbing the fence without snagging on the razor wire will take an **Athletics roll over 20**. Anyone trying to climb the fence but failing their roll will take 1D6 damage in two random locations, plus be snared for 1D6 combat turns.

INSIDE THE BASE

There are two main buildings. One is a quonset hut that houses vehicles and maintenance shops. One is a three story office building. There are a number of smaller buildings. Most appear to be storage sheds and fuel shelters. See the map for more details. There are various vehicles scattered around. Most appear to be heavy military trucks and jeeps. There are a couple of Arasaka Combat 10 vehicles. Now that the characters are getting a closer look, they will see some more signs of violence. Several windows are shattered and there are areas in both main buildings where the walls sport a profusion of bullet holes. It looks like the bullets were fired inside the office building and exited through the walls. There are no bodies outside, but if the characters make an **Awareness/Notice roll over 20**, they will notice bloodstains where it looks like people have been cut down and dragged off. There are also shell casings scattered around.

The Quonset Hut: There is blood around the roll-top vehicle door at the end of the quonset hut. Both the large door and the small personnel door to the right are unlocked. The quonset hut appears to have escaped major damage during whatever confrontation occurred. Inside are a number of vehicles in various states of disrepair. There are also some weapon and armor maintenance benches. There are bullet holes in the walls, but they appear to be entrance holes created by rounds coming from outside. There are five bodies, two female and three male, arranged in a pile by the door. Riddled with machine gun fire, they appear to have been shot outside and dragged in. There is also a pile of weapons. Unlike the guard's weapons, these have been fired.

The Office Building: The office building is a little more interesting. It looks like it has been the scene of a major battle. Upon entering, the characters will immediately see bullet holes and bloodstains on the wall and bodies in the hallway. As the

THE UNION FORCERS (SOLOS)

These are the soldiers who serve in a small, private mercenary outfit. These stats apply to the soldiers at the complex and the soldiers that will accompany Nathan Ryder later in the adventure.

Stats: INT 8, REF 10, TECH 6, COOL 9, ATTR 7, LUCK 5, MA 8, BODY 7 to 10, EMP 8/7, SAVE 7 to 10, BTM -2 to -4.

Skills: Combat Sense 5, Awareness/Notice 6, Hide/Evade 6, Shadow/Track 4, Wilderness Survival 5, Athletics 4, Dodge and Escape 3, Karate 4, Driving 5, Handgun 6, Rifle 6, Submachinegun 6, Demolitions 6, Heavy Weapons 5, Melee 6, Stealth 5, First Aid 4, Weaponsmith 5.

Cyberware: Varies. Most have Basic Processors, Chipware Sockets, Smartgun Links, Cyberoptics with Targeting Scopes, and a few other enhancements.

Gear: Smartchipped Militech Ronin light assault rifles with four magazines apiece, smartchipped Militech Avenger pistols with three magazines apiece, monoknives, radios, SP 20 torso armor and helmets, various grenades.

characters explore the building they will see more and more signs of carnage. Desks are overturned, bodies are strewn about, and shell casings litter the floor.

AMBUSH

Not everyone in the building is dead. Six survivors of whatever firefight took place are waiting, crouched in the office building, scared and edgy. They will hear the characters enter the building, and, seeing that the characters aren't cops, they will lie in wait. The ambush is set in the junction of the two major hallways on the ground floor of the office building (see map). The assailants are hidden in dark rooms off of the main corridor. The characters will have to make **Awareness/Notice rolls vs. the Union Force member's Stealth** to successfully detect the Union Force members. If any of the characters have Low-Lite™ or Thermographic Cyberoptics, they will get a +2. See sidebar for Union Forcer stats.

If the characters succeed: They will see the dark shapes crouched behind desks in the recesses of the offshoot rooms. They may act however they wish. It's worth pointing out, however, that the Union Force members have taken a beating this evening. They are paranoid and on a hair trigger. The characters might try negotiating. If the characters make any threatening move, the Union Force soldiers will fire.

If the characters fail: The Union Force soldiers don't know whether the characters are connected with their previous assailant or not, but after this evening they're not taking any chances. They will move to the doors of the rooms, draw beads on the characters and yell at them to freeze. If the characters make a hostile move, the Forcers will fire with the Ambush +5 bonus. If the characters stay cool, the Forcers will tell them to drop their weapons and back away, and then demand to know what the characters are doing there.

If the characters kill the remaining Union Forcers they'll destroy their next lead and you will have to improvise. If there are any left alive, then the characters may interrogate them. They will find out what happened earlier and get their next lead (see below). If the characters don't fight, the Union Forcers will talk to them after they are convinced of their motives.

SHOOTOUT AT THE UNION FORCE

The soldiers will tell the characters that their commander, Colonel Nathan Ryder, was planning an operation that was to take the Union Force to Indonesia. The anonymous client assigned an intimidating cyborg to work with the Union Force as a liaison. The Forcers knew the cyborg only by the handle

A POSSIBLE PLOT DEVICE

If a firefights breaks out, have Ringo take a hit that forces him to go to a hospital or back to the Forlorn Hope. That'll make things very interesting for the characters later on, if they actually confront Rico.

Stringer. Ringo will point out that Stringer was Rico's handle in South Am.

Nate Ryder and Stringer never hit it off. Forced to work together, there was tension between the two from Day One. As client liaison, Stringer had his own ideas about how the operation should be run. Ryder stood firm on his command over the Force. If it hadn't been such a lucrative contract, he probably would have told Stringer and the client to get lost. Ryder and Stringer had gone to the Calypso Club that evening to try and work out their differences, to see if they could find some common ground and salvage the mission. Evidently, it didn't work out. There was only a skeleton crew of twenty soldiers at the base. Some of the force were at the

club with Ryder and Stringer. The rest are on leave elsewhere in the city. A little while ago, Stringer came back to the complex without Ryder. No one thought anything of it until he started shooting. Taken by surprise, the skeleton crew had little chance. It was all over in about five minutes. Stringer disappeared. Fourteen were killed, six survived. They saw the characters come into the complex and set up the ambush because they didn't recognize them. They thought the characters were from one of the local gangs, or possibly connected with Stringer.

A FEW POINTS

- * The Forcers know that Stringer was staying in a coffin complex near the airport, the EZ Overnighter Luxury Sleeper. They don't know which unit he's in. Of course, he could be anywhere in the city.
- * The cops haven't been to the Union Force base yet. They usually don't respond to firefights in South Night City. It's a good bet that McCarty and his team will be there before long, however, and the characters had bet-

ter be gone before he shows up. The Union Forcers are going to stay behind and start picking up the pieces. They still don't know if Nate Ryder is alive.

- * The characters will want to check in with the Hope and let Marianne know what they've found. She will pass the information along to the other teams when they contact her. In the meantime, the characters should keep working. None of the other teams are in immediate contact.

PART FOUR: RICO

The EZ Overnighter coffinshop is off of Interstate 16, the city beltway, just a mile away from the airport. The EZ is a low-grade coffinshop, popular with Solos and Corps on a budget who need a place to crash. It is rare for people to stay in the EZ, or any coffinshop, for more than a day or two, as the tiny cells have barely enough room for one person and a suitcase. They are meant for sleeping only.

The EZ Overnighter is old and cheap, and unlike many newer establishments, it

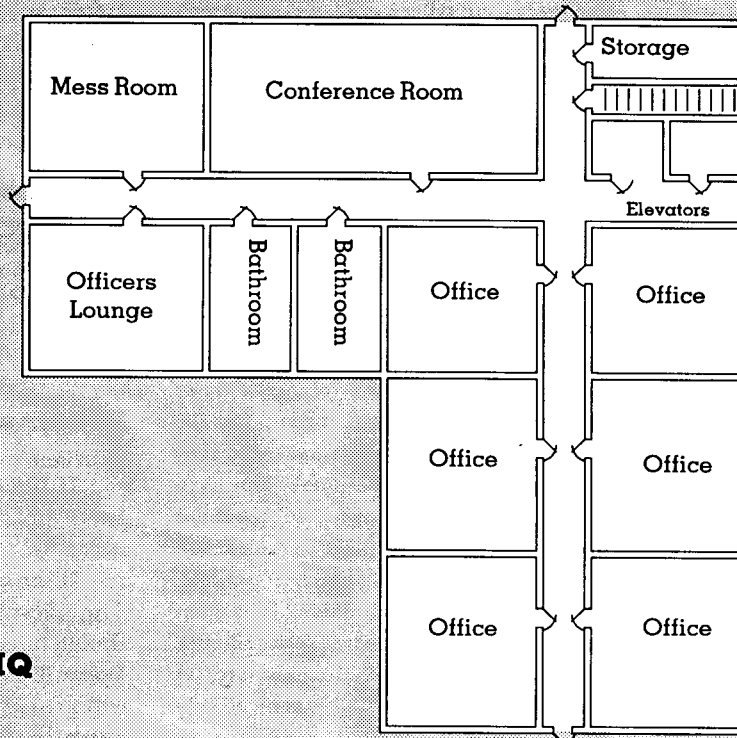

Union Force HQ

has an attendant. He claims to “not make a habit out of discussing customers,” but if the characters slip him a few bucks he’ll sing like the fat lady at the endless German opera. He’s behind a bulletproof shield in an office resembling a small fortress (SP 30 walls, SP 25 SDP 20 window and door), so prying the information out of him could prove difficult. He also has a silent alarm button under the desk. He will use it to summon the police at the first sign of trouble. If the characters bypass the attendant they’ll be in for a long evening as there are 240 coffins to check. Most people in coffins *don’t* like being disturbed.

The coffinshop attendant does remember seeing a particularly cyberheavy individual going in and out of the establishment. The man in question is registered in compartment 111 and also has a locker. He paid in cash for about a week and no name was given. The attendant has been watching TV and he has no idea if any of the patrons have walked in or out recently.

The characters will have to think carefully now. How do they want to approach the coffin? Do they want to page it? Do they want to knock? Blow it up? The coffins themselves are arranged in concrete bunkers of 60. The bunkers leave little room to maneuver. The characters should also be forewarned that the coffinshop has about 60 other patrons. There is a 20% chance per minute of someone entering or exiting one of the bunkers.

If the characters page the coffin: No answer.

If the characters check it out: It is closed. There is no way of telling if there is anyone inside. No one answers if the characters knock.

If the characters want to open the coffin: The attendant won’t crack it. That’s going too far for him. He’ll tell the characters not to mess around. The most he’ll do is leave a message. The characters can pop the lid with a **Pick Lock roll over 25**. An **Electronic Security roll over 20** will keep the light on the attendant’s board from going on. Better prep. As soon as the characters start to open the hatch, have everyone close to the coffin attempt an **Awareness Notice roll over 20**. Anyone succeeding will notice wires inside the hatch. A booby trap. A **Demolitions roll over 20 will defuse the trap**, a failed roll will detonate it. If the characters fail to detect or disarm the trap it will explode,

COFFINSHOPS

Coffins are tiny, one-person sleeping compartments that are rented out on a nightly basis. They are the cheapest way to sleep except on the street. The only things in a typical coffin are a vinyl mattress and pillow, disposable paper sheets and blankets, a tiny storage cubical and a pay TV. Large items must be kept in rented lockers or in a car. Everyone uses a communal bathroom. Security is usually lax, and many are automated except for cleanup. Typically 10-40eb a night, depending on quality and security.

doing 3D6 to everyone within four meters. Armor at 1/2 effectiveness. If the characters trip the booby trap or fail their Electronic Security roll, then the attendant will summon the police.

The coffin is unoccupied. There are some clothing items and personal effects scattered around, however, including a dog-eared photo of the members of LRT-601 taped to the ceiling over the pillow. The photo shows the entire unit, including a pre-Borg Rico, gathered around a US flag somewhere in the field in South or Central America. A board has been propped up in front of the group. It has been crudely painted with the legend: LRT-601 THE LONG RIDERS—MISSION 25 10/15/2007. If Ringo is still around, he will point out that the photo was taken to celebrate the completion of the Long Riders’ 25th mission into plantation territory. Many of the vets have a copy of the picture, as it’s the only one that shows the entire unit together.

RICO ATTACKS

At this point, if any of the characters are on guard, have them make **Awareness/Notice rolls vs. Rico’s Stealth** (see sidebar for Rico’s stats). If the characters succeed, they will notice a large figure quietly approaching the building from the shadows. If the characters fail, then their first clue will come somewhat more suddenly. If possible, Rico will sneak up behind one of the characters and attempt to cut his throat silently. Otherwise, he will rush the character(s) with a knife or shoot with his silenced sub-machineguns.

If the characters fight back: Rico will attempt to kill the characters as quickly and

as quietly as possible. He will not hesitate to use firearms if he has to. He will continue to attack until the characters are dead or until they convince him of their good intentions and their connection to LRT-601. Once fighting, Rico will have to make an **EMP roll over 9** in order to stop attacking at any time. Rico gets +2 to his EMP roll if confronted by Ringo or another member of LRT-601. He can attempt once per turn while the characters are trying to talk him down.

If the characters retreat or act passively: Rico will pursue and attempt to attack. He will persist until convinced of the characters’ connection to LRT-601. It will take an **EMP roll over 7** for Rico to stop pursuing and an **EMP roll over 9** for him to stop attacking. He gets +2 if confronted by Ringo or another member of LRT-601. He can attempt once per turn while the characters are trying to talk him down.

If there is any gunfire or serious disturbance, or if any other coffin occupants see the fight, then the attendant will summon the cops. Also, if there is gunfire, the other patrons will panic and come streaming out of their coffins. If this happens there is a good chance that Rico will open fire on them. If, at any time, Rico makes his EMP roll, he will collapse, sobbing onto the ground. He will beg for help, especially from any members of LRT-601 that are present. Half-crazed and on the verge of suicide, he could lose control again at any time. Rico wants to be human again, but he doesn’t know how.

“I’VE KILLED SO MANY PEOPLE...I DON’T KNOW HOW TO STOP. HELP ME, PLEASE. HELP ME BEFORE I DO IT AGAIN.”
- RICO

If the fight drags on: The Union Force and the cops will show up, in that order. See Part Five: Confrontation.

If the characters somehow kill Rico: The adventure is over. The characters should bring the body back to the Hope. Dollar Bill will pay for burial. Lt. McCarty will grill everyone and may bust some heads, but it’s all over. Nate Ryder will be denied his revenge (see Part Five: Confrontation).

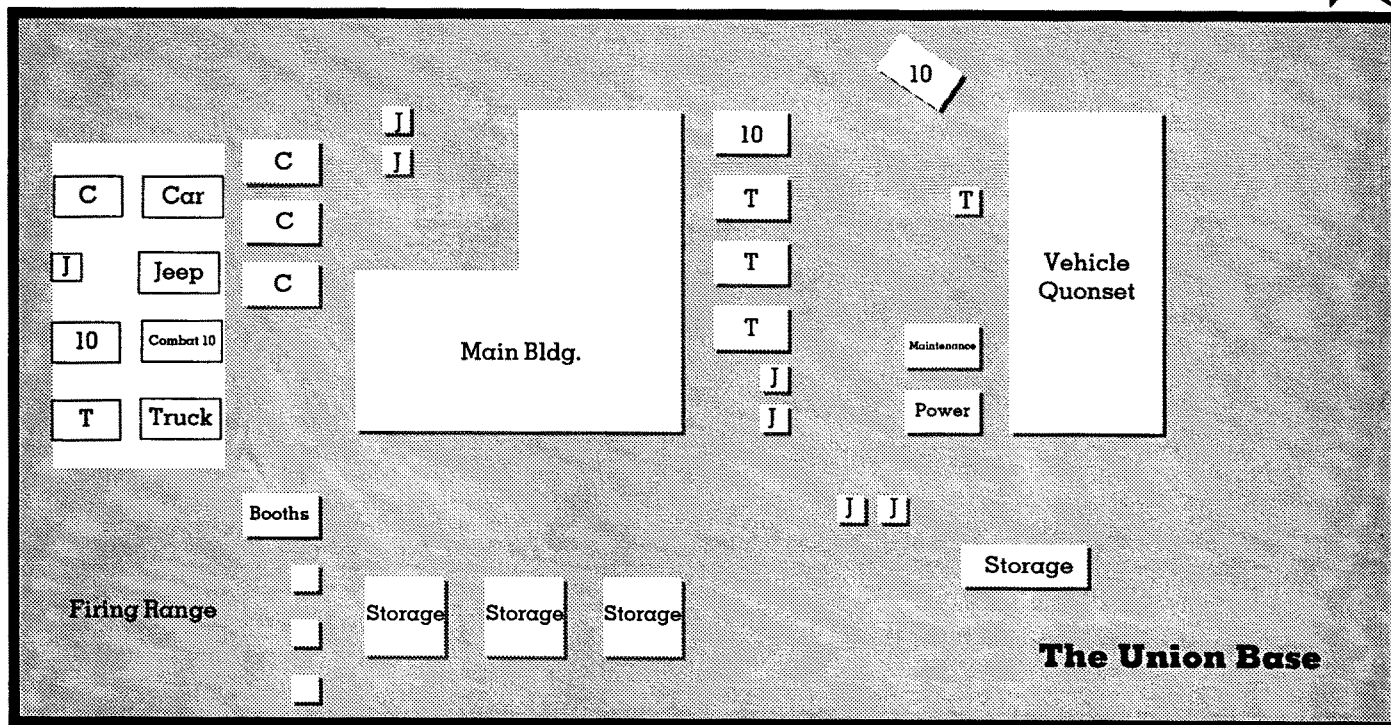

If the characters flee with Rico or talk to him at the scene: They will get a chance to hear his story before the Union Force and cops appear. Ringo will call the Hope and tell Marianne that he is on his way home with Rico. The other teams will be recalled.

RICO'S STORY

Rico has been freelancing as a Solo ever since the end of the war. He didn't want to, but after all those years in-country he found he couldn't adjust to anything other than life as a soldier. Gradually, as contract after contract was fulfilled, he accumulated more cyberware and lost more friends. Slowly the strain on his mind grew, yet he deluded himself that he could control it. Until today, when it got to be too much. Recently, Rico's been working as a Solo for a small but up-and-coming biotech firm. They hired the Union Force to run an international op for them, and he was to be the liaison between the corp and the Union Force. The commander of the Union Force, Nate Ryder, wouldn't leave him alone, however, persecuting him incessantly just for trying to do his job. Finally, today at the Calypso Club, he snapped and went into a killing rage. Ironically, Ryder escaped.

Rico went back to the Force headquarters near the refinery, hoping to find Ryder there. He didn't, but he left a trail of other bodies. After that, he came here. At first, he was going to collect his things and

flee, but something made him stay. He's been watching the planes land and take off for the last hour, half hoping that the police would catch up with him and finish him off. He had no idea that the members of LRT-601 were in the city. He still considers them the only true friends he ever had. Finding them is the one thing that makes him want to survive this evening. He will beg the characters to take him back to the Hope and turn him over to the police. The last vestige of his humanity urges him to do this. All it will take is one more incident for him to go permanently insane.

PART FIVE: CONFRONTATION

There are a few ways that the final confrontation can come about. Either the characters can dally at the EZ Overnighter too long; they can be hit on the way back to the Hope, or they can be hit at the Hope. The exact situation depends on how the characters play it. One way or another, both Lt. McCarty and Nate Ryder are going to appear. The confrontation will only happen if Rico is still alive.

RYDER'S REVENGE

As Rico pointed out, Col. Nate Ryder ironically escaped his rage at the Calypso Club. Ryder heard about the massacre at the Union Force base shortly thereafter. Now he is bent on revenge, driven to destroy

the cyborg that killed twenty of his men in a single evening. Ryder has collected a force of fifteen men, drawn from off-duty Union Forcers who were on leave in the city. Ryder not only knows where Rico is staying, but he has also done his research and knows of Rico's connection to LRT-601. A South-Am vet himself, Ryder is no stranger to the ties between soldiers. If he can't find Rico at the EZ Overnighter, he is more than willing to check the Hope. He and his men are cruising in an Arasaka Combat 10 (see *Corpbook One* and sidebar) armored vehicle, looking for Rico.

MCCARTY'S JUSTICE

Ryder isn't the only one who is closing in. McCarty and his SPAR troopers have done a good job of tracking Rico. The only reason that they didn't find him before the characters is because they worked together as one team rather than splitting up. McCarty has also traced the Union Force lead, and now he's closing in.

THE COURSE OF EVENTS

Nate Ryder and his Union Forcers will show up first. This is too bad, because Rico was willing to surrender to the police. Ryder, however, is not interested in surrender. He's interested in blood. His men are heavily armed and armored, and this time they're prepared. It's up to the referee to decide where the Forcers make their move. It can be at the EZ Overnighter, on

Rico

A tortured man who has been forced by his own weaknesses into living a life of violence for fifteen years. He is borderline cyberpsychotic, prone to violent rage and with little compassion for humans. He is not, however, beyond recovery.

Stats: INT 7, REF 10, TECH 8, COOL 10, ATTR 4, LUCK 4, MA 10, BODY 14, EMP 10/1, SAVE 14, BTM -5.

Skills: Combat Sense 9, Endurance 5, Strength Feat 6, Intimidate 8, Resist Torture/Drugs 4, Awareness/Notice 8, Hide/Evade 4, Shadow/Track 6, Wilderness Survival 6, Athletics 5, Dodge and Escape 4, Karate 5, Handgun 7, Rifle 7, Submachinegun 7, Heavy Weapons 6, Fencing 5, Archery 8, Demolitions 6, Driving 4, Stealth 6.

Cyberware: Basic Processor, Chipware Socket, Smartgun Link, Dataterm Link, Machine Link, Vehicle Link, Interface Plugs, Sandevistan Speedware, Pain Editor, Nasal Filters, Grafted Muscle, Muscle and Bone Lace, Basic Cyberoptic, Image Enhancement, Targeting Scope, Times Square Marquee, Low-Lite™, Basic Cyberaudio, Amplified hearing, Enhanced hearing Range, Radio Link, Level Damper, Two Cyberlegs, one Cyberarm, all with Hydraulic Rams, Microwave/EMP shielding and SP 20 armor, Linear Frame Beta, Cowl, SP 25 Torso Plate.

Gear: SP 20 armor jacket, monoknife, Colt AMT 2000 pistol with four magazines, two smartchipped, silenced Ingram MAC 14s with eight magazines. In his locker are various grenades, more ammo and a Militech Renegade squad automatic weapon (HVY 0 N R 6D6-1 (6.5mm) 200/35 20 ST). See *CorpBook One* for details on the Renegade.



the road or at the Hope. The only way the characters have a prayer of saving Rico is if the confrontation takes place at the Hope.

If The Forcers attack the characters at the coffinshop: Two of them will stay in the Combat 10. The rest will spread into an assault formation and quietly sweep through the complex looking for Rico. There is a 50% chance that the characters will be alerted by a patron. Otherwise they and Rico will have to make **Awareness/Notice rolls vs. the Forcers' Stealth**. If the characters succeed they'll realize that they're about to be attacked. Otherwise it will come as a surprise. The Forcers

want no quarter, and they will attack savagely and with everything at their disposal. If the characters are with Rico, they'll be attacked too. Rico will have no choice but to participate in the fight. See below.

If the Forcers attack on the road: If they catch up with the characters on the way back to the Hope, they'll use the gun on the Combat 10. The characters will have no choice but to try to outrun the vehicle, or bail out and fight man to man. If they run, Ryder will follow them back to the Hope. Once again, Rico will most likely have no choice but to get involved in the fighting. See below.

If the Forcers attack at the Hope: This is the one chance the characters have of saving Rico. Ryder will station his Combat 10 outside the Hope and send several men around to the back. He will demand that the characters send out Rico. Rico doesn't mind dying, but he'll be damned if it's going to be at the hands of Nate Ryder. Fortunately, the Hope is secure enough that the characters can hold off the Union Forcers while they keep Rico out of harm's way. Rico still has a 10% chance of snapping every two turns that he hears gunfire. If Rico does snap, he will leap into the fray, an unrecoverable killing machine.



COL. NATE RYDER (SOLO)

Ryder is the leader of the Union Force. He is a veteran Solo and a syndictive person.

Stats: INT 8, REF 10, TECH 7, COOL 10, ATTR 7, LUCK 7, MA 7, BODY 8, EMP 6/7, SAVE 8, BTM -3.

Skills: Combat Sense 7, Leadership 5, Awareness /

Notice 6, Education and General Knowledge 4, Hide/ Evade 4, Shadow/Track 5, Blending 5, Dodge and Escape 5, Handgun 6, Rifle 7, Submachinegun 5, Driving 5, Melee 4, Stealth 4, Demolitions 4.

Cyberware: Basic Processor, Chipware Socket, Smartgun Link, Interface Plugs, Left Cyberarm, Basic Cyberoptic, Low-Lite™, Targeting Scope, Times Square Marquee.

Gear: Basic Union Force kit.

RYDER'S PERSONNEL

The same as the Union Force personnel detailed before. These troops are armed with heavy weapons, however, including one squad automatic weapon, one grenade launcher and two RPGs.

THE ARASAKA COMBAT 10

An armored vehicle common with troops around the world. Nominally capable of transporting ten troops, but can move fifteen if they have no packs. SDP 250, SP 50. Eight Tires, SDP 50, SP 90. A turret houses a minigun and a cannon that fires shells that do 8D6 over a 5m radius. Also has smoke ejectors. See *Corp Book One* for details.

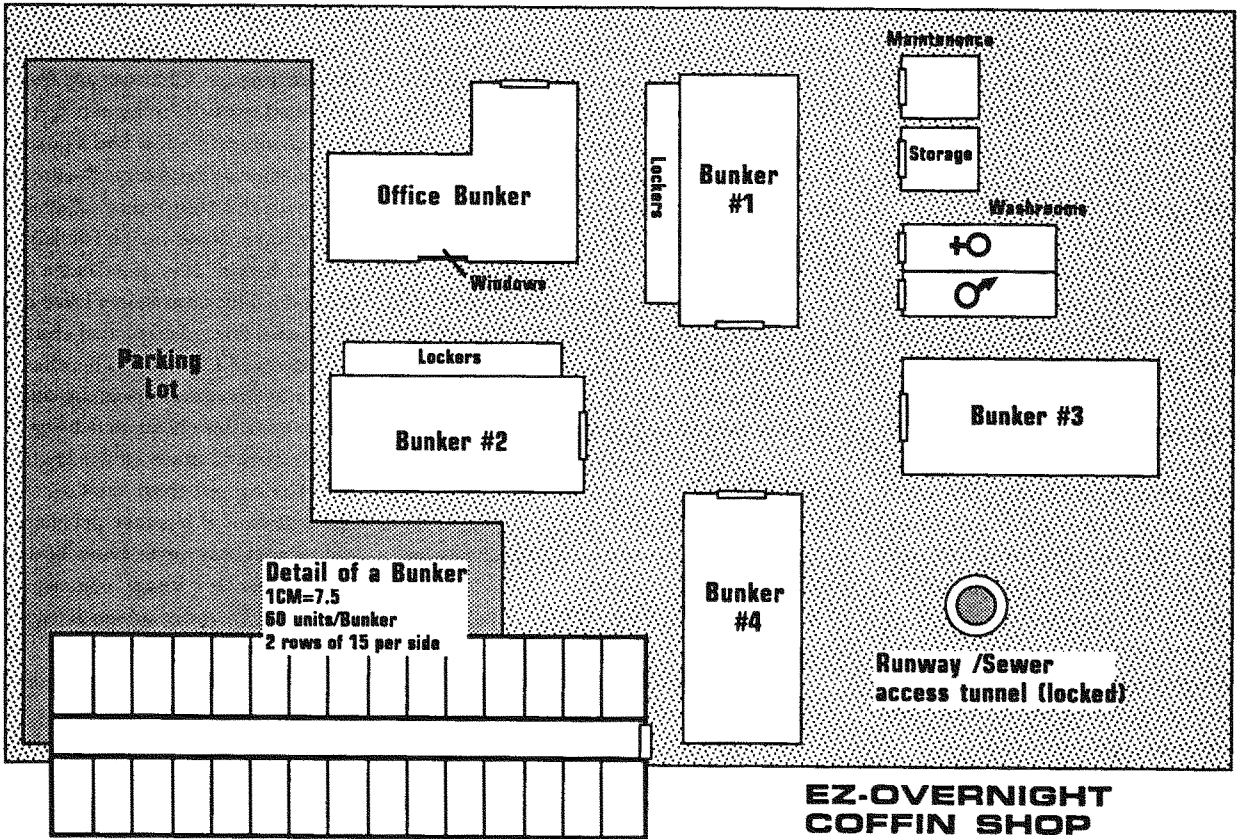

EZ-OVERNIGHT COFFIN SHOP



TIME RUNS OUT...

MCCARTY SHOWS UP

A few minutes after the characters engage the Union Force, McCarty and his SPAR team will show up in their E-Van. They have traced Rico through the Union Force. McCarty and his men will go through both the Union Force and the characters to get to Rico. There's a good chance that the whole scene could dissolve into a massive three way brawl that will end only when Rico is dead. The characters will have to duck and cover to keep themselves alive, as they are targeted by the Union Force for being Rico's friends, and by the cops for aiding a fugitive cyborg.

If the cops appear at the coffinshop or on the road: Ryder doesn't want to surrender his revenge. He may order his men to engage McCarty's team. Perhaps the characters can escape unnoticed. Rico may already be beyond help.

If the cops appear at the Hope: If the characters communicate to them that Rico is prepared to surrender, the cops may deal with the Union Forcers. Then Rico can be safely turned over. He will have to be tried, but he is prepared for that. At least he'll receive treatment. If Rico has gone unrecoverable, then a three way brawl may erupt, with the cops and the Forcers gunning for Rico and the characters covering their butts.

THE CAVALRY

If things ever start to look really bad for the characters, the other Hope regulars

can show up. They have contacted Marianne and learned that the characters have located Rico. They are on their way to help. This will even the odds a little. This is especially likely if the characters get Rico back to the Hope.

OPTIONAL IRONY

If the Forcers are defeated and Rico agrees to surrender to the cops, you can throw in a huge ironic twist by having a concealed Forcer take a pot shot at Rico just as he is leaving the Hope to walk into McCarty's E-Van. There are two possible outcomes. For irony, the shot can send Rico over the edge into that final cyberpsychotic rage that must end in death. The cops will have no choice but to kill him, and the characters may have to help. For straight up pathos, the shot can hit Rico in the head, penetrate his armor and kill him. Killed on the verge of salvation. It's up to you.

POSSIBLE OUTCOMES

There are two ways in which this adventure can turn out:

✦ **Rico is Killed:** The characters couldn't save him. It's a bittersweet loss, though. Rico is finally at peace, and he didn't die alone. He had friends at his back when the end came. He'll be laid to rest at home. His true home, near the Forlorn Hope, and the best friends he ever had.

✦ **Rico is Saved:** He'll have to be tried, but cyberpsychosis is an accepted defense. He'll have to do time in an institution, but he'll get treatment and some of his humanity will be restored. Having found his friends, there is no need for him to walk the road of solitary madness ever again.

CONCLUSION

A clear cut victory will be hard to obtain in this adventure. Chances are that Rico will die, and even if he doesn't, he will face time in an institution and a painful period of emotional recovery. Freeman is satisfied with the characters' efforts, however. They have done more for him than he could hope. His gratitude knows no bounds. The characters have earned his trust and friendship, and that of all the members of LRT-601. The characters are closer to the members of the unit than any other outsiders have ever been. They are also heroes to many of the regulars in the bar, having put their lives on the line for the veterans. It is a rare privilege, and the characters may never know better friends. They'd better keep 'em too, because there will be more adventures at the Forlorn Hope.

Whether or not Rico makes it, his image is permanently etched into the minds of the Solos of the Forlorn Hope. He is a reminder of the fate that they all flirt with, and the end they may all someday face. No one will ever forget the last Long Rider. ✦

TALES FROM THE FORLORN HOPE

2009:

Long Range Team-601 left on its last mission. Four years in a savage SouthAm drug war with little support from home and no quarter given by the enemy. When the war ended, the team was scattered into civilian life, but their combat instincts, that craving for the rush of *action*, couldn't be purged...

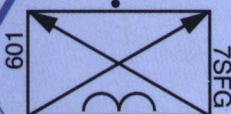
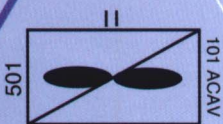

2015:

John "Professor" Freeman, Captain of LRT-601, builds a bar as a rallying point for his former teammates, and a haven for other SouthAm vets. He calls it *The Forlorn Hope*—a place where soldiers and solos can fraternize with others that "speak the language" and know the nerves that come with living hard and fast.

2020:

Today, the regulars at the Hope continue to run the Edge, across the country and around the world. And you can be there with them in 8 different adventures, from a corporate extraction with a twist, to a murder investigation gone bad, to a monster hunt in the wilds of Eastern Europe! Pay your dues and become a member of the most exclusive solo fraternity around—*The Forlorn Hope™!*



**AN ADVENTURE
FOR**



**R. TALSORIAN
GAMES, INC.**

Published by R. Talsorian Games
P.O. Box 7356
Berkeley, CA 94707
Copyright 1991 by R. Talsorian Games Inc. Cyberpunk®
and Tales From the Forlorn Hope are trademarks of
R. Talsorian Games Inc. All Rights Reserved.

