

# WHEN GRAVITY FAILS

ADVENTURING IN THE WORLD OF GEORGE ALEC EFFINGER'S NOVELS

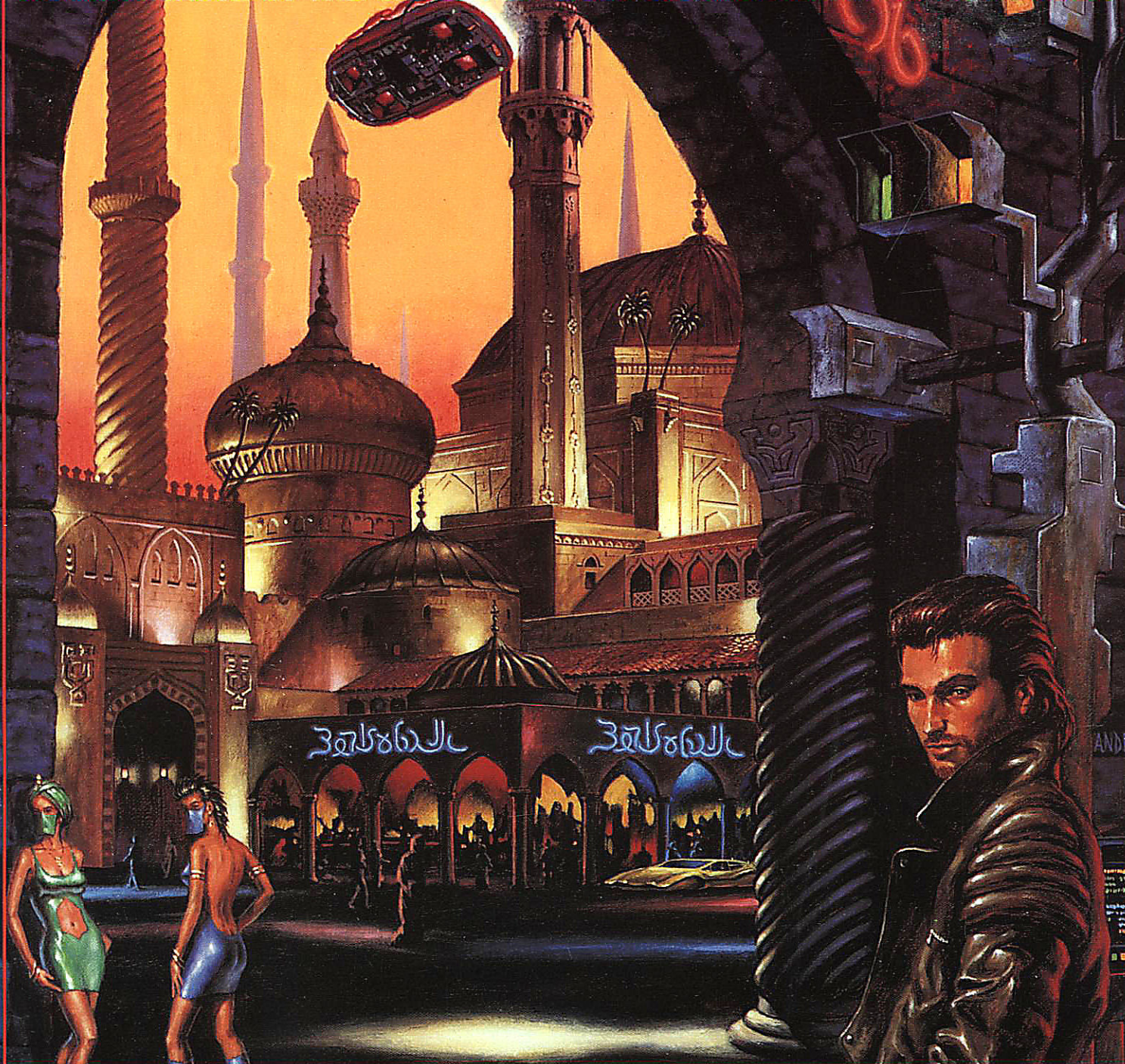

ACKERMAN • MOSS • HOCKABOUT • WILLIAMS

A SOURCEBOOK FOR

CYBERPUNK®

R. TALSORIAN  
GAMES, INC.



# WHEN GRAVITY FAILS

ADVENTURING IN THE WORLD OF GEORGE ALEC EFFINGER'S NOVELS

Want to know where that dark alley leads? What's it worth to you to find out? Maybe all your money? Maybe your *Life*?

I pictured some dark byways in *When Gravity Fails*, and I have Michael MacDonald, William Moss, David Ackerman and the rest of the crew at R. Talsorian to thank for bringing that vision to dice-wielding reality. In the original novel, I was very concerned with showing Marid as a loner and an outsider, one who doesn't quite fit into his own noble and ancient heritage. I'm glad that RTG has taken the same care and effort to consult the proper experts and provide an accurate and plausible vision of the world of 2202.

Everything's just a game to some people, right? You just don't want to be standing next to them when the pay-back happens.

GEORGE ALEC EFFINGER

A SOURCEBOOK FOR

CYBERPUNK





# Credits

Written by:

David Ackerman  
William Moss  
Chris Williams  
Chris Nockabout

Edited by:

George Alec Effinger  
Derek Quincannon, S.E.  
Will Moss  
Michael MacDonald

Development:

Michael MacDonald

Art Direction:

Matthew Anacleto

Layout:

Matthew Anacleto

Cover by:

Doug Anderson  
©1992 Doug Anderson

Illustration by:

Bj. West  
Bob Ciadrosich  
Darryl Midgeotte  
Shon Howell

Special thanks to George Alec Effinger. Redolet Lucerna

Based on characters & situations created by George Alec Effinger in his novel *When Gravity Fails*

Copyright © 1992 R. Talsorian Games, Inc. All Rights Reserved. *Cyberpunk* © is R. Talsorian's Trademark name for its adventure game of the dark future. All rights reserved under the Universal Copyright Convention. All incidents, situations, and persons portrayed within are fictional, and any similarity, without satiric intent, of characters living or dead is strictly coincidental.

# Forward

Imagine a world where *Casablanca* collides with *Blade Runner*; where intrigue outstrips firepower, and where every crowded bazaar and twisting alley holds its own brand of danger.

Imagine midnight in the Budayeen.

The mullah's call awakes you from a fevered sleep; you stagger to the open window. You blink away your transpex hangover and focus on landscape below—minarets, domes, and microwave receivers spearing up into the desert night. A hot wind sweeps across the moonlit street, scattering dust devils over the ancient cobbles and driving laughing groups of veiled women back into the safety of club doorways. You start to smile a razor smile...

Then a thunderclap splits the night as a static gun hurls its gift of death.

*When Gravity Fails* is the second entry in our *Cyberpunk Masters* series—world-sourcebooks based on the works of the best in the genre. George Alec Effinger's hit series (*When Gravity Fails*, *Fire in the Sun* and *The Exile Kiss*) combines the best of mystery novels, hard science fiction, cutting edge cybertech, and the allure of a foreign land into a hard-hitting package that's hard to top. If you haven't read the novels yet, do it now; I guarantee you won't be disappointed.

For the true Cyberpunker, the world of *Gravity* is particularly fascinating because it takes place in a little known and seldom explored realm of the dark future: the turbulent Middle East. Unlike the metal-hard, steaming black cities of mega-urban America, or the glittering towers and neon palaces of Europe and the Pacific Rim, this is a land of ancient mystery, not easily penetrated by cybertech and the data flow. Here, the secrets run deeper, and the dangers are more subtle. Every face is a mask, and every proverb a warning.

So join us on this journey to another face of the cybersphere. Enter this world and prepare to be changed; to wear another mask. You know you're ready; your seizure gun is charged and you're about to hit those dark alleys. Sure, it's unknown territory. But you can handle it.

Because you're *Cyberpunk*.



Mike Pondsmith



# Contents

## Introduction.....4

Our welcome to the reader entering the exotic world of *When Gravity Fails*.



## History of an Alternate World.....5

The two centuries of political and environmental catastrophes that have formed the *Gravity* world. Included is a comprehensive history of what has gone before, as well as the current world situation.



## The City .....16

Detailing the city, its residents and environments, as described in *When Gravity Fails*. Included are stats for all major characters appearing in the novel, as well as descriptions of important and interesting locations.



## Arabic Culture and Islam.....32

To role-play within a culture, you must understand the workings of it. This is an overview of the regional culture inside *When Gravity Fails*. In Islamic life, culture and religion are everything, so we provide a guide for both, to help players better understand the motivations of those around them.

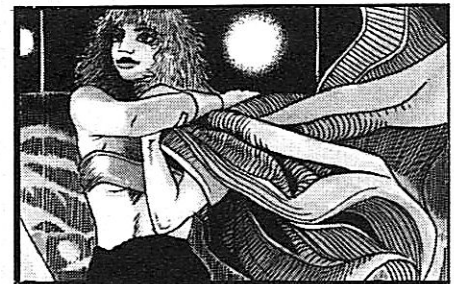

## Hacking through the future.....42

In 2020 the Net was a place of light; in 2202 the Net has faded into fragmented disuse, mirroring much of the real world. To a select few it is still a place of adventure and danger. Included is an overview of the fragmented Net, with rules and equipment new to 2202.

## Tech of the 23rd Century.....65

Centuries of time can influence technological advancement in many ways. Included are rules for new weapons and armor, unique vehicles, and other items. Moddies and daddies have transformed the very minds of Mankind, while genetic surgery has altered their bodies. Plus a system for custom creation and pricing of moddies and daddies, as well as an expansive list of "off the rack" chipware.



## Silken Nights.....82

In the Budayeen, people are not always what they seem, or even what they think... In a rare display of overt generosity, Papa presents a young woman with a gift that transforms her life, and the lives of those around her. A truly unique *Cyberpunk* adventure.



# INTRODUCTION

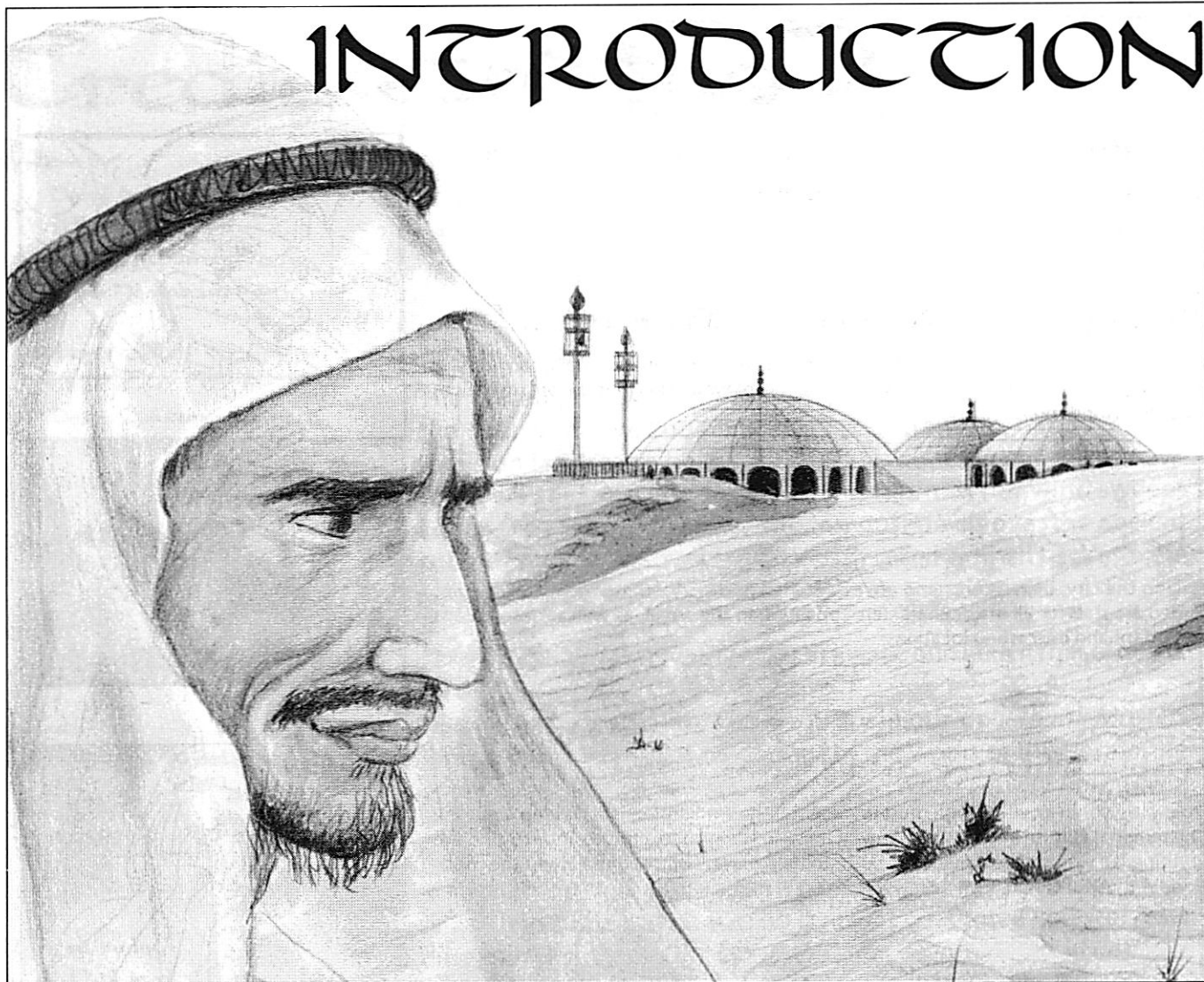

**W**hen George Alec Effinger's novel *When Gravity Fails* was published in 1988, its originality and ingenuity made it an immediate hit among fans of the cyberpunk genre. The most outstanding thing about Effinger's book was its *setting*; not the shell-shocked, burnt-out remains of a once proud Europe or America, or the neon jewel of a corporate-owned Japan, but an exotic and often-overlooked dark future Middle East. Effinger's characters move through a hybrid world, caught between new technology, cyberpunk ideals, and traditional Islamic faith and culture, all set in an anonymous city somewhere in the Islamic world. It is a backdrop unlike any other in the genre, and an opportunity for a whole new kind of *Cyberpunk* role-playing adventure.

*When Gravity Fails* already encompasses two sequels: *A Fire in the Sun* and *The Exile Kiss*. The fourth, *Retribution*, is currently in

production. Reading all three books will give you the best overview of the setting and characters, but only this supplement is necessary for adventuring in the *Gravity* world. This product is intended to give as complete an image as possible of the world at the time of *When Gravity Fails*, and presents the Budayeen and its inhabitants as depicted at the beginning of this first book.

To make this supplement stand on its own we've had to cover a lot of ground not yet touched on in the books themselves. Although George has approved everything we've added, he may need to contradict some elements of this supplement in order to pursue his own vision in future books and stories. Referees should not find it hard to reconcile these differences in their campaigns. As always, the material in this book is meant to serve only as a guideline, leaving you the ultimate arbiter of what is to be included in your adventures. ■



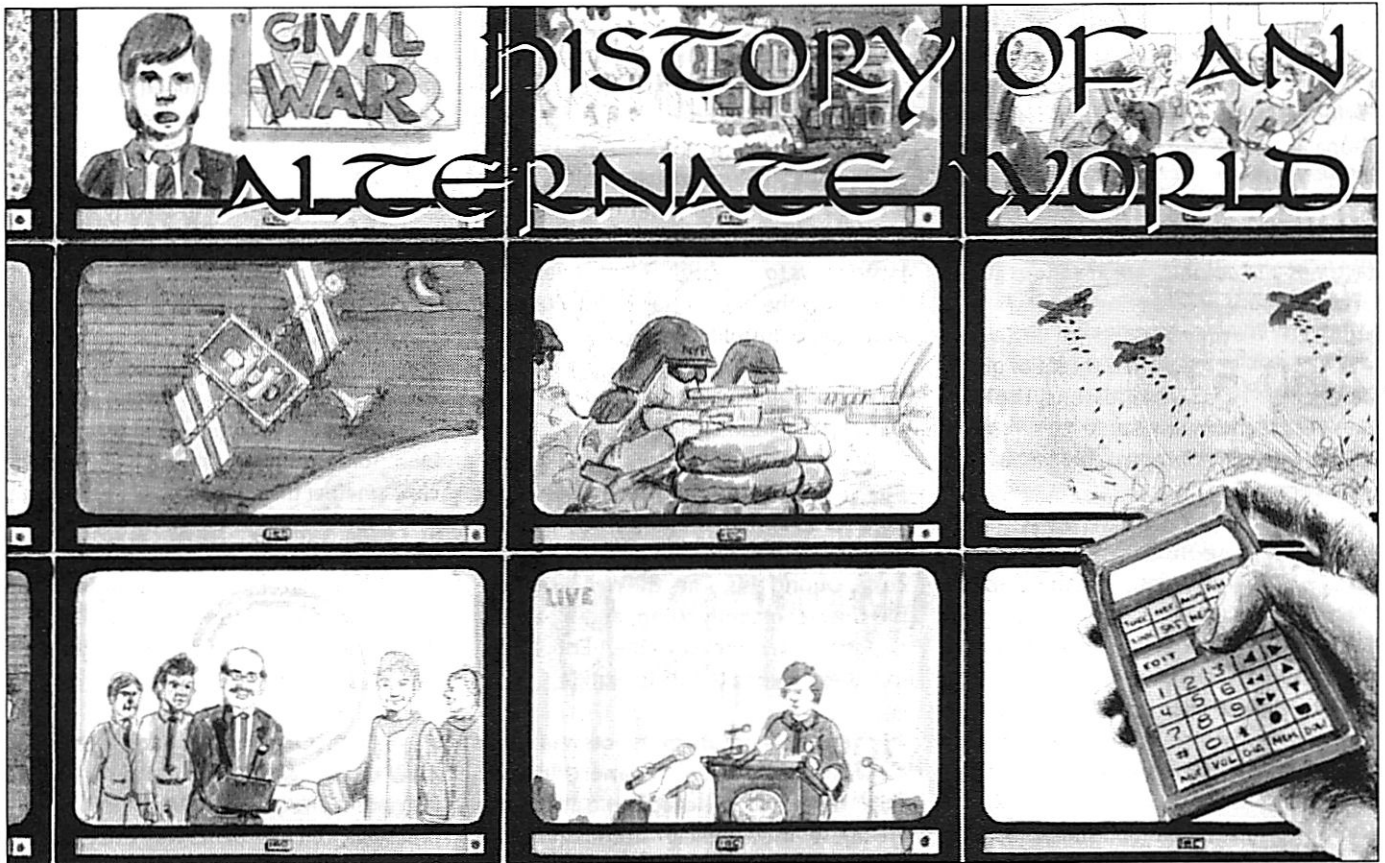

---



---

### NOT WITH A BANG...

---



---

Like most *Cyberpunk* settings, the future of *When Gravity Fails* is not very pleasant. While no world-shattering holocaust has occurred, humanity has definitely taken as many steps backward as forward and the planet shows all the scars. The major factors in this collapse were pollution, overpopulation, scarcity of resources, and mankind's inability to adapt to the world it had created.

---



---

### A TIMELINE OF THE GRAVITY WORLD

---



---

**2000.** The beginning of the "Age of War." First- and Second-world nations exhaust their resources and turn to the Third-world to compensate. The European Economic Community is firmly established, but individual national pride keeps it from reaching full effectiveness.

**2004.** A series of small brushfire wars start as the major superpowers begin grabbing offshore resources. The fighting will last for the next 45 years. Several times it will nearly degenerate into global war.

**2014.** Japan "buys" most of Southeast Asia and begins to form the separate nations into a single economic entity modelled after the EEC. The Japanese call it SACT (the Southeast Asia Coalition Treaty).

**2019-20.** In response to pressures put on South American resources by the United States, Brazil defaults on its World Bank loan. The U.S. uses the default as an excuse for military action and launches a "punitive" invasion.

**2022.** To protect themselves from "foreign aggressors," the Arab League nations mine their oil fields with nuclear warheads. This keeps the Middle East out of the constant scramble for resources.

**2025.** Quebec declares its independence from Canada. This year also starts 25 years of "New Imperialism." Fearing the loss of influence over resource-rich

Third World nations, the industrialized countries rely on military might to hold on to power.

**2029.** The Soviet Union resorts to military action when several of the southern provinces try to declare independence, as attempted in the late 20th Century.

**2031.** The Soviet Union tries to develop Siberia as an oil region. Problems in the south prevent success.

**2035.** Beginning of a three-year famine in the Soviet Union. Rationing is the rule. Many agriculturally productive Soviet republics resent being stripped bare to feed the massive military machine.

**2036.** The Soviet-American space treaty is ratified.

**2039.** South Africa falls in a bloody rebellion mere weeks after signing a mutual-defense pact with Israel.

**2040-48.** The "Space Age" is in full swing. The major nations look to space to save a depleted Earth. Poverty-stricken US and Soviet citizens protest the massive funds being directed into the space



## WHEN GRAVITY FAILS

programs, but governments of all nations agree that man must expand into space if the Earth is to survive. The fighting that has gone on for the last 45 years slowly grinds to a halt; the nations involved simply can't keep going.

**2049.** The *Capricorn* base on Mars is established. Several orbital factories and colonies are in various stages of completion.

**2050-52.** As the threat of global war lessens, the dangers of riots and internal strife increases. The Soviet Union declares martial law to preserve order.

**2054.** The Hollister report on the greenhouse effect is published. A coalition of several nations, including the EEC, the USSR, and Japan, all agree to put aside national differences and work together to help the environment. The coalition dies quietly when an argument occurs as to the location of the first meeting.

**2055.** Riots and protests fill the streets of the United States. Food is scarce due to Midwestern and Californian droughts. Washington lacks the leadership to keep things running smoothly.

**2056.** The United States declares martial law. Presidential elections are suspended "indefinitely" in order to preserve government stability.

**2062.** The *Hoshi Shinju* project is started when Japan's orbital radio telescope detects a planetary system around Epsilon Eridani. A large exploration ship is converted into a colony slowboat and launched under joint Japanese-American funding.

**2070.** The Georgia Republic secedes from the USSR. The fighting lasts for ten years. In the end the Soviet Union fails to recover the rebellious republic.

**2074.** Resurgent nationalism and incompetent leadership splinter the EEC back into its component nations. It stays alive in name only for a few more years.

**2075.** France, India and Germany abandon the United Nations charter. The organization loses what little remains of its influence and dies. Few notice.

**2077.** China enforces stricter birth control as the country's food supply can longer support the massive population.

**2080.** Japan gives the United States an offer it cannot refuse. In return for industrial and trade concessions, Japan offers to reduce the budget deficit. By the end of the decade, Japan owns 88% of American industrial capacity.

**2082.** Presidential elections are reinstated in the US.

**2085.** Many Japanese businesses move their operations to the United States in order to exploit low labor costs. During this time, the mean sea level has been constantly rising, and Japan is in danger of losing several cities. Entire communities move to the US to work.

**2087.** There are mass riots and strikes protesting Japanese "ownership" of America. The Japanese attempt to "readjust" the American attitude. This fails miserably, leading to the return of martial law in the US.

**2088.** U.S. national elections are cancelled, never to return.

**2089.** The *Hoshi Shinju* leaves Earth orbit with a crew of 957.

**2090.** A British/German project follows in the *Hoshi Shinju's* footsteps. It is scheduled to launch the next year.

**2092.** The *Stern Leben* launches, carrying its English and German crew. A Japanese mining colony is up and running on Titan.

**2095.** The *Hoshi Shinju* clears Pluto's orbit.

**2097.** The Japanese mining colony on Titan is destroyed by a nuclear blast from a mining bomb. It is never made clear whether this is an accident or sabotage.

**2098.** The *Stern Leben* is destroyed after suffering a massive system failure around the orbit of Saturn. It is later revealed that the ship was sabotaged by French terrorists.

**2099.** On the eve of the turn of the century, China has become a fully industrialized society. With help from the Japanese, China is on its way to becoming one of the most powerful nations on Earth. It still suffers from tremendous overpopulation.

**2100.** The greenhouse effect takes its toll. The waters of the Earth have risen constantly in the last 100 years. Most of the coastal cities of the 20th century are knee-deep in water.

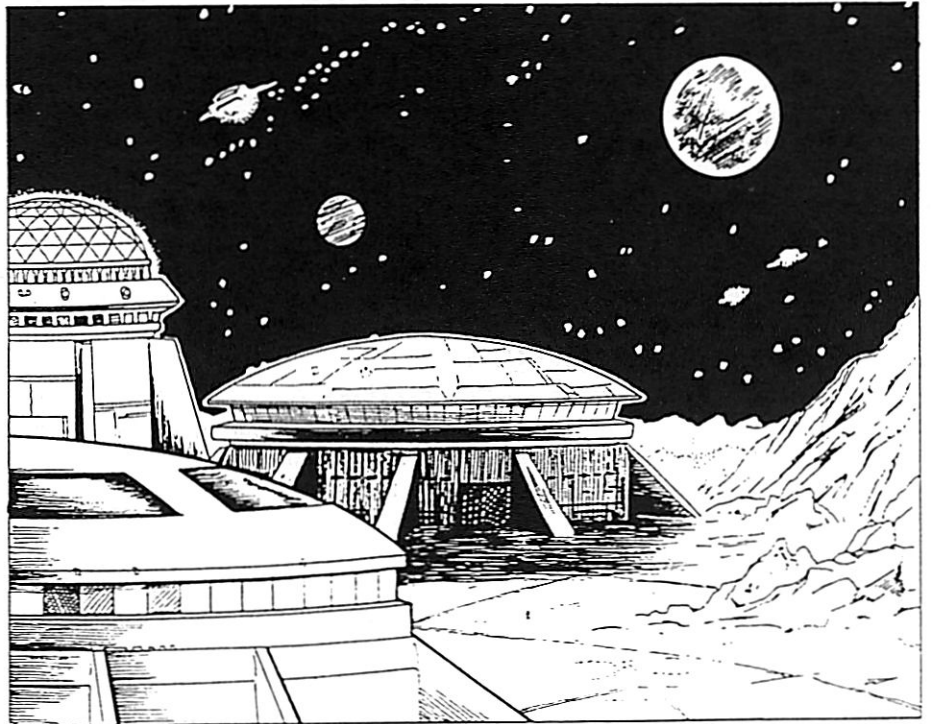



**2105.** The secret of controllable fusion is discovered in Great Britain. It comes too late to do any real good. Only six plants will be built before the Collapse.

**2106-19.** The dying convulsions of the old world order. The superpowers desperately try to hold themselves together while economic and social pressures tear them apart.

**2122.** Syria and Jordan, under fanatic Shiite government, attack Israel. The war lasts for four years. Israel stands, but is weakened by the assault. The founder of the Arab Federate distinguishes himself in battle during this time.

**2130.** The Ukraine declares independence from the Soviet Union. After months of bloody battle, the Soviets decide they don't have the resources to continue the fight.

**2131.** The Soviets use terror tactics to make an example of the Ukraine. Within a few months after the war, Soviet planes drop chemical warheads on the population. Within 24 hours 35% of the population of the Ukraine free state is dead and much of the once-rich ground is poisoned.

**2134.** The American Southeast responds to outrageous tax-

ation and incompetent government by seceding from the Union. The second Civil War is begun. The U.S. Army tries to reclaim the new "American Confederation" by force. The attempt is a failure due to a split in Congress and strong Japanese support for the Confederation. The secession starts a chain reaction within the country. By 2135 the United States has split into seven independent nations.

**2135.** The death throes of the Soviet Union. The tighter the Politburo tries to hold on, the more the country splinters. By the end of the year neither the United States nor the Soviet Union exist as political entities.

**2136-45.** The Texas Alliance for Reunification and The Northeastern Union battle to become the "real" United States. The war leads to even more fragmentation. Ultimately the US degenerates into over 20 small monarchies or police states. Most of the eastern US looks like Europe after WW I: exhausted and shell shocked. During this time, the forces of the Pentagon hire themselves out as military mercenary units.

**2140.** Brazil invades northern Argentina. Most South American nations dissolve into tiny monarchies and police states. Borders change daily. The last message from the *Hoshi Shinju* reaches Earth.

**2141.** Beginning of the "Light of Islam." A Saudi Arabian Sunni general, Bilal Sharif Allah (The Honor of God), starts a unification of the Arab states around the Dead Sea. Later Egypt, Yemen, and North Sudan are integrated. Arab pride and unity grow over the next 10 years.

**2147.** After losing its American influence, Japan declares a new policy of isolationism and withdraws from any western international affairs. It concentrates on consolidating their power and developing Indonesia. The island nations have raw resources the Japanese lack.

**2148-54.** Neues Deutschland invades Poland, triggering an entire series of European brush-fire wars. Lack of resources cause most of the wars to end by 2154. The Soviets make one last attempt at reunification. It ends in failure.

**2151.** The Arab unification is all but complete. The Persian Gulf states make alliances with the kingdoms that once were Chad, Niger, and Ethiopia. Islamic culture grows stronger as the rest of the world falls into confusion.

**2153.** Saudi Arabia finishes a fusion power plant. It also takes over operation of the Capricorn colony on Mars and changes the colony's name to Ares.

**2155.** The Chinese state dissolves when the high standard of living collapses. Overpopulation, famine, and other social pressures tear modern China apart. Regional warlords seize power as centralized government vanishes.

**2159.** The Arab Federate is officially born. It is a spot of light in a dark world, and converts to the Muslim faith roll in by the thousands.

**2160.** Japan and Thailand form the axis of power in the Pacific. There is relative stability in the Western Pacific Rim.

**2175.** The Light of Islam is almost extinguished. Bilal is assassinated and several leaders vie for his position. Outright war is avoided, but the Arab Federate loses much of its unity and power.



## WHEN GRAVITY FAILS

**2176-99.** Known as the "Age of the Jackal" to some historians. The massive social and political forces that have been working to tear the world apart have been slowly winding down. There are still wars, but no nation has the will or the resources to maintain one for any period of time. Nations change names and boundaries almost daily, but by the beginning of the 23rd century things are stabilizing. Economies have adapted. Power comes more with ability, less with weapons. The emphasis is on survival, not political or economic ideals. There are still some who believe the old days will come again, but their numbers are dwindling every day.



---

## THE WORLD OF THE 23RD CENTURY

---

**T**his is a future where many of Man's dreams have turned bitter and fruitless. It is a time of dry cynicism and quick wits, where survival is a daily concern. Unable to adapt quickly enough to the world it created, mankind watched as society disintegrated around it. Gone are the visions of the conquest of space: no one can afford space exploration any more. Gone is the image of a Utopian Earth of technological plenty. You use technology to stay alive; it gives you the edge to survive one more day. The comforts and pleasures of this world are many, but available only to the few who can afford them. Indulge your fantasies, but don't look around too much, and don't ask too many questions.

---

### POLITICS

---

**B**y the early 23rd century the nations of the world have balkanized. There are no superpowers, no multinational power blocs to dictate world policy. Instead there is a collection of disorganized and factional police states, monarchies, and political experiments, each trying to second-guess the others. Political maps of the 23rd Century bear no resemblance to their twentieth century counterparts, and the lines never stop changing.

There are no world leaders, no shining examples for the rest to follow. Monarchies and dictatorships are back in vogue, and alliances between nation-states are tenuous at best. Often the value of treaties can be measured by the price of the paper and ink used to draw them up. Situations change fast; it's almost impossible to keep up with who is ruling what and who they are at war with this week.

---

### TECHNOLOGY AND INDUSTRY

---

**S**ome countries are better off than others. Everyone has less than they might, but some still have more than others. The differences just aren't as extreme as they used to be. The remnants of the First World countries still retain many of the advantages of technological society. The North American and Western European nations (although somewhat battered and no longer united) still have fairly high standards of living and technology. Japan has maintained a solid industrial base, some of which rubs off on Australia and Indonesia. Many of the former members of the Arab Federate retain the advantages of their affiliation in the form of technology and industry. These countries have access to better computers and weapons, more refined medicine, and better communications and transportation than their less fortunate counterparts.

The rest of the world can be considered technologically deprived and under-developed. This includes the location of the novel *When Gravity Fails*, an unnamed city somewhere in the Islamic world, close enough to the Arab Federate to get a tantalizing glimpse of its prosperity. While fairly cosmopolitan, the city is definitely in a Third World nation, rife with poverty and signs of under-industrialization. Economic and cultural isolation let many of the advantages of modern technology pass the city by. By way of example, Friedlander Bey, one of the most powerful individuals in the area, still relies on troublesome donor organ transplants, while in Western Europe, North America, or even some of the more developed areas of the Middle East, he could have made-to-order replacements cloned from his own cells and grown within his body.

---

### THE CORPORATE PRESENCE

---

**I**nternational corporations have increased their power and influence drastically in the last two hundred years. With the break-up of the major alliance blocs, corporations moved to stabilize industrially important areas such as NeuesDeutschland and the Commonwealth of the Western Reserve in the central U.S. While the corporations never took over the governments of any countries, they built a web of influence in international politics and amassed enough

CORPORATION	SPECIALIZING IN	HOME OFFICE
MERCOTECH	COMPUTERS/AIS.	BOSTON, FEDERATED NEW ENGLAND
MOGAMI HONSHU CORP.	MILITARY ELECTRONICS	TOKYO, JAPAN
KEMAL INDUSTRIES	PLASTICS AND TEXTILES	AMMAN, JORDAN
SONNE RIM	GENETIC CONSTRUCTS	OSLO, NORWAY
STUDIO ORTEZ	MODDIES	BARCELONA, CATALONIA
TELEFUNKEN E.K.	PERSONAL ELECTRONICS	MUNICH, NEUESDEUTSCHLAND
BAHIA FABRICA ARMA	MUNITIONS	SALVADOR, BRAZIL
EICHNER-VOSS	SPACE AND AIRCRAFT	ESSEN, WESTPHALIA
KYOTO CYBERNETICS	CYBERNETICS AND MEDICINE	KYOTO, JAPAN
SEDLACEK PRECISION MEDICAL	PORTABLE MEDICAL EQUIPMENT	COPENHAGEN, DENMARK
BLenheim INTERNATIONAL SHIPPING	INT'L TRANSPORT AND CUSTOMS	LIVERPOOL, ENGLAND

power and resources to virtually become nations unto themselves. Based out of no one country, and able to cross borders and consolidate resources at will, the corporations are the envy of many nations.

Although the corporations are some of the most powerful and influential bodies in the world of *Gravity*, they are not really foci for society. Unlike the *zaibatsu* of *Cyberpunk*, the **multinats** don't feel the need to protect their employees or supply them with the basic comforts of life. They haven't formed the shelter of security and pride that breeds loyalty. Their sole tool for unifying people is the paycheck. Corporations in *Gravity* use people like they would any other disposable resource. You don't feel pride belonging to one of these monsters, you just hope that you remain valuable enough to stay on the payroll. Corporations of this era are ruthless and detached. If they burn out a region or population with their exploitation, they merely shut down the operation, pack up the valuables and move on. In this future the human resource is the only resource that is cheap, plentiful, renewable, and available on a world-wide basis.

Consider the multinats to be shadowy megaliths, almost like supernatural things that pursue aims above and beyond the understanding of mere men. They really don't care if they're caught. Who is going to stop them? A village disappears in the Sudan and evidence leads to Amalgamated Fabricators. It seems they needed some raw material for RNA experiments. You may be able to find a regional office, trash it, kill a few lowly lab techs and administrators and shut down a local operation of no real importance. But don't plan on bringing the cold bastards who planned the deed to justice. Make trouble and you will either find

yourself all alone, facing a small army, or ignored as the company has already moved on to the next plan in the next region. The companies slither through the world like gigantic, blind hydras, always seeking the next opportunity.

Anyone going up against the multinats had best be prepared to go the long-haul. Many nations have taken military actions against multinats and lost. Getting corporations to turn on each other is a safer tactic, as in the Global Automation/Hitachi war. Hitachi won, but six countries nationalized assets of both companies during the confusion, crippling the combatants. Divide and conquer can work both ways.

---



---

## MONEY

---



---

he Collapse and the resulting diaspora has made stable economies a rare item. As nations rise and fall, paper money is more valuable as cooking fuel than as a means of international exchange. Naturally, a global currency is pretty much a thing of the past. Even electronic banking is limited mainly to local accounts, with credit cards allowing access. Trying to beam your funds around the world is all but impossible. Trying to nab someone's bank account in the Net will only work if you are in the same area sub-Net.

Precious metals and commodities are the preferred means of trade in this anarchic future. Most countries have taken to minting gold and platinum coins for use on the international market, although they may ban the use of these coins internally. Not that it stops anybody. Gold never goes out of style.

Stocks are still good, too, but the Comsat Triad is a pretty exclusive club. You can

do big purchases by trading stocks, bonds and futures, but they won't buy you a beer in Cairo when you need it.

The only real reminder of past economic unity are the units of currency. The Japanese and European economies were the strongest before the Collapse, so the **yen** and the **euro-mark** are typically used to rate relative value. The Arab Federate established the **kiam** as an equivalent regional currency. The kiam was widely accepted

## MULTINATS IN WHEN GRAVITY FAILS.

23rd century multinational corporations share many attributes with their 21st century counterparts: stockholders, boards of directors, regional offices, and security forces like private armies. Like their predecessors, they give minor lip service to local laws when the country is strong enough to enforce them and ignore them when the authorities are weak or corruptible. Their interests are diverse, perhaps centering around one industry but not limited to it. In fact, many of the original purposes are merely fronts for terribly large buying trusts and investment companies. Like the Mafia of old, the multinats cast long shadows, and no one is really sure who they are.

The above are a few prominent corporations of the 23rd century. While we list the main business and the home office, you can count on world-wide influence and diverse products and holdings. Some, like Kemal Industries, are hundreds of years old, with resources to match. All of these companies are capable of fielding enough troops to storm a small country, but most prefer the low-key approach to domination: money and internal greed. It's more profitable and has a higher success rate.



## WHEN GRAVITY FAILS

due to Federate solvency at the time of issue. For game purposes, the euro-mark and the kiam can be considered equivalent to the Eurodollar of *Cyberpunk*. The conversion for yen is 50 ¥ = 1eb/kiam/EM. Prices are given in euro-marks (EM) and may be converted as needed. The market value of gold in 2202 is 11 EM per gm (about 300 EM per oz.).

---

### COMMODITIES AND TRANSPORT

---

**T**he 23rd century is a study in the effects of balkanization on trade and prosperity. Very few countries can support themselves completely, and when lines of commerce break down, the standard of living suffers.

Because large-scale cooperation is almost impossible in this environment, solutions to many of the resource problems facing the *Gravity* world just aren't being implemented. The quality of life has gone down world-wide, and is hardly what you would expect considering the technology at people's disposal. In the last 30 years, no new fusion plants have been constructed and the technique may be lost. High tech is around, but its effect on daily life can vary drastically due to lack of distribution. You can get cybernetics in third-world countries if you have the money, but they will be limited and expensive. Satellite communications still link the world, but they are costly, maintained by corporations that rent them to countries.

Not only are resources scarce, but it is harder to get them to where they are wanted or needed. A shipment of goods may have to pass through four different countries to get from Maine (Federated New England) to California (The Northwestern Protectorate). It may be held up at any point due to internal conflicts, tariff laws, or paranoia. Avoiding little obstacles like these and getting the dime in on time is how runners (smugglers — see New Character Classes) earn their living. For them business has been good.

Here are a few of the things that runners are moving these days:

**Food:** This simple necessity is rarer in many areas of the world than almost anything else. Rising world temperatures and the disruption of large-scale agriculture have made famine and poverty common conditions. To



add to the problem, by the 21st century several genetically engineered grain and bean strains had become staple crops for much of the world. Designed to be more efficient and durable than their natural progenitors, they all but replaced the old crops. Then, in the chaos of the mid-22nd century, several viruses tailored to attack the new crops got loose. The world starved as fields blackened and died. Now old-world seed stocks and cuttings immune to the viruses are being desperately sought to recultivate the land.

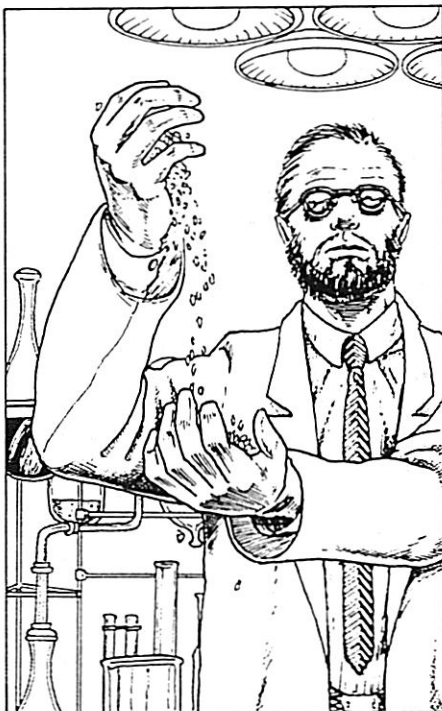

Stockpiles in the Dakota Republics and northern Siberia are raided periodically. Hauling genetic templates or raw seed grain is big business for smugglers. Everybody's got to eat.

On the other hand, the wealthy of many countries still want to be able to taste Beluga Caviar from the Dnepr river in Byelorussia, strawberries from the Northwestern Protectorate, and chardonnay from the Camargue. Since many countries have high tariffs on imports of this kind (in order to keep their struggling domestic markets alive and keep currency at home), runners have made a fair living slipping luxury food items across borders and into the larders of the petty bourgeoisie.

**Cybernetics:** Cybertech is seen as the status symbol for up-and-coming third-world militaries. It seems that you're just not a proper military dictator without a bunch of wired-up super-commandos on your ticket. So everyone is willing to pay for the latest in cyberware, moddies, daddies, or implants. Industrial espionage and competition for neo-tech secrets between companies and countries can run pretty hot, but the rewards can be equally high.

**Weapons:** Given the state of things, it isn't too surprising that there's an active market for tools of destruction. The main demand is for high-tech infantry weapons, but there are always buyers for tailored viruses, heavy artillery and other big-ticket items. Brazil and several European states are the biggest weapons suppliers, and just about everybody's buying.

**Medical Supplies:** New medical advances have created lifesaving and life-extending techniques that are almost miraculous, and therefore in high demand. Be it the newest wonder drug from Switzerland or an operating technique out of the Nippon National Health Labs, you can find a buyer. Your stock might include some of the newest genetic creations: a praying mantis variant that breeds fast enough to destroy whole locust swarms but goes sterile after three generations and then dies off at the end of its eight-day lifespan. Or perhaps a bacteria that can eat the insulating plastic on military lasers, discharging the batteries and shorting out the systems. Sometimes it's just as simple as getting that shipment of anti-toxin through to the underground fighters before the nerve gas seeps into the lowest bunker levels.

**Information:** Data, *Informcao*, *Auskunft*; by any name, it's worth euro-marks. Any

netrunner can tell you about selling data, but the current disorder makes info-handling an art. Situations change so quickly that your tidbit may lose its value in hours if not handled properly and slid to the right people (fixers, you linked to that?). Maybe you're just a runner with a comp full of local bank codes or an administrator moving on the latest tip that the platinum market is about to get pumped. Either way, you're carrying the intangible resource that information represents, and that can mean power and big money. Look at Papa and Abu Adil.

---

### THE ENVIRONMENT: THE HOUSE THAT MAN BUILT

---

**T**he 21st Century saw many of man's worst fears of environmental catastrophe come true, and in 2202 the planet is still reeling. The coastlines have changed substantially as the water-level has risen. Many coastal cities are inundated. Air quality in many regions is often hazardous, and acid rain constantly takes its toll. The good news is that population has stopped growing and actually gone down a bit. Pollution has also eased off somewhat since the 21st century, especially since few can afford large-scale production.

The **greenhouse effect** has changed the face of the world in hundreds of ways. The mean sea level has risen a full 2 meters since the year 2000. New marshes and coastlines have forced the relocations of huge populations. The big coastal cities have been fighting for survival for 200 years. Japan has made a national effort to stave off the drowning of Tokyo and Osaka. Dikes, landfills, and floating arcologies have all been tried, and some have even worked. The U.S. debated long and hard about what to do for New York, during which time much of it went under the waves. Los Angeles traded ghettos for swamps and gave a tide of refugees to Fresno and Bakersfield. New Orleans, Norfolk, San Francisco all tried various techniques, all have had to change radically to survive. The coast of what was Florida, including Miami, Jacksonville, and St. Petersburg, lie inundated. Other low-lying regions around the world, such as the Netherlands and Bengal, suffered equally drastic loss of land and life. The lower cities of the Mediterranean have been shifted inland as the waters rose, with the notable

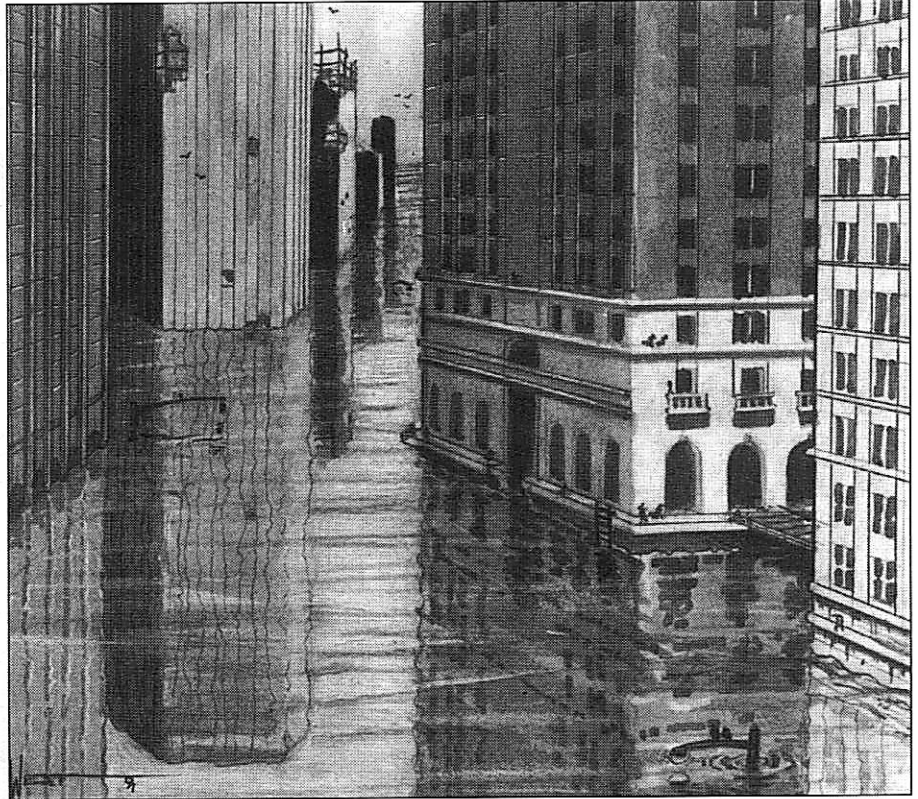

exception of Venice; Italy, in a last gasp of solidarity (and with a lot of help from the rest of Europe), declared Venice an art treasure and instituted a plan to dismantle the entire city and move it up the tide-line to safety. The project failed after 2 years. Even the bulldozers are under water now.

The average global temperature has gone up about 2 degrees Celsius. This is good for some, bad for many. Russia has achieved its dream of a rich climate, but it's main grain-producing areas have moved north into Siberia, where there has been fierce fighting over land. Equatorial countries are alternately parched or drenched. The Breadbasket of central North America has lost 25% of its productivity. Many African and Middle-Eastern climes have had an increase in rain, but much of it is acidic, doing crops more harm than good. The north coast of Antarctica has become marginally usable and is populated with colonists and refugees from dozens of troubled countries. The expatriates have formed the new nation of Antarctica Sovereign along the rocky, frigid shores.

The term "pure as rainwater" is serious hard vac these days. Air pollution is only now thinning to 20th century levels. Latin America and Eastern Europe have suffered the worst from the acid rains which have roamed the winds for a century. Led

fuels and coal left these lands with the legacy of a silent scourge. It's got a lot of names: *Sulch, Angel Piss, Sizzle, Brown Down*; take your pick. It still means ruined water tables and dead crops. The rains reached their peak in about 2155, when it was declared unsafe to walk the streets of Krakow during winter without wearing a sealed suit. The rain has also decimated the Lower Amazon and aided in the devastation of the rainforests. Even in 2202 the sky can still turn brown with hydrogen sulphide and nitrogen oxides. When that happens, it is best to stay indoors.

---

## REGIONS OF THE WORLD

---

### NORTH AFRICA AND THE MIDDLE EAST

---

**F**or a brief period the Arab Federate made this land a locus of information and culture. While these countries are quickly unified by charismatic leaders, they can dissolve just as rapidly when the leaders are removed. With the death of Bilal Sharif Allah the fall of the Federate was assured. The Federate had centered around the Red Sea, with the nations



## WHEN GRAVITY FAILS

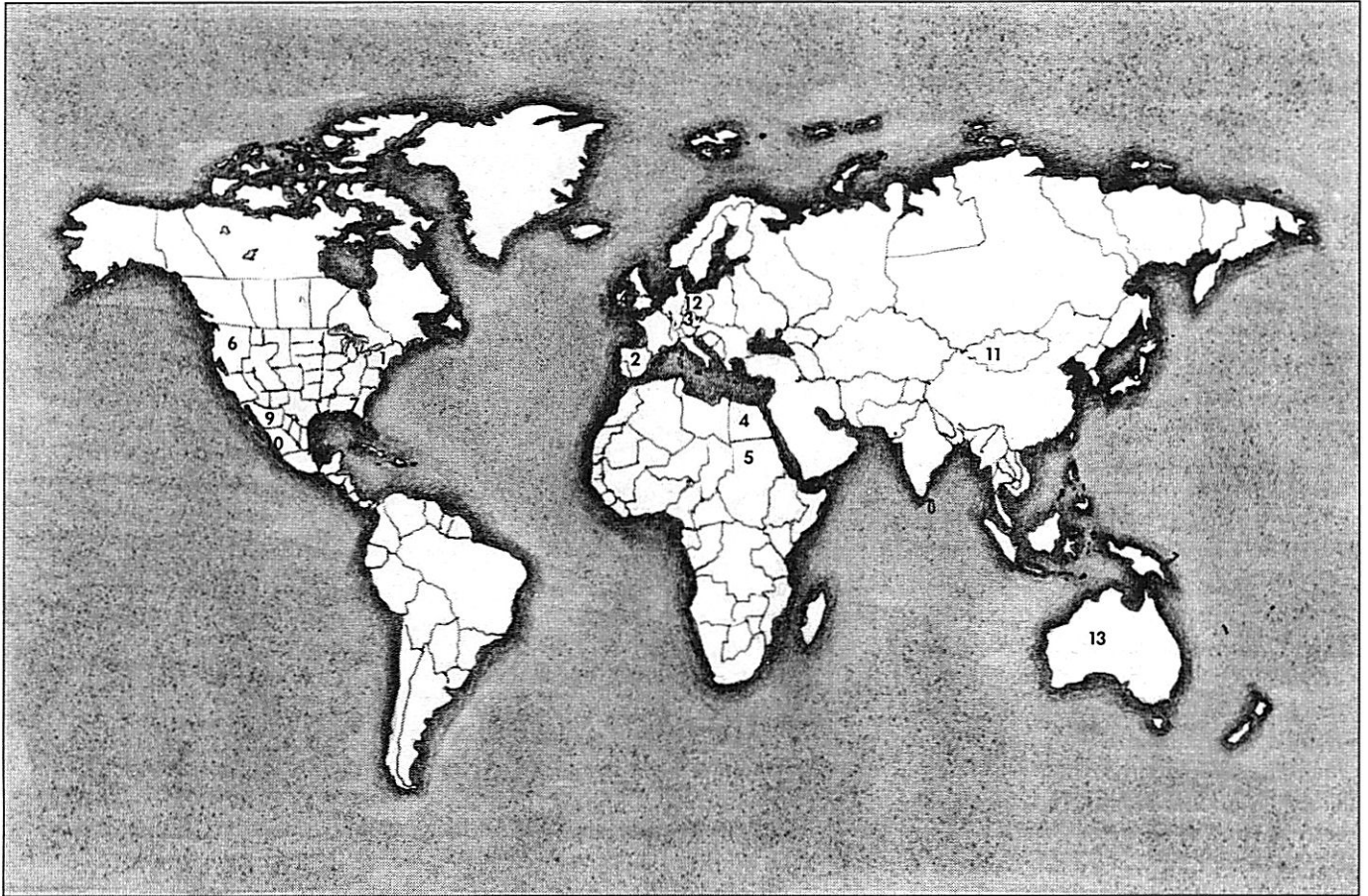

On the above map, published in 2192, only 14 countries still exist as political entities in 2202. 1: Federated New England. 2: Catalonia. 3: Westphalia. 4&5: Upper and Lower Egypt. 6: Northwestern Protectorate. 7: New Confederacy. 8: Japan. 9: Coahuilla. 10: Nuevo Leon. 11: Mongolia. 12: Neues Deutschland. 13: Australia. 14: Ireland.

of Jordan, Northern Saudi Arabia, Yemen, Lebanon, and eastern Egypt. From there it had influenced Iraq, Syria, Northern Sudan (now Egyptian Sudan) and parts of old Iran and Turkey. With the death of Bilal, these areas have swiftly reverted to the factional provinces that they once were.

There are few real nations here, only tribal areas and city states. Saudi Arabia is a case in point. It ceased to be a nation sometime in the late 21st century when the last members of the Saud family fell from power. It was reunited under the Federate, but with its fall, many old sheikdoms and new monarchies re-surfaced. City-states dominate the coasts, and wilderness claims the central deserts. Many other Middle Eastern and North African countries have followed this pattern.

Israel knew its first real peace in ages during the reign of the Federate. Now Israeli paranoia is welling again as its Arab neighbors become more militaristic. Israel is importing huge amounts of weapons and has activated the *Haganah*. The Stern Group has resurfaced as a militant radical

element screaming for Israel to go on the offensive before it's too late. Its cries may become a self-fulfilling prophecy.

Syria, Jordan and Yemen still exist as nations, although their borders have shifted a bit. Egypt has broken into Upper and Lower Kingdoms once again, with the two constantly warring for control of various areas along the Nile, including the Aswan Dam. Libya and Algeria gave up claims in the Sahara and settled into several coastal provinces. They remain countries in name only, and Algeria has reverted to "Mauretania" along the northern coast.

Exports from this area are largely raw materials such as metal ores, phosphates, and cotton. The oil supply was sucked up long ago. Wealth has to be earned in other ways now, and a growing percentage of high-tech items such as medical equipment, electronics, and cybernetics are flowing from the cities around the southern Mediterranean. Cairo has become a center for light industry, specializing in medical cybernetics such as brain-wiring and biomech generation (although the minori-

ty of vocal Shiites have a real problem with this). While Middle Eastern tech may not be as slick as that available elsewhere, it is reliable and relatively inexpensive.

The region maintains a fairly advanced level of technology, including one of the few remaining intact Computer Nets around. But this advanced state is relatively recent; much was lost in the dissolution of the Federate. This leaves the Middle East as it has always been: a study in contrasts. Bedouin tribes maintain a lifestyle thousands of years old while, a few kilometers away, urbane Arab businessmen plan the next twenty years over imported schnapps and holographic displays. When the Federate was at its peak, multinationals poured money and personnel into the Middle East. When the Collapse came, the euro-marks went. Factories set up in 2160 now lie empty. The post-boom economy that survives is one of extremes. Fellahin drawn to the cities now grovel in shanty-towns, denied the jobs and lives they came for. The next generation was raised in urban squalor, looking up at the towers of those

who capitalized on the prosperity and held on to their power. The cities are filled with people waiting for the next *Mahdi* to lead them out of the dark.

---

## JAPAN, INDONESIA AND THE SOUTH PACIFIC

---

**E**ven after the flooding, Japan remains a potent political and industrial force throughout Indonesia and Southeast Asia. Most of its ports have adapted to the higher tide level and the country has fortified its position as an industrial center. The Japanese remain the pioneers of the organized Urban Sprawl. The metroplexes of Osaka/Kyoto and Tokyo/Sendai were models for many other 'plexes world-wide. Now they contain the offices which control commerce through the entire Pacific Rim.

During the "Nippon Diaspora," entire Japanese communities moved to the US. These were isolated from Japan when the West self-destructed. To make up for the loss, Japan strengthened its industrial hold on the Philippines and Indo-China. With Japanese investment, Thailand has also become a center for international trade and business. Ships move in and out of the Gulf carrying manganese, rice, and gold-electrolink circuits. Most go to America or around to the Red Sea and Suez. The pirates operating out of Sri Lanka know better than to mess with the heavily armed Nippon ships. This is not a Japanese Empire, but rather a trade confederation; Japan and Thailand have learned the lessons of empire well.

Australia is just beginning to challenge Japan for a share of the Pacific market. Given rain by a changing climate, and insulated from the disintegration of the West, the Aussies have developed international ambitions. They're ready to take on the world, starting now. They've signed a trade pact with Antarctica Sovereign and have already made claims in revolution-wracked Papua New Guinea, sending in a "peace-keeping" force to quell the turmoil. The Sareket Islam Movement has re-emerged and has become a rallying point for communist rebels. They have clashed with the Australian-supported Dutch refugee population. The Yakuza kumi have interests in the Islamic front that they are not ready to abandon. An underground war is raging, with Australian patrols raiding Yak operations and Yak hiring's retaliating

against the patrols. Japan and Australia keep good diplomatic relations but it is well known that the Yakuza have clandestine Japanese support. The fighting goes on, and both sides are hiring.

---

## NORTH AMERICA AND MEXICO

---

**W**hat used to be the United States is now more than twenty separate countries, each trying to carve an identity for itself. The East Coast includes Federated New England, the New Confederacy (naturally), and the New York Union. Westward is the Commonwealth of the Western Reserve in old Ohio and Indiana, the Great Lakes Alliance of Wisconsin, Illinois, and Michigan, and the Dakota Republics. To the south is Nuevo Tejas, constantly trying to expand into the Mexican states of Coahuila and Nuevo Leon.

The Mormon state of Sovereign Deseret occupies old Utah and parts of eastern Nevada and southern Idaho. Paranoid and fanatical, the Mormons are well-armed and may have imperialistic goals. They are the closest thing America has to a religious dictatorship. The neighboring states keep their guns handy.

The largest ex-US nation is the Northwestern Protectorate, an alliance of the states of Oregon, Washington, and the northern half of California. The Protectorate is isolationist. Except for regular ships to Japan, and railways into the Commonwealth of Columbia, it has little international commerce. The protectorate regularly hires solos and nomads to augment its border guards. A radically pro-environment Socialist government currently has power. Whether it is tyrannical or not is a matter of perspective, but it has achieved a fairly stable economy and seems determined to stay that way.

America is tired. Only after fifty years of war have things settled down to the point where the nation-states can communicate diplomatically with each other. But old wounds and current rivalries keep any hope of growth and unity at bay. Raider bands still roam the country, some descended from the remnants of the US military. Although there haven't been any major wars in 24 years, petty infighting continues between the various nation-states. Intrigue and covert warfare are constant. The state of Nuevo Tejas is muscling for inroads into the northern Mexican States, especially

along the Gulf. The state of Sovereign Deseret lays claim to every unwatched acre at its borders and is in turn closely monitored by the NW Protectorate. Internal conflicts are just as common, with politics and rulers changing daily. America's days of world supremacy are just light-lines on memory bubbles these days.

Canada's large provinces have become independent commonwealths. These are larger than many former US territories, but they are not aggressive. The Northwest Territories are now a rugged collection of Eskimo provinces working to develop their natural resources. Québec has the dubious honor of being the forerunner of the separatist states, and it is one of the best established and most stable. Rising temperatures have made Canada more arable, and for the time being the Canadian States seem content to live off their own resources rather than warring with each other.

After a brief attempt at empire, Mexico broke into thirty different sub-nations. The economic forces and horrible climate covering much of the south doomed any attempt at unification almost before it had begun. The Mexicans squabble over each other's riches when not banding together to defend against raiders from Nuevo Tejas.

A few still struggle to rise above the petty politics. Although limited, the CompNet still exists across North America, Europe, and Asia. Hackers ignore borders as they trade in information and credit across ragged phone and laser links. Nomad packs still roam the roads, holding fast to traditional family values if nothing else. The NW Protectorate has tried to establish the first ecologically sound nation since man discovered fire. While its success is questionable, the attempt is daring. Cooperation and vision aren't common, but they aren't completely lost either.

---

## EUROPE

---

**E**urope is a maze of tiny nations. Listing all of the new nations would be pointless; they will probably be different tomorrow. If there was a state that existed at any time in the last 400 years, it has probably resurfaced. The result is a sort of political confusion. It's harder to get things from here to there, and no one has a real handle on what's going on in the neighboring nations, but the people have remained fairly civilized.



## WHEN GRAVITY FAILS

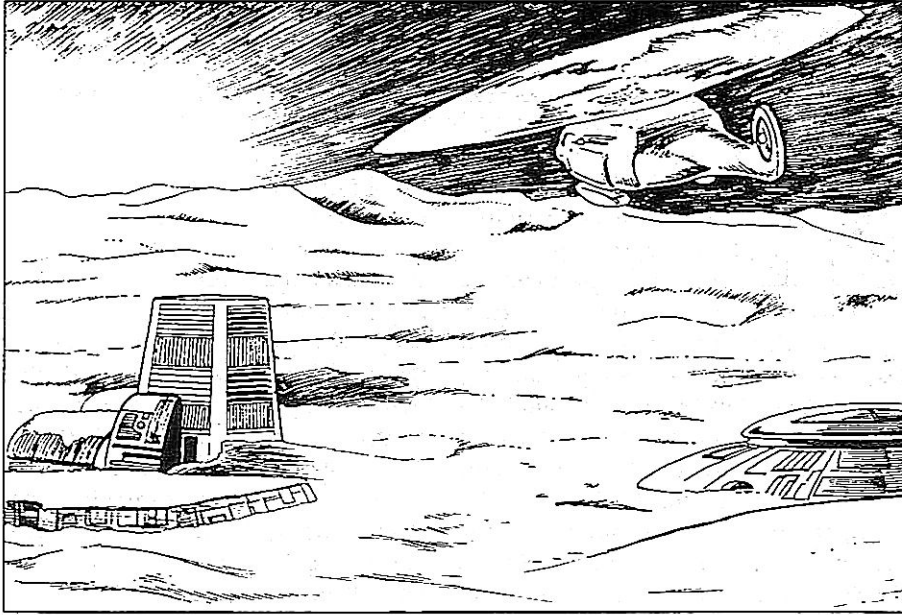

Things aren't really any better in Europe; it's just that the European people have adapted more easily to the shifting nature of the current world. Some of the revolutions have been peaceful. Others bloody and vicious, and there are still more to come. Political ideas are still screamed across the town plazas while guerillas sit in cellars and make hand grenades out of beer bottles, detergent, and gasoline. Governments constantly plot to bring about the downfall of their neighbors while trying to keep the masses at bay. But this has happened before in these lands. The people have learned to go on despite it all.

There are no major powers in Europe. The Soviet Union is no more and the Soviet Republics are independent nations now. NeuesDeutschland has declared the Fourth Reich, but without Westphalia or Jutland there is little to back it up. Supremacy is being decided by revolution and sabotage, not invasion.

The European CompNet may have a lot of holes in it, but many have been quick to use this Net to gain the Edge. Euro brainburners are linking with American hackers to form an unofficial network of information and services. Europe is a continent of intrigue and violence, but also beauty and tradition. It's an ideal place for intrepid mercenaries, smugglers, and deal-makers. Job opportunities abound, but don't expect to be able to remain neutral for long. You play—you choose sides.

---

### SOUTH AMERICA

---

**S**urprisingly stable after 100 years of war and exploitation, the Latin nations are slowly beginning to re-establish themselves. Brazil, Peru, Argentina and others have all lost territories to secession, but they have since stabilized. Despite losing the western Amazon, Brazil has built a strong export economy in munitions and military hardware. Many other South and Central American nations also support strong export trades. Ecologically, however, most are devastated and they are now eyeing each other as sources of raw materials. If these nations don't go to war with each other again in the next ten years they may become a force to be reckoned with.

---

### CHINA AND INDIA

---

**T**ibet has achieved independence, but other than that, China has become a patchwork of warlord and communist states. While trade does flow slowly between them, all of these states are incredibly paranoid, and unrecognized or unlicensed traders and travelers are often killed at the borders. Some coastal regions are allied with Japan, but none of these can claim any territory more than 30 kilometers inland.

India has shattered into a dozen provinces with caste and resource wars crossing all borders. The south is quietest, which is to say you might not get caught up in the food riots or religious killings.

---

### SUB-SAHARAN AFRICA

---

**A**frica has broken into small tribal kingdoms and revolutionary states; Ethiopia is the only fully intact pre-Dissolution nation. The continent is fairly isolationist, and trying to sort itself out without outside interference. Things have been that way for 50 years now, without measurable progress, and seem just as chaotic as ever.

---

### ANTARCTICA SOVEREIGN

---

**T**his fledgling Antarctic nation is still struggling to carve a place for itself on the warming shores. Its polyglot population of refugees has been keeping runners busy hauling in any technology and supplies they can get, and they don't ask where it comes from. The Antarticans have established hydroponic agriculture and are just now reaching the self-sufficiency point; things could still go either way.

---

### SPACE

---

**T**wo hundred years of space exploration has left a surprisingly small mark on the Solar System. An archipelago of orbital colonies still function in near-Earth orbit. Six contain at least 4,000,000 people apiece. The largest colony is Emersonville, with a population of 6,600,000. The orbitals' monopoly on zero-gee manufacturing gives them the freedom to trade with anyone they want, and traffic to and from orbit is brisk. The colonies mainly buy organics to keep their systems stocked, while selling pharmaceuticals, foam metals, and zero-gee electronics in return.

Orbital life is freewheeling and rich compared to many ground societies. Technology is abundant by necessity, and conditions in the larger colonies are clean and well-controlled. While some of the smaller colonies are merely subsistence-level operations, the major cylinders have active theater, art and

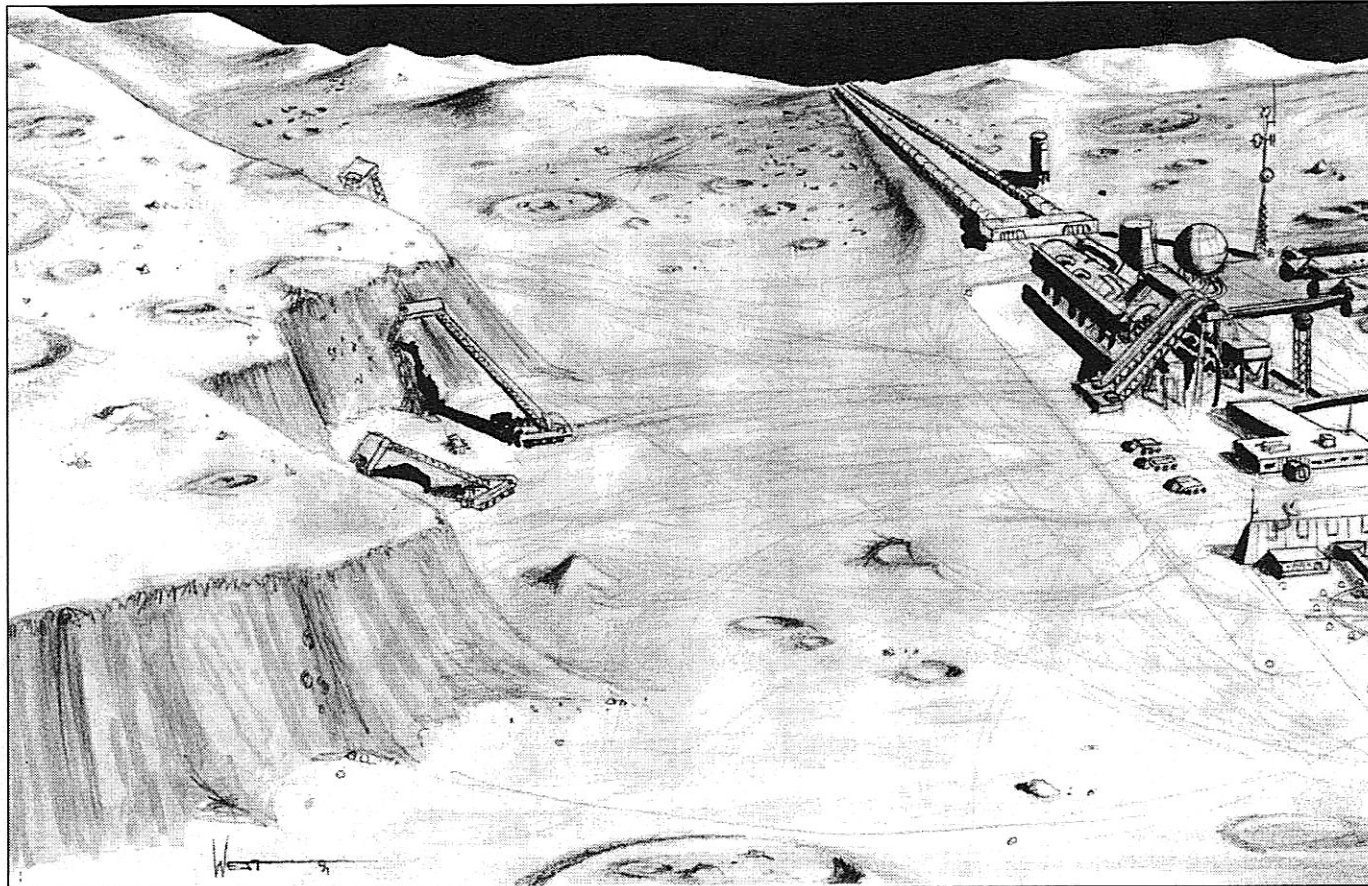

leisure activities. Spacers enjoy bardic competitions, music, and z-g ballet. Orbital life may be the last refuge of high (!) culture.

The Moon base at Mare Orientale also sells raw materials to the orbital colonies, using mass drivers to send iron modules containing metals, silicon, oxygen, and water out to the Trojan Points to be picked up by tugs. While little more than an industrial site, the Moon Base has a rotating population of about 15,000, most from the orbital colonies.

Work on the Moon is largely mining and refining, and the Moon Base is considered harsh and uncomfortable next to the relative luxury of the colonies. A one-year term working in a Lunar industry is mandatory for all orbital immigrants. Immigration to the orbital colonies is tightly controlled, but there is always a place for a person with the right skills.

The intrigue and competition from down the gravity well has also infected the orbitals, such that no unified front exists. However, the orbitals will never fight each other. Over 50,000 lives were lost during the Wars of Dissolution (when two colonies perforated each other's hulls with anti-satellite weapons as their parent countries warred).

“  
Attempts at colonising  
Titan and Ganymede have  
all failed, leaving only  
empty pressure domes as  
monuments...  
”

The disaster only solidified the orbitals' desire for independence from earthly conflicts. The colonies feel safest when confusion and disunity reign downstairs. Any Earther attempts to shut down or control the Lunar pipeline have met with violent response from the orbital lasers and anti-satellite weapons now under control of the colonies. No rocks have been dropped. Yet.

Ares, the Mars colony, is a series of domed structures near the buttes of the south polar region. The colony's main problem is that it has no export other than knowledge. The colony has become a center for astronomical study and research into space sciences, but little of that is profitable; in fact, while relatively self-sufficient, the

population of 123,000 still needs some supplies from Earth, and only support from the nations of the old Arab Federate has allowed the Mars colony to remain operational. The Mars colonists still struggle with the task of terraforming Mars, but the scale of the job is daunting and work proceeds only sporadically. Still, if you're not welcome anywhere else in the Solar System, Mars needs trained personnel, few questions asked.

Slowboats travel between the Mars colony and near-earth orbit fairly regularly. Depending on the orbital positions of Earth and Mars, a one-way trip takes from 4 to 8 months, so tourism isn't the prime reason for travel.

Throughout the Solar System, man's reach has exceeded his grasp. Once there were hundreds of asteroid mining operations tapping the rich rock fields between Mars and Jupiter. Now there are only twenty-two, mostly selling raw materials to the orbitals. Attempts at colonizing Titan and Ganymede have all failed, leaving only empty pressure domes as monuments. There has been no contact with the *Hoshi Shinju* colony ship for over one hundred years. Man has flailed against the Big Dark, found himself wanting, and crawled back into his cave. ■



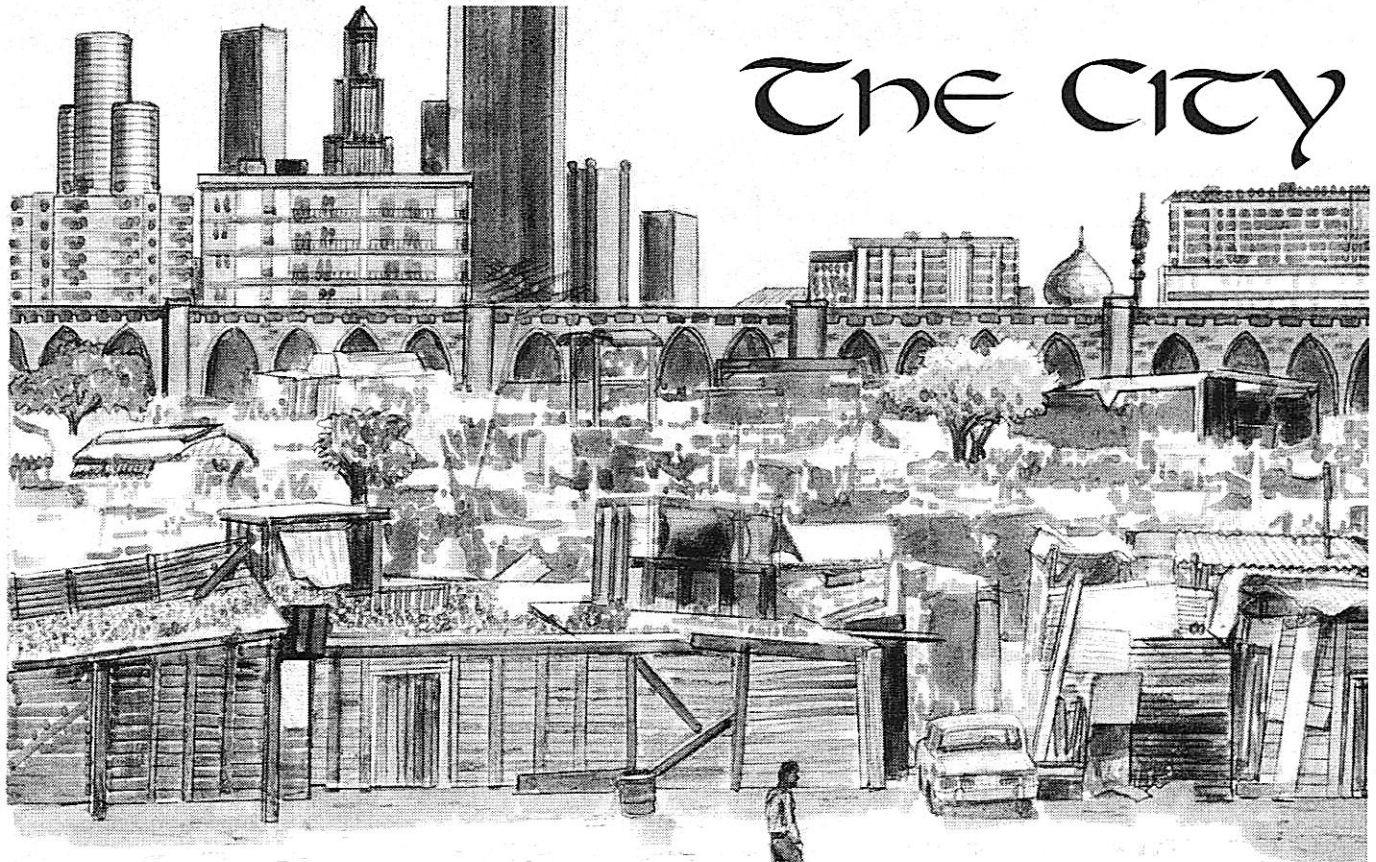

# The City

The City lies at the edge of an unnamed desert, fifty miles from the coast, on the fringes of what was once the Arab Federate. Almost 2,500,000 people live in it, making it one of the largest cities in the region. For a city this size, it's got a good feel to it; clean and alive, not like many European or American cities. Even the air is clean, step outside and you can smell dry, desert winds scented with spices, flowers, and date palms. The streets are crowded with scooters, taxis, and horse carts, all of which make so much of a racket that the Muslim faithful need a city-wide network of loudspeakers to hear the *muezzin* call them to prayer. There are few private cars; most of the city's residents can't afford them and there is little room to park them anyway.

Because the city once lay within the borders of the Arab Federate, it has received many of the benefits which the Federate had to offer. Fortunately, the city also didn't suffer as heavily from the splintering of the AF as many other places did. The main airfield, thirty miles to the north, is still intact, as is the canal that runs fifty miles to the coast, bringing in cargo and sailors. The canal, airfield, and the railways that run through the city ensure a constant, life-giving flow of tourists and goods.

The soil around the city is red; as are many of the old clay buildings to be found therein. Some of the newer concrete buildings are painted red to match their earthen counterparts. Only the towers in the old corporate sector stand apart in their decaying trappings of western-style glass and steel. The Arabs weren't much for building up, so they built out. They still like to keep their houses and shops packed close together, separated only by narrow walkways. From the air, most of the city looks like big, solid blocks with main streets running between, but it's really a maze of twisting side streets and tiny alleys full of shops and houses.

came, but somehow the big multinationals decided that there was money to be made here. The corporations needed people to exploit and so, lured by the promise of paying jobs and a better life, the people came, leaving by the thousands their farms and goat herds.

The city couldn't accommodate them all, so immigrants built homes outside the walls. At first there were thousands of hand-built shacks, followed later by government-funded housing projects. The area became known as Hâmidiyya, and it became home to most of the city's blue collar workers. It was a time of growth for the city and prosperity for its people.

This Golden Age came to a rather abrupt end when the Arab Federate splintered and the corporations pulled out, leaving no means of support for the huge population. Overnight an entire class of people found itself without jobs; a generation of people who couldn't return to the ways of their parents. Hâmidiyya soon became a run-down area with too many people and not enough money. Now, almost 300,000 people live here, although only about 40,000 have real jobs. Many live by begging, (or by any other means they can find).

---

## AREAS OF THE CITY

---

### HÂMIDIYYA

---

The city wasn't always huge; before the Arab Federate came into being, only a few hundred thousand people lived here, and very few of them were foreigners. Then, with the coming of the *Light of Islam*, the corporations arrived. Few people remember why they

The residents of Hâmidīyya don't hate the corporations for what happened to them; it was the will of God. This doesn't mean that they're at all satisfied with their lot. Westerners aren't very popular in this neighborhood. The police don't patrol it very much, so many things go on down there that nobody ever hears about. People disappear; a body, living or dead, can command a good price from the right buyer. It's also the territory of the *Jaish* — the Citizens' Army, a gang of ultra right-wing thugs that likes to harass and beat up anybody it thinks deserves it. That usually means foreigners, particularly Americans. Sometimes the *Jaish* parades around the city in their grey uniforms, calling for the removal of all non-Arabs from the city.

---



---

### THE MEDINAH

---



---

**T**he oldest part of the city is the Medinah, the original core of the city, built around 1250 AD. The Medinah is a typical Arabic neighborhood: a mixture of the residential and the commercial with little separation between the two. In this maze of crowded alleyways, merchants offer spices, candles, bolts of cotton and silk, domestic and exotic animals, books, rugs, produce, and everything else. The squares are filled with storytellers, performers, water-sellers, beggars and soothsayers.

Most of the businesses in the Medinah are organized into *souks*, open squares devoted to one type of business. There are rug *souks*, spice *souks*, animal *souks* and so on. Restaurants and cafes are not organized in *souks*, but are common in the squares. The Medinah is traveled almost exclusively by foot. Except for the main squares and a couple of large streets there just isn't enough space for cars (or even scooters).

---



---

### THE CORPORATE BUSINESS DISTRICT

---



---

**O**n the other end of the scale is the corporate business district, a fifteen block area just south of the amir's palace, and the home of the multinats. The area has become a sad parody of the western metropolitan ideal. The buildings are hundred-story monoliths of technology and flash. Some were thrown up

by the corps; others by Arabs buying into the dream. Until the bottom fell out. Now about a quarter of these offices are empty and many of the others are filled with locals renting cheap.

---



---

### THE FOREIGN QUARTER

---



---

**B**ack in the 14th century there were only Muslim, Jewish, and Christian quarters in the city. All foreigners living within the city walls had to reside in one of the latter two areas. These districts were home to rich merchants, diplomats from foreign lands and so on. As the centuries passed, more and more foreigners from around the world came to the city, bringing with them a multitude of languages and cultures. Many came to escape from something: political persecution, warfare, pollution, boredom. . . . Many have concealed their true identities to protect themselves, and the foreign quarter is a dangerous place to be poking around.

The villa's here are still luxurious, with enclosed courtyards and fountains, but the foreign quarter also shows the influence of its western residents: apartment buildings, supermarkets and shopping malls. The main shopping mall is the *Medinah 2000*, a tacky, westernized imitation of the real Medinah, with open-air booths, neon signs, fast-food stands and glitzy shops offering western goods. It is unpopular with the natives, having none of the style or humanity of the original; no storytellers, no familiar or enticing odors, no soothsayers. The only real similarity to the original is the high beggar population, but at the mall most of the beggars are westerners.

---



---

### THE NEW AMUSEMENT DISTRICT

---



---

**T**he New Amusement District is a park area on the north end of the Boulevard il-Jameel (see below), next to the foreign quarter. Built by the multinats for their employees, here they constructed western-style restaurants and arcades. Across the canal, the designers set sports and recreational parks for bocci, tennis, golf and other diversions. When the multinats left, local entrepreneurs took over. Now the restaurants have naked dancing girls to draw in customers and casi-

nos have sprung up, much to the disapproval of the *imams*, who tolerate the vices only as long as they remain in the walled quarter (one Budayeen is enough for them).

---



---

### ESTATES

---



---

**S**ome of the more affluent and mysterious foreigners own estates on the outskirts of the city. They like their privacy and have gone to a great deal of trouble to insulate themselves from the prying eyes of natives and foreigners alike. Some of these men and women own businesses within the city; others have more suspect means of support.

The two most luxurious estates belong to the men who unofficially run the city. The estate toward the center of the city (near the Christian quarter) belongs to Friedlander Bey. The house is a sprawling, three-story mansion with a private driveway. It is surrounded by high, ivy-covered walls and large, well tended gardens with pools, fountains and date palms. Friedlander Bey values his privacy, and only a very few, select individuals have been allowed to visit his house.

The second estate belongs to Reda Abu Adil, Friedlander Bey's rival, and is located in Hâmidīyya, near the Medinah. It rivals the house of Friedlander Bay in its opulence, but it looks out of place surrounded by block after block of poverty.

A third, less-lavish estate belongs to Herr Lutz Seipolt (See *People of the City*). Herr Seipolt's estate is the last outpost of civilization on the southeastern edge of the city; beyond his home lies only desert, but you'd never know it from inside its walls. Date palms and gardens surround him, brought grudgingly to life by an expensive irrigation system. Walls and guards keep uninvited individuals from enjoying the comforts of this private oasis.

---



---

## PLACES TO SEE AND BE SEEN

---



---

**T**he *Madrasa Al-Ahqaf* (College of the Sand Dunes) is an Islamic university, and the largest in the city. Originally it was little more than a gathering of scholars who came together to keep alive the traditions of the Qurân,



## WHEN GRAVITY FAILS

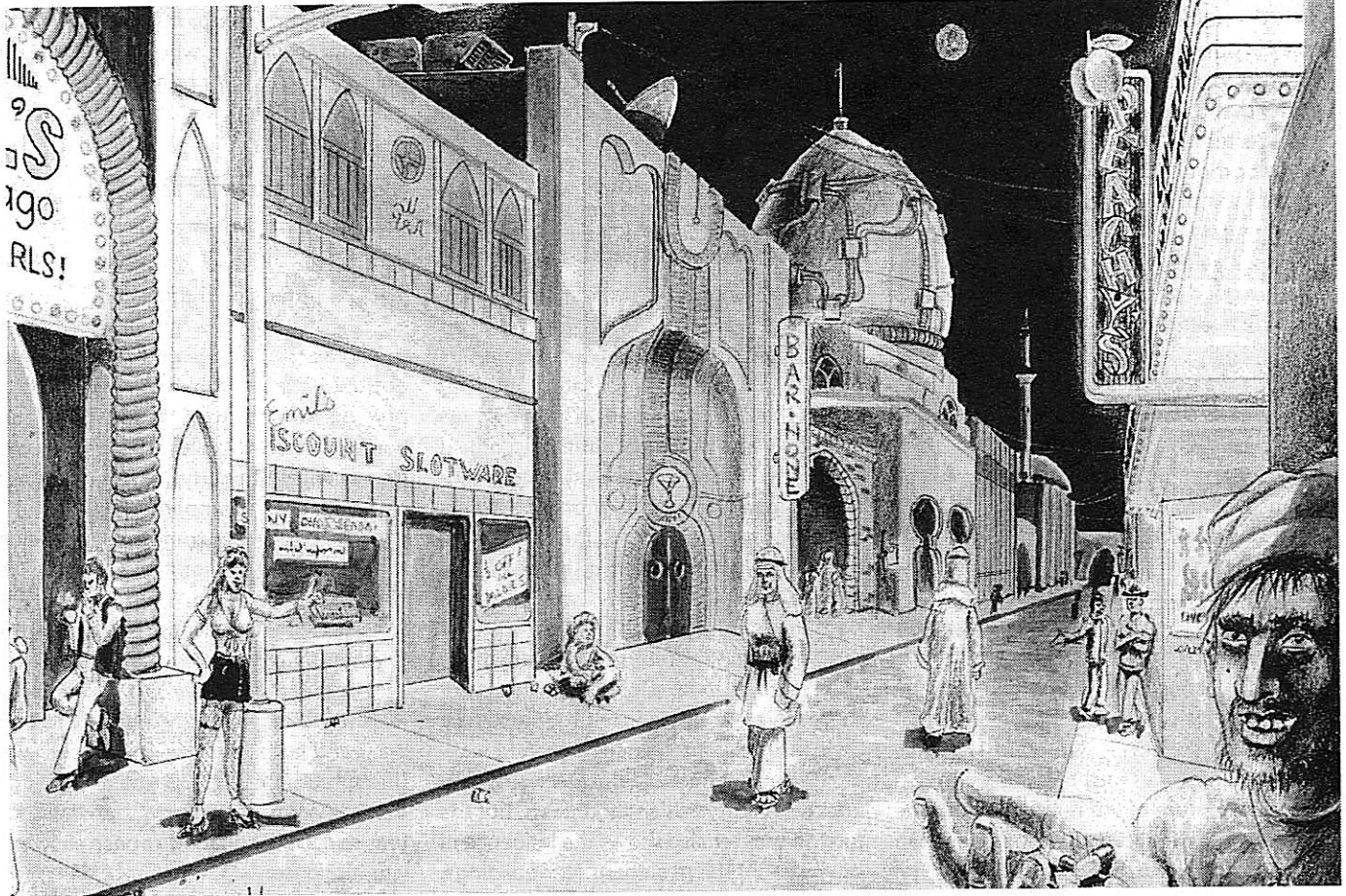

**J**ust outside the eastern gate of the Budayeen lies the tree lined Boulevard il-Jameel. A spacious neutral ground separates the north-and southbound traffic. The center-strip is planted with several varieties of flowering shrubs. There's always something in bloom, filling the air along the boulevard with sweet scents and distracting the eyes of passers-by with startling colors. Larks, warblers and ring doves sing from the tops of the date palms lining the boulevard and from the roofs of nearby buildings. It is one of the prettiest areas of the city.

and to aid laymen with their duties to the church. But as the city grew, so did the school. When the Arab Federate came into being, it computerized and updated the libraries in all the *madraas* inside its borders. Most of these schools suffered when the AF splintered, but not this one. It is one of the finest Muslim colleges still in existence, attracting students from all over the Islamic world and the rest of the globe.

The city also boasts the El-Amir Hospital, one of the region's leading centers for implant research. The Arabs lag behind the

West in some technologies, especially cloning and transplants (orthodox Muslims still haven't accepted the ideas of clones; it's too close to playing God for them). Most of the people in the city can't afford top-notch or specialized health care, so there are several clinics set up around the city which offer basic health services at little or no charge. The interns and nurses working at these clinics are often still learning their trade, (so even a simple blood test can be a long ordeal), but it's better than no treatment at all. Daily the clinics are packed full of poor locals seeking treatment at all hours.

Running north and south from the Al-Islam Square, dividing the city into the more traditional areas to the west and the newer, westernized districts to the east, is the Boulevard il-Jameel. Lining the boulevard are an assortment of high-priced shops and department stores selling European clothing, the latest in electronic devices, and almost anything else that you might want from anywhere in the world. There are also expensive high-rise hotels like the Swiss-owned Hotel Palazzo di Marco Aurelio: twenty stories of glass and steel and pastel-colored rooms with spec-

tacular views of the nicer areas of the city. Of course, none of the expensive guest-room windows face Hâmidiyya. People don't want to look at that sort of thing.

---

## THE BUDAYEEN

---

**T**he Budayeen is the part of the city most captivating to foreigners. The Budayeen operates (despite strict Islamic law) because the *imams* and the *qadi* realized that, although they might not be able to *eradicate* sin, they could at least contain it. The walls around the Budayeen were constructed to provide a moral lesson to the faithful. Since the Budayeen offers all the forbidden carnal pleasures of the world (alcoholic drink, fornication, drugs), pleasures that once indulged in there are often only two possible outcomes, salvation or death. Reflecting this concept, there are only two gates to the Budayeen. The eastern gate faces religious remainder of the city, and therefore represents repentance and salvation, and the western gate opens into the cemetery. The symbolism is obvious, but those who fre-

quent the Budayeen don't seem to take the *imams'* lesson very seriously.

Lots of the Budayeen's visitors like to fool themselves into believing that they're safe because the copshop is just across the boulevard from the eastern gate. They're wrong; the cemetery at the opposite end of the Budayeen is full of the unmarked graves of people who thought that the police would come to their rescue before the lights went out. The three-story police building may be close to the Budayeen, but the cops are much more interested in containing the problems of the Budayeen than solving them. When the cops do come inside the walls, they stick to the street unless they're on a call. The police will help you after you've been victimized (if you're still alive), but there is little they can do to prevent something from happening to you. Also, the local precinct is responsible for many more upscale areas, so you know where most of the patrols go.

Stepping into the Budayeen is like stepping into another world. Surrounded on three sides by twenty foot walls, and with no motor traffic allowed except for emergency vehicles, most of the rush and noise of the city is closed out. But for all that, Budayeen street life is as active as that of the Medinah. Street hustlers will try to sell you almost any kind of pleasure you can imagine, and guides will offer to take you to the best bars, gambling houses, or opium dens. Working girls will offer to fit you in as a "date". Laughter and music filter out of the open club doorways. Strangers to the Budayeen are reasonably safe as long as they don't stray off the main routes. If they start to wander down the side streets or, Allah protect them, down any of the numerous back alleyways, they may never see home again.

The principal walkway (called the Street) runs sixteen blocks straight through the Budayeen, from the east gate to the cemetery at the west end. For the first two or three blocks, the Street isn't too seedy. Open-air cafes line the sidewalks, and a variety of legitimate shops can be found down the first couple of side streets. It's not until you go a little further that the real Budayeen reveals itself to you, starting somewhere between the third and fourth cross-streets. The hookers become more evident and the hotel signs start to advertise rates by the hour. Shops become less numerous and more suspect and clubs with neon signs for girls, gambling, and alcohol prevail.

**"F**renchy has a policy of not hiring debs. Girls are all right with him, and debs who've had their full changes, but the ones stuck indecisively in the middle make him feel that they might get stuck in the middle of some other important transaction, and he doesn't want to be held responsible."—*When Gravity Fails*

---

### CLUBS AND SHOPS: BUYING AND SELLING IN THE BUDAYEEN

---

he first club you'll come to as you walk up the Street is **Big Al's Old Chicago**. The word on the street is that Big Al is a former Mafioso from Chicago. He keeps pictures of all the biggies on the walls: Capone, Dillinger, and Lucky Luciano. He's even got a dart board with Elliot Ness' face on it (although few people recognize it). Al runs his own distillery in the basement and there's a casino in the back room. The crowning attraction is an antique Thompson submachine gun mounted above the bar. Big Al once used the Thompson on a customer who expressed his dissatisfaction with a needle gun. Lots of westerners like to hang out here. They come in wearing their E.G. Robinson or Jimmy Cagney moddies and act tough. If you need some muscle this is a good place to start looking.

The next club up the street is **Chiriga's**. Located right at the center of the Budayeen, Chiri's is probably the best moddy club inside the walls. The locals have a saying: "The Budayeen hides from the light," and Chiri lives up to that statement very well; she keeps her club dark. The stage is well-lit, but that doesn't help the illumination for the rest of the room. The darkness is effective in this club. It makes the girls seem less predatory and it provides an atmosphere of mystery for the tourists. Of course, Chiri may be just keeping the light off any private business that may be occurring at any of her booths or tables. It's a good place for clandestine meetings.

The third moddy club on the Street is **Frenchy's**. Frenchy Benoit has been running his club almost since before the walls were completed, and only Chiri's is as old. Frenchy charges a bit more for his drinks than the other clubs do, but he looks on it as insurance. And he doesn't allow debs — count on it. You're paying to be in his club with real girls,

not some guy who looks like a girl. None of the other clubs can guarantee the genders of their employees, but you pay for it here.

The other two moddy clubs in the Budayeen worth mentioning are the **Red Light Lounge** and **Jo-Mama's**. The Red Light is probably the worst club in the Budayeen (if not the whole of the city). The liquor is watered, the place is a mess, and the girls are lowlifes. The place is a dive, one step up from the street. Violent incidents are common here.

It's cheap, though.

Jo-Mama's is interesting because it caters to Greek merchant seamen, among others. If you need to contact someone in the shipping industry this is the place for it. It is also a friendly bar; Jo-Mama will treat you as if she's known you for years, swapping jokes and telling stories all night long. Don't be deceived though, she'll hold back your change even if she *has* known you since birth (she's a sly one). Jo-Mama's is also unique in that it's the only place in the Budayeen where you can really feel safe. Jo-Mama doesn't stand for any trouble in *her* bar. She's been known to prove that point by pulling out her needle gun when things get rowdy and blazing away until things are quiet again, one way or another.

Not all of the establishments in the Budayeen run illegal activities. Many of them are completely legitimate, but would find life outside the walls difficult. The **Transpex Arcade** is a good example. At the arcade players use their corymbic implants to hook into a computer system and mentally duel with each other at games of skill (see *The Technology of When Gravity Fails* for a detailed description).

The Budayeen is also a good place to find surplus body parts at good prices. The **Eyes of Texas**, on First Street, is a good place to go if you need some new eyewear or eye-ware, and **Electroniques** over on Fifth is just the place for the enthusiastic hobbyist. If you're looking for something unique in the way of moddies or daddies then **Laila's** down Fourth Street is the place for you. It may not look like much, with its dirty windows, flickering neon sign and dusty, jumbled inventory, but this store is a treasure house. Laila has, or can get, moddies and daddies of any type, legal or not. She's also a whiz at building her own moddies. Many bootleg moddies are dangerous and untrustworthy, but Laila's have a reputation for reliability.



## WHEN GRAVITY FAILS

Magic is still a large part of the Arabic way of life, and the Budayeen also has herb shops to cater to its witches. Most witches use potions and herbs, and there are several seemingly innocent herb shops in the Budayeen which would be shut down immediately if they were anywhere else.

There are two kinds of Arab magic: *Sahar*, the Evil Eye, is purely sympathetic, a lot like voodoo. *Sahar* doesn't work well on foreigners; you have to believe in the witch's power before she can put a hex on you. *Sukil* is the second type of Arab magic. It involves the use of drugs, and can therefore affect anybody. *Sukil* practitioners can do just about anything with their drugs: make your hair fall out, make you impotent, or put you into a trance so they can plant suggestions in your mind.

Then there's the enigma of Hassan's. The casual bargain-hunter will be mystified as to what Hassan's shop actually sells. All that you're likely to see when you enter the shop is a young boy watching the doorway. This is because the shop is virtually empty. Since Hassan deals in everything, there is no reason for him to display his wares. Hassan can provide *anything*, from books and bombs to guns and marital aids. But since his shop has only a limited amount of space, it would be impractical for him to try and keep one of everything on hand all of the time. If Hassan doesn't have what you're looking for in

stock he'll have it for you in a day or two at the most. Cash in advance only. Hassan also works for Friedlander Bey (Papa) as an intermediary agent. If you need to speak with Papa, or have a problem with one of his people, you go to Hassan.

The Budayeen also has shops that would be permitted outside the walls, such as rug merchants and smoke shops. It's the goings-on in their back rooms that wouldn't be permitted outside the walls. Back alley opium dens, dice games, even cock-fighting arenas and slave markets can be found in some of the more out-of-the-way stores.

---

---

### RESIDENTS OF THE BUDAYEEN

---

---

**M**any people actually live in the Budayeen. Most live in one of the several apartment buildings located toward the ends of the side streets. These range in quality from reasonably decent to just above the tenements in Hâmidiiyya. Where there are people living, there are grocery stores, a few small, family-owned places with the basics. If you really need to stock up, go to the Medinah. There are also plenty of people living on the streets of the Budayeen, surviving on their wits. These people sleep in back alleys and doorways, begging or hustling for money.

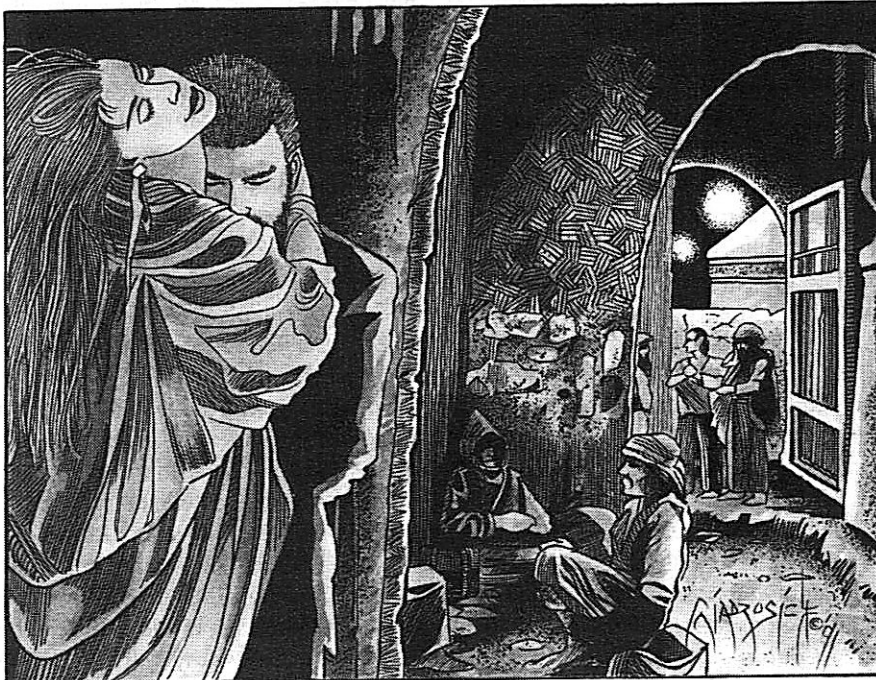

---

---

## NOTES ON THE CITY

---

---

**T**he exact location of the city is never revealed in Effinger's stories. It's located somewhere in the vast Islamic world, between Morocco and Indonesia, fifty miles from a saltwater coastline. All areas included, it's approximately 10 miles across and 20 miles long. Trying to put exact borders on it is difficult (And George wants it that way).

---

---

### POLITICS

---

---

**T**he *amir* of the city, Shaykh Mahali, resides in the northern quarter with the government offices a few blocks south. The amir is a respected man doing his best to maintain some sense of identity for the government. The bureaucracy below him is where decisions really get made. The City bureaucracy is a good place to have friends. Getting anything done is otherwise almost impossible. The local government is well aware that its powers have limits. These limits are defined by the interests and power of Friedlander Bey and Reda Abu Adil. The dog knows where its leash ends.

---

---

### NEIGHBORHOODS

---

---

**T**he City is typical of this area; principally Muslim but with a fair number of Christians and Jews. Old, but having recently expanded, the city consists of a sprawl of diverse and distinct neighborhoods. Maghrebi, Berber, Bedouin and other cultures can be found. One minute you may be strolling in the fellahîn neighborhood, the next in the affluent sector, stumbling over the Christian quarter in-between. Fellahîn neighborhoods are usually winding mazes of narrow streets with market places, small mosques, and multi-storey houses running together. Hâmidiiyya is worse: ramshackle houses leaning against each other to keep from falling into the streets, and people whose lives revolve around getting their next meal and staying alive.

Rasmiyya is a middle class neighborhood with a more modern feeling to it than



the traditional older areas. Successful families live here, sampling the luxuries of the West while trying to hold true to the Five Pillars of Islam. Cops try to keep this place safe and quiet; these people are the taxpayers. The Rasmiyya area borders the Corporate Business District, and is populated by people who still cling to the remainder of the corporate presence.

The *Haffa-a-Khala* (Edge of the Wilderness), on the eastern edge of the city, is similar to Rasmiyya but not quite as upscale. You'll find more people of the true faith and a lot more sand. Some wealthy people, such as Lutz Seipolt, live here for the relative solitude. The western part of the city has many of the industrial areas, most abandoned now that the corporations have moved elsewhere. The docks are here, rubbing up against Hâmidîyya and the Medinah. Not many cops, but a lot of security guards with itchy trigger fingers, and people looking for quick kiam, maybe yours. Watch your back.

---

### TRANSPORTATION

---

**F**leet and scooters are the two most common ways to get around. There are also electric taxis and bike rikshaws which can get you to most places. Horse-cabs are a quaint hold-over from the past, popular with the tourists and priced accordingly. A freight railroad runs

parallel to the canal, and barges run constantly up and down the canal itself. The streets are narrow and confusing, and most are accessible only to foot traffic.

Public transportation is almost nonexistent. Buses only go in and out of town from the terminal on the north end of the boulevard. Airliners and sub-orbital shuttles leave via the airfield thirty miles north of the city.

---

### PUBLIC SERVICES

---

**Hospitals:** The El-Amir Hospital is the largest, but several clinics are spread through the Rasmiyya and fellahîn quarters. See the *Technology* section for details on medicine and enhancement.

**Information:** Use your phone to call into the city phone net. Public info is accessible there, but it's mostly dull, useless stuff for tourists. Still, it can be a help if you're lost.

**Police:** There are two police forces in the city: the real cops and the *Mutasib* (the religious police). The real cops do an okay job of keeping the streets of the better neighborhoods safe. The rest of the city is pretty much on its own. Cops are usually seen in two-man patrol cars or walking the beat the old-fashioned way. They run the gamut from corrupt bullies to devout Muslim paladins. In emergencies they can call out an impressive arsenal, but they prefer to use

**T**he Rasmiyya is the part of the city most like Night City, with corporate trappings and middle class residents. You can use the Night City encounter tables here, with a little cultural modification to account for things such as foreigner-bashing and religious fundamentalists.

non-lethal (if not necessarily painless) means to end arguments.

The *Mutasib*, while unofficial, is a recognized power. The *Mutasib* monitor the religious practices of the Muslim populace. While generally unarmed, they have the ability to close businesses, charge fines and ostracize people. Few are corrupt, but their fanaticism is far more annoying than any corruption. They are especially busy during the holy month of Ramadân. If you're a foreigner, watch yourself.

---

## THE

## UNDERWORLD

---

**A**lthough located in the "Third World," the city has had enough contact with "modern" society to have a real conglomeration of interests, not the least of which is organized crime. In this industry, two individuals of particular interest have chosen this city as their home. Two people whose influence extends far beyond the city itself.





## WHEN GRAVITY FAILS

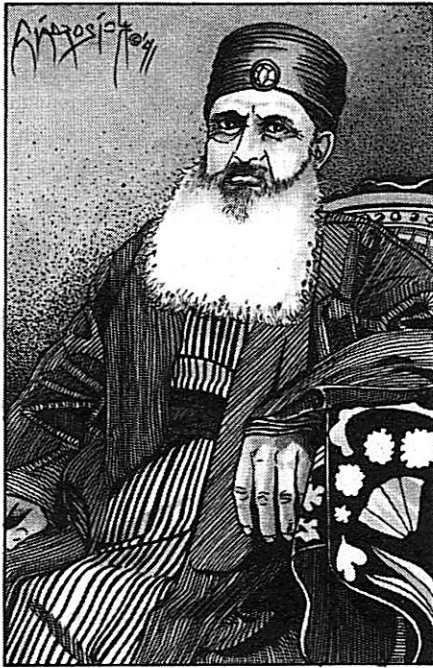

---

### FRIEDLANDER BEY

---

**F**riedlander Bey, or Papa as he is known on the Street, is one of the two men who really control this city. Everyone in the Budayeen works for Papa, as do many people in the rest of the city. He owns most of the clubs, brothels, and cookshops in the Budayeen, and a fair number of establishments outside of it. At least Papa's fair about it. It's perfectly all right with him if you want to run your business on your own. As long as you don't bother him, he won't bother you. But most of the independent operators end up working for Papa eventually. He offers a lot of incentives, and as long as he gets his cut he really doesn't care what goes on in your back room or what you sell. Around the Budayeen they say Papa doesn't just have connections, he *is* connections.

---

### REDA ABU ADIL

---

**L**ike all businessmen, Papa has his competition. Papa's competition is Reda Abu Adil. Abu Adil runs Hâmidiyya, on the far side of the city from Papa's domain. He owns most of the tenements in the area and keeps conditions just above those on the street. People will do anything for money in Hâmidiyya and that suits Abu Adil just fine. He's actively involved

in slave-trading, protection rackets, prostitution, gambling, money-laundering, counterfeiting and any other crime that turns a profit. There's no room for competition in Abu Adil's domain; either you work for him or you don't work at all. Abu Adil simply removes any thorns in his side by pruning them off the bush. He'll usually tell you what you're going to do for him, too. It doesn't do to have too many opium dens in one area. It has also been noted that the *Jaish*, once a completely independent organization, has increasingly become a gang of enforcers under Abu Adil's control.

---

### THE RELATIONSHIP BETWEEN PAPA AND ABU ADIL

---

**N**either Papa nor Abu Adil have much to do with the daily running of their businesses. They oversee, coordinate, and plot. Most of the actual business is handled by intermediaries such as Hassan the Shiite in the Budayeen, Lutz Seipolt in the export business, and the *Jaish* in the enforcement racket. They in turn are served by various underlings who are in turn served and so on down the line. Ultimately, the dirty work is usually done by someone who could never be traced back to Papa or Abu Adil. They are careful to remain above suspicion and see that they are never directly connected with anything. If the authorities could connect Papa or Abu Adil to many of the goings-on in Hâmidiyya or the Budayeen, it would certainly mean exile for the guilty parties. Both men have representatives within the police force to see that any incriminating evidence is lost or destroyed. No one on the streets would risk the wrath of either one by informing.

On the surface these two men would simply seem to be local crime lords, but the criminal activities of their associates are just a small portion of their empires. Their real wealth and power comes from their other business: information brokering. In this ever-troubled world, nations are in a constant state of flux due to revolutions, coups, invasions, and so on. Governments change on an almost daily basis. Papa and Abu Adil have taken upon themselves the monumental task of keeping track of who rules what, who works for whom, how many people live where, and where the borders are redrawn each day. They sell this information to the various nations and leaders of the world that

require it. Payments for these services are not always cash. The more powerful nations often pay in goods, services, and favors. Favors like this mean immense power.

Outwardly, the two houses maintain a cordial and friendly relationship. Open warfare and competition between Papa and Abu Adil for information sales has been avoided by means of an agreement which splits the world in two. Nations in an area falling under the jurisdiction of one are no business of the other. The Muslim world in Africa is divided along the Sahara. Of course, each individual keeps track of everything anyway, just in case the competition disappears. If a representative of some nation or power approaches the wrong house for aid, he will be kindly directed to the competition. The two houses are not overly concerned with each other's holdings in the city, because their real wealth lies elsewhere. Even though the two houses have a working business arrangement, they are each plotting the demise of the other; Abu Adil because he is greedy, Papa because he knows he must deal with Abu Adil sooner or later. Actions against one another are subtle, but nevertheless designed to disrupt the smooth running of business. Shipments are often lost or hijacked by "reactionary forces," satellite communications are garbled or lost completely due to malfunctions, and neither man is above supporting revolutions within the other's sphere of influence just to make his job that much more difficult. From time to time even the corporations have been manipulated to good effect.

---

### OTHER UNDERWORLD GROUPS

---

**A**part from the *Jaish* there aren't any gangs *per se*. There are a few small groups of thieves and muggers around the city. Mostly they will work independently and then pool their hauls. Most of these tough guys stick to either Hâmidiyya or the Budayeen. Then there are the smugglers. Smugglers sometimes work for one of the big houses, but mostly they like to work on their own for smaller interests. Hassan uses these men all the time. The City beggars often work in groups, hoping to increase their take. They can be found throughout the city; from the Medinah to the Budayeen.



---

## PEOPLE OF THE CITY

---

The following are key characters from the novel and important people in the city and the Budayeen. Some of the people listed in this section are placed in new character classes. These individuals have new skills and special abilities listed in bold type. There are detailed descriptions of new skills and classes in the *Adventuring in the 23rd Century* section.

---

### Marîd Audran: Private Investigator

---

INT 7, REF 6, COOL 6, TECH 4, ATTR 7,  
LUCK 7, MA 6, EMP 7, BODY 6

**Research +4**, Awareness +5, Interview +4,  
Handgun +2, Brawling +6, Human Perception  
+3, Streetwise +8, Shadow +4, Intimidate  
+3, Persuasion and Fast Talk +7, Social +5,  
French +4, English +1, Greek +1, Dodge +4,  
Drive +2, Wrestling +5, Disguise +6, **Manual  
Computer Use +3**, Urban Survival +3

**Cyberware:** see below.

Marîd Audran is the principal character of the *When Gravity Fails* series. All of the other characters relate to him in one way or another in the course of the book. For game purposes he can be treated like any other NPC.

Marîd's name means "sickness," following an old Arab superstition that naming a child after a particular misfortune will ward off the actual occurrence. He was born in Algiers, the illegitimate son of a French sailor and an Algerian prostitute. His family background made for a tough upbringing. Fed up with his lot in life, and afraid that his mother might sell him as she did his brother, Marîd ran away to the city in his late teens. He made his living on the street by hustling for every kiam he could get his hands on. Over time, he gained an intimate familiarity with the Street and the Budayeen. With a quick mind and a little muscle, he's moved up since first arriving in the city. Marîd now works as an investigator of sorts. If you've got a problem that the police can't help you with, Marîd will help you out discreetly and for a fair price.

Marîd has always been proud of the fact that he's never been wired. He likes the idea that with his unaltered brain he can best any chipped-in punk in the city. He also scorns guns. Marîd, although not a complete junkie, is addicted to several of the various drugs which are available on the street. He uses them to give him an edge and make life in a rough area a little more tolerable. Marîd is frequently on some kind of pill — usually more than one kind at a time.

During *When Gravity Fails* Marîd does get his brain wired, courtesy of Papa. Marîd's posterior implant is completely conventional. It is his anterior implant that is unique. With it he can use daddies which affect several more specialized diencephalic structures. He has chips to block out disturbing visual, audible, and tactile signals. He is also able to control, augment, or override most of his other bodily functions, giving him the power to indefinitely suppress hunger and fatigue. These chips give Marîd an advantage, but they have limitations. He can't struggle on with one leg shot off, and if he ignores hunger and fatigue signs for too long, his body will just shut down. The main drawback is that once he unplugs one of



## WHEN GRAVITY FAILS



these chips, the sensations that have been bypassed hit him all at once. This can be a traumatic and painful experience (see Advanced Cortical Implant Surgery in the section *The Technology of When Gravity Fails*). Papa also had the pain center of Marid's brain wired. This has two uses. First: to ensure Marid's loyalty. Second: if Marid wishes, he can plug in a special Black chip which stimulates his pain center, turning him into a raging, unstoppable creature of destruction. Marid uses the Black chip only once in the course of *When Gravity Fails* and will not willingly use it again. When using Marid as an NPC the referee can decide to use him either before or after he was wired.

---

### Lt. Okking: Cop

---

INT 9, REF 8, COOL 7, TECH 4, ATTR 6, LUCK 5, MA 6, EMP 7, BODY 6

Authority +5, Awareness +5, Handgun +6, Human perception +4, Athletics +3, Education +4, Brawling +4, Melee +4, Interrogation +4, Streetwise +4, French +4, Arabic +2, Driving +4, Weaponsmith +3, Shadow +3, Accounting +4

Cyberware: none.

Lt. Okking originally came from one of the now dilapidated and bankrupt European countries. In the city, he is in charge of the affairs of the Budayeen. He's a good cop

with an impossible job to do, so he lets most of the crime in the Budayeen go. Only when a crime is too heinous to be ignored does he go into action. Okking does a pretty good job of keeping a lid on things because he has a knack for getting along with the innumerable squabbling factions residing under his jurisdiction. Almost everyone in the Budayeen has a reason to either hate, fear, or distrust police, but they all agree that Lt. Okking is all right (for a cop). Unknown to his superiors, he has performed services for various foreign powers with interests in the city. This doesn't mean that he's on the take; it's just that he knows that these powers are going to do whatever they want and it's best all around if he can make it easier for them to accomplish their goals without disrupting daily city life or resorting to murder.

---

### Sgt. Hajjar: Cop

---

INT 7, REF 8, COOL 6, TECH 4, ATTR 4, LUCK 6, MA 6, EMP 6, BODY 5

Authority +3, Awareness +4, Handgun +5, Human Perception +3, Athletics +4, Education +3, Brawling +5, Melee +5, Interrogation +5, Streetwise +6, Forgery +4, Intimidate +4, Pick Pocket +4, Pick Lock +5

Cyberware: none.

Originally from Syria, Sgt. Hajjar had a long arrest record in his native country, every-

thing from petty theft to assault and battery. Hajjar is what most people in the Budayeen think of when they think of cops. A swaggering, overbearing, tin-starred punk with a license to blast away whenever he likes. He particularly enjoys hassling Arabs who are inattentive in their spiritual duties, which means practically everyone in the Budayeen. His psych file states that he is not to be trusted; he's been suspected of smuggling drugs and money into prisoners, and he's been investigated in connection with the disappearance of a good deal of confiscated property. Hajjar is probably profiting from his position on the force by selling his influence to private citizens or criminal organizations. He is certainly not above extortion, racketeering, and conspiracy. Currently Sgt. Hajjar is employed by Friedlander Bey to monitor the activities of the police with regard to his operations inside the Budayeen.

---

### Friedlander Bey (Papa): Corporate/Fixer

---

INT 9, REF 5, COOL 8, TECH 3, LUCK 9, ATTR 5, MA 4, EMP 7, BODY 6

Resources +9, Awareness +7, Human Perception +8, Education +7, Library Search +3, Social +9, Persuasion and Fast Talk +9, Stock Market +7, Wardrobe +7, Personal Grooming +7, History +8, English +7, German +5, French +5, Japanese +4, Expert: Islam +7

Cyberware: none.

The word on the Street is that Friedlander Bey might be as much as two hundred years old. He has an archaic sense of what is honor, what is business, and what is loyalty. He dispenses his favors and punishments like a local god. You don't want his disapproval. Papa never forgets anything. If need be, he hires other people to carry his grudges for him. He's a pious Muslim, there are few other men as sincere in their beliefs or as glad to meet their obligations to the teachings of the Qur'an, but he can be harsh and even cruel at times. Papa believes that, now that the West is weakened, it is a time for Islam to complete the conquest that it began so many centuries before. *Jihad*, the holy war. To this end, Papa will lend support to both sides of struggles which seem to have no bearing upon him or his empire. These conflicts serve to further weaken the infidel, and he uses his payments to strengthen his forces for when the *Jihad* begins.

**Habib & Labib, the Stones That Speak: Solo**

INT 5, REF 9, COOL 10, TECH 4, LUCK 6, ATTR 4, MA 6, EMP 3, BODY 10

Awareness +4, Handgun +5, Brawling +6, Melee +5, Wrestling +5, Rifle +3, Athletics +4, SMG +3, Stealth +3, Combat Sense +4, Endurance +7, Strength Feat +8, Intimidate +9, Driving +4

**Cyberware:** none.

What can be said about pillars of sandstone that walk and speak? These two huge, intimidating men have been with House Bey for their entire lives. Serving as Friedlander Bey's bodyguards, they are always at least within earshot, if not actually in the presence of their master. For all intents and purposes, Habib and Labib are identical, although no one knows if they are twins, clones, or have been biosculpted to appear alike. They will each respond to either name. They are terse, generally limiting themselves to one word commands like "come" or "sit." People listen to these commands like they were the words of Papa himself. It's the only healthy attitude. Nobody can remember a time when Papa was without these two.

**Hassan the Shiite: Fixer**

INT 9, REF 8, COOL 6, TECH 4, ATTR 6, LUCK 5, MA 5, EMP 5, BODY 4

Streetdeal +8, Awareness +9, Forgery +4, Handgun +3, Brawling +3, Melee +3, Pick Lock +1, Pick Pocket +1, Intimidate +6, Persuasion and Fast Talk +7, Social +5, Perform +5, Accounting +4, Education +4

**Cyberware:** none.

Hassan works as an intermediary for Friedlander Bey. If you want to talk to Papa, you talk to Hassan first. Most business with Papa is handled through Hassan, unless you are of sufficient social standing to rate an audience with Papa himself. Hassan serves as an arbitrator, settling disputes between people who are indirectly employed by Papa. Hassan also runs a shop on the Street which deals in every conceivable commodity. A short, plump man in his fifties, Hassan is very courteous, but he exploits his favored position to no end. Not

being a particularly brave man, Hassan prefers to leave violence and action to those better suited to it; however when it comes to intrigue in the smoke-filled back rooms of the Budayeen, nobody can match him. Hassan is also something of a hypocrite. He claims he will not use brain implants for religious reasons, but he is known to the police to be a pederast.

**Referee Note:** If you've read the book, then you know that Hassan also is a sadistic murderer who likes to use a vicious "black moddy" on his wired victims while torturing them. He commits a series of murders for foreign powers in *When Gravity Fails*. He is shrewd, and conceals his perversions well while abusing his position in Papa's organization.



**Yasmin Nablusi: Stripper**

INT 7, REF 6, COOL 5, TECH 4, ATTR 9, LUCK 6, MA 6, EMP 8, BODY 7

**Vamp** +7, Seduction +5, Persuasion and Fast Talk +4, Dance +6, Streetwise +3, Perform +5, Personal Grooming +6, Wardrobe +5, Interview +5, Awareness +4, Handgun +2, Brawling +4

**Cyberware:** corymbic implant with several language daddies and sexually oriented moddies. Also a perfect sex-change body.

Yasmin is Marîd's sex-change girlfriend. She has one of those perfect bodies that you can buy out of a catalog, but her long, straight, black hair is original equipment. She has the characteristically large hands and feet that most male-to-female sex-changes do. Yasmin works as a dancer at Frenchy's. She is famous around the Budayeen for being late for almost everything, including work. She's not lazy, she just loves to sleep. Frenchy fines her fifty kiam every time she comes in late, but she doesn't care. As one of the best hustlers on the Street, she can make the money back in no time. Yasmin likes her boyfriend to act like he is in a Bogart film, with a Bogart moddy if at all possible. Yasmin is also a firm believer in the *I Ching*. She carries a small *I Ching* machine with her which she consults whenever life becomes too weird for her.



**Laila: Techie**

INT 7, REF 5, COOL 5, TECH 9, ATTR 4, LUCK 6, MA 5, EMP 4, BODY 4

Jury Rig +3, Awareness +4, Basic Tech +4, Cybertech +5, Teaching +2, Education and General Knowledge +5, Electronics +5, Modular Tech +6, Electronic Security +3

**Cyberware:** corymbic implant.



## WHEN GRAVITY FAILS

To quote Marid: "Laila is a twitchy old woman who had one of the first brain implant jobs performed on her. Either the surgeons missed what they were aiming for slightly, or else she had always made you feel like getting out of her presence as quickly as possible. She has long, straggly grey hair; bushy grey eyebrows; yellow eyes; bloodless lips and depopulated jaws; black skin, scaled and scabrous, and the same crooked, clawed fingers that a witch ought to have; and she can't talk to you without whining. She is constantly wearing one moddy or another, which is fortunate because her own personality is unbearable. But even so, her own personality sometimes leaks through whichever moddy she happens to be wearing at the time."

But despite her personality flaws, Laila knows her business. If you're looking for a specific type of moddy or daddy, she knows just the one. If your favorite moddy is busted, she can fix it.

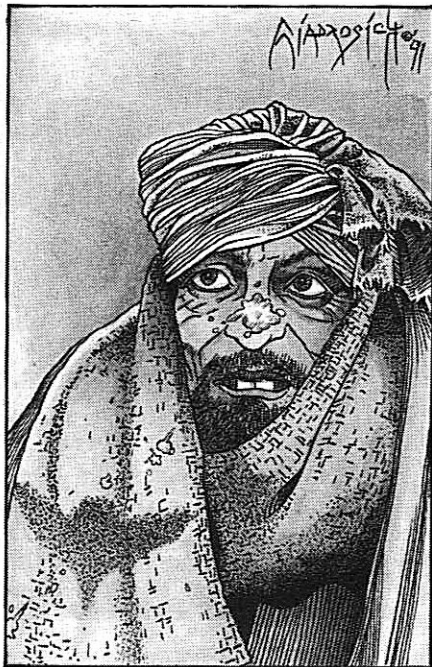

Fuad il-Manhous: Pest

INT 3, REF 4, COOL 3, TECH 2, ATTR 3, LUCK 2, MA 8, EMP 4, BODY 4

Awareness +3, Human Perception +2, Urban Survival +7, Simper +8, Brawling +2, Stealth +1, Shadow +1, Social +1, Education +2

Cyberware: corymbic implant.

Fuad's name actually means something along the lines of "the chronically unlucky." He doesn't mind his nickname much though—it brings with it a kind of notoriety. Fuad lives by his wits (which means he barely gets by most of the time) and his ability to make others take pity on him. But he does this in the most annoying way possible, so most people don't like him very much. Constantly under foot, he is used by almost everyone in the Budayeen to run and fetch. This is usually done not because people really need it done, but because it keeps Fuad out of their way. Fuad has a weakness for black strippers, and on those rare occasions when he has money he can usually be found in one of the clubs, sitting with one such girl who will invariably trick him out of all his cash.

---

### Chiriga (Chiri): Fixer

---

INT 8, REF 7, COOL 7, TECH 3, ATTR 6, LUCK 7, MA 6, EMP 7, BODY 6

Streetdeal +3, Awareness +5, Forgery +1, Handgun +3, Brawling +3, Melee +3, Pick Lock +1, Pick Pocket +2, Intimidate +4, Persuasion and Fast Talk +5, Accounting +4, Human Perception +4, Arabic +6

Cyberware: corymbic implant with reflex daddy.

Chiri owns a club on the Street called Chiriga's. She is a tall, formidable black woman with skin tattooed with the traditional markings of her people. Her shrewd eyes don't miss a thing that goes on in her bar or on the Street. When she smiles she reveals her teeth, which have been filed to points in the fashion of cannibals.

To quote Marid: "Chiri doesn't have much patience for the crowd which she caters to. Her philosophy is that somebody has to sell them liquor and drugs, but that doesn't mean she has to socialize with them."

Chiri has an interesting philosophy when it comes to using moddies. She'll often wear daddies out in public (accounting, language daddies, etc.), but she will never wear a moddy outside her own home. She feels that if she wants to alter her personality that's her business, and she won't inflict it on anybody else. She wishes that a lot of other moddies had the same sort of philosophy.



---

### Indihar: Stripper

---

INT 7, REF 6, COOL 6, TECH 4, ATTR 8, LUCK 7, MA 7, EMP 8, BODY 5

Vamp +5, Seduction +4, Persuasion and Fast Talk +4, Dance +7, Streetwise +3, Perform +6, Personal Grooming +4, Wardrobe +5, Interview +5, Awareness +6,

Cyberware: none.

Indihar is a dancer working the club circuit in the Budayeen. She is currently employed at Chiri's. She is unusual on the Street because she is a natural, unmodified woman and she's not wired. Most of the other dancers on the Street are synthetic hustlers using moddies to customize their personalities for their clients. One moment they're soft and erotic (Honey Pilar), the next they're cold and foulmouthed (Brigitte Stahlhelm). It all depends on which personality they have chipped in at the time. But Indihar makes her living with her own personality. This can make working in the Budayeen moddy bars a little tough, but Indihar succeeds because many customers find an extra attraction in the rarity of an unmodified body and personality. Indihar was raised in a traditional Egyptian home, and she considers herself a good Muslim woman despite her occupation. She is a devoted wife and mother and has never been unfaithful to her hus-

band; she dances, and hustles the customers, but she won't sleep with them and she doesn't drink alcohol.

---

**Saied the Half-Hajj: Fixer**

---

INT 6, REF 7, COOL 7, TECH 5, ATTR 7, LUCK 7, MA 7, EMP 6, BODY 6

Streetdeal +4, Awareness +6, Forgery +3, Handgun +4, Brawling +5, Melee +5, Pick Lock +3, Pick Pocket +4, Intimidate +3, Persuasion and Fast Talk +7, Hide/Evade +3, Shadow/Track +3, Dodge/Escapes +5, Driving +3, Stealth +4, Wardrobe +4, Personal Grooming +5

**Cyberware:** corymbic implant.

Saied is Marid's best male friend in the Budayeen. He is called the Half-Hajj because he is excessively scatter-brained. Hajj is the title that one obtains by completing the pilgrimage to Mecca. Saied only made it about 500 miles towards the Holy City before he started home with a brilliant money-making scheme which he couldn't remember once he got back. Saied is strictly homosexual and will not allow himself to be seen in the company of women, natural-born, surgically modified or created. Careful of his appearance at all times, he is particularly proud of his mustache. Saied usually wears his favorite moddy: The Man of Action, which turns him into the strong silent type. He also feels that it is beneath him to work for a living and so he is constantly looking for ways to make money with little or no effort.

---

**Jacques: Fixer**

---

INT 6, REF 6, COOL 5, TECH 4, ATTR 6, LUCK 5, MA 6, EMP 6, BODY 6

Streetdeal +4, Awareness +4, Forgery +5, Handgun +4, Brawling +4, Melee +3, Pick Lock +5, Pick Pocket +6, Intimidate +3, Persuasion and Fast Talk +7, Gamble +2, French +5, English +5

**Cyberware:** corymbic implant.

Jacques is a Moroccan Christian who feels that he is better than most people in the Budayeen because he is three-quarters European. This, combined with his smug heterosexuality, makes him somewhat

unpopular with almost everybody. Jacques makes his living through thievery and hustling. He will often offer himself to unsuspecting tourists as a guide to the Budayeen. He will then offer to get them in on some "deal" that would set them up for life. As soon as the suckers part with their money, Jacques becomes very scarce indeed.

---

**Mahmoud: Fixer**

---

INT 7, REF 6, COOL 8, TECH 4, ATTR 6, LUCK 6, MA 6, EMP 5, BODY 8

Streetdeal +4, Awareness +3, Forgery +3, Handgun +4, Brawling +6, Melee +5, Pick Lock +3, Pick Pocket +3, Intimidate +5, Persuasion and Fast Talk +4, Gamble +4, Social +4, Dance +4, Seduction +3, Wardrobe +3

**Cyberware:** corymbic implant.

Mahmoud completes Marid's circle of male friends. Mahmoud started life as a doe-eyed, slim-hipped dancing girl named Misty. A post-op deb, he is now short, broad and mean. Some believe that Mahmoud works as a strong arm for Papa.

---

**THE BLACK WIDOW SISTERS**

---

**T**ami, Devi, and Selima aren't really sisters. They weren't even born girls. They are three sex-changes who came from various parts of

the world. Although the sisters look different, they all have huge breast implants and wear thin black pullovers, tight leather skirts, and black spike-heeled shoes when they work the streets. The Sisters have a reputation for being independent operators and they take care of themselves. They supplement their prostitution income by working for Papa from time to time as his assassins, but they keep this connection secret. The sisters are all murdered in *When Gravity Falls*.

**Cyberware:** All of the Sisters have had one salivary gland replaced with a poison sac containing a lethal neurotoxin. The poison is introduced to a victim's blood stream by means of a hollow tooth, which can be capped or uncapped as needed. The poison is harmless if swallowed.

---

**Selima, Black Widow Sister: Solo**

---

INT 7, REF 6, COOL 6, TECH 3, LUCK 6, ATTR 8, MA 7, EMP 7, BODY 6

Combat Sense +3, Awareness +6, Handgun +3, Brawling +4, Melee +4, Rifle +1, Athletics +3, SMG +1, Stealth +4, Seduction +7, Wardrobe +5, Intimidate +3, Streetwise +7, Urban Survival +3, Martial Arts: Karate +3, Social +3

Selima is native to the city. When not working the Street, she has the demeanor of a





## WHEN GRAVITY FAILS

typical middle class Muslim woman, wearing a veil and a hooded cloak as befits a woman in Arab society. Something of an enigma, many denizen's of the Budayeen wonder how she can reconcile her prostitution with her Islamic faith. Easily the prettiest of the three, she is also the least altered by her surgery. Selima's name means "peace." She is the quietest sister, avoiding unnecessary violence. Make no mistake however, she can take care of herself.

---

### Tamiko, Black Widow Sister: Solo

---

INT 5, REF 8, COOL 8, TECH 4, ATTR 6, LUCK 6, MA 6, EMP 5, BODY 7

Combat Sense +6, Awareness +5, Handgun +4, Brawling +5, Melee +5, Rifle +4, Athletics +5, SMG +4, Stealth +5, Seduction +3, Wardrobe +3, Intimidate +7, Streetwise +4, Martial Arts: Aikido +7, Personal Grooming +4, Social +5

For someone who wasn't born an Oriental, let alone female, Tamiko plays the part of a geisha assassin well. She is fond of kimonos, traditional white-face make-up and geisha hair styles. Moody and silent, she keeps to herself. She enjoys her privacy and will soundly beat those who disturb it. Tamiko loves electronic koto music and plays it loudly over her sound system much to the dismay of her neighbors. Nobody complains. Tami is the most violent of the three sisters, and she has a reputation for being just plain nuts.

---

### Devi, Black Widow Sister: Solo

---

INT 6, REF 5, COOL 6, TECH 3, LUCK 6, ATTR 6, MA 5, EMP 6, BODY 6

Combat Sense +3, Awareness +6, Handgun +3, Brawling +5, Melee +5, Rifle +1, Athletics +4, SMG +1, Stealth +6, Seduction +5, Wardrobe +4, Intimidate +4, Streetwise +3, Urban Survival +4, Martial Arts: Aikido +3

Devi is a refugee from Calcutta who came to the city soon after her sex-change. She used her operation to accentuate her East Indian heritage and bears a caste mark on her forehead (although she is not entitled to wear it). When not wearing the uniform of the sisters she is fond of bright silk saris in the fashion of traditional Indian women. All things considered, Devi is probably the most normal of the sisters. Neither too reserved nor prone to

excessive violence, Devi has a reputation around the Budayeen for being the easiest of the sisters to deal with.

---

### Abdoulaye Abu-Zayd: Fixer

---

INT 6, REF 6, COOL 5, TECH 3, ATTR 5, LUCK 6, MA 6, EMP 5, BODY 8

Streetdeal +4, Awareness +4, Forgery +2, Handgun +4, Brawling +5, Melee +3, Pick Lock +2, Pick Pocket +2, Intimidate +7, Persuasion and Fast Talk +5, Social +2, Gamble +3

**Cyberware:** none.

Abdoulaye is a pimp who works the Budayeen for Friedlander Bey. He holds the strings on about a dozen men and women. A cruel man, he takes a large cut of his "employees'" earnings for himself and is prone to beating them. The only reason Abdoulaye has lasted as long as he has is because he works for Papa, and nobody wants to cross Papa. He is killed by Hassan in *When Gravity Fails*.

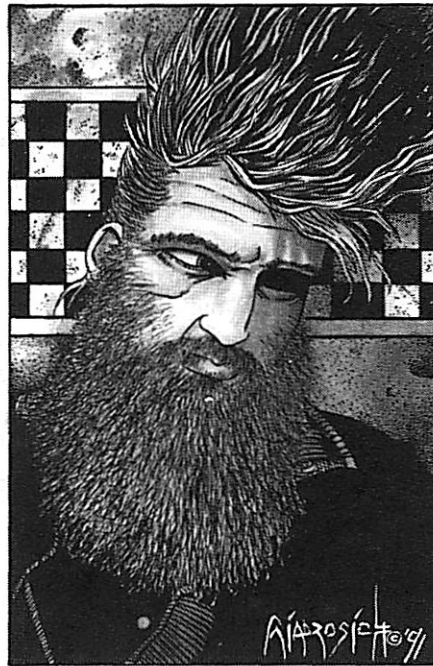

---

### Bill the Cabbie: Solo

---

INT 5, REF 6, COOL 5, TECH 6, ATTR 5, LUCK 5, MA 5, EMP 4, BODY 5

Combat Sense +4, Awareness +4, Handgun +4, Brawling +5, Melee +5, Rifle +4, Athletics +4, SMG +3, Stealth +3, Driving +7, Martial Arts: Aikido +4

**Cyberware:** Bill has had one of his lungs replaced with a large artificial gland which perpetually drips a tiny quantity of the hallucinogenic drug RPM into his bloodstream. RPM produces bizarre and frightening hallucinations. No one knows how Bill has survived the drug's effects as long as he has.

Bill was born in the United States (when they were still united) in the area now known as Sovereign Deseret. His arms are covered with blue-green tattoos so old that they've blurred into obscurity. He hasn't cut his sandy blond hair or his beard in years, and his skin, where it is exposed to the sun, is burned bright red. Bill is crazy, but he chose his craziness. Sometime in his past he acquired enough money to have his single, unique, body modification. Nobody really knows how Bill made his way here and Bill isn't much for conversation any more. Now he drives one of the many cabs that roam the city's streets, and he can usually be found sitting behind the wheel of his taxi staring at the passing people with a mixture of patience, love, curiosity, and cold fear.

---

### Khan/Bond/The Killer: Spy

---

INT 7, REF 8, COOL 7, TECH 6, ATTR 6, LUCK 5, EMP 4, BODY 5

Chameleon +8, Human Perception +5, Resist Torture +5, Pistol +7, Judo +6, Education +6, Computer Use +5, Shadow +8, Basic Tech +6, Disguise +7, Interrogation +6

**Cyberware:** Corymbic implant, none other mentioned, but biomechanical enhancements are possible.

This individual has been using moddies so long there doesn't seem to be anything left of his original personality except maybe a sociopathic lust for murder. He has very few enhancements for an assassin, apparently making up for it in sheer lack of conscience. He is amazingly flexible, however, fully realizing the personalities he assumes. This makes him incredibly difficult to track, since his whole look changes with the plug. While very dangerous, his weakness seems to be getting too personally involved in his assignments. His cat-and-mouse game with Marid in *When Gravity Fails* ends his career.



Nikki (Nikolai Konstantin): Prince

INT 6, REF 5, COOL 5, TECH 4, ATTR 8, LUCK 7, EMP 7, BODY 6

**Charismatic Leadership** +5 (in her own country only), **Seduction** +6, **Persuasion** and **Fast Talk** +5, **Streetwise** +4, **Personal Grooming** +6, **Wardrobe** +4, **Gambling** +6, **Awareness** +5, **Education** and **General Knowledge** +8, **Social** +3, **Human Perception** +4, **Brawling** +6

**Cyberware:** Corymbic implant.

Nikki was born the Crown Prince of Byelorussia and the Ukraine, but after several embarrassing incidents at his father's court he had to be sent away. Nicholas became Nikki soon after. Now she is a tall blonde, although still somewhat muscular. With unnaturally blue eyes and long blonde hair she is an exotic in a city of exotics. Formerly a dancer at Chiri's, Nikki now works the Street for Abdoulaye. She has a reputation on the Street for being even more nuts than Tamiko, although she isn't prone to wanton violence. Nikki is being sought by the Neofascist parties in Germany to use against the monarchy in Russia. She is killed by a Russian assassin in the course of *When Gravity Fails*.

## ENCOUNTER TABLES

### DAYTIME IN THE CITY: PERCENTILE DIE ROLL

**1-5:** Beggars asking for alms. If you are a Muslim and can afford it, pay up. Otherwise it's up to you. You may get a story out of it.

**6-15:** Hucksters trying to help you find the "entertainments" offered in the city. Roll 1D10. 1-3, they know what they are talking about. 4-10 they'll try to take you for all you've got and leave you lost in Hâmidiyya.

**16-24:** Cops on patrol in their car. Roll 1D10. 1-5, they drive on by. 6-8, they stop and ask you some questions. 9-10, they think you are someone else and ask you to come with them.

**25-29:** Rogue Camel. A camel has decided to tour the city unescorted. It is mean tempered and belligerent, spitting and biting at passers-by. If you shoot it the owner may want compensation.

**30-40:** City merchants. Roll 1D10. 1-4, they try to sell you something. 5-7 they want to buy something you have. 8-10, they accuse you of stealing something and yell for the police.

**41-50:** Locals. These will be Arabic men and women just trying to make a living. Roll 1D10. 1-5, they avoid you. 6-8, they will be friendly and inquisitive. 9-10, they invite you to share dinner. It is insulting to say no.

**51-55:** Call to Prayer. During this time all devout Muslims will forego work and participate in prayer for about 15-30 minutes. A good opportunity for non-Muslims to get things done.

**56-60:** *Mutasib*. The religious police have noticed you. Three brown garbed men walk across the street in your direction. Roll 1D10. 1-3, they ask you some questions, then leave. 4-7, they ask questions, then charge you with some fail-

ure of faith and ask you to pay a 20 kiam fine or get off the street. 7-9, they ask you some questions and make notes in a little book for later reference. 10, they scream and run at you, yelling "Kaffir!" and threatening to beat you if you don't give all the money on you for donations.

**61-66:** Foreigners traveling on business. If you are a local they ignore you. If foreign roll 1D10. 1-4, they are business people looking for information. 5-7, they are agents of a foreign power or corporation. They offer you a job doing minor errands for them. 8-9, they think they recognize you (Roll 1D10 again: 1-5, you're an enemy. 6-10, a friend). Wing it. On a 10, they look at you, give you 20 kiam, and walk away.

**67-75:** *Jaish*. Six grey-uniformed men with static pistols decide that you don't agree with them. They approach menacingly. Roll 1D10. 1-4, they are loud and abusive. They want a fight, but want you to start it. 5-9, they attack immediately but only use fists and insults. 10, they draw and fire.

**76-85:** Bedouins passing through the city. They are garbed in traditional desert dress and are fascinated by the wonders of the city. Roll 1D10. 1-5, they like you and ask questions, offering the hospitality of their tents outside the city. 6-7, they take a fancy to some gadget you have. If you give it to them they will accept and are now in your debt. Acts as Family +1. 8-10, they are offended by your urban manner and call you many names, none of which you understand.

**86-90:** Goatherd. A goatherd is bringing his flock into the city. A pack of 30 baying, foul-smelling, omnivorous goats are being led through the streets. Roll 1D10. 1-4, they force you to take a detour. 5-6, you are somehow caught in this mass and are carried with it for 1-6 blocks. You now smell like desert goat. -3 to all Social Skills until you change your clothes. 7-9, the flock panics and stampedes, scattering pedestrians and destroying stalls. The goatherd blames you. A lot of angry eyes are turning your way. 10, a particularly hungry goat grabs your wallet (telephone, gun, other easily accessible item) and starts to eat it.



## WHEN GRAVITY FAILS

**91-95:** Terrorists. You see two men wearing combat outfits getting out of a vehicle. Roll 1D10. 1-3, they pull out military lasers and run into a nearby building amidst the sound of screams. Police arrive moments later. 4-5, they approach a pair of nearby foreigners and exchange packages. If they see you, you are assumed to be a witness. 6-7, they approach a foreigner, grab him/her and force them into the vehicle. The vehicle makes a swift exit. 8-9, they approach you menacingly only to offer leaflets at the last minute. They are canvassing for popular support. 10, they approach you and ask you to join their organization.

**96-00:** Crazy: Some mullah who's slipped over the edge. He has come in from the desert, eyes wild with revelation. People are either listening to his rantings in earnest or running away quickly. Roll 1D10. 1-5, he grabs you, screams at you for a while, and stumbles off. On 6-8, he tries to get you to follow him back out into the desert. He has already collected 1-6 other followers. 9-10, he starts to scream and passes out in front of you. People may think that you have something to do with it.

---

### NIGHT IN THE CITY

---

**1-5:** Beggars asking for alms. Roll 1D10. 1-4, they really are beggars. 5-6, the beggar will offer you some hashish and ask you to sit so he may tell you a story in return for your generosity. 7-10, these are actually muggers. When you get close enough they will try to jump you unless you outnumber them or are obviously armed.

**6-20:** Hucksters trying to help you find the "entertainments" offered in the city. Roll 1D10. 1-2, they know what they are talking about. 3-10, they'll set you up for a mugging or take you to some of the scummiest dives in the city (probably in the Budayeen).

**21-30:** Cops on patrol, riding in their car. Roll 1D10. 1-3, they drive on by. 4-8, they stop and ask you some question. 9-10, they think you are someone else and ask you to come with them. They will be quite curious about a large party skulking about late at night.

**31-40:** Group of local thugs. Some (1-10) Arab badboys out to

prove their manhood. Armed with knives, maybe a needle pistol if they are really serious. No armor. Roll 1D10. 1-5, they will taunt and insult you to provoke a fight. 6-8, they will push you around and yell at you. 9-10, they will rush you. May have plugs and combat daddies.

**41-50:** Locals. These will be Arabic men and women (women will not be unescorted) just out for a good time. Roll 1D10. On 1-6, they avoid you. On 7-8, say hello to you and wish you the best in Allah's eyes. 9-10, they are getting hassled by a group of local thugs (see above).

**51-55:** Crazy. The Arabic equivalent of a cyberpsycho. Some moddy-head with lots of enhancements is running rogue in the streets bopping around and randomly attacking people. The police are not really equipped to deal with this sort of thing and are looking for some qualified assistance. Are you it?

**56-60:** *Mutasib*. The religious police have noticed you, and 3 brown garbed men walk across the street in your direction. All proper Muslims should be at home with their families right now. Roll 1D10. 1-2, they ask you some questions, then leave. 3-7, they have decided that the establishment that you are in should be closed immediately. 8-9, they just ask you some questions and make notes in a little book for later reference. They do warn you off the street immediately. On a 10 They have marked you as a religious terrorist and want to hold you until the police come. They can try.

**61-75:** Foreigners. Roll 1D10. 1-4, they are out looking for the local entertainment. On 5-7, they are agents on a mission, probably a grey op. They are dressed in armored jackets and carrying hidden weapons, probably needlers. (Roll 1D10 1-5 they ignore you. 6-10, they figure you've made them and you are now targets.) 8-9, they are media people shooting a travel holo on the city. They will stop and ask you for help and advice. 10, they beg you not to kill them, give you all their money and run away.

**76-80:** *Jaish*. Six grey-uniformed men with static pistols decide that you don't agree with them. They approach

menacingly. Roll 1D10. 1-4, they are loud and abusive. They want you to start a fight. 5-9, they attack immediately, but only use fists and insults. 10, they draw and fire.

**81-85:** Security Guards. You've stumbled onto private property, and they are determined to keep it private. 4 men dressed in light armor and helmets with static guns and needlers demand that you freeze while they approach and search you. After questioning you might be released. Then again, maybe not.

**86-90:** Assassin. A fanatic religious group has sent a killer on a mission. You see a dark-robed man moving smoothly along an alley. Roll 1D10. 1-4, he is waiting for his target to pass by. If you find a place to observe him, you may be able to interfere if you want to. 5-7 the target passes by while you are there. The assassin leaps out, wraps a garrote around the victim's throat and pulls them into the alley, unnoticed by anyone but you. 8-9, the assassin sees you and fades back into the alley to strike at another time. On 10, assassin mistakes you for his prime target. You feel a wire around your throat...

**91-95:** Criminals. You see two men wearing black night-op gear getting out of a vehicle. Roll 1D10. 1-3, they pull out a great deal of equipment and move down the alley next to a business building. 4-5, they are loading several large packages marked BIOHAZARD into the back of a large truck. If they see you they warn you off, but you are assumed to be a witness. 6-7, they appear from a doorway carrying a long, struggling parcel and force it into the car. The car heads into the night. 8-9, they walk up to a gentleman on the street. There is a dull hiss and the gentleman falls. 10, they mistake you for their contact and start asking you about the "delivery." When you can't answer they realize their mistake and draw weapons to correct it.

**96-00:** You trip over a body lying in a side street. It is freshly dead from: Roll 1D10: 1-3 a knife wound, 4-5 a laser burn, 6-8 a needle wound, 9 poison, 10 he/she isn't quite dead. He/she is: roll 1D10: 1-5 a local, 6-9 a foreigner, 10 a foreigner posing as a local. Take it from there.

---



---

 DAYTIME IN THE BUDAYEEN
 

---



---

**1-3.** Cops. A single patrol car cruising the Street. Roll 1D10. 1-5, they drive on by. 6-8, they stop and ask you some questions. 9-10, they think you are someone else and ask you to come with them.

**4-10.** Newcomers. Roll 1D10. 1-5, native teenagers come looking for some fun. 6-9, expatriates new to the city. 10, relatives looking for misguided family members.

**11-25.** Hookers looking for a "date" and offering the best choice of moddies.

**26-35.** Tourists. Duck if you don't want your holo taken.

**36-45.** Cops. These cops are looking for someone to roust. Armed with seizure cannons and itchy trigger fingers, they'd just love to blast you into the Street, and are willing to provoke you so they can do it, too.

**46-50.** Call to Prayer. During this time all devout Muslims will forego work and participate in prayer for about 15-30 minutes. Make the best of the break.

**51-60.** Shopkeeper. City merchants doing business. Roll 1D10. 1-4, they try to sell you something. 5-7, they want to buy something you have. 8-10, they accuse you of stealing something and yell for the police.

**61-70.** Pickpocket. His REF is 8, his pickpocket skill is +6. Armed with only a knife. If he's successful you have lost your wallet (and all your cash, cards, etc.). If he fails the attempt, feel free to beat him to a pulp.

**71-75.** Hustlers - drug pushers, pimps, hawkers attempting to lure you somewhere (50% chance they mean to do you harm in some way).

**76-80.** Moddy. (1) Roll 1D10. 1-4, they are wearing a harmless but annoying personality moddy. 5-7, they are wearing a general personality module (the man of action, the helpless heroine, etc.). 8-9, they are wearing a hostile and

dangerous moddy (Charles Manson, etc.). 10, they are wearing a bootleg moddy and it has shorted out. The moddy will attack anyone and everyone with reach.

**81-85.** Thugs. (1-4) They will only attack if they outnumber you and there is little chance of being seen. They prefer dark alleys and backstreets. They will follow you for a bit to see where you are going.

**86-90.** Hassan the Shiite. (Or another shopkeeper if Hassan's dead.) Roll 1D10. 1-3, Hassan has recently received a shipment of goods in which you had expressed an interest. 4-7, Hassan has some piece of information which he will gladly sell to you. 8-9, Hassan needs you to do a job for him. 10, Papa wants to talk with you.

**91-95.** The Black Widow Sisters. (or other cyber-assassins) roll 1D10. 1-4, just one (random) working the Street. 5-6, two of them (random) looking for someone. They ask you for info. 7-9, all three looking to settle a score with someone. 10, any number of them looking for you. You're on your own.

**96-99.** Crazy. Gun waving psycho, a junkie with bad drugs, a bad moddy or both.

**00.** Fuad. roll 1D10. 1-3, has an incredibly annoying story to tell you. 4-6, wants to ask you for money. 7-9, has an incredibly annoying story to tell you *and* wants to ask you for money. 10, just stands and looks at you with a completely blank look on his face.

---



---

 NIGHT IN THE BUDAYEEN
 

---



---

**1-2:** Cops. Single patrol car. See daytime table.

**3-10.** Street punks. Four young men looking for trouble and some easy cash. Roll 1D10. 1-5, they will taunt and insult you to provoke a fight. 6-8, they will push you around and yell at you. 9-10, they will rush you, armed only with knives. No armor. May have plugs and combat daddies.

**11-20.** Street Hustlers. Trying to lure you to the best club in the Budayeen. Pretty girls, good booze, and cheap drugs! Roll 1D10. 1-4, they know what they are talking about. 6-10,

they'll take you down an alley where 6 "friends" are waiting to show you just how good a time you can have down here.

**21-30.** Hookers. Only 100 kiam. Probably good-looking, definitely not natural.

**31-45.** Locals. Out for an evening of pleasure. See daytime table.

**46-55.** Tourists. (1-4) These people don't know that they should be in their hotels by now. Roll 1D10. 1-3, they are sitting in one of the clubs nervously sipping at their drinks. 4-8, they are being followed by punks looking for easy money. 9-10, they are being mugged.

**56-65.** Thugs. (1-4) See daytime table.

**66-70.** You are approached by someone, perhaps an acquaintance, who has information regarding some possible employment for you.

**71-75.** Moddy. (1) Roll 1D10. 1-4, they are wearing a harmless but annoying personality moddy. 5-7, they are wearing a general personality module (the man of action, the helpless heroine, etc.). 8-9, they are wearing a hostile and dangerous moddy (Charles Manson, etc.). 10, they are wearing a bootleg moddy and it has shorted out. The moddy will attack anyone and everyone with reach.

**76-80.** The Black Widow Sisters. See daytime table.

**81-85.** Jaish. The Jaish have come into the Budayeen looking for foreigners to stomp. Roll 1D10. 1-4, if you have Western friends or are Western, they will harass you. See Daytime City encounters.

**86-90.** Foreigner. Roll 1D10. 1-3, a businessperson looking for some muscle. Will offer you a job. 4-6, mercenary looking for employment. 7-8, looking to buy contraband weapons, tech, or drugs. 9-10, looking for someone: lost relative, lover, enemy, etc. Will ask questions and may be hiring help.

**91-00.** Fuad. See daytime table. ■



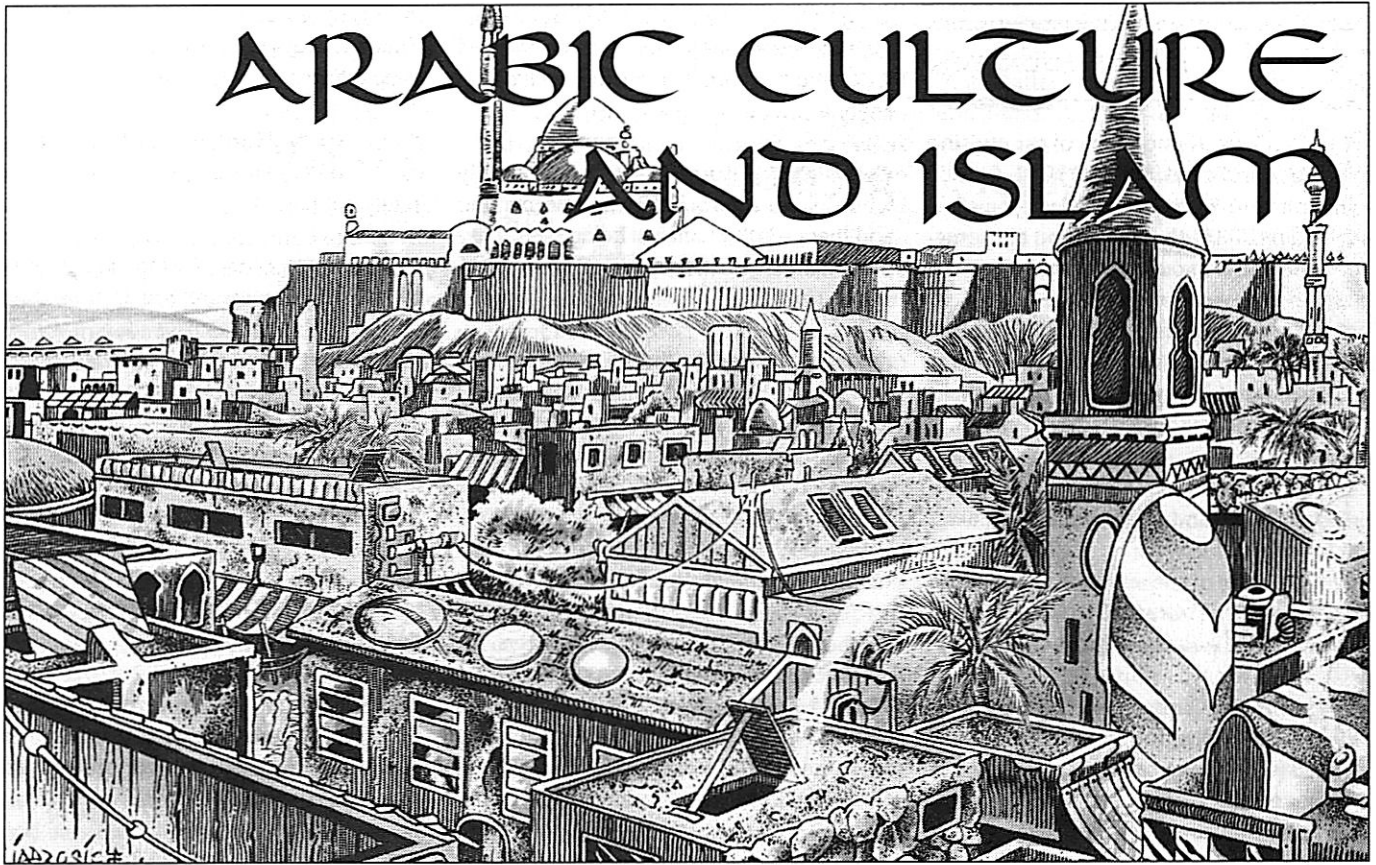

# ARABIC CULTURE AND ISLAM

Since the Arabic setting and Islamic culture of *When Gravity Falls* are what gives the story its exotic flavor, it is likely that many *Gravity* campaigns will be set in this area. The conflict of ancient, traditional cultures facing the intricacies of 23rd century technology puts a new perspective on the decadence of the dark future. Much of the enjoyment of the story comes from seeing the Islamic culture of the city through the jaded eyes of the half-hearted Muslim, Marid Audran. Another

reason for concentrating on this region is the possibilities that exist here. The globe has fragmented politically, economically and ideologically. One of the few remaining unifying factors is religion. Islam is a relatively new and vital religion and it has continued to give this region a sense of common identity rare in the current geopolitical situation. True, there are factions within Islam, but it was the Islamic ideal that made the Arab Federate possible 30 years before, and who knows what the future holds?

---

---

## ISLAM

---

---

**1600** years old, Islam is a reformation and continuation of the previous monotheistic religions, including Judaism and Christianity. Its foundation is the Qurân, the holy text of the words spoken by the Prophet Muhammed in the 7th century. Islam recognizes Abraham, Moses, and Jesus as legitimate prophets of God. Muhammed was simply the final prophet, delivering the true, unsullied word to humanity. The Qurân contains the true word of Allah (God), and provides the guidelines for living in the *Sharia* or Straight Path to God. To do this it corrects many "misinterpretations" contained in the Torâh and the New Testament.

The Qurân shares many ideas with the other two monotheologies, including the concepts of heaven and hell, judgment for sins, and this life as a test before paradise. There are, however, many subtle differences. Islam does not have a concept of original sin: Shaitan (Satan) fell not because he refused to give homage to God, but because he refused to give notice to man, displeasing God. Man is being tested, but he carries potential as the

### IT'S ONLY A GAME

If you want to run a campaign in the Islamic world, here are a few guidelines to use when dealing with people, places, and things Arabic. It is hard to avoid generalizations when you talk about an entire culture, so keep in mind that these are only a few broad traits that we are mentioning. Although they are unified by culture, people remain individuals, and individuals will break the rules in their own way for their own reasons.

Keep 'em guessing. The campaign area covers up to 20 different countries. Even though most are Muslim, there is going to be a lot of variation in customs, dialect, and so on. Use

our information as a primer. If you find this culture as fascinating as we do, further research will prove helpful. Keep in mind that changes have occurred in the last 200 years, even in such a traditional society.

The description of Islam in this section is *not* a pitch. To role-play in an Arabic society one must understand Arab culture, and Islam is the single most important factor in defining Arab culture. We have tried to portray Islam as honestly and accurately as possible, but the authors of this book are not Muslims. Some inaccuracies may have slipped through our research. If that is the case, we apologize to any persons of the Islamic faith who are concerned.

## ARABIC NAMES

In most Arabic cultures a man's first name is his given name, the second his father's given name, the third his paternal grandfather's, all of which may be followed by a family name (if they are used). More generations can be added, but this can get cumbersome. Thus an Arab man's name traces his ancestry on his father's side. Women do the same along maternal lineage, and they do not change their names after marriage. Sometimes the term "ben" (son of) or "bint" (daughter of) is inserted, as in Fatima bint-Harithi. This tradition, like many, has often been replaced by Western styles, but it remains common. As a result, Arabs prefer to address people by their first names at all times, even strangers. Often they will use the titles Mr., Mrs., or Dr. as deserved along with the given name. While this may sound strange to Westerners, take it as a sign of respect.

**Note:** Mar'îd only has a family name since he did not know his father or his lineage.

Epithets are also used in Arabic names. The common Arabic prefix "Abd-" means "Servant of-" and is usually followed by one of the aspects of God, such as

"Abdallah" (Servant of God), or "Abdel-Karim" (Servant of the Generous). The term "al" means "the", so names such as "al-Sayf" (the Sword) or "al-Irrahman" (the Merciful) mean just that. "Al" may also mean "of" or "from", so "Mustafa al-Hajiz" is "Mustafa from Hajiz". A complete Arab name may run like "Faisal Abdel-Malak Ben Youssef Ben Hassan al-Nejed" and would translate: "Faisal, Servant of the Angel, son of Youssef, grandson of Hassan, whose family is from the Nejed." That was a short one.

The terms "Umm" and "Abu" mean "mother of" and "father of." A proud parent may add this term followed by the first born's name to their own name. Thus "Fatima Umm Mustafa" is "Fatima, mother of Mustafa". Umm and Abu can also be used to address parents with respect. And one would never do otherwise, right?

Typical male first names are Bilal, Mohammed, Abdul, Feisal, Ibrahim, Hasan, and Gamal. Female names include Fatima, Ayesha, Sarah, Aida, or any number of Biblical choices. Western names are common as well, and often identify Arab Christians. A dictionary could be helpful in determining character names. The short one in this section will get you started.

true vessel of Allah. God is like an authoritative parent, harsh and demanding, but loving and compassionate as well. As the Qurân says, "God has placed on man no burden too heavy to be borne."

All that happens is *inshallah* — the Will of Allah. This does not mean that individuals are not responsible for their actions. Everyone may choose whether to follow the path or not; it's just that Allah knows what you are going to do anyway. *Inshallah*. In fact, the word *Islam* means "to submit" in Arabic. Thus Islam means submission to the word and way of God. The *Sharia* is the code of living, law, and worship that guides Muslims in everyday life.

One will find few "reinterpretations" of the Qurân, as this is sacrilegious. The many versions of the New Testament are an example of the Word rewritten by the hand of man. The Qurân is the exact Word of God and therefore inviolate. Even translations of the Qurân are usually accompanied by the original Arabic text, since Muslims believe that Arabic is obviously God's chosen tongue. The Word can only be truly appreciated in that form.

Islam, like many faiths, has several sects, the most of important of which are the *Sunnis* and *Shiites*. The original schism arose because of disagreement on the method of secession of the *caliphate*, the Islamic equivalent of the Catholic Papacy. The *Shiites* are thought of as being very conservative and traditional, some to a fanatic extent. Sunnis are considered to have a more liberal interpretation of Allah's plan. While the schism has caused some friction, both sects recognize each other as Muslims above all else. A third path is that of the *Sufi*, the mystic spiritual seekers. They look to experience the joy of the presence of Allah in life. Many *mullah*, or holy men, come from the ranks of the *Sufi* in both sects, and they are well-respected by all for their ascetic lifestyle and dedication to prayer.

---

### THE PILLARS OF ISLAM

---



The Qurân sets forth the Five Pillars of Faith upon which Islam rests. While the faith is diverse, these practices are essential and required for all Muslims.

The first is the Profession of Faith, or *Shahada*: A person simply proclaims his commitment to Allah and His Prophet, and pledges belief in the one God. This is witnessed, and if judged sincere, that person becomes a Muslim.

The second is Prayer, or *Salat*: Five times each day the faithful are called to worship by the *muezzin* from atop the minaret of the local mosque. Once this calling was done unaided, and *muezzins* took great pride in this, but cities have grown too large. Amplifiers now carry the call to every alley and corner. To perform the ritual, the worshipper must stand facing in the direction of the Holy City of Mecca, home of Muhammed and the *Kaaba*. Knowing the direction to the Holy City is always important to the faithful. The prayers may start with absolution's and proceed with prostrations and recitations. These prayers praise the glory of God, and rejoice in his influence in our lives. They may take from 15 minutes to one-half hour, depending on one's devotion.

The prayers are called at daybreak, noon, mid-afternoon, sunset, and nightfall before retiring. The Friday noon prayer is the *juma*, the congregational prayer, and the faithful are expected to gather at the central mosque. In the city of *Gravity* that mosque is the Shimaal, which is close to the Budayeen. There the faithful are lead in prayer by the *imam*. Only men are required to attend, and any women who come are segregated. (The practice of segregation has fallen into obscurity in *Gravity*, but women are still forbidden from becoming *imams*, even if they have had complete sex-changes.

The third pillar is Almsgiving, *Zakat*: It is God's desire that we look after our less fortunate brothers. Thus every Muslim is expected to provide money from his income towards the welfare of the poor in the community. This may take the form of an alms tax or tithe. All able, adult Muslims are required to donate the tithe. Typically, two and one-half percent of annual income is asked, either in kiam or other valuable resources. This is not charity as Westerners think of it. This is an act of faith as important as prayer and belief itself. Faith must be put into action.

The Fast of Ramadân is the fourth pillar. During the ninth month of the Islamic calendar it is commanded that no Muslim whose health permits may eat, drink,



## WHEN GRAVITY FAILS

“  
The Fast of  
Ramadân occurs  
during *When  
Gravity Fails*,  
giving you a good  
idea of how the  
city deals with it.  
Check it out.  
”

smoke, or have sex between sunrise and sunset. Even drinking water is forbidden. The month is used as a time of spiritual reflection and gratitude for God's generosity. You'll find that activity shifts to the evening, with shops open late after being closed during the mid-day hours. Relatives visit each other and share late evening meals called break-fasts. People often sleep for a few hours during the day so that they can be active later into the night. The calls to prayer are maintained, naturally, and the respectful still rise and face Mecca the five times required daily. At the end of the fast is a three-day celebration similar in intensity to Christmas. Families travel to see each other, trade gifts, eat heartily, and give special alms to the poor.

The fifth pillar is the Pilgrimage, the *Hajj*. Every Muslim who is able should, at least once in his life, make the journey to Mecca to worship at the *Kaaba*, the cube-shaped house of God. Pilgrimage itself involves many elements, including special simple clothing, chants, and rites that highlight the equality, devotion, and purity of the pilgrims. When pilgrims reach Mecca they go to the Grand Mosque where the *Kaaba* is located. Built by Abraham, the *Kaaba* contains the black stone given to him by the angel Gabriel (Jibreel) as a sign of the covenant with God for Abraham's (Ibrahim's) son, Ismail.

Ismail is considered the father of the Arabic tribes.

Pilgrims circle the *Kaaba* counterclockwise seven times as part of their journey. Other acts of worship in and around the Holy City complete the pilgrimage itself. These include the stoning of the pillars that represent Satan, and the wondrous purge of seeking Allah's forgiveness on the Plain of Arafat outside the city, where Muhammed gave his final sermon.

The *Id a-Adha* (the Feast of Sacrifice) marks the end of the pilgrimage with symbolic sacrifices of animals for feasting. Since it is written that pilgrimages take place during the twelfth month of the year, the whole region celebrates the end of the Hajj together. Those who have completed their pilgrimage take the title of Hajj to add to their own names as a sign of pride and accomplishment.

Some Muslims believe that there is a sixth pillar, the *Jihad*, or Struggle: using your life to advance the belief and cause of God. This is *not* officially recognized. Many feel that the *Jihad* addresses personal growth, not warfare. But others, particularly some fanatics, feel that this last pillar requires the faithful to use whatever means available to advance worldly causes. Even by lasers and bombs, if necessary.

## RELIGIOUS TOLERANCE

Even though Islam pervades Arab culture, Muslims can be very tolerant of other faiths in their communities. Be it Christian, Jew, or Hindu, Arabs appreciate devotion to religion in any form. The sincerity with which you worship can gain you much respect, regardless of the creed. That doesn't mean that religious prejudice is completely absent, but it's not as common as you might expect.

## ARAB SOCIETY

It is almost impossible to separate Arab culture from the Islamic religion. Islam forms the basis for most of Arabic society, much more than Judeo-Christian beliefs affect Western society. While there are certainly Christians and Jews in most Arab countries, Muslims generally form the majority, and their way sets the pattern for all behavior. This stems from the very basic precept of Islam that actions are as important as faith, and actions should be directed towards building a just and holy community, the *umma*. The concept of separation of church and state is difficult for Muslims to see as desirable or even possible.

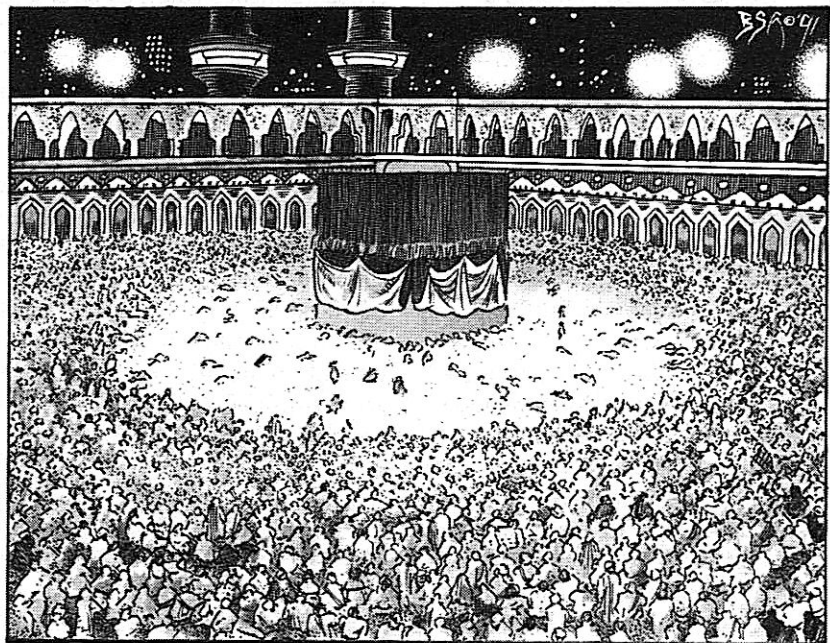

## LAW

The *Sharia* is the basis for Law in most cases, and the Five Pillars are integrated into most aspects of government, allowing prayer, welfare tithes and so on. Islam prohibits adultery, mistreatment of women, and contains many other moral guidelines. Originally *all* law was founded on the *Qurân* and the *Hadith*, the series of writings based on accounts



of Muhammed's sayings. After time, the *sultans* felt "restrained" by the *qadis* (Islamic judges), so they created the Grievance Courts. They were intended to deal with public law such as commercial and land agreements, but their scope has gradually expanded to include all types of cases. The political rulers have control of the Grievance Courts, but they still must answer to the *Sharia* in all judgments or risk a religious revolt.

## FAMILY AND REPUTATION

Personal and family honor and reputation are held in the highest regard in Muslim cultures. An Arab will go to very great lengths to preserve his reputation, and he can be ruined if his stature in the community is compromised. Loyalty to one's family is a duty, and one is expected to put the family's needs above

## AN EYE FOR AN EYE.

Arabic law is harsh, even by martial standards. Trials are swift and appeals uncommon. Use the Justice code from 2020, but increase the sentences by 50%. Rape is punished by death or amputation of the genitalia with the nerves cauterized so a replacement cannot be attached. Theft is occasionally punished the same way, with hands being the most often removed limb. Of course, these days, most cops would rather just shoot you and save the court appearance.

## FAMILY

To show the close-knit nature of Arab society you may want to allow any player generating an Arab character to buy the Nomad special ability Family up to +3 as a pick-up skill. This represents members of his own family that he can count on. But remember, he will have many familial obligations in return, such as a brother he has to keep bailing out of jail, or an uncle who is an *imam* and happens to know the most wonderful Muslim girl who's looking for a husband.

## CLASSES IN ARAB SOCIETY

The three main classes in Arab society are basically the same as elsewhere: the rich upper class and royalty, the middle-class (shrinking fast) of civil workers, military officers, successful merchants, highly trained technical specialists and teachers, and the lower class of peasants and urban poor. Cyberpunks generally like to make their own class, but the Arabs will put you in one of the above if you don't do it yourself. Better understand how they see you before you go throwing your weight around.

## WARRING WITH WORDS.

Winning at a Persuasion skill contest is a good way to win respect, and a lot safer than pulling a gun. Use those Oratory skills to the max and you may find yourself with a healthy rep. Or declared a fool.

one's own. Consequently, one should always be able to depend upon the family in return. Only turning your back on both them and Allah can deny you a place in the family's arms. Nepotism is not seen as favoritism, but good sense. Who better to trust than your own blood? Remember this when dealing with Arabs: you cross one, you may have to answer to his entire family.

In Arab society, your family status and social background determine your own status. Arabs are still a fairly class-conscious people, and while your own accomplishments have merit, it can be very hard to break out of

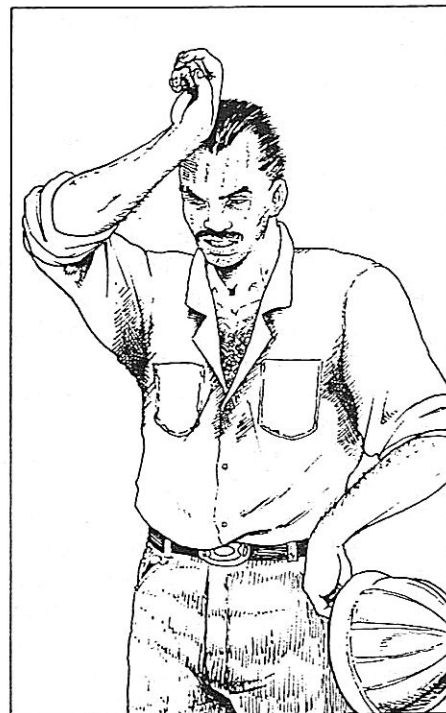

the stigma of being "lower" class. It is considered in poor taste to complain about your standing. You should rejoice that you have found your proper place in life. Also, one does not brag about "working your way out of a poor family" as Westerners do. While many will admire efforts of someone who does this, they will not be impressed by the disparaging way this person thinks of his kin.

## ETIQUETTE

Creating a pleasant impression in public is always important. How you appear to your peers is often as important as what you really are. Arabs see themselves as generous, polite, and humanitarian, and that is the image they cultivate. Some, however, pursue slightly less gentle



## WHEN GRAVITY FAILS

reputations. Should you try to make friends, be prepared to open much of your life. Friendship in Arab terms means taking and giving favors, many visits to and from friends, and a very unwestern idea of privacy. An Arab will never deny a friend a favor. He may have to later tell him that there was not much he could do, but he will *not* say no. That would be seen as impolite and insulting.

A favorite Arab pastime is conversation, and friends are expected to participate as much as possible. Social life is very active, with dinners, parties, and visits constantly being exchanged. Not participating is a sure way to find yourself alone. Dinner parties are long affairs with great portions of talk, and spicy food, but no alcohol. Alcohol and pork are forbidden by the teachings of the Prophet.

There is a clear distinction between friends and strangers, and a different set of manners for each. Arabic "public manners" may seem coarse to Western eyes; Arabs are used to crowding and close physical contact. Many foreigners believe that Arabs are too aggressive and rude in public. Do not take it personally. It is just that their habits are different.

The spoken word carries much weight in Arabic society. An act spoken out loud is almost as good as deed done. Thus you can witness threats and demands being thrown by merchants and buyers across a bargaining stall, only to be forgotten the next day. Saying the threat was akin to doing it. The speaker need not actually follow through. This is the opposite of the Western proverb "Words are Cheap." Here, words are real. Now, swearing and the use of curses are very offensive as they bring evil with them, defiling the conversation. Eloquence is highly respected, and rhetoric is an honored art. How you say it is as important as what you say. Blessings, poetry, and proverbs are used liberally throughout the conversations of the enlightened. This is not to say that foolish babble is tolerated. Silence is respected when you have nothing worth saying: "A fool's heart is in his mouth. A wise man's mouth is in his heart."

---

### BUSINESS AND BUSINESS ETIQUETTE

---

**B**usiness among Arabs has its own pace. Polite conversation and coffee often precede any discussion of business, and it is considered cultured to

### "GREED LESSENS WHAT IS GATHERED"

An example of the pacing situation occurs in the meeting between Marid, Hassan, Nikki, and Abdoulaye in *When Gravity Fails*. Nikki is in far too much of a hurry. Cyberpunks may have to down-shift in order to put up with the more casual pace of doing business here. Break out those Bureaucracy and Persuasion skills. Also, that's probably why Abdoulaye was so ticked at having to talk to Marid; Marid was not exactly a high-status mediator.

best ways to get things done, potentially saving you great mounds of red-tape, but then they may want a favor someday.

---

### WOMEN IN ARAB SOCIETY

---

**T**o Westerners, women would seem to be repressed in Islamic society. Arabs, including most women, do not consider this to be the case. There are many traditions and guidelines for women's actions, but this is considered to be done out of respect for the female, and is intended to protect

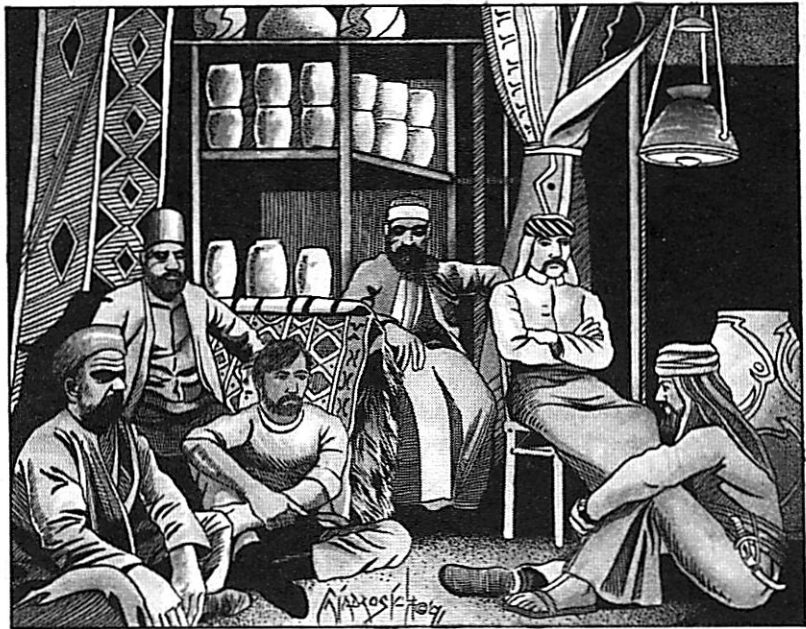

enjoy the light talk and blessings that lead to work, and crude and ill-mannered to rush ahead. Trying to accelerate the pace of business is an error many Westerners make. Mediators who know one or both parties involved are often used to smooth out business proceedings. Care must be taken to choose a mediator of equal status to the person you will be dealing with. Having a lower-status mediator to face your counterpart is considered truly insulting. Patience is more than a virtue. In transacting business it is a necessity. Pushing for quick resolutions may well doom you to failure. If time is of the essence, a few kiam in the right hands can go a long way towards moving things with alacrity. But beware, not all who would take your money will truly be able to help you. Choose your "donations" carefully. Friends or family in business and government are the

them from the harshness of men and day-to-day life. Orthodox Islamic women dress modestly in public, including veils. They participate in social gatherings of both sexes only when their husbands or fathers are present, and should also avoid participating in a conversation between men. This is as Allah wills. Intimate displays in public should be very discreet. Even public hand holding between lovers is frowned upon. Arranged marriages are still quite common. Once married, the husband is obligated to support his wife in a manner befitting her station.

While their public presence may seem limited, women are given great authority in the home, having much to say in the handling of the family, money, and children. And they will always have respect. There has been some outcry from

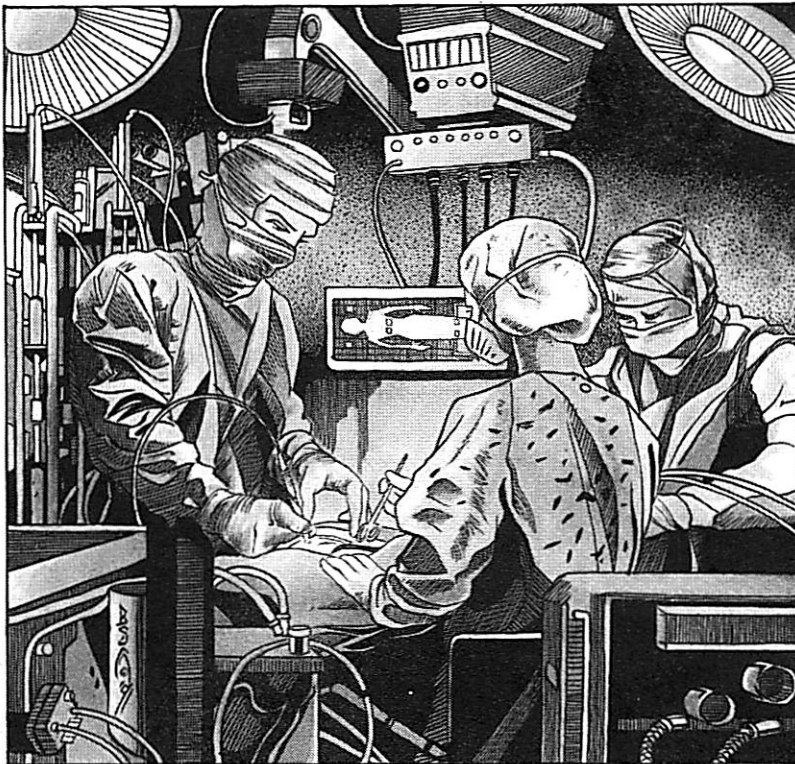

has cast them. Fundamentalists believe that debs and sex-changes do not understand that Allah does not make mistakes; that there is a reason they were made the way they were. They have but to seek the reason rather than to change God's work. As always, however, there are those who manage to reconcile sex-changes with their faith.

Arabs haven't made up their minds about cyberware and biotech. Most traditional Muslims don't approve of cyberware, seeing it as an unnecessary violation of the body, modifying that which need not be modified. Others feel that headware is too seductive, and equate cory plugs with addictive drugs. Many others, however, see the technology as simply being too useful to pass up. Daddies especially have found a rich market in the Arab world. Since the city is the meeting place for so many cultures, the adaptability that plug-ins allow is a major selling point. Standard cyberware items such as limbs and accessories aren't as controversial, but they aren't very common out here either. They are expensive to buy and maintain in this environment.

As we mentioned before, the Arabs are still trying to put transsexuals into perspective. While any educated Arab of this era will understand the psychological nature of a sex-change, many are still rationalizing it theologically. And keep in mind that to them there is no real difference between the two. It may take a while.

women who have taken in the Western ideas of "freedom" and "equality." The Arab man's response is: Free to do what? Fight every day for a living? Bare themselves shamelessly in public like soiled Budayeen tramps? Women hold public office and can be doctors. This alone is enough to shock some.

**ARE WE KIDDING?**

The views on women presented in the text represent the *traditional* Islamic position. All this has been changing slowly over the years, and in Marid's time only *very* traditional women feel bound by these customs. Many women hold political offices in Islamic countries, and many have tried to advance the cause of their gender against a *lot* of resistance. During the 22nd century a strong fundamentalist movement stopped women's equality in its tracks. Little advancement has occurred in most Arab counties for the last 45 years. Women are still considered second-class citizens by Western standards. Sex-changes are still confusing to traditional Arabs, and they are treated gingerly, like men who have given up their status. Female-to-male sex-changes evoke even more confusion. Western women are treated with respect and given more freedom than Muslim women, but they would do well to keep in mind the restrained nature of inter-gender relations when dealing with Arab men. Traditional women still get married before they fool around.

IDEOLOGY

TECHNOLOGY

**23rd** century technologies pose many problems for traditional Muslims. Man has chosen to improve upon God's plan with surgery and electronic implants. This has caused much controversy in the mosques and houses of wisdom. Modern Arabs ask: should not men use the tools that God has given them the ability to create? It's like using a car, or a radio; devices to ease one's lot in life. But because some cybernetics can alter the way we *think*, many feel it is akin to drugs or alcohol, allowing Shaitan into one's mind, violating the 'Haram', or the concept of keeping the spirit clean. Traditionalists believe that those who use moddies and daddies are imperiling their souls. Then there are sex-changes, individuals unsatisfied with the role in which nature

**M**uch has changed in this land over the past 200 years. Traditionalists, reformists, and many other movements all wish to determine the direction Islam will take in the 16th century (23rd century in the calendar of the infidel). The Shiites have fallen from favor since the death of Shaykh Bilal, which may make them all the more potent. There has recently been a reflowering of the faith, but there are many who say that Arabs must adopt a more "cosmopolitan" attitude towards the technology and information coming from the rest of the world; a revival of the *ijtihad*, or broad thinking. Many Arab leaders warn that the faithful must tread carefully; new developments will lead to Western decadence and the ruin of Islamic values. Then the Muslim lands will decay like the nations of the West.





## GLOSSARY AND PROVERBS

Following is a list of Arabic words and phrases and a list of Arabic proverbs. Use the glossary to help in the creation of character names. Slang and proverbs will liven up character dialogue and role play.

### GLOSSARY

- Ahlan wa sahlân:** "You have come to your people and level ground." A formal greeting. (Arabic)
- Afrîf or Afreet:** Demon. (Arabic)
- Al-baqarah:** The Cow. Also the name of the second Sûrah of the Qurân. (Arabic)
- Al-fâtîhah:** The first Sûrah of the Qurân, a comforting prayer that is the Islamic equivalent of the Lord's Prayer. (Arabic)
- Al-kalb:** The dog. Next to the donkey, Arabs consider the dog the filthiest of animals. (Arabic)
- Al-sifr:** Zero. (Arabic)
- Allah is most great:** A frequent Islamic interjection, usually at the end of some speech or negotiation.
- Allah yisallimak:** "God keep you in peace." Response to "Salaamtak." (Arabic)
- Almaani:** A German. (Arabic)
- Amp:** To have one's brain wired. (Slang)
- As-salaam:** "Farewell, Peace be with you." (Arabic)
- Badawi:** The nomadic desert Arabs. (Arabic)
- Bakebrain:** Someone wired to use moddies and daddies. (Slang)
- Baksheesh:** A tip, gratuity, or bribe. (Arabic)
- Baraka:** A concept which doesn't translate well. It can mean magic or charisma or the special favor of God. People or places can have it. Shrines which have this property are often touched in the hopes that some of the *baraka* will rub off. People who have it can do almost anything they want. (Arabic)
- Bismillah:** "In the name of God." Common Arabic interjection. (Arabic)
- Bismillah ar-Rahman ar-Raheem:** "In the name of Allah, the Compassionate, the Merciful." Common saying. (Arabic)
- Beauties:** Butaqualide HC1. A very powerful form of sleeping pill which is highly illegal. (Slang)
- Blazebrain:** See Bakebrain. (Slang)
- Blue Triangles:** Triphetamines. A powerful form of amphetamines. See Tri-phets. (Slang)
- Business is business and action is action:** Motto of the Budayeen.

- Bwana:** A term of respect similar to Mister. (Swahili)
- Chipping in:** Using a moddy or daddy.
- Cold tea:** Alcohol. (Slang)
- Choo:** Excrement. (Swahili)
- Copshop:** Police station. (Slang)
- Cory Plug:** A corymbic implant which allows the user to chip in moddies and daddies. (Slang)
- Creased:** Killed. (Slang)
- Daddy:** An add-on chip that gives the wearer temporary knowledge or skills. (Slang)
- Deb:** A pre-operation transsexual. (Slang)
- Derwishes:** Believers in a mystical form of Islam. They believe that certain fortunate people are specially blessed by Allah with *baraka* (see above), and are therefore worthy of respect in the community. (Arabic)
- Far from you:** Superstitious formula spoken to prevent tragedy or bad luck caused by someone talking about such matters.
- Fellahîn:** Peasants. (Arabic)
- Fiq:** A small copper coin of little value. (Arabic)
- Flic:** Police. (French slang)
- Gelstrips:** Protective gelatin bandages.
- Habari gani?:** "What's up?" (Swahili)
- Himmar oo ibn-himmar:** "Donkey and son of a donkey." One of the worst insults possible to an Arab. (Arabic)
- I am quite unable to express my thanks:** A common Arabic expression of gratitude, the formal reply to which is "No thanks are needed when one performs a duty."
- Ibn wushka:** "Son of a unclean woman." An insult. (Arabic)
- Imam:** A Muslim holy man or church official. (Arabic)
- Inshallah:** "If God wills" or "It is the will of God." A catch-all phrase used by Arabs in almost every situation in which the outcome is in some doubt. Uttering this statement takes all blame for failure out of the hands of man and places it in the hands of Allah, but it is not an excuse.
- Jam:** To mess up, hurt, or have sex with. (Slang)
- Jambo:** Hello. (Swahili)
- Jihad:** A holy war. (Arabic)
- Kaffir:** Unbeliever. Also means black person, or slave. Used as an insult. (Arabic)
- Kiam:** Standard monetary unit in *When Gravity Fails*.
- Kwa heri:** "Good-bye". Used when speaking to one person. (Swahili)
- Kwa heriniya kuonana:** "Good-bye." Used when speaking to more than one person. (Swahili)
- Kwa siha yako:** A toast, similar to "Cheers!" (Swahili)
- Libdeh:** The knitted skullcap of a Muslim male. (Arabic)
- Marhaba:** A greeting, often used with persons of a lower social standing. (Arabic)
- Maghrebi:** A mildly racist slur used to describe Algerians, Tunisians, or Moroccans. (Arabic)
- Maktoob:** "It is written." (Arabic)
- Mâshî:** "Nothing." (Arabic)
- Medînah:** The old part of the city. (Arabic)
- Medersa:** A Muslim college of theology and law. (Arabic)
- Mgongo:** Rear end, rump, etc. (Swahili)
- Moddy:** An electronic chip which give the wearer a temporary personality overlay. Also used to refer to someone currently wearing such a chip. (Slang)
- Muezzin:** A man who calls the faithful to prayer from the minaret of a mosque. (Arabic)
- Mush hayk:** "Is it not?" A suffix added on to the end of a statement. (Arabic)
- Njema:** "Nothing." (Swahili)
- Noraf:** A North African individual. (French slang)
- Paxium:** A mild tranquilizer.
- Qadaa oo Qadar:** "A judgment of God and Fate." (Arabic)
- Qurân or Qur'ân:** The Book of Islam, containing the word and dictates of God. To the Muslims what the Bible is to Christians.
- Ramadân:** The holy month of Islam, during which all Muslims fast between sunrise and sunset. (Arabic)
- 'Ricaïn:** An American. (French slang)
- RPM:** 1. Ribopropylmethionine. An extremely potent hallucinogenic drug.
- Sahib:** "Sir." A title of respect. (Arabic)
- Sahtay:** A toast, similar to cheers. (Arabic)
- Salaam:** "Peace." A greeting or farewell. (Arabic)
- Settle:** To kill. (Slang)
- Shiatan:** Satan, the devil. (Arabic)
- Shukran:** "Thank you." (Arabic)
- Simoom:** A strong, hot, sand-laden wind that blows through the Saharan and Arabian deserts. (Arabic)
- Simsaar:** A broker or agent. (Hassan the Shiite is one.) (Arabic)
- Salaamtak:** "Peace be with you." A greeting or farewell. (Arabic)
- Souk:** An open-air marketplace. Usually *souks* will consist of one type of shop or booth along one street. (Arabic)
- Spill:** To spend money. (Slang)



## WHEN GRAVITY FAILS

**Street American:** A street urchin. (Slang)

**Sunnies:** Sonniene, a powerful opiate pain killer. (Slang)

**Sûrah:** A chapter of the Qurân.

**T, the T:** The truth. (Slang)

**Tri-phets:** Triphetamines. See Blue Triangles. (Slang)

**Tomorrow with the apricots:** A common levantine phrase similar in meaning to "When pigs fly."

**Uncivilized idiot:** A popular Arabic insult.

**Wallâhî il-azîm:** "By Almighty God!" An exclamation. (Arabic)

**Where you at?:** A Budayeen greeting.

**Ya salaam:** An exclamation of joy or dismay similar to "Oh, my God!" (Arabic)

**Ya shabb:** "O young man." (Arabic)

**Yil'an'abook!:** "May your father be cursed!" An insult. (Arabic)

---

---

## PROVERBS

---

---

Most of these are self explanatory. Make a crib sheet and throw them into role-play dialogue at opportune times.

☑ The moon shines in the absence of the sun, do not strike a rail with your fist nor mistake the sun for the puff of a candle.

☑ He who has burned his mouth with milk blows on ice cream.

☑ The understanding of an Arab is in his eyes.

☑ Open up your door to a good day, and prepare yourself for a bad one.

☑ He who speaks the truth better have one foot in the stirrup.

☑ Patience, my friend, is the key of paradise.

☑ The candle is put into the lantern and the moth is left outside, fluttering.

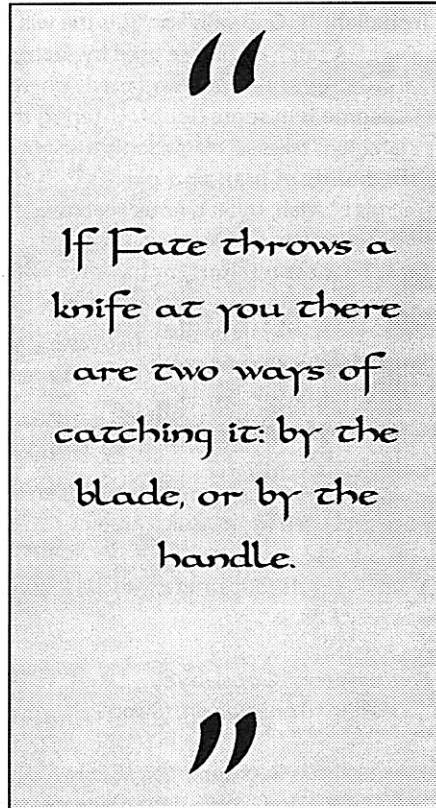

☑ Nobody but the one who is carrying the load knows how much it weighs.

☑ The air of heaven is that which blows between the horse's ears.

☑ To him who has no teeth left Allah gives dry beans to eat.

☑ Without fingers the hand would be a spoon.

☑ If a man puts a cord around his neck God will provide someone to pull it.

☑ The beard of the guest is in the hands of the owner of the tent.

☑ The barking of dogs does not hurt the clouds.

☑ The palm of one hand does not eclipse the sun.

☑ The camel driver has his plans, and the camel has his.

☑ If you see him riding on a bamboo cane, say to him 'Good health to your horse.'

☑ Hearts are depositories of secrets, lips are their locks and tongues are their keys.

☑ Think of the going out before you enter.

☑ The day has its eyes, the night has its ears.

☑ A strainer is none the worse for having another hole.

☑ Take care, the sleep of non-existence will overtake you at last, for the coming and going of the breath is but the rocking of the cradle.

☑ The hand that you cannot bite, kiss.

☑ May Allah protect me from my friends, my enemies I can handle.

☑ A small date stone props up the water jar.

☑ Catch the halter rope and it will lead you to the donkey.

☑ If a light serves to see, it also serves to be seen.

☑ A dog cannot bite when it has a bone in its mouth.

☑ Trust in Allah, but tie your camel first.

☑ Manage with bread and butter until God brings the jam.

☑ The dawn does not come twice to awake a man.

☑ In the desert one forgets everything, one remembers nothing any more.

☑ The bear knew nine songs, all were about honey.

☑ To the dog that has money men say 'My Lord Dog.'

☑ Let us sit bent, but talk straight.

☑ When the feathers are of gold it is unwise to make broth of the hen.

☑ The biggest nuts are those which are empty.

☑ A town's gate can be shut, a fool's mouth never.

☑ By all means make friends with the dog, but do not lay aside the stick.

- ✓ Into a closed mouth no fly can enter.
- ✓ A smooth lie is better than a distorted truth.
- ✓ A narrow place is very big to the narrow minded.
- ✓ If the prayers of dogs were answered bones would rain from the sky.
- ✓ The best fighting is against yourself.
- ✓ Every sheep hangs by its own leg.
- ✓ If I listen I have the advantage, if I speak others have it.
- ✓ The tongue has no bone, yet it crushes.
- ✓ Don't be deceived by the whiteness of the turban, soap is bought on credit.
- ✓ If a man said to you 'A dog carried off your ear,' would you go after the dog, or search first for your ear?
- ✓ Allah may love a poor man, but not a dirty one.
- ✓ He who is a mocker dances without a tambourine.
- ✓ One must not shoot a glass arrow at a painted deer.
- ✓ The heart of the fool is in his mouth, the mouth of the wise man is in his heart.
- ✓ Better the gurgling of a camel than the prayers of a fish.
- ✓ If you make yourself honey the flies will eat you.
- ✓ The fish in the trap begins to think.
- ✓ Often the best way of giving oneself what one lacks is to take from oneself what one has.
- ✓ There cannot be two stallions in the same small stall of camels.
- ✓ When fate arrives the physician becomes a fool.
- ✓ A clever man's mistake is equal to the mistakes of a thousand fools.

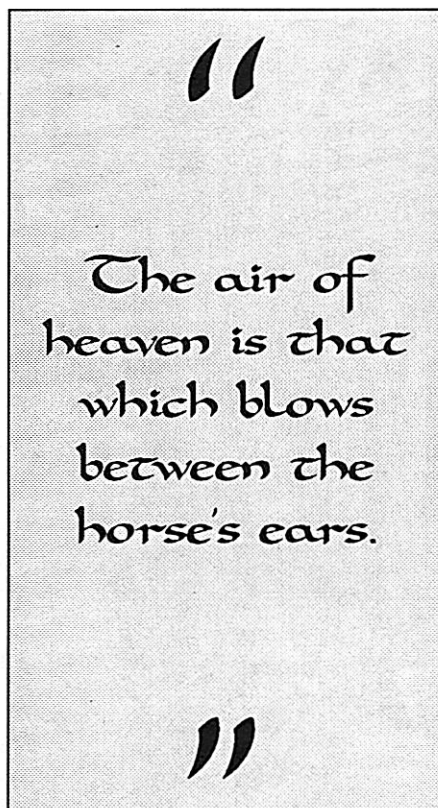

- ✓ When the crow is your guide, he will lead you to the corpses of dogs.
- ✓ Mother a weed, father a weed, do you expect the daughter to be a saffron root?
- ✓ You can count the number of apples in one tree, but you can never count the number of trees in one apple.
- ✓ The camel never sees its own hump, but that of its brother is always before its eyes.
- ✓ The universe is sacred, you cannot improve it. If you try to change it you will ruin it. If you try to hold it you will lose it.
- ✓ Three things cause sorrow to flee: water, green trees, and a beautiful face.
- ✓ Life is a perpetual drunkenness, the pleasure passes but the headache remains.
- ✓ As the sands of the desert are to the weary traveller, so is too much speech to him who loveth silence.
- ✓ However high the eye may rise it will find the eyebrow above it.
- ✓ He who drives an ass must, of necessity, know its wind.
- ✓ Unhappy is the man who has no nails with which to scratch his head.
- ✓ It is he who eats when he is full that digs his grave with his teeth.
- ✓ A dog on the run can safely be kicked.
- ✓ If Fate throws a knife at you there are two ways of catching it: by the blade, or by the handle.
- ✓ It's easy to carry on a war with a spy-glass.
- ✓ Once you put your head into the mortar it is useless to dread the sound of the pestle.
- ✓ Whoever pets scorpions with the hand of compassion gets stung.
- ✓ Nourish a raven and it will pick out your eyes. ■
- ✓ Fortune is with you for an hour and against you for ten.
- ✓ Greed lessens what is gathered.
- ✓ The best kindness is done quickly.
- ✓ What has died has passed.
- ✓ You talk in the east, he answers in the west.
- ✓ If you ask a mule of his lineage he will say only that one of his parents was a horse.
- ✓ The dog's tail is still bent.
- ✓ The jar cannot remain whole forever.
- ✓ If the King at noon day proclaims it is night, behold the stars.
- ✓ A wise woman is one who has a great deal to say, yet remains silent.
- ✓ Every rose has a thorn as its friend.
- ✓ To the donkey one thistle is better than two ass-loads of jewels.
- ✓ Every man thinks of his own fleas as gazelles.





---

## ROLEPLAYING IN THE 23RD CENTURY

---

**T**he focus of adventures set in the world of *When Gravity Fails* should be on roleplaying and problem solving. Combat and action should supplement the roleplay, but not dominate it. You can run almost any type of adventure in *Gravity* that you could in *Cyberpunk*, but the *Gravity* world may give you options and ideas that you've never considered before.

Don't build your scenarios around firefights. The lasers and other weapons of the 23rd century will make firefights quick and messy affairs. Make action add to the drama, not just to the body count, with each scene adding more plot to the adventure. That's not to say that scenarios should be without violence. This is a world where people make up the rules as they go along, and most like to play hardball. Depravity and despotism are going to promote violent situations, and death can come shockingly fast. Just don't let it dominate the story. The *reasons* behind

the violence and the *consequences* that follow should be at least as important to the plot as the action itself.

Don't try too hard to tie this future together with the original *Cyberpunk*. Although the original 'Punk world fits pretty well into the first fifty years of the *Gravity* timeline, the situations in each are also widely different. Do feel free to take those elements that you like from each world and cross them over to the other. Create the fusion which best serves your conception of a dark future. There is no reason why you can't use moddies in a straight-up *Cyberpunk* run, and no reason why *Cyberpunk* corporations can't find a home in a game set in the *Gravity* world. Catch our drift?

---

### EVERYONE LOVES A MYSTERY

---

**O**n the most basic level, *When Gravity Fails* is a detective story. It is also a tale of clashing cultures and self-discovery, with a bit of international intrigue thrown in for spice. It's a perfect model for detective-style adventures, particularly those that seem simple only to grow more and more intricate.

Mystery and detective scenarios make players use their heads more than their hardware, but plotting one out can be a challenge. Mystery scenarios can revolve around any type and number of crimes or situations, but all should contain certain key elements: the *act*, the *motive*, the *technique*, the *trail*, and the *characters*.

The *act* can be any crime or incident that gets the ball rolling, from electronic theft to mass murder. The higher the stakes, the more tension you can generate.

The *motive* will vary, and may not be clear to the characters at first, but the Referee should *always* understand why the criminal did it. Greed, politics and passion are all good potboiling motives. Remember, even apparently senseless crimes occur for some reason, even if it's just the fact that the perpetrator is psychotic. (Why they're psycho can make a scenario all by itself.) Conspiracies make good fodder for motivations as well, with nations and corps constantly waging a deadly war of intrigue.

Coming up with a *technique* can be fun. You get the chance to sit in the perpetrator's head and imagine what twisted methods he might use. In a good mystery the perp is smart and cunning. Otherwise it's no challenge. Use your wits when set-

ting up the situation, and don't choose techniques that are too obvious or traceable. Circumstances sometimes dictate the technique: was the act rash and later covered up, or was it carefully planned months ahead of time? Does the perp prefer poison, or have an affinity for chainsaws? Maybe the body is needed afterwards and must be intact, or the crime is set up to misdirect the investigators.

If the crime was perfect then there isn't any adventure, because there's nothing to investigate. Thus there need to be enough clues and loose ends to allow the party to start putting the pieces together. That's the trail. Not that it should be easy. The trail can be twisted and long, with lots of branches and dead ends. Frustrate your players before you let them solve everything. It will make them more respectful.

Characters add humanity to the plot, and they're a key element in designing any adventure in this setting. Effinger's books emphasize characters over technology. Gadgets influence the plot, but characters drive it. It's the people who inhabit the Budayeen, with all their different quirks and personalities, that make the stories so compelling. Unlike many *Cyberpunk 2020* NPCs, which often exist for no reason other than to give the characters something to shoot at, *Gravity* NPCs should be carefully and individually designed, and their personalities, motivations and behavior should be major influences on the plot and roleplay. You don't have to build complete lives for your NPCs, but having some grasp of who they are and how they act can make them come alive for your players. Treat your NPCs with respect and they'll pay you back.

---

### NOIR: THE FEEL OF GRAVITY.

---

**D**oublecrossing beauties with fire in their eyes and ice in their veins; criminal minds with plans within plans; scheming street vermin looking to make a buck off others' suffering; steel-eyed killers who deal death as easily as they deal cards; desperate men who flirt with violence as a last hope of redemption— these are the denizens of the dark side of existence.

Back alleys full of rats, garbage and blood stains; cheap hotels that rent rooms

by the hour and don't ask questions; dark bars shrouded in smoke, the smell of hard liquor and the low murmur of despair, these scenes make up the world of *Noir*.

This kind of story harkens back to the hardboiled stories of Raymond Chandler and Dashiell Hammett. These masters told tales of men who tried to carve some sense of honor out of an insane and vicious world lurking behind the one most people knew. That world has become the future of *Cyberpunk* and *When Gravity Falls*.

In this arena people use every advantage to gain the Edge, be it a silky body or a fast trigger finger. Often they do it with a facade of civility, playing society's games until they have the chance to grab that brass ring. Then they kill whoever gets in the way. Trust can be a rare commodity, and a deadly weakness. Hope is a lever to be used against people, and only suckers take the fall. You're either a hustler or a mark; there's no in-between. Attitude can keep you alive, but use it on the wrong people and you'll be counting your exit wounds. As with *2020*, mood and atmosphere are everything in a *Gravity* game. As your characters are casing the seamy sidestreets, try to maintain that aura of tension and desperation that makes this the *dark* future.

---

### THE COMMODITY OF INFORMATION

---

**I**nformation is something of value in the 23rd century. In the post-Collapse world, getting the whole story requires real effort. But information is power, and power means survival...and success. Abu Adil and Friedlander Bey have built empires based on the control of information, and they depend on people needing their services. It's no longer healthy to be apathetic and acquiescent; that makes you a mark. If you want to stay on top, establish the contacts and pathways that will slide you the facts you need. Otherwise you'll have to depend on someone else.

---

### TEAMS

---

**T**o unite characters you can still use any of the teams suggested in *Cyberpunk*, but not all are appropriate in all situations. Trauma Teams (under another name) will only

work in more advanced areas, and won't be very common. Media Teams, Mercenaries, Corporate Teams, and Cops can be found anywhere. Bands and Nomad Packs go wherever they like. Gangs cut their turf where they can.

**Administrators** (see the new character classes later in this section) can build teams of troubleshooters, trained specialists under their direction. They are sent anywhere in the Administrator's jurisdiction to solve problems.

Many **Runners** (see new character classes) get their own group of support people together to make the runs go more smoothly. Having a good Tech is a must to help with maintaining the vehicle, and he could even make a good co-pilot if the craft needs it. In order to make the right contacts you need a Fixer you can trust, someone who only takes his fair cut and doesn't talk to clients who don't pay. Then there's always the Netrunner to range ahead and monitor the airways from his console, interrupting enemy radar links and throwing white noise into the communication network. If trouble is expected at the meet point (and when isn't it?), having a dependable Solo or three at your back may convince the buyer that he really does have the gold with him. A few Runners carry an entire entourage with them on their jumps. Rachel "Blackhawk" Esposito trips around India and Burma with a crew of 10 in her Eichner & Voss BR45 Mariner SeaJet. And no-one can get around the sub-continent faster. Believe it.

If your campaign is based in the Budayeen, you may want to have the group be a loose association of people linked mainly by friendship and a sense of mutual usefulness — an information-sharing network. When an interesting job crops up, the people with the right abilities pull together to take advantage of it. Everybody gets his cut. Another possibility is to have the players be members of a family. This will ensure their mutual loyalty and make for some great roleplay.

---

### TEAM SCENARIO SEEDS

---

**h**ere are a few ideas for basic scenarios to get your team started in adventuring in the world of *Gravity*. There is a more elaborate adventure at the end of the book.



## WHEN GRAVITY FAILS

**1** Your runner team is hauling a bunch of refugees out of Egyptian Sudan. On a stop-over in the city, one of the passengers is murdered, and the police suspect a team member. The victim was a Sudanese military officer who, the previous day, had challenged the character to a duel in front of witnesses. The police think that the character decided to settle the matter privately and permanently. The character has no alibi.

The Sudanese was actually killed by another passenger, a young shaykh who was defending the honor of one of the women of his tribe. The soldier made untoward advances, and the shaykh killed him. The other Sudanese passengers support the shaykh, who was following tribal law. They worry that the local authorities will use it as an excuse to hang a "Sudan barbarian," so they remain silent.

The officer was also going to make contact with expatriates in the city to form the core group for a coup. These people want revenge for the murder, and they are willing to bury the whole team to get whoever killed their friend. The player characters had better get cracking.

**2** Your team is approached by a local merchant who wishes you to help Ihsan Abdul Kader, a well-loved local *imam* known for his generosity and keeping of the Five Pillars. He tells a tale of a bogus blackmail attempt which may ruin the *imam's* reputation, and he wishes the team to catch the blackmailer and secure the evidence. The team tracks down the blackmailer, a scummy Japanese techie, and nab the incriminating chips. The chips indicate that Ihsan is an experimental clone who escaped from Japan. Clones are considered soulless under Islamic law, and Ihsan would be cast out or killed were he exposed. Is Ihsan aware of his origins? Who is he a clone of? Before the team can turn the data over, they're bounced by Japanese hit-men determined to keep these questions from being asked.

**3** Your runner team is hired to haul a cargo of technical daddies from Cairo to Osaka. What the team doesn't know is that Australian agents have sabotaged the daddies to interfere with the operations of the buyer, the Mogami-Honshu Corporation. The rigged daddies will be used to train technicians in a new production procedure. The sabotage will lead

to project failures costing billions of yen. Mogami-Honshu is not going to be pleased, and they will try to trace the saboteurs back through the runner team. Look out.

**4** Your troubleshooting team is sent into the desert south of the city to establish contact with a new Bedouin tribe that has migrated into the area from Algeria. The team discovers that the people have been driven east by other tribes utilizing *Sahar* magic. Many in the group display symptoms of acute measles. In fact, factions in the Algerian government have been supplying bio-warfare weapons to certain tribes along with orders to kill or drive out the others in preparation for an Algerian reclamation of the Sahara. Now one of the exiled tribes has wandered into your area, possibly spreading contagion. Algeria has found out about the leak and has sent a search-and-destroy unit across the border to eradicate the incriminating Bedouins. The team is caught in the middle.

**5** Jewd Diab, leader of a local spice *souk* and a team-members' uncle, asks the team to investigate the rise in suicides and crimes of passion in his neighborhood. The incidents can be traced to a new type of moddy called "Perpetual Paradise." It continuously stimulates the pleasure centers of the brain. It also burns out the pleasure centers after 28 hours of use, leaving the victim numb and psychologically crippled. This results in suicidal depression and psychosis. Mercotech has been testing these moddies here to see how they work, selling them through the local black market. Sales have been brisk. Now they're ready for overseas release. The side-effects will work themselves out in time. First, however, they must eliminate anyone who has learned the truth about the moddies.

---

### ADVENTURING ACROSS THE WORLD

---

 The international scope of *When Gravity Fails* gives you a chance to adventure in any number of exotic places, the city being just one of them.

Although *Gravity* is centered around the Middle East, and most of the background we've given you applies to that region, don't feel constrained by it.

Use the richness of the foreign surroundings to enhance the game. Let the environment's beauty or bizarreness set new tones for the action. The differences between business in North Africa and business in New York can keep players from growing complacent, especially when they get arrested by the *mutasib* for talking to a woman without asking permission of her husband first. New rules, new game.

Players can come from anywhere, as technology and the cyberpunk mentality have spread over much of the world. World-spanning adventures may take a little research, but the roleplaying rewards can be well worth it.

---

## NEW CHARACTER CLASSES

---

 These are some of the new character classes which can be played in *Gravity* games, and even in regular *Punk* runs if you like. Skill Packs list recommended skills for each class. Some new special abilities are listed and explained.

---

### ADMINISTRATOR

---

 Big government has died. Now there are dozens of small nations all struggling for stability and supremacy. Politicians and leaders come and go, but the bureaucracy is forever. And that's good, since this is where all of the real work gets done anyway. Only a few people have the right touch to manipulate the wheels of power so that the nation doesn't grind to a halt. Greasing the right palms and stroking the right egos can do as much as a platoon of jump infantry in the chaotic governments of the *Gravity* world.

As an administrator, you are an official assigned to specific projects or districts by your government. Your job takes you into the problem areas in the country and gives you the opportunity to pull together the people needed to solve those problems, be it inserting that mole into Sardinia's Parliament or finding Runners and Solos to get the gold shipment through the danger zone in the foothills. This usually means

organizing and logistics, but often you go in with the troops. You don't always lead, but since it's your butt on the line you'd better be on the scene to make sure the job gets done right.

Like Corps, the administrator special ability is **Resources**, only in this case the skill represents the resources made available to you by the government for which you work. Even a small country has access to materials and funds far beyond most private groups. Admin Resources is also your ability to call in government help as long as national interests are at stake. Abuse it and lose it.

#### Administrator Skill Pack

Special Ability: Admin Resources

Awareness/Notice

Education

Social

Library Search

History

Area Knowledge

Persuasion

Bureaucracy

Manual Computer Use

Streetwise

---



---

### RUNNERS

---



---

**Y**ou had a knack for vehicles and there was one way to make it pay. You started out running needle-guns from the Commonwealth to the Dakota Republics in an electric truck. Then it was armored hovercars careening through the arroyos of Nuevo Tejas, bringing pure Kentucky whiskey and surface-to-air missiles to the rebels. The whiskey went to bribe the local officials and the missiles went to burn Federalé VTOLs. Soon you graduated to the big-time: jump-jetting datacores from Switzerland to one of the Turkish nations. By that time, you were wired so you could head-talk with your machine, binding the two of you even closer in the electron-interface. Now it's just a matter of finding the right contracts to keep you and your machine moving. Maybe this week it'll be a shipment of laser batteries to the Amazon Confederación, or getting refugees out of Holland before the socialists cave in.

As a runner you're one of the drivers, pilots, and smugglers of this dark future. You are the one who gets into the driver's seat and jacks the stuff where it's supposed to go. Friends come and go quick for the man and

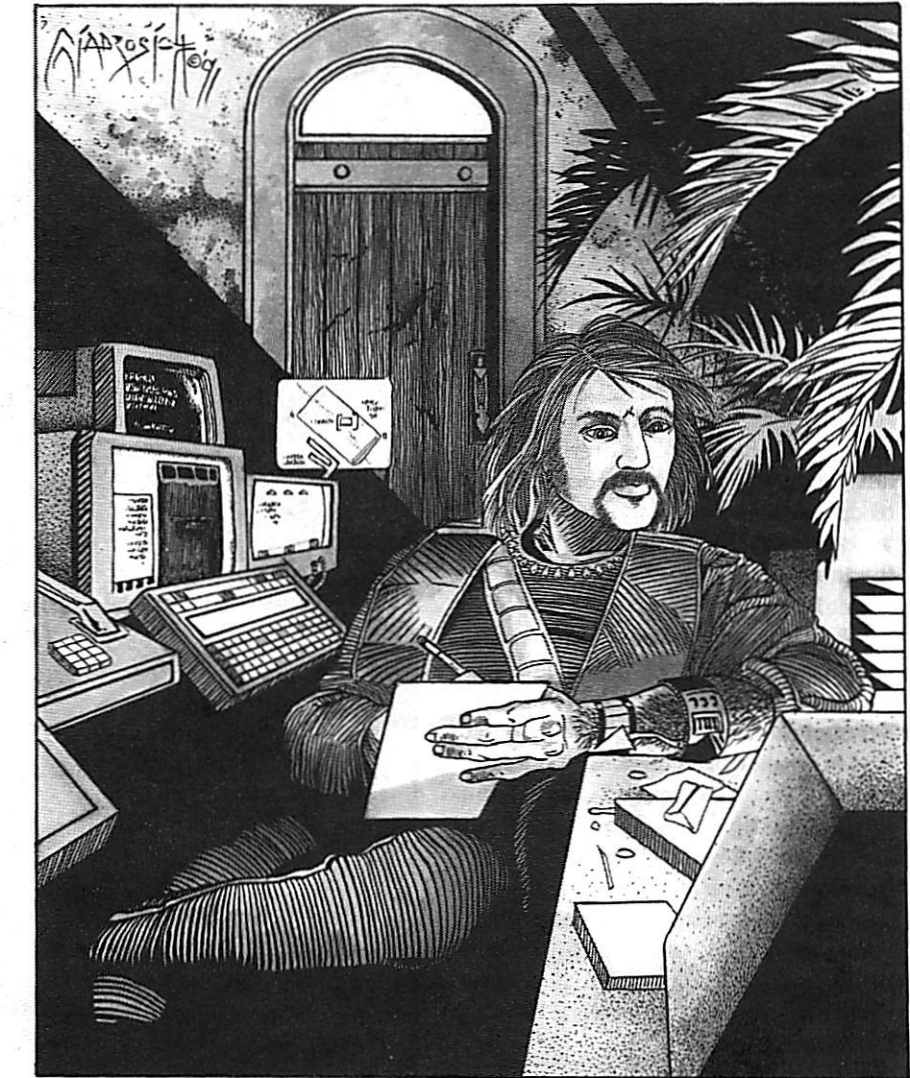

machine on the move, and you don't lay down roots in this line of work. But you've got your Swiss gold bars, Japanese travel kit, some hot Turkish tunes on chip, and a Zeiss pulse laser under your jacket in case things get personal. Outside on the pad sits that MiG SV5A Kestrel, waiting for your head and hand to take it to the limit. Don't confuse smuggling Runners with net-jocks who are sometimes referred to as 'runners.

The runner special ability is **Vehicle Zen**; that certain intangible synergy that allows some individuals to manipulate vehicles in a way that defies belief. Add Vehicle Zen to any vehicular skill when tough maneuvering is necessary.

#### Runner Skill Pack

Special Ability: Vehicle Zen

Awareness/Notice

Pilot (Any two vehicle types)

Tech (For some or all of the vehicles with

which the runner is proficient)

Driving

Brawling

Athletics

Electronics

Streetwise

Basic Tech

---



---

### PRIVATE INVESTIGATOR (AS PUBLISHED IN HARDWIRED)

---



---

**T**he world is a complicated and dangerous place. A lot of people just aren't able to deal with it. Who do these people turn to solve their problems when they can't get anybody else? You. You'll go out there and find the answers for them. You act as an intermediary between the fearful mundane's and dark reality, and then you get stuck cleaning up their messes. That's because you're a



## WHEN GRAVITY FAILS

P.I., a hammer, a tracer. Sometimes the money just isn't enough.

Pushing people's buttons is part of the job, maybe the part you like the best. It's always fun to watch a mark squirm while you grill him. Sometimes he doesn't even know he's being grilled. That's when you know you're jacked and jammin'.

But that's only half of it. A whole lot of dreary hours get spent sitting in front of a datascreen, finding all the threads that form the answers you're scanning for. Most of the time it's data you're not supposed to see. Being prepared is the name of the game, and these streets aren't kind to losers. You lose, you die. Maybe you'd better up your rate.

**Research** is the PI special ability. This is the amount of information sources that the Private Investigator has access to, and his or her ability to use it. Be it snitches, friends, or computer files, the higher the level the more the PI has at his fingertips. Add Research to Streetwise or Library Search roles in investigative situations.

### Private Investigator Skill Pack

Special Ability: Research

Awareness/Notice

Interview

Handgun

Brawling

Human Perception

Streetwise

Shadow/Track

Intimidate

Persuasion

Library Search



a simple data raid on a government complex. Your skills are designed around taking on cover personas that let you move through the establishment you are infiltrating and gather information inconspicuously before you strike.

### PLAYING A SPY

**S**pies are an unusual character class, and they can affect the balance of game play when used in an inappropriate scenario. A player and Ref should always confer in advance when a spy is to be played in a game. Spies are played under the guise of some cover role (see below), and always have a secret agenda to fulfill, separate from the goals of the other players.

### CREATING A SPY

**W**hen a player creates a spy, the character must be given two false-histories and cover roles in addition to his or her actual history and spy role. One is the primary cover role under which the spy is operating. The other is the backup cover for emergency use. Cover identities can be fleshed out with the aid of the lifepath in *Cyberpunk 2020*. Spies use their special ability of Chameleon to successfully maintain their cover roles. Cover roles are picked when the character is generated and may not be changed. In addition to Chameleon, Spies should also buy some pickup skills related to their cover roles.

---

---

## SPY

---

---

**T**hey put you here. You never thought it'd go this deep. You joined because you knew you could make a difference, bring in that assignment that would keep your country free from the violent chaos that surrounds it. Now, after a dozen jobs, you're not quite so idealistic. But here you are, wearing someone else's clothes and living someone else's life for six months. Just so you can be there when *they* need you.

James Bond isn't a real spy; real spies are people you never see. Espionage specialists are trained to assume a variety of guises to complete a mission. The mission may be an assassination, a kidnapping, or

Occupation Table

ROLE	SPECIAL		ABILITY		LEVEL	
	1-5	6	7	8	9	10
Administrator	1,000/mo.	1,500/mo.	2,000/mo.	4,000/mo.	6,000/mo.	8,000/mo.
Runner	1,000/mo.	2,000/mo.	3,000/mo.	5,000/mo.	8,000/mo.	11,000/mo.
Private Investigator	1,000/mo.	2,000/mo.	3,000/mo.	4,000/mo.	7,000/mo.	10,000/mo.
Spy	2,000/mo.	3,000/mo.	5,000/mo.	7,000/mo.	10,000/mo.	13,000/mo.

---



---

## CHAMELEON

---



---

**C**hameleon is the special ability of the spy class. Chameleon gives the spy the ability to assume two possible cover roles to an extent that will confound almost all inspection. Chameleon is more than the Disguise skill in that it allows the spy to emulate the special abilities of his cover roles at a reduced level. The spy may pick the two cover abilities best suited to his theater of operations and mission requirements. The level of the cover identity special abilities is equal to the spy's Chameleon skill divided by two for the primary cover and three for the secondary cover. Round up. Example: A spy must assume the identity of a netrunner, backup role techie, and he has Chameleon 7. The spy has Interface 4 and Jury Rig 3. ( $7/2 = 3.5$ , rounded up to four,  $7/3 = 2.5$ , rounded up to three.) This system limits the spy's abilities in his cover role special abilities, but it allows him enough latitude to operate without detection for long periods of time.

When a spy achieves Chameleon 10, he or she may pick a third cover identity and role. Like the second special ability, the third is bought at Chameleon skill divided by three. When a third role is purchased the spy should construct a history for the cover.

While Chameleon is primarily used to represent training in specific roles, it also means an ability to blend into any situation or culture easily. This is more than just a disguise skill; use it with Persuasion while trying to seem inconspicuous or with Fast Talk to convince someone that you belong in that zone, on that vehicle, in that office, etc. It also represents ability at assuming another persona when acting as a mole with artificial

behavior, mannerisms and so on. Thus it acts like a Social or Performance skill as well. Moddies can certainly make this job easier, but a cory plug is pretty obvious unless you get one of the new behind-the-ear models. This skill may be all that stands between you and a firing squad.

### Spy Skill Pack

Special Ability: Chameleon  
 Human Perception  
 Resist Torture/Drugs  
 One Ranged Weapon Skill  
 One Martial Art  
 Education and Gen. Know  
 Manual Computer Use  
 Shadow/Track  
 Basic Tech  
 Disguise  
 Interrogation  
 Pickup Skills for Cover Roles

---



---

## YOUR MISSION

---



---

**C**he spy presents a special challenge to the *Cyberpunk* Player and Referee. In an already distrustful universe, this character stokes the fires of paranoia even higher. At the beginning of an adventure or campaign the Ref assigns the spy a secret agenda. This is a secondary set of goals that the player must fulfill during the course of the campaign. This is the mission that the spy's government has sent him on, and it must be pursued parallel to the general mission of the group, all without the rest of the group knowing.

The secret agenda may be as simple as gathering any accessible information, or it may get as complicated as terminating an enemy official and framing one of the other party members for the deed. The Ref may

change the agenda at any time that he feels the spy's superiors can make contact. That may only be once every two months, or, if the spy is part of an elaborate network, every few days.

The Ref has the right to deny IP if the player does not adequately follow his Secret Agenda. This is very much a Ref's call. If a player is unwilling to take many risks to complete his agenda then you may knock off up to 1/2 their total points for a given session. If the spy completely ignores his orders then you can withhold all IP and send a couple of dark, quiet men with guns to offer some encouragement.

---



---

## CYBERPUNK ROLES IN WHEN GRAVITY FAILS.

---



---

Techs and Medtechs have lots of new stuff to tinker with, and their skills are needed now more than ever, since weaponry has progressed in the last two-hundred years.

Rockerboys and girls will find a wide audience, although it's harder to get worldwide distribution. There's certainly a lot to sing about. Being a moddy star is another way of literally spreading your way of looking at life. Not to be underestimated as a tool, moddies mean you're inside their heads for real. Getting a cory plug and a recording crew may be the best political weapon you could have. Distribution is complicated, but there are lots of companies willing to sell new moddies worldwide. You just have to find your market.

As long as there is some semblance of civilization we are going to have Cops. Nowadays their jobs are tougher than ever. Not only are the criminals better equipped, but your own government may go belly up any day now.



## WHEN GRAVITY FAILS

**Fixers** are in their element here. This world is in need of so many things, and matters must often be handled discreetly. Any fixer worth his salt can carve a place for himself in the byzantine webwork of trade and espionage. Papa and Abu Adil are fixers taken to the ultimate extent.

**Corporates** are still players in the international arena, but the corporations they serve consider their people pretty expendable and may seem less worthy of loyalty than their *Cyberpunk* counterparts. Still, the resources they wield rival those of many countries. Execs are constantly given assignments in godforsaken areas of the world, where they can play king. For a while.

In a world racked by fragmentation and brushfire wars, **Solos** are always going to have a place. Everyone needs men and women who are ready to kill and surgically equipped to do it faster and better than anyone else. There are plenty of freelance Solos in the *Gravity* world since the governments that created many of them no longer exist.

**Netrunners** may be the hardest hit. Neural links and cyberdecks are available, but the international Computer Net of the *Gravity* world is a lot more limited than the Net in *Cyberpunk*. Only North America, Europe, the Japanese Trade Area and the Middle East have true Nets. The computer system is covered in detail in the Tech section, but suffice it to say that hackers are less powerful in this universe than that of *Cyberpunk*.

Being a refugee is a way of life for many these days. **Nomad** families are now an international phenomenon. Europe, China and America all have their displaced and restless. In a North African campaign, native Nomads may very well be Bedouin, the traditional Arab tribes that still guard the deserts. Bedouins disdain cybertech, but they have a family unity which beggars that of most modern Nomad packs. Tough, resourceful, rich in tradition and respected by most other Arabs, these are good people to have on your side.

---

---

## NEW SKILLS

---

---

These are new pickup skills for use in the generation of *Gravity* characters.

**Computer Use (Tech):** This represents an average person's ability to use computers. Some 23rd century computers respond to neural link as well as voice and keyboard commands, but most can be used manually only. With this skill you can dive for data without being a netrunner. This skill can be substituted for Interface in most netrunning applications, but only with the -4 Keyboard modifier from *Cyberpunk* and an additional -2 since this is not a true skill system for netrunning. If pitted against a real netrunner in the Net, the individual on the manual system will always lose the initiative. Computer Use can be used instead of Library Search when looking for information in databases, but at -3.

**Area Knowledge (INT):** In a world this messed up, knowing what's going on anywhere is a valuable skill. With this skill you have the low-down on a given area no bigger than a small nation or large city or city-state. You'll know the politics and recent history well enough to recognize things that the average person is blind to. At +2, you have a basic background on the area. At +4, you have a fairly deep knowledge of the people and the history. At +7, you have studied or lived in the area and know it intimately. Patterns or disturbances in the area become apparent quickly. At +9, you are so tuned into the pulse of the place that any change is immediately noticeable. That's the kind of thing that can keep you alive, *effendi*.

**Urban Survival (INT):** The ability to survive on the city streets. It involves knowing where to find free food, how to make a cargo container into sleeping quarters, and what gutters are safe to drink from. Knowing which vermin are okay to eat can be important when your apartment is the sidewalk and you don't have the kiam to buy dirt. A good safety-net skill.

**Bureaucracy (INT):** Modern government makes a tradition out of red tape. This skill lets you maneuver through it as painlessly as possible. At +3, you know how to jink minor clerks. At +5, you can sweet talk councilmen and some judges. At +7, you can slice through the worst red tape and bureaucracy and even senators may give you an ear. A necessary skill in an age of petty governments and petty people.

**Beam Weapon (REF):** This is a common weapon skill in the 23rd century. It includes hand lasers, seizure guns, static guns and other induction weapons. It does not include semi-portable or heavy beam weapons (see Tech).

**Heavy Beam Weapons (REF):** Similar to standard Heavy Weapons Skill, but for the more sophisticated, modern systems. Can be applied to vehicular energy weapons.

**Vamp/Con (EMP):** This is the user's ability to separate a fool from his money. The girls in the bars in the Budayeen use their charms to wile marks into buying them drinks for hours. Street hustlers make tourists spend kiam on items they wouldn't want as gifts. That's what this skill is all about. Can be countered by Streetwise.

**Simper (EMP):** Fuad can stop you dead in your tracks and make you listen to the most inane stories for minutes at a time. Then you feel sorry for him. Why? Because he can Simper. This allows a character to elicit sympathy with stories, postures or just plain pathos. In game play it may be used to woo others to your point of view, similar to Oratory, but with a focus on pity and manipulation. Also good for NPCs.

**Tactics (INT):** This skill gives you the edge in small unit actions, allowing you to anticipate the enemy's moves and respond quickly. At +4, you are a trained squad leader. At +6, you are a seasoned veteran who knows how to adapt to changing battlefield conditions. At +9, you are a master tactician.

**Pilot RPV (REF) (IP X 3):** The ability to pilot remote vehicles such as hoverdrones and attack remotes. The operator knows how to use a remote board and interpret its signals. This skill is absolutely necessary for using RPVs in combat. Direct cory-link systems are available, adding +2 to the skill.

**Modular Tech (TECH):** The tech skill for moddies and daddies. This skill allows the techie to determine the contents of chips and create new ones. Usually a skill of +4 or +5 is needed to make chips, but lesser levels are handy for Moddy examination and repair. A useful talent in this day and age. ■

# TO THE CUTTING EDGE AND BACK AGAIN: THE TECHNOLOGY OF WHEN GRAVITY FAILS

**T**he pace of technological advancement has fluctuated greatly over the past hundred years as societies have risen and fallen. Revolution and rebirth have alternately hampered and motivated the development of man's technological base. When one advancement was made, a score of others would be lost to social upheaval.

The paranoia of the pre- and post-collapse years helped to hamper the dissemination of new technologies. Fearful countries kept their experiments and discoveries secret from those they considered their potential enemies—meaning almost everybody else. Some countries would have a thriving wealth of knowledge, while their neighbors struggled with almost medieval conditions.

The relative stabilization of the world situation and the need for commerce eventually allowed technological and scientific developments to start filtering across borders. World markets became the showrooms for new technologies, some of which trickled into backwater countries as flotsam and jetsam on the tide of international trade. Underdeveloped nations began to get a taste of what was out there: cloning, biosculpting, cybernetics, lasers, artificial intelligence, moddies and daddies. Now

many of these things are available all around the world, for better or for worse.

---



---

## MODDIES AND DADDIES

---

### CIRCUITS WITH PERSONALITY

---

**I**n 2065 lab techs isolated specific memories and reaction patterns in test subjects and replicated them in template software from which they could be imprinted into a chipware format. This chipware could then be interfaced directly with the human nervous system via a corymbic implant and receiving socket, allowing the wearer to duplicate selected skills and knowledge of the person from whom the imprint was taken. Artificial abilities, the greatest convenience the world had ever seen. Within a few years, the first commercial models were made available to the public under the brand-name Add-Ons™, "daddies" for short.

Implants were developed to augment and broaden individuals' access to skills in an over-specialized, technological society. At

first they seemed the answer to many of society's problems. With the right plug, doctors could perform procedures that they had never trained for, ambassadors could speak any language instantly, workers could handle unfamiliar machinery, and soldiers could operate any weapon. Unfortunately, in many ways implants caused more harm than good. Education suffered as people no longer felt the need to learn skills. A new wave of illiteracy swept the U.S., Canada, Mexico and Europe. Chip technology soared while the written word languished.

Perhaps Western society could have handled daddies, but then Modular Personalities came out. Developed in Canada, the original, rudimentary moddy circuitry was designed to redirect, clarify, and intensify selected neural signals for use in the therapy of people who had suffered neurological damage or trauma. Neural Feedback Interface chipware aided greatly in the treatment of several neurological disorders. Further development and research soon revealed the true potential of these systems. They could be used to alter an individual's behavior to conform to a free-floating template, either programmed by hand or read from a second test subject. Now artificial skills had competition from artificial personalities.



---

### THE PROLIFERATION OF MODDIES

---

**R**ecognizing a powerful new technology, governments, corporations, and private investors around the world poured billions of dollars into the development of moddies. Less than eighteen months after the first developments were made public, Venezuela, Israel, China, the Eastern Unification States of America, and Prussia all had working models of Modular Personality chips. Many other countries and private groups followed suit in the ensuing months.

The commercial and military uses for moddies were obvious. Labs went to work to fill the orders of governments desiring diverse moddy software for military applications. Corporations marketed the units to the public, exploiting the desire for a new rush.

In the years that followed, manufacturers struggled to meet the demand, flooding the market with over four hundred different moddies. Commercial moddies contained either an aspect of a personality or the personality as a whole. The famous of the day sold the rights to their personalities to moddy labels, allowing themselves to be replicated millions of times on multicolored pieces of plastic and silicon. Researchers and programmers created artificial moddy templates based on the personalities of celebrities long dead and fictional characters. When moddies were combined with skill daddies, true replication of personalities became possible. Now you could think and act like James Bond, and shoot like him, too. Hallucinatory black market moddies began to appear, containing not personalities or personality traits, but memories. The wearer of these moddies experienced the implanted memory as if it were happening at that moment. Moddies became a new kind of drug. The public ate them up. Guests at moddy parties would pass around a tray of the newest commercial or black-market chips. Moddy bars became popular. Teenagers traded moddies. People used moddies to alleviate the boredom of work and school and to enhance their personal lives. Many people became addicted.

The licensing of moddy and daddy hardware and software production allowed the chips to proliferate around the world. Thousands of different personality and behavior chips were available. Corymbic

plugs became one of the most common cybernetic enhancements. Companies specializing solely in moddy and daddy technology began to pop up. With corporate competition and espionage, it was common to see one personality marketed under different labels and several different versions of the same reconstructed fictional moddy on the market.

---

### SHOOTING UP THE ELECTRONIC VEIN

---

**T**he addiction spread like wildfire. Things went from bad to worse in the West. With few cultural traditions to prevent the abuse of the new technologies, it seemed everyone in America was getting wired and tuning out. Apathy became a national pastime. True craftsmanship and creativity became rare.

There were exceptions to the destructive influence of moddies and daddies. Keisha Milton and Graham Proshoka used daddies extensively to draw together all the pieces necessary to make the fusion power breakthrough. Psychological disorders were corrected by surgically implanting the correct moddy. But the problems could not be ignored. Drastic actions were required to stem the downward slide. Rigid controls were instituted. Most of these would disappear when North America disintegrated politically a few decades later.

Fortunately for much of the rest of the world, there was greater cultural resistance to this technology. Some countries required licensing for moddies and daddies. Others forbade all non-military use, or all use period. Despite the preventative measures undertaken around the world, moddies and daddies were a major factor in the chaos which lead to the death of the old world order.

Even though the moddy and daddy craze has passed, the chips remain one of the most commonly used electronic devices. Companies producing them still rake in sizeable fortunes, and the library of available titles continues to expand. The public demand is still there. In some parts of the world the chips are as popular as they were when they first appeared. Many people still live their lives by moddy manipulation, rarely reverting to their real personalities. The difference is that it's a subculture now, not an epidemic.

---

### MODDIES AND DADDIES: A TECHNICAL OVERVIEW

---

**M**oddies and daddies differ greatly in size and shape. Moddies are plug-shaped objects about an inch in length with slots for sub-mounting the much smaller daddy chips. Made of plastic or ceramic, they come in a multitude of colors ranging from dull grey to transparent day-glow orange with visible internal circuitry. Most moddies come with a set of applicable daddies or a list of recommended daddies on the back of the blister pack. A sliver of memory plastic will conform to the opening and keep dirt and water from entering the cory socket. Moddies have guide slots along the side that may be air sealed by simply squeezing the top of the plug. Squeezing again relaxes the plastic, opening the seal and revealing any daddies that may be mounted on the moddy. Moddies come with up to six daddy slots. The order in which the daddies are placed makes no difference. Daddies are generally square, round or octagonal chips one centimeter in diameter, with a one centimeter "handle" attached for ease of removal. They come in as many colors as daddies.

The name "moddy" comes from one of two different sources, depending on who you ask: Modular Personality Chipware or Personality Modification Chipware. Moddies are programmed with a template that usually mimics the personality of a person, living, dead, or fictitious. The template can be burned onto the moddy chip at a lab using a reference copy stored in a large computer or it can be programmed directly into the moddy chip by a programmer working with a personality specialist.

Moddies and daddies need not be used together. The basic cory-plug is only designed for daddies, holding up to 6 at once. The socket and surrounding base is grafted to the skull at the crown or back of the head and is clearly visible unless covered by hair. New, expensive versions may be located behind the ear, making them less obvious. "Chipping in" involves sliding the daddy into the cory plug and clicking it into place. The base of the plug is pressure sensitive and will eject the daddy when pressed. Using moddies



requires a special corymbic implant or a modification of the basic implant. Moddy plugs can accept the standard six daddies, alone or in combination with a moddy, but they can never accept more than one moddy.

When a moddy is inserted, the personality changeover is instantaneous (although there is a brief period of disorientation). The character is now who the moddy tells him he is. The moddy overrides the user's personality and substitutes the chipped template. While the moddy is in place, the user's real personality is below the surface, crowded into the recesses of the mind. The real personality knows what's going on, but on a subdued level. This allows conscious action, as the user may pursue goals and actions which are his own, but decisions and actions will be executed on the basis of the moddy personality. The real fun in social moddy use is in relaxing and allowing the moddy personality to take over.

When wearing a moddy, the user keeps rudimentary memory: who he is, who his friends are, where he lives, etc. All legally licensed moddies have an aware-

ness feature so that the user knows that the current personality comes from a plug and is not natural. In black market moddies these safeguards may be dysfunctional or absent. A person using a black market moddy may suffer from amnesia or delusions (not realizing that he is wearing a moddy), or worse. Many victims of malfunctioning black market moddies roam the Budayeen, drooling quietly and mumbling the moddies garbled language.

---

### MODDIES IN GAME PLAY

---

**M**oddies should be used as a roleplay tool. In roleplaying a moddy, one should keep in mind the personality detailed on the moddy and act accordingly. Players using moddies should work with the Referee, deciding in advance how the moddy will react to certain situations. Work out a list of major occurrences and reactions: how the moddy responds to being attacked, friends being threatened, to insults, seduction and so on. The Referee should note serious swings from the moddy's personali-

ty type (the Judy Garland moddy wouldn't pull out a gun and blow away a few people indiscriminately). Inserting or removing a moddy stuns a player for one round as the mind adjusts itself.

Moddies also affect the user's self-perception. A man who puts on the Marilyn Monroe moddy will feel like a 130 pound woman, to the point of being able to feel aspects of the female anatomy about himself. If a user inserts a moddy with the personality of someone a hundred pounds overweight, he will stagger as he suddenly feels the added weight. The perceptions the moddy imparts are instantaneous, and may be uncomfortable until the user gets used to them. This can be from a few minutes to a few hours. A good rule of thumb is to note severe differences in weight, size, age and sex, and plan how they might affect roleplaying.

The Moddy also gives the user a knowledge of the person he's impersonating. Expert: Moddy Persona at levels ranging from 3 to 10 depending upon the skill of the manufacturer, the price of the moddy and the method used to record the personality.





# TRY A TASTE OF HONEY



*THE NEW HONEY PILAR MODDIE*

## TYPES OF MODDIES

**M**oddies come in four different types. The first three are common, legal models. The fourth type encompasses specially-made black market moddies with unusual applications. The most common are the type we have been discussing in this section, **TYPE 1** moddies. These completely overlay the user's personality. They may alter the user's stats. The second most common, **TYPE 2**, change the user's personality but do not replace it. They may also change the user's stats. **TYPE 3** moddies resemble *Braindance*, the virtual reality braintripping discussed in *Rockerboy*. These moddies contain a hallucinatory scenario with complete sensory detail. A neural interrupter keeps the user from moving his body in response to the hallucination while the chip is active. **TYPE X**, the fourth type, are black-market torture models. They are similar to the third type but contain sensations of pain, torture and even death.

## GETTING HOOKED

**L**ike drugs, moddies have the Addiction Side Effect. **A COOL roll must be made after each 5 uses of any moddy.** Success means you've avoided getting hooked, for the time being. Failure means the onset of addictive symptoms. An addict will lose 2 points of REF and 3 points of COOL after 1D6 hours without a moddy. He will stay at the reduced levels until a moddy is inserted or treatment is obtained. If you just decide to leave the moddy in for days and count it as only one use, we've got news for you.

## INSERT PERSONALITY REJECTION SYNDROME

**S**omething happens to the human mind when it has been under the influence of a moddy too long: Insert Personality Rejection Syndrome, or **InPeRSyn**. Moddies weren't supposed to be used for more than about 24 hours at a time. After a couple of days of constant moddy use, the user's own personality will start forcing itself through the moddy's programming. This will get worse and worse until, by about the third day, the user is only performing a poor mimicry of the moddy's personality.

If the user gets to this state his personality has gone into overdrive. All psychological characteristics are enhanced, and this will become apparent as soon as the moddy is removed. I.e., something that would normally only annoy the user will now drive him to violent rage. Dramatic mood swings plague all victims of InPeRSyn. Phobias and other quirks are intensified. Irrational fear turns to unbearable horror, horror turns to incapacitation, maniacal rages or catatonic insanity. It is best to keep a victim of incapacitation isolated at a clinic until the syndrome passes. Obviously, incapacitation is a common affliction among moddy addicts, and a good reason to keep an eye on them. The best guideline is to not use a moddy for more than thirty-two hours, and if you have used one for more than twenty-four hours, to avoid any moddy use for eighteen hours after that. Characters may safely use a moddy for a number of hours equal to their **COOL x 4**. After that they begin to suffer from the effects of InPeRSyn. They have the full-blown syndrome

after they have used a moddy for **twice the safe amount of time**. It will take **one day for every five hours** of overuse to recover from the syndrome, with the symptoms being worse for characters who go farther over their safe time limit.

## TYPES OF DADDIES

**D**addies contain information which interfaces with the part of the brain responsible for short-term memory. Daddies may either be placed in a cory plug directly or inserted in a slot in a moddy. Daddies come in three types: Active, Utility, and Reactive. **Active** daddies are similar to *Cyberpunk's* APTR and MRAM chips. They contain a skill at a set level and, like *Cyberpunk* chipware, they override any previous knowledge of that skill. *Gravity* daddies do record skills at a higher level than *'Punk* chipware. Active daddies are, more often than not, recorded from subjects who were very competent in their field, and it is common to find daddies with skill levels as high as +6 or +7, although they may be expensive. Active daddies are seldom higher than +7. Active daddies are the kind most often packaged with moddies to supplement the chipped personality.

Utility daddies serve purposes identical to some of the implants in *Cyberpunk*. Biomonitor and sensory recording daddies are common. Reactive daddies actually add to one of the user's skills or stats in some way.

Daddies sometimes grant their user a set of related skills. The Strength Booster daddy gives its user a bonus to his Strength Feat and either his Brawling or Resist Poison & Drugs as well. Daddies have a natural limit, however. They will never enhance a

skill above level 8 or a characteristic above 11 (unless specifically designed — see moddy/daddy construction below). A Reactive daddy will not boost the skill derived from an Active daddy.

Active and Reactive daddies may be used in any combination, but never more than six at a time.

---

## MODDY EXAMPLES

---



All moddy set costs include the costs of enclosed daddies.

**James Bond: Type 1 Moddy/Daddy Set**  
Bond, James Bond. You're cool as ice. In combat you're an ace. Shoot to kill, or wound the mark and grill him for info. You're the top agent in the British Secret Service. The ladies fall at your feet and you never say no. You never say die either. You like small, concealable slug throwers and dry martinis, shaken not stirred. But be careful, there are enemy agents around every corner.

Just by wearing this moddy the user's COOL is raised by 1 (but not over 11). Users of the James Bond moddy seldom wear protective clothing, and always prefer some sort of small, bullet-firing pistol over any other type of weapon. (Slug throwers are, by the way, hard to get anywhere, nearly impossible to get in the Budayeen.) This moddy is hard to come by, but one might turn up with a diligent search or a few kiam in the right hands.

When packaged new the moddy comes with four daddies: Karate +2 (active), Awareness +2 (active), Handgun +4 (active) and Seduction +2 (active). Package cost: 930 EM. Other daddies suggested for possible use with the Bond moddy are: Wardrobe & Style +1 (reactive), Sharpshooter (see below), Shadowing +2 (active), Electronic Security +2 (active), and Stealth +2 (active).

**Honey Pilar: Type 1 Moddy/Daddy Set**  
Seductress Supreme, you are the World's reigning porn goddess. The sultry Spanish Siren. Everybody wants you. Everybody fantasizes about what it would be like to be with you. You're the Lady of Spain. You're Honey Pilar.

The Honey Pilar Moddy comes in several different frames of mind, each based upon a character she has played on one of her sims and overlaid upon the basic Honey Pilar seductress personality. She could be the seductive wife of a Mafia kingpin, a revolutionary in Catalonia's battle for independence, or the rich business executive in need of pool repair. Regardless of the scenario, the user of a Honey Pilar moddy will assume a heavy Spanish accent. Best sellers, Honey Pilar moddies are available at all electronics stores and moddy retailers.

The Pilar moddy comes with an assortment of Daddies: Seduction +6 (active), Expert: various sexual practices +5 (active), Human Perception +3 (active) and Perform +2 (active). Cost: 1400EB. Cheaper sets are available without the expensive sexual practices daddy. Spanish language is also suggested.

### Xarghis Moghadil Khan: Type 1 Moddy/Daddy Set (Illegal)

Xarghis the destroyer, Xarghis the genocide, Xarghis the mangler, Xarghis the torturer. You are the insane leader of an evil cult of bloodthirsty killers. But none are as murderous or as skilled in the art of torture as you. The blue metal angel has spoken the truth to you alone, and His will be done! It is a pleasure to kill the infidel (or anyone, for that matter). You will bathe the streets in the blood and entrails of your victims. Tonight will be the night of a thousand screams.



Possessing this highly illegal moddy carries a severe penalty. It serves one purpose only: to turn its user into a blood-thirsty killing machine. The user becomes fearless and psychotic. This moddy lowers the user's EMP to 1 and boosts his COOL to 10! The user desires nothing other than to torture and then kill, caring little for his own safety. Xarghis Khan eschews ranged weapons, favoring knives and swords. He never wears protective clothing unless it is ultra light. The user is completely insane when this moddy is inserted. Police shoot to kill when dealing with someone wearing this moddy.

Being available on the black market only, this Moddy doesn't come in the usual blister pack, but the three daddies this usually comes with are Melee +5 (active), Stealth +4 (active), and Shadowing +6 (active). Cost: 6190 EM. Incredibly difficult to find.

### Perfect Soldier: Type 2 Moddy/Daddy Set

Yes, sir! I understand the situation and will complete my mission as efficiently as possible. No, sir! Retreat is not acceptable. The enemy must be destroyed and the objective taken.

This is one of the most popular military chips out. Intended for commandos and junior officers, the Perfect Soldier moddy doesn't turn you into a ravenous murderer, but into a dedicated, efficient killing machine. The user's COOL is raised by 3 (Maximum 11) and EMP is reduced by 2 (but not below 1). The user is able to focus his mind clearly on evaluating the tactical situations he faces. This effectively raises his INT by 2 for combat-related tasks, but reduces it by 2 for other tasks. The moddy also imparts a compulsion to obey orders from superiors and complete a mission at all costs.

Daddies included with the set are: Beam Weapons +5 (active), Heavy Weapons +4 (active), Awareness/Notice +4 (active), Tactics +5 (active). Cost: 1910 EM. A common addition is the Pain-Killer daddy, which adds +2 to Stun/Save rolls as long as it is used. Also recommended: Leadership, Martial Arts, and any weapon skills.

### Kick Ass: Type 2 Moddy

Originally created for use with the military, this popular moddy enhances aggression and determination. The user is relatively fearless, and cares little for polite interaction. In game terms, this moddy raises COOL by 2 (not over 11) but lowers EMP by 2 (not



## WHEN GRAVITY FAILS

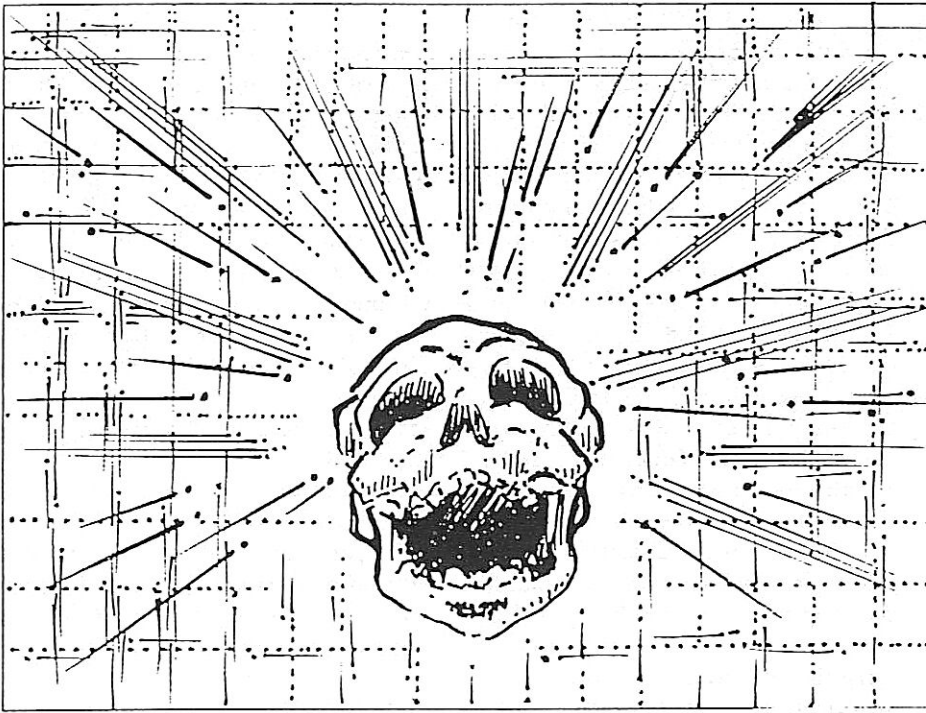

below 1). The lower the EMP the more uncontrollable and violent the user becomes. Also called the "Rex Moddy," this chip is available in limited numbers. Most people like to hold on to theirs. Cost: 550 EM. This moddy is not sold with any daddies, and the package doesn't list any which would be applicable.

### Sunny Day: Type 2 Moddy

What a lovely day it is! Oh, how the sun shines down on the Budayeen today! Allah must be proud of me to present me with such a lovely day. Here comes my friend Fuad. Oh Fuad, how handsome you look today. Allow me to compliment you on your intelligence.

This moddy puts its user in a good mood. He thinks that everything is beautiful and that everyone is a friend. It doesn't raise the user's EMP stat, but it will keep the user from panicking in tight situations. The user will remain calm, even happy in the face of crisis. Luckily this doesn't impair the user's judgement too much. It is a favorite among people who intend to deal with large, dangerous types. When wearing this moddy the user gains +4 to cool rolls vs. intimidation and +2 to Resist Torture/Drugs. This moddy is also -4 to the user's attempts to intimidate anyone else. Like the Kick Ass moddy, this moddy isn't normally sold with accompanying daddies. It is very common, often found in 50% off bargain bins. Cost: 900 EM (before possible discount).

### Wise Counselor: Type 3 Moddy

You find yourself in a shadowed hall, or on the top of a sand dune, or even in the breezy courtyard of a mosque. Sitting, kneeling or standing before you is a wise looking old man (or woman in some models). You feel great awe and peace of mind in his presence. You feel that he has the answers to all of your questions. You need but ask.

Wise Counselor is a hallucinatory moddy which creates a virtual reality in the user's mind. The wise man is a composite assembled by the moddy from the user's subconscious and buried memories. The user asks the Wise Counselor questions about current dilemmas. The Counselor will answer in cryptic phrases or symbols. It is from this that the user must attempt to discern the answers to his problems. The user must make an INT roll (difficulty 13) to interpret the Counselor's answers. One roll may be made per hour. If the roll fails, the user considers the Counselor's answer to be gibberish and no further rolls are possible on this issue. If the roll is made, the user gets +2 to any INT roll he may have to make to solve his current problem (Wise Counselor will help you, but it will *not* solve your problems). In a roleplay situation a successful roll will get you some hints from the Referee on how to proceed. This moddy is very scarce, and probably unavailable without connections. It cannot give clues to questions the user has no chance of knowing. Referees should be creative when speaking as the Wise Counselor.

This moddy comes without daddies, and is not designed to accept them. Cost: varies, but extremely expensive. Up to 12,000 EM.

### A Thousand Nights and a Night:

#### Type 3 Moddy

This moddy is for entertainment only, and is typical of type 3 moddies. The user experiences the mythical tales of Sultan Shahryar and the stories of a Thousand and One Nights. This Moddy can be found anywhere along with hundreds of others of its type including children's stories, action/adventure and pornography. Cost: 100 EM. Not designed to accept daddies.

### Type X Moddies

Type X moddies are used for torture. They contain up to three different sensations of pain or pleasure (most often pain). Type X moddies force their recipient to endure all of the moddy's recorded sensations. Each sensation loaded into the moddy will add +1 to +3 (depending on the severity of the sensation) to an interrogation roll directed at the wearer. The highest total level is +9. This moddy acts in lieu of the interrogator's own skill (if applicable). These moddies are very hard to get and very illegal as they must be recorded directly from a person experiencing the desired sensations. Most crimelords have theirs personally made. Sometimes the moddy contains sensations which can kill the recipient or drive him unconscious. For every three points of interrogation the recipient will take 1D6 of damage (for a total possible 3D6). BTM applies. Fatalities result from cardiac arrest. Rare versions of these chips have sensations recorded from animals. Common sensations are drowning, burning, flogging, cold, bone breaking, vivisection etc. Cost: 500 EM per sensation. (500-1500 EM)

---

## DADDY EXAMPLES

---



Active daddies contain the recorded reactions and knowledge of someone else and therefore can contain any type of skill. Active daddies are the most common and accessible of the three types. Reactive are the rarest. For skills available refer to the list on page 73 of *Cyberpunk 2020* or make up your own with Referee approval.

**Sharpshooter: Reactive Daddy**

This rare and expensive daddy increases the user's skill with handguns by +2 (but not above 7 total). A secondary effect of the daddy is to increase the user's level with either submachineguns or rifles (there are two types of Sharpshooter daddy) by +1. Cost: 600 EM.

**Streetfighter: Reactive Daddy**

Easier to find than Sharpshooter but comparably priced. This daddy increases the user's level with Brawling by +1 and Melee by +2. Cost: 600 EM.

**Crystalclear: Reactive Daddy**

This daddy increases the user's Awareness and Human Perception by +2, boosting the ability to concentrate on sensory input. Readily available in upper-class stores, but expensive. Cost: 700 EM.

**Dream Date: Reactive Daddy**

One of the newest on the market, this daddy counsels the user on proper attire and grooming techniques. +3 to the skills of Personal Grooming and Wardrobe & Style and +2 to Seduction. Available in only the most posh stores with exclusive clientele. Cost: 600EM.

**Body Manipulator: Utility Daddy**

This increases the user's strength by directing the brain to subtly alter body chemistry to increase adrenaline and rapidly break down fatigue toxins. It also regulates breathing and circulation. The result is +1 to the user's Body (maximum 11). Every two hours of use demands one hour of rest. Rare and expensive, this daddy is illegal to use in professional competition unless specifically noted. Cost: 1000EM.

**Biomonitor: Utility Daddy**

This daddy performs the same functions as the Biomonitor cyber enhancement in *Cyberpunk 2020* by constantly informing the user of his or her physical state. This information is in the form of visual readouts appearing in the user's mind when requested. Readily available at a reasonable price. Cost: 200 EM.

**Reflex Enhancer: Utility Daddy**

This daddy works like Kerenzikov booster-wear. When inserted it boosts the user's Reflex by +1 (not over 11), but without the humanity cost. Expensive but common, the

staple of most high-priced hit men. It is rumored to be available in higher boosts if you can find them. Cost: 1000 EM.

**Arabic: Active Daddy**

Self-explanatory. With basic Arabic grammar, vocabulary, and idiom and a basic primer on Arab customs. Available in several regional dialects. Gives the user Arabic Language +5 and Expert: Arab Customs +2. Available anywhere. Cost: 40 EM.

---

## CONSTRUCTING MODDIES AND DADDIES

---

**A**lmost any personality type can be fitted onto a moddy and any skill onto a daddy. Consider the limitations described in the rules when constructing your own moddies and daddies. These limitations are not set in stone; experimental models pop up on the street all the time. They are generally applicable, however. Confer with your referee when you plan to exceed suggested limitations.

---

## BUILDING DADDIES

---

**B**uilding Active daddies is not difficult. A recording of the appropriate brain patterns are taken from an expert with the desired natural skills. This process requires Modular Tech +4 and a fully-equipped chip recording studio. The expert must also have a cory plug to record from. The big trick is making sure that all the necessary information is recorded while extraneous stuff is filtered out. **Active daddies have a Difficulty of 4x the desired Skill level.** You cannot record a higher skill level than that of your source subject.

That's why experts make the big money in recording sessions.

Reactive daddies are tougher to make since they have to respond to a character's attributes. **Reactive Daddy recording Difficulty is 8x the desired bonus.** Reactive daddies can have up to three skills of the same type or two skills that are of different types but related in some way. (See Crystalclear daddy for an example.) There is no difficulty modifier for multiple skills. Reactive daddies seldom add over +3 to a skill.

Utility daddies serve the same purpose as much of the implant cyberware in *Cyberpunk*. Reflex Boosters, Pain Editors, Adrenal Boosters, Biomonitors and Voice Stress Analyzers can all be replicated with utility daddies. Some restrictions must be followed. Utility daddies can never add more than +1 to a stat. Utility daddies may also boost sensory input, like enhanced audio and visual cyberware in 'Punk. Since Utility daddies don't impart skills, they have a different difficulty system. Utility daddies have a base 20 difficulty to create. Follow the difficulty modification guidelines for moddies if the daddies change stats. These are listed below.

---

## PRICING ACTIVE AND REACTIVE DADDIES

---

**D**addies are a good deal cheaper than their *Cyberpunk* counterparts because manufacturing technique has simplified in the future. Base costs for daddy chips follow a simple rule. Each category of skills (REF, INT, BODY, COOL, EMP, TECH, ATTR) costs a certain amount per level. Multiply all costs by the IP modifier (listed in parentheses next to applicable skills in the *Cyberpunk 2020* skill descriptions; pp 36-43).

Remember: Active daddies seldom go over +7, Reactive daddies over +3. Most Type 1 moddies come with two to four

Daddy Costs Per Level		
ATTR SKILLS:	ACTIVE = 30 EM	REACTIVE = 80 EM.
BODY SKILLS:	ACTIVE = 40 EM	REACTIVE = 100 EM.
COOL SKILLS:	ACTIVE = 40 EM	REACTIVE = 120 EM.
EMP SKILLS:	ACTIVE = 100 EM	REACTIVE = 200 EM.
INT SKILLS:	ACTIVE = 40 EM	REACTIVE = 150 EM.
REF SKILLS:	ACTIVE = 50 EM	REACTIVE = 200 EM.
TECH SKILLS:	ACTIVE = 50 EM	REACTIVE = 200 EM.



## WHEN GRAVITY FAILS

active daddies, and occasionally one reactive daddy. Daddies sold with a moddy may be 10% to 40% cheaper than if bought by themselves. Reactive daddies have no price penalty for multiple skills.

---

---

### PRICING UTILITY DADDIES

---

---

**U**tility daddies have functions similar to implant cyberware in *Cyberpunk*, and they are priced on a different system than active and reactive daddies. Utility daddies cost twice what the comparable cyberware costs in *Cyberpunk*. The trade-off is that there is no humanity cost.

---

---

### DADDY COST EXAMPLES

---

---

**Sharpshooter Daddy (Reactive):** Handgun +2 (reactive) = 400 EM. Rifle or Submachinegun +1 (reactive) = 200. Total: 600 EM.

**Crystalclear Daddy (Reactive):** Awareness +2 (reactive) = 300 EM. Human Perception +2 (reactive) = 400. Total: 700 EM.

**Biomonitor Daddy (Utility):** Same function as Biomonitor Cyberware, which costs 100 eb.  $100 \times 2 = 200$  EM. Total: 200 EM.

---

---

## BUILDING MODDIES

---

---

**M**oddies are more complicated. All require a full moddy studio set-up with some very powerful computer systems and some-one with Modular Tech +5. A highly complex moddy not only adds the chipped personality but some of the associated physical or mental characteristics. The two most influenced stats are COOL and EMP, as they are closely connected with personality. INT is third, but REF and even BODY can be affected. The Base Difficulty to record is determined by the type of moddy: **TYPE 1=20, TYPE 2=18, TYPE 3=15, TYPE X=20.**

Every level of EMP or COOL change that the moddy causes, whether up or down, adds +2 to the difficulty. Every INT level change is +3, and BODY or REF changes are +5 per level. If the subject personality is dead or fictitious, add +5 to the Difficulty. These numbers can also be used

for figuring utility daddy difficulty modifiers. Other factors may affect the Difficulty at the Ref's discretion. Since difficulties can be high, people can pool their skills as in the "Pooling" rule for program writing on page 158 of the *Cyberpunk 2020* rules.

**Example:** The James Bond moddy is a TYPE 1, Base Difficulty 20. It increases COOL by +1 and is based on a fictitious character. Total Difficulty is 27 ( $20+2+5=27$ ).

---

---

### PRICING MODDIES

---

---

**P**ricing moddies is complicated since it is based on market values, not difficulties. The cost of creating moddies is based on such factors as the rarity of the personality of the moddy and the accuracy of the duplication. The availability of the moddy is the basis upon which further costs will be calculated. Moddies come in three categories of availability: Common, Uncommon and Rare.

---

---

#### COMMON

---

---

**Type 1:** Modern celebrities, current popular holo/vid characters, famous historical figures, popular fictional characters. **Type 2:** Simple or single emotions: hate, happiness, sorrow. **Type 3:** Popular stories, pornos, up to 30 minutes long. **Base Price: 100 EM.**

---

---

#### UNCOMMON

---

---

**Type 1:** Obscure historical personalities, up-and-coming celebrities, famous vid/book characters from rare sources. **Type 2:** Specific emotional sub-types and combinations on demand only: controlled anger, sorrow, happiness, calmness, cooperativeness, hatred, determination. **Type 3:** Old, out-of-date vids or books converted to chip, banned or infamous stories or pornography. **Base Price: 250 EM.**

---

---

#### RARE

---

---

**Type 1:** Rare or obscure historical personalities, characters out of books, vid stars. Powerful modern celebrities or personalities. Blackmarket personalities: serial killers/criminals. **Type 2:** Extreme emotional



states: suicidal depression or anger, berserk rages, slave-like loyalty, uncontrollable lust. Controlled dangerous emotions: homicidal tendencies, pyromania, sexual perversion. **Type 3:** Rare books translated to chip, obscure old movies (pre 21st century), banned films or books. **All Type X moddies. Base price: 500 EM.**

---

---

### RAISING CHARACTERISTICS

---

---

COOL, EMP, and INT are the most often affected by a moddy's program. To add elements which raise characteristics raises the value of a moddy.

**Raising either COOL or EMP costs 200 EM per point.** Raising the other stat, if both are raised, is 100 EM per point. The statistic which is being raised the most must be paid for first. To raise the values up to a bonus of +3 costs 600 EM for the first stat and 300 for the second. A bonus can never go over +3 except in extremely experimental moddies far beyond most character's financial reach. **Raising INT costs 500 EM per point.** INT may not be boosted more than +3. **Raising REF or BODY is 400 EM per point.** These characteristics may never be raised more than +1.

The most extreme and expensive stat change is where the stat is boosted to a straight 12 or lowered to a flat 1. This is extremely rare and should be used with caution by the Game Master. The most

common example is the Xarghis Khan moddy (see above under moddy examples). To boost a stat to 12 costs 5000 EM, a second stat costs an additional 5000 EM.

---

## LOWERING CHARACTERISTICS

---

**L**owering any characteristic *except* EMP lowers the cost of the moddy. Lowering a characteristic lowers the cost of the moddy by half of what it would cost to raise that characteristic by an equivalent amount. *Under normal circumstances no characteristic may be lowered by more than the amount it may be raised by.*

**Example:** The thoroughly unpopular Coward moddy reduces one's COOL by one point, lowering the cost of the moddy by 100 (200/2) EM. Lowering COOL by two would lower the moddy's cost by 200 (400/2) EM. Lowering a second statistic by one point would be a 50 (100/2) EM reduction, by two a 100 (200/2) EM reduction. A characteristic can never be taken below 1. *The cost of a moddy can never be reduced to lower than half its base cost.* Taking this into account, the coward moddy could never cost less than 50 EM.

---

## RESISTANCE AND SUSCEPTIBILITY

---

**S**ometimes a moddy can change how a skill effects the user. With the Sunny Day moddy, the character's incredible good mood and calm nature made him resistant to Intimidate and Interrogate. A moddy can make a character resistant to other people's attempts to use up to two of the following skills: Interrogation, Intimidate, Resist Torture/Drugs, Human Perception, Seduction, and Persuasion and Fast Talk. **Resistance costs 200 EM per point for each skill. Making the user more susceptible to these skills lowers the cost of the moddy by 100 EM per point for each skill.** Plus or minus 4 pts per skill is the maximum amount of resistance or susceptibility.

---

## OTHER FACTORS

---

**T**he Ref should feel free to adjust costs to reflect popularity, availability or hype on any

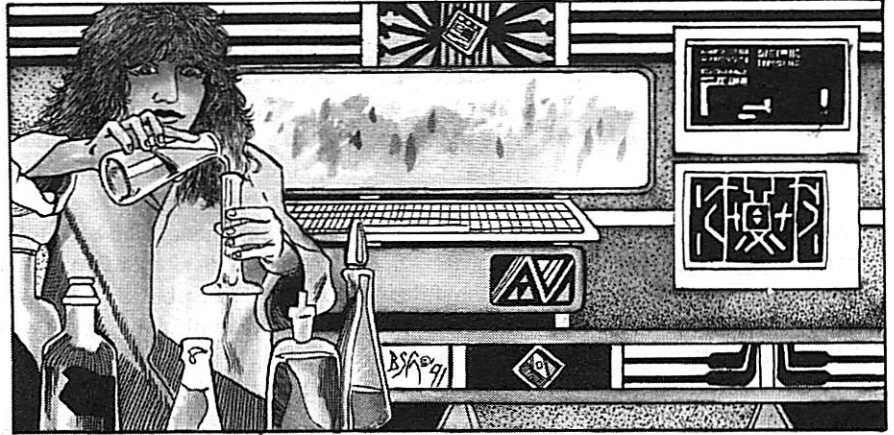

particular moddy. (This, along with included daddies, is why the moddy examples listed earlier may not exactly follow the price guidelines.) The guidelines will give you a ballpark figure from which to judge the final price. Most moddies come with the space to fit six daddies. Having no daddy slots reduces the cost of a moddy by 50 EM.

---

## MODDY COST EXAMPLES

---

James Bond Moddy (Type 1): Uncommon = 250 EM. +1 Cool = 100 EM. Moddy subtotal = 350 EM.

Featured daddies: Martial Arts +2 (active)= 100 EM, Awareness +2 (active)=80 EM, Handgun +4 (active)= 200 EM, Seduction +2 (active)= 200 EM. Daddy subtotal = 580 EM.

Package total: 350 + 580 = 930 EM.

Sunny Day Moddy (Type 2): Common = 100 EM. +2 resistance to Torture & Drugs = 400 EM. +4 resistance to Intimidate = 800 EM. -4 to user's Intimidate skill = -400 EM. Moddy subtotal = 900 EM.

No daddies.

Total: 900 EM. Poor sales may lower cost 50%.

Moddies and daddies play a great role in the Budayeen. Most are readily available from specialized shops and even street hawkers. Prices can vary widely from those listed, especially at Laila's. New models are being developed frequently and old ones modified and improved. They are the cutting edge of personal electronics. Chip in, if you can hack it.

---

## WONDERS IN THE AGE OF CHAOS

---

### BIOTECH AND TRANSSEXUALITY

---

**G**enetic engineering and biosculpting have advanced greatly in the world of *When Gravity Fails*. Nanotechnology, gene splicing and editing, and hormonal and viral engineering have combined to allow complete physical and psychological restructuring of the human body. Many of these alterations are frightfully expensive, and common only among the very wealthy. They are also either frowned upon or completely taboo in some cultures.

---

### Why LET GENETICS STOP YOU? THE TRANS-SEX REVOLUTION.

---

**S**exual reassignment is the most common form of body restructuring. In *Gravity* sex changes are both common and widely accepted. Most people treat sex changes like anyone else.

The quality of modern sex changes is excellent. People look, feel, and sound like the gender of their modification. More expensive sex changes are harder to detect. The base difficulty of detecting a sex change is 20 (INT roll). This can be modified up or down by wardrobe, behavior, and cost and location of the operation. Expensive sex-changes from rich countries are physically completely undetectable, even with gene-mapping.

## WHEN GRAVITY FAILS

The cheapest, most basic sex changes usually restructure only fundamental physical characteristics and a few genetic characteristics. They may or may not include vocal reconstruction, involved hormone therapy and psychological counseling. Basic changes are sterile and can neither conceive children nor lactate. More expensive changes impart fully functioning internal and external sexual organs and hormonal patterns and the ability to bear or father children (unless sterility is requested).

includes psychological counseling. The ability to father children only costs 1000 EM. Higher levels of change involve better surgical techniques and complex therapy and require a top-level medical institution. The El-Amir hospital in the *Gravity* city can handle all but the most high-level changes. The highest level changes are available only in Europe, the US, the Pacific Rim and a few parts of the Middle East.

One component of most sex changes is a bodysculpt to increase one's ATTR. It is

individuals for specific tasks. Biotech is common among special agents, assassins and commandos. Usually someone with biotech will have a few stock items and one or two custom pieces designed to suit that person's specific tasks in the most efficient way possible. There are as many different kinds of biotech as there are people who have it. See later in this section for a more detailed description of biomechanics.

Cybertech is less varied, although the number of different items is just as innumerable. The most common cyberware includes intercranial enhancements such as corymbic implants, cyberoptics and cyberaudio. Limbs and other enhancements are also available, but less common due to their price and visibility. Except for cory plugs, cybertechnology and biotech are rare in places such as the Budayeen.

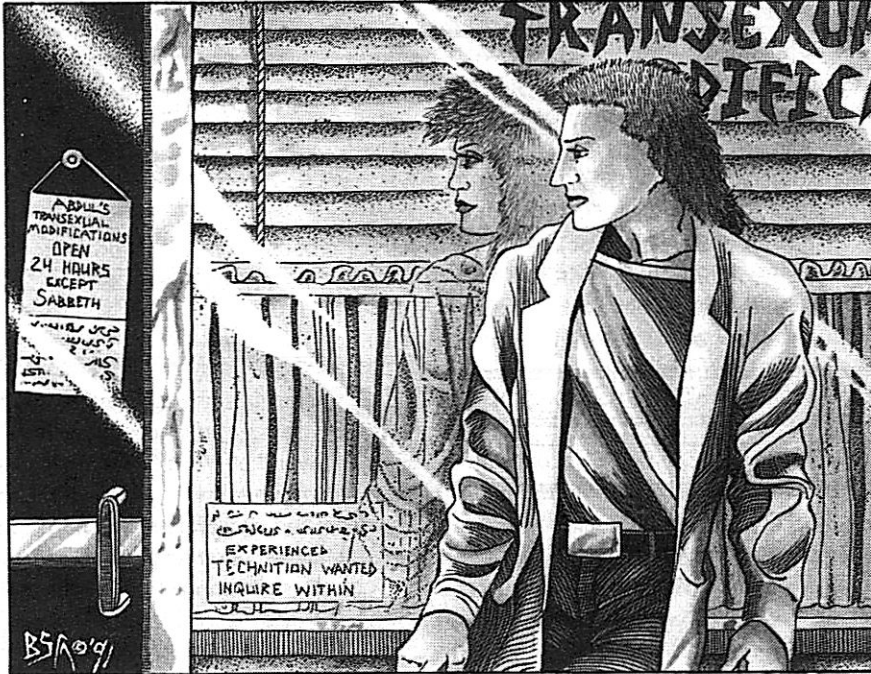

### GETTING A SEX CHANGE

**B**asic sex change requires a one month course of hormone therapy, gene editing and nanotech injection followed by a one week hospitalization and a one to two week recovery period. No counseling, no follow up treatment.

Total cost is 1200 EM for the prep and 3000 EM for the operation.

More advanced sex changes are more complete and harder to detect. Each increase of 5 in the difficulty of detection doubles the cost of the whole procedure and the time it takes to complete it. A change with difficulty 25 to detect costs 8400 EM and takes two months of prep and two weeks in hospital. A 30 costs 16800 EM and requires four months of prep and a month in hospital. The ability to bear children costs an additional 5000 EM and

identical to the bodysculpting in *Cyberpunk 2020*. There is hardly a prostitute in the Budayeen without an ATTR of 8-10, all bought and paid for.

Sex change has a 1D6 Humanity Cost. Counseling cancels the humanity cost.

### CYBERWARE, BIOWARE AND BIOMECHANICS

**B**iomechanics, or biotech, is cybertech's modern cousin. Less obvious and psychologically damaging than cyberware, biomechanics are also much more mysterious, harder to get and more expensive. Although there are some standard items, most biotech is custom designed and built to fit specific

### CYBERWARE AND BIOWARE

**A**ny item from the *Cyberpunk* rulebook is likely to be found somewhere in the world of *When Gravity Fails*. Some items are more common than others, and some are obsolete by *Gravity* standards. **Chipware processors and interface plugs have been replaced by the Corymbic Implant.** Cory plugs perform many of the functions that interface plugs and neuralware did in *Cyberpunk*. The following is a description of a few items which can be obtained in the *Gravity* world either easily, or with some diligent searching, connections, or a lot of money.

### CORYMBIC IMPLANT AND PLUG

**C**his is the *Gravity* equivalent of the Interface Plug. The cory plug is an advanced version, serving all the purposes of the interface plug without requiring a neuralware processor or different links to operate smart-chipped equipment. The cory plug consists of a round receiving slot surrounded by a facing ring which is clearly visible above the skin. Always implanted in the head, the cory plug links



## CONDENSED CYBER/BIOWARE LIST

CYBERWARE	SURG.	I.D. CODE	DESCRIPTION	COSTH.	COST
CORYMBIC IMPLANT	(MA)	(CORY)	ALLOWS DADDY USE	500	2D6
MODDY LINK	(N)	(MODL)	ALLOWS MODDY USE	100	
MODDY RACK	(M)	(SDMR)	HOLDS MODDY/DADDY	200	1D6
NICTATING MEMBRANES	(M)	(NICM)	EYE PROTECTION	400	1D6/2
ANTI DAZZLE NICM	(M)	(ADNM)	FLASH PROTECTION	500	1D6/2
POISON SAC	(MA)	(PGL)	POISON RESERVOIR	500	2D6
POISON GLAND	(MA)	(VGL)	POISON PRODUCER	1200	3D6
WATER REFILTRATION SYSTEM	(MA)	(WRS)	WATER FILTRATION	2500	1D6
UV BLOCKERS	(N)	(UVBL)	UV/IR RESISTANCE	1500	1D6/2
FEATURE ALTERATION OPTION	(N)	(FAO)	FACIAL QUICK CHANGE	3500	1D6
ADVANCED CORTICAL IMPLANT	(CR)	(ACIS)	EXPERIMENTAL	150,000	3D6

parts of the brain to the interface network located at the base of the plug with micro-filaments and co-processors, making the brain receptive to moddy and daddy programs. Initially for use with daddies only, the cory plug doesn't allow for moddy use without a moddy link (see below). The basic cory plug accepts six daddies and allows vehicle and equipment interfacing. Currently only one cory plug can be installed in an individual, although there are experiments involving multiple plugs underway in some laboratories. More expensive cory plugs are mounted behind the ear and are less unsightly than those mounted on the crown or back of the skull. A basic cory implant costs 500 EM. A behind-the-ear model costs 1000 EM. 2D6 humanity cost.



## MODDY LINK

A simple accessory which can be installed in a cory plug, enabling it to receive moddy chips. Only a close inspection can reveal that a plug has been modified to receive moddies. 100 EM.

## SUBDERMAL MODDY RACK

A moddy/daddy rack contained in a subdermal pouch with a self-sealing memory plastic opening. The rack can contain three moddies and up to ten daddies. 200 EM (as subdermal pocket in *Cyberpunk*). 1D6 humanity cost.

## NICTATING MEMBRANES

Thin, transparent membranes which sweep down to cover the eyes, protecting them from debris and injury. They give +4 to saves vs. any eye irritants such as tear gas or mace. Also offering full protection against mundane air or waterborne particulate's such as sand or dust. They can come in several colors. They also allow full visibility under water. 400 EM. For an extra 100 EM they can be impregnated with a photoactive chemical that gives anti-dazzle protection. 1D6/2 humanity cost.

## POISON SACS AND DUCTS

Synthetic sacs, vat grown and surgically implanted in any area of the body where a duct can

easily lead to the surface. Ducts are commonly connected to some injection device such as a hollow tooth or claw. Each sac can hold up to four applications of any drug or chemical and will release one application upon a mental command. Vampires are a good way to inject the poison. Hollow vampires cost 50 EM more than regular vampires. A hollow claw costs 250 EM, 2D6 humanity cost. A retractable needle in the fingertip costs 650 EM, 2D6 humanity cost. Poison sacs can be refilled with a special applicator that comes free with installation. Beware, a ruptured sac can leak its contents into the owner's body! No more than two sacs may be implanted in one person. 500 EM, 2D6 humanity cost.

**Poison Gland.** A true bioware option. Unlike Poison Sacs these are true, living glands, genetically engineered, grown in vitro and surgically implanted in the user's body. The glands produce and store certain kinds of venom. Each gland can hold eight doses of its venom, replacing spent venom at the rate of one dose per hour. The Poison Gland is specifically designed to produce only one type of toxin or chemical. It is possible to have two Poison Glands, each secreting a different substance. Altering a gland's product takes nanosurgery and gene therapy. Venom is delivered the same way as from Poison Sacs. No more than two glands may be implanted in one person. Possible gland products include Biotoxin One, Sleep Agents, a 5D6 nerve toxin, or hallucinogenic drugs. See the Drugs and Poison table on page 89 and the drug rules on page 112 of *Cyberpunk 2020* for more information. 1200 EM, 3D6 Humanity Cost.

## WHEN GRAVITY FAILS

### WATER REFILTRATION SYSTEM

**H**eavy bioware, this system of synthetic organs is designed to fill the needs of those who spend long periods in the desert: Bedouins, traders, and soldiers. This system interfaces with the colon and kidneys and significantly decreases the amount of water in body wastes. The recaptured water is redirected into the bloodstream. The system monitors blood solute levels, and it will not retain water when it is unnecessary to do so. This system triples the length of time that a person could normally survive without water. Installation is complex, requiring a month of nanotech injections and three days at a hospital. 2500 EM, 1D6/2 humanity cost.

### UV BLOCKERS

**A** nanotech system which monitors the levels of UV light striking the skin and accelerates the production of melanin and bioengineered skin pigments when necessary. Within five hours after initial exposure all unprotected skin will have darkened considerably. At this point the person is immune to all effects of ultraviolet light. The system will not activate unless exposure exceeds a preset threshold level. It takes about one week to wear off. This technology was developed by caucasians working in Africa and the Middle East. Natives are generally more resistant to the effects of ultraviolet light. Installation involves gene therapy and nanotech injections. 1500 EM. 1D6/2 humanity cost.

### FEATURE ALTERATION

**T**his set of implants allows the user to subtly change his or her physical appearance within a few hours. Small, movable appliances are inserted under the muscles of the face. These can shift to alter the appearance of the chin, brow ridges and cheekbones. A series of glands producing an oil soluble dye are installed in the scalp. These can change the hair color within about three hours. Common with spies and agents,

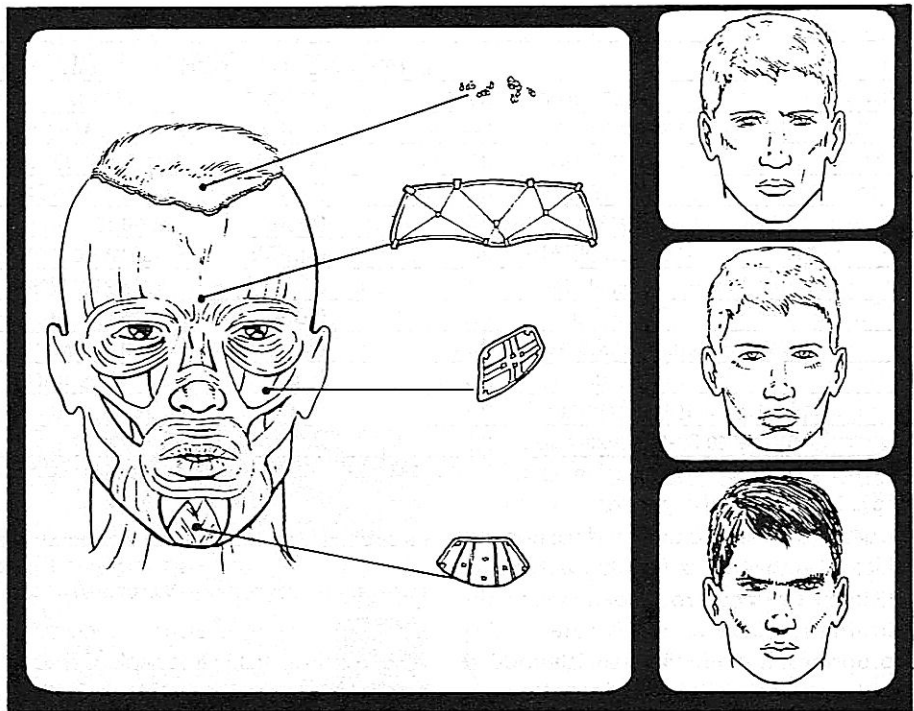

this feature allows the wearer to escape casual inspection. Full transformation takes three hours. (INT roll over 18 to detect or + 4 to disguise rolls.) 3500 EM. 1D6+1 humanity cost.

### ADVANCED CORTICAL IMPLANT SURGERY

**T**his experimental modification links a basic cory plug with new electronics and several other areas of the brain, allowing the user to augment or inhibit several basic bodily functions with the use of a series of daddies. The daddies are experimental, and available only with the surgery. Advanced Cortical Implant Surgery is almost impossible to attain and can only be had with the help of powerful contacts. Referees should be sparing in their assignment of this item to player characters. 150,000 EM. 3D6 humanity cost.

Even without the supplemental daddies, this operation confers several advantages upon the recipient. On demand, the body metabolizes alcohol and drugs at an accelerated rate. Alcohol and drugs last for one third their normal duration.

Because of wiring to the hippocampus and other associated areas, long-term memory is increased. The user gains the INT based skill Eidetic Memory +2. This allows the user to recall memories with

near photographic acuity. The difficulty of the attempt is based upon the complexity and amount of information the user is trying to recall, and how recent the memory. This skill can be increased with IP.

The character's retentive ability is enhanced. The user learns new skills in half the normal time when working under instruction. Halve the cost of INT and TECH skill advancement under the Instruction rules from Cyberpunk.

When this operation is completed the user is introduced to the series of daddies which accompany this procedure. These daddies work only with the experimental cory plug, causing painful static in an unmodified corymbic implant. They are not recommended for use with moddies.

**DADDY#1 (Utility):** This daddy allows the user to dampen or enhance selected sensory information. This allows greater concentration when working on certain tasks. The user can gain a +2 bonus with any skill roll where concentration is important. The user can concentrate on fixing his weapon in a combat situation, or concentrate on a specific conversation in a crowded bar. While doing this the user is -3 with all other Awareness and skill rolls.

**DADDY#2 (Utility):** The allows the user to ignore hunger, thirst, sleep, and excretory needs as well as suppress pain (the user need not make STUN checks), sexual arousal, and fatigue (+4 for all Endurance checks). The user may con-

sciously regulate blood pressure and body temperature. All of these functions may be maintained indefinitely, until the user dies of hunger or thirst or collapses with exhaustion or from bleeding wounds. The user can add +1 to some COOL and BOD based rolls. Incautious use of this daddy can lead to injury or death. Also, upon removal of the daddy all of the sensation that is being suppressed comes crashing down at once. The longer it is used the greater a penalty the user will ultimately have to pay.

**DADDY#3 (Utility):** The user can control when he falls asleep and can pre-determine when he will wake up.

**DADDY#4 (Utility):** The user can stimulate the adrenal glands and other parts of the endocrine and nervous systems, increasing REF by 1 for a period of 1D6+2 turns, four times a day.

**DADDY#5 (Utility):** This allows the user limited control over his emotions. The user can pick a general emotion to feel. At the discretion of the GM this may help or hinder certain skill rolls.

**DADDY#6 (Special):** "It was like...it was like being strapped to a table and having a dentist drilling up through the roof of my mouth. It was like being right on the edge of an epileptic fit and not quite making it, wishing it would either go away or seize me and get it over with. It was like having the brightest lights in the world blazing in my eyes, the loudest noises exploding in my ears, demons sandpapering my flesh, unnameable vile odors clogging my nose, the foulest muck in my throat. I would have gladly died then just to have it all stop... I would kill"

*When Gravity Fails*

There is a part of the brain which can be stimulated to create incredible pleasure. There is also one which can be stimulated to cause incredible agony. That is the area that this daddy taps into. It drives the user insane with agony, turning him into a ravening killing machine driven by the pain coursing through his body. The character is berserk, beyond all fear, gaining +5 to initiative. BODY and COOL are raised to 12, EMP drops to 0. The user has no drive other than to kill the person before them. A person under the influence of this daddy is incapable of using any weapon more complex than his own hands and teeth or a club, but he gets +3D6 to all hand-to-hand damage in

addition to any bonuses from increased strength. Martial arts are unusable but brawling skills still apply. The user will not dodge and cannot be stunned by any means other than a Neural Interrupter or Seizure Gun.

The user cannot distinguish friend from foe, and once the principle target has been killed he will attack the next nearest person. This state lasts for 2D10+10 minutes, when the user passes out. Characters under the influence of this moddy are under the control of the Referee and will not remember anything other than the first few seconds of the experience. Recovery can take anywhere from a few hours to a few weeks depending on how much damage the user suffered. No other daddies may be used with this chip.

---

## SECTIONAL CYBERNETICS

---

**S**ectional Cybernetics were designed to allow people the convenience of cybernetic extremities without having to replace a whole limb. In order to attach a sectional hand or foot to a limb you must buy a sectional mount. This not only allows structural attachment, but it also provides the interface area for nerves and tendons and contains the unit's power supply.

The Sectional Mount costs 300 EM, with a humanity cost of 3 points. Purchase hands and feet from the master list in *Cyberpunk 2020*. Remember to take the humanity cost for whatever extremities you pick. For an extra 150 EM the Sectional Mount can be a Quick-Change model. Hammer-Hands and Grapple Hands can not be attached to sectional mounts. Sectional extension hands have only half the normal extension distance.

---

## BIOMECHANICS: RETURNING TO THE FLESH

---

**C**ybertech is going through a new stage of development in the twenty-third century; the gradual shift to more biomechanical systems. Biomechanical systems represent a fusion of bioware and cybernetic technology, and are the cutting edge of biotechnology. Metal and motors are being replaced by genetically engineered biological components which offer many of the strength and endurance advantages of cyberware without the unsightly metal, maintenance problems, or humanity cost.

Biomechanics will never replace cyberware, however. Cybernetic limbs are not only the cheap alternative, but their

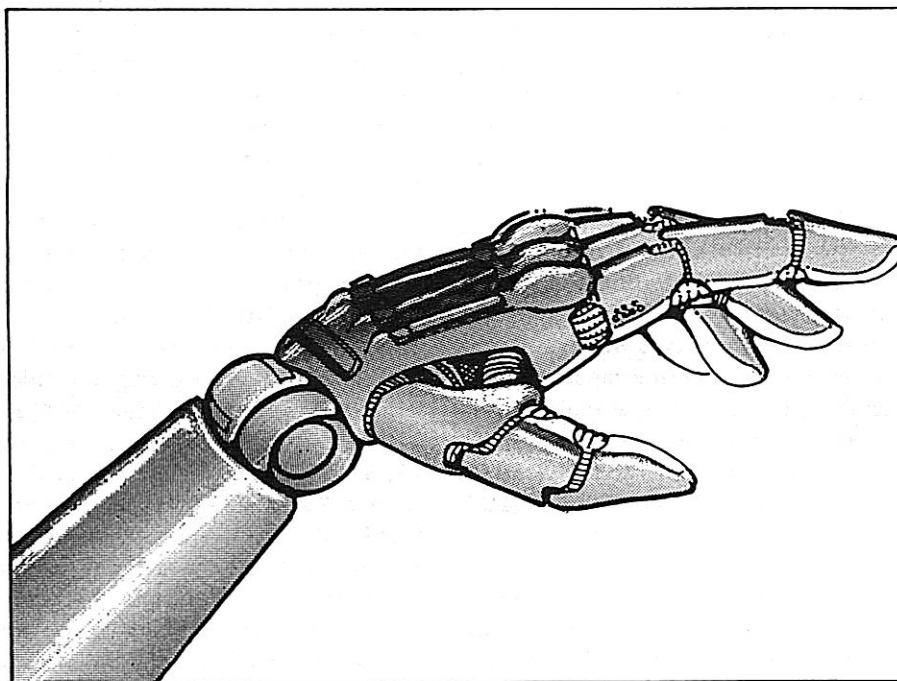



## WHEN GRAVITY FAILS

durability and modular fittings are convenient in many situations. Sectional cybernetics are still in the development stage and are not often seen in public. (And almost never seen in the Budayeen.) Available only with connections, biomechanics are very expensive, very experimental, and often illegal.

**In game use biomechanicals work as their cybernetic counterparts do but with several important differences.** To purchase a cyberware item as a biomechanical, double the cost in EM and pay the minimum possible humanity cost based on the die roll listed. A biomechanical arm with standard hand would cost 6000 EM (3000 x 2) and have a humanity cost of 2 (lowest possible 2D6 roll).

Only items designed to replace human body parts (i.e. eyes, arms, legs, etc.) can be biomechanical. Cyberware that requires metal to function (cyberweapons, body plating etc.) cannot be biomechanical. Nor can electronic systems such as cory plugs, reflex boosters, and implants. Bioware enhancements are compatible with biomechanical limbs.

Biomechanical systems are not easily distinguishable from their organic counterparts. Thermographic and infrared systems can not detect biomechanical systems. Metal detectors will detect all biomechanical systems except eyes or internal audio systems.

Biomechanical systems can only hold half the options that their cybernetic counterparts can. Eyes can hold 2 options; internal audio, which can usually hold six options can only hold 3; arms and legs can hold 1 option each and can't be armor plated.

Biomechanical limbs are affected by microwavers, static charges and EMP blasts only 20% of the time. If limbs are affected they take 2D6 in damage to their organic components as well as suffering the effects of whatever weapon was used on them. Eyes and internal audio are only affected by anti-cybernetic weapons 10% of the time. A successful attack has a 15% chance of causing severe damage (2D6) to the optic or auditory nerves or surrounding tissue.

Biomechanical limbs have striking, crushing and kicking abilities equal to that of normal cyberware and are insensitive to pain. They have twice the endurance of



flesh limbs. Paired biomechanical legs can make vertical leaps of 4 meters and running jumps of 6 meters.

Biomechanical limbs possess both normal 8 pt limb SDP and the SDP of the inorganic components; 8 extra pts for arms and 12 for legs. This gives biomechanical arms 16 SDP and legs 20 SDP. It takes 8 points of damage to destroy a natural limb. A biomechanical limb takes damage in this order: the first 3 points are considered flesh damage. Then the metal components take damage until they are destroyed. All subsequent damage affects the flesh until the remaining 5 pts have been inflicted and then the limb is considered destroyed.

Biomechanical Linear Frame Exoskeletons are more complex than cybernetic ones. All systems are internal, built on the musculature and skeletal systems, protecting and strengthening the body. The frame becomes a permanent part of the body, making the user incredibly large and muscular-looking. These frames increase BODY and BTM in varying amounts. Sigma: BODY 12, BTM -5. Beta: BODY 14, BTM -6. Omega: BODY 16, BTM -7. It is rumored that Friedlander Bey's bodyguards, the Stones That Speak, have biomechanical linear frames. Biomechanical linear frames are 3x the cost of their cybernetic counterparts and have an additional 1D6 humanity cost.

---

## CYBERPSYCHOSIS PREVENTION THERAPY

---

**P**ost-Operative Psychological Therapy is an expensive new treatment available in the twenty-third century to help prevent cyberpsychosis. It is popular with enhanced bodyguards, security personnel, and covert operatives working for wealthy employers. When properly applied this therapy significantly reduces the incidence of cyberpsychosis in heavily enhanced individuals. It is a purely preventative treatment, completely ineffective on people who have already crossed the line.

Post-operative therapy reduces the trauma to people's emotions and humanity which can occur with heavy enhancement. The procedure requires a specially trained therapist (*minimum* skills: Medtech +5, Human Perception or Expert: Psychology +5) and a peaceful environment where the patient can be both supervised and insulated from the outside world for a few weeks after his operations. The treatment involves the use of special mildly relaxing and hallucinogenic drugs along with counseling sessions. The therapy alleviates the feelings of alienation from humanity which lead to the

violent rages characteristic of cyberpsychosis. One point of humanity is restored for every two days of therapy. Minimum treatment time is one week. Therapy costs 1200 EM per week.

To determine the success of the treatment the referee must make a Human Perception or Psychology Roll for the therapist. The difficulty is 15 plus the number of humanity points being restored. The psychologist gets a one point bonus for every five points of the patient's COOL and a two point bonus for every week in therapy (except the first). A successful roll restores the targeted amount of humanity. A failed roll means no effect, and no further attempts are possible. A fumbled roll adds 1D6 humanity loss as the patient feels he is being patronized. This may lead the patient into cyberpsychosis during treatment. This treatment is available only in advanced nations and not economically feasible for any humanity loss under 10 pts.

---

## MEDICAL TREATMENT IN 2202

---

As with other technologies, advances in medical treatment have flourished and fallen with the fortunes of their parent countries. Nonetheless, many new developments have appeared since the fall. Gene therapy, reconstruction and editing, viral engineering, nanotech, sterilizer fields, tissue cloning and other technologies are available in 2202. Diseases can be cured, bodies can be customized, and life can be prolonged. But these medical marvels are not available to everyone. These services are beyond the reach of much of the world's poverty-stricken population.

Hospitals and clinics in *Gravity* offer many of the same services available in 2020. They can repair you as efficiently, but count on recovery times being up to twice as long in Third World areas due to crowding, varying conditions, and reduced availability of drugs and specialized equipment. Most hospitals can install basic cybernetics such as cory plugs, cyberoptics, and limbs, but don't have the resources to do complicated work involving bioware or biomechanics. Hospitals in advanced areas can install the

most advanced devices or enhancements, but expect to pay in advance.

Although cloned limb and organ replacements are state of the art, body banks still do brisk business. Body banks are common in areas where cloning is forbidden or too expensive for the local populace. Cards and paperwork are nominally required to sell or buy body parts, but a few extra kiam can dispense with that.

One major medical development is the Trantor-Rheinmann longevity treatments, which use nanotech and chemical baths to keep a brain and nervous system active for up to 300 years. These treatments, along with cybernetics and organ replacement, can keep a person alive for an astounding length of time.

---

## HOSPITALS AND THE CITY

---

The El-Amir hospital is one of the biggest and best in North Africa and the Middle East. It offers near cutting-edge medical technology to an area in grave need of it. The clinics in the city are far less attractive, with overworked and underpaid staffs working with minimal equipment. The clinics offer a variety of basic services in conditions which range from abysmal to clean and functional. Clinics are always crowded, and waits of three hours are typical. But they are free, or at least cheap.

“  
Many  
religions, such  
as Islam,  
abhor clones  
altogether.”

---

## PAYING FOR IT

---

First World countries have real medical insurance and Trauma Team services. These are unheard of in an area like the city. Here you either get coverage from a local broker like Papa, or you get the no-frills government policy which offers only the most basic services. These policies can cost anywhere from 1000 EM per year to 15,000 EM for lifetime coverage. Most people in depressed areas have no coverage. The average hospital stay costs about 50 EM a day for a ward bed or 500 for a private room. Private rooms are only available to people with clout, connections, or cash.

---

## CLONES AND CONTROVERSY

---

Cloned organs and limbs are common features in most First World hospitals. They are grown from one's own cells in order to eliminate rejection syndromes. People who can afford cloned replacements usually donate tissue and grow the parts in advance so that they will be ready immediately in the event of a medical emergency.

Full human clones are possible, but they have a past mired in scandal and controversy. In the few areas of the world where full clones are permitted, they are considered artificial constructs without legal or property rights. This decision stems from incidents in the past where clones committed murder or rebellion, and it allows brutal exploitation. Many religions, such as Islam, abhor clones altogether. Rumors have it that there is a clone underground seeking to release their brothers and sisters from bondage. To most people, however, full human clones are an abstraction, a concept which people acknowledge deep within themselves but are unwilling to bring to the surface for some reason.

---

## SUSPENDED ANIMATION AND MEDICAL FREEZING

---

One of the recent advances in medical technology has been a refinement of organic freezing technique. People and animals can now be reliably “frozen” and revived for medical and

## WHEN GRAVITY FAILS

transport reasons. In some instances people frozen as long ago as the early twentieth century have been revived. Unfortunately, not all of their dreams have come true. Many suffered irreversible brain and flesh damage from the formation of microscopic ice crystals in their tissues. Others suffered from diseases still incurable. The most pathetic were those who had been frozen in the hope of waking to a modern utopia. They found instead a world of confusion and violence. Many pleaded to be immersed again in the cold darkness, but you can't go home again.

---

---

## DRUGS IN GRAVITY

---

---

 hether made in back-alley pharmacies or huge corporate refineries, drugs are available in almost any quantity in the world of *Gravity*. Laws prohibiting their use are lax to the point of nonexistence. The most commonly taken drugs in the Budayeen are various amphetamines and barbiturates and combinations thereof. Hallucinogens are less common, and combat drugs are rarely seen outside of soldiers' first aid kits. Drugs are primarily in the form of pills and capsules. Less common, but available, are patches, or derms. These administer their contents through the skin. Patches are surprisingly quick, delivering their full dose in as little as three minutes. In *Gravity*, drugs are meant to be taken like your morning java. They give you what you need to function for the rest of the day.

Of course, there is a price. The chief symptoms of withdrawal and drug side effects are nausea and incapacitating pain. Severe cases can be accompanied by hallucinations and convulsions. Many are willing to risk the withdrawal symptoms and side effects for the temporary feelings of well-being and invulnerability.

Muslim edicts prohibit the consumption of alcohol and drugs. This doesn't stop much of the populace from regularly partaking. Drugs, including alcohol, are still the number one recreational habit in the Budayeen, more common than moddy addiction. Alcohol is the most popular intoxicant, being less addictive and cheaper than many other drugs, and relatively free of side effects. The Budayeen has a multitude of crowded bars and cafes where a wide assortment of drinks may be bought.

The following is a list of drugs featured in *When Gravity Falls*.

### Tri-Phets

**Type:** Stimulant  
**Strength:** +1  
**Difficulty:** 40  
**Duration:** 1D6+1 hours  
**Cost:** 1000

Blue, triangular tablets of Triphetamine. This drug increases COOL by 1 as well as filling the user with incredible energy, giving him a bonus on all Endurance checks. Physiologically addictive, this drug can cause severe nausea and vomiting. It carries with it the side effect of Negative Physical Reaction (see below).

### RPM

**Type:** Hallucinogen  
**Strength:** +3  
**Difficulty:** 4  
**Duration:** 1D6+1 minutes  
**Cost:** 100

RPM stands for *l. ribopropylmethionine*. This drug usually comes in a small, square, plastic derm. It can be applied anywhere on the skin. Few people willingly take this drug; it creates horrifying hallucinations which get steadily worse for duration. Not only that, but with every use the drug gradually burns out the user's central nervous system. For every use roll a D10. On a 1 the user loses 1 point of REF permanently. No one in the city knows how Bill the Cabbie is still alive.

### Neocorticine

**Type:** Hallucinogen  
**Strength:** +2  
**Difficulty:** 4  
**Duration:** 1D6+1 minutes  
**Cost:** 100

This very nasty and powerful hallucinogen was developed as a tool for interrogation. Through some sick, cosmic twist it has ended up as a street drug. Acetylated neocorticine causes the user to have terrifying hallucinations which follow a basic theme which seems to repeat endlessly. Comes in the form of a deep red microdot. This drug causes Negative Physical Reaction.

### Beauties

**Type:** Euphoric  
**Strength:** +3  
**Difficulty:** 8  
**Duration:** 1D6+1 minutes  
**Cost:** 200

Beauties are butaqualide HC1. Butaqualide comes in a bicolored capsule of powder

blue and peacock blue. Illegal without a prescription, beauties are a potent sleeping drug which acts as both a sopophoric and a euphoriant. They also scramble the user's coordination. The user stumbles around bouncing into walls and people. This loss of coordination reflects a REF loss of 3 pts for the duration of the drug. If the user hurts himself while on the drug he will not feel it until the effects wear off. Beauties are physiologically addicting.

### Sunnies

**Type:** Pain killer  
**Strength:** +2  
**Difficulty:** 33  
**Duration:** 1D6+1 hours  
**Cost:** 825

Sonnienne is a powerful opiate from Neues Deutschland, developed to negate pain and act as a euphoriant. The chalky white tablets, nicknamed sunnies, were however, physiologically addictive. They also gave the user delusions of invulnerability. These delusions can put the user at risk, especially in combat situations. This drug raises the user's COOL by 2 for the duration as a side effect.

### Paxium

**Type:** Soporific  
**Strength:** +1  
**Difficulty:** 2  
**Duration:** 1D6+1 turns  
**Cost:** 50

Paxiums are yellow, hexagonal tablets with very mild tranquilizing effects. Also called Nofeq's, these tablets also cause severe nausea. They have the Negative Physical Reaction.

---

---

## NEW SIDE EFFECT

---

---

**Negative Physical Reaction (-8pts):** Drugs with this side effect cause severe nausea, vomiting and joint stiffness. When a character takes a drug with this side effect he or she must roll a D10. On a 1-7 there are no side effects. On an 8-10 the side effects develop and the character must make a SAVE roll at -4. On a failed roll the effects are full blown and last for the duration of the drug, incapacitating the character. On a successful roll the effects are somewhat reduced and last for the minimum duration possible for that drug. The stricken character will still not feel like doing much for a while. ■





Things aren't as simple for netrunners in 2202 as they were in 2020. The Net that once covered the globe has a lot of holes in it. To use a cyberdeck you must have a cory-plug. The computers are just as sophisticated, but the technology is different. Manual systems are the norm, with true netrunners limited to the few areas where the Net is cohesive enough to allow direct interface.

Hackers in *Gravity* are looking for the same things as those in *Cyberpunk*: money and information. With no international currency, and exchange rates changing drastically every hour, the Net serves as a banking service only on a local level. It is impossible to transfer funds within the Net except on a local level. A better bet is the Comsat Triad communications web which contains the World Stock Exchange. This orbital network acts as a securities, commodities and bartering network, and is the last means by which money is commonly electronically transferred. A sharp operator can purloin interests from across the globe and sell them for a quick profit before anyone can trace the signal.

During the heyday of the Net hundreds of AIs were built. In some areas they run entire sections of the Net. In others they

have retreated into unused corners, monitoring, but hoping to remain unmolested. Like virtual dragons in their lairs, they guard their stockpiles of information and RAM. Only the brave or stupid seek them out.

---



---

### THE NETS

---



---

The current Nets cover very specific areas.

---



---

### AMCOM

---



---

This Net encompasses most of North America and stretches down to Brazil. It was established when the U.S. was still a single nation, and has changed a bit since then. Now it is a collection of sub-nets, each covering a few small nations or city-states. The flexibility of the old set up was too attractive to discard entirely. Only Sovereign Deseret has managed to isolate itself entirely. Its city grid is well isolated and protected from outside communications and intrusion. Many other nations pay big bucks to Netrunners trying to crack the S.D. grid. The search for uncut lines goes on.

Other problems come from the decrepit state of the phone system. World Telecom still runs phone lines across North America, but they are cranky and hard to maintain. Links are constantly breaking down, cutting off various areas. Some areas never bother to reconnect. Parts of the Midwest have been out of contact for 40 years. An AI calling itself Matthias has staked out the Commonwealth of the Western Reserve grid, and no-one passes through unnoticed. AmCom has key city grids at Los Angeles, Seattle, Dallas, Rio De Janeiro, São Paulo, Denver, Chicago-Detroit Plex, Atlantic Plex, Vancouver, Toronto, and Quebec City. Keep in mind that each nation-state or group of states will have its own sub-net with its own bulletin boards and services.

---



---

### EURONET

---



---

Covering Europe and what used to be western Russia, this region has the widest variety of systems and services. It is linked to AmCom by several lines. Unfortunately, the Euros have no central phone system and there are even more holes here than in North America.

## WHEN GRAVITY FAILS

Parts of the Baltic, Armenia and Spain have been off-line for sixty years. EuroNet is a curious mix of old and new, with manual systems as common as neural ones. To foil netrunners, many paranoid governments keep all of their systems on manual equipment that won't interface with cyberdecks. Key Net cities are London, Rome, Paris, Lyon, Berlin, Munich, Geneva, Helsinki, Warsaw, Prague, Valgograd (St. Petersburg), Kharkov, and Moscow.

---

---

### THE WILLOW NET

---

---

his Net handles Japan, Australia, and much of Indonesia. It is the most sophisticated Net in the world, with well-maintained internal links and lines to most other nets. There is a lot of traffic, as many Indonesian countries have worked hard to industrialize and expand their Net capabilities. This is the closest thing in *Gravity* to a typical 2020 net. Be warned however, the Japanese have strict security, and will use whatever means necessary to maintain it. Black ICE is common here.

---

---

### HAIYAK AD-DAU (WEAVE OF LIGHT)

---

---

his is the newest of the Nets, established in 2150 along with the Arab Federate. It covers the Arabian Peninsula and parts of Egypt. It is a bit sparse, having only a few key Net cities: Amman, Beirut, Cairo, Damascus, Medina, and Mecca. The data fortress for the Caliph is an image of the Kaaba. Bulletin boards and services are minimal, and the *imams* have decreed that no icons will be direct representations of people or animals. Only abstract *Tronnic* style images are permitted. Visiting netrunners would do well to remember this. The Net will adhere to the Sharia as much as anything else, or it will be declared Satan's abode.

The systems here are not as sophisticated as those in older areas, but they employ black programs with alarming frequency. You may encounter them anywhere: in systems linked to Friedlander Bey or while trying to crack the accounts of the local grocer. Cheap copies of programs like *Liche* and *Bloodhound* have made it to the market here and found an enthusiastic audience.

---

---

### COMSAT TRIAD

---

---

his not a true Net, but a communications nexus that links the three orbital colonies. It is the only network linked to all of the Nets, and it serves as a neutral ground for those intercontinental trade and securities transactions that still go on. Here you'll find the rich and daring trying to make sense of the constantly shifting economies of the world. The nexus can appear as a stock-exchange floor, a Budayeen marketplace, or anything else that you have the interface software to generate. It is a good place to rub shoulders with the wealthy and powerful of 2202. Raiding the Triad is almost impossible, its security is tighter than that of the Japanese and the whole operation is watchdogged by a super-efficient AI named Grendel.

---

---

## WHAT THIS MEANS TO NETRUNNERS

---

---

### YOU CAN'T GET THERE FROM HERE

---

---

etrunners can't zip anywhere in the world like they used to. The com net essential to neural interfacing only covers North America, Europe, the Arabian Peninsula and the Willow Net. Even these areas have to be accessed via special satellite links. Billing isn't a problem with long distance links, but getting them to work is. Every time you uplink to satellites and after every hour of communication, there is a 25% chance that the connection will fail. If this happens you will have to wait 4D6 hours before the link becomes active again. EuroNet to AmCom transmissions only fail 15% of the time due to the many links between the two areas.

---

---

### MANUAL NETRUNNING: BACK TO BASICS

---

---

lot of people use unsophisticated systems that can't interface with modern cyberdecks (mostly because of system speeds). You must use or emulate a manual system in order to interface

with them. In game terms this means that cyberdeck netrunning is only efficient in the most modern areas of major Nets. Even in these areas there will be systems that can't communicate with cyberdecks. These areas must be accessed manually. Although netrunners can usually see these areas in advance, or predict when they will be encountered, it is still an inconvenience; much like going from lightspeed to a walk. Manual interfacing requires netrunners to work from a keyboard, the nearest thing to purgatory for them.

When interfacing manually, netrunners can use their **Interface** skill as a **Manual Computer Use**, with only the -4 keyboard modifier to actions. They will always have the initiative against non-netrunners. Conflict and searches are handled much in the same way as with cyberdecks. The netrunner is just one step removed from it all, using verbal and keyboard commands to control programs instead of with his synapses. A netrunner can use his cyberdeck to hunt up a distant system in the Net, then, once linked, he can revert to manual if necessary.

Manual netrunning has its advantages. Although black ICE can still kill your system, it can't kill you. Netrunners are not immobilized when they interface with manual systems. Also, all portable computers have cellular links. These features allow the Netrunner mobility while working. The chance of losing a link due to cellular failure is 5% per hour. Manual running isn't as visually stimulating as cyberdeck interfacing. Some hackers maintain neural links when accessing manual systems and use the Magic Keyboard Program to emulate manual systems (see netrunner).

### Magic Keyboard Program

**Class:** Controller

**Strength:** Not Applicable

**MU:** 1

This program allows the user to emulate a manual keyboard system while in the Net in order to access systems incompatible with cyberdecks. The icon appears as a neon keyboard and a disembodied screen floating in front of the Netrunner in the virtual space of the Net. The Netrunner takes only a -3 modifier instead of the normal -4 for keyboards. The catch: the Netrunner is still susceptible to lethal black ICE. The Netrunner must also disconnect from the keyboard in order to move, causing a -2 REF penalty for one phase. Good for people who can't bear to leave the Net.



# SAMPLE CYBERDECKS

## Magna Vision Comp

Speed: +1

Memory: 40

Data Walls: +6

**Standard Features:** roll-out keyboard, vocal command, stylus response pad, 20 x 30 cm semi-flex flatscreen, infochip reader, fully portable. Manual use only.

**Options:** holo display, up to 2 additional keyboard links, satellite uplink antenna (4kg). 4500 EM

## Grunwelt Compmachine 204

Speed: +3

Memory: 25

Data Walls: +6

**Standard features:** roll-out keyboard, vocal command, flex-screen display, infochip reader, fully portable, plug cords, 40 hour battery.

**Options:** holo Display, stylus response pad, satellite uplink antenna (4 Kg.) 5000 EM

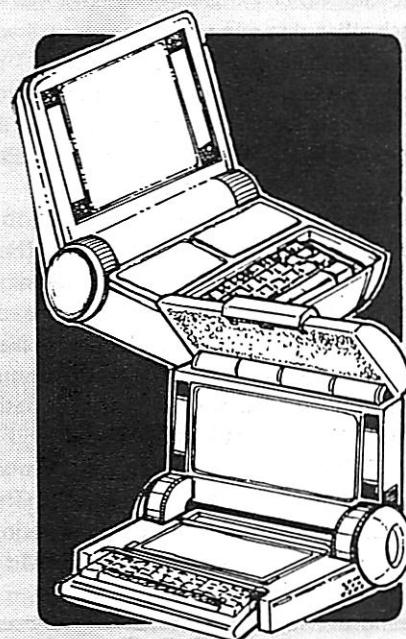

For game purposes, use *2020* programs in *Gravity* games. Names and icons may be different. *Gravity* cyberdecks will always have keyboard and vocal control features, screens, and cellular links. Data Fortresses operate exactly as in *2020*, they just may not be virtual in nature. A more detailed manual hacking system is available in the *Hardwired* supplement.

---

## WHEN GRAVITY FAILS: GEAR TO GO

---

The following is a basic list of everyday gear available in the *Gravity* world. Many of the items from the original *Cyberpunk* list are also available.

---

### MEDICAL

---

#### Basic Medical Kit

This affordable kit comes in a sturdy plastic case a few inches on a side. The contents are designed to keep for extended periods, even when exposed to the desert heat. This whole packet weighs about .85 kilos and costs 120 EM. It can be purchased from any hospital or specialty store, or through mail order. Contents include: **50 Gelstrips**-gelatin bandages made of nutrient chemi-

cal and polysaccharides which stick to the wound when applied. They stop bleeding but are air-permeable. After two days they dry up and flake off. **50 Endorphin Patches**- plastic drug patches which kill pain when applied to the skin. They last for 1D6/2+4 hours and have no side effects other than sedating the patient for the duration. **5 capsules of Sonneine** (see glossary or Drugs). **5 antibiotic capsules. 18 applications of Coagulant Creme**- for stopping major bleeding. **1 cannister of Gelcast**- enough to cover a leg or two arms. Gelcast hardens in three minutes, forming a temporary cast which lasts about six hours. Not strong enough to withstand blows, but it will immobilize a limb. **1 cannister of antibiotic spray**-about 100 applications.

#### Portable Life Support Kit

For the Medtech on the go, everything you need to carry out intensive medical procedures in a remote area. Good for treatment when time is of the essence and more sophisticated facilities are not available. This kit carries all of the supplies needed to treat major wounds, even fairly involved field surgery. The trauma kit can only be purchased from a hospital or medical supply house, and only by a licensed Medtech. 10,000 EM.

The large backpack-size kit contains: respirator, pulmonary stimulator rods, biomonitors, surgical tools (laser scalpel,

retractors, etc.), 50 large gelstrips, 1 cannister of gelcast (enough for two legs or four arms), 20 doses of Sonneine, 50 Endorphin patches, 1 pair of magnifying goggles, 1 cannister of oxygen, 10 anesthetic patches (enough to render someone unconscious for 1D6/2+4 hours each), 10 stimpatches (can revive unconscious people), 2 portable flood lights which run off of internal batteries, 1 cannister of antibiotic spray, 40 ampules of pro-coagulant creme, 1 chill-sheath (for lowering and raising body temperature), 1 dermal stapler, 1 cannister of sterilizing spray (about 50 sprays per cannister), First Aid +4 daddy (active) for the assistant (if any), 20 capsules of wide-spectrum poison antidote, 20 capsules of wide-spectrum antibiotic /anti-viral, 20 capsules of Speedheal. The backpack folds out into a stretcher or cot.

---

### FASHION

---

**DisposaClothes:** Clothes made of a high tech plastic fiber. These flimsy clothes won't last a day, but they're great for a disposable society. Come in virtually any style and can also be customized by the consumer to fit his needs. Looks like the real thing. 75-350 EM.

**Slicksuit:** A bodysuit made of an almost frictionless plastic fiber with traction points on the hands and feet. These suits are considered totally chrome in chic clubs where a dance craze called "eeling" is all



## WHEN GRAVITY FAILS

the rage. Participants throw themselves at each other, skimming off in a random direction, then sliding onto another victim. The overall effect is considered quite erotic. Pickpockets and muggers have taken to these suits as it makes them hard (difficulty 20) to grab during a get-away. 300 EM.

**Gallebeya:** Common Arabic robe worn by most men in the Middle East. They come in many colors, but white and beige are typical. Comes with an arabic head-dress, or keffiyah, which is held on by an akal. Expensive ones are made out of luxurious fabrics or embroidered. 5-20 EM for basic outfit. Up to 6x that for something fancy.

**Hijab:** The *modest dress* worn by most traditional women in Muslim society. The Hijab extends from head to toe, covering every part of the woman's body. 15 EM

---

---

## PERSONAL ITEMS AND ELECTRONICS

---

---

**Moddy Rack:** A plastic or metal case available in several colors. Can hold up to ten daddies and three moddies. About the size of a cassette case. 5 EM.

**Pill Case:** A slim case which can hold up to fifty tablets or capsules, with a slit in the top to hold derms. 10 EM.

**Holo System:** A more advanced version of the one offered in *Cyberpunk*, it creates images with more clarity and detail. Images are lifelike, and the projection radius is eight feet. The projector is a small unit about 5x10x10cm. Can be connected to the city cable system or play tapes. Works best in a dark or dim environment. 300 EM.

**Holocam:** Small video cameras designed to record images and either play them back over a holo system or project them directly from the camera (with lower quality reproduction). They record onto holotapes. Still cameras can be purchased too. 150-700 EM.

**Holotapes/Plates:** Holotapes are slim, credit card sized wafers which slide into a hologram camera. They can record for up to two hours. Holoplates are stills on 3x3 inch plastic slides from which a hologram can be projected. A holoplate cartridge can hold fifty exposures. Commercial holotapes can be rented. 2-4 EM blank, 5-50 EM prerecorded.

**Telephone:** Small, fold-out, clip-on units. They have no numeric keypad. The user whispers or speaks the number or comm code of the person they want to reach into the phone. The phone does the rest. 250 EM.

**I Ching:** The I Ching is a glossy black unit about the size of a cigarette pack, with a keypad and small screen where words and pictures appear. Images are accompanied by reedy, tinkling music and a tiny female voice. Pressing one button throws a hexagram and produces a philosophical passage. Pressing a second interprets the hexagram. Available in several languages. 100 EM.

**Electronic Books:** Works of fiction, biographies, history, religion, technical manuals. The Encyclopedia Britannica is a popular favorite, carrying all 42 volumes, including an index, in a tiny, electronic unit. Typically about the size of a calculator or cigarette packet. 50-400 EM.

**The Electronic Qurān:** A common electronic book in Muslim areas. Beige or blue plastic with a keypad and screen. Accompanied by Arabian music. All recitations and screens are in Arabic. The voice sounds like a resonant boom trying to force its way out of a 2cm diaphragm speaker. 300 EM.

**Pocket Infochip Player:** Similar to regular electronic books, but this system uses an interchangeable chip system. 10x5x3cm, with the usual keypad and screen. An androgynous voice speaks the information on command. These can load up to four infochips and select which one to play. They can also record to infochip or internal memory through link cables. Many films and books are available on infochip. 350 EM.

**Infochip:** Crystalline slivers, infochips can hold video, audio, or numerical information. Huge storage in a tiny unit makes these a popular item. Common infochips hold videogames, movies or books. 10 EM.

**Telephone Privacy Link:** A credit card sized receiving/broadcast unit accompanied by a small earphone and a cap which fits over a tooth. The Privacy Link routs all sound to the tiny earphone. The user can subvocalize through the tooth cap. The earphone and toothcap are wireless, and not connected to the receiver. These units are separate from the actual phone, using radio to maintain communication. If the telephone is within ten miles the call will be routed to the telephone link. The user cannot make calls with this unit. 500 EM.

**Flight Suit:** A full body suit designed to enable the wearer to survive the high-G maneuvering of modern air combat. The fabric has built-in myomar fibers that constrict as needed to keep the blood flowing and prevent blackout. The suit includes a sealed helmet with com gear and link capabilities and maintains a closed atmosphere for the pilot. Popular with Runners who use high performance aircraft. 3500 EM.

**Link Cables:** Equivalent to *Cyberpunk* interface cables in function, these may also be used to link data systems to each other. 10-40 EM.

**Bloodhound:** This chemical sensor is popular with the police and military. A briefcase-sized unit contains an air-sampler and computerized chemical analyzer. It is used to identify trace chemicals and pheromones. It can be programmed to identify and respond to certain chemicals including individual pheromones and breath traces. This enables the unit to follow chemical trails left by people. It can be overwhelmed by other scents, and wind or rain can ruin a trail. You will see a great many cops at crime scenes running their bloodhounds over every surface. Adds +4 to Tracking and Chemistry Rolls for identification purposes. A common item. 750 EM.

---

---

## TRANSPEX

---

---

 Transpex is a relatively new development in the area of virtual reality interface technology. Similar to Braindance, it is more advanced. Transpex allows real-time control of a virtual universe in a game format.

To play Transpex, two people sit at a table, usually in a bar devoted to Transpex machines. Each player plugs a cable from the unit into their corymbic implant. A starting player is established and the players link up to the machine's CPU. The starting player imagines a scenario into which the opposing player is inserted. The opposing player experiences the whole scenario in perfect Braindance simulation. Most often the scenario is designed to "kill" the other player, so the player must survive as long as possible. Players are scored on how long they survive their opponent's scenario before being killed or jacking out. Then the whole situation reverses and the second player envisions a scenario which the first player must now try to survive.

---



---

## PERSONAL WEAPONS

---



---



---



---

### NEEDLE GUNS

---



---

High rates of fire and armor piercing, flesh stripping, high speed projectiles make needle guns a nasty street weapon. Needle gun ammunition types and rates of fire vary among manufacturers. The following are common examples. Projectile dimensions range from 1.5 x 10mm to 3 x 20mm. Projectiles can be explosive, armor piercing or poisonous. Needle guns are usually made of graphite and plastic composites, but several companies produce larger, metallic needle guns for heavy-duty police and military use. Needle guns use either magnetic or compressed air firing systems. Magazines range from 10 to 100 rounds. Needles are made from metal, crystallized chemicals or hard, heavy polymers. Guns cost 150-500 EM. 75m range.

---



---

### NEEDLE GUN LOADS

---



---

**Normal:** Armor piercing. Various damage ratings from 1D6+1 to 2D6-1. See the weapons table in this section for load sizes, costs and damage. Common.

**Anti-Armor:** Double the needle's natural armor piercing qualities. Armor's SP is 1/4 against this attack. 4x cost. Uncommon.

**Poison:** Rounds which carry a drug or poison on the surface or in an internal reservoir. Advanced versions have needles made of water soluble crystals of the toxin or drug. These dissolve on contact with blood. 2x cost plus toxin cost per dose. Uncommon.

**Exploding:** Made of solid explosive or metal with an explosive core. These can be rigged for explosion on impact or on contact with moisture. Impact rounds explode on contact with armor or flesh for 4D6 damage. Moisture rounds are armed by firing and explode on contact with water. They do normal load damage to armor, exploding only if they penetrate and enter flesh. Once fired, moisture rounds can be triggered by any water source, including sweat, rain, etc. Don't touch undetonated rounds imbedded in armor or surfaces and don't fire these rounds in a rain storm. 5x cost. Uncommon.

The whole thing is a full sensory experience with sound, sight, touch, smell, taste, and pain. It can be horrifying, wondrous, erotic or exhilarating depending on who is constructing the scenario. No real damage is taken by either player, but a virtual death can be a frightening experience.

Refs can have opposing Transpex players describe their respective scenarios and reactions to each other. The final winner can be determined by a roll. The Ref determines a Difficulty rating based on each scenario described and, the opposing player rolls an average of INT and COOL to beat it. If both players beat their roles, the one who beat the higher Difficulty is the victor. Ties are possible, and there is a good deal of subjectivity involved, but its all for fun. Right?

Other nations are just beginning to explore the commercial possibilities of arms exporting. Sales have been good.

Nations have abandoned obsolete nuclear weapons for more selective and controllable instruments of terror such as mass drivers, orbital lasers and particle beams. Not much of an alternative. Old style projectile weapons, large and small, have been replaced by Gauss weapons, energy projectors, and self-guided smart rounds. Old fashioned slug throwers are manufactured only by the oldest weapons makers and can only be found in antique and collector shops.

Gun laws around the world are as varied as the nations of their origin. Some places enforce a death penalty for even *car-*

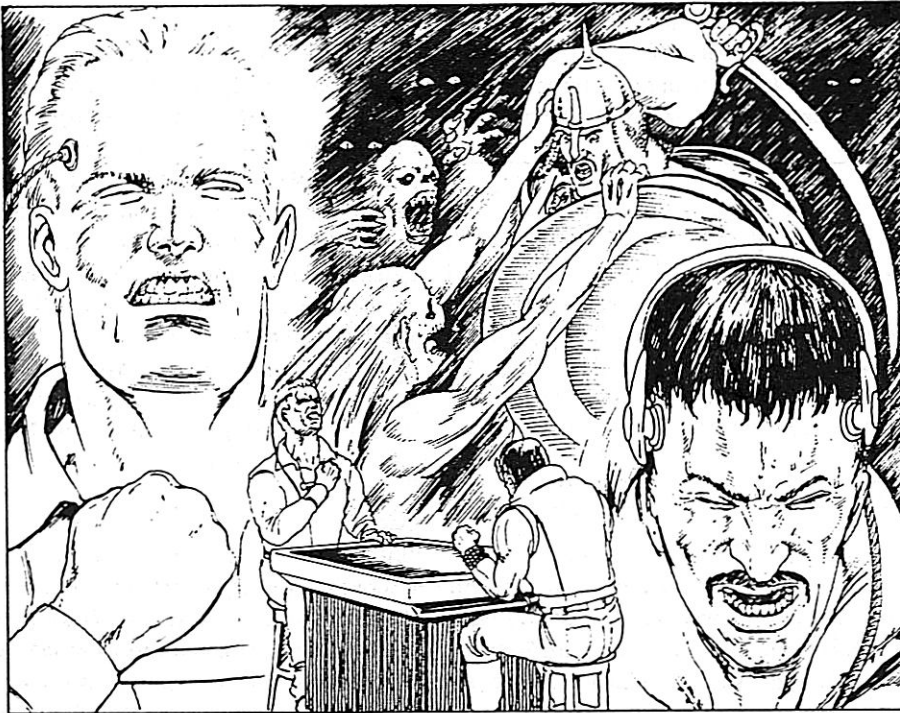

Transpex costs 2 EM per game. More advanced versions of the Transpex game use a 'trode crown, allowing people without cory plugs to play. Units look like coffee-table style video games.

---



---

## WEAPONRY IN 2202

---



---

**T**ensions around the world have kept weapons and combat vehicles at the forefront of technological development. Brazil has developed into one of the world's leading arms suppli-

ying melee weapons. Others require their citizens to arm themselves with guns. To keep death rates down, many non-lethal weapons has been developed for the consumer market. Non-lethal weaponry is common among civilians.

Police in the Budayeen enforce few weapons laws as long as people stick to the small scale stuff. Weapons that cause heavy damage or have high rates of fire, such as explosives or assault weapons, can get you arrested in a hurry. Personal weapons are available from several fixers in the Budayeen and the rest of the city. Common non-lethals can be bought in any specialty store.

## WHEN GRAVITY FAILS

These ammo types may be combined in one round for interesting and deadly combinations. Add the cost multiples together for combined rounds. Combined rounds are extremely rare.

### Slug Throwers

Obsolete and hard to find. Use weapons from *Cyberpunk* as examples. Since they are rare and distinctive, they may be easy to trace.

### Seizure Guns

Seizure guns are sophisticated personal weapons which were developed for non-lethal defense. Seizure guns fire a powerful radio pulse at a frequency which disrupts the human nervous system, specifically the motor control areas of the brain. The target is paralyzed by seizures or unconsciousness. These weapons also cause painful muscle spasms and headaches lasting several hours after the primary effects wear off.

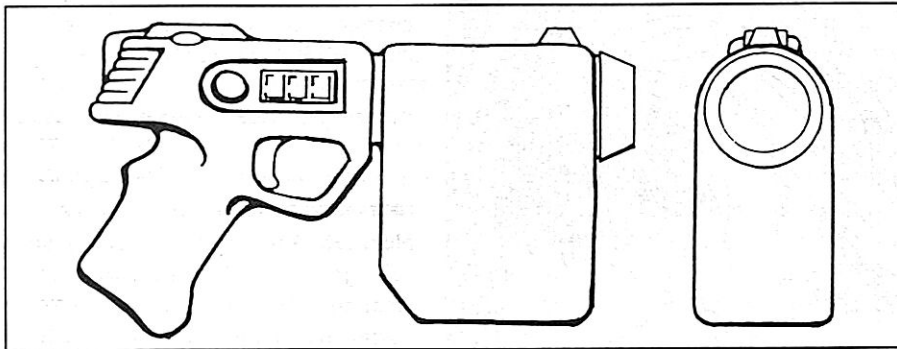

Someone hit by a seizure gun must make a Stun/Shock save roll with modifiers based on the range from which they were shot. Close range: -7, Medium range: -5, Long range: -3, Extreme range: -1. Hit location is not a factor except for head hits which are an additional -2 to the save roll. A failed save roll means the person is incapacitated for 1D6+1 minutes. Point blank hits cause unconsciousness for 2D6 minutes and 3D6 neural damage with no save. Normal armor won't stop this, but BTM applies. A point blank head hit causes 6D6 damage and there is a 10% chance that there will be a permanent loss of 1-2 points of INT and REF. When a target fails their save, REF will be halved for the next hour due to painful muscle cramps and spasms. If the target makes their save roll REF is dropped 2 points for 1D6+1 minutes. Multiple hits compound effects. Seizure guns use a rechargeable battery good for

15 shots. The beam is invisible, but the weapons make a distinctive buzz-crack sound. Also called Neural Interrupters. Cost is about 800 EM. 50m range.

Large, rifle versions called Seizure Cannon are also manufactured. Seizure cannon have a greater range, and area effects similar to shotguns. Additional -1 to all Stun/Shock Save rolls. The modifications are Close -8, Medium -6, Long -4, Extreme -2. Point Blank damage is 3D6+3, or with a head hit 7D6. Easily lethal at close ranges. 1500 EM. 200m range.

### Static Pistols

Similar to old-fashioned Tasers, these fire an arc of electricity meant to stun the target. They also cause 3D6 damage. Stun/Shock saves are at -4. Static pistols can also short out machinery and cybernetics. For every point of damage a target takes there is 1% chance of his cybernetic parts shorting out. Shorted cybernetics will not

function properly until repaired. Static pistols are made of high density plastics and ceramics with plenty of rubber and gel insulation. Popular brand names are Souken-Hitachi and Weintraub & Baretta. Static pistols make a characteristic blue arc of electricity and crackling sound. They are powered by a small, rechargeable battery good for 10 shots. 475 EM. 10 EM for battery. 50m range.

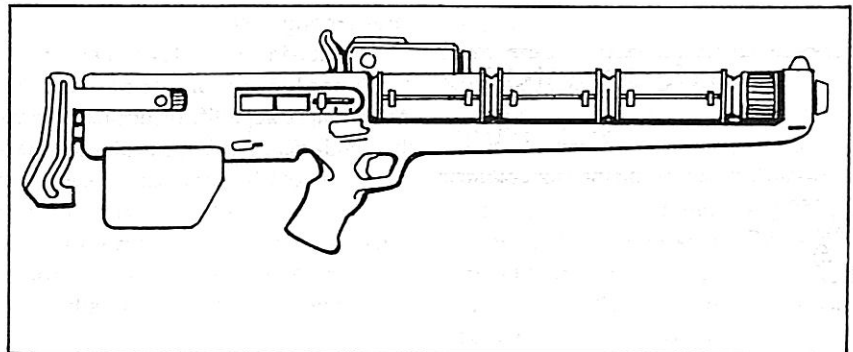

## EXOTIC AND HEAVY WEAPONS

### GAUSS WEAPONS

**G**auss weapons, also called railguns, work on the same principle as Mass Drivers. They use a magnetic field to move a projectile down a barrel or rail at high speeds. Capable of velocities much higher than those achieved by explosive slug throwers, with no muzzle flash. They do make noise: a loud hiss and crack as the projectile breaks the sound barrier.

Gauss weapons are always long-barreled to accommodate the magnetic coil needed to accelerate the projectile. Many use a bullpup configuration to shorten overall weapon length. An important weapon in many urban and jungle conflicts, popular because of their damage and low muzzle signature. Special sensors (usually mounted on vehicles) can detect the electromagnetic "flash" caused by the acceleration system. Gauss Weapons were first developed for large-scale vehicle mounting and artillery purposes, and adapted for personal use only in the last few decades. 950-1500 EM. 1000m range.

### Lasers

The latest in man-portable armament, laser rifles and large backpack units were first seen in the battles of Toulon vs. Marseilles and the revolutionary wars of Venezuela in 2105. Laser weapons draw from a high-efficiency battery to fire an intense beam or pulse of photons which can penetrate or detonate a target. Lasers create a loud "crack" as the beam or pulse superheats the air. Beams are frequently in



## PERSONAL WEAPONS TABLE

NAME	TYPE	WA	CON	AVL	DMG	SHOTS	ROF	REL	RNG	COST
LIGHT NEEDLE	P	+1	J	C	1D6+1AP	12	1/3/20	VR	75M	150 EM
MED. NEEDLE	P	+1	J	C	1D6+3AP	30	1/3/20	VR	75M	250 EM
HVY. NEEDLE	P	0	J	P	2D6-1AP	20	1/3/20	R	60M	325 EM
HVY NEEDLE	SMG	-1	J	P	2D6-1AP	100	1/3/30	ST	100M	475 EM
SEIZURE GUN	P	0	J	P	SPECIAL	15	1	R	60M	800 EM
SEIZURE CANNON	RIF	0	L	P	SPECIAL	20	1	R	200M	1500 EM
STATIC PISTOL	P	0	J	C	3D6+SPECIAL	20	1	ST	50M	475 EM
GAUSS RIFLE	RIF	+1	N	R	3D10	50	1/3/50	ST	500M	950 EM
HVY GAUSS ASSAULT RIFLE	RIF	0	N	R	4D10	120	1/3/30	R	500M	1500EM
PULSE LASER PISTOL	P	+1	J	P	4D6+4	15	1/3/10	ST	75M	900 EM
PULSE LASER RIFLE	RIF	0	N	R	6D6+4	30	1/3/10	ST	450M	5000 EM
BEAM LASER RIFLE	RIF	+2	N	R	1-5D6	40	2	R	400M	6000 EM
SMART ROUND PISTOL	P	+3	J	R	4D6	20	2	R	150M	1500 EM
SMART ROUND RIFLE	RIF	+3	L	R	4D6+3	20	2	ST	550M	2500 EM
MAN-TO-MAN MISSILES	HVY	+1	N	R	4D10+4	10	2	VR	450M	2000 EM

the visible range, and they always create a visible signature due to the superheating of the air around the beam. Laser costs and ranges vary. See the weapons list for detailed information.

#### Pulse Lasers

Pulse lasers are the common man-carried variety. Pulse lasers come in heavy rifle or pistol models with integral power sources. They fire discrete, high energy pulses of light, frequently in bursts similar to automatic weapons fire. Pulse lasers damage targets by penetrating or blowing them apart rather than burning them. Wounds are messy and large due to the combination of penetration and body water explosively flashing into steam.

#### Beam Lasers

This type of laser fires a continuous beam of light at lower energy than pulse systems do. Typically vehicle mounted although large man-portable units are not uncommon. They require an outboard power supply such as a vehicle or backpack. Continuous beam lasers use a greater amount of power, but are more versatile than pulse systems as they can be tracked and varied in intensity. Beam lasers do less damage than pulse systems, but they have greater stun and shock effects due to burn damage. All Stun/Shock save rolls from beam hits are at -2. Damage is typically from burning and penetration.

## LASER POWER AND DAMAGE

**P**ulse lasers have an internal charge with a specific number of shots at a preset damage level (see weapons list). Beam lasers have a battery with a specific number of power points. Man-portable beam lasers do 1D6 damage per point expended per turn. Vehicle beam lasers do 1D10 per point per turn. Maximum points expendable per turn is 5 for man portable and 10 for vehicular systems. Beam lasers can be jury rigged by a techie to double their maximum intensity for one shot, but this burns out the whole system 50% of the time, uses all available power and can injure the operator and bystanders.

#### Laser Obstructions

All lasers are lowered in effectiveness by rain, fog, smoke and anti-laser aerosols. Depending on conditions, lasers can be up to -2 to hit and half damage. Anti-laser aerosols (see Accessories) are even more effective.

## SMART PROJECTILES AND MISSILES

#### Smart Rounds

Smart rounds are small, self-guiding rockets fired from lightweight pistols or rifles. They act as gyrojet rounds and explode on impact. They can be programmed to track an object by shape, color, size or infrared emissions. Once locked onto a target they can follow it, to a limited extent, around corners and obstacles. Smart rounds will follow a target successfully 50% of the time. A successful roll gives a +3 to hit and negates cover and line of sight modifiers, *it does not mean that the round automatically hits*. A failed roll means that the round was distracted and struck something or someone else at random, with no possibility to hit the target. Advanced rounds track 80% of the time, but are nearly impossible to find. The rounds must be aimed at a partially exposed target. If they are fired blindly they will fail to initialize to target and will fly in straight paths like normal projectiles. See table for price, range and damage info. Rare.

#### Man-To-Man Rockets

Area effect weapons that explode on impact, man-to-man rockets act like large smart

## WHEN GRAVITY FAILS

rounds. They will successfully follow a designated target around obstacles only 30% of the time, advanced versions 50% of the time. They are carried in special launchers about the size of a light machine gun. See table for ranges and damage. Rare.

### Smart Missiles

Smart missiles contain rudimentary AI technology which allows them to isolate and choose targets based upon their threat level. When confronted with a variety of possible targets, a smart missile will isolate and attack the most dangerous one 45% of the time. Smart Missiles may also target specific parts of a target with 50% accuracy when desired. Smart missiles can be programmed to search out targets based on color, size, chemical signature, sound signature, and configuration. Once a target has been identified and initialized for attack, the missile will track it through streets and around corners.

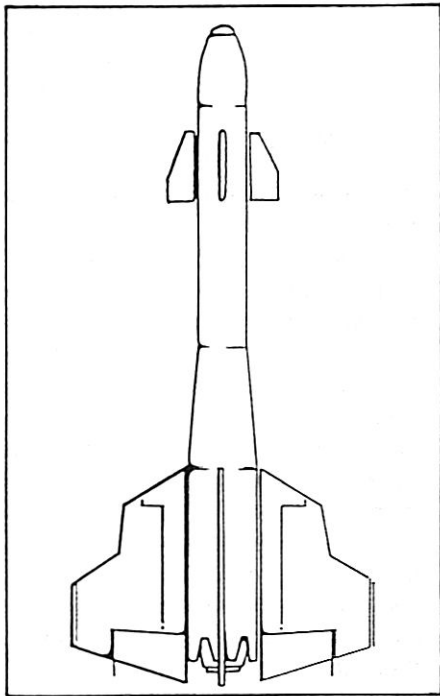

Smart missiles can follow a target in the open with an 80% accuracy, or through streets or natural cover with a 50% accuracy. Since they guide themselves they have a simple 90% chance to hit *if they track successfully*. (That means two rolls.) They come in many sizes, from small, man-portable to large, vehicular models. They can be confused by flares or ECM. See the weapons list for price, damage and range ratings.

Missiles are usually vehicle-mounted and designed to take out other vehicles or

hardened targets. A good selection of modern anti-vehicular missiles can be found in *Solo Of Fortune*, along with some good defensive measures for avoiding or baffling them. Common only in military applications and scenarios.

---

---

### TABLE NOTES

---

---

- All needle gun entries are marked AP to indicate that they are armor piercing vs. most armor types.
- Medium and Heavy Gauss Cannon can also fire HEAP rounds with explosive, area effect damages of 8D10 and 10D10 respectively.
- Weapons on the vehicle table are too heavy to be man-portable.
- \* The listing for lasers under the "Shots" category indicates the number of battery charges for the unit. For pulse lasers each battery point does the full damage listed. For beam lasers each battery point is equal to one damage die. The number of dice that may be expended in one firing is listed under "Damage."
- Missiles are fired from launchers which can carry 10 small, 6 medium or 4 large missiles respectively. Launchers cost 10% of the single missile cost.

---

---

## WEAPONS ACCESSORIES

---

---

### Cordless Smartchipping

Similar to the smartgun cybernetic systems in *Cyberpunk*. This system uses a small, wireless transceiver to link the weapon to the user's cory-plug and cyberoptics, allowing the +2 smartgun advantage, but without a cord linking the weapon to the user. The cordless system costs 150% of the weapon price. The older, cord system, as listed in *Cyberpunk*, is still available. A common item.

### Advanced Lasing Crystals

The latest in laser modifications, this system replaces the focusing assembly and power core of beam lasers with a more energy efficient system. This increases the output and

intensity of both vehicular and man carried beam laser systems. Maximum damage is increased by 2 dice; rifles can fire up to 7 dice and vehicular models up to 12. This rare and experimental system doubles the cost of the beam laser.

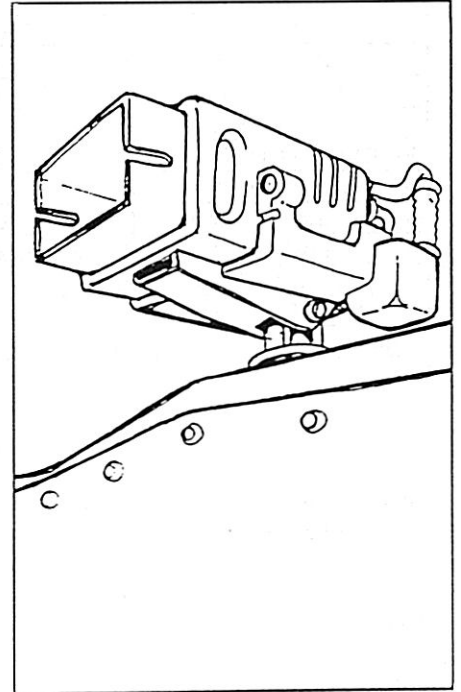

### Beam Splitters

Vehicular or static-mounted beam lasers can use a beam-splitter to create a "fan" of laser energy useful for sweeping rooms or battlefields. A laser fan can cut a person in half or cover him with burns. Beam splitters turn the beam laser into an Area Effect Weapon (*Cyberpunk 2020* p.98), creating a fan or cone pattern. Splitters decrease range. To find the range for any pattern divide the normal range by the pattern width in meters + 1. A split beam with a base 5 meters wide would divide its range by 6 (5+1). Splitting also decreases damage. For every meter of pattern width subtract 1 die of damage from each hit. Thus a 5 meter wide split beam from a vehicular laser has a sixth of the range, and for 10 points taken from the battery will do 5D10 damage (10-5). Beam splitters are an accessory, and must be installed. Availability is poor, but they can be found at arms shows and military auctions, where they are always popular items. 2000 EM.

### Advanced Laser Batteries

These are increased capacity powerpacks for laser systems. They are available in backpack and stationary models. The backpack

## VEHICULAR/HEAVY WEAPONS LIST

NAME	TYPE	WA	AVL	DMG	SHOTS	ROF	REL	RNG	COST
HVY. NEEDLE	HVY	+1	P	4D6AP	12000	1/3/30	ST	200 M	1500
LIGHT GAUSS CANNON	HVY	0	P	6D10	200	2	R	600 M	7500
MED. GAUSS CANNON	HVY	0	P	7D10	200	2	R	750 M	8000
HVY. GAUSS CANNON	HVY	0	P	9D10	200	2	R	1000 M	15000
HVY. PULSE LASER	HVY	+1	R	8D6	30*	1/3/10	ST	600 M	6000
PULSE LASER CANNON	HVY	+1	R	5D10	30*	1/3/10	ST	750 M	12000
HVY. BEAM LASER	HVY	+2	R	1-5D10	50*	2	R	650 M	7000
BEAM LASER CANNON	HVY	+2	R	1-10D10	00*	2	R	1000 M	20000
SMALL SMART MISSILE	HVY	80%	P	5D10	1	1	VR	1500 M	10000
MED. SMART MISSILE	HVY	90%	P	8D10	1	1	VR	5 KM	14000
HVY. SMART MISSILE	HVY	90%	P	10D10	1	1	VR	10 KM	18000

is for man carried systems, and can be used for both beam and pulse lasers. It weighs 7 kg. The 15 kg stationary battery is for vehicular or static mount lasers. The man-portable backpack holds 60 points which can be considered shots for a pulse laser or battery points for a beam laser. The larger battery holds 100 points. Man-portable batteries cost 1000 EM and stationary models 2500EM. Availability is poor.

#### Gauss Signature Suppressor

This is an insulated muzzle sheath made of high-density foamed metals and ceramics. It conceals the magnetic pulse characteristic of gauss weapons, preventing sensors from detecting the weapon or identifying its position. Still under development, the gauss flash suppressor reduces the chance of detection to 50%. It is currently available only for large, vehicular weapons. 1200EM. This is a very rare item.

#### Remote Weapons Station

This unit allows one man to control several remote weapons outposts. The main station consists of a 2m portable console with a protective, ablative foam armor dome (SP 10). The weapons operator can direct the fire of up to 12 different weapons positions through holo and audio monitors. The weapons are usually linked to the console via cable, although radio link is possible. The system is designed for static weapons, but it can be used to control weapons on remotely operated vehicles. The console weighs 30kg. 6000 EM for main console and 500 EM for each link. This item is uncommon.

#### Advanced Targeting Systems

Computer assisted targeting systems which increase the accuracy of vehicular

weapons. Commonly interfaced with the operator via cory plugs, heads-up displays or multi-function displays. Costs about 15,000 per point with +1 or +2 levels typical. Common on military aircraft only.

## ON THE DEFENSIVE

The advent of new weapons systems has led to the development of armor and defensive measures designed to counter them. Many armors are effective against only one type of weapon, but recently, advanced composites with broad defensive capabilities have hit the market. Be prepared to pay for them, though.

### KEVLAR

Still an old favorite. Kevlar can be interwoven with heat-dispersing fiber or ablative, laser resistant fabrics. Kevlar comes in Light (10 SP), Medium (18 SP) and Heavy (20 SP) ratings. Kevlar in 2202 is lighter and more resilient than its progenitor. New items are half the weight of 2020 items. Kevlar is common, with light, medium and heavy jackets costing 90, 120, and 200 EM respectively. Kevlar alone acts at half defence vs. all laser weapons, and is ineffective against seizure or static guns. It is commonly made to look like normal clothing. Encumbrance values as in *Cyberpunk 2020*. The armor is light, but still bulky.

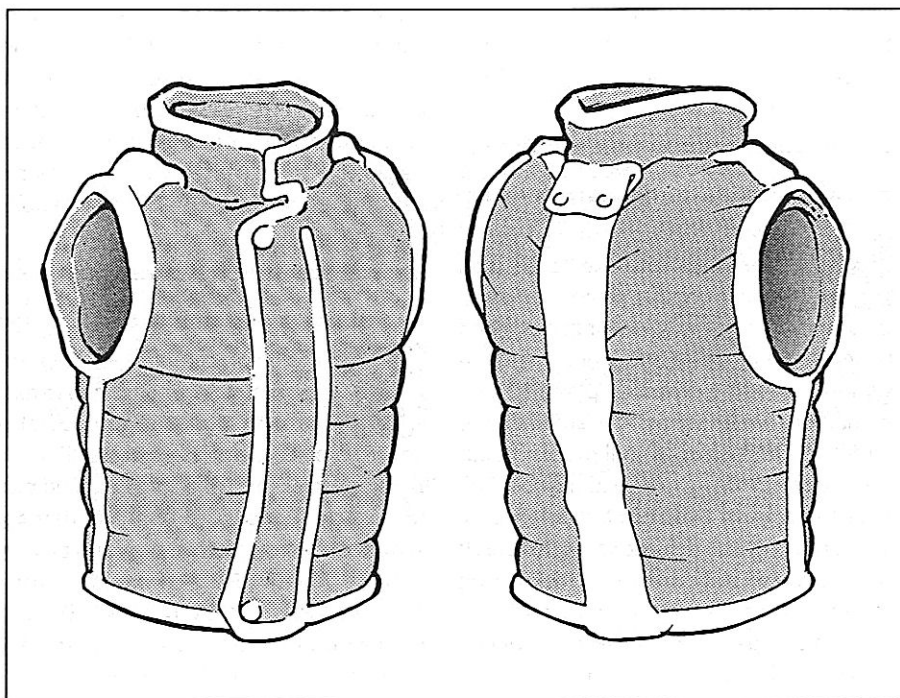



## WHEN GRAVITY FAILS

### RESISTANT FABRICS

**R**esistant fabrics are made to baffle, redirect, absorb or disperse nonkinetic energy. Resistant fabrics may be incorporated into many armor types, either woven into armor fiber or inlaid into plating. No more than two different types of resistant fabric may be placed in any armor. These do not add to armor EV. Armor items can be made solely out of resistant fabrics, in which case the cost is only what is listed below.

**Signal Retardant:** Developed to baffle and retard all electric and low-frequency radio beams, specifically those from static pistols and seizure guns. It offers 10 points of defence vs. damage from these guns and gives a bonus of +4 to any Stun/Shock saves made against them. Fairly common, this fiber costs an extra 150 EM per item.

**Heat Displacement Fabric:** This is a fabric made of thermoconducting ceramic fibers. It absorbs heat and disperses it over its entire surface area. This reduces laser damage. The fabric breaks down if it absorbs too much heat. Each item has 100 points of Energy/Laser resistance. All laser or plasma hits are absorbed by the fabric until it has taken all 100 points. At that point the armor becomes ineffective. Heat Displacement Fabric is very rare and very expensive. 1200 EM per item.

**Laser Ablative Fabric:** An earlier version of Heat Displacement Fabric. Laser Ablative armor absorbs laser energy, vaporizing in the process. Ablative fabric confers 50 points of resistance to laser and plasma attacks. Cheap and common, add 90 EM to the armor price.

### HARD PLATE

**A**lso called Plate Armor or Metal Gear. Hard Plate, like Kevlar, is an old but popular defensive item. It is commonly seen only in war zones. Hard Plate can be made of many different substances, including ceramics, plastics, foam metals, or combinations. All Hard Plate has 25 SP. It comes in sectional pieces; head, torso, arms, and legs. All sections cost 100 EM apiece. Hard plate has full defense vs. lasers, but only half defense vs. explosions. It is ineffective vs. static and seizure guns. Hard Plate can be coated with resistant fabrics at an extra cost per segment (see resistant fabrics above). EV +2 for whole body.

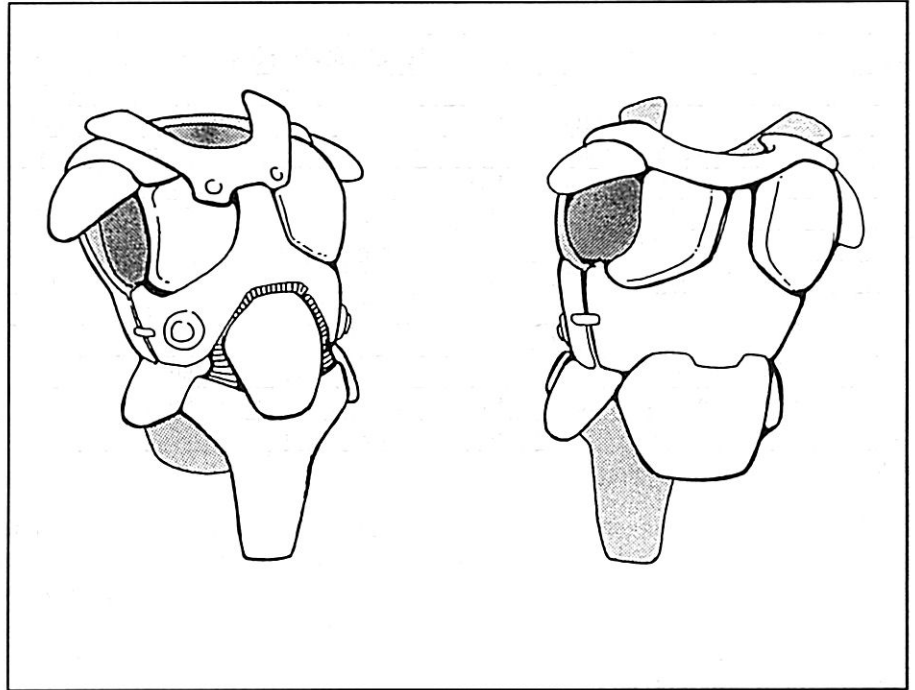

### REFLECTIVE PLATE

**A**very light composite armor with a reflective coating. It is effective against lasers only, offering no defense against other beam or kinetic weapons. Reflective plate has 30 SP vs. lasers, but it loses 1 SP for every 10 points of laser damage it absorbs. Reflective plate cannot be combined with resistant fabrics. Reflective coatings can be put on hard plate, but coated hard plate can not be combined with resistant fabrics. Mud, dirt, or paint on the armor impairs its effectiveness (1/2 resistance). Head, torso, arm and leg sections cost 120 EM each. Reflective hard plate costs 200 EM per section. Uncommon. EV +2 for whole body.

### ABLATIVE PLATE

**h**eat displacement ceramics and foam metal are combined to form a tough, durable armor, effective against projectile and laser attacks. SP 20 vs. physical attacks and SP 40 vs. laser and plasma attacks. For every 5 points of damage subtract 1 SP from both energy and physical defense. Ablative Plate comes in the usual sectional pieces. 500 EM per piece. EV +2 for whole body. Ablative plate can be combined with resistant fabrics. Rare.

### ANTI-LASER AEROSOLS

**C**heap alternatives to laser resistant armors. Anti-laser aerosol cans spray a cloud of reflective and heat absorbing particles into the air, producing a cloud 3m in diameter in one burst. Pulse and beam lasers are compromised by the cloud. Anti-Laser Aerosols carry enough for 30 bursts each of which last about 12 combat turns. The effectiveness of a cloud decreases in 3 turn increments. For the first three turns after a cloud is released targets inside are at -4 to hit, and hits do minimum possible damage. The second three turns; -3 to hit, 1/4 damage. The third three turns; -2 to hit, 1/2 damage. The fourth three turns -1 to hit, 3/4 damage. After that the cloud has dispersed into ineffectiveness. No matter how much aerosol is sprayed, effectiveness will never exceed -4 to hit and minimum damage. Wind and rain can speed the dispersion of clouds to as fast as four turns. People not wearing eye or respiratory protection have a 5% chance of suffering adverse effects when in a cloud, including -4 to REF and -4 visual Awareness rolls. 150 EM per can, available anywhere.

---



---

ABLATIVE CREME

---



---

**C**hese are thick, blue, powdery cremes applied directly to the skin. Originally designed to protect against flashburn from orbital lasers, ablative creme confers 10 points of defense against laser hits. Every 5 points of laser damage reduces the creme's effectiveness by 2 points. Ablative creme comes in tubes of 5 full body applications, or about 30 hand and face applications. If you don't cover all exposed areas you may still suffer damage. 100 EM per tube, available anywhere.

---



---

ELECTRONIC  
COUNTER  
MEASURES

---



---

**E**CM is the defense against smart missiles. ECM suites are generally part of the package in vehicles, and are rarely purchased separately. All ECM packages have a listed percent value. This is subtracted from smart missiles' percentile To Hit rolls. Thus a smart missile that normally has an 80% chance to hit has only a 65% chance vs. a vehicle with an ECM suite rated at -15%. When purchased separately for installation in vehicles, ECM suites cost 2-5,000 EM per percentage point, and are never greater than -50%. Refs should consider this when designing vehicles.

---



---

VEHICLES OF THE  
23RD CENTURY

---



---

**T**he development of advanced materials and propulsion systems has led to revolutions in the transportation technology of the 23rd century. Such things as light, composite vehicle armors, electro-responsive metals and polymers, new alloys and memory materials have allowed designers to create aircraft and ground vehicles that are faster, lighter, stronger, and in some cases, even cheaper than their predecessors.

Alternate fuel sources have developed out of necessity, since petroleum supplies have dwindled to a trickle. Methanol, methane, hydrogen and electricity are all in use, but the splintering of nations has prevented the development of a world stan-

dard. The owner of a Nuevo Tejas methane burning car may have to search long and hard to find a commercial methane source in Arabia. Electric cars are the most universal, and the easiest to refuel. Just make sure you have a voltage converter. Newly developed hydrogen and methane fuel-cell systems are just beginning to become popular.

Some vehicles have onboard computers which can drive them to preprogrammed destinations or respond to signals from master traffic control computers. (Only a few of the largest cities still have these computers.) Control features have also been refined, with multifunction displays (MFDs), touchscreen controls and heads-up instruments common. Voice control has also been perfected. Many controls are integrated into helmets, reacting to the operator's head and eye movements. Weapons track and fire literally at the blink of an eye. Cory links are the most common alternate method of control. Cory control systems cost the same as cyberlink systems in *Cyberpunk*.

Small, efficient vehicles have become the order of the day. With the world so divided, large haulers just aren't in demand, and few can afford to run them. There are exceptions though. The *Atlantic Mistress*, the largest oil tanker ever made, was sold for scrap in 2150. Before it could be broken up, the wealthy Bergen family of Norway purchased it and sailed it into the Mediterranean. The Bergens converted the tanker

into a carrier for the millions of refugees who were looking for transport around the region. The Bergen's investment was recovered in the first year. After the diaspora, a talented group of refugees took over the operation of the *Mistress*, converting her into a huge, travelling marketplace; half carnival, half caravan. The *Mistress* still cruises the Med, tents and houses decorating her huge flat decks and children playing on her railings. Her majesty has never been greater.

---



---

CIVILIAN VEHICLES

---



---

**Electric Cars**

Manufactured world-wide by innumerable companies.

**Powerplant:** High efficiency electric motor powered by barium-superconductor batteries. 100 horsepower average.

**Speed:** 80-150kph.

**Range:** 400-600km.

**SDP:** 50

**SP:** 5 Can be armored to 20 SP.

**Cost:** About 2000 EM.

This is the basic city and road car. Most models have room for 2 passengers and 100kg of cargo. Family models can hold 5 people and 200kg of cargo, but will be in the low range for performance and efficiency. Bodies, tires and motors are all largely

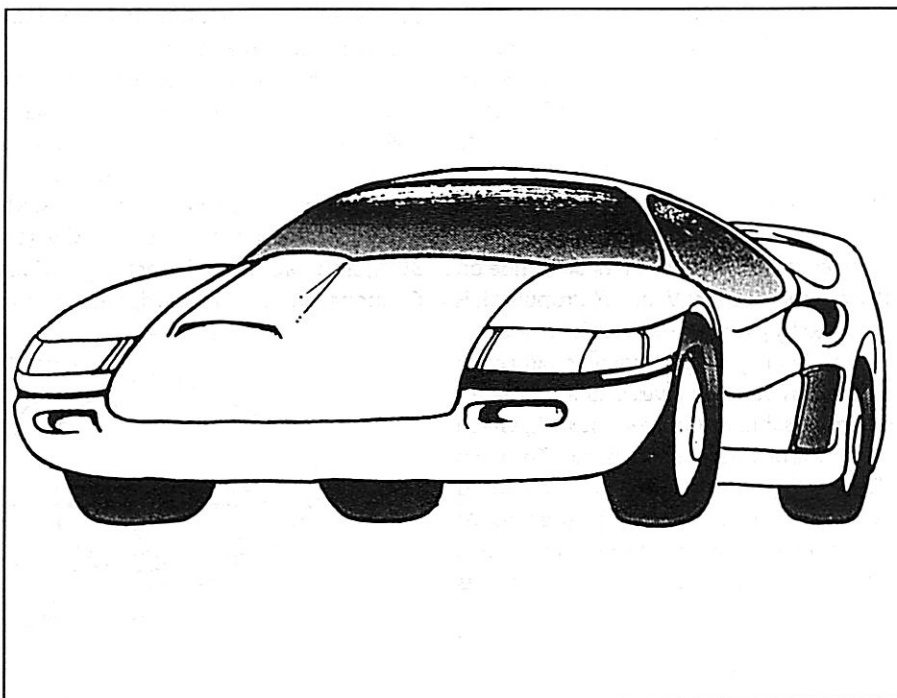

## WHEN GRAVITY FAILS

constructed of synthetic bioplastics. Electric cars are reliable, universally refuelable, and have decent range, but they aren't performance vehicles. Basic transportation.

### Combustion Car

Manufactured in many First World countries. Methane and alcohol burning are the most common, followed by hydrogen. Some fuel-cell models are just coming out. Gasoline powered versions are very rare.

Powerplant: Internal combustion. 50-300hp.

Speed: 100-300kph.

Range: 400-1000km.

SDP: 60

SP: 10 to 30 depending on armor.

Cost: 60-100,000 EM.

These are heavier than electric cars, and have better performance specs. These cars provide the upper classes with the power and luxury they crave, and are a common alternative to aerodynes. Models range from 2 seat, high performance sports cars to luxury limos with seating for 8 and heavy armor. Some have hidden weapons such as lasers or seizure cannons.

### GEV Rovers and Trucks

Manufactured in most industrial nations.

Powerplant: Alcohol or methane combustion, some fuel-cell models. A few low-performance electric models.

Speed: 110 (trucks) to 220 (rovers) kph.

Range: 800km.

SDP: 80 (trucks) 70 (rovers).

SP: 5, but can be armored to 40. Ablative and Reflective Armor available. Cost: 10,000-20,000 EM.

These are the off-road vehicles of choice. Using plenum skirts and high-powered fans, these craft create a cushion of air to ride on (GEV: Ground Effect Vehicle). Propulsion is provided by jets or props. Excellent for crossing moderately rough terrain or fairly calm water. Obstacles or waves over a 1.5 meters are impassable without jet boosters, which are typical on military models only. The main disadvantages are the noise and tremendous amounts of dust kicked up by the fans. At high speeds they can be less than nimble. Hovercraft are banned inside most city limits but you will find them roving the open plains of most continents. They are a favorite of Runners on tight budgets.

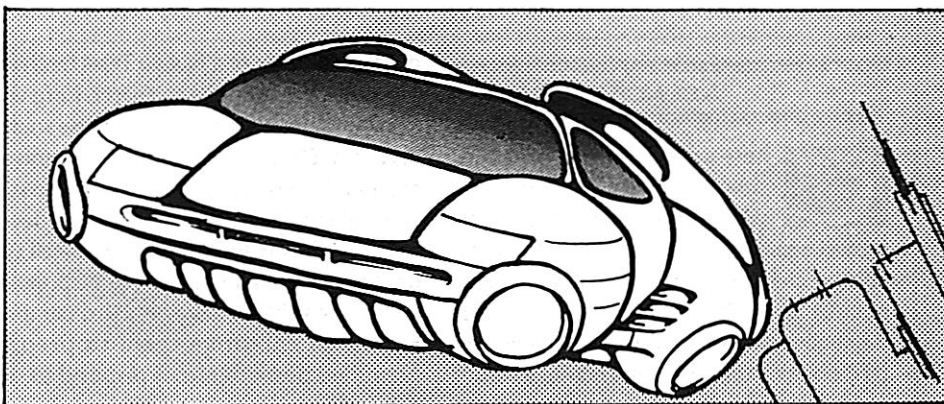

### Aerodynes

Manufactured in Japan, North America, Brazil, and England by various makers.

Powerplant: Advanced hydrogen burning turbofan engines.

Speed: 500kph.

Range: 600km.

SDP: 70-100.

SP: 10. Can be armored to 50.

Ablative or reflective armor is common. ECM:

to -30%

Cost: 200,000-400,000 EM

23rd century versions of the AV series aerodynes from *Cyberpunk*. These vehicles house extremely powerful, compact turbines behind the passenger compartment, using a complex series of vents for lift and control vectoring. No larger than cars, aerodynes can zip between buildings and canyons like nobody's business, making them great urban vehicles and the ultimate in attack aircraft. They have low IR signature, but are loud even when baffled. Real hangar queens, they would be more popular if they didn't require so much maintenance.

Used primarily by industrial countries and large corporations, these have replaced helicopters in the light VTOL role. Civilian versions range from truck-sized haulers to small, nimble, 2 person sport hoppers. Military craft are armored, carry ECM (to -30%) and pack Pulse Lasers, Light Gauss Cannons, and up to 4 hardpoints for mis-

siles or munitions. Advanced Targeting is also available to +2.

### Airliners

Manufactured in most industrial countries.

Powerplant: 2-4 hydrogen burning turbofans.

Speed: 800kph.

Range: 6000 km.

SDP: 250.

SP: 10. Seldom armored.

Cost: 5 million EM.

These have shrunk in size and grown in sophistication, with composite skins and computer controlled, fly-by-optic surfaces. An average liner only carries 150 passengers and is far more fuel efficient than its predecessors. Most have STOL capability for operations in under-developed areas. Some carry ECM gear (-15%) just in case.

### Airships

Manufactured in North America, Japan and NuesDuetschland.

Powerplant: 4-8 ducted electric fans or 4 hydrogen turbofans.

Speed: 400kph (fans), 600kph (turbofans).

Range: 12,000km.

SDP: 1000.

SP: Gas compartment, 10. Passenger/cargo compartment, 15.

Cost: 2-4 million EM.

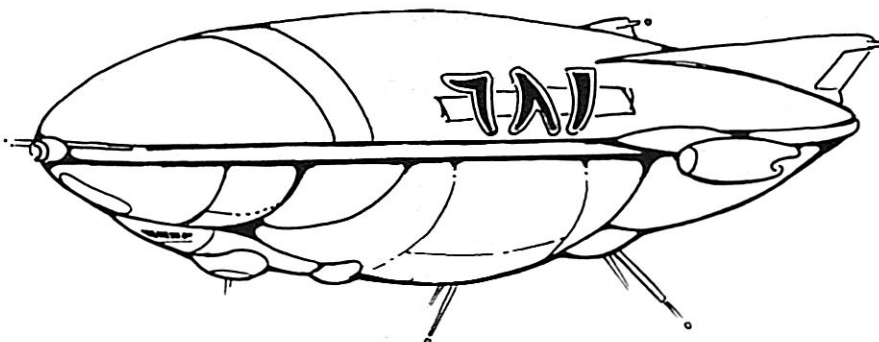



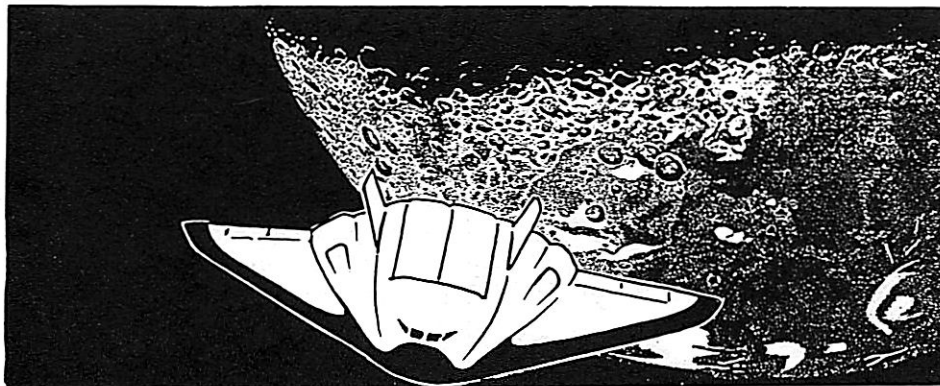

Made practical by advances in materials technology, these rigid frame airships have taken the place of large airplanes, and to an extent, passenger liners. Using helium for lift, they are efficient and reliable. Cellular construction enables these ships to fly on one engine with only half their gas compartments intact. They are not made for combat, though. In an air battle, these just give the enemy target practice; +4 To Hit. Their size lets them soak up an astounding amount of damage. Cargo versions carry up to 100 tons, while passenger ships can carry up to 300 passengers in relative luxury.

**Suborbital Shuttles**

Manufactured in Japan, Nuevo Tejas, and several European countries.

- Powerplant: Hydrogen burning turbofans, scramjets and rocket thrusters. Speed: 3000kph in atmosphere, 15,000kph in LEO.
- Range: 1 trip anywhere on the globe. Must be refueled before flying again.
- SDP: 250.
- SP: 15. Always have 30pts of ablative armor on underside. (Heat shielding.)
- Cost: 50 million EM.

Designed to carry 80 passengers or 12 tons of cargo into the uppermost reaches

of the atmosphere, where they use scramjets to achieve ultra-Mach velocities with minimal fuel use. These ships have the newest in responsive composite fuselages. These allow the shuttles to vary their shapes in response to pressure and temperature stresses and change wing and body chord to switch from hypersonic to STOL configurations. The shuttle is at maximum efficiency at any altitude and speed. A few of these carry heavy beam lasers and ECM suites for self-defense against missiles.

---

**MILITARY VEHICLES**

---

**Hovertanks**

Manufactured in First World countries and Brazil.

- Powerplant: Hydrogen burning turbine engine.
- Speed: 110kph.
- Range: 450km.
- SDP: 250.
- SP: 75 vs. everything.
- Armament: One heavy gauss cannon with 200 rds or 24 heavy smart missiles and launcher. 3 anti-personnel heavy beam lasers, 12 antipersonnel mines (frag grenades attached to the hull, designed to blow

outward), 2 sensor hover drones.

ECM: -20%.

Advanced Targeting: +1.

Cost: 3 -4 million EM.

The modern incarnation of the queen of the battlefield. Tanks generally have a crew of three: driver, gunner, and commander. Some can carry a five man infantry squad in addition. They have some of the most sophisticated sensor suites available, including two remote hover-drones designed to range across the battlefield, relaying tactical information to the tank. Tank commanders view drone information on a special holographic display.

Drones are commonly used as target acquisition devices, locating a target and painting it with a laser designation beam. The tank then fires smart rounds from behind cover, which will automatically track on the marked target. Infantry troops spend a great deal of time trying to take out enemy drones, and drones are now being armed with antipersonnel weapons.

**Jumpjets**

Manufactured in the First World and the Arab Federate.

- Powerplant: 1-2 hydrogen burning turbofans.
- Speed: 1000-2000kph.
- Range: 1200km.
- SDP: 180.
- SP: 20 (40 with ablative armor.)
- Armament: 2 pulse laser cannon or heavy beam lasers, 3-8 hardpoints. ECM: -10% to -50%.

Advanced Targeting: +2.

Cost: 2-3 million EM.

Descendants of 20th Century VTOL aircraft, these planes use vectored thrust for vertical take-offs and landings. Their hulls are made of the responsive composites, allowing them to adjust during maneuvers for maximum effect. Combined with special materials and ECM, you get a stealth aircraft of impressive qualities. Military fighters use these features to get behind enemy lines. Smugglers use them to cross borders. VTOL fighters can operate near the front without vulnerable airfields. Smuggler craft can land in fields, roads, or anywhere away from prying eyes.

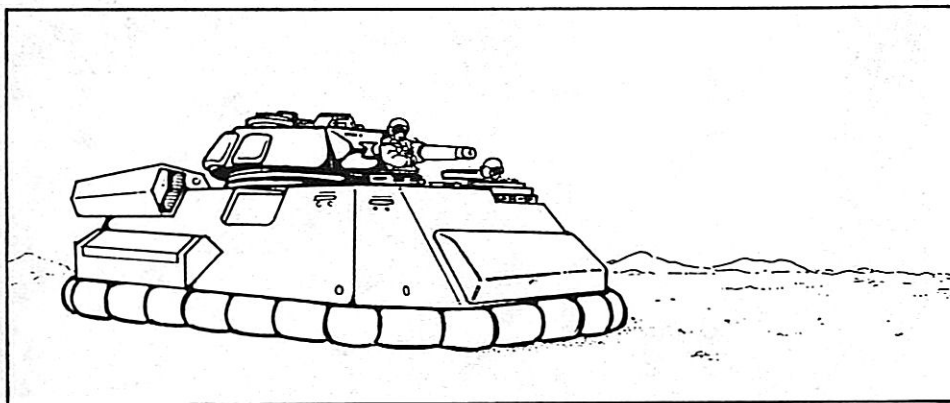

## WHEN GRAVITY FAILS

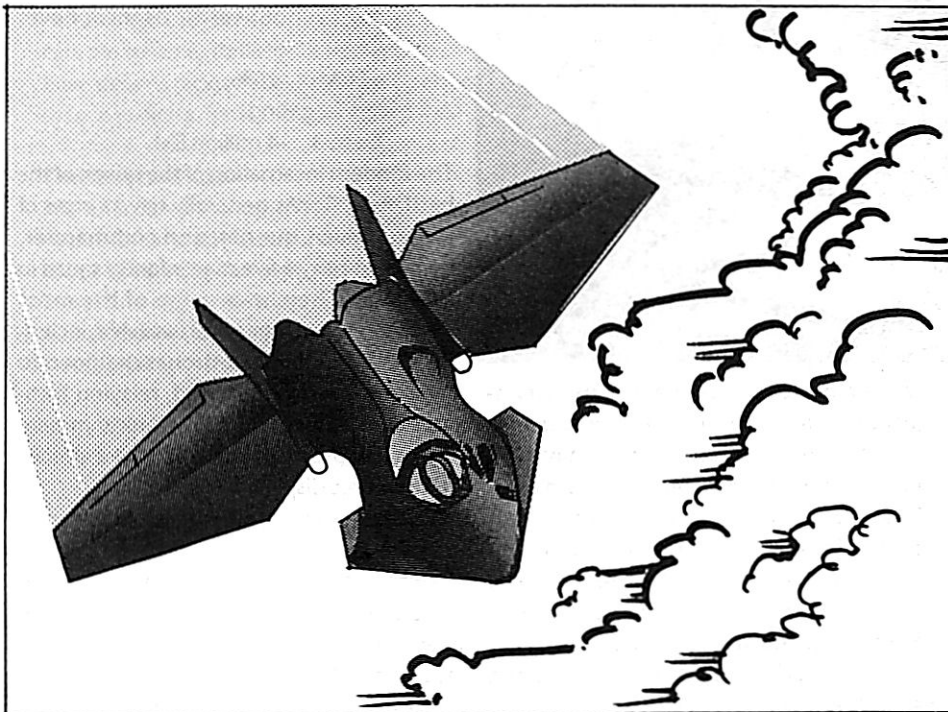

counterparts. Advanced computers and cory-links allow the operators to closely supervise their distant charges. All remotes use the REF and Pilot RPV skills of their operators in combat. If communication is broken, the on-board systems take over with programmed skills. The wide variety of RPVs available precludes an exhaustive listing, but here are a couple of examples.

### Rover Hoverdrones

Powerplant: Fuel-cell powered hoverfans.  
Speed: 120kph.  
Range: 200km.  
SDP: 40.  
SP: 25.  
Armament: Varies. Beam laser rifle, 8 small smart missiles or one light gauss cannon.  
ECM: -10%.  
Cost: 60,000 EM.

Miniature hovercraft used for scouting and reconnaissance. They often accompany tanks into action. Missions range from target acquisition to deep recon missions behind enemy lines, with on-board sensors transmitting information back to base. While they are primarily made for recon they have been increasingly pressed into the attack role. Several types of weapons can be mounted on-board. The on-board computer with its Pilot skill of +5, REF of 7, and appropriate Weapon skill, can take control if the unit loses contact with the operator.

There are two basic versions of the Jumpjet: cargo and fighter. Cargo jumpjets can carry up to 5 tons of cargo or 10 passengers. Fighters are designed strictly for combat, with a crew of one. Each hardpoint can mount either one heavy or medium smart missile, eight deadfall bombs, an ECM pod (-10%), or any of several other items.

These are the vehicle of choice for runners; fast, stealthy and versatile. Some hopped-up runnercraft have AI computers, satellite links, RPV decoy mounts and smart missiles. A few have very plush interiors as well. When you live in an aircraft, you make it comfortable.

### Interceptors

Manufactured in Japan, Jutland, and England.

Powerplant: 1 or 2 hydrogen burning turbofans.  
Speed: 2000-5000kph.  
Range: 2000 km.  
SDP: 240.  
SP: 35. Can be reflective.  
Armament: 2 pulse laser cannon with 100 shots each, up to 10 hardpoints for air-to-air smart missiles.  
ECM: -40%.  
Advanced Targeting: +2.  
Cost: 10 million EM.

These are the nemesis of jumpjetting smugglers. Designed to move at ultra-Mach veloc-

ities to catch and bring down intruding aircraft, Interceptors can appear from anywhere and end a Runner's career in a fireball across the horizon. Only a few countries can afford to field these deadly craft. Runners tread carefully around those nations.

### RPVs

Remotely Piloted Vehicles have become a major factor in modern warfare. Small, radio controlled craft are cheaper and often more maneuverable than their manned

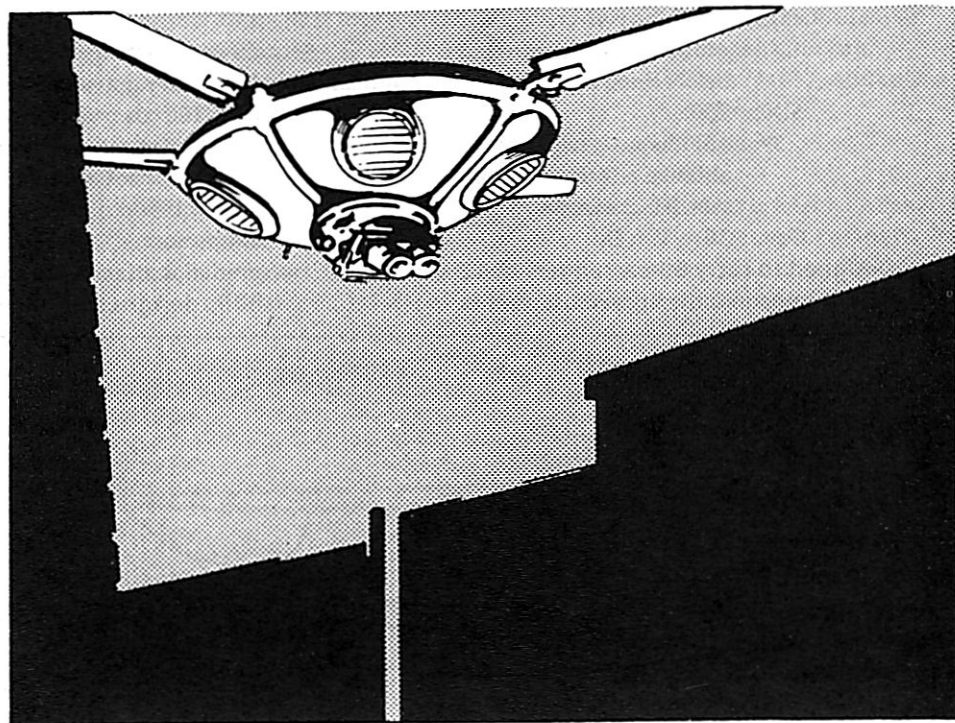

VEHICLE  
COMBAT

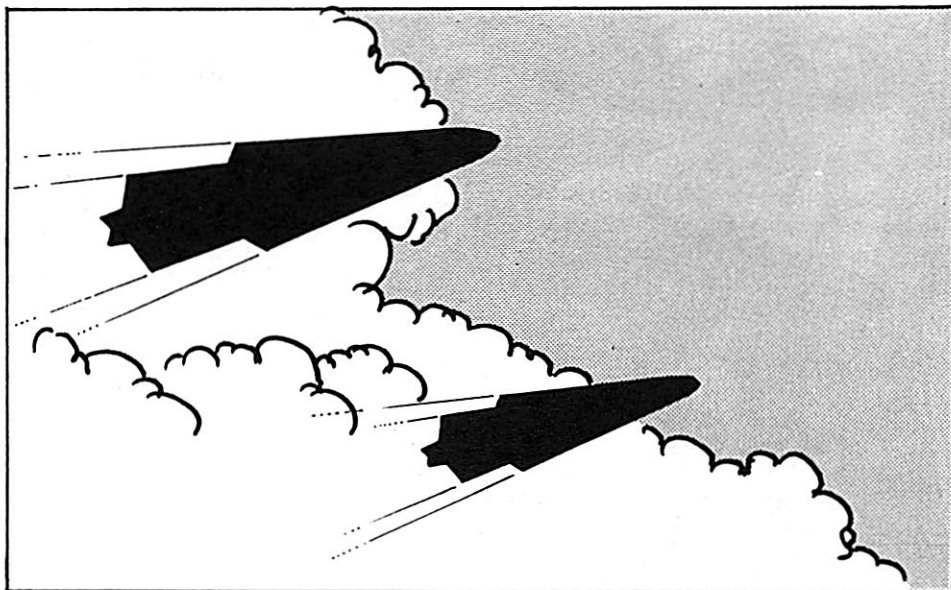

**Viper Attack Drones**

Powerplant: Fuel-cell turbofans.  
 Speed: 1000kph.  
 Range: 1200 km.  
 SDP: 45.  
 SP: 30.  
 Armament: 4 medium smart missiles and one heavy pulse laser with 30 shots.  
 ECM: -25%.  
 Advanced Targeting: +2.  
 Cost: 100,000 EM.  
 These delta-shaped, airborne attack remotes are designed to hunt down and engage enemy drones or aerodynes over the battlefield. When not linked to an operator, the computer controls the craft

with REF 8, Piloting +6, and Weapons skills of +5. Guided by advanced AI technology, these machines have been known to independently plan ambushes of enemy craft.

**Remote Control Board**

Cost: 6000 EM; 10,000 EM with booster.  
 Required to operate battlefield drones, this is a sophisticated radio control board about the size of a large briefcase. It can include a holographic display and cory link as required. Control can be via cory link, or console and joystick. Broadcast range is about 300km, 1000km with booster.

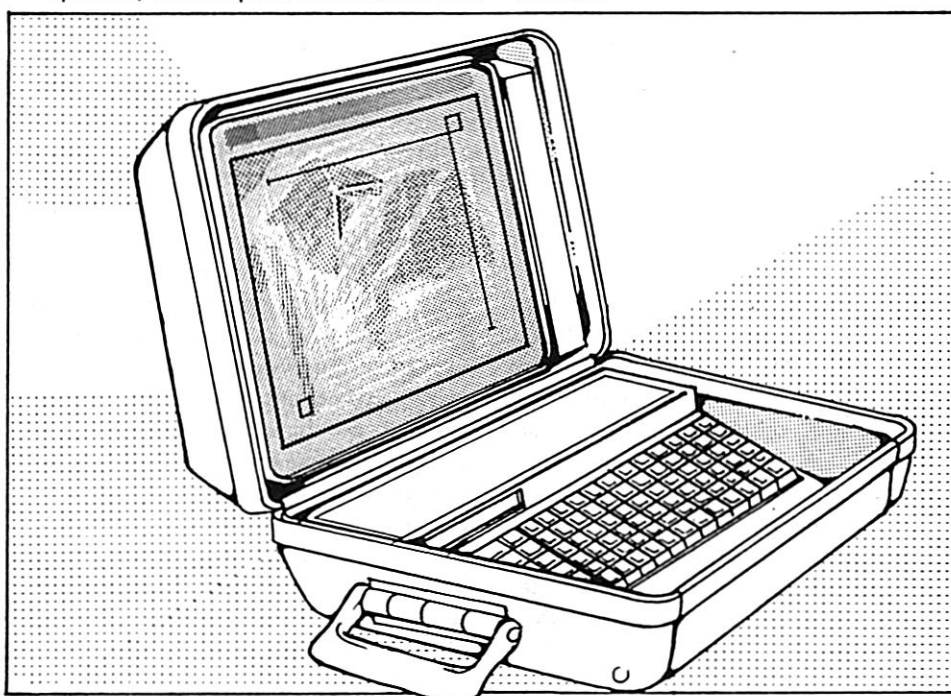

Use the basic system in *Cyberpunk 2020* for vehicle combat, or, if more detail is desired, the advanced system in *Solo of Fortune*. If the advanced system is used, referees will have to arbitrate the difficulty levels for the different maneuvers with the new vehicles. For extra detail we have included a new vehicle hit-location system in this book. When hits penetrate armor roll on the tables below. Some hits are considered critical and increase the amount of damage.

This is an optional rule.

**Civilian Ground Vehicles**

Roll	Location
1-4	Tire or GE Skirt
5	Engine
6	Driver or Crew
7-10	Vehicle Body

**Military Ground Vehicle**

Roll	Location
1-3	Tire or GE Skirt
4	Engine
5	Driver or Crew
6-9	Vehicle Body
10	Turret or Weapon (Body if none present)

**Aircraft**

Roll	Location
1-2	Engine
3	Pilot or crew
4-5	Wings, Rotors, or Fans
6-10	Vehicle Body

**Critical Hits**

Hits on Engines, Wings, Rotors, Fans, or Tires when in motion are considered Critical. Double the damage that penetrates for these hits. A Control roll against Difficulty 20 must be made or the pilot/driver loses control.

**Remote Combat**

Combat between Remotely Piloted Vehicles is the same as regular vehicular combat, except Pilot/Crew hits become Computer Hits, and are considered Critical. ■





**Note:** Only referees should read this adventure!

## INTRODUCTION

**T**he Silken Nights is a three-part scenario designed to introduce referees and players to adventuring in the world of *When Gravity Fails*. It takes place throughout the city and the Budayeen and involves many of the technological items, and cultural conditions, unique to *Gravity*. The complete adventure should incorporate all three sub-sections, but the modular design will make planning and running the adventure easier. Each sub-section has its own discrete goal, but the completion of each one will lead the characters closer to the ultimate solution to their mystery. The sub-sections must be run in the sequence in which they are presented here. The adventure may be run with from three to five players; we suggest using our pre-generated characters. Playing the adventure to conclusion should take from one to three sessions. As suggested in the text, the adventure is heavy on roleplay and light on combat.

### CAUTION

**T**his adventure deals with adult topics, including sex-change, prostitution and alcohol and drug use. While it is highly unlikely that anyone who is sensitive about these matters will have made it this far into this book, or enjoyed the original novel, we still want to issue this warning. R. Talsorian Games does not condone alcohol and drug abuse, or prostitution.

### IT'S NOT WHAT YOU'RE USED TO

**T**he "Silken Nights" is designed to thrust you and your players straight into all that is most exotic in *When Gravity Fails*. To this end, the key characters in this adventure are three sex-change women who begin the scenario as prostitutes. Players may initially balk at using these characters, but they should find as the

adventure progresses that they are more than they appear to be. This is, in fact, the crux of the whole plot. If players completely refuse to use the women then they can be relegated to NPCs. In this case your player characters will be friends of the women or people whom they hire to help solve their mystery (two of the pre-generated characters are friends of the women). Taking this path may diminish the impact of the adventure, however, and we recommend using the provided characters. If you have fewer than five players, precedence should be given to assigning the three women as PCs. Trust us, it'll be more fun that way. Dare to be different. This is, after all, *Cyberpunk*.

This adventure is probably sounding pretty unusual by now. Good, that's the way we want it. Anyone who has read either this sourcebook or the actual novels knows that adventuring in *Gravity* is not the same old thing, and certainly not for the conservative or faint of heart. As we said above, people uncomfortable with the concepts detailed in the novel and sourcebook will probably not enjoy gaming in the *Gravity* universe. For those people there will always be Cribbage. The rest of you hold on tight.

---



---

## BACKGROUND

---



---

**T**hree years ago, the patriarch of the wealthy and powerful al-Yemen family died suddenly, leaving his four sons to inherit his estate and fortune. The eldest brother, twenty-five year old Habib, was an evil and power-hungry individual who looked upon his father's death as an opportunity to realize his ambitions. The Yemen clan's chief business rivals had always been the Lechin family, a Christian clan local to the city. Habib, lacking his father's subtlety, hated the Lechin family, and desired nothing more than to see it chased from the city or destroyed. He hatched a plot whereby he would bankroll and oversee the production of a line of black-market moddies, many of which would be considered blasphemous in Islamic nations. While reaping the profits from the sale of these moddies he hoped to have the blame for their production placed upon the Lechin family. After all, no pious Muslim house would produce such offensive items. Habib fell in with someone known as the Eye of the Star, a shadowy individual with a reputation as a technical genius and one of the world's leading black-market moddy designers. Together they arranged to begin production of the illicit moddies.

Unfortunately for Habib, there was a hitch in his plan—his three younger brothers: Outha, 22; Rashid, 20; and Salmin, 18. Outha suspected that his elder brother's evil plots could lead to the downfall of their family and the dishonoring of their father's name. Closest to the two younger brothers, Outha schemed with them to remove Habib from power. Salmin especially had a vested interest in preventing the downfall of the Lechin family, as he was in love with one of the young daughters from that household.

Before the three brothers could execute their plans, Habib secretly discovered their conspiracy. Evil as he was, Habib could not bring himself to kill them, so he and the Eye hatched an even more insidious plot. At a family dinner he arranged for the brothers' wine to be drugged. That night, he had the three unconscious young men shipped to Neues Deutschland on a secretly chartered flight. The brothers were all given high-level sex-change operations; enough to defeat all attempts to discern

their original gender. Only a close medical examination would reveal the truth. Special moddies designed by the Eye were implanted inside the brothers' skulls as well. These moddies replaced their normal memories, personalities and skills with artificial substitutes. They also used experimental template technology, allowing them to interact with any normal moddies inserted into the brothers' corymbic implants and enabling them to operate continuously without causing Insert Personality Rejection Syndrome. No one would ever know that their personalities were artificial.

While the brothers were being physically and mentally reconstructed in Neues Deutschland, Habib faked their "accidental death by fire" at the family compound in the city. Amidst much mourning, three singed corpses in closed caskets were buried in the cemetery by the Budayeen. Shortly thereafter Habib had Outha, Rashid and Salmin secretly flown back to the city. The brothers were now young women with the memories and personalities of prostitutes and the names Sara, Fatima and Lilli. He secretly arranged for all three to be given jobs at the Silken Nights brothel. Habib thought that by keeping the brothers together he might better keep them under control.

That was his first mistake.

Habib also did not reckon with the power and influence of Friedlander Bey, nor the interest that Papa took in the goings-on of his city.

That was his second mistake.

Two years later...

---



---

## THE ADVENTURE

---



---

### EPISODE ONE: SILKEN NIGHTS

---



---

**T**his segment introduces the characters to each other, and gets the plot rolling by hinting that all is not as it seems with the three girls. The key setting is a party at the brothel at which the girls and other player characters can interact with key Budayeen NPCs and during which Sara receives a moddy which reveals that she has secrets buried deep within her mind. The key event is Sara's insertion of the moddy sometime that evening.

---



---

## SETTING IT UP

---



---

### THE PLAYER CHARACTERS, AND WHAT THEY KNOW ABOUT THEMSELVES

---



---

**A**s the adventure begins, the five player characters must be briefed on what they know about each other and themselves. Three of the characters are the three brothers, now women. They are good friends, but they have no suspicions as to their true histories or relationship. They do not realize that they are related, although as friends they have felt a special bond since they first "met" each other at the Silken Nights. The other two player characters are male employees of the brothel who are friendly with the girls: the bartender and the bouncer. Brief the players on their character's backgrounds separately and allow them to share whatever information they choose with their fellow players.

**Important:** Under no circumstances should you reveal the characters' true histories to the players. Uncovering their past is the backbone of the adventure, and the players should be just as surprised as their characters.

---



---

### PRE-GENERATED PLAYER CHARACTERS

---



---

**Note:** The women are prostitutes, but they are classed as Strippers for simplicity. See the section on new character classes. The only character who starts with a weapon is Fatima. Let the characters choose some other items of basic equipment that suit their characters. Initially, only Abdullah is likely to wear armor, although Simon might. Use your judgement in keeping the characters selections of equipment reasonable. Remind them that they can use daddies to supplement their skills if necessary. Let each character pick a couple of daddies to start with. They should be appropriate to the characters and not worth more than about four-hundred kiam total. They can buy other daddies as they need them later in the adventure, providing their finances permit. If the players want to flesh the characters out more they can see the lifepath in



Cyberpunk 2020. None are likely to have more than a couple hundred kiam starting money. Copy all stats and skills onto character sheets for player use.

---



---

The Girls

---



---

**Sara, Stripper:** It seems that all your life Allah has intended for you to fulfill the fantasies of others. Your mother died when you were eleven, you never knew your father. Prostitution was the only way to survive. You are by nature shy and submissive, a good Muslim woman, and it has always pained you, the path that your life has taken. Your escape from the prison of your existence is moddies. Other than your friends they are your one true joy in life. Allah must have sent them to Earth just for you. You so enjoy the different personalities they give you: seductress, dominatrix, master of men and their desires. All so different from your true personality. If possible, you would stay under the influence of moddies at all times, never again becoming sweet, shy, disillusioned Sara. Abdullah the bouncer has a crush on you. You like him, but you

rebuff his advances as you do not wish to become involved with anyone who works at the brothel.

INT 6, REF 8, TECH 5, COOL 6, ATTR 10, LUCK 9, MA 7, BODY 6, EMP 8, BTM -2, SAVE 6.

Vamp 4, Personal Grooming 6, Wardrobe and Style 5, Streetwise 5, Human Perception 8, Seduction 4, Social 6, Persuasion and Fast Talk 5, Perform 4, Dance 5.

Cyberware: Corymbic implant with moddy plug.

**Fatima, Stripper:** You are an ambitious young woman. You are only making time with the pathetic men of the Budayeen until you can save enough money to buy a ticket to the big time in Europe, North America or the Pacific Rim. Where the real action is, and where the men know how to show the women a good time and have the money and power to do it. You would've left already if you didn't spend money almost as fast as you make it, but your time is coming soon. At seventeen years old,

you're already one of the busiest women in the Budayeen. You enjoy satisfying the desires of others. It gives you a feeling of power. Other women call you slut and harlot. But what does that matter? They are just jealous that their husbands come to you for satisfaction. You ran away from home at an early age and have no idea where your family is now.

INT 7, REF 9, TECH 5, COOL 8, ATTR 10, LUCK 8, MA 6, BODY 5, EMP 7, BTM -2, SAVE 5.

Vamp 10, Personal Grooming 2, Wardrobe and Style 2, Streetwise 8, Seduction 8, Social 2, Persuasion and fast Talk 10, Perform 5, Dance 5, Handgun 4.

Cyberware: Corymbic implant with moddy plug.

Carries a seizure pistol.

**Lilli, Stripper:** You have a secret past that none of the other girls know about. Your name is actually Ada, and you are of high birth. You were engaged to be married to



the son of another noble house, but you loved his younger brother. He made you pregnant. Your horrified parents had you exiled to the Budayeen, where you lost the child to a miscarriage. Your lover fled the country to escape the wrath of his brother. He has vowed to return and rescue you someday. You spend your days awaiting his appearance, using moddies to keep your soul pure for him while you pursue your distasteful trade. You have told the other girls that you are an orphan.

INT 10, REF 6, TECH 5, COOL 7, ATTR 10, LUCK 8, MA 6, BODY 6, EMP 10, BTM -2, SAVE 6.

Vamp 3, Personal Grooming 6, Wardrobe and Style 6, Human Perception 9, Seduction 6, Social 5, Perform 6, Composition 5, Education and General Knowledge 4, Library Search 5, Dance 6.

Cyberware: Corymbic implant with moddy plug.

---



---

### THEIR FRIENDS

---



---

**Abdullah, Solo:** Working as a bouncer in the Silken Nights is a pretty good gig. The pay is solid, for the Budayeen, you get room and board, and occasionally one of the girls will give you a freebie. You are friends with all three of the girls, especially Sara. You are attracted by her shyness. Unfortunately, she's not interested in you. Still, you keep working on it. You are a long-standing employee of the Nights, and totally loyal to the owner, a Frenchman named Monsieur Joseph. He plucked you off the streets and gave you a life. On the other hand, you think that the manager, Ayesha, is irritating and dictatorial. Other than that, you're happy where you are.

INT 7, REF 9, TECH 6, COOL 8, ATTR 9, LUCK 7, MA 8, BODY 10, EMP 6, BTM -4, SAVE 10.

Combat Sense 8, Strength Feat 3, Interrogation 5, Awareness/Notice 5, Intimidate 5, Brawling 10, Dodge and Escape 2, Handgun (seizure pistols, needle guns) 7, Melee 8, Stealth 5, Streetwise 4.

Cyberware: Corymbic implant with moddy plug.

**Simon DeWitt, Fixer:** You are a North American expatriate from Nuevo Tejas. You were a soldier at one time, serving in the Coahuilla and Nuevo Leon campaigns. You saw many battles, and were lucky to emerge alive, let alone whole. Well, not quite whole. You were an experimental subject for a variety of combat drugs tested by the Nuevo Tejas government. These eventually lead to addictions and the disintegration of your life. You got in trouble with the local law and fled the continent. Now your job is to mix drinks and serve them to the customers at the Silken Nights. You've recovered a great deal from those days of chaos, although you still have a weakness for pills. You need them to get through the night, when the shakes and nightmares return to haunt you. Many of the girls are touched by your plight, and you've been taken into their confidence. They are your best friends. You are closest to Sara, Fatima and Lilli. Being on good terms with Abdullah, you share many of his opinions as to the management of the brothel. Your position at the bar allows you to interact with many people, and you've forsaken your past as a soldier for the new role of Fixer.

INT 8, REF 6, TECH 8, COOL 9, ATTR 7, LUCK 8, MA 6, BODY 7, EMP 8, BTM -2, SAVE 7.

Streetdeal 8, Streetwise 7, Leadership 1, Education and General Knowledge 4, Dodge and Escape 4, Handgun 3, Submachinegun 2, Melee 2, Karate 2, First Aid 2, Awareness/Notice 4, Pick Lock 3, Electronic Security 5, Stealth 4, Driving 3, Library Search 2, Shadow/Track 5, English (Native).

Cyberware: Corymbic implant with moddy plug, Arabic +4 daddy, 12 Sunnies, 12 Paxiums.

---



---

### THE IRONIC TRUTH

---



---

 here are some things that the players don't know about their characters, but may discover later. Habib and the Eye of the Star did their best to make the brothers' construct personalities as different as possible from the originals while not compromising template integrity. Shy, quiet Sara was Outha, the eldest of the three brothers and the leader of their conspiracy. Outha was a natural leader

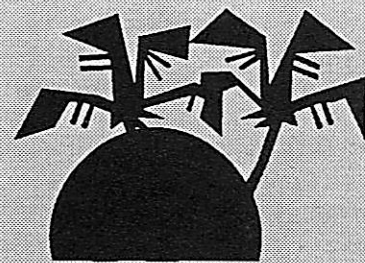

## THE SILKEN NIGHTS

**T**he Silken Nights is a large, sturdy, though somewhat dilapidated looking building located on a side-lane just off the Street. A flashing red neon sign above the door spells the name in Farsi. Next to the door is a small metal plaque which bears the inscription "Until Allah calls, Heaven is where you make it" also in Farsi. The first floor of the building is a club with a bar and a small stage for dancers. The club is furnished with props from an old moddy production of the "Arabian Nights," including columns, arches, plush couches, chairs and throw pillows. The working girls are all dressed in best "Harem" fashion; in thin silk coverings and veils. While Simon pours them drinks, customers may lounge about the club or select one or more of the girls from the photo albums at the bar. Customers indicate their selection to the manager Ayesha or one of her assistants and pay in advance at the bar. The hulking Abdullah keeps a close eye on the club and stays in contact with Ayesha and the girls, ready to intervene at a moment's notice if there is trouble. On the second and third floors are the ten "guest" rooms and Simon and Abdullah's rooms. On the fourth floor are the offices and rooms for a few of the girls who actually live in the building. Twenty girls work at the club, although they may not all be on shift at any one time. Seven girls, including Sara, Fatima and Lilli, live in the building. Other employees include assistant managers, some errand and pick-up boys, and assistant bouncers and bartenders to cover for Abdullah and Simon. Girls who are not entertaining customers in the private rooms double as dancers, waitresses and drink hustlers. Business at the Nights is always quite good, with regulars and a steady stream of first-timers and tourists. Although M. Joseph owns the brothel, he is answerable to Friedlander Bey. Papa considers the club part of his business empire.

## WHEN GRAVITY FAILS

### AYESHA AND M. JOSEPH

**Ayesha, Fixer:** Ayesha is the Madame at the Silken Nights. She used to dance in the Silken Nights when it was just a typical Budayeen club. M. Joseph eventually promoted her to a "managerial" position.

Ayesha is a sculpted beauty in her mid-thirties. She is generally competent and collected, used to the Budayeen and its tribulations. She is congenial to customers and fair to employees, but she can be icy and hostile if irritated.

INT 9, REF 6, TECH 5, COOL 10, ATTR 10, LUCK 7, MA 5, BODY 6, EMP 8, BTM -2, SAVE 6.

Streetdeal 5, Personal Grooming 6, Wardrobe and Style 7, Streetwise 3, Human Perception 4, Persuasion and Fast Talk 5, Seduction 7, Social 5, Perform 3, Dance 3, Accounting 5, Education and General Knowledge 2, Business 2.

Cyberware: none.



**Monsieur Joseph, Corp:** M. Joseph is the owner of the Silken Nights, and various other properties in the Budayeen and the city. He is a part of Papa's empire of influence and business. M. Joseph is known to Budayeen residents only by his first name. He is a French expatriate somewhere in his fifties; graying, but healthy and robust. He generally keeps aloof from his employees in the Budayeen, letting Ayesha handle day to day matters at the Silken Nights. If the characters talk to him he will be brusque and impatient.

INT 8, REF 7, TECH 6, COOL 7, ATTR 8, LUCK 4, MA 7, BODY 8, EMP 6, BTM -3, SAVE 8.

Resources 2, Personal Grooming 2, Wardrobe and Style 4, Intimidate 3, Leadership 2, Social 6, Education and General Knowledge 6, Expert: Business 6, Arabic 4, French (Native), Driving 2, Pistol 2.

Cyberware: Corymbic implant with moddy plug.

and an outgoing person. Fatima, the ambitious teenage harlot, was twenty year old Rashid, the most traditional and devoutly religious of the three brothers. Of the three, Lilli is closest to her original identity. Her love for the fictional young man of her "secret" past is a redirection of Salmin's love for the daughter of the Lechin family.

important clients and even M. Joseph. There is even a rumour that Papa himself may stop by to wish Ayesha a happy birthday.

---

### PART ONE: THE PARTY

---

#### PREPARATIONS FOR THE PARTY

---

---

### PART ONE: THE FIRST NIGHT

---

**I**t is summer, and the Budayeen comes alive at night, when the heat of the sun has settled to a tolerable level. For much of the city the day is ending, but in the Budayeen it is just getting started. Business is picking up at the local establishments. One such establishment is the Silken Nights, a brothel and club located just off of the main thoroughfare known as the Street. There are many such establishments in the city. The only thing that makes the Silken Nights any different, is that not everything there is as it seems (as several people are about to discover).

It is a special evening for the patrons and employees of the Silken Nights. Tonight is a party celebrating the 34th birthday of the manager, Ayesha. Everyone will be there, including people from the Budayeen,

**T**here has been a lot of anticipation as the date of the party has grown closer. When the day arrives, all of the girls will be made up and dressed in their best outfits. For this night they are not common prostitutes, but the mistresses of a wealthy estate throwing a party for the city's most powerful men.

Ayesha has sent invitations to hundreds of individuals throughout the Budayeen and other parts of the city. The club floor of the Silken Nights has been cleaned and rearranged so that there will be enough room for all of the guests and a buffet. A local band has been contracted for the evening, and their equipment stands ready on the cramped stage. Ayesha has been busy overseeing preparations all day. Although the girls are not expected to take clients this evening, they and the other employees have been asked to help with the set-up. The adventure begins during

the early evening, a short time before the guests are due to start arriving. Although the Silken Nights is in the Budayeen, it is close enough to the gate that those guests from outside the walls should feel comfortable. Most of the guests will, however, be Budayeen residents or frequenters. The party begins at eight in the evening.

---

### THE PARTY

---

**T**he party itself is a subdued affair, with much mingling, talking, eating and drinking punctuated by dancing and birthday salutations for Ayesha. Many familiar faces from the Budayeen will be present, including most of the people from the NPC list in the *People of the city* section. Chiri, Frenchy, Marid, Yasmin, Saied, Hassan, Abdoulaye and others will all put in appearances. Unless there are any incidents, there will be no police officers present. Use the early stages of the party as an opportunity to allow the players to get comfortable roleplaying their characters. It's also a good time for the referee to start getting acquainted with NPCs which might play a recurring role in *Gravity* campaigns. Players can interact with each other and the guests. Simon should be at his station behind the bar. Abdullah should move



about the club keeping an eye open for potential trouble. The three girls will be roaming the club serving as hostesses, talking and dancing with guests.

Ayesha will receive many gifts over the course of the evening, including moddies and daddies, clothes, jewelry, and so on. The highlight of the evening will come at about 10 PM when Papa will put in his brief but long anticipated appearance. Everyone will gather round as he presents his gift to his "loyal and enduring friend" Ayesha. The gift is a necklace with thirty-four diamonds set into a gold band. Papa will promise Ayesha another link with a diamond in it for every birthday she celebrates in the Budayeen.

Papa will also bring gifts to all of the employees of the Silken Nights. The player characters, aware of Papa's power and importance, should be suitably flattered and flustered. Most of the gifts are dresses or jewelry. The only two gifts of importance are the ones given to Sara and Abdullah. Sara will receive the latest Honey Pīlar moddy, which she should be overjoyed about. The moddy will come with a card admonishing her that "The best gifts are those that can be shared with others close to you." The likely assumption at the time should be that the card refers to using the moddy to give pleasure to a romantic partner. Abdullah will receive a card signed by Friedlander Bey which states "The Bearer of this Card is Entitled to One Audience With Friedlander Bey at Any Time, or One Admittance to the Friedlander Bey Estate at Any Time." It does not specify Abdullah by name. After dispensing his gifts, Papa will take his leave, claiming the limitations of his advanced age.

The party will continue until two or three in the morning, by which time the last guests will have left and the employees will be leaving or retiring to bed. It might be worth pointing out that some people will take short breaks from the party for the customary evening and night-time calls to prayer, although many will not. Player characters may have formed romantic attachments over the course of the evening. There's nothing wrong with that. In the case of Sara, it might even be worth encouraging.

**Note:** See the *People of the city* section for information on NPCs not detailed in the adventure.

---



---

## GOSSIP

---



---



As the party goes on, the players will hear the following gossip from the NPCs. The first four items are plot important, the last three are red herrings, and may not even be true. Don't deliver them to the characters in order. You will have fun watching over-eager players trying to tie all of the incidents into one cohesive plot. Papa will *not* be a source of any gossip.

- ✓ A Christian family in the city is in a covert war with a Muslim family of high standing. (Simon is most likely to hear this.)
- ✓ There have been a series of murders in the city. Some have been very cruel.
- ✓ The cops in the city are uptight about something. No one knows what has them on edge.
- ✓ A black market moddy that really fries people's brains is making the rounds on the street. (Sara will hear this from Marīd, who knows of her fondness for moddies.)
- ✓ Reda Abu Adil is ailing, some say close to death. Abu Adil's household is trying to hide it. Look for Papa to make his move soon.
- ✓ Some say that a large number of international mercenaries, many from Europe, have been smuggled into the port on Greek freighters. No one knows why.
- ✓ A new drug is making the rounds. It is called Flare. Everybody wants some, and nobody has any. Apparently there have been some violent incidents between dealers and manufacturers.

---



---

## INCIDENTS

---



---



To provide a little action during the party we have possible incidents. Use as many or as few as you wish, or roll randomly to see which occur. Don't go overboard though, or all of the characters may be in traction

## Papa and his Gifts

The referee should make sure that there is no special emphasis placed on Sara and Abdullah's gifts. The characters will discover the importance of the two items as the adventure progresses. To keep things subtle, roleplay all of the player characters receiving their gifts from Papa, not just Sara and Abdullah. Simon will receive a marvellous leather jacket and a new Arabic language daddy of level +7 (active). (Simon speaks no Arabic, and always uses a daddy. He has been using one at +4.) Fatima will receive a gold bracelet studded with rubies. Lilli will receive a fine silk dress of exquisite workmanship.

The only person who might have questions about his gift is Abdullah. If the person playing Abdullah asks Papa about the unusual nature of his gift Papa will say something like: "Pardon my lack of modesty, O my nephew, but this is perhaps the most valuable thing that I have given this evening. After all, I have no greater or more personal gift than my time and favor." If Abdullah asks "Why me?" Papa will say jovially, "Would you prefer a silken dress? Come my nephew. I pray for Allah to give you long life and prosperity, but who knows when you may need a favor from a less heavenly source." That is all he will say on the matter. Characters should know that it is unwise to press Papa on his motives.

Papa will be at the party only briefly, but he will take the time to throw in some quiet and acerbic comments as to the visibility of alcohol or drugs at the celebration. Along with the admonition that he expects to see an unusually high number of Budayeen residents responding to the calls to prayer on the morrow as they attempt to assuage their guilt. This will be laughed at all around, but sharp characters may notice several normally indifferent Budayeen Muslims responding to the calls of the muezzin for the next few days.

Characters making INT rolls over 15 may realize how truly unusual it is for Papa to appear personally at an event like this. Rumours notwithstanding, most people expected him to deliver his gifts via an agent like Hassan. This information may also come up during gossip at the party after Papa leaves.

## Gossip and Incidents at the Party

It would be a boring party if nothing happened. To liven things up we have *Gossip and Incidents*.



## WHEN GRAVITY FAILS

for the rest of the adventure. No incidents should occur while Papa is present. None will stop the party, although they may interrupt it.

- ☑ Some party guests make advances at Sara, Fatima or Lilli. When rebuffed, they get belligerent.
- ☑ Someone accidentally pops in a dangerous, black market animal moddy and goes on a psychotic rampage until subdued or the moddy is popped out.
- ☑ A big brawl breaks out; either several men over a woman or several women over a man. (Budayeen women can be plenty tough.) Or perhaps over some other petty reason.
- ☑ A wealthy but obnoxious woman makes a pass at Simon. Simon does not like this lady, but she is insistent. After all, why shouldn't she have anything she wants? She may threaten reprisals upon being rejected.
- ☑ Someone claims to have seen a beggar being attacked in a nearby alley by someone acting and speaking as though he was a demon. A quick investigation will reveal little, but this incident is, in fact, indicative of things to come.
- ☑ The *Mutasib* crash the party, which they consider a concentration of vice and an insult in the eyes of God, and sternly lecture everybody on the advantages of virtue. There are many people present, so they will not try anything. They will eventually leave, after vowing to make a note of who was present. Characters who argue with the *Mutasib* may find themselves encountering them again before long.

---

### SARA AND THE MODDY

---

**A**t some point, during or after the party, Sara should want to try out her new Honey Pílar moddy. Since it is possible that the player characters may not sleep alone that night she may have incentive above and beyond that of her addiction, especially considering the

excellent reviews which the chip has been receiving. The moddy will work as normal when inserted, but once removed Sara will get a severe headache and desire nothing other than to go to sleep. If she tries the moddy out early in the evening that may mean that she is out of commission for part of the party. That's OK, though, because things really get interesting the next day.

**Note:** The character Honey Pílar plays in her latest sim is duplicated in the moddy. While Sara wears the moddy, she thinks and acts like Carlotta D'Angou; a Spanish countess trapped in a loveless marriage to a French count during the reign of Louis the XIII. Sara will "seek out" a brave and noble musketeer to show her the love she doesn't receive from her coldhearted and cruel husband. While inserted, Sara receives the skills as detailed for the Honey Pílar moddy in the text

---

### PART TWO: THE REVELATION

---

#### THE NEXT DAY

---

**E**veryone has a hangover. Ayesha has closed the Silken Nights for a day to give everyone time to recuperate. Since the player characters all live in the building, most of them will probably have slept here. A few guests have crashed on the throw pillows in the club room. The place is a mess, and it will require a thorough cleaning before re-opening.

Sara wakes with more than a hangover, however. Something has happened during the night, apparently due to the use of the Honey Pílar moddy. (It will probably be the last one she used before retiring to sleep.) Sara has a terrifying feeling of schizophrenia and anxiety. There are memories in her head which don't seem to be hers. Things stirring in the back of her mind.

At this point Sara must make a series of rolls to find out how many of her old memories she has recovered. She should roll 1D10 once for every memory listed below. A roll under her INT is successful, and that memory is recovered. Failed rolls may not be reattempted. Don't tell Sara what the rolls are for until after she has done them all. Then tell her what her initial memories are.

---

### SARA'S POSSIBLE INITIAL MEMORIES

---

- 1) She was definitely born a boy.
- 2) A hospital...on a gurney...the doctors are speaking a foreign language.
- 3) "She" was of noble or wealthy birth.
- 4) "She" has three brothers.
- 5) "She" has a brother whom she hates, and who hates her.
- 6) "She" was outspoken and confident.
- 7) Another hospital memory...in a dark room...wondering: are my brothers here?
- 8) Running through the dark night as a little boy, and being afraid. Then being comforted by...father.
- 9) "She" was good with weapons.
- 10) "She" didn't want a sex-change.

Sara should not be clear immediately as to whether these are her own suppressed memories, or whether the moddy is defective and they come from there. Was she really a man? If so, who did these things to...him? Her body is fully functional. She has a menstrual cycle, and must use contraceptives. Why would someone give her a full sex-change and suppress her memories and personality? Think of the money involved!

It is important to remember that, at this point, Sara's personality has not been affected, she just has these extra memories. She won't lose her mind, although she should be upset. She will probably be very curious.

---

### THE MYSTERY OF THE MODDY

---

**S**ara should be asking some serious questions now. Expect a lot of role-playing as Sara discusses her problem with her close friends (the other PCs) and the group decides what course of action to take. A few possibilities include



the following. Players may pursue more than one of these courses. The order can make a difference.

**Having the other player characters try the moddy:** This is perhaps the simplest, most desirable and most likely alternative. Especially if Sara considers the double meaning of the card that came with moddy. The card, handwritten by Friedlander Bey, said "The best gifts are those that can be shared with others close to you." Originally that might have been interpreted by Sara as no more than an innuendo. After all, the moddy is essentially a sex toy. It is possible that she is considering other interpretations by now. (If you like, you can drop Sara an appropriate hint if she makes an **INT roll over 15**.) Eventually, all of the girls should insert the moddy. If anyone other than Sara, Fatima or Lilli tries the moddy they will notice nothing unusual. It seems to be nothing more than a high quality Honey Pílar chip. If Fatima and Lilli try the chip they will initially notice nothing strange. But once they pop the moddy out they will get headaches and fall asleep for **1D6 hours**. When they next awake from a period of sleep, they too will have new memories. Most of these will be similar to Sara's, with a couple of key differences concerning their personalities and self awareness. If all three women try the chip it will be a simple matter of deduction (**INT roll over 14**) to realize that it is likely not a chip error. While they are getting similar memo-

ries from the chip, there are too many differences for them all to be off of one template. When it becomes apparent that no one other than the three women develops these symptoms after using the chip the player's suspicions about themselves should switch into high gear. At that point it should be obvious that there is a major mystery to be solved.

**Taking it to Lalla's shop for analysis and research:** The characters may decide to take the moddy to Laila's shop. Laila may be weird, but she knows her moddies. If the players go to the shop they will find the old woman puttering around the store under the influence of a moddy chipped from a hot Pacific Rim pop star. She is speaking broken English with a Japanese accent and has a tendency to break into song. It may take the players some doing to persuade Laila to remove the moddy. If Laila examines Sara's Honey Pílar moddy, she will see nothing unusual. It is in a commercial casing and it bears the markings and serial numbers of the well known European moddy company which carries Honey Pílar's exclusive contract. A check with the manufacturer will reveal that the chip's serial number is authentic and comes from a lot shipped to Cairo for distribution throughout the Middle East. If Laila puts the chip in she will act in a lascivious and provocative manner, fondling herself and groping any men present. This will be really disgusting, considering Laila's

## IN CASE YOU FORGOT...

Remember, in the Middle East women still suffer from the effects of hundreds of years of inequality. In the Budayeen this won't amount to much. Outside the Budayeen it may be a problem. If the women go to the police or try to investigate the matter on their own they are liable to be ignored, brushed off, called hysterical, or otherwise frustrated. In situations where this is likely the characters will benefit by assigning certain tasks to Simon and Abdullah. Don't be bashful, stick it to the girls. It will make for some good roleplay and add a little irony to the adventure.

## FATIMA AND LILLI'S BURIED MEMORIES.

If Fatima and Lilli try the moddy, they will have the same symptoms as Sara did, and their unearthed memories will be very similar. There will be some differences however. They should roll on the same system as Sara. Memories 1-5 and 10 are the same as on Sara's table. Memories 6-9 are different.

### FATIMA

- 6) Your eighteenth birthday, which should still be four months away!
- 7) Had a deep love and respect of Allah and Islam.
- 8) You were betrayed by someone...
- 9) You were fascinated by machines.

### LILLI

- 6) A beautiful girl that you were in love with. A Christian?
- 7) A dark plan which scared you to your very soul.
- 8) Parents that you loved deeply.
- 9) A deep love of books and knowledge.

advanced age and decrepit condition. When the moddy is removed she will rave about the programming and sensual detail, but claim (truthfully) to have noticed nothing unusual about it. She will not display any unusual symptoms. She might make an offer to buy the chip based on its stellar performance.

Going straight to Friedlander Bey to find out what the deal is: It is possible that

## WHEN GRAVITY FAILS

the characters might storm off to Friedlander Bey's place to find out what the story is. The characters should probably know that Papa is not enamored of receiving uninvited guests. But if all three women have developed bizarre symptoms from the chip, and the characters are feeling nervous and frustrated, they may attempt to cut straight to the heart of the matter. Abdullah's card may also provide incentive to pursue this path. If any or all of the characters go to Friedlander Bey's estate they will be turned away unless they invoke Abdullah's card. If they do invoke the card they will be told that only one person may use it, and they will have to decide who. The others should leave immediately. This last will not be a request. If the characters send a representative in, this person will indeed be granted an interview with Papa. The characters' representative will be told that a secret meeting between Papa and all of the player characters must be arranged. Papa will not reveal anything about the Honey Pîlar chip, but he will say that he told the other characters to leave the vicinity of the estate for their own safety. He will ask for this information to be relayed to the rest of the characters, and he will tell them to expect his emissary. If the three women have not all tried the moddy, Papa will state that a meeting can take place only after they have done so. He will then have the character ushered out of the estate and driven back to the Budayeen.

---

---

### ASKING AROUND

---

---

**I**t is also possible that the players will decide to do a little investigating to see if they can uncover any inconsistencies in their pasts. The three women all remember coming to the Silken Nights at about the same time. Simon and Abdullah were both already there. Neither Simon nor Abdullah remembers anything odd about the girls' arrival, except that they were all hired within the space of a week. That, however, is not at all unusual at a brothel. Ayesha will say much the same thing if asked. "You all came looking for work within the space of one week, and I thought 'Allah preserve me, business will be good.' It was a fortunate coincidence as near as I can tell." Any of the player characters with good Human Perception rolls may be able to detect some stress about Ayesha when she is asked about the girls' history. They

### WHAT IS AYESHA HIDING?

If the characters are sly, they will notice that Ayesha gets a little jumpy when the characters ask her about their history. If the characters notice that Ayesha seems tense, they may try to pump her. Ayesha will crack only when pressed or threatened. **Characters will be making Interrogation and Persuasion and Fast Talk rolls against Ayesha's COOL and INT rolls respectively. Make the roleplay good.**

If Ayesha breaks down, she will reveal that she was well paid by some anonymous individual to hire the three girls and monitor their well-being. She was warned not to dig into the girls' past, nor to try to discover the identity of their "benefactor"....upon pain of death. A couple of months ago she confessed the circumstances of the girls' hiring to

Friedlander Bey; the first time that she had discussed it with anyone. The anonymous man demands reports on the girls' welfare once every month. He claimed that he would know if Ayesha lied to him. Ayesha is now afraid for her life. What will she tell the man next time he calls? This situation is her own fault! Ayesha may get a little hysterical if she is forced into revealing all this. The players will have to deal with this however they can. It is to their advantage to raise as few ripples as possible. Also, Ayesha would be a good person to keep as an ally. If the characters don't get it on their own, and you want to drop a clue, an **INT roll over 17** will allow the characters to deduce the connection between Ayesha's confession to Papa, and Papa's presentation of the moddy.

will have to **beat Ayesha's COOL roll** to see it however. No one else can remember anything unusual about the girls' arrival or hiring. Monsieur Joseph is not part of the day-to-day operation of the brothel, and won't even know when the girls were hired.

If the characters get really curious, and start trying to ferret out stuff about the girls' histories, they will discover that things begin to break down under scrutiny. For instance, none of the girls can actually locate any members of their supposed families or any friends from before two years ago. This should stoke the fires of curiosity quite a bit higher. Successful investigation will require **Library Search rolls over 20**, and possibly other rolls depending on how the characters go about it.

---

---

### PART THREE: THE TRUTH

---

---

**A**t this point, the three girls should be developing a pretty good idea of what they were, though not exactly who or why. If all three have tried the moddy and are beginning to recover memories it should be fairly obvious that they were brothers. Then someone had *this* done to them. Simon and Abdullah, while not directly connected, are involved by way of their friendship with the girls. If the characters have already tried to contact Papa, then they will be expecting his emissary. If they have not tried, then the emissary's arrival may be a bit of a surprise. At any rate, sometime during the evening of the day

after the party an envelope will be delivered for Sara. The envelope will contain a letter asking the three girls, along with any friends who are aware of their new state of mind, to come to a site outside the city the following day. Remember: requests from Papa are not turned down lightly!

---

---

### THE MEETING WITH PAPA

---

---

**h**ow the characters get to the meeting place is up to them. Maybe a ride in Bill's taxi. If the characters arrive at the meeting place at the appointed time, they will indeed see a large Bedouin tent set up in the middle of the grove, screened from the road by the date palms. This is not unusual. Desert nomads who have dealings in the city frequently camp in this area. On this day, however, there is only one tent, and it is a safe bet who it belongs to. At the entrance to the tent the characters will find one of the Stones That Speak. If the characters introduce themselves he will tell them, "Wait." He will duck briefly inside the tent, and then return and lead the characters inside.

Bedouins may use tents like this, but it is doubtful that any Bedouin ever had a tent as luxurious as this one. The air inside is cool and comfortable. A thick carpet is spread over the rough ground. Upon this is a large table. To one side is a smaller table with fruit and coffee. At one end of the large table sits Friedlander Bey. He will motion to the characters to be seated. "O



**THE LETTER**

The letter was written by Hassan the Shiite, Papa's emissary to the Budayeen. It reads as follows:

*My Darlings,*

*Our master and protector, Friedlander Bey, has recently taken an interest in your predicament. He would be most gratified if you would honor him with a visit to the palm grove by the highway on the south edge of the city tomorrow at noon. Look for a tent in the fashion of the Bedouin. He regrets the inconvenience of the location, but he wishes you to know that it is for your own safety. There are those who would harm you to prevent this meeting, and few people should know of it. Please bring any friends who are aware of your situation. Papa wishes to aid you in the solving of your mystery, and offer you an opportunity to reclaim your rightful heritage. I pray for your health and success.*

—Hassan

*If the characters have already gone to Papa's estate, there will be an apology for turning them away. It will mention that it would have been dangerous for the characters to have been spotted entering or leaving the estate.*



picians into high gear. A quick consultation with Dr. Lisân, the city's resident modular tech and neurosurgery genius, revealed that it would be possible to permanently suppress and replace someone's entire personality, but that the technology was experimental, and only a few people had the expertise to implement it. Dr. Lisân also knew how implanted personality templates could be revealed, and he cooked up the doctored Honey Pilar moddy which did it. The girls' presence and symptoms confirm Papa's suspicions. Papa has discovered who the characters really are. The unfortunate thing is that the girls, and anyone who knows their secret, is in terrible danger (this obviously includes the other player characters). The fortunate side is that Papa is willing to do something about it...

**WHAT IF THE CHARACTERS GO ON A DETECTIVE KICK BEFORE TALKING TO FRIEDLANDER BEY?**

Players obviously have their own ideas about how things should go, and it's quite possible that the player characters could maneuver events so that Papa can't reach them. They might also ignore Papa's summons, although this is not recommended. If this is the case, the characters may decide to find out for themselves what happened to the three girls rather than waiting for Papa's explanation. Or, even after they hear Papa's story they may be suspicious enough to pursue matters on their own. So here are some facts they might uncover with clever **Streetwise**, **Library Search** and **Interrogation** roles. Roll difficulties will vary depending on who the characters talk to and how intelligently they go about their investigations. Use your best judgement in assigning difficulties. Make the characters role play in the course of their investigations, don't just ask them to make the skill checks. Remember the cultural stigmata about women!

**FACTS THAT MIGHT BE UNCOVERED:**

- Two years ago a wealthy Shaykh died in his estate on the outskirts of town, leaving four sons. Several weeks later, the three younger sons died in a tragic fire and were buried in closed caskets.
- Shortly thereafter, a prominent doctor at the el-Amir hospital died in an auto accident.
- Several months later there was an upsurge in a certain type of black market moddy, many of which contained blasphemous personalities.

If the characters unearth this information they may want to examine the bodies. They will have to bribe and talk their way into being able to covertly exhume the bodies. If they get to the bodies and get dental impressions or skeletal information and compare it with the brothers' old dental or medical records, they will be able to prove that the three bodies are definitely *not* the brothers! Things will then start falling into place. This will not help the sisters recover their memories however, and they still have no proof that they are the

my beloved, it pleases me that you accepted my invitation. Blessed be Allah that you are well. We have many things to discuss. But first, share with me a cup of coffee." Papa will motion to one of the Stones, who will pour coffee for everyone. Papa will exchange a few pleasantries while the coffee is consumed. Only when people are getting started on their second cups will he get down to business.

**PAPA'S REVELATION**

**P**apa will reveal his speculations to the player characters. His address is directed principally at the three women, but the other PCs will also find it interesting. Especially as they will learn that they may have become targets too!

Papa will tell the player characters that, after Ayesha made her confession, he tied the three girls' appearance to the death by fire of three sons of a wealthy family at an estate in the city. A background check on the girls failed to reveal any history further back than two years. This threw Papa's sus-

**WHAT REALLY HAPPENED.**

**H**abib had three tourists murdered in the Budayeen. Two days after the brothers were drugged and sent to NuesDeutschland, Habib had the fire set at the compound. He substituted the murdered tourists' bodies for the brothers'. He then paid off the medical examiner to certify the identity of the bodies. To cover these tracks, the doctor was killed shortly thereafter. As far as anyone but Habib and the Eye know, the bodies in the caskets are those of the brothers.

## WHEN GRAVITY FAILS

three brothers....unless they have their teeth compared with the brothers' records. If they do this, it's a whole new ball game. They'll still need Papa's help to get their memories and bodies back however, and Papa will still contact them. Unless the player characters do something dumb, like rushing off to confront Habib, Episode Two will go as written. If the players do rush off to confront Habib, they will be in trouble, as they have few applicable skills and no equipment. See Episode Three.

---

### EPISODE TWO:

### THE DEMON

---

**I**f the players agree to Papa's deal, at the end of the episode their memories and bodies will be restored. The manufacturing site for the blasphemous moddies will also be uncovered, and Habib implicated. The key events are the recovery of the demon moddy, the arrangement of a meeting with the moddy supplier, and the discovery of the warehouse.

---

#### PART ONE: PAPA'S DEAL

---

**N**ow the characters know the truth about themselves. Papa will make them a proposition. But first, he will tell them of a problem he faces. Everyone is still at the tent.

"O fortunate ones, I too have a problem that needs attention. Any person who knows me knows that my devotion to, and love of, God can not be questioned. It grieves me to see the names of Allah and the Prophet, may the blessings of Allah be on him and peace, cast down by the irreverent. New black-market moddies have been sweeping the city, especially the Budayeen. Many of these moddies are of a blasphemous nature, offensive to all who follow *Sharia*, the straight path. Some contain templates of people who abhor the true God and the Arab people: crusaders of the twelfth century and criminals of the twenty-first century. There are reports of chips of Aaron Bergman, a sociopathic Zionist cult leader who was personally responsible for the rape and murders of over thirty Palestinian women in the Israeli-occupied territory in the early twenty-first

century. This chip has already been implicated in the murders of several local women. Even worse, there are chips of creatures out of our faith. Evil *afrit* with no compassion for the living." Papa will pause for a second. "Perhaps worst of all. There is a chip which attempts to mimic the personality of..." an uncharacteristic expression of anger will spread over Papa's face, "...of the Prophet, may the blessings of Allah be on him and peace." Papa will pause to let this sink in. It should be emphasized to the characters that this is most blasphemous indeed! Papa will offer more coffee and fruit to the player characters, and then continue.

"Many believe that responsibility for these moddies lies with the Lechins, a prominent, local Christian family. They are known to have holdings in electronics and modular technology. I disagree. I have business dealings with the Lechins. They are sensitive to the delicacy of their position as a religious minority in this area. I do not believe that they would do anything to jeopardize their position. I have secretly conferred with experts who have had a chance to examine some of the black market moddies. They all agree that the templates are remarkable, the work of a gifted expert. The same kind of expert who could have created the moddies which altered your memories and personalities. One name is suggested by my sources: the Eye of the Star. Unfortunately, no one knows who this individual is or what he looks like, and thus he is impossible to trace. I believe that your alteration and the appearance of these moddies may be related, and that your elder brother and this "Eye" may be connected. But no proof exists as yet. This is where you come in."

"We are in a position to help each other. As long as you appear as women, your brother will believe you to be of no danger to him. Meanwhile, my own interests are threatened and Allah is offended. This is my offer: you will trace these new moddies to their source and report the location of that source to me. In return, when this is done, I will finance you three to have surgery to recover your memories and personalities, and return you to your true genders if you wish. I will also see to the protection and compensation of your friends here. This may also offer you a chance to avenge yourselves and reclaim your rightful positions and heritage."

Now it's up to the characters.

---

### THE CHARACTERS' OPTIONS

---

Big time decision for the characters. They can...

- Accept Papa's offer, in which case the three girls will return to the Budayeen and continue to live their "lives" while secretly searching for the manufacturer of the black market moddies. Continue with adventure as written.
- Refuse Papa's offer and go storming off to wreak revenge upon Habib. If this happens, the characters will have to face Habib's estate as detailed in Episode Three. Best of luck, as the three girls have little in the way of combat skills, and Simon and Abdullah are but two individuals.
- Flee the city and live out their lives elsewhere. End of adventure.

---

### BACK IN THE CITY

---

**A**ssuming the characters accept Papa's offer, the girls will be back in the city before sundown, and will have some thinking to do. Remember at this time the girl's memories of when they were men are faded and dreamlike, almost unreal. The last two years are the only time they truly remember. This will most likely cause some concern among the characters, who might prefer a life they know to a shadowy phantom in the mind.

Back at the Silken Nights, Ayesha has been contacted by Hassan, who has instructed her to give the characters the next couple of weeks off. With pay. While not entirely happy with the loss of income, she will be less upset when the promised "reimbursement" arrives from Papa, four one-thousand kiam notes.

The players will still be allowed to live on the premises, as Habib will continue calling to check up on the girls on a regular schedule. And Ayesha will continue to report nothing out of the ordinary.



**NOW WHAT?**

**A**t this point in time the actions the characters take are up to them. If they have agreed to Papa's deal they will probably be out scouring the streets for information concerning the manufacturing of the black market moddies. Below we have provided a list of clues, and where they might be found.

**Frenchy's:**

1. One of the dancers was mauled by an unknown man on her way home last week. The man claimed he was a servant of Shaitan.
2. Two days ago some crazy tried to attack Nikki. She had to break his jaw, nose and one leg before he finally gave up.
3. Several bodies have shown up in the canal with "unmarked" moddies in their skulls.

**Chiri's**

1. One of the girls was given a moddy to chip in by a new customer. When she tried it on she claimed to be the reincarnation of the Prophet. Chiri took the thing out and smashed it with a hammer. When it was removed, the girl returned to normal.

**Big Al's**

1. Al had to use the tommy gun on some nut who smashed into the bar waving a wicked looking knife. The police reports say his brain was totally fried.
2. Several moddies with the impressions of animals on them are making the rounds. Some even have standard store marks on them.

**Police, and the Hospital**

1. Crimes of passion have been on the rise for the last three months.

**THE DEMON**

A few nights after the meeting with Papa a girl named Kalima will come stumbling into the Silken Nights. Kalima is an employee and resident of the brothel, and someone with whom the girls are friendly with. Kalima's clothes are torn and she is bruised and scratched. She is terrified and near hysteria. She will seek out Abdullah.

"O master, help me please! A demon is after me...in the alley nearby...he wanted to kill me! To offer my soul to Shaitan!"

Kalima will collapse into a sobbing heap. After she has settled down a little, she will be responsive to questions. She will tell the characters that she was attacked by an Afrit, an Arab demon. The creature stalked her, and dragged her into a nearby alley. It had tremendous strength and terrible, twisted facial features. The creature was babbling about raping and killing her as a sacrifice to Shaitan. By a miracle she managed to break free and escape, but the creature screamed after her that it knew where she lived and it would be back to pay her a visit that night.

Once again the characters will have several things that they can do. Remember, no matter what action the players take, the demon will come to the Silken Nights that evening.

**Check out the alley:** If they do this they will find nothing other than Kalima's discarded handbag and some scraps from her clothes.

**Call the police:** The police will take an uninterested view towards the whole thing. They been having problems with berserk moddies for a while, and they suspect that this is another incidence of the same thing. Without the perpetrator, or at least a good description, they will claim that there is little they can do. If the characters are insistent, the police will send out a man to interview Kalima. He won't learn anything that the characters don't already know. The police will not offer any protection, just an exhortation to call them if they get a description or get a hold of one of the moddies.

If the players press the policeman (a process that will be made much easier if they bribe him, or one of the girls buy him a couple of drinks,) he will reveal that the department has been having trouble with pirate moddies for a while. The problem is

that, although they have several of the chips on hand, they have been unable to trace them to a manufacturing site. They have also been unable to take any suspects alive, and consequently have not been able to trace the chips back through dealers. They had undercover officers trying to buy the chips on the black market, but their cover was blown by a departmental leak and the police have been at an impasse ever since. They are not willing to sacrifice any more officers for a problem which is common only within the Budayeen.

**THE COP'S CLUE**

**T**he characters may not pick up on it, but when the cop mentions that their undercover officers are being killed or exposed, he reveals that there must be a mole somewhere in the police department. While this is not uncommon in the city, the characters would do well to remember it later. If the players miss it, and you feel benevolent, have the characters make **INT rolls over 17** to pick it up as a clue. It could make an interesting aside to the adventure.

**Set a Trap for the Demon:** This is the key option. Kalima is begging for people to stay the night with her. She is terrified that the demon will make good on his threat to come and get her. The characters should realize that this event is tied to the very matters which Papa wants them to investigate. A perfect opportunity! How the characters choose to arrange themselves is up to them. Go on to the next section.

**TRAPPING THE DEMON**

The characters will need weapons; non-lethal ones if they are smart. Fortunately, Ayesha, a Budayeen realist, keeps a supply on hand, including two seizure pistols and two heavy needle pistols. As bouncer, Abdullah has access to the weapons. Characters can divide them amongst themselves as they see fit.

Remember that Sara and Lilli have no applicable combat skills, and while Fatima may know how to use a gun, if the demon gets his hands on her she would fare no better than any of the other girls. To this



## WHEN GRAVITY FAILS

### HASHEMI THE DEMON

Hashemi is the man wearing the demon moddy. Without the moddy he is tough, but not remarkable. With the moddy (and associated daddies) he is vicious, evil and powerful. These are his stats without the moddy.

INT 6, REF 8, TECH 4, COOL 7, ATTR 6, LUCK 7, MA 7, BODY 9, EMP 7, BTM -2, SAVE 8.

Streetwise 5, Persuasion and Fast Talk 4, Awareness 1, Hide/Evade 2, Brawling 5, Dodge and Escape 2, Handgun 2.

Cyberware: Corymbic implant with moddy plug.

**The Demon Moddy (Type 1):** The moddy makes the wearer cunning and sadistic. The wearer becomes an *afrit*, a servant of Shaitan, seeking to rape, torture and kill his victims in sacrifice to the dark lord. The wearer feels

invulnerable and has decreased sensitivity to fatigue and pain.

- ☑ Difficulty: 36.
- ☑ Moddy Cost As Built: 2000 Kiam.
- ☑ +3 COOL, +1 REF, +1 BODY, EMP to 2, +2 resistance to Interrogation and Intimidation.
- ☑ Included Daddies: Melee Weapons +6 (Active), Stealth +3 (Active), Torture +5 (Active), Expert: Islamic Lore +4 (Active).
- ☑ Total Daddy Costs: 810 Kiam.
- ☑ Total Package Cost on Black Market (reflects popularity, availability): 2300 Kiam.

end, try and encourage the girls to use their wits, and leave the heavy work to Simon and Abdullah.

True to his words, the demon will pay a visit that night. Kalima's room faces the back of the building and has a fire-escape balcony. At about 3 A.M., the demon will scale the fire-escape and attempt to gain entrance to Kalima's room. If the window is locked he will attempt to jimmy it silently. If any characters are stationed nearby, have them make Awareness rolls vs. the demon's Stealth. If the demon fails to jimmy the window he will break it with his fist, unmindful of the damage to his hand. Once in the room he will look for Kalima. If she is not there, the Demon will silently case the entire brothel until he finds her, or someone else. If the demon comes upon someone else, he will fly into a rage, attacking them and demanding to know where Kalima is. If the brothel is deserted, the demon will go berserk, tearing the place up and then fleeing.

If player characters corner or ambush the demon they will see that he is indeed a normal man under the influence of a moddy. His face is twisted into a grotesque leer. The characters will be surprised if they get into a fight with the demon. Although he looks like an average individual, he is possessed of incredible strength and endurance. He will attempt to flee only if wounded and obviously outclassed.

### POSSIBLE OUTCOMES

**I**n the course of the evening the characters may find themselves in the following situations:

**The demon is incapacitated, but alive:** This is the ideal situation. The players can recover the moddy and question the man who was wearing it. With the moddy out, Kalima will recognize the man as one of her regular customers, someone she has long known is infatuated with her. A Budayeen local known as Hashemi. That would explain both the demon's preoccupation with Kalima, and why he knew where she lived and slept. If grilled, the man will reveal that he bought the moddy from a black market dealer known as Mohammed ben-Yussuf.

**The demon is dead:** Kalima will still recognize him, but the characters won't have a lead back to the dealer. In this situation, it may be time for another visit to Laila. In fact, even if the characters take Hashemi alive they may want to take the moddy to Laila for examination. A word of warning: if the characters want to find out more about the moddy, Laila's first impulse will be to chip it in. If the characters allow her to do that, then they, and Laila, may be in trouble.

If Laila checks out the moddy, she will be able to tell them only that she believes it was made locally. There are no serial numbers or labelling. She will say that she has recently bought moddies that she believes

were manufactured by the same people. She will give the characters the name of a man who sold her a moddy in a similar casing, an expatriate Frenchman named Michel D'Angelou, a shopkeeper in a local furniture souk. That moddy was supposed to be a sexual aid. If any of the characters try the moddy that Laila bought from D'Angelou, or if they can persuade Laila to try it, they will discover that it is a sexual aid but that it also involves bondage and torture.

A little Streetwise and some detective work will uncover Michel D'Angelou's home or work address. (Difficulty at Ref's discretion based on how the characters go about it.) If D'Angelou is grilled, he will reveal that he also bought his moddy from Mohammed ben-Yussuf. He sold it because it was too violent for him. D'Angelou is not a confrontational man, and he will not offer any resistance to the characters. His COOL is 7.

**The demon escapes:** This will make some work for the characters. If the demon escapes, they can try to shadow him to his apartment. If the demon had to punch through the window of Kalima's room, the characters may be aided by the blood from the Hashemi's hand. If the characters successfully shadow the demon, they will find that he lives in an apartment in one of the slimier areas tucked back near the walls of the Budayeen. The characters can attempt to capture him at the apartment. If they go in anytime that night there will be a 70% chance that the demon has removed the moddy and a 30% chance that he is still chipped in.

If the characters fail to shadow the demon they will have to do some sleuthing. The demon knows where Kalima lives, right down to the room. That makes it likely, although not certain, that it is a customer or friend. Given a little time, Kalima may be able to place the demon's face. She has a 40% chance of remembering who it is within the next 24 hours. If she sees the demon during the course of the fight her chance goes up to 60%. Kalima gets one roll only, and if she fails she gets no further attempts.

There is one more way that Kalima could get an edge on identifying the demon. The main obstruction to her memory is that she was terrified when she was in the presence of the demon, and she still gets scared recalling the event. Sara is a moddy addict, and an expert in the kinds of chips available. There are hypnosis moddies which can make people able to recall the details of events

Yussuf's supplier will call back the next day with the details of the meeting. The call will come directly to ben-Yussuf's little portable phone. If anyone other than ben-Yussuf answers, there is a 50% chance the supplier will hang up. If ben-Yussuf is alone when he takes the call, he will warn the supplier what is going on. He will then tell the characters that the call never came. This will send the characters back to square one, and the Ref shouldn't do this to his players unless he feels really mean. As long as the characters are present, ben-Yussuf will stick to the plan. The meeting will be set up for the following day, at six in the evening at a Budayeen club called the Casbah. By way of a code, the woman will ask ben-Yussuf "Did you find a red cloth bundle on the street outside?" The correct reply is "No, but I saw a small child running away with one."

At this point the meeting is set up. Depending on how things go for the characters, they may or may not have ben-Yussuf on hand for the meeting. If the characters do have ben-Yussuf there are a couple of tactics they can try. The characters ultimate goal should be to find out who the supplier is. Almost all skill checks in this section will pit the characters rolls directly against those of the woman and her goon.

The characters want to follow the representative: If the characters decide to try this option they will have to make sure that the meeting between ben-Yussuf and the veiled woman is undisturbed. It is vital that the woman not be suspicious when she leaves. The characters will have to be very low key about observing the meeting and will have to make sure that they are not detected while trying to shadow the woman. The characters will also have to remember that the woman is going to have a nearby goon watching over things too. The goon will be somewhere in the club during the meeting, and will rendezvous with the woman only after the meeting is over. They will walk out of the Budayeen and drive away in a car parked nearby. The goon is behind the wheel.

If the characters successfully shadow the woman after the meeting, they will trace her to a warehouse in the dock area. The warehouse belongs to a company called All-Mediterranean Shipping. If the

much better than they could normally. Police use them. It is possible that Laila has one in stock. If not, one of the high priced stores on the boulevard might. Sara will have to make an INT roll over 14 to recall this possibility. If Kalima uses the chip she will have a 90% chance of identifying her assailant, even if she has already failed once. A little detective work and Streetwise will then enable the characters to find out where the demon lives.

If all of these options fail, the characters will have to wait. The demon will eventually strike again, or Laila might eventually come up with some information in return for a little baksheesh.

### TRACKING THE SOURCE

If all goes well, the characters will have learned the identity of the dealer Mohammed ben-Yussuf. ben-Yussuf is a well known black-market moddy dealer, and it will be easy for the characters to track him down. (**Streetwise roll over 17.**) It will not be so easy for the characters to pry the identity of his suppliers out of him. Apparently the suppliers threatened to kill him if he revealed any information about them. The characters can use whatever methods they like to get ben-Yussuf to divulge the information. Possibilities include basic Interrogation, forcing ben-Yussuf to wear some of his own black-market torture chips, seduction, threatening him with Papa's wrath, or just a plain, old-fashioned thrashing.

When properly coerced, ben-Yussuf will reveal how he contacts the source who provides the demon moddies. When he needs new stock he dials a special phone number and leaves a message on a voice mail system. The supplier calls him back within 24 hours to take his order. The supplier names a date, time, location and a code phrase. At the appointed time, ben-Yussuf goes to the selected meeting place; usually a local club or coffee house. The supplier's representative is always a woman in full veil and gown. ben-Yussuf has never seen her face, and suspects that she is not always the same person. She always appears alone, but ben-Yussuf has no doubt that she has a muscleman nearby in case things get dicey. They exchange a little polite talk, then ben-Yussuf gives her the money and she gives him a satchel with the order in it. That's all. ben-Yussuf will admit that, of all his suppliers, these people take the most precautions.



### MOHAMMED BEN-YUSSUF

Mohammed ben-Yussuf is a Budayeen Fixer and black-marketeer. He is small, stout man in his forties. Mohammed will be under duress from the characters from the beginning. During his entire association with the player characters he should moan and whine about how his business is being destroyed and his life threatened by the characters' schemes. At the core of it all Yussuf is a cowardly man, and he will wilt under pressure from the characters. He will also bolt if given a chance. Yussuf will become violent only if his life is directly threatened.

INT 6, REF 7, TECH 8, COOL 5, ATTR 4, LUCK 7, MA 4, BODY 8, EMP 7, BTM -3, SAVE 7.

Streetdeal 8, Streetwise 8, Persuasion and Fast Talk 6, Awareness/Notice 5, Hide/Evade 2, Brawling 3, Handgun 5, Melee 1.

Cyberware: Corymbic implant with moddy plug.

Carries a seizure pistol.

### SETTING UP A MEETING

The next move is setting up a meeting between ben-Yussuf and his supplier's representative. ben-Yussuf will be reluctant to do this, since it will put him in the firing line and destroy one of his hottest suppliers, but the characters should be able to convince him to see things their way.

Provided ben-Yussuf doesn't screw up vastly, or the characters don't kill him while interrogating him, setting up the meeting with the supplier's representative should be no problem. After ben-Yussuf makes the call, the characters will have to wait a day before the supplier calls back with the details of the meeting. The characters will have to keep a tight reign on Yussuf at all times, perhaps even locking him up. If they give him a chance, he will escape and disappear. This will make life rough for the characters.



## WHEN GRAVITY FAILS



woman or her assistant ever catches on to the characters she will lead them on a wild goose chase until they're sure that they've lost them. If the characters realize that the woman is trying to shake them, they may want to abandon subtlety and try to capture her. See below.

If the characters are smart enough to get the license number on the woman's car and can squeeze some cooperation out of the police, they will find that the car is regis-

### THE CASBAH

The Casbah is a typical, dark Budayeen club. This one, as the name might suggest, is popular with Morroccans, Algerians and other Maghrebi. The proprietor is a huge Moroccan named Ahmad. Ahmad is used to trouble in his bar, and will usually let the customers sort it out amongst themselves unless they start to damage the club. Then he suddenly becomes very dangerous. If the characters start tearing up the club during the fight they may suddenly find themselves facing a large, angry Ahmad in addition to the woman and her henchman.

**Ahmad**

INT 6, REF 8, BODY 10, COOL 6, MA 4.

Melee 7, Handgun 2, Brawling 8, Dodge and Escape 1.

Keeps a big club under the bar.

tered to All-Mediterranean Shipping. A little investigation will turn up the location of their local warehouse and offices.

The characters attempt to capture and interrogate the woman: The characters might choose to forego the risk of tailing the woman and merely capture her and squeeze the information out of her. The moddy suppliers never reckoned with their woman being attacked by five people, so she has only one goon for escort. That goon is, however, quite tough. The woman is no pushover either. The characters would do well to remember that they're no better off than when they started if both the woman and her goon are killed in the fight.

Assuming either the woman or the goon is captured they can be pressed into revealing the location of the warehouse and the identity of the company that owns it. They will also reveal that they are employees of All-Mediterranean Electronics. It won't be easy, but a little Interrogation or Intimidation may do the trick.

---

### WHAT IF THE CHARACTERS LOSE THE WOMAN AND HER GOON?

---

**T**he characters will be set back quite a ways. They will have to locate another black market moddy dealer and set up another meeting. ben-Yussuf's credibility will be shot. If the woman and her henchman caught on to the characters shadowing them or escaped an attack the next meeting will be even tougher. Expect the representative to show up with multiple henchmen and take strict precautions against being attacked or followed.

---

### THE CHARACTERS' NEXT MOVE

---

**T**he characters would do well to remember one thing at this point: they are two men and three girls, nor do they have access to special weapons or vehicles. If they try to heroically storm the warehouse, shut down the operation and take prisoners, they will meet with a simple and obvious fate.

They'll be killed like the idiots they are.

This is Gravity, and big, climactic combat is not the way to do business. The characters will get a chance for something similar in a little while. What they should do is report



### THE WOMAN AND HER HENCHMAN

**The Woman, Fixer:** The woman who delivers the merchandise to Mohammed ben-Yussuf is nothing more than courier. She has no special knowledge of the black-market manufacturing ring or its leaders. She does work out of the warehouse where the production is based. The woman is under orders to be cautious at all times, and to avoid revealing the location of the moddy production facilities. She will remain loyal unless her life is threatened.

INT 8, REF 8, TECH 6, COOL 9, ATTR 9, LUCK 5, MA 7, BODY 5, EMP 8, BTM -2, SAVE 5.

Streetdeal 7, Resist Torture/Drugs 2, Streetwise 5, Seduction 4, Persuasion and Fast Talk 6, Awareness/Notice 4, Hide/Evade 3, Dodge and Escape 2, Brawling 3, Melee 4, Handgun 4, Modular Tech 6.

Cyberware: Corymbic implant with moddy plug.

Carrying a seizure pistol and a knife.

**The Henchman, Solo:** The henchman accompanies the woman at all times. He stays out of sight when the woman is dealing, keeping watch on her. He will respond when he gets a hand signal from the woman or on his own initiative if she is threatened. Long on brawn, short on brains.

INT 5, REF 9, TECH 2, COOL 10, ATTR 5, LUCK 6, MA 8, BODY 10, EMP 4, BTM -3, SAVE 10.

Combat Sense 4, Strength Feat 5, Intimidate 6, Resist Torture/Drugs 3, Awareness/Notice 5, Hide/Evade 4, Shadow/Track 3, Athletics 4, Brawling 6, Handgun 6, Melee 8, Stealth 5, Driving 5,

Cyberware: Corymbic implant with moddy plug.

Carrying a needle pistol and a knife. Wearing an armored t-shirt, SP 10.



# AMS

## ALL-MEDITERRANEAN SHIPPING

If the characters successfully follow the woman, trace her car, or interrogate her or her henchmen they will discover that she operates out of a warehouse owned by a company called All-Mediterranean Shipping. The warehouse is easy to find. It is a large, two-story building with production, storage and shipping facilities on the ground floor and offices on the second floor. A little investigation (**Library Search roll over 17** or talking to the right people) will turn up the fact that All-Mediterranean is a legitimate local shipping company that does good business with Greek and Italian principalities. If the characters dig deeper they will find that the majority owner for the last two years has been the brothers' betrayer, Habib ibn-Ali al-Yemen. This will help to prove Habib's involvement with the illegal moddies.

The warehouse is well guarded, and everyone entering or leaving is likely to be checked out by guards toting needle guns or seizure pistols. If any of the characters do successfully sneak in, they will discover that there is indeed a complete moddy recording and production facility within. Rolls to get into the warehouse will be vs. the guards skills.

**All-Mediterranean Guards, Solos:** There are ten armed guards stationed in and around the All-Mediterranean Shipping warehouse. The guards carry seizure pistols and knives.

INT 6, REF 8, TECH 5, COOL 7, ATTR 5, LUCK 5, MA 8, BODY 8, EMP 6, BTM -3, SAVE -8.

Combat Sense: 4, Handgun 3, Melee 5, Brawling 5, Dodge and Escape 3.

Cybernetics: Corymbic implants.

their findings to Friedlander Bey. They have traced the source of the black market moddies to a company, and fulfilled their part of the bargain. The next move is up to Papa, who is the man with the resources to deal with the problem. If your players are used to standard gun-toting roleplay they may require a little coaching before they realize this. If they want to try and sneak into the warehouse for a better look, they're welcome to try, but they may be risking their lives. One way or another, proceed to Episode Three, which will allow the characters to tidy up the loose ends and realize their dreams of returning to their proper positions and lives.

---

## EPISODE THREE: THE END OF THE BLASPHEMY

---

### RE-TRANSFORMATION

---

If the characters accepted Friedlander Bey's offer then things will be set in motion very quickly. Two nights after the discovery of the manufacturing plant, the three girls will be put on a chartered plane to Neues Deutschland. There they will be greeted by Dr. Lisân, along with German modular tech and reconstructive and cosmetic surgery specialists. They will go into surgery that very same day. All will have their implanted moddies removed. Prep for sex-change (for those who wish it) will also begin immediately, although it will be a month before the surgery for that can be performed. The characters will have to be out of the country for ten weeks total. This time

should not be played out. We will assume that it is hitch-free, except for possible surgical complications (see box).

While the characters are out of the country, Papa will arrange a scheme with Ayesha to cover their absence. Three of Ayesha's other girls will be paid off and given minor cosmetic surgery to make them look like the sisters. This will be done before Ayesha's next call from Habib. Ayesha will continue to report everything normal to Habib while the characters are away. The three stand-in women should help to maintain the cover. Simon and Abdullah will return to work while the brothers are abroad. It is essential that everything appear normal at the brothel.

This time need not be played out. Just explain the course of events to the players. Remember Habib won't know that Papa knows where the manufacturing plant is located. Unless the players gave themselves away.

---

### RETURNING TO THE CITY

---

Assuming that there are no problems, the three brothers should return to the city, ten weeks later, as strapping young men possessed of their full memories and old skills. They will *not* look like they did before they were originally transformed. The surgeons did not have enough references to reconstruct them exactly. If any of the brothers have chosen to remain female, they will have the option of regaining their old memories, or forgetting their past entirely. Friedlander Bey will let Abdullah and Simon know of the brothers' return only one day in advance, to prevent any leaks.

## SURGICAL COMPLICATIONS

If you want to inject a little stress into the run, you can have the three brothers roll for possible surgical complications. Each player should **roll once on a D10** for the brain surgery and once for the new sex-changes. On a 9 or less, everything goes fine. On a 10 there are complications. If there are complications, roll 1D10 again on the following table.

**1-2:** Infection. Lengthen recovery time by one week.

**3-4:** Scarring. The operation left some scarring. -1 to ATTR of new body.

**5-6:** Recovery Problems. Lengthen recovery time by two weeks.

**7-8:** In a coma for 1D6 weeks or failure to recover full memories.

**9:** Brain Damage. Loose 2 points of INT and REF permanently.

**10:** Total loss of old memories. Will only remember "artificial" personality.

## WHEN GRAVITY FAILS

### THE BROTHERS AS THEY WERE

If and when the brothers have their implanted moddies removed and get changed back into men they will have new sets of stats and skills and new personalities. The brothers will remember everything that happened while they were women. Players should modify their character sheets accordingly. Outha is a Corp by virtue of the family's business holdings. Until he recovers his estate and fortunes his resource roll can be used to represent assistance from Papa.

**Outha (Sara), Corp:** You were a robust and strapping young man, aggressive and intelligent. You were being groomed to assist Habib in the management of your father's business empire. It was you who conceived the plot to oust your elder brother, Habib. Consequently, you must bear some of the responsibility for what happened to your brothers. There will be vengeance.

INT 9, REF 8, TECH 5, COOL 9, ATTR 9, LUCK 2, MA 6, BODY 7, EMP 7, BTM -2, SAVE 7.

Resources 4, Awareness/Notice 4, Human

Perception 3, Education and General Knowledge 6, Library Search 4, Social 3, Persuasion and Fast Talk 2, Expert: Business 6, Wardrobe and Style 3, Personal Grooming 3, Streetwise 3, Leadership 7, Brawling 3, Handgun 5, Driving 1.

Cyberware: Corymbic implant with moddy plug.

**Salmin (Fatima), Techie:** You are horrified by what has been done to you. As a pious and devout young Muslim, your blood boils at the thought of the indiscretions you committed while trapped in the body of a harlot. But it was the will of God, who knows all. Perhaps there is a lesson in it somewhere. You will not deviate from *Sharia* again. Your love of Allah is matched only by your interest in technology.

INT 7, REF 7, TECH 8, COOL 6, ATTR 10, LUCK 7, MA 8, BODY 6, EMP 9, BTM -2, SAVE 6.

Jury Rig 6, Basic Tech 5, Modular Tech 3, Education and General Knowledge 6, Electronics 4, Electronic Security 6, Pick Lock 6, Driving 4,

Expert: Islam 5, Brawling 3, Stealth 3, Dodge and Escape 2, Melee 1.

Cyberware: Corymbic implant with moddy plug.

**Rashid (Lilli), Student:** A veil has been lifted from your eyes, uncapping a wellspring of emotion. For two years, your love of Catherine Lechin has been trapped by a computer chip, transformed into an electronically perpetuated fantasy. You must get a message to her somehow. But first, you must think of your brothers, and revenge.

INT 10, REF 8, TECH 5, COOL 7, ATTR 8, LUCK 6, MA 8, BODY 9, EMP 7, BTM -3, SAVE 9.

Education and General Knowledge 7, Awareness/Notice 3, Biology 5, Chemistry 5, World History 4, Library Search 6, Physics 3, Athletics 4, Basic Tech 3, Expert Investigating/Research 5, Interview 5, Social 2, Persuasion and Fast Talk 4, First Aid 2.

Cyberware: Corymbic implant with moddy plug.

### BACK IN THE CITY

Assuming everything goes well, the brothers will be back in the city ten weeks after leaving. Hopefully, Papa's cover will still be intact and Simon and Abdullah will be waiting. Unless there has been a major breakdown somewhere along the way, things will be much as they were when the brothers left.

The brothers will be flown in on a privately chartered jet, arriving early in the evening. They will be driven to the Silken Nights right away and reunited with Simon and Abdullah and re-introduced to Ayesha. There won't be much time for celebration however...

### TAKING HABIB

Papa will ask one final favor of the player characters. Now they know that Habib was involved with the production of the black market moddies, Papa will ask the player characters to go and capture Habib and bring him back to Papa's estate. If at all possi-

ble, Papa wants him taken alive, to be made an example of. Papa will provide the characters with whatever weapons and equipment they need, as well as whatever information he has on the current state of Habib's estate. Papa tells the brothers that once Habib has been taken, the estate will fall to them. The characters should move against Habib that night, at the same time that the warehouse is being raided.

Remember, if the characters take Habib at the right time he will have no warning that anything is coming. If the characters allow themselves to be delayed, Habib may get warning from the warehouse that the whole thing has broken wide open. The players should also remember that Habib has no idea that the characters are no longer women. Make the role-play worthwhile, it ought to be a good one!

The people playing the three brothers should be reminded that all their memories are intact. They therefore know the layout and defense systems of Habib's estate. After all, it used to be theirs too. This will give the combined group of characters an advantage in defeating security systems and patrols and make it easy for them to find their way around.

### THE AL-YEMEN ESTATE

The al-Yemen estate is a large, walled compound on the edge of the city. The walls conceal a landscaped area and a spacious, two-story mansion. There are front and rear gates. The gates are wired with alarms, but the wall itself is not. Unfortunately, there are no convenient ways to scale the wall from outside. The characters will have to jury rig something if they want to try that approach. Habib has guards posted at the front and rear gates as well as two guards roving the grounds and one in the house. The roving guards have dogs. The characters can try to bluff the guards, but the guards may very well contact Habib for confirmation of any admittance. Skill checks to scale the wall will vary depending on what method the characters use. If they confront or try to evade the guards the characters will have to roll vs. the guards' own skills. Penetrating gate security systems takes an **Electronic Security roll over 25**. The characters get a +4 to Electronic Security rolls and +3 to Hide/Evade if the brothers are present.

If the characters make it past the walls and exterior guards, they will have to get into the house itself. The house is also pro-



## WHAT IF THE COVER-UP FAILS?

It is possible that Friedlander Bey's cover-up of the brothers' absence could fail while the characters are away. This may not effect the brothers while they are gone but it could have direct repercussions on Ayesha, Friedlander Bey and Simon and Abdullah. If the cover-up is discovered (which is likely if the players exposed themselves at the manufacturing facility) here's what might happen:

Ayesha must go into hiding, possibly with Papa's help. Otherwise Habib may have her killed or interrogated. If interrogated, Ayesha may reveal Simon and Abdullah's involvement. If this happens then Simon and Abdullah may receive a visit from Habib's goon squad. Alter-

natively, you may have Simon, Abdullah and Ayesha all together when the thugs strike.

If the cover-up is blown, the climate may be a little different when the brothers arrive home from Europe. Instead of being able to secretly pursue an investigation the mayhem may erupt immediately. It may alter the story-line of the adventure, but it could be lots of fun anyway.

Now the characters know where the illegal moddies are being made and have proof of Habib's involvement, at least on some level. He will tell the characters that he will have the police department raid the warehouse and shut down the operation the next day.

Now you'll find out how alert your characters are. Do they remember the hint they got from the cop in the last section? Someone in

the police department was tipping off the moddy manufacturer and exposing undercover cops. If Papa simply has the police raid the warehouse, the manufacturers may get some advanced warning. While it's doubtful that it would be enough for them to move or salvage the operation, it might give some key people time to escape. If the characters tell Papa of the probable leak, Papa will have some private mercenaries raid the warehouse and burn it to the ground.

Whether Papa has the police or mercenaries do it, the black-market moddy ring will be shut down. The blasphemous chips will stop appearing on the Budayeen market. The Lechin household has been cleared by Habib's involvement. The characters will have accomplished one of their primary goals.

tected by an electronic security system. Rolls to defeat the security system at the house are the same as at the gate. If any of the alarms are tripped or any of the guards are alerted, exterior floodlights will come on and all of the guards will coordinate to search the compound. Habib will also be alerted. This will make the characters' job much tougher, but still possible. How the characters choose to penetrate the estate and take Habib is entirely up to them. The guards will do nothing to endanger Habib unless he personally orders them to forego his safety.

Habib will be asleep in his room when the players strike. (This could change if the characters are delayed and he gets a warning call from the warehouse. In that case, it is quite likely that he will have fled, with a large portion of the family's money.) Habib will have a girl with him, but she won't be good for much other than hysteria and general color (at least initially). Habib keeps a needle gun in his nightstand and he will use it, even if the brothers have revealed themselves. If the brothers reveal themselves Habib will be skeptical at first. His calls to Ayesha have revealed nothing unusual, and his spies have reported that the girls are still working at the brothel. (This assumes that Papa's coverup of the brothers' re-transformation was successful.) The brothers can convince Habib by revealing personal facts about their past. Once Habib is convinced he will try one final time to persuade the brothers and their friends to join him. He won't know that he's been put out of business unless the characters tell him.

## PEOPLE AT THE AL-YEMEN ESTATE

Talk 5, Dance 6, Handgun 1.

### Habib, Corp

Habib is a handsome, tall, strong young man about thirty years of age. He is smart and quick, and will do anything he can to escape his predicament.

INT 10, REF 9, TECH 5, COOL 10, ATTR 9, LUCK 3, MA 7, BODY 8, EMP 5, BTM -3, SAVE 8.

Resources 6, Personal Grooming 5, Wardrobe and Style 6, Intimidate 4, Leadership 4, Seduction 3, Social 5, Persuasion and Fast Talk 6, Awareness/Notice 5, Education and General Knowledge 7, Expert: Business 7, Expert: Black Market 6, Brawling 5, Melee 3, Handgun 5, Driving 4.

Cyberware: Corymbic implant with moddy plug.

### Habib's Girl, Actress:

Habib's girlfriend is a local actress. She is young and beautiful; a natural woman, not a sex-change. Without a moddy she will not be a factor in the confrontation. However, when she chips in the Eye of the Star she will become a force to be reckoned with.

INT 7, REF 7, TECH 5, COOL 5, ATTR 10, LUCK 8, MA 7, BODY 6, EMP 8, BTM -2, SAVE 6.

Perform 7, Personal Grooming 7, Wardrobe and Style 8, Oratory 4, Human Perception 6, Seduction 8, Social 6, Persuasion and Fast

Cyberware: Behind-the-ear implant with moddy plug.

### Estate Guards, Solos

These are the men guarding Habib's estate in the city. They are competent, but unexceptional.

INT 6, REF 8, COOL 8, TECH 6, ATTR 5, LUCK 5, MA 7, BODY 8, EMP 6, BTM -3, SAVE 8.

Combat Sense 4, Intimidate 4, Awareness/Notice 5, Hide/Evade 4, Athletics 3, Brawling 6, Dodge and Escape 4, Fencing 4, Melee 5, Handgun 5, Driving 6, First Aid 4, Electronic Security 2.

Cyberware: none.

Carrying needle pistols or seizure pistols and sabers. No armor.

Dogs: Rottweilers; tough, aggressive, smart, not gun shy. Bites do 2D6. They'll go for the throat and 2x damage.

INT 3 (for applicable rolls), REF 7, COOL 5 (for applicable rolls), MA 11, BODY 6, BTM -2, SAVE 6.

Dodge and Escape 6, Stealth 5.



## WHEN GRAVITY FAILS

### THE EYE'S SURPRISE

What the players don't know is that the moddy that Habib's girl-friend chipped in is the Eye of the Star. The Eye is not, and never has been, a real person. It is the name of a unique moddy with an artificial construct personality originally designed for an unknown purpose. What is known is that the Eye of the Star contains a cold and ruthless personality, plus built-in active and reactive daddies that impart an unparalleled knowledge of modular technology, programming and neurosurgery. It is quite possible that the "Eye of the Star" who originally operated on the brothers was an unwitting accomplice of Habib's or a dupe, or maybe even Habib himself.

The players won't know that the moddy is anything special unless Habib gives it away. As far as they know, it may be nothing more than a Man-of-Action moddy or something similar. Habib, however, will do anything he can to

protect and keep the moddy. This may tip the players off as to its importance. The Eye of the Star was the key to Habib's whole operation; the source of the skills that enabled him to establish his black-market moddy operation. Papa will certainly be interested in this.

### THE EYE OF THE STAR, TYPE 1 MODDY

This is an unusual, one of a kind moddy that must have been assembled by a genius. It contains the personality of a brilliant but cold Modular Technician and criminal, possibly the man who designed it. The moddy comes with several daddies built into it. These may not be removed. There is also space for five optional daddies of the user's choice. Neither this moddy nor the included daddies could have been built by normal methods.

- Difficulty: 50.
- Cost as built: Unknown.
- INT to 12, COOL +3, REF +1, +2 resistance to Interrogation, Intimidation, Persuasion and Fast Talk and Seduction.
- Daddies Built In: Modular Technology (Reactive) +10, Programming (Reactive +10), Electronics (Active) +8, Neurophysiology (Active +9), Medicine and Surgery (Active) +9.
- Daddies Included: Handgun (Active) +5, Brawling (Active) +4.
- Package Cost on BlackMarket: Unknown. Possibly up to 100,000 kiam.

Having taken Habib custody, the characters can try to return him to Papa, except...

---

---

### HABIB'S GIRL

---

---

he players will very likely ignore Habib's girl-friend. Sometime during the course of the confrontation she will chip in a moddy. When she does this, she will suddenly switch from cowering and hysterical to cold and lethal. She will produce a needle gun from the nightstand on her side of the bed and ally herself with Habib. You may want her to do all of this while the players are distracted by Habib. The players won't necessarily know that the girl has chipped in a moddy, but they will know that suddenly they may have a large problem.

---

---

### WRAPPING

### IT UP

---

---

Depending on how adept the players are, here are some possible outcomes.

**The players get wasted:** Too bad. This is, after all, *Cyberpunk*. If the players are dead, roll up new ones, create another adventure and try again.

**The player go off on some unexpected tangent:** It is possible that the players may never make it to confront Habib, or even be restored by Papa. If this happens, feel free to create new adventures around the characters, but remember: Habib will hunt them down if they show any signs of remembering their old lives.

**The players have to retreat:** If the players screw up, they may have to retreat. In this case they will score a partial victory. They've shut down the moddy operation and regained the brothers' estate, but Habib has fled with the bulk of their fortune, and possibly the Eye of the Star. In this case you may want to extend the adventure into a campaign, with the players tracking Habib or getting other work from Papa.

**The players kill Habib:** Papa may be a little put out, but the characters have pretty much done everything that they wanted to do. They've shut down the moddy operation, solved the mystery of the Eye of the Star and regained the brothers' estate and fortune. The brothers may want to spread some of the good fortune to Simon and Abdullah, without whose help they might still be prostitutes in the Budayeen.

**The players take Habib alive:** Maximum experience points for everyone. All of the players goals have been attained.

They've shut down the moddy operation and recovered the brothers' estate and fortune, solved the mystery of the Eye, and taken Habib alive. Now that the brothers are wealthy again, they may want to give some consideration to Simon and Abdullah.

If the brothers take Habib to Papa, Papa will make the following speech before having the police cart him away.

"I do not often take an interest in the internal matters of families in the city, but then few have perpetrated such heinous atrocities on their own blood as you. And if that was not bad enough, you produced these..." Papa will dump a handful of black market moddies on the table, "...which are an insult to Allah and a humiliation to me. Justice will ride heavily upon you."

Habib will reply, "I do not fear the justice of men!"

"Perhaps not, but the Judgment of Allah is infinitely heavier, and I fear that your soul is already lost in the sight of God. Fear the moment of your death, when your soul stands naked before the creator. Take him away!" Then to the characters, "I am grateful for your help. I may call upon you again someday. Now live your own lives for a time, you have earned it."

End of speech, end of adventure. ■



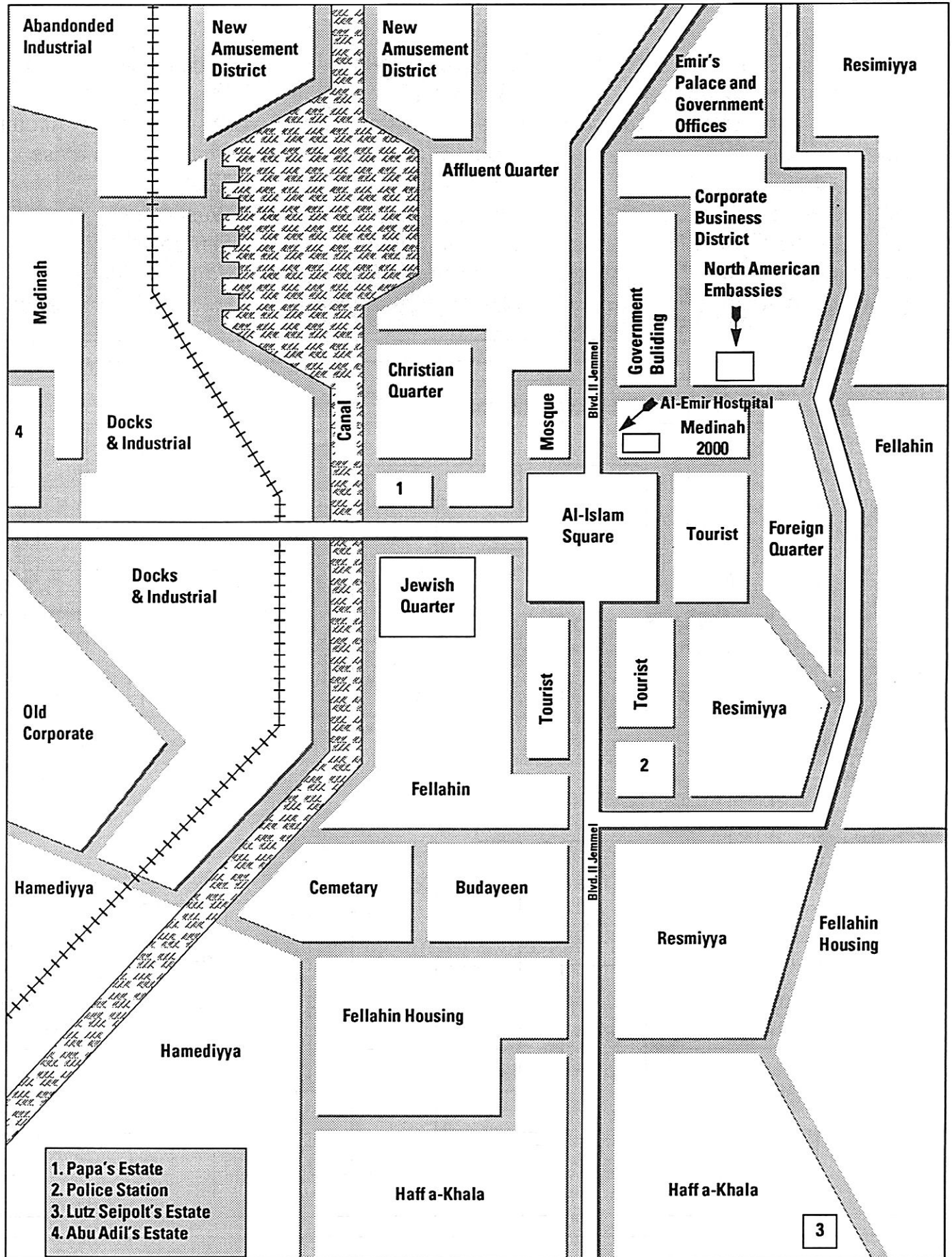

- 1. Papa's Estate
- 2. Police Station
- 3. Lutz Seipol's Estate
- 4. Abu Adil's Estate

- \* Laila's Mod Shop
- A Cafe de la Fee Blanche
- B Tamiko's Apt. / Salah Ad-Din Apts.
- C Eyes of Texas
- D Crazy Abdul's
- E Madam Mimi's Tarot Den
- F Mag-Allah's Newstand
- G Cafe on 2nd St.
- H Cafe 'H' Solece
- I Budayeen Hotel
- J Sea Rey Motel
- K Martyrs-O-Democracy
- L "Cold Tea"
- M The Smoke Shop
- O Houvis
- N Compu-Security
- P The Leather Goddess
- Q Iku Iku Bath House
- R Sensory Deprivation
- S Transpex
- T Double Wisdom Acupuncture
- U Muhammed's Glass
- V Nosfff
- W Vast Food
- X Electroniques
- Y House of Snakes
- Z Freaco's Tattooo Parlor

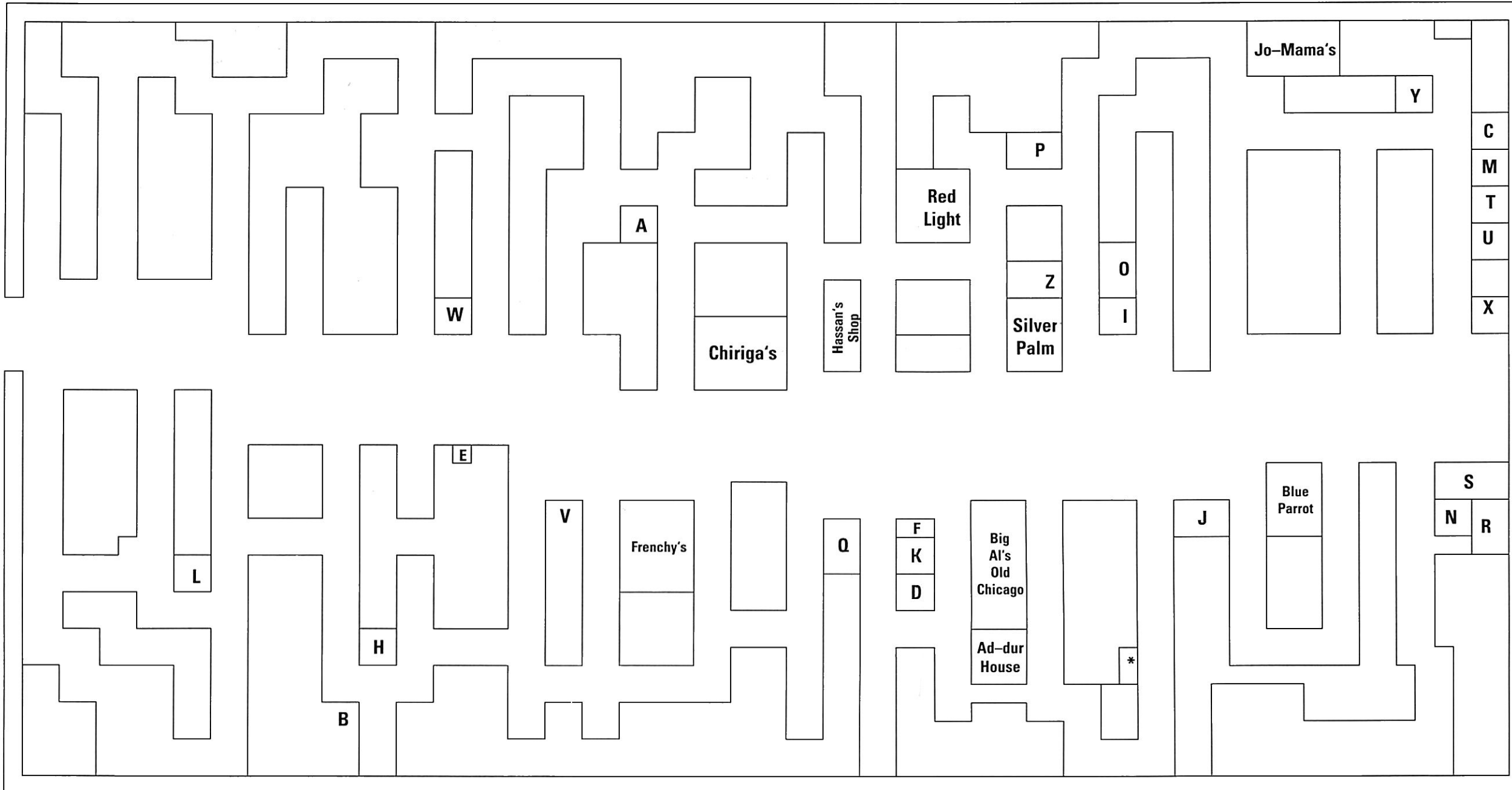
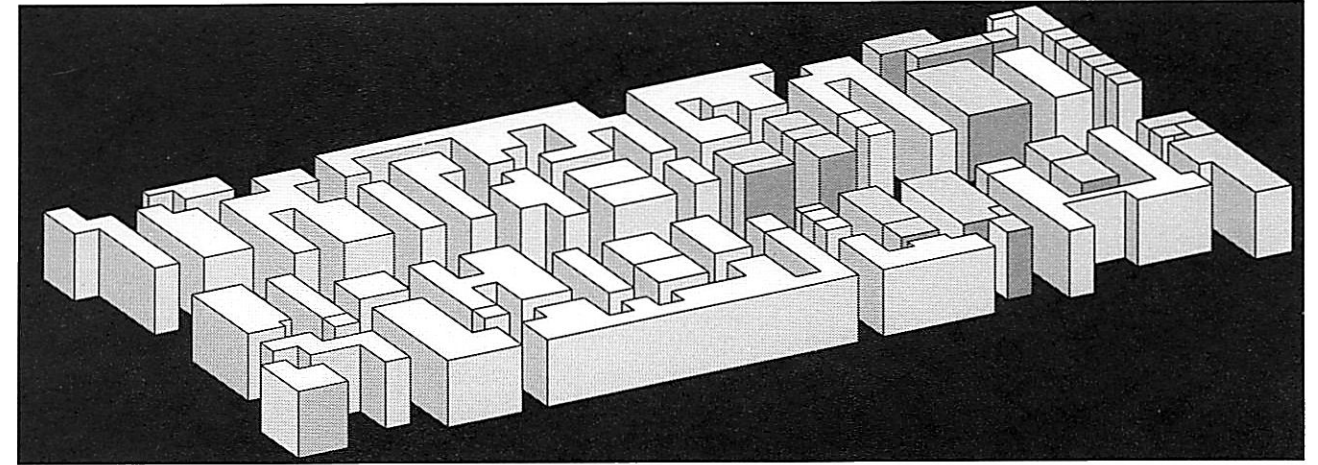

# The BUDAYEEN



**"I smiled. 'I don't carry a weapon, Mr. Bogatyrev. Not usually. I've never been in a situation where I needed one. Either the other guy has one, and I do what he says, or he doesn't, and I make him do what I say.'"**

**-Marid Audran**



## **COME TO THE CASBAH OF 2202!**

**R. Talsorian Games brings you the rules and background to put your campaign into the world of the George A. Effinger novel. This supplement (written with assistance and input by the author) includes a study of Islam in the Future, personality modifying chips, new mind-altering substances, the technology of *WGF*, and a Cyberpunk adventure with a sexy twist...**

**A SUPPLEMENT FOR**

**CYBERPUNK®**

**R. TALSORIAN  
GAMES, INC.**

Published by R. Talsorian Games  
P.O. Box 7356, Berkeley, CA. 94707  
Copyright 1992 by R. Talsorian Games Inc. Cyberpunk® is a  
trademark of R. Talsorian Games Inc. all rights reserved.

**CP 3601  
ISBN # 0-937279-12-9**