

DEEP SPACE

TAKE CYBERPUNK TO THE FINAL FRONTIER

CYBERPUNK

R. TALSORIAN
GAMES, INC.

DEEP SPACE



THE INTERPLANETARY SUPPLEMENT FOR
CYBERPUNK™ 2020

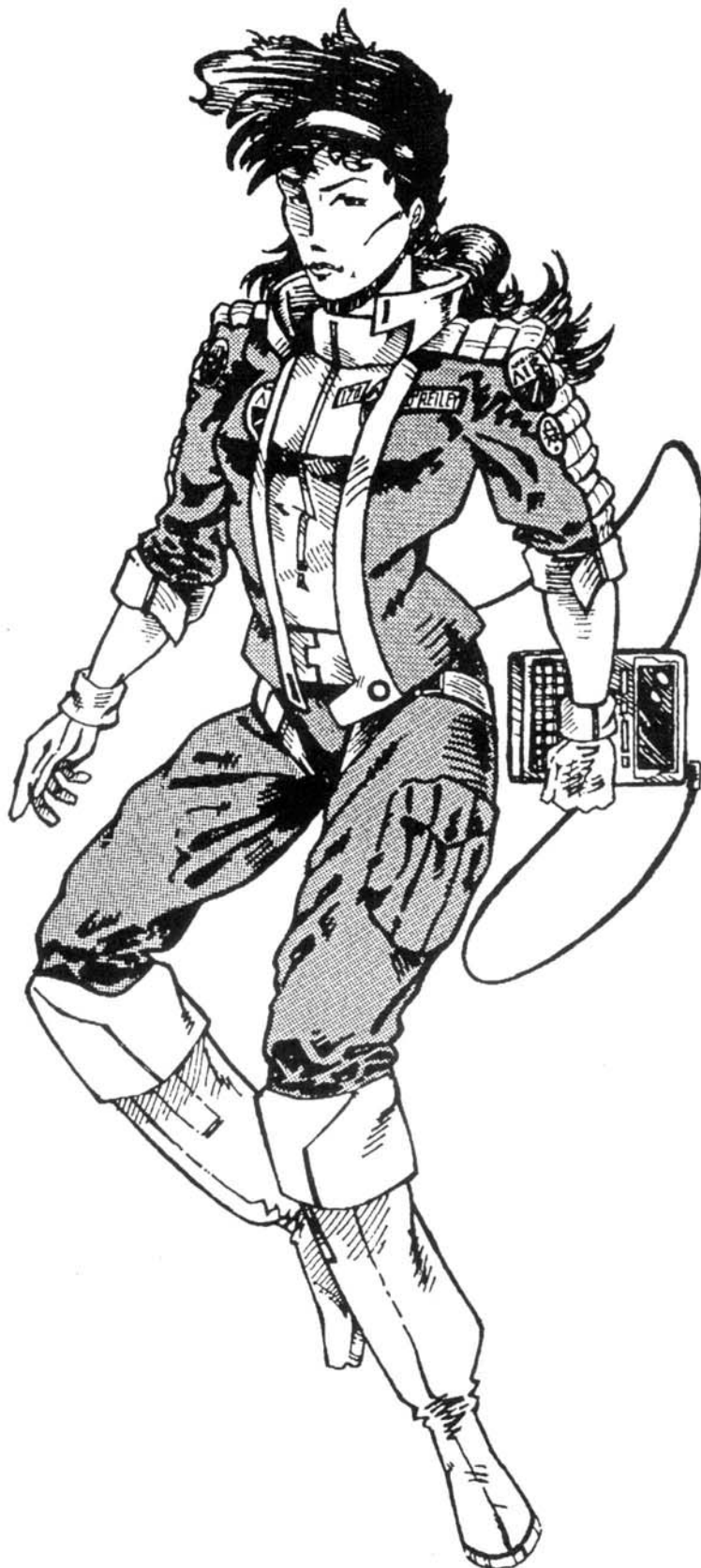

**DEEP
SPACE™**

**The CYBERPUNK®
Space Supplement**

Design
Chris Young
Scott Hedrick

From An Original Idea by
Mike Pondsmith
David Ackerman
Glenn Wildemuth

Editing
Derek Quintanar, S.E.
Janice Sellers

Covers
Doug Andersen © 1992, 1993

Interior Illustrations
Malcom Hee
Paulo Parenté
Matteo Resinanti
Karl Martin
Harrison Fong
Glen Hallstrom
Mike Pondsmith
Chris Hockabout

Layout
Glen "I.C.E., I.C.E., Baby"
Hallstrom

Copyright 1989© R. Talsorian Games,
Inc. All Rights Reserved under the
Universal Copyright Convention.
DEEP SPACE™ and NEAR ORBIT are
trademarks of R. Talsorian Games, Inc.

An R. Talsorian Games Product.
Published by
R. Talsorian Games, Inc.
P.O. Box 7356
Berkeley, CA 94707

Stock #CP 3211

CONTENTS

**Dedicated to —
Gerard K. O'Neill**
For the endless
possibilities

Werner Von Braun
For making the
reality possible.

Mark W. Miller
For making the
possible fun.

ON THE EDGE OF SPACE .. 4

Earth 2025	5
Lunar System Map	7
Who's Who in the Solar System	8
The Solar System	10
World Spaceport Map	11
Planetary Data Table	15
Communication Lagtime Table	15

THE ENVIRONMENT OF SPACE 16

The Triad	17
Atmosphere	17
Radiation	19
Radiation Effect Table	21
Long Term Effects Table	22
Gravity	23
Gravity Adaptation	24
Combat in Zero-Gee	25

GETTING AROUND THE SOLAR SYSTEM 26

Hardware	27
Surface-to-Space Spacecraft ...	27
Surface-to-Orbit Spacecraft	28
Orbital Spacecraft	33
Small Craft	34
Battle Satellites	34
Deep Space Ships	35
Spacecraft Technology	39
Orbital Mechanics in Three Easy Lessons	42
Hohmann Orbit Diagram	42
Hazards of Space Travel	44
Space Combat	46
Communications	48
Psychological Effects of Long Distance Travel	49
Interstellar Travel	49

EQUIPMENT AND WEAPONS 50

Equipment	51
-----------------	----

Vehicles	53
Tools	55
Personal Gear	56
Survival Gear	56
Weapons	57
Newtech 2025	59
Equipment List	59
Bioware List	61

ARTIFICIAL HABITATS ... 62

Workshacks	63
Autofactories	63
Battlestations	63
Orbital Colonies	63
Planetary Bases	65
Habitat Modules	66
Orbital Module Diagrams	67
Ground Bases	68
Crystal Palace Diagram	70
Tycho Moon Base Map	71

LIVING AND WORKING IN SPACE 72

Highriders	73
So What Do They Do?	75
Space Careers Table	75
Orbital Skills	76
The Orbital Character	77
The "Orbitals"—Space-based Corporations	78
Living in the Belt	80
Colonizing New Worlds	80

RED CONFLICT: A SPACE ADVENTURE 82

Part One: Groundside Blues ...	83
Dawn Facility Map	84
Dawn Net Map	85
Part Two: Ticket to Ride	87
Part Three: Home	
Sweet Home	97
Part Four: Mutiny	108
Isidis Net Map	117
Isidis Base Map	118

SELECTED REFERENCES .. 119

1

On the high frontier it takes more than metal to make you tough...

ON THE EDGE OF SPACE

EARTH: 2025

The corporations control the world from their skyscraper fortresses, while armies of cyborg killers roam the shattered urban ruins. The seas are a chemical soup slicked with oil, the skies are black with acid rain, and vast deserts sweep across what was once fertile farmland. The cities of Earth teem with human scum, as fashion models rub biosculpt jobs with battle-armored roadwarriors in the meanest streets this side of Postholocaust.

This is the world of CYBERPUNK.

But only a scant hundred miles above the steaming, polluted atmosphere of the Cyberpunk Earth is another world. Silent and frigid, it is the world of great spinning cylinder-worlds, speeding space-fighters, spider-like orbital vehicles, and the titanic white lattices of the deep space explorers.

This is the world of DEEP SPACE.

THE VIEW FROM SPACE

Motivated by a deteriorating ecosystem and accelerating population growth, mankind has exploded out into the stars. In the Near Earth Orbit Zones the skies are crowded with space traffic: busy orbital transfer vehicles unloading cargos from space shuttles, sleek spaceplanes docking among the spiderweb girders of habitats and stations. There are over two thousand factories in orbit, with automated workstations churning out drugs, plastics, alloys and tools for corporate markets on Earth.

Microwave satellites spread lattice wings to catch the solar wind, converting its energy to microwaves and beaming it down to the power starved millions below. Skirting the outer fringes of the atmosphere, the sinister arrowhead shapes of space-fighters and deltas cruise, seeking

out enemy lasersats with their kinetic kill weapons.

At the stable orbit of L-1, hanging suspended between Earth and Luna, is the huge spinning wheel of the Crystal Palace, Mankind's first true space colony and the glittering crown of the Euro Space Agency's achievements. Looming just beyond at L-5 is O'Neill One: the titanic micro-planet whose cylindrical bulk spans twenty miles (33km), a giant hive of humanity surrounded by myriad OTV's and shuttles. On the far side of Earth from O'Neill One lies the equally massive O'Neill cylinder of Paradise Station; situated at L-4, this is the final cylinder colony, and is eventually planned to extend to approximately 100km in length. Its design already contains the seeds for this further expansion.

On Luna and Mars are self-sustaining colonies, tunnelled into the floors and walls of their respective craters, with miles of solar collectors providing the raw energy to support life on these dead worlds. The mile long tracks of the Luna massdrivers are buried deep within the crater rock, a dark reminder of the time when ESA used them to hurl multi-tonned rocks at the Earth.

Welcome to the Space Age.

IN LOW ORBIT

In Low/Near Earth Orbit (LEO), the traffic is fairly light. Communications, weather and spy sats shift from this zone to Geo-syn Orbit and back as their programmed routines dictate. LEO is also the domain of orbital space fighters and battle satellites, which require closer orbits and a higher degree of manoeuvrability.

GEO SYN ORBIT

GEO-Synchronous Orbit (22,000 miles / 37,000 km) is dominated by orbital workstations, small factories, battlesats (US and USSR), and other stable platforms. It is here that

ground-based spaceplanes and shuttles dock with Orbital Transfer Stations, shifting crews and cargo to outbound Orbital Transfer Vehicles (OTV's).

THE L-ZONES

The "L points" (or LaGrange Stationary Points) occupy stable positions relative to Earth and Luna, making them perfect for long-duration, self-contained bases, factories and construction sites. At the L points orbit the largest space constructions in existence—the roughly toroidal Crystal Palace space station (L-1), the mammoth O'Neill One Habitat (L-5), Paradise Station (L-4), and the smaller Galileo Cylinder (L-3). Behind the Moon sits the L-2 point, home of the ESA's testbed cylinder and deep space explorer dock.

ON LUNA

Since the early 2000's ESA and its allied nations have maintained permanent bases on Luna. The original bases were simple pressure domes and modified workshacks boosted by OTV's and soft landed in sections. Over the last twenty years, these footholds have been expanded through the use of nuclear and solar powered laser-drills (collectors on the surface, and cutting drill below), which have created networks of sub-surface tunnels. Water is provided through the mining of Lunar ice and is heavily recycled, while air comes from sub-surface hydroponic gardens (lit by rolling back huge shutters on the surface).

There are two permanent cities on Luna, both controlled by the Euro Space Agency. Tycho/Luna Colony, the largest, maintains two massdrivers, used to boost Lunar rock and ore out to the L-5 constructions. The population (in 2025) is approximately 18,000. The second colony, at Copernicus, supports a single massdriver, and a population of around 12,000.

TIME-LINE FOR DEEP SPACE

1997

Tycho/Luna colony founded.

2000

Construction of Crystal Palace begun.

2002

Copernicus/Luna colony founded.

2005

First Corporate war. Construction on Crystal Palace delayed as Orbital Air plunges resources into defense of Transworld against EBM. A stalemate results.

2008

Euro-American Conflict runs for only a few weeks before ESA destroys many strategic U.S. offensive positions by hurling Luna rock via the Tycho massdriver.

2009

ESA/Sov Mars mission departs.

2010

O'Neill One construction begins.

2011

Crystal Palace opened. ESA/Sov mission arrives on Mars.

Construction of L-3 and L-4 colonies begins.

2012

First viable nanotechnology achieved concurrently by Euro and Japanese corporate labs.

OUT TO MARS

From 2011, after the landing of the first ESA/Sov joint Mars mission, humanity has maintained a tenuous foothold upon Mars. It was NASA, however, with its ambitious Columbus mission, who established the first permanent colony at Chryse Planitia, with ESA announcing formal completion of their Isidis Base twelve months later.

Since that time NASA has provided a regular series of flights to support the Mars colony. The latest generation of NASA deep-space cyler transports, the Explorer class, are performing the trip in under thirteen months. In conjunction with JAB, the Chryse base has become an important center, currently supporting a population of over 900.

Martian orbital space has become progressively busier over the last three years and now supports its own complement of workshacks and factories for production of materials and components. At least a dozen operating autofactories are known to orbit Mars, with approximately two-thirds of these operated by JAB.

Although all major parties involved on Mars are interested in the possibility of terraforming Mars to reduce the cost of further colonisation, there has been little real progress made in this area. A quasi-independent research organization, known as the Japanese Mars Research Laboratories (JMRL), has constructed a significant research installation at the Martian polar ice-cap. However, the extent of their investigations is unknown.

THE BELT

Tumbling like tarnished jewels, a billion tons of rock and ice spin through

the void between Mars and the giant gaseous Jupiter. Aided by the colonisation of Mars and the prospect of untold mineral wealth a steady stream of robot mining droids, processing factories and foolhardy individuals clutter the solar system's main asteroid belt.

FURTHER OUT

Although mankind now possesses the technology to extend into the outer solar system, the intense cold and inhospitable atmospheric conditions on the outer planets make further commercial expansion unlikely for some time to come. Advanced probes from both NASA and JAB continue to shed new light on the nature of the outer solar system.

Based on data gathered by the 2018 ESA unmanned probe, NASA launched a manned mission to Jupiter in early 2023. The mission is aimed at conducting scientific analysis on both the gas giant and its moons. Curiously, several corporations have taken an unusual degree of interest in the mission and it is believed that NASA may be hiding certain information revealed by the earlier probes. Whatever the information is, it appears to have generated some interest outside of NASA, and rumors speculate that systematic radio transmissions have been detected emanating from the planet. In any event, the expedition should enter the Jovian system in November 2025.

In addition, a joint JAB/NASA unmanned mission is scheduled for launch towards Saturn in 2025 to follow up the Cassini probes. While it will survey the Rings and other aspects of the Saturnian system, the focus for study is said to be the moon Titan.



THE EARTH/MOON SYSTEM, 2025

Name: Van Allen Belt
 Radius: Inner-7717km/Outer-26450 km
 Width: Inner-1365 km/Outer: 8000 km
 Strength:

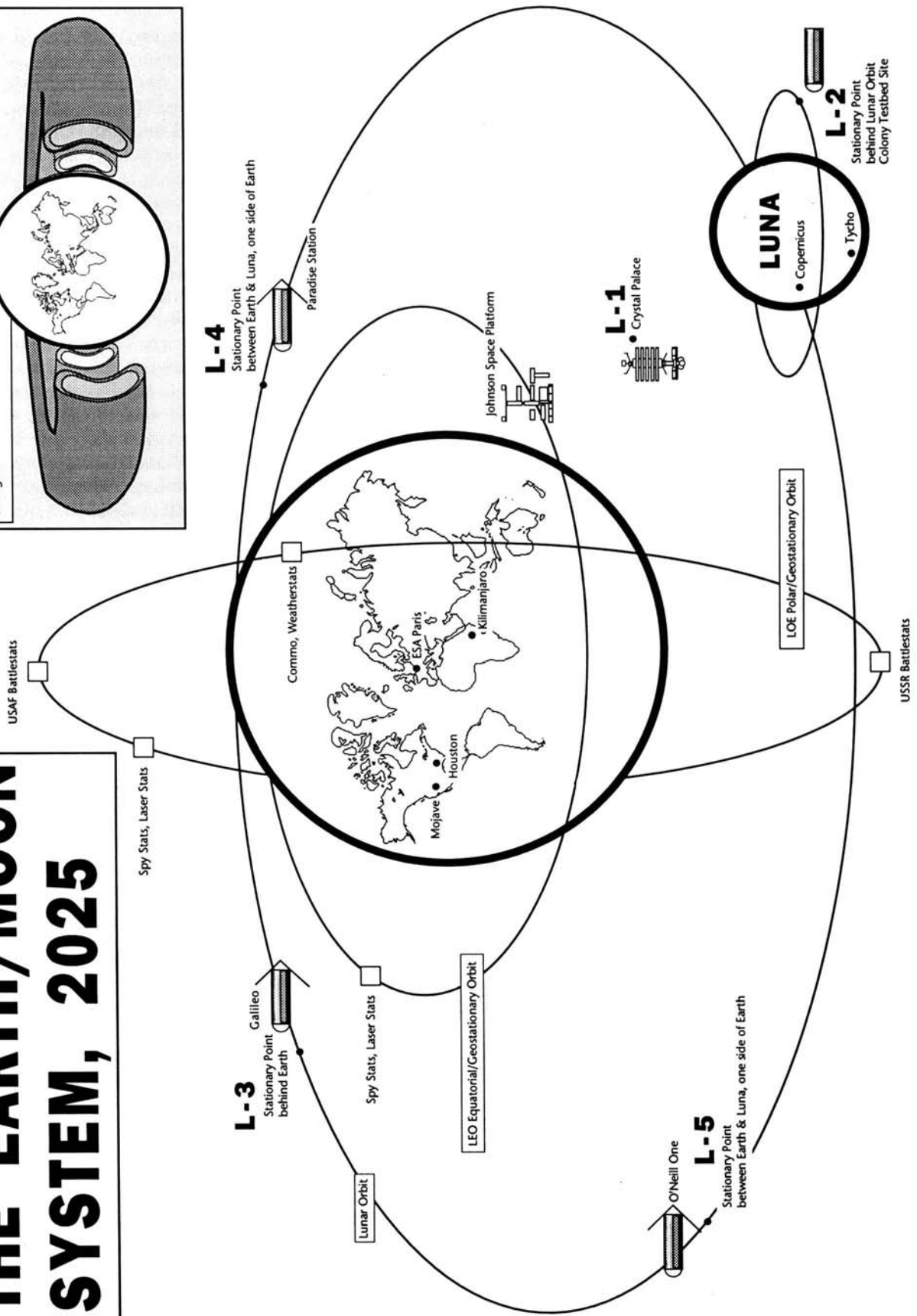

TIME-LINE FOR DEEP SPACE (CONT.)

2013

First "true" AI activated.

2015

Nanotech becomes a commercial reality.

2016

Bioware hits the streets. O'Neill One completed.

2017

First self-aware clones. L-3 colony completed; named Galileo Cylinder (O'Neill Two). NASA Mars mission departs.

2018

L-4 colony completed; named Paradise Station (O'Neill Three).

Second ESA/Sov Mars mission departs.

ESA unmanned probe is sent to Jupiter.

2019

L-5 colony revolt. Highriders successfully repel ESA forces and announce independence. L-4 colony placed under martial law.

NASA Mars mission arrives

2020

Second ESA/Sov Mars mission arrives.

2021

NASA's Chryse Base completed on Mars.

2022

First automated factories appear in orbit around Mars.

WHO'S WHO IN THE SOLAR SYSTEM

In space the only laws are those of physics and the corporations. Both can kill you.

ESA

After its technological coup in 1998 with the Hermes II spaceplane, the European Space Agency looked fit to control most of the rapidly expanding sphere of colonized space. In the same year ESA began the recruitment of millions of people from the central African nations. In an event now known as the **ESA Hireout**, entire African townships were brought into orbit, trained and put to work. ESA took control of LEO for manufacturing and colonization, developing the more advanced Aries series spaceplanes and constructing hundreds of workshacks and the magnificent Crystal Palace habitat (a glittering toroidal playground for the rich).

Since its founding, ESA has focused on orbital manufacturing and has obtained funding from several Euro-multinationals who have traded both raw material and eurobucks for a slice of the orbital manufacturing industry. ESA also implemented a historic deal with the Soviets, who provided heavy lift capacity in return for spaceplane payloads. Orbital Air (the main carrier of personnel into space) was instigated by ESA and is still the only licensed owner of the Aries series spaceplanes.

By 2015, ESA was the largest, richest and most capable spacefaring organization in existence. It creamed a 10% commission off all space-related manufacturing, and controlled most of the law enforcement in LEO and out to Luna through the EEC-controlled Interpol space police. They proceeded to build several major orbital habitats, including three O'Neill colonies (huge rotating cylinders of lunar rock and metal framing several kilometers in diameter).

Unfortunately, as ESA grew and expanded, it became more bureaucratic and authoritarian. The main orbital population (approximately 68%) stemmed from the Hireout and was growing exponentially. These individuals, many born and bred in space, were hardy and individualistic and saw the orbital colonies as "home." This population, known as the "highriders," eventually revolted against the growing pressure from ESA to overcrowd the orbital colonies and force many workers to operate in sub-standard conditions for little reward. This blewup into a series of short but violent clashes between Highriders and ESA known as the "O'Neill Wars," during which ESA lost control of both O'Neill One and the newer Galileo Cylinder.

By 2025 ESA still controls the majority of facilities in LEO. It maintains both Crystal Palace and Paradise Station (an O'Neill cylinder at the L-4 point). ESA also has access to long range drive technology and with Soviet help has set up a Mars Base at Isidis Planitia. All ESA facilities are now kept under oppressive surveillance by Interpol and elite ESA corporate squads to ensure that the O'Neill Wars do not have any successors.

NASA

Faced with budget cuts and the loss of military shuttle payloads to the United States Air Force (USAF) in the late 1990's, NASA became relegated to deep space probes and scientific exploration. The NASA "Galileo" space station was finally abandoned in 2004. This appeared to spell the end for NASA as a serious space pioneer.

The successful commissioning of NASA's deep space-capable Explorer class manned vehicle (based on the Proteus nuclear propulsion system) quickly opened the highway to the outer solar system. The now historic Columbus Mars mission placed NASA, and its familiar technology partner, JAB, firmly into the lead in planetary colonization. This first mission suc-

cessfully landed sixty-three people on Mars with sufficient equipment to construct a small permanent base. Subsequently, NASA has initiated regular Mars flights which leave Earth approximately every fourteen months (this will be shortened to a year very soon).

NASA now provides the majority of the personnel and equipment transport to Mars, including renting payload space (at exorbitant rates) to the somewhat embarrassed ESA/Soviet colony. NASA has also begun using its stable position on Mars as a base for further exploration of the outer Solar System and the Belt. NASA has a manned research station and four mining facilities already in operation in the Belt and several more are planned in the next year.

USAF

The United States Air Force is the premier US space partner. While NASA fought for funding in the 90's, USAF reactivated its X-15 program (linked to the new scramjet technologies of the "Orient Express" program), and created a series of low-and-high orbital fighters designed to knock out shuttles, satellites and workshacks. The USAF has a huge budget for "Star Wars" space technology such as laser sats and kinetic kill weapons.

With the further degeneration of the American situation, the USAF has become a dangerous and unpredictable force. At least three deep space weapons platforms have been commissioned over the last five years. These huge floating "gunships" use NASA's highly successful nuclear propulsion system to provide enormous range and supposedly exist to protect American interests in space (whatever that means)! The USAF has appeared in incongruous places over the last few years in support of several orbital revolutions. Although not yet acting in a blatantly aggressive manner, several other orbital powers (particularly ESA) are becoming uneasy as to the USAF's intentions. Orbital facilities, particu-

larly ESA's major headquarters - Crystal Palace - would be easy prey for a "rogue" gunship.

The USAF is the master in space subversion and military double-think. It has more weapons, spy and laser sats, and armed vehicles than any other orbital power, and is willing to use them. The USAF is also suffering an eclipse of their popularity after NASA's successful Mars colonisation attempts, and are looking for a way to justify its existence (and large budgets), to the flailing U.S. government.

SRC

With the slow disintegration of the United Soviet Block under Gorbachev and the subsequent revolts during the Yeltsin-to-Gorborev transition era, the Soviet Rocket Corps was rapidly demobilized from military to civilian status. In a brilliant move, the SRC refitted nearly 40% of its MIRV missile fleet to heavy payload carriers, leasing them to ESA and other nations. With the best heavy lifting vehicles and the largest body of data on long-term, man-in-space projects, the Soviets were able to trade themselves into the current space frontier boom. They sold advertising on spacesuits, set up construction projects, and eventually established KOSMOSOV, the heavy lifting vehicle combine.

Trading for ESA technical information, the SRC also built up a moderate military presence with orbital stations, spy and laser sats, battle sats and ground laser arrays. The huge laser complex at Sary Shagan has since been entirely converted to laser-lift vehicle support, but can be reconverted within 72 hours.

Still working closely with ESA, the Soviets maintain a strong and active presence in Space. They are clear leaders in terms of raw lift power out of the Earth well and have been enormously successful in construction of long-term life-support systems. The Soviets are also the recognized experts in space psychology. There is a

TIME-LINE FOR DEEP SPACE (CONT.)

O'Neill Two declares independent status.

The "O'Neill war" between ESA and the Highriders occurs, lasting approximately 7 hours. Due to numbers, and the inherent cooperation between workgangers and space-pilots, ESA is forced to rescind control of O'Neill Two. They retain Crystal Palace and L-4 (O'Neill Three).

ESA/Sov Isidis Base completed and a formal colonial government introduced.

2023

NASA begins regular flights to Mars, initially every fourteen months.

Major manned survey effort by NASA leaves for Jupiter.

2025

Arrival of the NASA manned Jupiter mission.

Joint JAB/NASA Saturn study set for launch.

The (soon to be) present.

DEEP SPACE

ON THE EDGE OF SPACE

minimal Soviet presence within the Chryse base on Mars; however, rumours abound that the Soviets are planning their own unmanned missions to Mercury and Venus to set up mining facilities.

JAB

The Japanese Aerospace Bureau traded the ability to mass-produce cheap, efficient workshacks for access to space via ESA spaceplanes. As a result, close to 85% of all workshacks and space stations are Japanese built. JAB has little high-mass or passenger-lift capacity, although Japanese technology helped construct the Kilimanjaro massdriver (the first massdriver was used on a Japanese railroad in the 1980's). The Japanese are also the main manufacturer of heavy colony construction equipment, including their "mobile construction suits," and invented the technology used to create "crete," a mixture of native soils and chemical brew used as a form of high-tech cement in construction of both Luna and Martian colonies.

The Japanese also lead the way in space newtech, diving headlong into the nanotech revolution. Most of the active asteroid mining equipment and life support suits used in the Belt are of Japanese manufacture, and some of the latest technology just appearing from the Japanese research labs into commercial production indicates they are far more technically advanced than many Western corporates had feared.

NASA's Chryse base sports a 58% Japanese presence and current construction of a vast network of living quarters under the existing base is totally regulated by JAB. JAB is also investing heavily in exploration of the Belt, and already has close to a dozen experimental laboratory/factories in operation.

IEC

International Electric Corporation is one of the great survivors of the space revolution and manufactures components (weapons, electronics, polymers,

nuclear reactors, you name it) used by virtually all other major corporations. IEC is ranked as the number five corporation in overall terms; however, they have moved virtually all operations into off-Earth based facilities in preparation for an expected Orbital/Earth war which they fear could see the destruction of the more Earth-bound mega-corps. IEC has taken the lead in this move over both Arasaka and EBM, although these others are clearly pursuing the same shift with vigor. Currently IEC rates as the second largest orbital-based corporate and it has influences throughout the newly colonized worlds. IEC is creating several research stations situated in the belt, although the purpose of these bases is unclear.

UTOPIAN CORPORATION

When Microtech's board decided in the early 2010's to target computer technology, a small team of forward-thinking and frustrated scientists packed their briefcases and slipped out a back door to form their own company. Within five years they had perfected molecular scale techniques and began floating initial prototypes onto the market, mostly small scale healing drugs, skinweave, etc.

Once the base technology was perfected it brought an asymptotic rise in the development of further enhanced products. By 2025 all major corporations are investing in the development of nanotech construction, drugs, computers and in fact anything else. With this astonishing rise in new technology has begun the rise of UC, now the largest orbital manufacturer and corporate shining star. UC's technological capability currently far outstrips any other corporation and some frightening rumours abound about their latest innovations.

UC has begun building facilities throughout the solar system. Corporate insiders suggest that the recent destruction of USAF's flagship *Andromeda*, billed as the most powerful gunship in existence, may have been insti-

gated by UC. Suggestions that UC has begun construction of its own deep space-capable craft have been met with ridicule by UC executives.

SUMMARY

While the USAF still sees space as a battleground, the other orbital players are all investing heavily in space construction and colonization. NASA leads in deep space exploration while ESA maintains the major orbital populations and construction facilities. JAB has the most advanced space construction technology and the Soviets control the largest amount of Earth-based lift capability, as well as expertise in space environments and psychology.

Meanwhile, an entire generation of spacers are growing up in space free of the cultural heritage of Earth, and new corporations are blossoming in an environment that poses new challenges and rewards.

The revolution has come.

THE SOLAR SYSTEM

PLANET EARTH

The once magnificent blue-white orb of Earth has steadily become whiter as persistent clouds of photo-synthetic smog shroud the densely populated land masses. Over 78% of the planet's surface is covered by water or ice, leaving a relatively small percentage to be overwhelmed by a teeming population of billions. The constant generation of pollutants, wholesale destruction of forests, and rampant use of so-called "natural resources" have left the planetary ecosystem in tatters. Less than 10% of the potential animal species still survive in some capacity, many in isolated preserves protected by conservationists, and the number of surviving plant species is currently less than 5%.

The Earth consists of an outer crust, broken into a series of tectonic plates,



WORLD SPACEPORT FACILITIES 2025

NASA

1. Kennedy Space Center, Florida:
Shuttle/spaceplane launch facility
2. Vandenberg Air Base, California:
General vehicle launch facility

USAF

3. Cape Canaveral Station, Florida:
Rocket and Delta launch facility
4. Vandenberg Air Base, California:
General vehicle launch facility
5. White Sands, New Mexico
HELL launch system
6. Edwards Base, California
Delta launch facility

ESA

7. Kourou, French Guiana
Spaceplane launch facility
8. Cairo, Egypt
Spaceplane launch facility
9. Nairobi, Kenya
Spaceplane launch facility
10. Madrid, Spain
Spaceplane/Delta launch facility
11. Rome, Italy
Spaceplane/Delta launch facility
12. Sydney, Australia
Spaceplane/rocket launch facility
13. Dakar, Senegal
Proposed Massdriver
14. Kilimanjaro, Kenya
Massdriver

15. Canary Island

Proposed site of orbital elevator

16. Paris, France (jointly with Orbital Air)
Spaceplane launch facility

Orbital Air

17. Paris, France (jointly with ESA)
Spaceplane launch facility
18. Mojave Field Port, California
Spaceplane launch facility
19. JFK Air Port, New York
Spaceplane launch facility
20. Midlands, England
Spaceplane launch facility
21. Melbourne, Australia
Spaceplane launch facility
22. London, England
Spaceplanes/Deltas launch facility

SRC

23. Plesetsk, Russia
Rocket launchpad
24. Kasputin, Russia
Rocket launchpad/Massdriver (proposed)
25. Baikonur, Russia
General launch facility
26. Sary Shagan, Russia
HELL launch system
27. Moscow, Russia
Spaceplane/Delta launch facility
28. Vladivostok, Russia
Rocket/Delta launch facility

Government

29. Alcantara, Brazil
Rocket launchpad
30. Bonn, Germany
Spaceplane/Delta launch facility
31. Palmachin Air Force Base, Israel
Rocket/Spaceplane launch facility
32. Sriharikota, India
Rocket launch facility
33. Xichang, People's Republic of China
Rocket/Spaceplane/Massdriver (proposed)
34. Tanegashima, Japan
Rocket/Shuttle/Spaceplane launches
35. Tokyo, Japan
Spaceplane/Delta launch facility
36. Hong Kong, China
Spaceplane launch facility
37. Beijing, China
Spaceplane launch facility
38. Nanjing, China
Spaceplane/Delta launch facility
39. Delhi, India
Spaceplane launch facility

Other Commercial

40. Kahili Point, Hawaii
Massdriver (under construction)
41. Cape York, Australia
Rocket/Spaceplane launch facility
42. Christchurch, New Zealand:
Massdriver

below which is the outer mantle of liquid rock, an inner mantle of liquid iron and a solid core (probably iron and nickel). This combination of iron-rich liquid and solid phases creates a strong magnetic field which causes the Earth to exhibit curious magnetic behavior. The Earth has two "radiation belts" which encircle the planet in a toroidal formation beyond the levels of the atmosphere (7717km radius, 1365km width and 26,450km radius, 8000km width). These are known as the Van Allen belts and, although not inherently "radioactive," form a pair of magnetic loops which capture charged atomic particles and present a significant to both personnel and equipment. This places a limit on those areas that may be safely "inhabited" by humans (and animals) and in some regions can damage or reduce the lifespan of electronic equipment.

Earth has one major satellite, Luna, an airless ball of rock cratered by thousands of past meteor impacts. Luna already maintains two permanent human colonies and is heavily mined for raw materials used construction of the large orbital colonies positioned at the LaGrange points. The three massdrivers located near the Tycho and Copernicus craters maintain a steady stream of Lunar materail into Earth orbit. For the colonists, a Lunar working "day" is equivalent to some two weeks on Earth.

MARS

As the planet which most resembles Earth within the Solar System, Mars still presents major differences. Its outer crust is solid, and a large portion of the inner mantles appeared to have colled, resulting in extremely low magnetic activity. Mars is still actively volcanic and the lack of moving tectonic plates allows volcanoes, once they occur, to reach sizes many times larger than on Earth. Many of these volcanoes arise in an area known as the "Tharsis region" and the largest, Olympus Mons, is over 550km across and 24km high. By comparison the largest volcano on Earth is 120km across at its base and rises 9km

above the ocean floor. Valles Marineris at 4000km long, 600km wide, and 6km deep, is a gully that would stretch from LA to New York on Earth.

Many surface areas of Mars show clear signs of water erosion and suggest that huge volumes of water once coursed across the planet's surface; however, there are now few visible signs of this water. Mars has little remaining atmosphere as most of the atmospheric gases were long ago absorbed into carbonated rocks and, as the planet cooled, the water was deposited as ice within the thick outer crust. Because there is no shielding ozone, the surface receives more solar UV than Earth, despite its greater distance away.

The Martian surface is thick with dust which is, at times, raised into dust storms that can cover the entire planet's surface and make travelling extremely hazardous, cutting off the sun for days at a time. Some areas are highly volcanic, while others consist of huge craters from meteor impacts which cause sections of the surface dust, lubricated by trapped water ice, to flow outward forming large depressions.

During winter the polar caps consist of large areas of frozen CO₂. During summer the carbon dioxide escapes into the atmosphere to leave a residual cap of polar water ice, a clear indication that much water (and atmosphere) is trapped within the planet's surface. This fact has long excited scientists and, with the construction of two major colonies on the Martian surface, several teams are studying the feasibility of gradually releasing more of the trapped gasses to revitalize the Martian atmosphere.

Mars is accompanied by two small moons, Phobos and Deimos. Both ESA and NASA have installed small, manned installations on these tiny moons to monitor orbital communications. Use of space on the moons has become an early point of conjecture between the major players in the Martian coloniza-

tion efforts, with ESA, NASA and JAB all claiming rights to some or all of the moons' surfaces. So far the issue hasn't been contested too hotly; however, with only a limited amount of room available, the battle may still be joined.

Mars is on its way to becoming a stable human outpost and its orbital space is becoming cluttered with dozens of man-made satellites and autofactories. The colonies at Chryse and Isidis Planitias are both expanding rapidly and a constant stream of new arrivals bolsters their numbers.

There is one further aspect of the colonization of Mars: Early unmanned probes and NASA "fly-bys" showed several curious formations which appeared somewhat "unnatural." The two most obvious artifacts were the "Cydonia Face," a strangely shaped mountain which appeared to the cameras to be shaped like a human (or near-human) face, and a series of highly regular formations which suggested they may have been shaped purposefully. It was expected that closer inspection would show both of these, and other, phenomena to have been formed naturally. However, research teams from both colonies have studied the formations in detail and have been unable to provide convincing evidence of either natural or intelligent mechanisms having created them. Indeed, NASA's file on these reports remains classified.

MERCURY

The closest planet to the sun, Mercury is a virtually airless ball of rock. It is so close to the sun that its surface temperature reaches 200°C. However, as its axis is nearly perpendicular to the sun, some areas of the pole may be freezing. Mercury rotates slowly, taking almost 59 Earth days for a single rotation, and has only a weak magnetic field which temporarily catches a small amount of the intense ionizing radiation streaming from the sun.

Mercury is unlikely to be viewed as a potential planet for colonization given

the extreme temperatures and high levels of radiation. Along with Venus, however, it is a potential location for unmanned mining operations, especially near the poles. It may be a rich source of less volatile elements, although mining operations within the Belt may provide a much greater return with less expense and risk involved. There is also a suggestion that a large-scale solar power collector/emitter might be assembled in orbit here.

VENUS

Venus is similar to Earth in size, density and position relative to the sun. However, its dense carbon dioxide atmosphere (over 90 times the pressure at sea level on Earth) and high surface temperatures (460°C) make it one of the most inhospitable planets in the solar system. Sulphurous compounds are extremely abundant and observation of the atmosphere indicates that a dense layer of sulphuric acid particles lies between 50-80km from the surface. This witches' brew of gases is lit by continuous lightning storms and stirred by powerful winds (they aren't very fast, but the immense pressure and density give them enormous force). Such conditions have ground the terrain down to a series of rolling plains broken by the rare volcano, of which Maxwell Montes (approx. 12km high) appears to be the biggest.

At this time there is little place for humankind in such an environment.

THE BELT

There are many thousands of "known" asteroids and a vast number of others which have never been catalogued. The largest congregation of asteroids occurs in an area which stretches between Mars and Jupiter and is generally described as the "Main Asteroid Belt". Known as the "Belt" since the dawn of space travel, this collection of asteroids provides a vast array of interest for scientists and corps alike.

The compositions of asteroids vary. They contain a variety of materials and in some cases are rich in metals and

other minerals which are required for modern manufacturing. It is mostly this lure of large amounts of relatively rare (at least on Earth) materials simply drifting in space which motivates many of the major players in space to invest heavily in reaching and monopolizing sections of the Belt.

The largest asteroid in the belt, Ceres, is approximately 930km across and contains over a quarter of the entire mass within the Belt. NASA has already set up two small automated mining "factories" on Ceres which extract raw material and partially process it before using a small massdriver to eject "packages" out from the Belt. They are subsequently collected and taken to Mars for use in construction and manufacture.

JAB has recently begun collecting small, mineral-rich asteroids intact and using "shunt rockets" to accelerate them outside the areas of primary asteroid density.

Working within the Belt is extremely hazardous. Although the Belt itself is in a relatively stable configuration, its component asteroids swarm in random paths, often spinning singly or paired with other objects. Collisions occur regularly, sending clouds of small particles and several larger pieces flying in all directions, sometimes out of the Belt entirely. Any of these particles can puncture a ship or workshack hull. The larger pieces may be many kilometers across and moving rapidly in an unpredictable direction.

For this reason the majority of operations within the Belt are carried out by remotely-operated automated systems carrying the minimum of equipment to extract the required material and remove it from the Belt. It may be possible in the future to set up permanent stations in the Kirkwood Gaps, areas of low object density caused by gravitic resonances with Jupiter.

The table on page 14 lists information regarding the largest known members of the Belt.

THE GIANT PLANETS

Jupiter, Saturn, Uranus and Neptune are entirely unlike the terrestrial planets such as Earth and Mars. These huge objects are virtually giant balls of liquid, without any true "surface", although Jupiter and Saturn both have solid cores many times larger than Earth. At their outer portions these planets are icy, due to their distance from the sun. However, within their liquid portions pressures are immense and these generate extreme temperatures. Under these diverse conditions a number of unusual forms of elements occur— such as metallic hydrogen.

The atmospheres of these planets are chemical soups which blend at the lower altitudes with the liquid planet itself, leaving little or no distinction between planet and atmosphere. Heat generated within the planet's cores generate huge convections of material which rise up toward the surface to cool, before being returned by other rising material. The rotation of the liquid/gaseous planets creates violent turbulences which can be seen as great swirling patterns of clouds.

For now the giant planets remain scientific curiosities which will be increasingly probed and analyzed over the coming years.

JUPITER

The largest planet in the Solar System presents a view of turbulence far beyond any earthly equivalent. The planet's surface is covered by rapidly moving bands of "cloud" which interact in tidal eddies to produce the familiar lines and "swirls" seen from space. The largest surface feature is known as the "Great Red Spot" and is a long-lived storm over 40,000km across which is estimated to have been occurring for over 300 years.

The most important feature of Jupiter for the current generation of spacers is its magnetic field, which is more than 1,200 times larger than Earth's and 19,000 times stronger. This magnetic field causes multiple bands of radia-

Name	Radius (km)	Rotation Period (hours)	Orbital Period (years)
Ceres	457	9.08	4.61
Pallas	261	7.81	4.61
Vesta	250	5.34	3.63
Hygeia	215	18.40	5.59
Davidia	168	5.13	5.67
Interamnia	167	8.73	5.36
Europa	156	5.63	5.46
Eunomia	136	6.08	4.30
Sylvia	136	5.18	6.52

tion, beginning above the upper layers of the atmosphere and extending over 3 million kilometres into space. For much of this area, the radiation is hundreds of times higher than the dose required to kill an unprotected human. Several of its moons (all of the larger ones), including Callisto and Io, reside well within this magnetic field and lethal radiation band.

Jupiter has sixteen known moons, all of which remained locked in a fixed "tidal" orbit due to the planet's strong gravitation, a well defined "ring", and a halo of electrically charged particles orbiting just outside the ring itself. The intense radiation and magnetic levels surrounding Jupiter make its moon system unsuitable for colonization and restrict mining operations because of the damage caused to even well-shielded equipment. The outer moons are generally too small to provide even mining potential.

Nonetheless, NASA has sent a major manned expedition to survey the Jovian system and to drop probes into the upper levels of Jupiter's atmosphere. The DSS *Pathfinder* and its crew of eight will reach the gas giant this year (2025) and the scientific community anxiously awaits the first transmissions.

SATURN

Saturn is in some respects a slightly smaller version of Jupiter. Its atmosphere is similarly disturbed and it shows a "Spot" similar to the Great Red Spot. Saturn's colors are less marked because, being further from the sun and thus cooler, many of the compounds which

provide Jupiter with its dazzling colour do not form on Saturn.

Saturn's magnetic field, although lower than Jupiter's, is still many times that of Earth and it exhibits similar bands of lethal radiation. Saturn has seventeen moons and a complex set of particle rings, many of which can easily be seen, interspersed with "gaps" created by gravitational fluctuations of the moons. Immense electrical activity occurs between the rings as they redistribute charge accumulated via magnetic interactions. Saturn has a large magnetic field, although it is substantially lower than that of Jupiter. The moons and ring system largely lie within the magnetic field and radiation belts.

Saturn is undoubtedly one of the most visually stunning objects in the solar system with many of its rings showing clearly to the naked eye.

TITAN

Titan lies on the fringes of Saturn's magnetosphere and is substantially larger than Luna. Unlike the other moons within the solar system Titan can be considered to have a true atmosphere, consisting mostly of nitrogen and methane which actually achieves pressures of 1.5 times that of Earth. Titan's surface is mostly covered by an ocean of liquid ethane.

Although Titan is relatively cold, its upper atmosphere is warmed by sunlight. The higher pressures and constitution of the atmosphere allow complex hydrocarbons to form and drop to the surface. Although NASA's Cassini

series provided substantial data on the composition and structure of Titan, it appeared to do nothing to confirm or deny suggestions that this rain of organic compounds from the sky may have allowed life to form under the misty haze of Titan's photochemical atmosphere. As a result, Titan has become a major target for the most recent JAB/NASA probe.

URANUS

Uranus is an almost featureless, light blue frozen ball with clouds of methane and ammonia scudding across its skies. It has fifteen moons, several of which are of substantial size (about a third the radius of Luna), and a series of faint rings. Once again Uranus has a substantial magnetosphere which bombards its moons and ring system with radiation and limits their usefulness for human habitation or mining.

NEPTUNE

Similar in size and composition to Uranus but even colder, Neptune shows similar atmospheric disturbances to Jupiter and even manages its own (rather dark) "Spot." Neptune has eight moons, only one of which (Triton) is of substantial size. Being similar in size and composition to Uranus, Neptune's magnetic fields are of similar strength and limit the potential uses for its small moons.

PLUTO

A small ball of icy water and methane twinned with its moon, Charon, Pluto is a frigid wanderer in the outer solar system. Its orbit is eccentric and passes inside that of Neptune for part of the cycle.

Pluto is totally unsuitable for colonization being so far from the sun as to afford no useful amount of solar radiation. It provides little motivation for attempts to reach it even for possible mining. It may, in the future, provide a fuelling point for potential interstellar flights loading up water before leaving the solar system, but so far the only suggestion for its utilization has been as a prison planet for recalcitrant cyberpsychos. It is unlikely to become a popular holiday resort.

PLANETARY DATA

The following table summarizes some information about the major objects in the Solar System. Most figures are given relative to Earth normals, which is far more intelligible to the average spacer than accurate values in millibars and degrees Kelvin. Such figures can be accessed from any data-term if required.

Object	Radius (days)	Rotation (°C)	Gravity Pressure	Av. Temp	Atmospheric Components	Main Atmospheric Composition
Earth	1	1	1	15	1	N ₂ , O ₂ , H ₂ O
Mercury	0.38	58.65	0.28	165	minimal	He, Na, O
Venus	0.95	243.01	0.88	457	90	CO ₂ , N ₂
Luna	0.27	27.32	0.17	@	0	@
Mars	0.53	24.63	0.38	-55	0.007	CO ₂ , N ₂ , Ar
Jupiter	11.2	0.41	2.34	*	*	H ₂ , He, CH ₄
Saturn	9.45	0.43	0.93	*	*	H ₂ , He, CH ₄
Titan	0.40	15.95	0.40	-170	1.5	H ₂ , CH ₄ , Ar
Uranus	4.01	0.75	0.79	*	*	H ₂ , He, CH ₄
Neptune	3.88	0.80	1.12	*	*	H ₂ , He, CH ₄
Pluto	0.18	6.39	0.04	<-250	minimal	CH ₄

Notes:

*Because the giant planets have no distinct "surface" these figures vary widely. Temperatures range from between -270°C at the outer fringes of the atmospheres to thousands of degrees within the depths of the fluid mantles. Pressures vary through similar levels.

@ These values are meaningless for an object without significant atmosphere.

COMMUNICATION LAG TIMES

Times are measured in minutes and seconds at both closest and furthest approaches to Earth.

Object	Delay
Luna	0.83 sec. close/1.12 sec. far
Mercury	4 min., 18 sec. close/12 min., 18 sec. far
Venus	2 min., 7 sec. close/14 min., 30 sec. far
Mars	3 min., 1 sec. close/22 min., 17 sec. far
Asteroid Belt	18 min., 20 sec. inner edge/22 min., 56 sec. outer edge
Jupiter	32 min., 41 sec. close/53 min., 47 sec. far
Saturn	66 min., 23 sec. close/92 min., 10 sec. far
Uranus	143 min., 46 sec. close/175 min., 10 sec. far
Neptune	238 min., 53 sec. close/260 min., 40 sec. far
Pluto	237 min., 23 sec. close/417 min., 40 sec. far

2

In Space, you either learn the rules fast— or you don't survive to learn them at all...

THE ENVIRONMENT OF SPACE



THE TRIAD

Humanity's headlong rush from its home world into the vast expanse of interplanetary space has highlighted its fragile nature. Minor concerns of politics and petty grievances are dwarfed by the simple reality of living, and surviving, in a hostile environment.

Forget your designer clothes, the biosculpts and the guns. Space is the most hostile environment of all. An unprotected man can exist in its unforgiving realm for only a few seconds before his lungs burst, his blood boils away to steam, and his body freeze-dries. It's a place where you either learn the rules fast or you don't survive to learn them at all.

Remember the Triad.

Every spaceborn child knows (and lives by) a triad of critical factors. These are Atmosphere, Radiation, and Gravity. These conditions are drilled from birth into every child and form the basis for Orbital culture. The wrong atmosphere will kill you in minutes, too much radiation in days and too little gravity can permanently cripple you. There is an old Highrider saying which has been immortalised in "ARG" earrings and tattoos: "ARG—if you don't remember it, it's the last thing you'll say."

ATMOSPHERE

The first leg of the Triad is Atmosphere. It isn't enough to have the right pressure, you also need the right composition. It's not just about people—equipment has atmospheric requirements as well, and there are waste gases to be removed. A little oxygen in the argon welding chamber could turn out to be just as deadly as too much CO₂ in your breathing mixture.

COMPOSITION

Most characters are only going to worry about breathing air. At a standard 1000 millibar pressure on Earth air is com-

posed of 75% nitrogen, 24% oxygen, and traces of carbon dioxide, water vapor, and other gases. However, in high pressure environments, nitrogen would be absorbed into the blood and must be replaced with an equivalent level of helium, while in low pressure environments the percentage of oxygen must be increased to ensure an adequate supply. In habitats you also have other concerns. The O'Neills have to make sure enough CO₂ is available for plant growth in the farms, the auto-factories need to monitor their atmospheres for contaminants and scientific satellites have to avoid the stray ions found in outer space.

RUNNING OUT OF OXYGEN

If your recycler malfunctions, you may have plenty of air pressure but not enough oxygen. When there is no loss of pressure it is sometimes difficult to tell whether the air is bad, or just stuffy. If a character is placed in this situation the effect may not be noticeable immediately. How long the oxygen levels last depends on how many people are burning it up, and how much they are exerting themselves.

One hour's worth of oxygen left: Air is hard to breathe. INT, REF, and COOL are reduced by three points, but not permanently.

Five minutes of oxygen left: Every three minutes after this characters will lose one point of INT. Characters regain all but 1D6/2 points (round down) of this lost INT when the oxygen level is restored.

All oxygen gone: All characters automatically pass out. In addition, all characters will lose 1D6 points of INT per turn in addition to whatever INT they may have previously lost. 1D10 minutes after INT reaches zero, characters are DEAD.

PRESSURE

Of course even if the right mixture of gases is available, there has to be enough pressure in order to breathe. Nothing galvanizes a Highrider like hearing the

thin, shrill scream of pressure escaping from a habitat. Even the smallest child can clamber into a spacesuit or emergency life bubble in a matter of seconds. Nothing makes a Highrider madder than someone who has just done something stupid to puncture a pressure seal.

Something stupid like firing a gun.

VIOLATING PRESSURE

It takes a certain amount of damage to violate a pressure seal. This is based on the Stopping Power of the hull itself, but walls and structures in space are not very thick. Materials are expensive and hard to come by; torque and thrust factors require a delicate balance between mass and acceleration. An Orbital Transfer Vehicle hull is only a millimeter or so of metal and a few centimeters of foam—just enough to hold in the air and shrug off whatever minute particles strike it.

There's good reason why spacecraft hulls are so thin. When cosmic radiation (such as an alpha particle) hits metal and passes on through, the radiation damage is fairly negligible; but if the radiation hits and only partially passes through, it breaks up into nastier secondary radiation. In short, you want to stop all radiation (as in a rad shelter), or let the harmless stuff pass through easily.

Luckily, space is pretty empty. The chances of a micrometeor hit are about one in a thousand, while the chances of a serious encounter are even slimmer. The greatest danger in space is from Man himself. Every year, more junk is thrown into orbit, where it waits for a possible collision.

Then there's always some idiot who decides to fire a heavy caliber hand weapon in a habitat. While guns are severely restricted in space, and are in fact illegal on space transportation, this doesn't stop the more enterprising solos. Every so often, some Groundside yahoo tries to get away with a handgun assassination in a pressurized area, and ends up killing himself, his target, and

DEEP SPACE

THE ENVIRONMENT OF SPACE

STOPPING POWERS FOR VARIOUS HULLS

Spacecraft "skin"	8SP
Internal bulkhead	8SP
Internal partition	4SP
Heavy Cargo	
craft skin	10SP
Station Hull	20SP
Workplatform Hull	10SP
Spacecraft Armor,	
per point	25SP
O'Neill Colony Wall	300SP

STANDARD VOLUMES AND SIZES

Habitat Module:	
15mx4m	188 m ³
Lab/Workspace:	
30mx10m	2355 m ³
Airlock:	
3mx3m	21 m ³
Shuttle Cargo Bay:	
20mx5m	392 m ³
Spaceplane Flight Deck:	
4mx3m	28 m ³
Spaceplane Main Deck:	
33mx3m	233 m ³
Orbital Torus:	
1590mx46m	2,641,085 m ³
O'Neill; Colony:	
16,100mx6440m ..	524.16Bil. m ³

several other people as his slug punches through a wall.

Solos who do this and survive are usually thrown out an airlock. Without a suit.

It doesn't end there. Here's an example: Say you fire a .45 caliber burst through a space station hull. Assuming it penetrates the wall with any force, it will continue moving at the same velocity essentially forever. If the burst is fired in the direction of orbit, it not only has its own initial velocity, but that of the station as well. A little while later, an OTV comes uprange from Earth. Moving at 3 km/sec, the bullet rips through the thin hull of the OTV, and two dozen construction workers die as their cabin evacuates to open space.

Remember: Guns are not welcome in space. Bring a knife instead.

PENETRATION DAMAGE

With air screaming out into vacuum, how big a hole is made becomes the critical factor. To calculate this, use the following formula:

For every point of penetration, a 2 cm diameter hole is opened in the hull. Example: I fire a gyrojet in a spaceplane, doing 18 points of damage. 13 get through. A 26 cm hole is opened in the hull.

Remember to account for armor on the external hull.

EVACUATION TIME

For every 2 cm of hole, you will lose six cubic meters (6m³) of air per turn. For example, if a 8 cm hole is punched in the hull, the compartment will lose twenty-four (4 x 6 = 24) cubic meters of air per turn. To know how long you'll have before you're breathing vacuum, you need to know how many cubic meters of air you have in your enclosed area. This is simplified by the fact that most space habitats are cylindrical in design. The general rule is:

$$3.14 \times \text{length} \times (\text{radius squared})$$

For example, a 30 meter cylinder with a 10 meter diameter has 2355 cubic meters of air. We have made this simpler by showing the standard module sizes and pressures for these units.

These volumes are normally written on the inner and outer surfaces of space vehicles and living spaces, usually near doors, hatches, and windows, in fluorescent paint. When 1/4th of the total pressure has been lost, automatic sensors will seal off the area and sound an alarm.

Example: A habitat module has 188m³ of pressurized area. It takes a hit from a meteor, opening an 8 cm hole, and losing 24 m³ per turn. After @47m³ have been lost (about two turns), the doors automatically slam shut and seal the module off. Hopefully, by this time the inhabitants have either cleared out or are in spacesuits. These rules assume a standard 1000 millibar atmosphere is used. If a lower atmosphere is used, it will take proportionately longer before the alarm is set off; if a higher pressure atmosphere is used, it will take less time. Generally, normally high- or low-pressure areas are sealed off anyway.

There are two devices that are commonly found scattered throughout space ships and habitats to help maintain a seal:

Goop Balls: Ping-pong ball-sized plastic spheres filled with a sticky white fluid. When exposed to air, the goop hardens to a putty consistency, filling the hole. One goop ball will cover a 5 cm hole, and most spacers carry six or seven stashed in their pockets at all times. 0.2 Eb apiece.

Slap Patches: These are folded circles of sticky-sided plastic with a foil backing. They cover a 30 cm x 30 cm area. The backing is peeled away and the patch applied. Most spacers have one or two on hand in every room of a habitat. 5 Eb each.

Of course in an emergency almost anything that can form a seal can be used.

A table can be slapped against a hole, held in place by air pressure, or perhaps even a body (dead or alive).

IF THE PATCH FAILS

When the pressure seal is violated by a hole, a Referee must take into account the effects of dropping air pressure on the players. Checks must be made three times: half volume, quarter volume, and zero volume. Note that this assumes standard pressure; if the pressure is higher, rolls are not made until the pressure is at half normal, and if lower, the half volume roll is ignored.

Half Volume: At one-half normal volume, the air in the area is becoming thin and hard to breathe. Characters must make a roll against an average task, using their Body Type and a 1D10 roll, or pass out until pressure is restored.

Quarter Volume: The oxygen in the area is less than is needed to remain conscious. Characters must roll against a Very Difficult task every turn to remain conscious. After three minutes, they will lose 1 point of INT for every additional three minutes of 1/4 volume (brain damage from hypoxia). When pressure is restored, all but 1D6/2 points (round down) will be restored with proper therapy. In addition, characters will suffer 1D6/2 damage every turn from "the bends" as nitrogen boils out of the blood, until zero volume is reached. This will not happen if the character is in a helium/oxygen atmosphere. Once pressure is restored, the character's Body Type is permanently reduced by 1D6/2 points.

Zero Volume: At zero volume, the compartment is airless. If a character is still conscious he has only 5D6 seconds of consciousness left in which to watch his life flash before his eyes. They suffer an additional 1D6 damage per turn from the remnants of blood nitrogen and an additional 1D6 INT loss per turn in addition to the INT he has have previously lost. After 1D10 turns at zero INT, the character has reached death state 10 and is DEAD; the parts won't

even be good for the body banks. Huge bruises begin to form, surface capillaries begin to burst, and blood begins to drip from the ears and the nose.

Example: Scarv's stray shot rapidly empties the tiny lab space he is in. In a few moments, the pressure is down to half. Scarv makes a roll to stay conscious. He fails and passes out. Luckily, Scarv's companion Lorani makes her roll. The reduced pressure starts to boil the nitrogen out of their blood, causing each of them 1D6/2 damage. She is able to painfully get a slap patch over the hole just as quarter pressure is reached, and she passes out herself. Moments later, a rescue party makes it into the lab, pumping new pressure into the compartment.

Both Scarv and Lorani have lost three points of INT (as Scarv isn't too smart to begin with, he is now at 2, somewhere about the level of a cabbage). Both players roll 1D6/2 to see how many lost INT points they fail to recover. Lorani rolls a 1; this is divided by 2, then rounded down. Lorani recovers all her lost INT. Scarv rolls a 4, so he is unable to recover 2 points. With his remaining 3 points of INT, Scarv is now content to say "Duh?" a lot and wait for orders.

RADIATION

The second leg of the Triad is Radiation. Radiation consists of tiny atomic particles which pass invisibly through the human body, leaving chaos and damage in their wake. Radiation can damage DNA inside cells, giving rise to cancer in body cells and mutations in reproductive cells, or can just plain kill.

Radiation is measured in millirads and rads. Although a full radiation measurement is a rad, dosages are usually measured in millirads (1/1000th of a rad) because a full rad of radiation is

"You leave Earth, and anything you forget to bring with you will kill you; anything you do bring with you which doesn't work properly will kill you; when in doubt, assume everything will kill you."

— COMMANDER NATHAN SPRING, "STAR COPS"

a serious dose. Over a spacer's lifetime, he will accumulate dozens of rads.

When a groundsider thinks of radiation, he thinks of nuclear bombs or mutant monsters from the movies. A Highrider knows that radiation is much more subtle. Every living thing continuously undergoes some form of radioactive bombardment, whether from cosmic rays, solar exposure, or naturally occurring carbon 14 or potassium 40. Excessive exposure mounts up until the organism is severely damaged or dies.

There are three major radiation sources in space. These are:

- 1) Cosmic and background radiation
- 2) Nuclear power plants and drives
- 3) Solar flares

Cosmic rays are tiny particles which constantly bombard space. Over a lifetime, a person continuously absorbs tiny amounts of these radioactive particles, which can cause genetic mutations. Power plant radiation is very intense and very lethal. Solar flares are very short and incredibly intense (although solar storms may last longer and have less intensity).

HOW MUCH DAMAGE CAN YOU TAKE ?

A Cyberpunk character can take up to 50 rads (50,000 millirads) before serious damage begins to occur. You should tally the amount of radiation the character has taken over a lifetime on his character sheet. This total is your character's radiation history, and is used to check for radiation damage over his life.

Radiation damage depends on both the dosage and the time over which the dosage is received. Short-term effects are rather easy to play, but long-term effects are very subtle and most effects, like cancer or mutations, cannot be instantly applied to a character. Instead, the Referee must use his judgment on the best way to integrate these factors into the game. For example, characters with cancer or severe rad sickness might take minuses from their REF and BODY TYPE stats, while those

with reproductive damage may become sterile. All of these should depend more on Referee discretion than on dice rolling.

RADIATION EFFECTS TABLES

Note that the physical effects of radiation damage do not usually occur immediately, but are phased in during the noted time period after exposure. Any temporary decreases in stats without specific durations will eventually be restored proportionately over the convalescence period. All the radiation absorbed over the last week is counted when assessing immediate effects. Because the more radiation a person has absorbed, the more sensitive he is, half of the character's radiation history dosage is also added to the immediate dosage to determine the immediate effects. The immediate dosage (NOT including any radiation history adjustment) is added to the radiation history for future use.

IMMEDIATE EFFECTS

Attribute losses, damage, and disease susceptibility are cumulative. For temporary BODY loss, use the result of the new level instead of the current level, should the dosage increase; this is NOT cumulative. Re-roll for death as the level increases. Below 751 rads, add the Body Type Modifier to the chance of death. See table on page 21 for further information.

Assuming the character survives the immediate effects, there are also long-term effects. Two types of damage deserve further attention: Cancer and Mutations.

CANCER

This is the worst side effect of non-fatal radiation damage. It is up to the Referee to determine the effects of a radiation-caused cancer, but the more radiation the character has taken, the more likely the cancer is serious or fatal. If the cancer is fatal, it is likely to spread rapidly through the body and kill the player within 2D10 + 4 months.

Of course, this is 2025. Laser surgery, chemotherapeutic "magic bullets", and

nanotech can effectively cure cancer if it is discovered early enough. Consult your nearest med-tech or ripper-doc. Also, a cancer may automatically go into remission (roll a 1D10 and pray you roll a 1, sucker), which means it is lying dormant. You never know when it might flare up again, though.

MUTATIONS

Mutations in real life (unlike the Marvel comics version) don't allow a player to change himself. Mutations to a body cell usually just kills the cell, but the nasty part is that they may affect your offspring.

Mutation of a reproductive cell is rarely favorable. Most mutations in offspring are ultimately harmful. If a mutation occurs in your rad history, roll 1D10 and consult the chart on page 23.

CYBERNETICS

Cybernetics are not immune from radiation effects just because they aren't organic. The occasional stray cosmic ray can play havoc with delicate circuitry, not to mention what stronger doses can do. Whenever the character needs to consult the Immediate Effects table, a roll is made on Microwaver Side Effects table (CP 2020, p. 98) for every 100 rads the character is exposed to. If results 1, 3, or 4 are received more than three times, it is permanent- the limb is effectively destroyed (half purchase price or better to repair). The character's radiation history isn't used for this, just the short-term dose. Shielding effectively subtracts 500 rads from the short-term dose for cybernetic effects.

SPECIFIC RADIATION TYPES

COSMIC RAYS

Cosmic rays are measured in millirads. Normally, a human on Earth takes about 250 millirads a year. At this level, a man could live 200 years before he reached the 50 rad danger limit.

However, in space there is no blanket of ozone to shield humans from this bombardment (on Earth of 2020, there's virtually none either, but there's still more than in space). Within the thick

RADIATION EFFECTS TABLE

Immediate Dose	Chance of Stat Reduction	Temp BODY	Perm BODY	REF	ATT	INT	COOL	Suscept. Disease	Damage	Chance of Death
<50	—	—	—	—	—	—	—	—	—	—
50 - 100	5%	- 1 2D10 +4 hr.	—	—	—	—	—	—	—	—
101 - 200	40%	- 1 2D10 +4 hr.	—	-1	—	—	—	+10%	—	2%+BTM 2 months
201 - 300	70%	- 2 2D10 +4 hr.	—	-1	—	—	—	+30%	—	7% +BTM 2 months
301 - 400	90%	- 2 1D6/ 2 days	-1	-1	-2	—	—	+60%	1D6-2	30%+BTM 1D6-1 wk.
401 - 500	100%	- 1 1D6 +1 days	-1	—	+1	—	—	+100%	1D6	50%+BTM 3D10 days
501 - 750	100%	- 1 1D10 +4 days	-1	-1	—	—	—	+100%	1D10-2	75%+BTM 3D6+2 days
751 - 1000	100%	- 1 2D10 +1 days	-1	-1	—	—	—	+ 100%	1D10	90% 1D10+4 days
1001 - 5000	100%	- 2 3D10 days	-1	-1	-1	-2	-2	+ 100%	2D6	95% 1D6+1 days
>5000	100%	- 1 per 8 hr.	-1	-2	-1	-3	-3	+ 100%	2D10	100% 5D10 hours

walls of an orbital colony, enough protection can be provided to drop the bombardment rate to nearly zero, but the thin hulls of spaceships or space suits can't stop this constant penetration. In short, every time you go outside of a workshack, orbital colony, or dome, you will take some cosmic ray damage.

For every hour you are exposed to cosmic radiation you gain 1D6 millirads of radiation exposure.

POWER PLANTS & NUCLEAR DRIVES

Under normal circumstances, most

Groundsiders will never encounter the results of a nuclear accident. Exposure to weapon or power-grade radioactivity happens only when a nuclear power plant leaks or a weapon is dropped.

Oddly enough, this doesn't happen as often as one might think. Radioactive equipment is expensive and the Corporations dislike waste. Of course if a groundsider is dumb enough to go scrounging through radioactive waste dumps...

In space there are hundreds of small nuclear reactors going all the time, powering satellites, space probes, and

workshacks. Deep space ships have enormous power-plants designed to move them across the Solar System. Any one of these reactors can, at any time, develop a fault that will expose a crew to nuclear radiation.

Nuclear radiation kills fast! For every turn of exposure, roll 1D10. This damage is measured in rads, not millirads! A ten minute exposure could pack enough radiation to kill a character rather horribly (think how fast Mr. Spock went down in the movie *Wrath of Khan*).

Power-plant radiation can be protected against by wearing a special lead and

LONG TERM EFFECTS OF RADIATION

Total Dose	Physical Effect	Game Effect
>50	None	None; the body can absorb this level with little effect (sure, SOMEBODY will get cancer from this amount, but this is <i>Cyberpunk</i> , not a medical journal)
100	Mutations	See below
200	Minor Cancers	See below
300	Cataracts	Characters will gradually become blind, although this is correctable via surgery No effect on cyberoptics
	Stillbirths	Any female characters becoming pregnant (heh what ?) will become increasingly more likely to have their children die in the womb, or to suffer a spontaneous abortion
400	Leukemia	There is a 1 in 300 chance the character will suffer from leukemia within the next 5-7 years; this chance doubles with every additional 50 rads
	Moderate Cancers	See below
450	Sterility	There is a 10% chance that the character is permanently sterile; this chance rises to 25% at 500 rads, 50% at 550 rads, 90% at 600 rads, 99% at 650 rads, and 100% at 750 rads.
600	Severe Cancers	See below
750	Fatal Cancers	See below

Offspring Mutation Table

Roll	Result
1	Favorable (Referee determines)
2-3	Harmless
4-7	Deformed, lose 1D6 points from 1D6/2 Stats as determined by the Referee
8-10	Stillbirth

Both tables assume a whole-body dose; dosages for smaller areas generally affect only that area, in the short term. Although there is no way to lower a character's radiation history, the worst results can be stopped or reversed through drugs, therapy, and/or surgery.

gold shielded suit. These suits have an RSP (Radiation Stopping Power) of 6 rads per turn.

Example: I enter a breached reactor vessel to shut it down. This emergency task will take me about three turns (about a half-minute) to accomplish. I roll my exposure; 10, 7, 8. Normally, I would have taken a total of 25 points just crossing the room. However, with my suit's RSP, I took only a total of 7. The rest was stopped by the suit. Of course, if I stay in this position long enough, eventually I will take enough rads to cause some serious damage.

Mr. Spock should have put on a rad suit.

SOLAR FLARES

The Sun is a fusion reactor smack in the middle of the solar system, prone to

occasional power fluctuations from time to time. When the output of energy peaks, it creates a deadly wave of radioactive particles which sleet through space. This is a solar flare.

Solar flares disrupt communications, interrupt power sources, corrode solar panels, make pretty lights in the sky, and give you several lifetime doses of radiation. A flare can kill you almost as fast as a nuclear plant or drive, generating as much as 60 rads in a six hour period. During a solar flare, there's only a few safe places to be, such as on Earth, behind lots of shielding on an orbital colony or under the Lunar or Martian surface.

Solar flares are fairly rare and there are plenty of warning devices about which give at least two hours notice that a flare is building. Occasionally players will

find it impossible to get to safe ground, particularly if they are living in a work-shack. This is why most (80%) of all smaller stations and all deep space ships have a small, heavily shielded chamber designed to shelter up to twenty people from the effects of a flare. This 'storm shelter' has sufficient food, water, and air for up to twenty days, but it's incredibly small and mind-bogglingly dull. Many 'cellars' have installed braindance systems (see *Rockerboy*) to keep the occupants from killing each other during a long flare. Any material placed between the character and the Sun will reduce the effects of a flare.

FLARE OCCURRENCE

The chance of a flare occurring increases as time passes. Roll 2D10 each month (minus the number of months since the last flare); if you roll less than 2 a flare will occur that month. A flare

will usually last 1D10 days—roll another 1D10 if you need to know the “fraction” of the last day.

Solar flares have a Strength, which among other things determines the number of D6 each player rolls per hour to determine the number of rads of radiation received; this radiation is reduced by armor, spacecraft hulls, water or fuel tanks, lunar slag, other characters, etc. The Strength is determined by rolling percentile dice and consulting the chart in the sidebar.

GRAVITY

The final leg of the Triad is Gravity. There is no place in the Universe where gravity is absent, but in most places gravitational attraction is so small it might as well be nonexistent; this is technically known as microgravity, but it is commonly referred to as “zero-gee”. Unfortunately, the human body evolved in a gravity field, and doesn’t easily adapt to its absence. Therefore, since no “artificial gravity field” has yet been developed, spacers learn to either simulate gravity using centrifugal force, or live without it.

The effects of zero gravity on a terrestrial body, while seldom fatal, can be detrimental to someone who eventually wishes to return to terra firma. Fluids pool in the chest and face, making you puffy (and hiding wrinkles), but also causing you to break down and excrete what the body mistakenly considers “extra” blood (dehydrating you). You gain up to 5 cm in height, but your bones begin to lose calcium, causing them to weaken (and increasing your chance to get a kidney or bladder stone). The body flushes out potassium, which affects heart rhythm. The heart itself pumps with a lower pressure due to a lack of downward pull on the blood. Since the muscles don’t have to fight gravity, they lose tone, and begin to break down. Eventually, the body will be unable to stand in a gravity environment. And we haven’t even discussed the psychological impact of zero-gee.

There are five ways used by Orbital personnel to minimize the physical effects of zero-gee:

1) Drugs, such as calcium tabs, water retention aids, and vasoconstrictors (to raise blood pressure). While useful in the short term, drugs lose effectiveness over time, and the body can become dependent on them (affecting the body when it returns to a gravity field).

2) Exercise, to stress the bones and muscles as gravity does. The amount of exercise must gradually increase; after several months, at least four hours a day will be needed just to slow down the deleterious effects. Two hours a day will be needed on Luna, and an hour a day on Mars. Heavy aerobic exercise is necessary, such as bicycling and running on a treadmill.

3) Centrifuges, from rotating tables to gravity wheels to spinning habitats such as the Crystal Palace. The centrifugal force has the same effect as gravity. Unfortunately, one drawback is the Coriolis effect (a sideways motion created by the spin). In a small environment, this force is powerful enough to cause dizziness, nausea, and sometimes injury. Centrifuges are seldom used on workshacks, since the torque can adversely affect some experiments and manufacturing processes.

4) Clothing, with built-in elastic to force the body into positions which cause the muscles to exert force to counteract; the Soviets refer to these as “penguin suits,” since that’s what you resemble as you waddle down the hall. It’s another form of exercise, only you can move about. One variation of this is the Lower Body Negative Pressure Device, a cylinder that covers the body from the waist down, and which has a lower pressure than the outside air. This forces blood into the legs, and the heart must work to circulate it.

5) Biotech/Nanotech, to repair and rebuild lost bone and muscle. Technology can directly repair any damage caused by zero-gee, eliminating the

CANCER AND YOU

Okay, so the cancer rules are fairly general. Do you really want to play Treatments and Tumours? In most cases, characters will either take enough of a dose in a flare or power plant accident to make worrying about the long term effects silly. When you have a rad accident in Near Orbit/Deep Space, you usually end up glowing in the dark.

FLARE STRENGTH TABLE

Roll	Strength
01-23	1
24-42	2
43-59	3
60-72	4
73-83	5
84-90	6
91-95	7
96-98	8
99	9
00	10

DEEP SPACE

THE ENVIRONMENT OF SPACE

need for gravity wheels, drugs, and exercise, but at a substantial cost. Devices can be attached to stimulate the muscles electrically, which will slow muscle loss.

GRAVITY ADAPTATION

There are immediate, short-term, and long-term effects as the body adapts to a weightless environment. The most immediate effect is Space Adaptation Syndrome (see below). Short-term effects are the tendency of the body to form a crouch (known as the Space Neutral Body Posture); the pooling of fluid in the abdomen, which the body interprets as excess and flushes out (causing the body to dehydrate), and the loss of minerals from bones (making them brittle). The eyes are also affected, with older astronauts requiring glasses to see close up; long-distance vision can actually improve. Long-term effects are lowered immune system efficiency, and occasional skin infections.

SPACE ADAPTATION SYNDROME

Space Adaptation Syndrome (SAS) is a form of motion sickness. About half of those arriving in space for the first time suffer from it, and there isn't any way to tell ahead of time who will be the lucky victims. It won't manifest itself until the character has the opportunity to move around a bit; it is seldom seen in small, enclosed spaces, or when a character is strapped down. Sudden, unexpected vomiting is not unknown, and nausea is a common symptom. There is also a loss of appetite. It's very much like having the flu. Regular drinkers of alcohol generally have few symptoms. SAS usually fades away by the fourth day.

Within three hours of attaining zero-gee for the first time, roll 1D10. On a roll of 2 or less on your first flight, you are permanently immune from SAS; otherwise, you don't suffer from it this flight. On a roll of 3, you are slightly queasy, but get better in 1 to 10 hours. On a roll of 4-9, you suffer the full effects of SAS for 1D6/3 + (half your roll) days (3.3-6.5 days; keep the fraction). On a 10, you

will never fully recover until you are in a gravity environment again; a large centrifuge will suffice. If you were born in space, you automatically subtract 4 from the roll. If you got it on your first flight, add 1 to the roll, as you will tend to get it again; if you didn't get it on your first flight, subtract 1, as you will not tend to get it in the future.

PHYSICAL DETERIORATION

After the first few days, characters will begin losing bodily fluids, causing a tendency toward dehydration. Muscle loss will begin, as well as bone demineralization. This increases the odds of a kidney stone. Magnesium and potassium will also be lost, causing a tendency for heart irregularities.

Without exercise a character's BODY TYPE stat would drop by one point per month during the first two months. There would be no drop in the third month, a loss of one point in the fourth month, then a loss of one point in the sixth month, the ninth month, and so on, with the time interval increasing by one month every succeeding period. As long as two hours of exercise a day is obtained, increasing by one hour every six months to a total of six hours, the effects of zero-gee are stabilized. Strenuous exercise is required; isometrics won't cut it. Use of a centrifuge would have the same effect as exercise, but special clothing would only be half as effective (thus requiring more time). The required time remains the same for Luna, but Mars requires only half the time. Note that any vigorous movement (such as a chase or a fight) counts as exercise.

PSYCHOLOGICAL EFFECTS

In the earliest days of space exploration, the mental problems of weightlessness weren't readily apparent. Most astronauts were experienced in strange environments and had some simulation of zero-gee through special water tanks and free-fall experiments. Besides, the

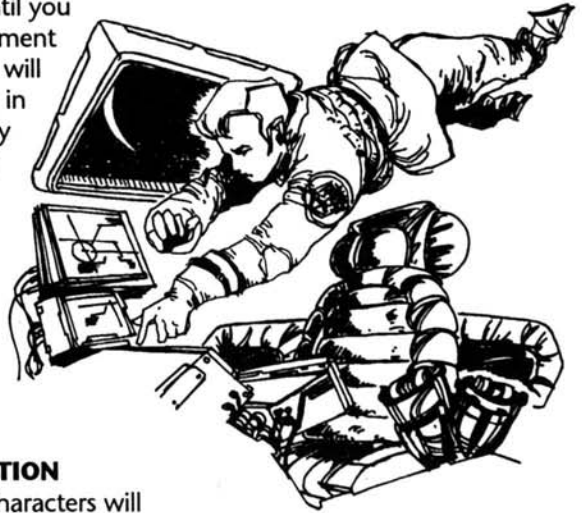

problem of hanging upside down in mid-air is negligible when the entire area is less than six or seven feet high.

The twenty-first century changed this. For starters, most of these new space travellers weren't trained scientists and pilots; they were corporate execs, lab researchers, and so on. Adapting to null gravity was far more of a problem for these civilians. Some became dizzy, disoriented, and "space sick". Others experienced constant anxiety without a readily identifiable up or down.

Meanwhile, an entire generation of colonists were growing up in space; adapting their homes and workplaces to its conditions. These new spacers thought nothing of hanging upside down over a 500 meter hangar bay to work on an exposed panel; they'd been doing things like this all their life. Although they dutifully took their pills and did their gravity-wheel therapy, most didn't think about up or down at all. The first spacers required special webbing to keep them from drifting out of their bunks. The second generation didn't even use bunks half the time. In a habitat, it became common for a two year old to curl up wherever he happened to be, snag a handhold, and reflexively hold himself at station while sleeping. As these generations matured, they began to shape their environment to fit. Huge, open spaces were thrown between areas of a habitat, without thought of bridges or catwalks. Corri-

dors had moving handholds installed to tow people from place to place. Elevators, stairs, and ladders disappeared from construction. Chairs were mounted on any convenient surface, or not used at all.

The result? An environment designed to scare the living daylight out of a gravity-raised, gravity-loving Groundsider.

Cyberpunk characters coming from Groundside have a serious adaptation problem facing them. They will find themselves plunged into an environment where up and down don't exist and nothing is arranged to facilitate a sense of gravity. Dinner parties may have guests floating languidly at all angles and an open corridor may suddenly cross a bottomless airshaft. As for combat, forget it!

NEW SKILL: ZERO-GEE MANEUVER

The skill of moving in zero-g without EVA packs, etc. By shifting body weight, pushing off walls and even throwing a heavy object the player can move about a zero gee environment with relative ease. Pushing off a wall in a straight line and stopping at a far wall without knocking yourself unconscious would be an AVERAGE (+15) task. See pg. 76 for details.

COMBAT IN ZERO-GEE

Combat in a gravity field often depends on gravity. A fighter can throw himself into an opponent and throw him off balance, or they can grapple, one trying to overcome the other by force, or one can attempt to throw the other. But all of these require gravity. You can't do much of a body slam if you lift yourself off the floor as fast as you throw your victim towards it. Fights end quickly when you swing a fist and set yourself spinning. One problem in zero-g is that lack of gravity doesn't cancel out Newton's Third Law. A heavy caliber handgun can easily propel its user into the opposite wall, from recoil. While gyrojet weapons can reduce or eliminate this recoil, as a standing rule any player firing a recoil-

ing weapon must make a REFLEX roll or be pushed backwards.

The player must roll a 1D10 + REFLEX total higher than 15 or be knocked off his feet. This +15 Difficulty is further modified by the following table

Recoil Save Table

Add modifier value to 15+ base Difficulty.	
Small Caliber (.22, .32)	+2
Medium Caliber (9mm, .38)	+5
Heavy Caliber (.45, .44, .357)	+10
Any rifle caliber	+10
Any automatic burst	+10
Braced Stance	-4
Velcro Soled Shoes	-2
Body Type is Strong	-2
Body Type is Very Strong	-4
Magnetic Boots	-4

For every point the player has failed by, he is pushed back 0.5 m/sec in the direction opposite of that in which the weapon was fired. If a wall is hit, the character will take 1D6 in bludgeon damage for every 2 m/sec or fraction of recoil speed. The character is also thrown into an uncontrolled spin (recovery takes an AVERAGE Zero-Gee Manoeuvring roll).

Example: Scarv fires a .357 magnum at a target fleeing down the corridor. He fails his Recoil save by five points, and tumbles back 2.5 meters/sec. Unfortunately, the wall is only two meters behind him. He hits solidly, taking 2D6 in bludgeon damage to his torso.

NEW SKILL: ZERO-GEE COMBAT

This skill assumes the player knows how to use recoil weapons in zero-g (bracing against walls, etc. to prevent blowback). This skill is also a modified style of martial art that teaches the player how to make punches and kicks in such a way as to keep close to the target, and how to use leverage to make throws and keep holds. Orbital Characters automatically have this skill at +1, and may buy it at higher levels using IP. This is not a maneuvering skill, and Zero-Gee Maneuver is a prerequisite. See pg. 76 for details.

RETURNING TO GRAVITY

Things don't get back to normal right away when you get back to normal gravity. Some bone damage will be permanent, and the general restoration of pre-flight strength and body functions will be dependent upon the efforts the character made while in zero-g. The more exercise, and the greater the amount of time spent in a centrifuge, the faster the recovery. In general, one day of recovery per month of zero-g will be needed before the character can walk around again; halve this if the character exercised vigorously or used a centrifuge in excess of the recommended amount, and double or more if the character failed to exercise at least the recommended amount. The lost fluids will be replaced within a week, and the lost muscle mass within a month or two, no matter how long the flight. Lost bone will take more time to recover, and some of the loss may be permanent. Once the character is in a full gravity environment, they will regain one point of BODY every 1D6/2 weeks, longer if on Luna or Mars. One point is permanently lost for every year (or significant fraction) spent in zero-g.

Example: Poor Scarv spent a year on a workshack performing menial labor while recovering from his bout with loss of pressure. The labor wasn't very taxing, however, and he isn't smart enough anymore to remember to exercise properly. He started with a BODY TYPE of 9. At the end of the first month, his BODY TYPE dropped to 8. At the end of the fourth month, he had dropped to 7. After six months, he was down to 6. After nine months, he had a BODY TYPE of 5. He accidentally broke the liquor cabinet, so he was fired and sent back to Earth. Since he was in space a year, he has permanently lost one BODY TYPE point. It will take him anywhere from twelve to sixty-four days to recover his strength.

3

*Spacecraft—
intricate systems
finely meshed to
support life, cover
distance, and, occasi-
onally, destroy...*



GETTING AROUND THE SOLAR SYSTEM

THE HARDWARE

There are four types of spacecraft. These are Surface-to-Orbit, Orbital Transfer Vehicles, Surface-to-Space and Deep Space Ships. Each type of spacecraft is designed for a particular environment.

SPACECRAFT CODES

Each spacecraft is represented by certain characteristics such as the type of drive, minimum crew requirements and cost. These factors are recorded as a spacecraft code (a profile of the craft):

Type • Cost • Crew • Passengers • Drive Type • Burn Elements • Power Type • Sensors • Computers • Cargo • Actions • Weapon Spaces • Armor • Damage Points • Overkill Points • Shuttlecraft

Type: The type of spacecraft and use if applicable.

Cost: The manufacturer's suggested retail price, in millions of euro. Used prices are 30-80% of this.

Crew: The number of crew needed to operate the craft.

Passengers: The number and type of berths usually available.

Drive Type: This is the number and type of drives the ship uses. All drives are listed here.

Burn Elements: The total number of burn elements available.

Power Type: Types of power systems.

Sensors: The base detection rating of sensors.

Computers: The number of onboard computers and capacity, and programs carried for each.

Cargo: The number of cargo bays and their capacities. Every 20m³ can be converted to 8 berths.

Actions: The number of actions the ship has per combat turn.

Weapon Spaces: How much room is available for weapons, defenses and armor.

Armor: The maximum amount of armor which this craft can support.

Damage Points: The number of possible damage elements.

Overkill points: How much extra damage the craft can take (after being wrecked) before it explodes.

Shuttlecraft: The smaller craft which may be carried and the cargo space they occupy.

Thus a spacecraft with the code:

Cargo Shuttle • 200 • 2 • 0 • Chemical • 10 • Battery, Fuel Cell • 50% • 3 • 1 x 200m³ • 2 • 4 • 2 • 12 • 4 • 1 x Flitter: 30m³

is a cargo shuttle worth approx 200 million eb list price with a crew of 2 and no passenger space. The craft has a single chemical engine providing a total of 10 burn elements and uses batteries and fuel cells for power. It has sensors with 50% base detection rating, 3 on-board computers and 200 cubic metres of cargo space. In combat it has 2 actions per turn and has 4 weapon spaces and a maximum hull armor of 2SP, with a total of 12 damage elements and capable of sustaining an extra 4 points of damage before exploding messily. This craft may also contain one Flitter which will occupy 30m³ of cargo space.

"I don't care that you'll shoot me if I don't! I can't take you to the Moon in an orbital shuttle, period. Try hijacking an OTV next time, you idiot ..."

SURFACE-TO-SPACE SPACECRAFT**SURFACE-TO-SPACE**

As of yet, there are still no true Surface-to-Space ships. NASA has designed a hybrid vehicle, with a TAV crew section and an orbital main drive. The TAV would lift off from Earth, link with the main drive, and travel into deep space. So far, no working prototype has been constructed. The Japanese are constructing their *Minerva* STS prototype, though severe design flaws (and not a little contractor fraud) have shown up. The *Minerva* uses a hydrogen fueled scramjet and a nuclear-heated drive pile to allow it to lift off, then makes a link with a long range fusion reactor and drive.

SURFACE-TO-ORBIT SPACECRAFT

The backbone of the space age, these craft get cargo and people into (and back from) orbit.

ROCKETS

Usually consisting of little more than an engine, fuel tank and cargo space, rockets are expensive and rarely reusable. Most lift cargo into orbit and, once in orbit, are converted into living space. Common designs include the EuroSpace Agency's *Ariane VI*, the Japanese *Hiyaku V* and the U.S. *Advanced Launch System (ALS)*. The largest rockets are the Soviet-designed heavy lift platforms.

The most common commercial model is the *HMLPV-15B* (High Mass Lift Profile Vehicle) developed by Orbital Air. HMLPVs are robot-controlled, lower-cost solid fuel rockets designed to get a huge amount of mass into space. They have a reusable scramjet booster section to reach a higher orbit.

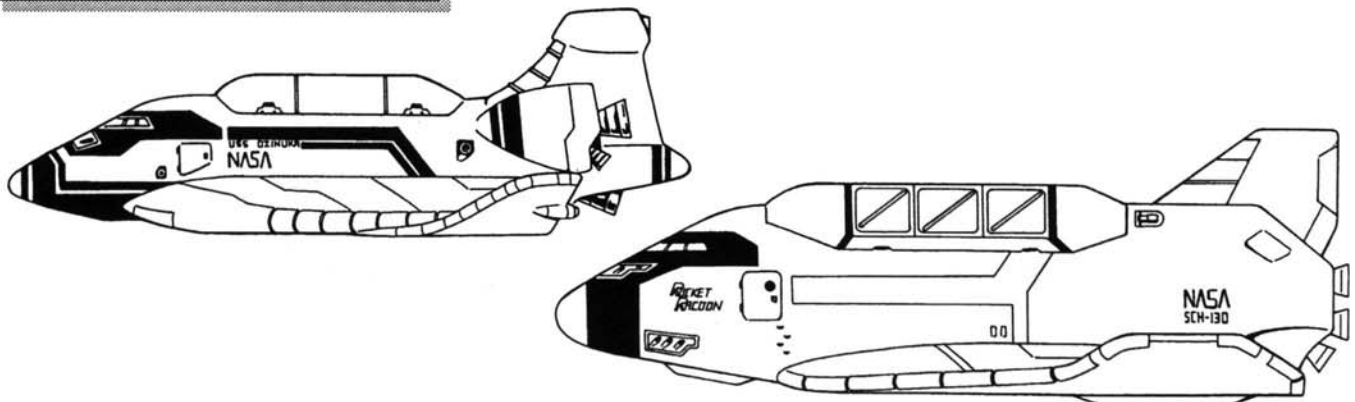
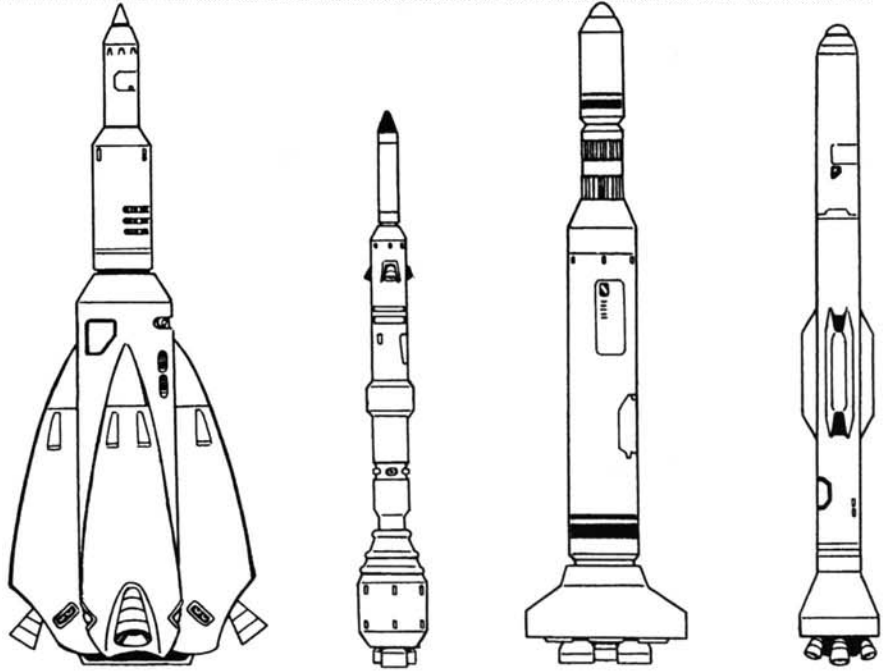

SHUTTLES/MINI-SHUTTLES

These are vehicles which are launched by either a rocket (such as the current U.S. Space Shuttle) or carried piggyback by a lifting platform. Shuttles are used to carry work crews into orbit at altitudes higher than a normal spaceplane can go and are also large enough to carry substantial cargo.

There are four types of shuttles in use in 2025: the standard NASA *Shuttle II* from the late 1990s; the almost identical *KosmoSov Shuttle* from the same time; the *Hermes I-b* mini-shuttle, designed primarily for carrying construction crews; and the NASA *HL-25*, which is optimized for cargo.

- *Shuttle II* • 200 • 2 • 0 • Chemical • 10 • Battery, Fuel Cell • 50% • 3 • 200m³ • 2 • 6 • 2 • 12 • 4 • 1 x Flitter
- *HL-25 Shuttle* • 100 • 2 • 2 • Chemical • 5 • Battery • 50% • 2 • 50m³ • 2 • 4 • 1 • 7 • 3 • None
- *Hermes I-b Shuttle* • 120 • 2 • 12 • Chemical • 5 • Battery • 50% • 2 • 20m³ • 2 • 4 • 1 • 7 • 3 • None

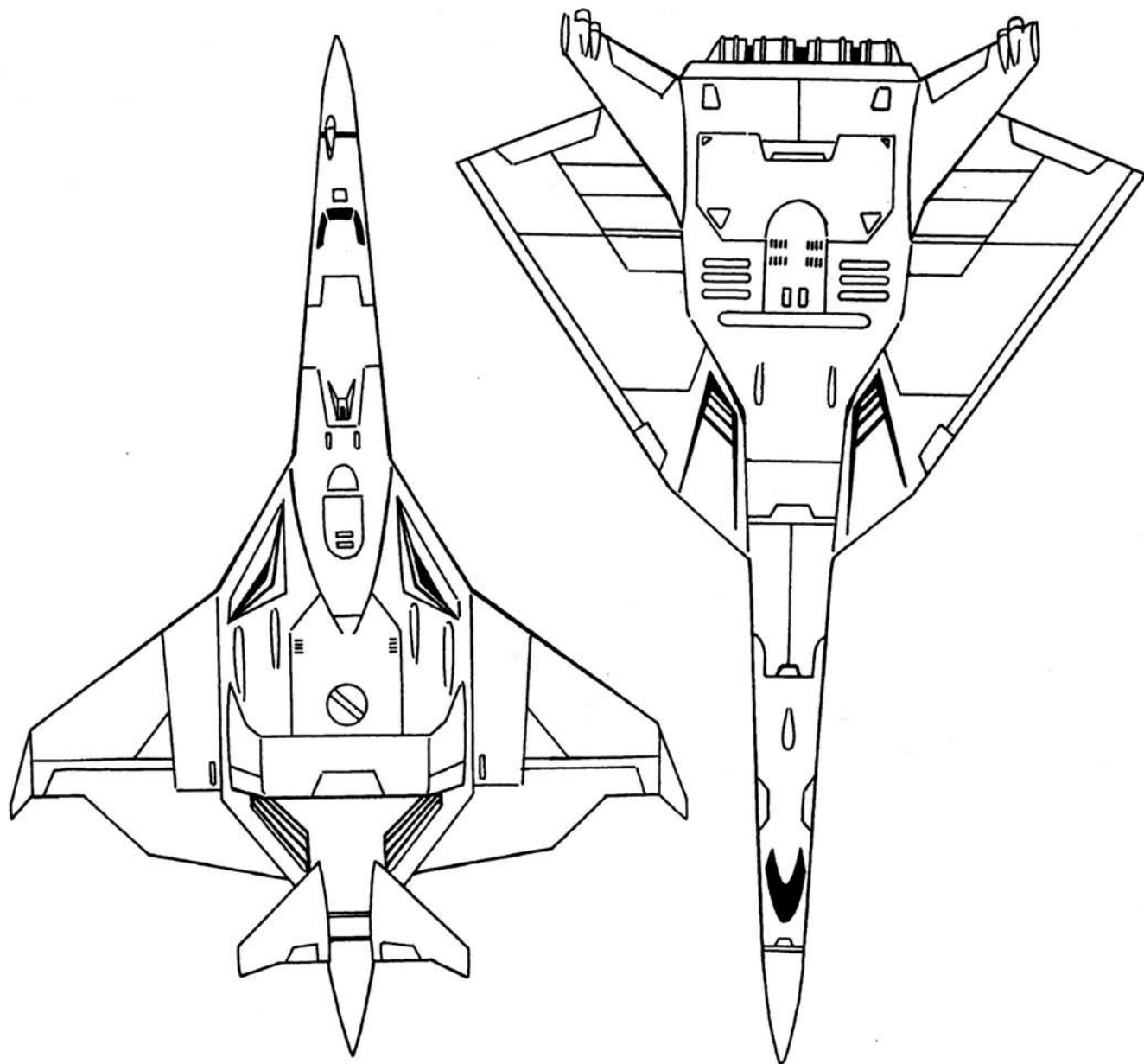

DELTA/CRUISERS

These are high-speed, suborbital spaceplanes designed for combat and interception. They usually have two engines: a normal supersonic jet for reaching an altitude of 35,000 meters, and a solid-fueled rocket engine for boosting into orbit. Occasionally, deltas are carried piggyback by larger jet aircraft, or boosted into orbit by using disposable rockets. They are also carried aboard deep space craft.

Once in orbit, deltas use maneuver thrusters to move in on orbital targets. Well armed with chemical lasers, space-to-space missiles, ASAT missiles for anti-satellite warfare, and kinetic-kill mines, deltas must strike quickly and then use their remaining fuel to reenter safely. The EuroSpace Agency has only a few deltas (24). In the main, they are used by the USAF (118 total) and the Soviets (67 total).

Delta • 80 • 1-2 • 0 • Chemical • 7 • Batteries, Fuel Cell • 55% • 2 • 2m³ • 2 • 8 • 1 • 5 • 2 • None

DEEP SPACE

GETTING AROUND...

LANDERS

Landers are spacecraft designed to take off and land on Luna, Mars, and smaller bodies. They are incapable of landing on Earth. There are two varieties: Luna-certified, which can land on any body no larger than Luna; and Mars-certified, which can land on Mars-sized bodies but carry less cargo.

*Luna Lander • 50 • 2 • 6 • Chemical
• 8 • Batteries, Fuel Cell • 50% • 2 •
15m³ • 1 • 3 • 2 • 5 • 3 • None*



HELL SYSTEMS

High-Energy Laser Lift systems are a small cargo rockets which carry no rocket engine. Instead, their fuel is heated by a laser that remains on the ground. They are cheap and effective at moving cargo.

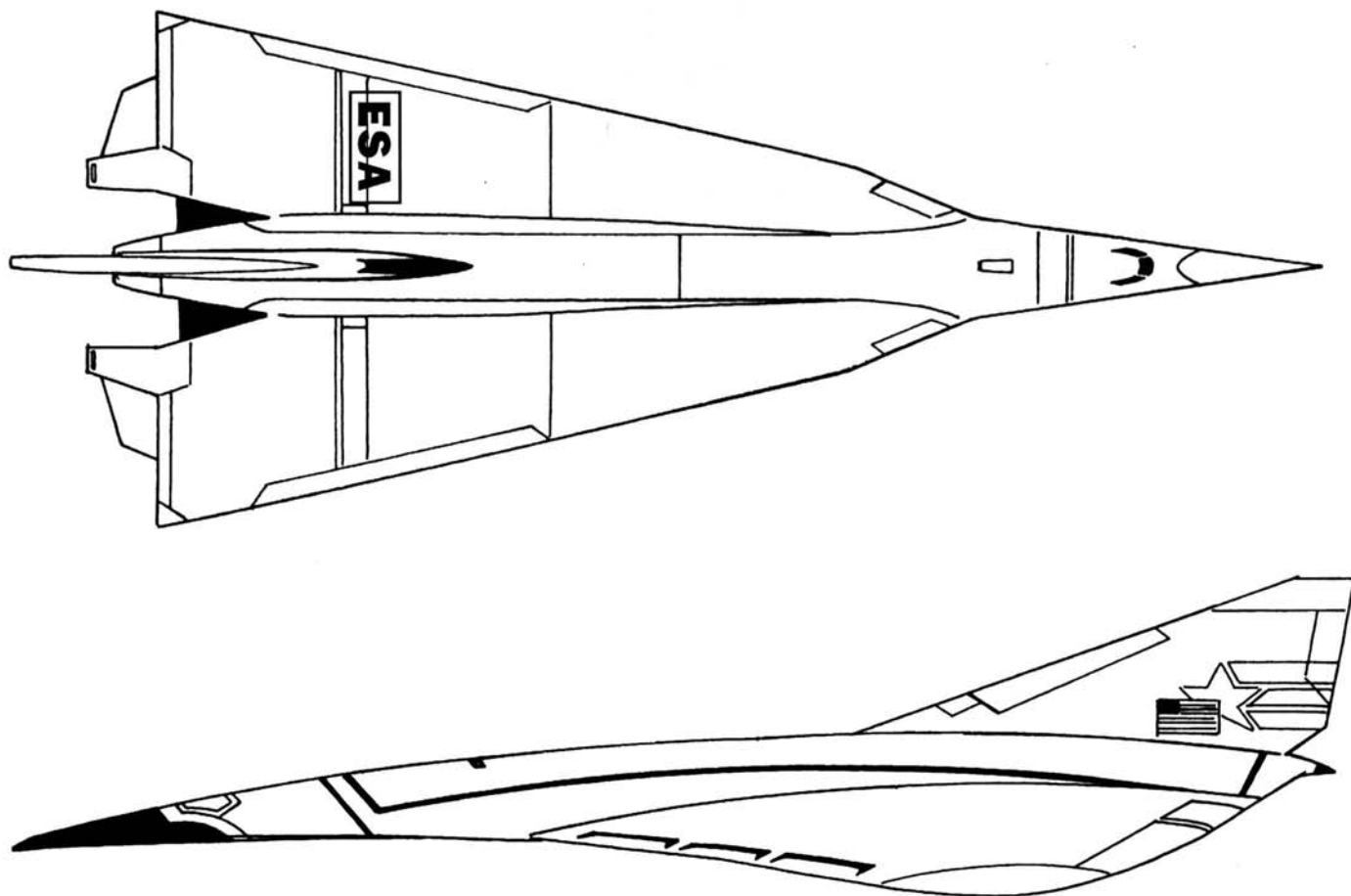

SPACEPLANES

Also known as TAVs (trans-atmospheric vehicles), spaceplanes are capable of reaching low Earth orbit using a combination of a normal jet engine for takeoff, a scramjet which propels it at hypersonic speeds to the edge of space, and a pure rocket to allow it to move in space. TAVs are not designed for deep space travel. They can reach the lowest ranges of

LEO, where they dock with a workstation and transfer cargo and passengers to an Orbital Transfer Vehicle, then reenter.

There are several models of spaceplane including the American designed *Orient Express* (rarely seen, as only six of the original ten are left); the more common *Hermes* and *Aries* series (both built by ESA); and the

Japanese *TAV-12*, which is slightly smaller than the other two designs.

Aries II • 350 • 5 • 48 • Chemical • 8
 • Batteries, Fuel Cell • 50% • 3 • 30m³
 • 3 • 4 • 0 • 7 • 3 • None

TAV-12 • 220 • 3 • 4 • Chemical • 8
 • Batteries, Fuel Cell • 50% • 3 • 30m³
 • 3 • 4 • 0 • 7 • 3 • None

MASS DRIVERS

These are magnetic "rocket sleds" which hurl a capsule into LEO. A mass driver handles cargoes of up to ten tons, usually in huge storage containers. They cannot be used for passengers, as the acceleration is far too great. Mass drivers on Earth are just over 3km. long; in the Lunar gravity well, a 155m track will suffice.



ORBITAL CRAFT

ORBITAL TRANSFER VEHICLES (OTVs)

OTVs are used to move from LEO to higher orbits, or to the LaGrange points. There are three types:

Cargo OTVs are egg-shaped vehicles which carry cargo between orbital points. All engine and fuel cells, they have wide docking rings for easy access. The EuroSpace Agency controls most of the cargo OTVs, although a few are used by the Soviets, while Orbital Air and the ESA have a virtual monopoly on the use of **passenger OTV's**.

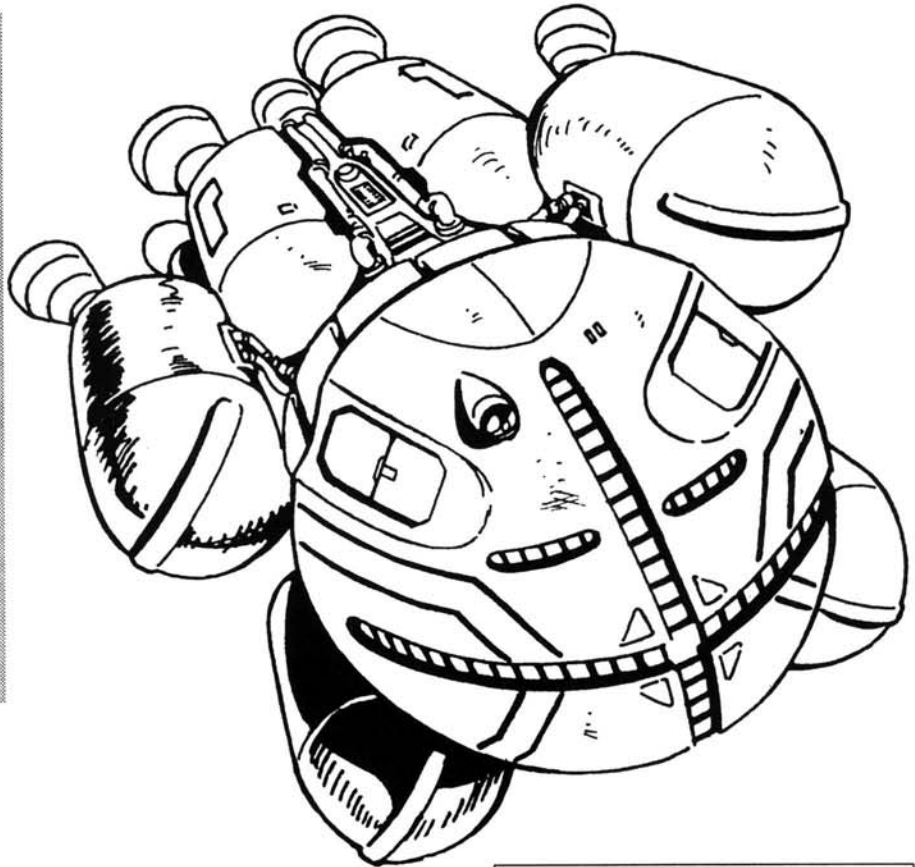

Passenger OTV • 50 • 4 • 16 • Chemical • 10 • Batteries, Fuel Cell or Solar Arrays • 50% • 2 (10MU) • 2 x 10m³ • 1 • None • 1-3 • 5 • 3 • None

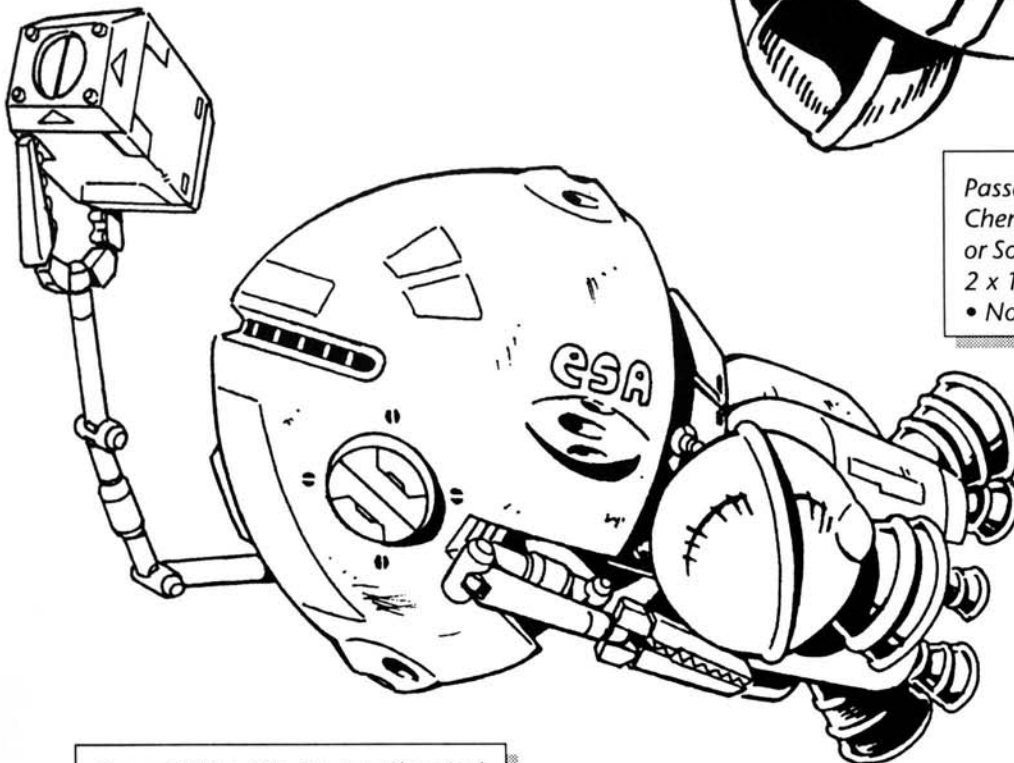

Cargo OTV • 40 • 2 • 1 • Chemical • 10 • Batteries, Fuel Cell or Solar Arrays • 50% • 2 (10MU) • 2 x 30m³ • 1 • 3 • 1-3 • 5 • 3 • None

Deep Space OTVs are much like cargo OTVs, but carry more power and fuel and have a larger crew cabin. They can land on asteroids and the smaller Jovian moons. They are often used by Deep Space Explorers as shuttlecraft.

DS-OTV • 70 • 2 • 16 • Chemical • 10 • Batteries, Fuel Cell or Solar Arrays • 50% • 2x(10MU) • 10m³ • 1 • None • 2-4 • 7 • 4 • None

SMALL CRAFT

Small craft are short-range vehicles used for personal transport. They fall into two categories:

Flitters hold up to four people and a cubic meter or so of cargo. They are used for transport between habitats. They cannot land anywhere.

Flitter • 10 • 2 • 2 • Chemical • 3 • Batteries • 30% • 1 (10MU) • 4m³ • 1 • None • 0 • 3 • 1 • None

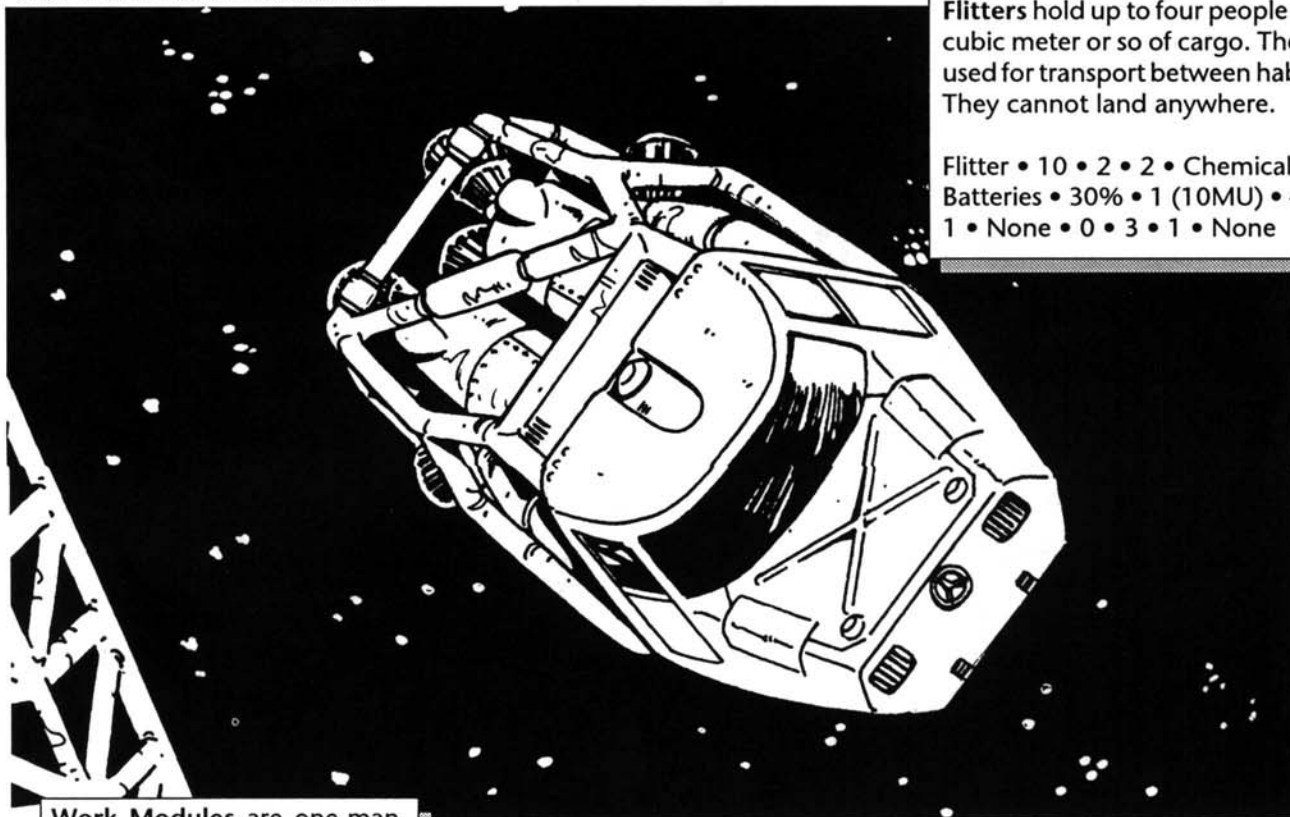

Work Modules are one-man capsules with manipulator arms and rocket thrusters, used mostly in the construction of orbital workshacks. Work Modules have a very limited range.

Work Module • 5 • 1 • 0 • Chemical • 2 • Batteries, Solar Arrays • 30% • 1 • 4m³ • 1 • 1 • 1 • 4 • 2 • None

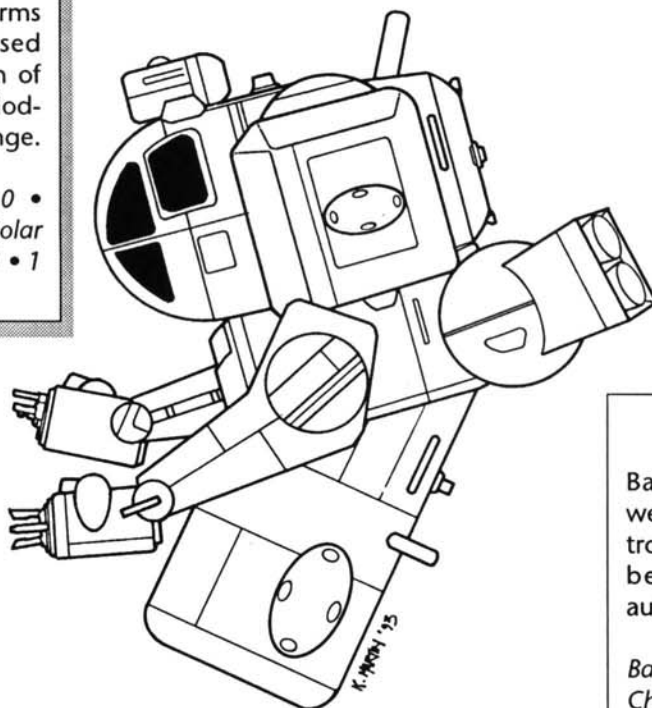

BATTLE SATELLITE

Battle satellites are unmanned weapons platforms. They are controlled from the ground, but can be programmed with some autonomy and initiative.

Battle Sat • 40 • none • none • Chemical • 3 • Batteries, Solar • 65% • 2 • 0m³ • 1 • 10 • 4 • 6 • 2 • none

DEEP SPACE SHIPS

These are the true long-haul vehicles of the Solar System. There is a considerable variety among their designs, as each is optimized for its particular mission. While on board a DSS, most of the crew remains in the state of braindance; bodies are cooled down to near freezing, while autonomic systems are controlled by direct nerve links to a central computer. A sensory "stim" is maintained while in the "dance", allowing the dormant crew to experience sensations and keep them sane. These links can even be shared, allowing an entire crew to share the same braindance (one way to deal with the long period of suspended animation is to run the entire crew as if in a braindance-based scenario). Characters and crew aboard a DSS are also shielded from stray radiation.

There are four main classes of DSS.

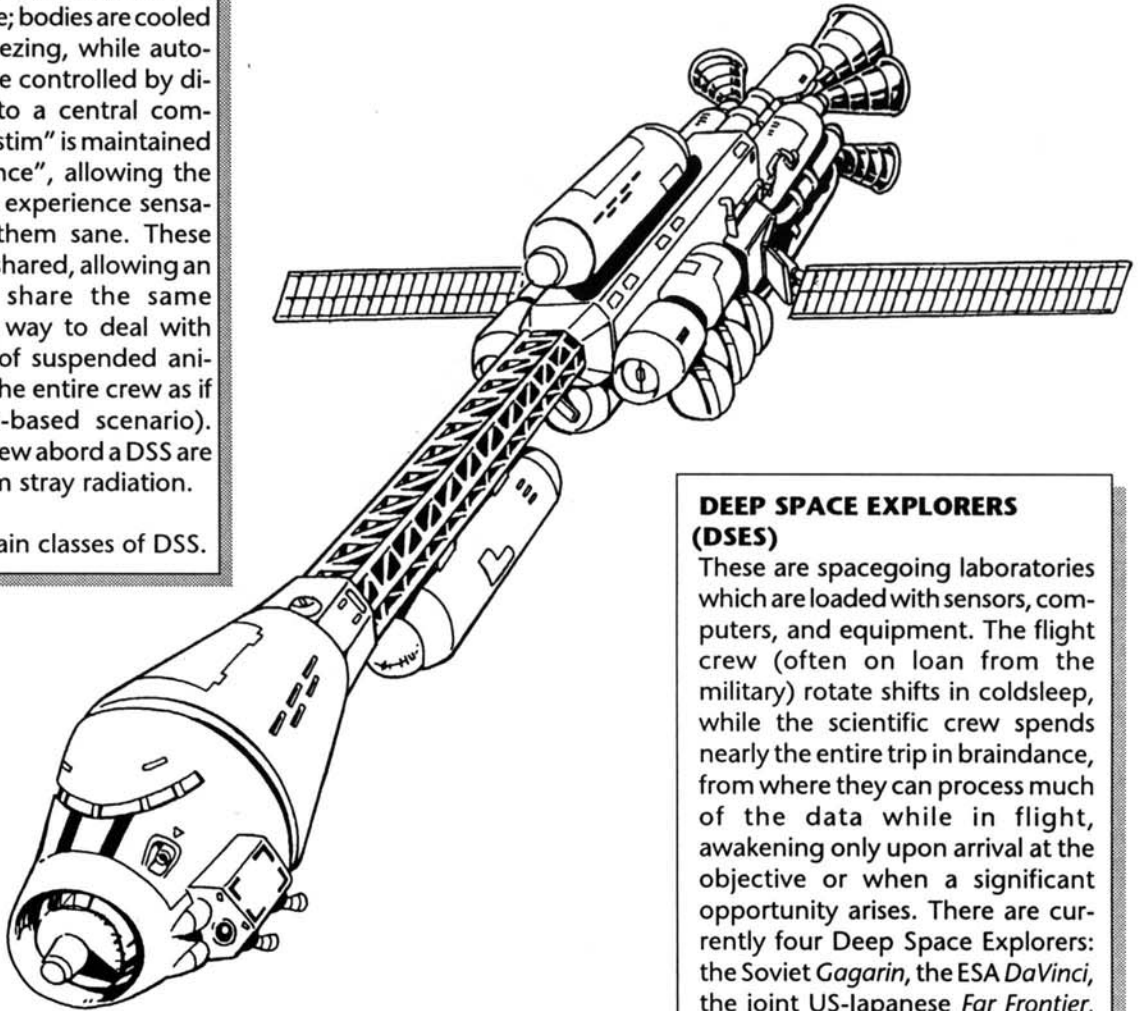

DEEP SPACE EXPLORERS (DSEs)

These are spacegoing laboratories which are loaded with sensors, computers, and equipment. The flight crew (often on loan from the military) rotate shifts in coldsleep, while the scientific crew spends nearly the entire trip in braindance, from where they can process much of the data while in flight, awakening only upon arrival at the objective or when a significant opportunity arises. There are currently four Deep Space Explorers: the Soviet *Gagarin*, the ESA *DaVinci*, the joint US-Japanese *Far Frontier*, and the U.S.-only *Pathfinder*. One more is under construction: ESA's *Kepler*.

DSE • 2500 • 8 • 60 • Chemical, Nuclear • 8, 12 • Nuclear, Solar, Fuel Cell • 90% • 5 • 4 Bays: 1- 15 m³ probe storage, 2- 45 m³ supplies, 3- 45m³ supplies, 4- 8 m³ • 3 • None • 0 • 15 • 6 • 2 Landers, 2 DS-OTV's, 6 probes, 2 m³ each

CYCLERS

Cyclers are massive open-structure craft which permanently cycle between two planets, currently only in use between Earth and Mars. Once set in motion, a Cycler requires very little fuel to maintain its orbit, making it cheap to operate. Specialized OTVs intercept them as they pass near a planet and transfer cargo and passengers. One Cycler has already been built by the U.S. (*Explorer II*), providing a 14-month one-way trip (soon to shorten to 12), and another two are under construction by the EuroSpace Agency.

Cycler (one half) • 250 • 4 • 20 (up to 200 in proposed models) • Chemical, Ion • 6, 2 • Batteries, Solar • 60% • 3 • 1000m³ • 2 • None • 0 • 8 • 4 • 3-4 OTV's, 2 Landers

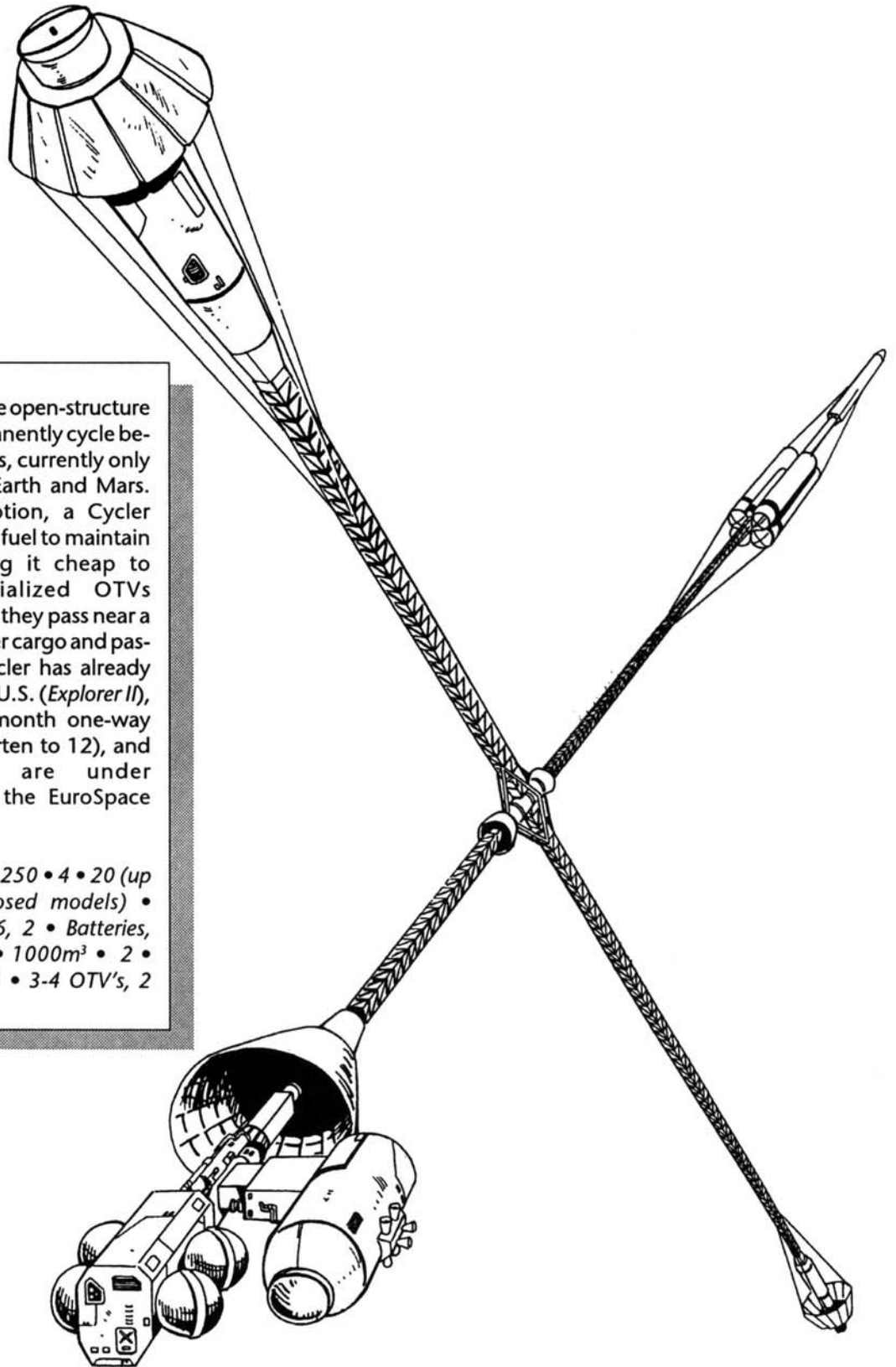

CLIPPERS

These are fast cargo ships consisting of an engine, fuel, and minimal life support to carry high-priority cargo. Although there are several designs on the drawing board, no Clippers are yet in operation.

Clipper • 70 • 2 • 2 • Chemical, Nuclear • 6, 12 • Batteries, Fuel Cell, Solar • 60% • 2 • 50m³ • 2 • None • 0 • 6 • 2 • 1 cargo OTV

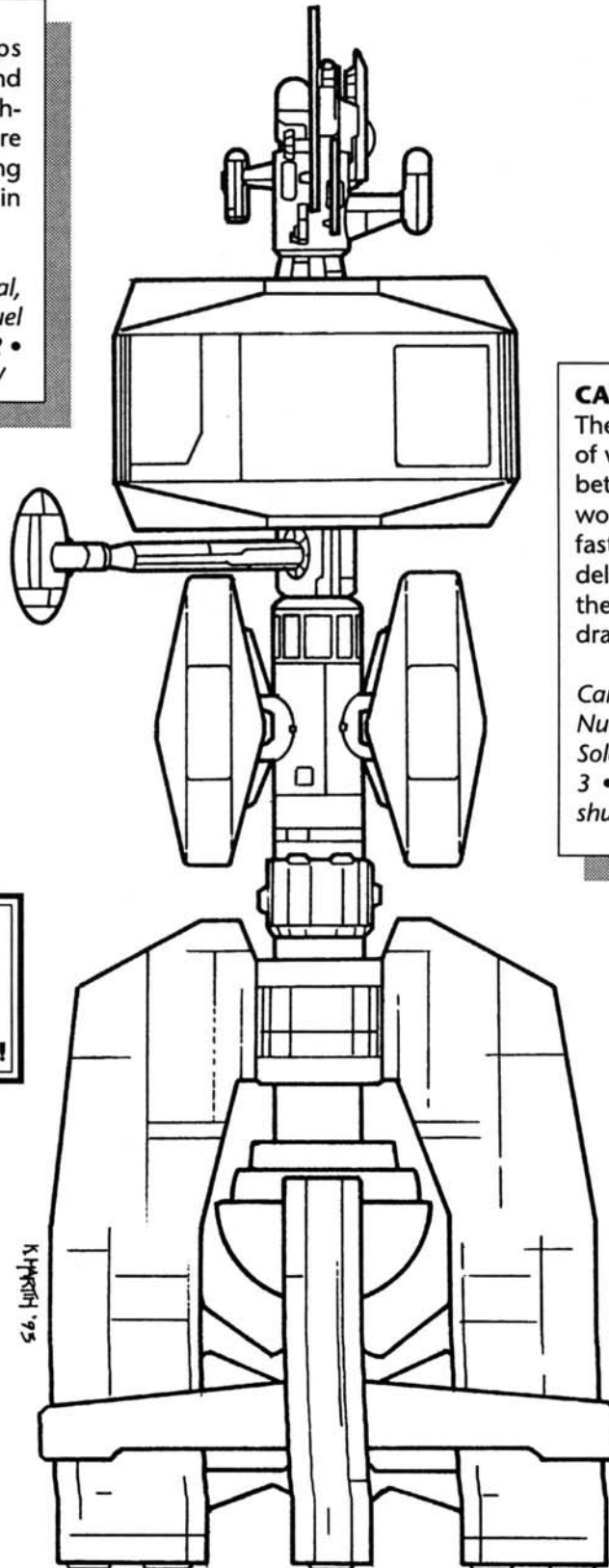

CARRIERS

The carrier is a proposed new type of warship that would be a cross between the DSE and a clipper. It would depend on its large load of fast-deploying mini-shuttles or deltas for combat. None exist, but the USAF has a few designs on the drawing board.

Carrier • 1400 • 6 • 6 • Chemical, Nuclear • 6, 12 • Nuclear, Fuel Cell, Solar • 80% • 3 • 125m³ • 4 • 7 • 3 • 15 • 4 • 6 deltas or 5 mini-shuttles, 1 cargo/passenger OTV

INTERPLANETARY EXPRESS— WHEN IT ABSOLUTELY, POSITIVELY, HAS TO GET THERE THIS YEAR!

KHPRCH 75

GUNSHIPS

The battleships of space. Bristling with weapons, they enforce national policies far from Earth. Currently, the EuroSpace Agency has two under construction, the Soviets have one in lunar orbit and another under construction, and the United States has two. A third, the *Andromeda*, disappeared mysteriously after reporting contact with a massive space object of unknown origin.

Gunship • 2500 • 8 • 4 • Chemical, Nuclear • 8, 15 • Batteries, Nuclear, Solar • 80% • 4 • 200m³ • 6 • 14 • 4 • 20 • 7 • 2 DS-OTV's, 4 deltas

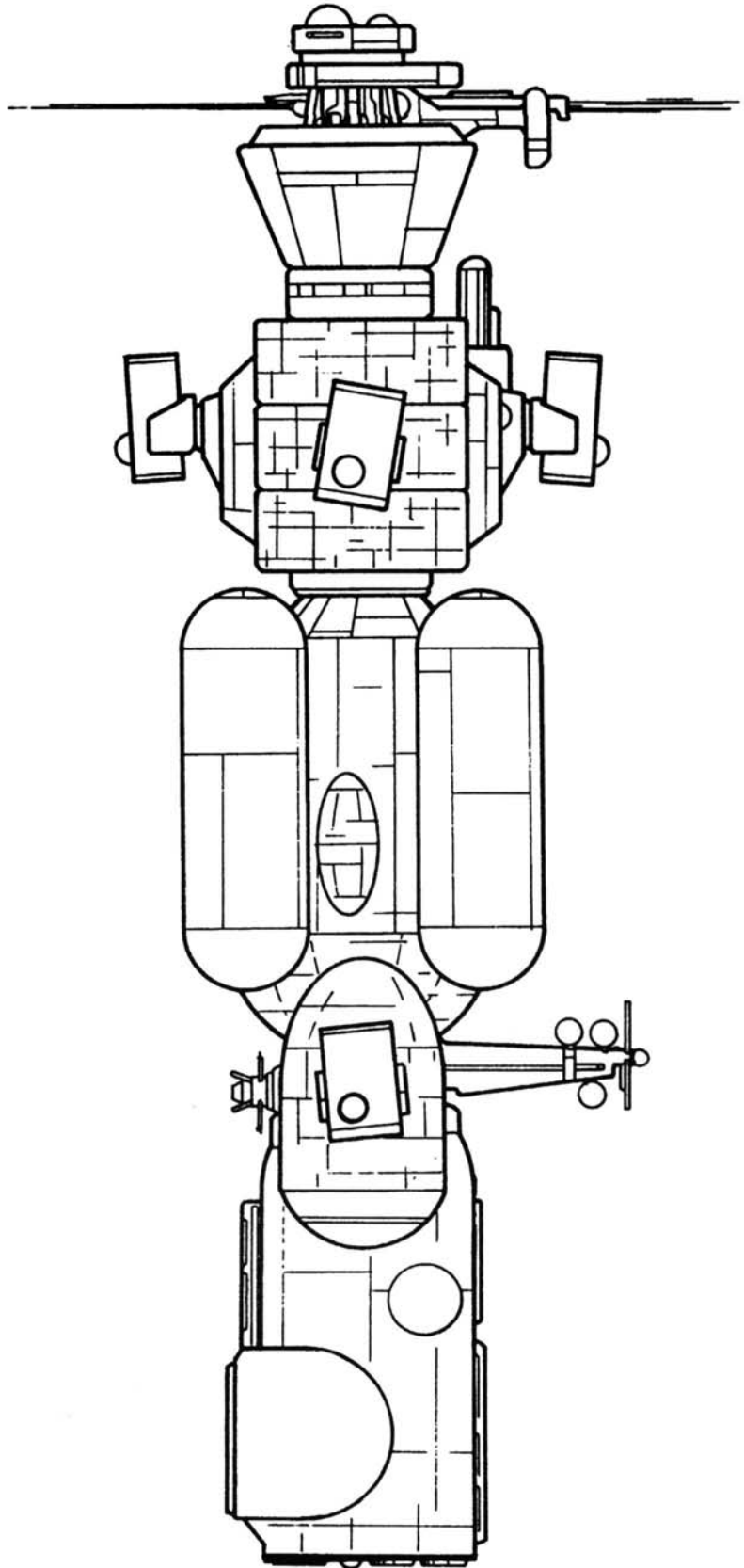

SPACECRAFT TECHNOLOGY

Spacecraft are intricate networks of systems

which interact with each other for movement, life support and combat. Often, there will be multiples of each system as backup.

DRIVE SYSTEMS

Drive systems are the main engines used by ships to move. Small movements are taken care of by thrusters (which are ignored in these rules).

Chemical engines use chemical fuels, such as liquid oxygen and hydrogen, which are combined to produce heat and pressure to produce thrust. They can react quickly, but require a great deal of fuel.

Ion engines do not produce a great amount of thrust, but can be left on for long periods, eventually developing substantial velocities. They require much less fuel than chemical engines, but have minimal maneuverability.

Nuclear engines force a fuel such as liquid hydrogen, ammonia, or water through a nuclear reactor heat source. The reactors can produce tremendous amounts of heat, and use less fuel than chemical rockets.

Solar dynamic drives use large mirrors to concentrate sunlight onto a central chamber, where fuel is heated and expelled. In many respects, it's like a nuclear engine, but in this case the reactor is the sun. They are lightweight, but the size of the mirrors makes for poor maneuvering.

Lightsails require no fuel at all, since they use the photonic "pressure" of light (solar or laser) for propulsion. The thrust is negligible, but it can be sustained indefinitely. However, lightsails have virtually zero maneuverability, and also require several square kilometers of sail area, making jammers, chaff, and flares useless.

Ships that use lightsails usually have a small chemical rocket to use when rapid maneuvers are needed.

Anti-matter engines are being developed by NASA for Deep Space Explorers, USAF for true dogfighting spacecraft, and Orbital Air for fast, cheap cargo runs. The Soviet tourist bureau, Intourist, has contracted with Orbital Air to develop a version for interplanetary tours. Anti-matter engines probably won't be available for at least another twenty years, minimum.

BURN ELEMENTS

Burn elements approximate the amount of fuel a ship has. The larger the fuel load and the less fuel a drive system uses, the greater the number of burn elements available.

POWER SYSTEMS

All spacecraft need power to operate communications, life support, weapons, etc. The type of power system used will depend on the operating environment, energy requirements, and costs.

Nuclear reactors are used when a long-term power source is needed, such as on deep space missions. They are bulky, but produce power for years.

Solar power is fairly light, and requires no fuel. Solar power is the most common kind of power for unarmed satellites and small lunar equipment. It isn't used beyond Mars, however, because there simply isn't enough light. Solar power cannot operate in planetary shadows, so solar power systems usually have substantial banks of batteries, and to a lesser extent fuel cells.

Brayton solar dynamic generators consist of parabolic mirrors which focus sunlight on fluid-filled heat pipes. The heated fluid passes through a turbine, which is connected to dynamoes. They can generate sub-

stantial amounts of power, but require sunlight and are inviting targets.

Fuel cells generate electricity and water from the recombination of oxygen and hydrogen. They are used by lunar OTVs because one oxygen tank can support power and life support requirements. On space stations, liquid wastes are often broken down by solar power into oxygen and hydrogen for use in the night portions of orbit; the fuel cell is thus acting like a battery.

Batteries simply store power generated elsewhere for use when solar power cannot operate, or as a temporary boost to any power system.

SENSORS

Sensors are used to navigate and find targets. Sensors can also be used to find scientific data. The more sophisticated the sensor, the greater the chance to find the target.

COMPUTERS

Computers are absolutely vital to interplanetary navigation, and it's almost impossible to navigate in Earth orbit (VERY DIFFICULT task), particularly with traffic, without one. No weapons can be used without computers. All ship computers require the Local Navigation program, and Deep Space ships need the Interplanetary Navigation and Astronomical Database programs. The Targeting program is necessary to fire weapons, although most defenses can be manually operated. Because of the problems with stray radiation, most ship systems have protected archive versions of their critical programs (usually the Navigation programs). Archives take ten minutes to unpack and upload per MU.

Unless otherwise stated, a ship computer has two memories, a Speed of 0, and a Strength of 2. Also, every computer will carry Local Navigation, and usually some version of

DEEP SPACE

GETTING AROUND...

Drone. Ship and habitat computers are treated like small Nets. Obviously, the smaller and more specialized the spacecraft, the smaller the Net.

WEAPON SYSTEMS

Spacecraft weapons are designed to destroy or cripple a large spacecraft. The levels of damage inflicted cause instant death for an unprotected human.

Lasers release concentrated beams of light to heat and melt the target. They can be fired long distances, but are degraded by aerosols.

Railguns use powerful magnets to hurl projectiles as hypersonic speeds. The projectile can be metal or plastic with a metal 'skirt' to grip the magnetic fields.

Missiles use heat-seeking and/or radar sensors to actively hunt targets. They deliver high-explosive or nuclear packages.

Particle Beams propel charged particles which produce both heat damage and radiation. Particle Beams are quickly dissipated in magnetic fields such as radiation belts.

Kinetic Kill Weapons fire tiny projectiles at high speed, with area effect like a shotgun. Armor is penetrated by use of fletchettes.

Note: due to their power consumption, Railguns and Particle beams require at least one non-battery or fuel cell power system to be assigned to each weapon of those types. If there

are no such systems available on board the ship, it can only fire such weapons by draining its batteries/fuel cells. This will cause the loss of sensors, computers, and life-support functions.

DEFENSES

To counter the increasing use of spacecraft weaponry, a number of defensive devices have been developed.

Armor: Layers of reinforced material draped over the spacecraft hull. While very effective, it also adds considerably to the mass of the ship, reducing the number of burn elements available. The number of armor points is subtracted from the amount of incoming damage to determine the final amount of damage. Any Armor

SPACECRAFT PROGRAM LIST

Name	Function	Str	MU	Cost
Local Nav	Navigate in planetary orbit: add strength to rolls for launch, landing and docking.	1-3	2	1000/Str
Interplanetary Navigation	Navigate between planets: add strength to success rolls. Must have Astro Database to use.	1-2	2	1000/Str
Astro Database	Planet and star data	1	3	600
Science	Compiles sensor readings for a particular branch of space science; needed for collecting and interpreting data	1	1	500
Science Database	Extensive database for a branch of science. Add strength to success rolls for collecting and interpreting data	1	1-3	200/MU
Targeting	Compiles sensor readings into targeting data. Add strength to hit roll. Weapons cannot be aimed without this program.	1-4	1	800/Str
Drone	Enables automatic/remote operation. Requires code to access system. Levels listed below.			
Level 1	Local Navigation only, Pilot +1, Grey security	1	1	2000
Level 2	Local Navigation only, Pilot +3, Grey security Can operate flares/chaff	2	2	4000
Level 3	Interplanetary Navigation, Pilot +1; Local Navigation, Pilot +3 Can perform any defensive action, level 1 security	3	3	6000
Level 4	As level 3 plus weapon operation at -2 using targeting program. Level 2 security.	3	4	8000
Level 5	As level 3 and can perform all actions without cost. Black security, currently only available to USAF	4	4	15000+

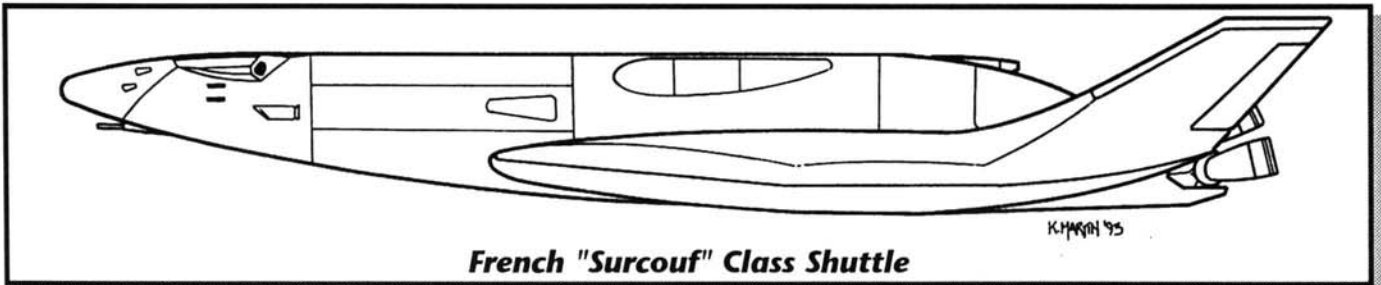

French "Surcouf" Class Shuttle

doubles the cost of maneuvers; this cost is not reduced when all the armor is lost. For those who insist on it, spacecraft Armor is worth roughly 10 SP per point. Whenever Armor is penetrated, one point (10 SP) is lost.

Chaff/Flares: Used to fool sensors and missiles. Chaff consists of millions of strips of aluminum cut to radar wavelengths, causing thousands of targets to appear. Flares produce heat at spaceship frequencies, causing sensors to be confused and (hopefully) track the flare instead of the ship. Chaff and flares last for three turns. They are usually fired together. A chaff/flare dispenser has five charges. Causes -10% to attackers lock-on roll (-15% for missiles) for three turns.

Countermissiles: Miniature missiles which are designed to intercept other missiles. They are fired in groups to increase the chance that at least one will hit. Successfully destroys incoming missile on a roll of 1 from a 1D10. Countermissiles cannot be fired unless there is an incoming missile. Kinetic-kill weapons can also be used in the counter-missile role. This has a 2 in 10 interception chance, but you cannot have fired the weapon offensively in the same turn.

Aerosols: Aerosols are opaque gases used to degrade lasers. While very effective, they tend to dissipate quickly. Aerosols last for four turns; subtract the number of turns since launch from 5 to determine the reduction in laser damage. Aerosol dispensers have five charges. Cumula-

tive -10% for lasers to hit per charge. This also affects the firing ship. The benefit of an aerosol is lost if the firing ship performs an Evasive maneuver or Decrease Range. "Stardust" is just coming into use with some ships: scientifically-produced glass crystals with the same effect as aerosols. They take six turns to dissipate, but cost four times as much.

Jammers: Jammers send out electronic signals to scramble enemy sensors. They require a non-battery/fuel cell power system for full effect (-30% to sensor rolls). If operating on stored power, their effect is halved (-15%).

DAMAGE POINTS

Damage Points are a generic measurement of the types/amount of damage a ship can take. Each ship damage listing shows the order in which systems are damaged. Slight variations are possible, although the vast majority of damage will occur to the burn elements.

Each ship also has a certain number of "overkill" points. These determine the likelihood of explosion, should a ship be sufficiently damaged. Whenever all the systems listed are hit, a D10 roll (equal or less than the remaining "overkill" points) must be made to see if the ship explodes. A ship only need roll in the turn it is hit.

INSIDE A SPACECRAFT

Most of the interior volume of a spacecraft is uninhabitable and is utilized by fuel and engines. Interior walls will be one of two types: partitions or bulkheads. Partitions are simple dividers; often, they aren't even sound-

proof. Bulkheads are structural members. Partitions have an SP value of 4, and must take 15 points of damage to make a hole large enough to pass through. Bulkheads have an SP value of 8, and require 30 points of damage to make a man-sized hole.

Partition doors are NOT airtight, but bulkhead doors are. Bulkhead doors also provide an effective seal against biotoxins (except those that eat the seals, of course). Some bulkheads, particularly those surrounding nuclear drives, power systems or flare shelters, are marked as radiation resistant. These have triple value with respect to radiation.

PURCHASING, OUTFITTING AND MAINTENANCE

A spacecraft is a major investment. Even an OTV can exceed a million dollars, while larger craft can only be afforded by the larger corporations or national governments. Used spacecraft typically cost 30-80% of new, depending on age and condition. New spacecraft also require time: a few months for an OTV, and several years for Deep Space Ships. Once a ship has been purchased, new or used, it can take months to customize and outfit for the individual user.

In addition to the initial costs, maintenance can take a substantial amount of money. Ten percent of the initial cost per year for a new craft, and double or triple that for a used spacecraft, is not unreasonable. Maintenance is time-consuming, and failure to spend the cash or time can be deadly.

ORBITAL MECHANICS IN THREE EASY LESSONS

LESSON ONE: TYPES OF ORBITS

LEO, short for Low Earth Orbit, is that region from about 150 km to 2000 km. Most workshacks are found here, as well as some orbital transfer stations.

GEO, short for Geostationary Orbit, is where a satellite over the equator will stay over the same spot on Earth. Virtually all communications and weather satellites are here, as well as a few workshacks. There aren't too many permanently manned stations here, as this orbit (also known as the Clarke Belt) is still within the outer Van Allen radiation belt.

High orbit is anything above GEO, such as the O'Neills. Some workshacks are here, as well as Crystal Palace. Luna is in High orbit.

Polar orbit circles around both poles, eventually passing over every point on Earth. Weather, resource, and spy satellites occupy this orbit, which is otherwise the same as a Low orbit. Polar orbits take more fuel to reach, so ships launching into a polar orbit cannot carry as much cargo.

Hohmann orbits, named for the German scientist who studied them, are elliptical orbits which use the minimal amount of fuel to travel from one point to another. They trade fuel for time. Essentially, the time to travel using a Hohmann orbit is half the average orbital period of the departure and arrival points, assuming they are in reasonably circular orbits.

Fast Transfer orbits travel between points as quickly as possible, but use tremendous amounts of fuel. They are seldom used, because once the fuel is loaded, the ship has almost no room for cargo.

Solar orbits are simply orbits around the Sun. Discarded fuel tanks, nuclear

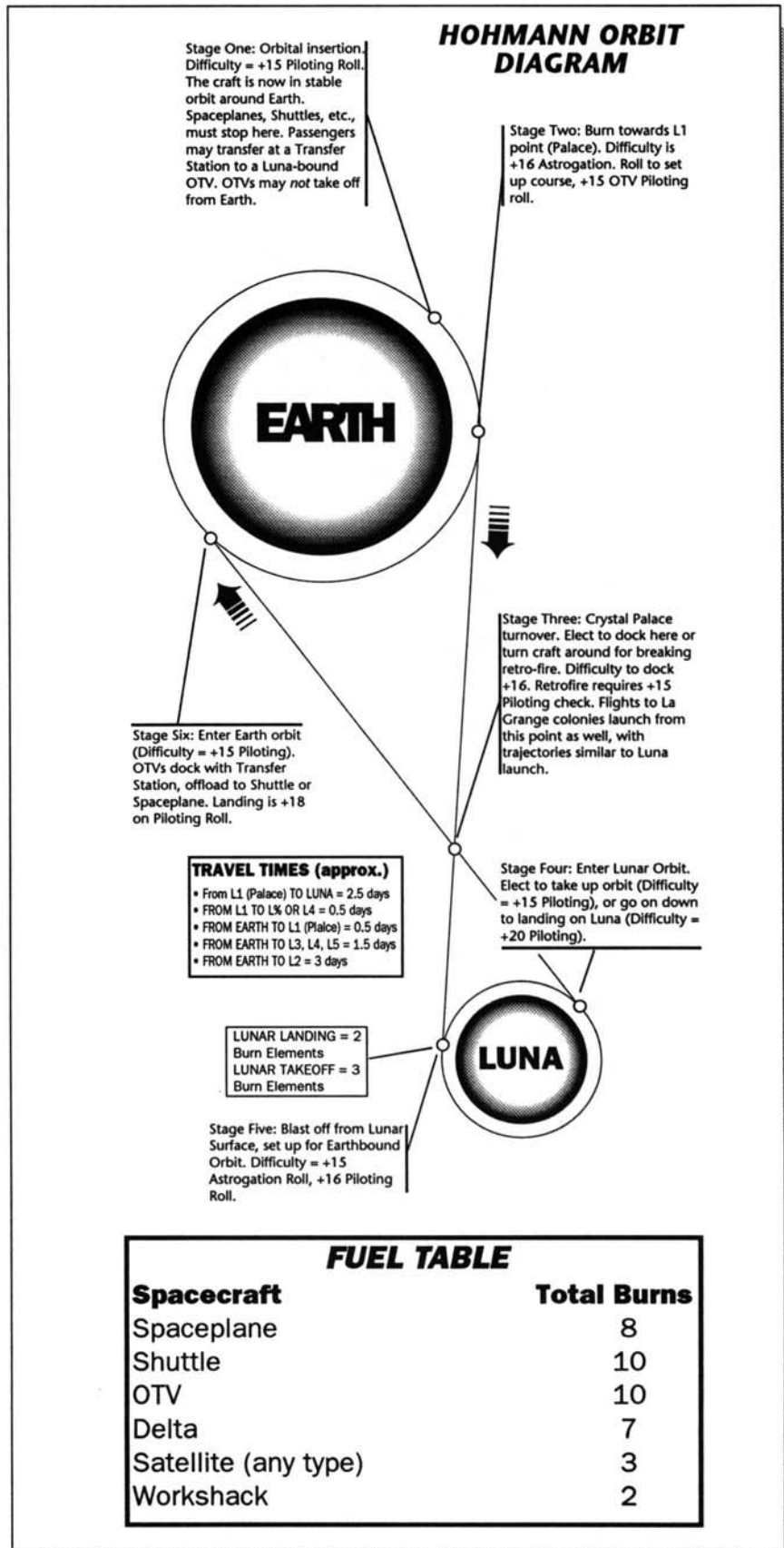

METEOR DAMAGE TABLE

Roll	Damage
01-50	1DP
51-75	1D6/2 DP
76-90	1D6 DP
91-95	1D10 DP
96-98	2D10 DP
99	3D10 DP
00	5D10 DP and roll again!!

Because they travel so fast, armor is of negligible effect against meteors; treat as half value. Regardless of armor value, a meteor will always do 1 DP.

PLANETARY RING HAZARD RATINGS

Saturn's Rings	Rating
A	5
B	0
C	2
D	2
E	0
F	0
G	0

Uranus' Rings	Rating
#1	0.1
#5	0.1
#4	0.1
alpha	0.1
beta	0.1
n	0.1
r	0.1
s	0.1
e	0.1

Note to Ring Hazards: these are approximations for game play and not direct representations.

THE HIGHER COSTS OF SPACE TRAVEL

Travel between planets is the province of government, the larger corporations, and the obscenely wealthy who have nothing better to do with their money.

One-Way Trips, from Earth (Euro Dollars):

Destination	Passengers			Cargo	
	Coldsleep	Coach	First Class	1kg	Ton
Mercury	28000	45000	75000	240	220000
Venus	14000	25000	40000	135	100000
Mars Orbit	15000	30000	50000	150	110000
Mars Surface	20000	35000	58000	180	130000
Ceres	25000	42000	70000	225	200000

The Mars trips assume a Venus fly-by. For Hohmann orbits, add 8%.

that way. Instead, a spacecraft from somewhere else can fly by a planet and gain speed—not relative to the planet (that remains the same), but relative to the Sun (making it a three-body problem: spaceship, planet, and Sun). The spacecraft gains a part of the planet's momentum around the Sun (consequently, the planet loses speed and moves a *tiny* bit closer to the Sun).

Gravity whips aren't always convenient or available, but when they are, they can realize substantial savings in time and fuel. Look at the Mars trip—a minimum-energy Hohmann is 971 days round-trip, but Mars via Venus is only 510 days (granted, the stay time is cut from 455 days to 10 days, but by then you'll have probably seen and done everything you wanted to, anyway).

HAZARDS OF SPACE TRAVEL

Space is fairly benign, if you pay attention to what you're doing. Still, a number of unpleasant events can surprise even the experienced traveller.

METEORS

Meteors aren't as common as you'd think. There is a lot of space out there, and very little to fill it up. Still, collisions do occur. Most particles will be the size of a grain of dust, or even smaller; collision with these particles

will occur several times a day, and do little more than make pock marks in the paint. Rarely, sand grain-sized particles or larger appear, and can do considerable damage. For every day in space, there is a cumulative 0.1% chance of a collision with a sufficiently large particle to worry about; this increases to 0.3% while in the Main Belt. Objects in Earth orbit must also roll for collision. If a collision occurs, roll on the table in the sidebar to see the damage that results.

ASTEROIDS

Asteroids are sufficiently large to be picked up on sensors and avoided. In fact, the Interplanetary Navigation program does this automatically. Asteroids will be extremely rare. If a ship hits an asteroid, there's little point in worrying about it.

PLANETARY RINGS/COMETS

Planetary ring compositions vary from dust to building sized boulders. Each ring has a Hazard Rating, (See Sidebar) which is the number of D6 to roll per hour while travelling through it. If the rating is less than 1, add the ratings cumulatively per hour traveled, and roll when the sum is equal to or greater than 1 (rolling resets the sum to zero). Comets are similar to asteroids, but their dust and vapor trails act like planetary rings. Comets have a Coma Hazard Rating, which is the number of D6 to roll per hour as a ship passes through the comet.

and toxic waste, and other assorted trash tends to end up in solar orbit.

LESSON TWO: SPACE NAVIGATION MADE SIMPLE I—EARTH ORBIT

Unlike the spaceships from science fiction movies, *Cyberpunk* spaceships have to deal with limits on fuel, orbital trajectories, and braking fire. Shown is a typical trip from Earth to Luna, called a Hohmann Figure 8. Each of the dotted points is a point where two things occur. The pilot of the spacecraft must first calculate his course (an Astrogation roll), then burn fuel to make the course changes he wants.

Rather than deal with complexities like delta-vee, constant boosting versus using gravity whips, and other astrophysicist's nightmares, we've simplified fuel consumption into what are called "burn elements." Every time a spacecraft makes a course change, it expends one burn element of fuel. When it is out of "burns," it can no longer change course.

A standard course from Earth orbit to lunar orbit would use up three burn elements: one to leave orbit, one to turn around at the halfway point (notice how the Crystal Palace just happens to be in the L1 halfway point?), and one to get into stable Lunar orbit.

Taking off from Earth uses up four burn elements, while reentry uses up three. This is one reason why spaceplanes, shuttles, and deltas are unable to do much more than take off, make a few orbits, and land. Landing on Luna would use an additional two elements, while take-off would use three. Martian burn costs are similar to Luna's.

LESSON THREE: SPACE NAVIGATION MADE SIMPLE II—INTERPLANETARY TRAVEL

Interplanetary travel requires substantial amounts of patience. You simply cannot travel between planets in a hurry.

THE HIGH COST OF SPACE TRAVEL

More than fifty years after Neil Armstrong planted the American flag on Luna, space travel is still prohibitively expensive. It's more than a simple trip to the store—there are fundamental differences between space travel and terrestrial travel that

will ensure space travel stays pricey for years to come. On Earth, gravity is generally your friend, but in space it is a persistent enemy.

Warning: These are not actual orbital mechanics; they are simple simulations of the real thing. This is a role-playing game, not an astrophysics course.

TRAVEL COSTS

One-Way Trips, from Earth (Euro Dollars):

Destination	Passengers		Cargo	
	Coach	First Class	1kg	Ton
LEO	1500	2500	50	40000
GEO	2500	3000	65	50000
L1	2500	3000	70	53000
L2-5	3000	4000	70	53000
Luna Orbit	4000	5500	80	60000
Luna Surface	5000	7500	95	72000

Discounts: Ah, ha ha ha, Mon Ami! Surely, you jest! Highriders get an average 8% discount (because they know all the right people).

Orbital Air employees get a 5% discount on Orbital Air flights. Corporations can buy in bulk (usually 100 million passengermiles, non-refundable, cash up front) for a 15% discount. Some travel companies offer frequent-flyer discounts.

There are two techniques which reduce fuel consumption and increase speed and cargo mass: aerobraking and gravity whips.

AEROBRAKING

It takes tremendous amounts of fuel to move from planet to planet (and fuel to move the fuel, and fuel to move that fuel, and so on). In fact, fuel occupies better than half a ship's mass. By minimizing the amount of braking fuel, the cargo load can be increased, or a ship can move faster, for a given fuel load. The ship, upon arrival, dips into the planet's atmosphere, converting kinetic energy into thermal energy. The use of an aerobrake can double a cargo load, even after accounting for the mass of the aeroshield. The *Leonov* in the

movie *2010* used an aerobrake. Specifically, the *Leonov* used a ballute (a collapsible aeroshield); unfortunately, no known material is even theoretically capable of withstanding such stress, yet still be inflatable.

GRAVITY WHIPS

Gravity whips allow a spacecraft to "steal" momentum from another body. A common fallacy in science fiction is when a rocket dives toward the planet it's orbiting to gain enough speed to break free of the planet's gravity. Unfortunately, it isn't that simple. By the time the spacecraft again reaches the altitude it started at, it has lost all the energy it gained by diving in the first place. It isn't a two-body (spaceship and planet) problem; there can't be any net gain

SOLAR FLARES

The Sun periodically erupts like a volcano, only instead of lava it throws energized protons. For those on Earth, it's barely noticeable. Large space stations and the O'Niell habitats have flare shelters, as do the deep space ships. The lunar bases are covered with slag, and the Mars bases are covered by the Martian sands and the Martian atmosphere. But for those unlucky folks in an OTV halfway between Earth and Crystal Palace, don't plan on having too many children. Fortunately, those travelling near a planet with radiation belts can subtract the average strength of the belts between the ship and the Sun (counting the strongest one twice) from the strength of the solar flare; the downside is that the ship is moving and won't stay in a belt for long, and there is the chance that more radiation will be received from the belt than from the Sun. In addition, everyone can divide their current distance from the Sun by 150,000,000, then divide the flare strength by the result, rounding up, to find the effective flare strength.

RADIATION BELTS

Planets with strong magnetic fields, like Earth and Jupiter, tend to collect charged particles in rings known as radiation belts. The stronger the magnetic field, the stronger and more numerous the radiation belt; Earth has two, Jupiter has ten. Each belt has a characteristic Strength; this is the number of times per day a roll on the Radiation Damage Chart is made. For example, Earth's inner and outer belts are Strength 2 and 1. On the other hand, Jupiter's second belt (they are measured from the planet going out) has a Strength of 10, so every 2.4 hours the players roll on the radiation chart to see how many rads they took. In fact, this belt has a true strength of more than 20; this has been reduced for playability purposes. Players must roll at least once for every belt they pass through. Armor and spacecraft walls reduce this damage.

RADIATION DAMAGE CHART

The amount of Armor, and the armor value of all the partitions and bulkheads between the explosion and the person is subtracted from the number of rads taken, with a minimum of 0.1 rad. For computers, partitions count as 0.1 Armor and bulkheads 3 Armor; for every 10 full points of Armor, the effects are reduced by one level (minimum 0). The effects on computers are cumulative, and each computer rolls separately.

Roll	People Effects	Computer Effects (Cumulative)
0	0.1 x D10 Rads	Down for 1 turn on a 6 (roll D6)
1	1D6/2 Rads	Down for 1D6/2 turns; Easy roll on Jury Rig or Electronics to reactivate
2	1D10/2 Rads	Down for 1D6 turns; Easy roll on Jury Rig or Electronics to reactivate
3	1D6+2 Rads	Down for 2D6 turns, Sensors blind for 1d6/2 turns; Average roll on Jury Rig or Electronics to reactivate
4	1D10+2 Rads	Down indefinitely, Sensors blind for 1D6 turns; Difficult roll on Jury Rig or Electronics to reactivate
5	3D6 Rads	Down indefinitely, Sensors blind for 2D6 turns and at -10 for 5d10 turns thereafter, 1D6/2 Memory areas erased; Very Difficult roll on Jury Rig or two consecutive Difficult rolls on Electronics to reactivate
6	3D10+5 Rads	Down indefinitely, Sensors blind 3D10 turns and at -20 for 20d10 turns thereafter, 1d6 Memory erased; Nearly Impossible roll on Jury Rig or two consecutive Very Difficult rolls on Electronics to reactivate
7	5 x D10 Rads	Down indefinitely, Sensors blind 10D10 turns and at -40 permanently thereafter, all Memory erased; Nearly Impossible roll on Jury Rig and two consecutive Nearly Impossible rolls on Electronics to reactivate
8	8 x D10 Rads	Computer crippled beyond repair, Sensors destroyed, all Memory erased

RADIATION BELT STRENGTHS

<u>Jupiter Belts</u>		<u>Rad Str</u>	<u>Saturn/Uranus/</u>	
<u>Neptune Belts</u>		<u>Rad Str</u>		
#1	5	#1	4	
#2	10	#2	4	
#3	9	#3	4	
#4	7	#4	3	
#5	5	#5	1	
#6	4			
#7	4			
#8	3			
#9	2			
#10	1			

Note to Radiation Belts: these are approximations for game play and not direct representations.

"THE GREAT GALACTIC GHOUL"

Spacecraft travelling between Earth and Mars occasionally spontaneously develop 'glitches' in their operations, leading some to refer to the "Great Galactic Ghoul" that lives there. It was first noticed in the 1960s, when two Soviet probes mysteriously went dead and Mariner 4 developed unexplained control problems. In 1969, Mariner 7 disappeared from the tracking scopes; it reappeared seven hours later, on a slightly different trajectory and with a reduction in its data transfer rate. Mariner 9, the first vehicle to provide up close pictures of Mars, mysteriously broke guidance lock but regained it. Later, one Soviet Mars lander failed to activate its retro-rocket and sailed on past, and another stopped working twenty seconds after touchdown, in spite of near-perfect health. In Earth orbit, the Pegasus 1 satellite (which had been shut down) began operating again. The Ghoul then quieted down until the first manned mission to Mars in 2009, when all the loudspeakers began blaring "Yankee Doodle Dandy" (a selection NOT in the computer) for nearly a minute at full volume. The odds of the Ghoul appearing, and the effects of the appearance, are entirely at the discretion of the referee.

SPACE COMBAT

"Lt. Buck Yeager brought the delta screaming around in a tight dive, releasing both of his wingtip missiles at the incoming Kosmos battlesat. The Soviet war machine spun back and out of range, firing its own deadly barrage of tracers ..."

Forget it.

Real space combat isn't going to be like that at all. The realm of real space combat will be one of computers, not men. At nanosecond speeds, no mere human mind can begin to assimilate the needed data fast enough to match trajectories, lock on, fire, and run

defenses. Warfare on the High Frontier will be a duel of wits and shifting strategies, punctuated by instantaneous destruction by weapons designed to stop a multi-ton ICBM in one shot. The human element is reduced to intuition, strategy, or freeze-dried hamburger.

COMBAT SEQUENCE

Space combat breaks into five parts: Trajectory, Weapon Lock-On, Action, Resolution, and Damage Allocation. All five parts take place within a standard 10 second Friday Night Firefight turn.

TRAJECTORY

In this part of the turn, the relative trajectories of the combatants are determined. Whether approaching in deep space or closing in on a Low Earth orbit, your trajectories are limited to:

- 1) Attacker closing, target stationary.
- 2) Target closing, attacker stationary, waiting for a shot.
- 3) Target moving, attacker following from behind.
- 4) Attacker overtaking the target from behind.
- 5) Both approaching head on.
- 6) Attacker perpendicularly intersecting the trajectory of target.
- 7) Target pulling away from attacker.

Determine how far apart the combatants are at the initial point of intercept. The initial separation is determined by $1000 \text{ km} + 3D10 \times 150 \text{ km}$. Note that this assumes that the attacker and target are in approximately the same orbit, going the same direction; if one were going retrograde to the other, they would pass each other too quickly to lock on and fire. In general, a satellite in Low Earth Orbit (LEO) will be orbiting at about 3000 km above the Earth. The maximum range of any of the standard space weapons is 1500 km, except for the Particle Beam; the range for a Particle Beam is 1500 km divided by the strength of the Radia-

tion Belt the firing ship is in. This means an intercepting delta will have to cover much of this distance before it can launch an attack. Objects in Geostationary Orbit are 38000 km out, requiring an even longer trip to knock out most stable work platforms and satellites. Objects in Deep Space are out of reach by anything other than another Deep Space ship.

It is assumed in these rules that spacecraft move at 15 km per FNFF combat phase (about 3 seconds) relative to each other. This would mean that a delta would take about 200 phases (600 seconds/10 minutes) to climb from Earth to LEO, get a lock on, and shoot.

WEAPON LOCK-ON

In this part of the turn, both sides attempt to detect and lock weapons onto each other. To lock-on to a target, you must roll equal to or less than the current base detection ability of your ship's sensors. This is then modified according to Radiation Belts (-5 times Belt strength) and Solar Flares (-5 times Flare strength). It is then modified by range (-5 per 500 km or fraction after the first 500 km), jammer use (-10 per jamming point) and finally a bonus if it was detected the previous turn (+10).

Missiles must also roll for lock-on each turn after launch, with a base chance of 80%. Without a lock-on, you cannot attack a target. You can tell something's there, but you can't get a good aim. Example: A USAF delta is tracking a Kosmos XII battlesat, using a Militech StarTrak 5 sensor (base 55%). The satellite is in the Inner Van Allen Belt (strength 2, -10). There is no Solar Flare (-0), the satellite is about 1600 km away (-20), it isn't using a jammer (-0) and it was tracked last turn. The chance for the delta to detect the battle sat is $(55 - 10 - 0 - 20 - 0 + 10) = 35\%$. The pilot rolls a 50, and the battlesat fades from the scope, at least until next turn.

ACTIONS

In this part of the turn, combatants program their computers for the most appropriate response. The number of options that can be selected per turn is listed in the ship description. To avoid any confusion, both sides should write down their selected actions and reveal them at the same moment. Actions take place in the order they are written down, with defensive actions taking priority. A player can always opt to do nothing.

Increase range: Fire the engines to alter the distance between ships. Subtracts 15 km/phase from the movement rate. Note that when the ship's movement rate is negative, it is moving away. An Increase Range cancels an attacker's Decrease Range. This action uses one Burn Element.

Evasive Maneuver: -10 to hit roll for both attacker and defender, and use two Burn Elements. This can be used by ships with damaged drive systems, since it uses auxiliary thrusters.

Decrease range: Fire the engines to get closer. Adds 15 km/phase to speed. This cancels an Increase Range. Requires one Burn Element.

Activate Defense: There is no limit to the number of defenses which can be used each turn, but any given defense can only be activated once per turn. Remember that many defenses affect the defender's weapons as well.

Fire weapons: Fire one or more weapons. There is no limit to the number

of targets that can be fired at, but any given weapon can only be fired once per turn. Obviously, you need enough power in order to fire railguns and particle beams. You must have detected/locked-on the target in the turn of firing.

MOVEMENT

Because of the abstractness of this system, it is impossible to keep track of the true relative positions of spacecraft. It is also unnecessary, since ships can change their attitude and fire in any direction. There are no dogfights in space.

Once the initial separation is determined, keep track of any engine burns that alter range. This will affect the time that missiles take to hit their targets. Missiles accelerate to 100 km per phase, and move after all other actions.

COMBAT RESOLUTION

Once the actions have been determined, look at the Weapon Hit Chance chart to determine the base hit chance for each weapon.

DAMAGE ALLOCATION

Once it has been determined which weapons have hit, the amount of damage and its location is determined. This is done by rolling the number of damage dice, subtracting the value of any armor, then marking off letters on the ship's damage chart.

WEAPON HIT CHANCE

Weapon	Base Chance	Damage
Laser	70% or less	4D10
Particle Beam	60% or less*	5D10**
Kinetic Kill	60% or less	3D10+5
Railgun	50% or less	7D10
Missile	50% or less	6D10

* Particle Beams reduce their Base Chance to hit by -5% per Radiation Belt strength and by -5% per Solar Flare strength.

**P-Beams also do D6 rolls on Radiation Damage Chart. Actual damage points are divided by Radiation Belt Strength, if any.

Each damage point marks off one letter on the chart, which are different for each ship type. The letter codes indicate the loss of a particular system: B= Burn Element, W= Weapon, D= Defence, P= Power, S= Sensor.

One of the given type of system is lost for each hit, except for Sensors, which lose 15 percentage points from their capability per hit, and Burn Elements. When there is a multiplier in parenthesis, that many elements are lost for one damage point. Very large or modular targets such as habitats are divided into sections which are considered separately. Gradually, ships become less and less able to fight. For example, if a Gunship takes six points of damage, two burn elements are lost from the first point of damage, then a weapon, then one more burn element, then a power system, then two more burn elements, and finally another weapon. Although that is a

SHIP DAMAGE CHARTS

Shuttle: (Bx2) W B S B P B D B W B S 4 3 2 1

Mini-shuttle: B W B P S 3 2 1

Spaceplanes: B W B P B D B 3 2 1

Delta: B W B P B 2 1

Landers: B W B D B 3 2 1

Cargo/Passenger OTVs: (Bx2) W B D B 3 2 1

Deep Space OTV: (Bx2) W B D B W B 4 3 2 1

Work Module: B W B 2 1

Flitter: B B B 1

Deep Space Explorer: (Bx2) W (Bx2) D B S B P B S B W B D B 6 5 4 3 2 1

Cycler: B W B P B D B S 4 3 2 1

Clipper: (Bx2) P B W (Bx2) D 2 1

Gunship: (Bx2) W B P (Bx2) W B D B S B W B P B S B D B S 7 6 5 4 3 2 1

Carrier: (Bx4) W (Bx3) P (Bx2) W B S B D B S B W B 4 3 2 1

Cargo Drone: (Bx2) P (Bx2) P (Bx2) P 2 1

Battle Satellite: W B W P W D 2 1

total of eight damage elements, a few of the burn element hits do double damage. The Gunship is still in action, although it is reduced in maneuverability and has lost some weapons. If there are multiples of a system type, the player chooses which one is hit; in the above example, either the batteries, the nuclear reactor, or the solar power unit would have been rendered inoperative on the power hit. If a ship doesn't have a given type of system, that damage point is lost. Eventually, when all damage elements are gone, the ship is a useless hulk. Any damage that goes beyond the last letter on the chart is marked as "overkill points." At the end of the turn in which a ship's final damage element is lost (or any later turn in which it takes overkill damage), roll 1D10. If the roll is greater than the overkill points remaining, the ship explodes, with lots of secondary explosions for effect.

It doesn't matter whether there is still any unused fuel or weapons to explode—what's the point of dying if you can't do it in style?

KILLS/CRIPPLES

When a ship has lost most of its drives and power, it is considered crippled. When it can no longer move or fire weapons, it is considered killed, whether or not there are still people alive. Killed vehicles are generally not worth salvaging.

NUCLEAR WEAPONS

Nuclear weapons aren't used on Earth because there simply isn't enough room and there are too many governments waiting to crack down on anyone who even thinks about it. Of course nobody worries about the vacuum of space. Sure, there are treaties against the use of nuclear weapons in space, but once it's been popped, where's the evidence?

A nuclear explosion unleashes a fearsome wave of radiation which fries electronics, computers, equipment

and personnel alike. If a nuclear detonation occurs, everything within a 5 km radius is exposed to radiation levels in excess of 10,000 rads (15 rolls on the Rad Damage Chart, pg.45); between 5km and 10 km this drops to 5,000 rads (7 rolls); and from 10 km to 20 km 2,000 rads (3 rolls, all rolls are 1D6+2).

This is modified by shielding such as armor, large masses such as an asteroid, or to a lesser extent by a ship.

DEPLOYING DELTAS/ SHUTTLECRAFT

Gunships and Carriers can drop one delta every other turn, in addition to other actions. It takes ten turns to retrieve a delta; only one can be retrieved at a time. Deltas can begin performing actions two turns after being dropped.

COMMUNICATIONS

In the latter half of the twentieth century, the need for communications exploded like a bomb. In the first half of the twenty-first century, it was a nuclear bomb. Even the fastest spacecraft, travelling nearly 100 kilometers per second, can take months to travel between planets. On the other hand, radio waves can usually get there in minutes. A radio map of the solar system would have three bright spots (the Sun, Earth, and Jupiter), and thousands of smaller points, like salt spilled on black felt. Radio is also substantially cheaper—a letter from Earth to Mars might cost 100eb and take months to get there, but a non-priority message can be sent by radio for 10 euro and be received within a few days or even hours, depending on traffic.

LAG TIME

On the other hand, as fast as radio is, it still isn't fast enough. Travelling at nearly 300,000 km per second, it can still take hours to reach the outer planets. A spacecraft in trouble be-

tween planets is isolated. Having a conversation over interplanetary distances is like voice mail—you never talk to a person, you only send and receive messages.

The planetary descriptions in *The Solar System, 2025* section include one-way communications delay times (called lag times) to Earth. These are, of course, all approximate. To figure out the lag time between any two points you should really work out their relative positions in orbit, then calculate the distance.

To approximate the lag time between two other planets assume it will be somewhere between the difference of the two values given from Earth (closest orbits) and the sum of these values (furthest orbits). Either be pedantic or take the average of these numbers. It's up to you.

Also, communications will always be cut off while two planets are furthest away, since the Sun blocks radio signals.

NETRUNNING

Netrunning from Earth to low-orbiting satellites is no problem. Netrunning to geostationary satellites produces a noticeable delay (-1 REF). Netrunning to Crystal Palace produces a significant delay (-3 REF). Netrunning to Luna or the O'Niells is rather hazardous (-4 REF). Netrunning beyond lunar orbit is virtually impossible (-20 REF to Mars, -50 REF to Jupiter, and so on).

That's not to say communication is impossible—it's just that nodes more than a few hundred thousand kilometers away have an unacceptable time delay that you just can't avoid; besides, there aren't any long-distance links past Luna (except on some spacecraft), so you have to "walk" there. When delays start reaching several minutes, you can't even hold face-to-face conversations.

TAPPING INTO THE OTHER SHIP'S NET

A ship's computer can be tapped into, just like a computer on Earth. Computers remain in constant communication, even at interplanetary distances. Real-time netrunning, however, is virtually impossible unless the two computers are in close proximity, due to the lag time. Otherwise, a ship's computer is treated like a data fortress, or a mini-net. Military computer communication is encrypted, and the computers can be isolated, making them impossible to tap remotely. They can also detect which antenna is receiving the signal; if it's in the wrong direction, it will alert the security officer.

PSYCHOLOGICAL EFFECTS OF LONG DISTANCE TRAVEL

Interplanetary travel is a more secure confinement than any prison. Once you've started, there's no turning back—you don't have the fuel. Most of the time will be spent in coldsleep, either frozen or in braindance, so there's no problem. But the non-"corpse-sicles" left awake as monitors will be alone. Day in and day out, except for a few days at arrival and departure, there will be the same monotonous view out the windows, and only the computer or a few other thawed people to talk to. Such isolation, for months at a time, has caused some to go insane; the captain of the early cyler ship *Explorer 1* destroyed the coldsleep controls, killing many of the 94 passengers and crew in 2024. Sending and receiving messages just isn't the same as person-to-person contact. This is resolved by periodically rotating the awake and coldsleeping crew.

BRAINDANCE USE

The braindance is probably the single item most responsible for allowing human travel through deep space. Coldsleep doesn't actually freeze people (which would cause irreparable tissue damage), it simply chills

them to the point where their metabolism is virtually nil. The brain, however, remains fairly active. Without stimulation, the mind begins to dredge up all sorts of unpleasant things. The braindance allows an individual to function within a virtual environment, providing all the stimulation a body would want. This allows the crew to monitor the ship while in coldsleep, for example (although only the awake crew could take action). Virtual environments allow passenger ships to provide a full itinerary without having to actually provide facilities (which would make the ship too large and heavy).

INTERSTELLAR TRAVEL

As of yet there is no way to travel to another star within a reasonable period of time. Currently the most distant spacecraft is the long-dead robot Voyager 2, about eight billion miles distant. That record will soon be eclipsed by Project TAU, launched nearly twenty years ago, which will travel a thousand Astronomical Units (hence the name; an AU is about 150 million kilometers), looking for the heliopause, where the solar wind merges with the interstellar medium, the true limit of the Solar System. The EuroSpace Agency has contracts for the design of a generation ship, based on anti-matter drives, currently under development. These ships will take hundreds of years to travel to another star and only the children of the children of the children of the original crew will see the destination star close up. There has also been a proposal for a similar type of ship, which will maintain frozen embryos until it gets near the star, then revive them, grow them to adult, and train them to explore.

Note: to change Near Orbit/Deep Space into a trans-solar scenario, merely add a "jump drive" which must be used at the edge of the solar gravity well, requiring a year long trip out and a year long trip back.

But They Tried...

Perhaps the greatest long-distance effort ever made was that of "Brain-Dead" Gutierrez, who linked into Voyager 2 in 2008. Since there are no long-distance links out there, he had to "walk" the whole way. Fortunately, his father was senior vice-president of LunaComm, a company which specializes in space communications. "Brain-Dead" concocted a virus that ordered one of LunaComm's Farside antennas to track Voyager 2 for nearly a whole lunar night (14 days). He had a med-tech friend hook up an IV for food, water and stimulators, and he jacked in. Even when you consider the tremendous speeds in Netspace, it took him ten days to make the journey. The trip almost ended when a technician noticed the antenna tracking a "non-client", but he chose to trust the computers. Voyager 2 didn't have enough brains for him to do much, but he did manage to leave a calling card. A few weeks later, a routine data dump received by NASA included two pictures: a picture of a camel, then the same camel exploding, with the caption "See how far I went to smoke a Camel???" He had lost several pounds and his father got demoted, but his nearly seven billion-mile link is a feat impossible to beat.

Realistic Delays

A truly sadistic Referee could impose a real delay. For example, while netrunning to Crystal Palace, the Referee could impose a one-turn delay on actions by the 'runner. For netrunning to Luna, there could be a two-turn delay. Characters 'running to Mars would discover that the ice had already eaten them before they were even aware they had arrived.

4

*Spacesuits. Skinsuits.
Slap patches. EVA
Units. Without these,
you're not going
anywhere in space...*

EQUIPMENT & WEAPONS



EQUIPMENT

Tools, weapons, and equipment are necessary in space just as they are on Earth. While lots of things can be just as they are, many more need to be modified to account for the space environment.

SPACESUITS

Without a spacesuit, you're not going anywhere in space. Modern spacesuits are designed to keep a standard atmosphere around both the head and body areas, and to maintain temperatures within a comfortable range, despite environmental extremes.

There are several types of spacesuits. **Standard suits** are the general-issue spacesuits, used by nearly everyone. They maintain a 3psi pressure both in breathing and body areas, as well as keeping body temperatures within livable ranges irregardless of environmental extreme.

Skinsuits are used by tourists and for short trips, or where agility is necessary (such as Delta and work module pilots). They are skintight, tough rubberized coveralls with a simple helmet and a 40-60 minute air supply. The surface tension of the suit holds the body together against vacuum; pressure is distributed through the foam-like inner skin. This air is heated to maintain body temperature. Skinsuits provide little rad protection, and their temperature regulation units can only stand full darkness or sunlight for ten minutes max.

Worksuits are used by workgangers for their durability and toughness. They are often produced in semi-rigid mod-



els (hard-shell helmets and torsos, with flexible arms and legs) to withstand unexpected punishment at construction sites. These suits will keep a human comfortable in all space and Lunar environments for up to eight hours.

Maintenance and Suit Failure

Spacesuits aren't just another piece of clothing. They are complex pieces of machinery that require regular maintenance, or like any piece of machinery they will cease to function. If your car fails, you're just late for work. If your suit fails, you're dead.

Suit maintenance for government and commercial firms is usually handled by specialized contractors. For small organizations or individuals, it's usually up to the wearer. Spacesuits have come a long way—the original '80s NASA Space Shuttle suits required over twenty hours of maintenance for every hour of use. The standard 2020 suit takes about two hours maintenance for every fifty hours use. Skinsuits require about half that, while the much more mechanical Battlesuit may take one hour maintenance for every four hours use.

Failure to maintain a suit may not be noticeable—until the oxygen line breaks. Most suit failures are merely annoying slow leaks. But some can kill instantly. For every two hours of use, there is a 1% chance for suit failure. Skinsuits roll every four hours. Failure to properly maintain a suit doubles the rate of rolling and adds 5% to the failure type roll, should one happen (per week of missed maintenance- but one maintenance session will reset this). It's worth the few minutes every day to check your suit over.

SUIT FAILURE TYPE

Roll	Failure	Game Results
01-50	Slow Leak	Duration reduced by 1D10/2 percent.
51-75	Fast leak	All air lost in 6D10 minutes.
76-85	Tear	As fast leak, but a slap-patch stops it 90% of the time.
86-95	Cooling System Failure	Character overheats in 3D10 minutes
96-98	Comm System Failure	Suit radio fails. Very Difficult task to repair.
99	Faceplate Cracks	As fast leak, but a slap-patch stops it 90% of the time (and also blinds character)
00	Major Seal Failure	All pressure instantly lost.

DEEP SPACE

EQUIPMENT & WEAPONS

Battlesuits are upgraded worksuits, with limited exoskeletal support (+1 to STR/BOD to a maximum of 11).

Radsuits are used in high radiation areas, but otherwise are like worksuits. Mars suits are standard suits adjusted for the Martian surface, but they are lighter, and they can be used in space. It is rumored that the Soviets have developed a suit for the surface of Venus, but there is no evidence to support such rumors.

Since 2021, the biggest innovation has been the advent of the **Advanced Combat/Construction Personal Armor (ACPA)** unit. In space, a powered armor suit doesn't need to support its mass in a G-field, and with maneuvering vernier jets, a powered armor suit becomes a one-man, man-shaped spacecraft. When a job calls for extended EVA activity (especially when large masses must be manipulated), more often than not, a powered armor suit is used. Of course, the single greatest user of powered armor in space is the USAF. For more on ACPA capabilities, see the supplement *Maximum Metal*.

EVA MANEUVER UNITS

These are specialized jet packs used to move around outside a spacecraft or habitat. They are measured by the delta-Vee, or difference in speed (in m/sec) they provide. Any change in speed—forward, back, up, down, etc. uses some delta-Vee. A character must remember that half the delta-Vee will be needed to stop any maneuvers performed. There are generally three types of maneuver units available:

1) Hand Maneuver Unit: used for quick trips, the unit consists of a nitrogen canister, two nozzles, and a handle. Squeeze the upper trigger and the left nozzle fires; squeeze the lower trigger and the right nozzle fires. It takes considerable practice to use these units efficiently; roll against REF -1 every ten minutes of use until the character gains sufficient experience (1D6 weeks). Failure means the character tumbles. The

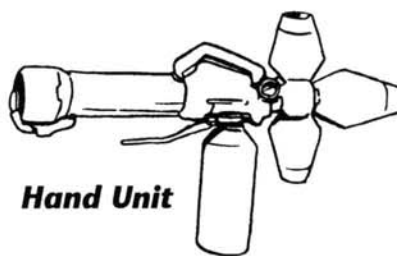
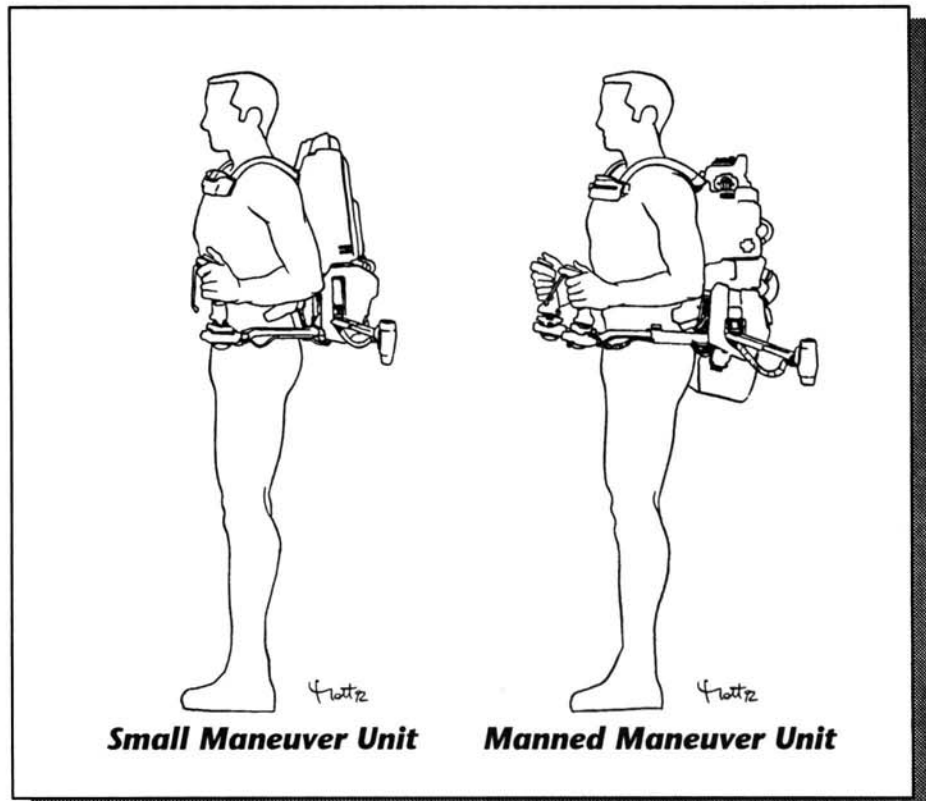

hand unit takes thirty seconds to prepare before use, and provides a total delta-Vee of 150 m/sec.

2) Small Backpack Maneuver Unit: This device attaches to the bottom of most suit backpacks with velcro and provides more control than the hand unit. It includes an inertial guidance unit and a rudimentary computer, which prevents the unit (and the suit it's attached to) from tumbling. It takes three minutes to prepare for use, and provides a total delta-Vee of 500 m/sec.

3) Manned Maneuver Unit: This is the largest maneuvering unit. It straps on the suit and provides the most stability.

If the spacesuit is so equipped, the Manned Maneuvering Unit can be controlled via interface plugs. It provides feedback through a readout and through a Times Square Marquee. It has redundant inertial guidance units and computers, and has attached lights good for up to six hours. It takes ten minutes to prepare for use, and provides a total delta-Vee of 2000 m/sec.

BUBBLE SHELTERS

The bubble shelter is a plastic environmental shelter designed to protect survivors of a pressure accident. They are found on all shuttles, spaceplanes, workshacks, and OTVs. Resembling a folded umbrella in its storage position, the bubble rapidly inflates to a large mylar sphere, one side opaque, the other side silvered. Through the core of the bubble runs a six inch metal rod, containing oxygen and oxy-scrubbers, a small water supply, a medical kit, a limited CO² maneuver thruster good for about 20 minutes, and a homing beacon with about a 1000 km range. The shelter inflates around the

core in about three seconds. An extendable airlock allows the crew to enter.

There are three sizes of bubble shelters: one-, four-, and six-man. Each carries enough air and water to support its crew for 24 hours (obviously, if a single man were to use a six-man shelter, he would extend his survival period to six days).

Emergency Bubbles are a still-smaller version of the one-man bubble shelter, about a meter in diameter. Characters sit inside, zip it shut, put on the enclosed oxygen mask, and wait to be rescued. It includes a radio beacon good for about 3 km, and a flashing light. Good for about two hours. Nicknamed the "morale bubble."

VEHICLES

Occasionally, there is a need to travel the surface of the moon or Mars without using a spacecraft. Specialized vehicles are used for that purpose.

LUNAR ROVERS

Powerplant: Nuclear Isotope Decay Thermocouple with Solar Backup
Performance: 500 km (600 km in daylight) range; 80 km/hr (95 km/hr in daylight), 1/2 speed if carrying more than 1000 kg
SDP: 20

The Lunar Rover is the "pickup truck" of the Moon. It is used for everything, from transporting ore and people, to being a light armored fighting vehicle (if necessary). It has two articulated grips, which can pick up nearly 400 kg. The solar panels are fully moveable, enabling them to track the sun and make room for cargo. The crew cabin is pressurized and normally holds two (although up to eight have been crammed inside in an emergency), with twenty man-days of supplies. The cabin has limited armor against radiation. It can carry up to 2000 kg cargo. For short-haul transportation, a personnel module is often placed on board, which can carry twenty people for up to two days. There is also a field hospital ver-

sion, with a complete mini-surgery and three intensive-care beds.

The armed version replaces the comm dish with a turreted minigun, and the cargo area carries several surface-to-surface or surface-to-space missiles. It normally has an SP of 6; it can be armored up to SP 50, but each SP 10 reduces the range by 5%, and the armor does not cover the cargo (which, of course, can be armored separately). Rovers can be operated remotely, but local control will always override remote control. The Lunar Rover can also be used on other satellites, but the solar panels are replaced with another nuclear generator.

MARS ROVER

Powerplant: Dual nuclear isotope decay thermocouples
Performance: 800 km range; 60 km/hr, 30 km/hr if carrying more than 500 kg
SDP: 30

In most respects, the Mars Rover is like the Lunar Rover. There are certain modi-

Mars/Lunar Rover

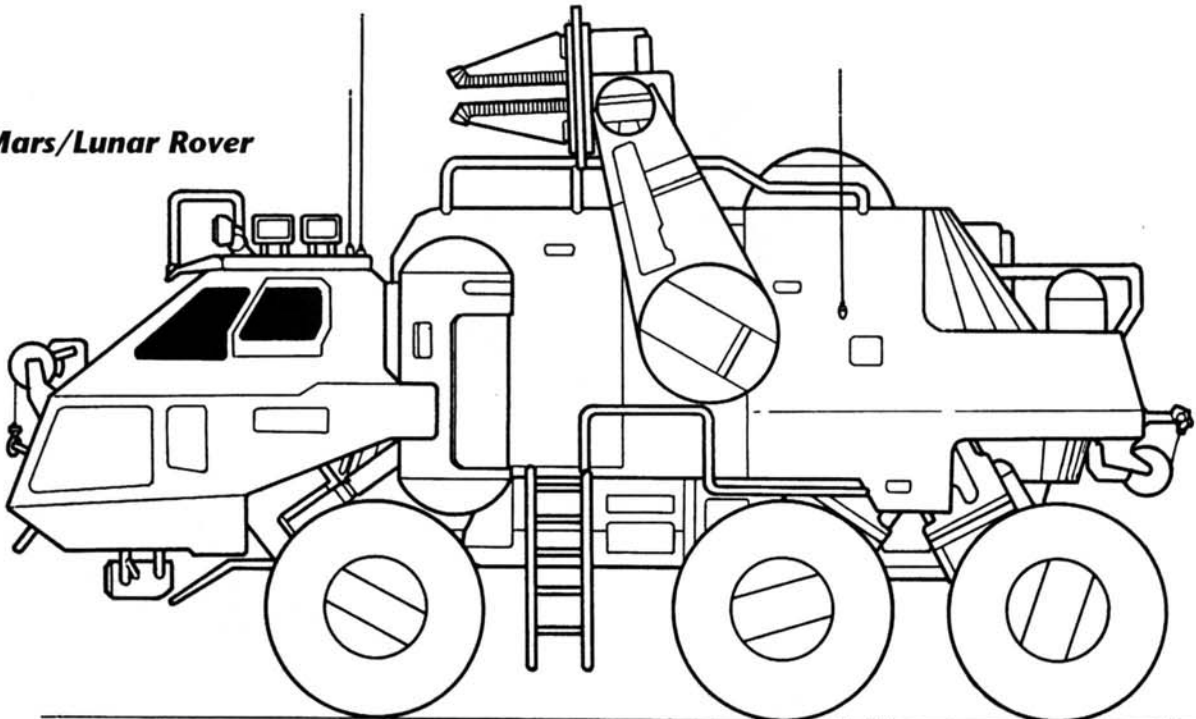

Mars/Lunar Buggy

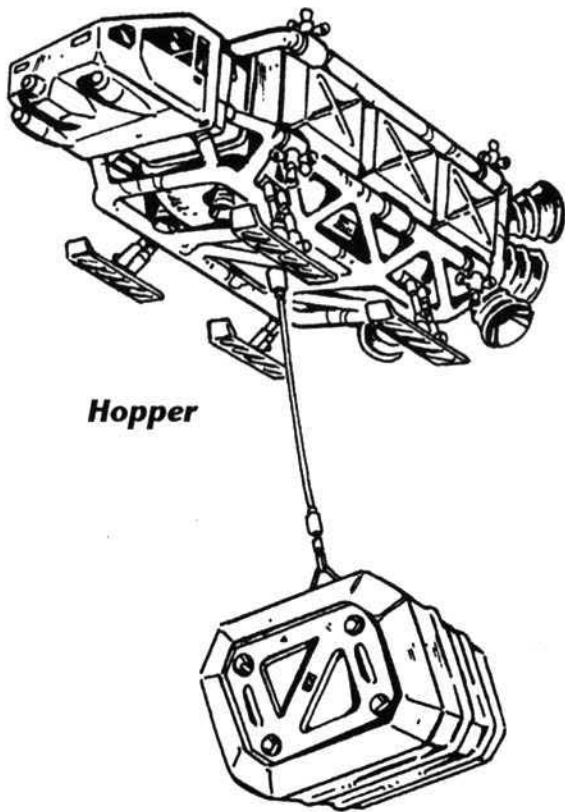
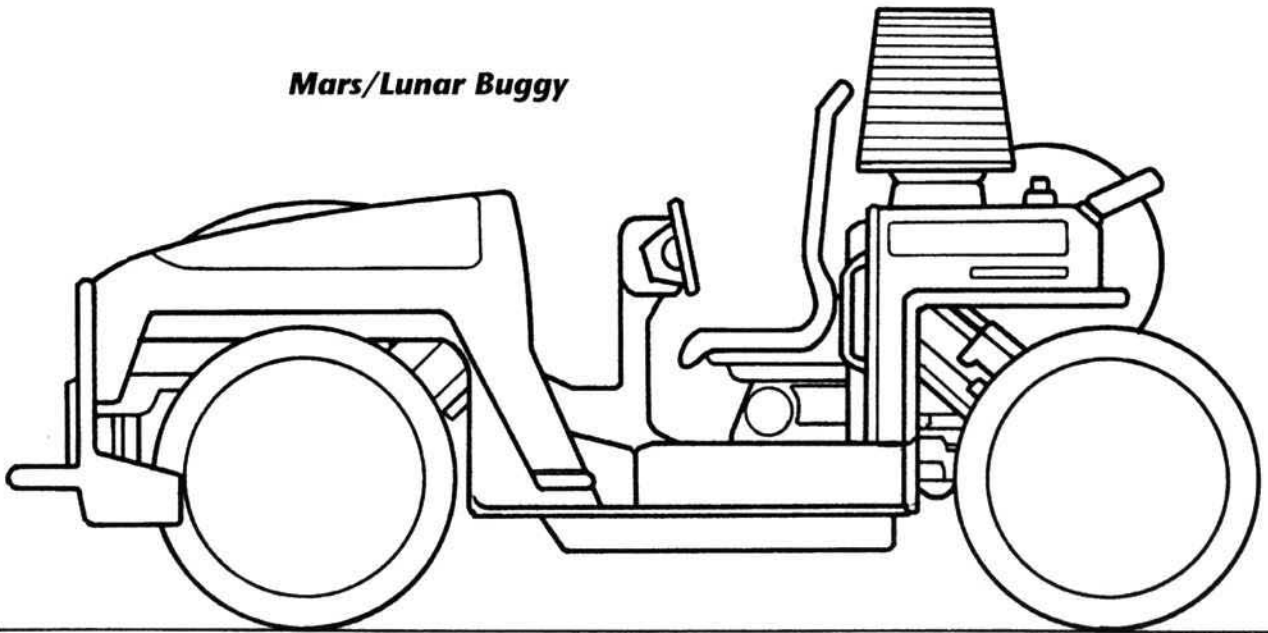

Hopper

Jet Cycle

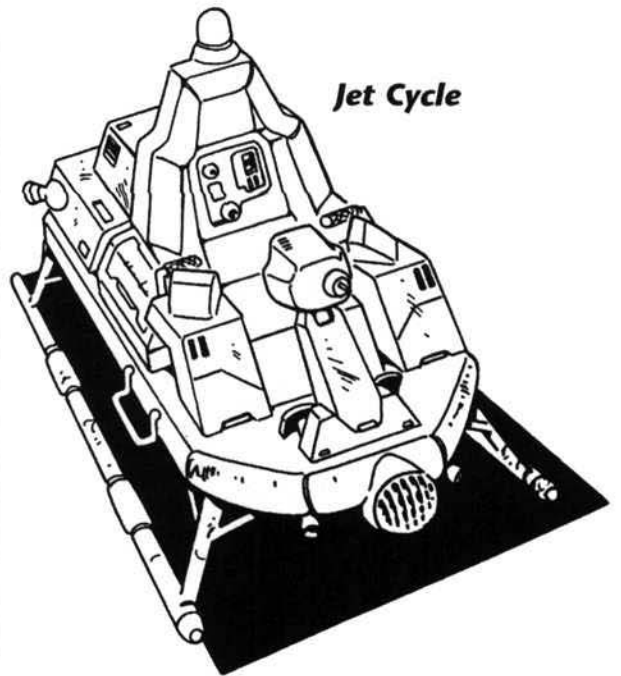

fications necessary for the Martian environment, notably the absence of solar panels. The Mars Rover is designed for an atmosphere. The windows are covered with a peel-away layer of plastic, which protects them from sandstorms. Similarly, the powerplant has an active cooling loop, sealed to prevent entry by dust. The cargo space is enclosed. The radio/radar antenna is shielded, which would normally reduce its range; since Mars is larger, the horizon is farther away and therefore Mars generally has a longer line-of-sight distance than Luna. The Mars Rover can carry about 1000 kg of cargo, and the articulated grips can lift about 150 kg each. The Rover can be armored to SP 40 (it is normally SP 10), but each SP 10 reduces range by 10%. The Mars Rover can't be used anywhere else (except possibly Titan), because it requires an atmosphere for cooling.

LUNAR BUGGY

Powerplant: Battery

Performance: 150 km range; 30 km/hr, 20 km/hr with 2 people and over 40 kg cargo SDP: 10

The Lunar Buggy is virtually unchanged from the original Lunar Rovers used in the Apollo landings almost fifty years ago. They can carry two spacesuited people and up to 100 kg cargo. They are completely open, and cannot be armored. They can be operated by remote control, but local control will override remote control. They have been armed, but their openness (SP 3, if you're hiding behind it) makes their military use limited.

MARS BUGGY

Powerplant: Batteries

Performance: 50 km range; 25 km/hr, 18 km/hr with two people and over 40 kg cargo SDP: 14

This is virtually identical to the lunar version, except it has a folding enclosure. Spacesuits are still required, however. The Mars buggy can be armored to SP 15 (from its normal SP 5), but this reduces the range to 35 km.

HOPPERS

Powerplant: rockets ; batteries

Performance: 400 km range, reduced by 20 km for every 200 kg or fraction cargo; up to 30 hops of up to 20 km each; each minute of hover uses 25 km of range; up to 120 km/hr ground-speed; can enter or leave lunar orbit once, with no cargo SPD: 15

The hopper is designed for rapid short-haul transport. The hopper makes short hops, and can even enter or leave lunar orbit. Hoppers typically make a few dozen hops between refuelling stops. They can also be used to lift objects like a helicopter; up to 1500 kg can be carried for up to 120 km this way. The crew cabin is typically left unpressurized if multiple hops are being made, since it would take too much air to repressurize. The cabin has two regular and two fold-down seats, and in lieu of passengers has 3 m³ of cargo space. Typically, additional cargo is strapped wherever on the body; this additional mass reduces range accordingly, and eliminate the ability to enter or leave orbit. A hopper can act like a cramped OTV if it is already in orbit; it has the equivalent of four burn elements. Hoppers are also used in the asteroid belt, but they aren't designed for it. Some beltters strap on a lot of provisions, hoist a solar power array, bolt on an airlock, and drift for a month or so between finds; some of these go whacko because of the confinement. Hoppers typically have ten man-days of supplies. They are usually used by science teams, or by corporates on inspection tours.

JET CYCLES

Powerplant: rockets, batteries

Performance: 3000 km range; up to 300 km/hr SPD: 8

Jet cycles are very cheap transportation between satellites. One or two people can strap themselves on, kick the thrusters, and in a few hours arrive at the next habitat. They are really only designed for a few hours duration, but they are often pushed beyond this. Their radar is more sophisticated than would be expected; this allows the 'cycle to show up more easily on other ships's radar. They cannot be used to move from one

orbit to another, just from habitat to habitat at about the same altitude. They are totally exposed, and cannot be armored. They have a "stationkeeping" mode, where the computer fires thrusters to keep the 'cycle in the same position if it's disturbed.

TOOLS

Tools used in space must take into account a wide variety of factors Earthbound tools can ignore. Using a normal screwdriver, for example, is nearly impossible in zero-gee, as the twisting motion will spin both screw and user. All space tools are therefore designed to be self-powered (using rechargeable battery packs and small motors), and to damp out the effects of Newton's Third Law. All tools also have a generous allotment of rings, magnets, and Velcro, to minimize the likelihood of loss.

POWER TOOLS

These tools have small motors with rechargeable battery packs (packs are good for 4 hours use, recharge in 4 hours). They include:

- **Powerdriver** with 15 interchangeable heads, including screwdrivers, socket wrenches, and hex keys. The unit has a counterrotating adapter to compensate for lack of gravity.
- **Vac-solderer** with high-heat tip and vacuum suction to pick up stray globules of solder. There is also a small brush to clear away solder in vacuum. The vac-solderer dispenses solder from a recess in the tip.
- **Hand-held Mini-vac** for cleaning up after EVA, catching spills, etc. This model can handle both liquids and solids.

There are also other pieces of technical equipment:

- **Micro-tools**, including tiny screwdrivers, probes, calipers, and other small electronics work tools.
- **Combo flash** with a strobe flash in the handle base, and a powerful adjustable beam in front.
- **Technical scanners**: these are small plug-in devices about the size of a paperback book. They are inserted into sockets built into control panels,

walls, and larger machines. Activated, they can (80% of the time) produce a detailed readout of the system's condition, repairs required, etc.

- **Sniffer:** Small hand-held device which can be programmed to detect levels of carbon dioxide, oxygen, carbon monoxide, and other atmospheric gases (90%). If levels are higher than a set optimum, the sniffer will sound an alarm. A good way to know when the air is going bad.
- **Pressure Alarm:** Tiny hand-held barometer monitors current air pressure, and will set off an alarm if pressure rises or falls by more than 5%. Good for detecting small leaks, most Highriders wear these on lanyards or clips. They are often built into Sniffers.
- **Radiation Meter:** Gives a reading of radiation present in rads. Sweep covers immediate area within 2 meters.

PERSONAL GEAR

A few common items used by everyone on the High Frontier:

- **Velcro:** Two-sided Velcro strips or pads, one side with Velcro, the other with adhesive. These are constantly used to secure things: books, pencils, tools, sleeping children. Most habitats have wide areas of Velcro surfaces, allowing one to stick things down with a corresponding Velcro pad. Get used to it—Velcro is used on desks, chairs, walls, clothes. Space is filled with the constant "sccrrriittttchh!" of Velcro being pulled apart.
- **Drink Bottle:** Most Highriders have their own personal drinking bottle, usually plastered with nametags, stickers, and other personalized bits. A squat plastic cylinder with a straw at one end and a shorter self-sealing filler spout next to it, the drink bottle can be fastened to convenient places with the ubiquitous Velcro strap. Holds about a liter.
- **Lap pad™:** A small LCD pad with a limited computer chip memory. You draw or write on the pad with your finger or stylus, and it mimics the writing on its silvery surface. Press

"save" and it stores the page and clears the screen. Press "recall", and it will present all the stored pages (up to 100) in reverse order of writing. When full, they can be plugged into a computer to download, or the memory chip can be replaced. They can produce a keyboard on the screen for typing. They can also be pre-programmed with a variety of forms, to help check inventory or passenger manifests, for example, or with a tech manual or book. More expensive versions can tie into the habitat computer via radio link, store more pages, accept interfacing, and/or include a small processor.

- **Personal Radmeter:** A three-centimeter-long grey wafer with a digital readout. Keeps a record of total dosage taken since it was last reset. Can be worn clipped to clothing, and even come in designer versions.
- **Electro-Stick Pad:** Hand-held device with a handle and battery pack on one side, and an electro-magnet on the other. Will stick to any metal surface (except 100% aluminum) when switched on.
- **Rail Key:** Many large permanent work modules have a lightweight cable running through a recessed slot in the wall. The cable is continually fed through pulleys, creating a trolley system in miniature. Cables run each way. The rail key is a handle designed to snag onto the cable and tow the person to another area of the module. It lets go of the cable when the grip is released.
- **Grip Slippers:** Soft overshoes with Velcro soles and magnetic heel plates. Good for traction in any zero-gee environment.
- **Hands-Free Comset:** An earphone and boom mike headset, voice activated. Plugs into your spacesuit helmet, or can be plugged into a belt module for interior use.

SURVIVAL GEAR

Nearly every Highrider at one time or another has needed some of the following equipment to survive:

- **Lunar Tent:** An inflatable tent (3x3x2 m) which provides tempo-

rary shelter. Has a small airlock which can be used five times before the air supply is depleted. The tent is pressurized to 5 psi pure oxygen. It is rated for 15 man-days. It has an outer reflective surface to radiate heat. There is a small battery powered air filter, heater, and light. A chemical toilet is available. It collapses to a 1x1x2 m cube, and inflates fully in two minutes.

- **Flare Shelter:** Often installed near construction sites and periodically along the more popular trails, flare shelters provide a limited protection against solar flares. They are cylindrical, about 2.5x4 m, with an air lock at one end. When properly buried, a flare shelter reduces a flare's Strength by 3. When a flare is detected, a red light flashes to show the shelter's location, and a radio beacon activates. They are typically rated for 18 man-days. It has a battery powered air filter, heater, and light.

There is a chemical toilet and four built-in bunks. Emergency rations and up to 500 liters of water are available. Since government policy (and common sense) dictates that they are useable by anyone in an emergency, everyone contributes to the upkeep fund. Those on the common routes are regularly serviced. Some even have braindance units, since little communication is possible during a flare. They are even occasionally used as residences.

- **Sandstorm Shelter:** Similar to a flare shelter, sandstorm shelters are a welcome sight on Mars. Sandstorm shelters have an enclosed awning to allow a rover to pull partially inside, minimizing the amount of sand entering the airlock. Sandstorm shelters are not buried, at least not voluntarily. When a sandstorm is detected, a green light flashes to show the shelter's location, and a radio beacon activates. Shelters are rated for 18 man-days. It has equipment and supplies similar to those in a flare shelter, and they are also maintained in a similar manner. Braindance units are not as common in sandstorm shel-

ters, because radio communication is generally possible through a sandstorm. Sandstorm shelters are often located on trailers, though these do not have the enclosed awning.

- **Goop Balls and Slap-patches:** described in *The Environment of Space*.
- **Porta-power:** A small nuclear isotope decay thermocouple, it can provide up to 300 watts power indefinitely. It also creates a lot of heat, and cannot be shut off. It is 50x50x100 cm, and masses 100 kg.
- **Breathers:** Similar to a breathing mask, the breather covers the entire face and has an attached oxygen cylinder (good for a half-hour, if it is only used to supplement existing air). It is NOT a spacesuit replacement.
- **Slag-Crete:** This is a form of concrete made with lunar slag or Martian soil. It is used as a building material, as radiation protection, and as insulation. It comes in several varieties: vacuum-activated, thermal-activated, water-activated, and chemically-activated. The most common form is thermal-activated, because it allows you to work it into whatever shape you want, then either apply a heat source or allow the Sun to do the job. Water-activated is only used in interior patch jobs. Vacuum-activated is used in pressurized areas that will later be exposed to a vacuum. Chemically-activated is used in all these places, and in areas where heat is a problem.

WEAPONS

Weapons in space have a number of special factors which must be considered in their design. In zero-gee, recoil is one critical problem. Another is random projectiles penetrating a thin habitat wall and letting the pressure out; lasers are also eliminated for this reason, since any laser that could burn through a body could also burn through a wall. While knives are the preferred (and socially acceptable) way to eliminate the opposition, three "fixes" have evolved to allow use of limited firearms: gyrojets, flechettes and bolters, and safety rounds.

GYROJETS

Gyrojets use a self-propelled rocket shell. A powerful spring launches the shell, which coasts about a meter from the barrel before igniting. No recoil, no mess.

There are a few problems with gyrojets. First, they are next to useless at close range, as the rocket shell is only spring-powered. It takes a good five meters of travel before the round accelerates to killing speeds. In a space habitat, a potential assassin may be hard-pressed to find enough space to make his gyrojet pistol useful!

Second, most gyrojets will penetrate the wall of a habitat without too much problem. Due to all of these factors, you can most reasonably expect to find gyrojets being used only outside habitats, or inside very, very large habitats like the Crystal Palace or the Lunar colonies.

FLECHETTES AND BOLTERS

Flechette weapons trade projectile speed for penetration. The flechette is thrown by a very low-powered shotgun-type round firing several flechettes at once. Bolt throwers are heavier flechette weapons which throw a single thick bolt.

Neither of these weapons can deliver enough impact to penetrate a hull (except at Point Blank range for Bolters), but because they are designed to pierce, they will halve the SP of any body armor they encounter. In space, where even a small rip is enough to send your enemy scurrying to a patch kit, big damage isn't quite as critical. Also, both types can be coated with poison or narcotics for added effectiveness.

One variation of the bolter is the popper. This is a hand-held cylinder which is pushed against a spacesuit or other surface and activated. A strong spring forces a spike through the suit. Unfortunately, a popper also has considerable recoil. But because of their size (about that of a long, thick pencil), poppers are easily concealed (Very Dif-

ficult to find). There is a version which fires a rocket-powered bolt; it has no recoil, but is much more difficult to use because of the backblast. Poppers are often homemade. Poppers are useless more than a few meters away.

SAFETY ROUNDS

Another solution to firepower in pressurized environments is to employ safety rounds. Designed in the 1980s for aircraft terrorist control, safety rounds will break up against even a thin metal hull. This makes them less effective against armor (armor is doubled, but penetrating damage is tripled). Any hard surface of greater than 10SP or 30SDP will cause the round to burst harmlessly. Available only to police and security forces.

TASERS

Although not really a firearm, handheld tasers are very popular in space. A flashlight-like unit ends in two metal prongs. Press the prongs to flesh, and the subject takes a powerful and stunning shock. Ranged tasers are less common, firing two probes on the end of thin trailing wires 5-10 meters.

Tasers are even more effective in the *Cyberpunk* generation—a quick jolt to a metal cyberarm could short the whole thing out (20% chance unless shielded) and make it useless up to the armpit!

ROCKET-PROPELLED GRENADES

RPGs are used outside habitats. They can truly ruin the day of anyone on the receiving end. They are generally the most powerful man-portable weapons found in space. In a vacuum, RPGs have triple the volume of effect they do on Earth, a little less than triple on Luna, and about double on Mars. On Venus, a grenade's area of effect is halved. An RPG has a dial for the fuse timer, usually from 2-10 seconds in half-second intervals. When fired, the RPG will travel 5 m the first second, 10 m the next second, 15 m the third second, 20 m the fourth second, and 25 m the fifth second and every second thereafter (less 1/5 on Mars, 1/2 on Earth, and 2/3 on Venus).

DEEP SPACE

EQUIPMENT & WEAPONS

Weapon List

TEXAS ARMS 351 GYROJET PISTOL

P 0 J C/P 9mm Gyrojet 8 2 UR
Developed as a lightweight gyrojet weapon along the lines of the earlier Mark II models of the 20th century, the 351 pistol fires a 9mm rocket round (damage as a normal 9mm). Range is 3x that of a normal pistol in vacuum. The 351 is a commonly used military firearm, particularly on Luna, but is rarely seen groundside.

MILITECH SILVER SHADOW FLECHETTE PISTOL

P 0 J P Flechette 8 2 ST 30m Range
The civilian ancestor of the famous "Black Widow" developed for the USAF. Each shotgun-like shell has 6 flechettes with a half-meter spread at medium range; roll (1/2D6)+2 to see how many hit per shot. Each hit does 1D6/3 (1/2 armor) damage at all ranges, plus any drug or poison added.

HAMMER M-11 BOLT PISTOL

P +2 J P 9mm Saboted Bolt 10 2 ST 30m Range
The most common bolter in use, the M-11 has better recoil control than most flechette weapons. The 9mm bolt does 1D6+2 at all ranges, but armor is x1/4, damage x1/2, due to its high penetration.

MILITECH BLACK WIDOW FLECHETTE PISTOL

P +1 J P Flechette 10 2 ST 30m Range
The "Widow" was designed under contract with the U.S. Air Force as a standard space sidearm, especially for EVATs (EVA Troops, the USAF Special Ops unit). The idea was to create the potential for a great deal of damage with low penetration/recoil for use in enclosed environments. Ammo feeds from a somewhat bulky 10-round clip. Each round has 10 flechettes with a one meter spread at Medium range (roll hit locations as per a shotgun). Flechettes do 1/2D6 (1/2 armor) damage, plus any drugs added.

DYNATECH INDUSTRIES HAND TASER

EX 0 P E Stun 12 1 VR
The most common taser weapon in space; the hand taser must be touched to bare skin in order to deliver its charge. Targets must make a Stun Save at -2, or be stunned unconscious for 1D10 minutes. If the save is made, REF & COOL are still halved for 1D10 minutes.

MITSUBISHI TASER

P 0 J P Stun 12 1 ST 5m Range
A standard defensive weapon for JAB security men in the construction shacks; this taser fires wire-trailing darts up to 5m away. The darts will penetrate up to 5SP of soft armor. If hit, the victim must make a Stun Save at -1 or be stunned for 2D6 minutes. Should the save be made, REF & COOL are still halved for 1D6+1 minutes.

M-99 EVAW

RIF +5 N R 6D6AP(12mm rocket) 30 2 ST
HVY 0 — 2D6+1(25mm HE) 10 1 —
10m minimum Range, 2000m effective Range

The M-99 Extra-Vehicular-Activity Weapon is the signature weapon of the USAF EVAT's, the astronaut troops of the U.S. Aerospace Force. The weapon is a cumbersome monstrosity with two barrels, two massive magazines, and a CO2 booster tank strapped to the EVA Trooper's belt. It fires two kinds of self-propelled rounds, using the compressed gas to eject the rounds from the barrel before their rocket propulsion ignites. The first kind of round is a 12mm seeking slug that homes in on infrared and radar sensors (it's quite expensive); in addition, there is an IFF reader in the shell to prevent it from tracking on friendly targets. The second round is a standard 25mm high explosive grenade fitted with a small rocket booster and a proximity fuse. Both rounds are equipped with an end-of-range self-destruct charge, which destroys the round when it goes beyond a set range (usually 10% beyond maximum range at velocity).

The advantages of the EVAW are low recoil, no heat emission, low gas ejection.

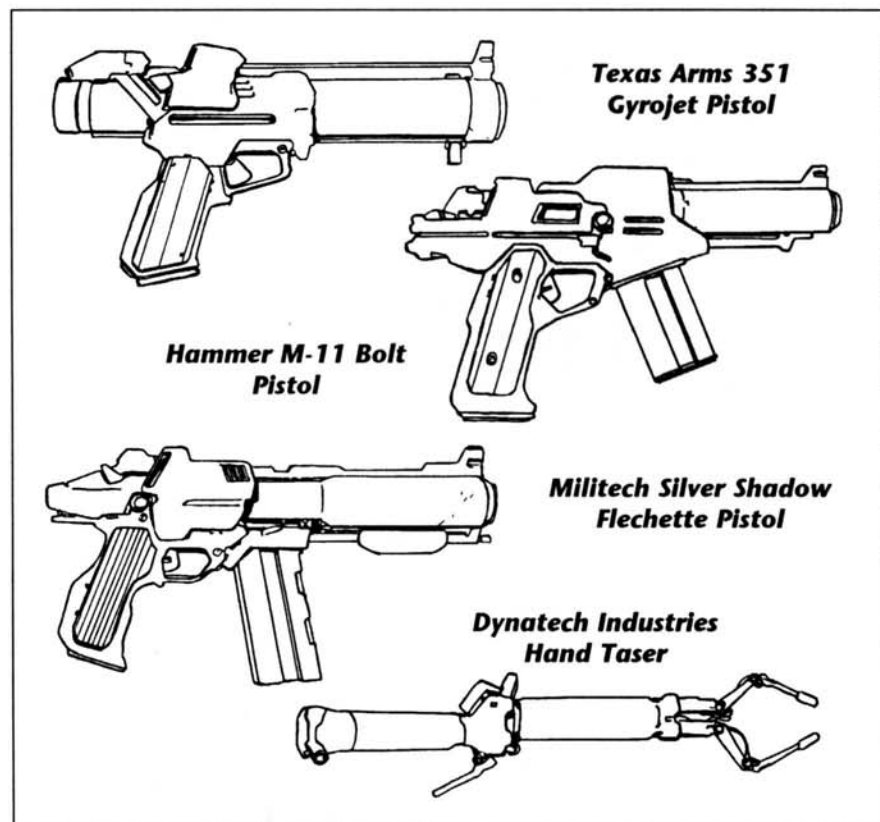

EQUIPMENT LIST (ALL COSTS IN EUROS)

Spacesuits Type	Cost	SP	RSP	Duration	Put On	Notes
Standard	15,000	10	2	6+2	3 mins	
Skinsuit	2,500	6	0	1+1/3	2 nims	
Worksuit	20,000	16	3	8+2	4 mins	
Battlesuit	50,000	25	6	6+2	8 mins	Military only; STR +1
Radsuit	30,000	16	6	8+2	4 mins	
Mars suit	15,000	7	2	5+2	3 mins	
Venus suit	?	?	?	?	?	Probable rumor

SP: Stopping Power

RSP: Radiation Stopping Power

Duration: Hours of operation, plus reserve

Put On: Time needed to put on suit. Properly taking it off also takes about the same time, though it can be done faster.

tion (standard rounds produce a cloud of smoke in zero-g/zero-pressure atmosphere), practically no moving parts, and built-in accuracy. Admittedly, it's not as perfect a space weapon as a portable laser, but it's almost as good.

NEWTECH 2025

When "Bioware" first hit the streets around 2013 it hardly caused a ripple. Slightly faster healing or stronger muscles seemed rather dull compared to the glitz of chromed Cyberware or Video skin-grafts. But we now know that in the corporate laboratories an entire new science was being born. Manipulation of molecular-scale objects, or "nano-technology," matured rapidly and soon changed the face of society.

By 2025 the language of nanotech has become commonplace and Bioware abounds alongside designer skin grafts and whirring cyberlimbs. Nanotechnology IS the newtech of today, competing with Cyberware as the potential elixir of youth, the ultimate in chic. Laws of supply and demand (and raw greed), keep prices high and restrict general use to the rich and powerful.

Nanotechnology relies on two main components. Assemblers are molecular sized "machines" which can perform complex acts of construction, taking individual molecules and combining them to form a particular material. Disassemblers can break a given material back into its component molecules.

Nanoids, the popular term for molecular sized machines, can assemble or disassemble almost anything given time and the right raw material. We can rebuild you, and anything else, for a price.

BIOWARE

As described in the *Cyberpunk 2020* rules, nanoid treatments can be purchased from local clinics. These nanoids are carefully constructed machines which can manipulate living biological components. An injection of nanoids and suitable materials, a few weeks of patience and *voilà*: natural armor or enhanced antibodies at the flick of a few thousand Eurodollars.

In truth, much more advanced bioware exists in the corporate labs and exclusive European clinics. The most radical enhancements require connection to life support equipment while vital organs are altered or rearranged. After all, the nanoids can rearrange anything,

Equipment (cont.)**EVA MANEUVER UNITS:**

Hand Unit 100
Replacement nitrogen/CO2 cartridges 5
Small Backpack Unit 800
Manned Maneuver Unit. 3000

BUBBLE SHELTERS:

1-man 300
4-man 600
6-man 800
Emergency Bubbles . 150

VEHICLES:

Lunar Rover 150,000
Mars Rover 150,000
Lunar Buggy 5,000

Mars Buggy 6,500
Hopper 350,000
Jet cycle 2,000

TOOLS:

Powerdriver 100
Vac-solderer 50
Mini-vac 30
Microtools 15
Combo flash 5
Technical scanners 100-150
Sniffer 20
Pressure Alarm 2
Radiation Meter 100

PERSONAL GEAR:

Velcro, 12 pk 1
Drink bottle 2
Lap pad 50-150
Personal radmeter 5
Electro-stick pad 20
Rail key 5
Grip slippers 5
Hands-free comset 30

Equipment (cont.)

SURVIVAL GEAR:

Lunar Tent	800
Flare Shelter	3000
Sandstorm Shelter	3000
Goop Balls	0.2
Slap Patches	5
Porta-power	1500
Breathers 100 Replacement	
O2 cartridges	5
Slag-crete, per 40 kg bag	10

WEAPONS:

351 Gyrojet	420
Silver Shadow Flechette Pistol	300
M-11 Bolter	320
Spring Poppe	50
Rocket Popper	100
Reload	15
Safety Rounds, box of 50	100
Dynatech Tase	50
RPG	1500

but how long can you live while your heart is rebuilt?

The following list is by no means exhaustive, so use your imagination. Most enhancements, within reason, can be combined to give startling effects.

Muscle Enhancement: Interweaves synthetic muscle through the natural muscle fiber, anchoring and strengthening them. This enhancement is virtually undetectable and results in an increase of strength, giving +1 to your Body Type stat for Strength Feats, lifting/throwing, and melee damage bonuses, but not for BTM.

Skin Weaves are a generic form of bioware involving nanoids that weave the top three layers of skin with synthetic fibres. Other modifications are often included to provide a specific result. Some of these are described in more detail below. With all these weaves, if the character sustains a Critical or higher wound, he must undergo a maintenance treatment costing 500eb.

Thermal Weave: Rather than providing physical protection, this version deflects heat. It is quite obvious as the skin takes on a silvery sheen. This allows the character to function efficiently and normally in "shirt-sleeve" clothing (or less) in temperatures up to 107°F (42C). Good for when your worksuit temperature regulator fails.

Chem Weave: Here the top three layers of skin are completely replaced by fibers which can resist chemicals, including acids and biological agents. Required saves vs. irritant gases and liquids (and skin-absorbed poisons) are increased by +4. There is also an 8SP defence vs. acid attacks (this protection is not reduced). The skin tends to take on a somewhat pallid look and only requires a Moderate Awareness check to notice. Requires 8 weeks and provides no protection until the conversion is complete.

Rad Weave: Similar to Thermal Weave but designed to provide protection from higher-energy radiation sources. Rad Weave is usually combined with cyber-

netic replacement of both eyes as these are not protected by the nanoid treatment. Rad Weave is also quite obvious, as the skin takes on a silver sheen similar to Thermal Weave.

Vac Weave: This is currently an experimental concept only. It is designed to strengthen the outer layers of skin in order to "hold" the body together and retain moisture and heat loss in a vacuum. To be of any value this must be combined with specially constructed cyber-optics (1200eb, 4D6 HL), filter valves for all body cavities (300eb, 8pts HL), and reinforcement of internal organs (cost covered in initial treatment). A "cyber-lung" (700eb, 1D6+1 HL) is also inserted to provide a suitable atmospheric mixture and pressure during exposure to a vacuum (good for 15min). Character will not begin to suffer any low-pressure effects (see pg. 17) until his internal air is exhausted; even then, the effects will be reduced. At Half Volume: no effect; Quarter Volume: equal to normal Half Volume effects; Tenth Volume: equal to normal Quarter Volume effects, Zero Volume: equal to normal Zero Volume effects, except additional INT loss is 1D6-1/turn.

Neural Enhancements: The human brain is not exempt from the trespass of molecular machines. Some possible effects include:

Reflex boost: Increases your reflexes (not just Initiative, the stat itself) to a maximum of 11. Cost and Humanity Loss is per point, up to +2. There is a 25% chance that the treatment has "hardwired" your pain receptors as well (-1 to Stun saves per point of REF boost). This enhancement cannot be combined with Kerenzikov or Sandevistan boosts. It cannot be redone or removed.

Enhanced senses: Any of the senses of sight, hearing or smell can be enhanced. Unlike Cyberware there is no "editing function," although the potential for overload damage to these organs is actually reduced. Sudden bright lights, loud noises, or strong chemical stench can temporarily "stun" the recipient. For sight any 2

of the following options may be chosen: IR, UV, LowLite, Teleoptics (2.5x), Color Shift, Image Enhance (+1 Awareness). For hearing (either or both): Amplified Hearing, Enhanced Hearing Range. For smell: Olfactory Boost

CRYOGENICS

The use of cryogenic chambers has long been perceived as a mechanism for keeping a living organism alive for long periods of time. However, experience has shown that the human physiology cannot stand being reduced to the near zero temperatures for any length of time before structural damage occurs to cells and organs.

The suitable addition of nanoids into the patient's bloodstream before the cryogenic process adds a new dimension to this technique. Nano-surgeons can equilibrate chemical and pressure imbalances and maintain the flow of trace elements to biological mechanisms now operating at drastically lower speeds.

While not perfect, this mechanism has a tested failure rate of less than 1 percent and has been predicted to operate successfully for periods of over 1,000 years.

CONSTRUCTION

At first glance nanotech doesn't appear much use in large scale construction, except for making small individual components. The key is that assemblers can create tailored material hundreds of times stronger than "normal" engineering materials, and construct tailored molecules of staggering complexity to specific constraints. Thus, large components can be manufactured as a single piece, with unsurpassed strength and resilience, by an army of molecular machines. The only catch for nano-construction is that it can only create raw building ma-

terials, or pre-shaped structural members or components.

This is only the start. Rather than constructing components of solid material, a wafer like construction is used. Within the cavities a solution of nutrients and assemblers lie in wait, for any breach of the structure. Activated by changes in pressure or contact with atmosphere, the assemblers begin rapidly spinning a seal to repair the break. Welcome to a new era in engineering.

SPACESUITS

Although rumored to have been in use by some corporates and the military for some time, nanotech suits have only recently come out of testing and are enormously expensive. Characters will only be able to obtain nanoid-based skinsuits as a Near Impossible deal of some sort, and the base price would be around 100 times the cost of a normal suit.

A nanotech skinsuit is hardly distinguishable from a standard skinsuit and would appear to be constructed from a 2mm thickness of rubberized polymer. In fact, the suit material consists of a flexible high-strength nano-polymer. Within the honeycomb structure of the suit material lies a nano-soup of assemblers serving various functions. These suits will repair most small punctures without appreciable loss of pressure. The suit's outer surface provides sub-

stantial radiation protection, while the clear helmet is virtually unbreakable. A small unit on the integral belt performs environmental monitoring and recycling of all body waste. Such a suit can sustain its occupant for several days without recharging.

COMPUTERS

Using molecular-scale construction, the latest wave of AI's-to-be will consist of intricate lattices of electronics spun by assemblers. By reducing internal switching components and paths to molecular scales these computers will run at hundreds of times the speed of earlier systems. Third generation nano-computers will be designed and constructed entirely by earlier versions of themselves. Their potential complexity may go beyond the understanding of the scientists and engineers who oversee their learning.

CYBERWARE

Cyberware may be one of the first technologies to benefit from the application of nanotech. New materials will lead to Cyberware which is stronger, more flexible and partially self-repairing while also being lighter and more resistant to EMP effects. The cyberware will be closer in feel and appearance to its organic counterparts, allowing a minimum of Humanity Loss for a minor increase in price. Unfortunately, little of this technology has yet bleed down into the open market.

BIOWARE LIST (SEE PG. 60)

Bioware	Surg	Description	Cost	H. Loss
Muscle Enhancement	(N)	Increases Body Type stat by +1	1,000	1-2
Chem Weave	(N)	Improves Chemical Saves by +4	2,000	1D6+3
Thermal Weave	(N)	Increases heat resistance by 20C	1,500	1D6+3
Vac Weave	(MA)	Strengthens body against decompression (Must be used with other options - see text)	5,000	1D6
Rad Weave	(N)	Provides radiation protection of 1 RSP	1,500	2D6
Reflex Boost	(N)	Increases REF stat by +1	3,500	1D6+3
Enhanced Senses	(M)	Improves one sense (similar to cyber-options)	1,200	2 per option

5

You gotta live somewhere. But there's a big difference between a tent in a crater and the Crystal Palace...

ARTIFICIAL HABITATS

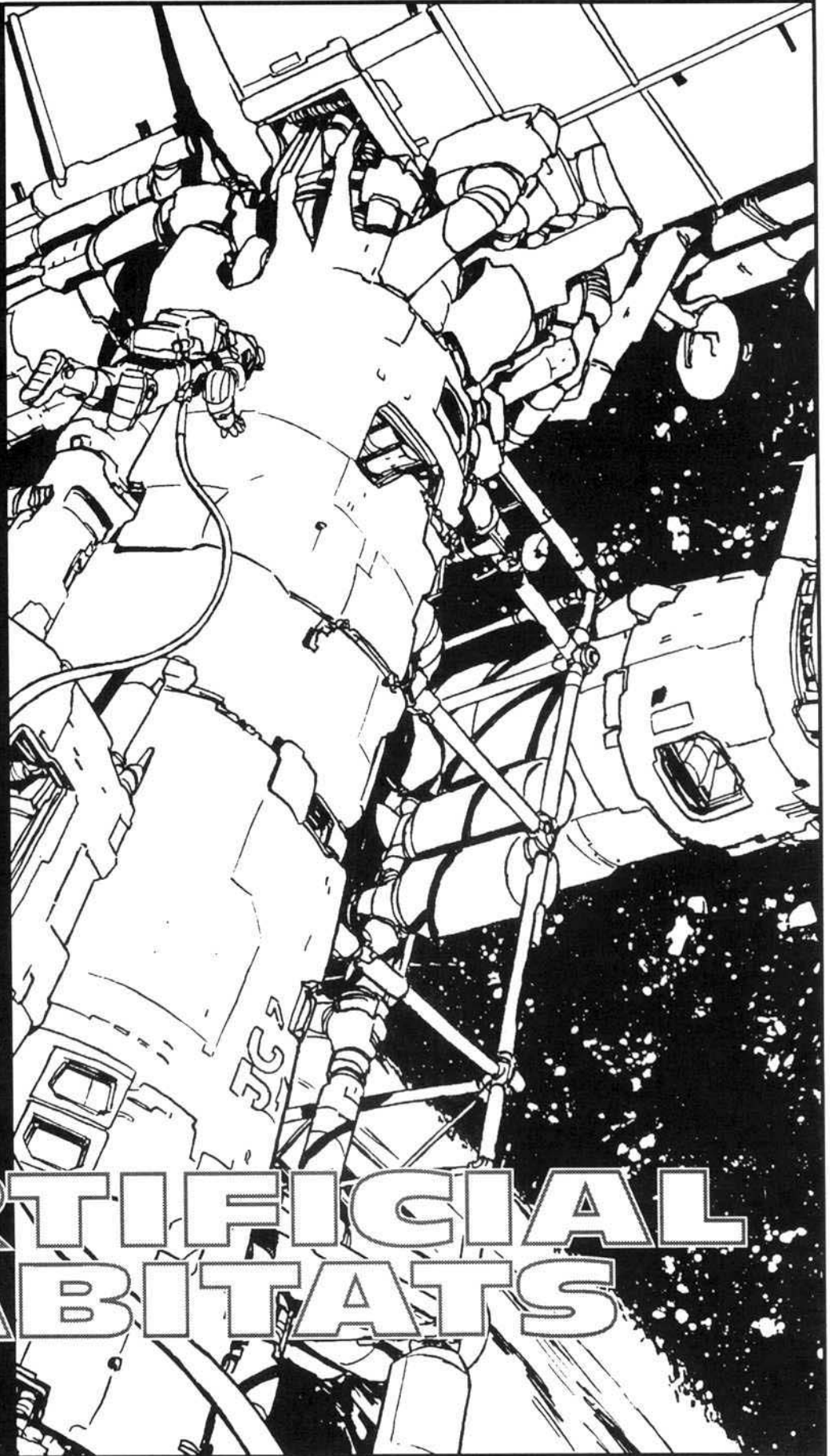

**SPACE
BASE**

Since the earliest days of space exploration, the goal has been to establish a permanent foothold on the High Frontier. In 2025, this goal has been met in a wide variety of ways, including workshacks, autofactories, battlestations, orbital colonies, and planetary bases.

WORKSHACKS

These are small, non-gravity stations, designed to support corporate research, manufacturing, or repair. The average workshack is made of five or ten modular sections, including two or three living sections, a lab section, a life support module, and a power module. These modules are fairly standardized; about 85% of all workshack sections in orbit are constructed by Japanese corporations, working from a base plan developed in 2006 by the Mitsubishi/Korydanshu Corporation. Specialized modules are constructed by the individual corporations themselves and mated to the basic modular design. There are nearly three hundred workshacks in Earth orbit, several dozen in lunar orbit, and three in orbit around Mars.

Workshacks do not have gravity; they are far too fragile to apply spin to. Instead, most have a gravity wheel attached to the central hub to provide relief from the stresses of zero-g. Workshack personnel are usually rotated back to gravity after a four-month tour of duty. Most workshacks support crews of ten to twenty people.

Most workshacks have a small, heavily shielded module designed to withstand a moderate solar flare. These cramped modules can support twenty people for up to four days. But it won't be a fun four days...

AUTOFATORIES

These are small structures, usually consisting of a power module, a monitoring station, and the main factory module. Autofactories are de-

signed to produce zero-gravity products, such as long-chain polymers and defect-free crystals. OTVs carry raw materials to an autofactory once or twice a month, pick up whatever has been produced, and restabilize its orbit before leaving.

Autofactories have almost no accommodations for personnel. They are primarily factories with only limited habitation at best.

BATTLESTATIONS

These are relatively rare. Although an enormous amount of "Star Wars" talk was generated by the US and USSR in the late '90s, budgetary considerations and the influence of the ESA kept the actual number of battlestations down to around seven confirmed installations. Four of these are controlled by USAF Space Command, two larger ones are the property of the Soviet Rocket Corps, and in a surprise move, the last large one is Chinese.

Battlestations are very similar to workshacks, but are built around a "core" weapon. This is usually a powerful laser or railgun weapon. Adjacent modules may contain missiles, nuclear weapons, smaller kinetic kill weapons, or particle beam arrays. While battlestations are usually well hidden behind jammer screens, their huge sensor arrays and high-powered radiation signatures make them very distinctive on a close visual approach. If, of course, you live long enough to get that close.

ORBITAL COLONIES

These are the most recent additions to the orbital hardware display. Orbital colonies are designed to be stationed in deep space between Earth and Luna. Isolated from regular supply runs (but decreasingly so), they are self-supporting mini-worlds, capable of generating their own air, food, and water.

In order to achieve this level of self-sufficiency, habitats must be very large to start with. They must be capable of generating their own spin gravity, which requires that they be either torroidal or cylindrical in shape.

The largest space habitats have been nicknamed L-5s, after their orbital positions at the LaGrange points around Earth and Luna. The most famous of these is the ESA's Crystal Palace station at L-1.

CRYSTAL PALACE

Constructed in an eleven year period between 2000 and 2011, the Palace is a five torroidal ring structure built around a large core extending for almost two kilometers through the center of the station. Each ring has a radius of 2.2 kilometers. The three central rings are entirely enclosed, while the two outer rings have two-meter thick leaded-glass windows to permit light to enter.

The torroids are protected from hard radiation by a thick shield of lunar rock. As with most space-borne equipment, all hardware on the Palace is hardened against EMP. The torroids spin at sufficient rotation to provide 0.8 G at the rim, dropping about 0.1 G for every 275 meters of altitude towards the hub.

Inside each inner torus are four levels of living facilities, manufacturing plants, life support systems, and apartment blocks. The two outer torroids support huge open parks; they are not only for recreation, but also provide the bulk of the Palace's oxygen supply. While most of this area is devoted to open space, there are common buildings, restaurants, and housing for high ranking Corporate and ESA officials.

While the ESA technically owns the Palace, it is in fact used by all space-capable nations, each of which maintains an embassy on the Palace for its nationals. Living space is leased by

A TYPICAL WORKSHACK

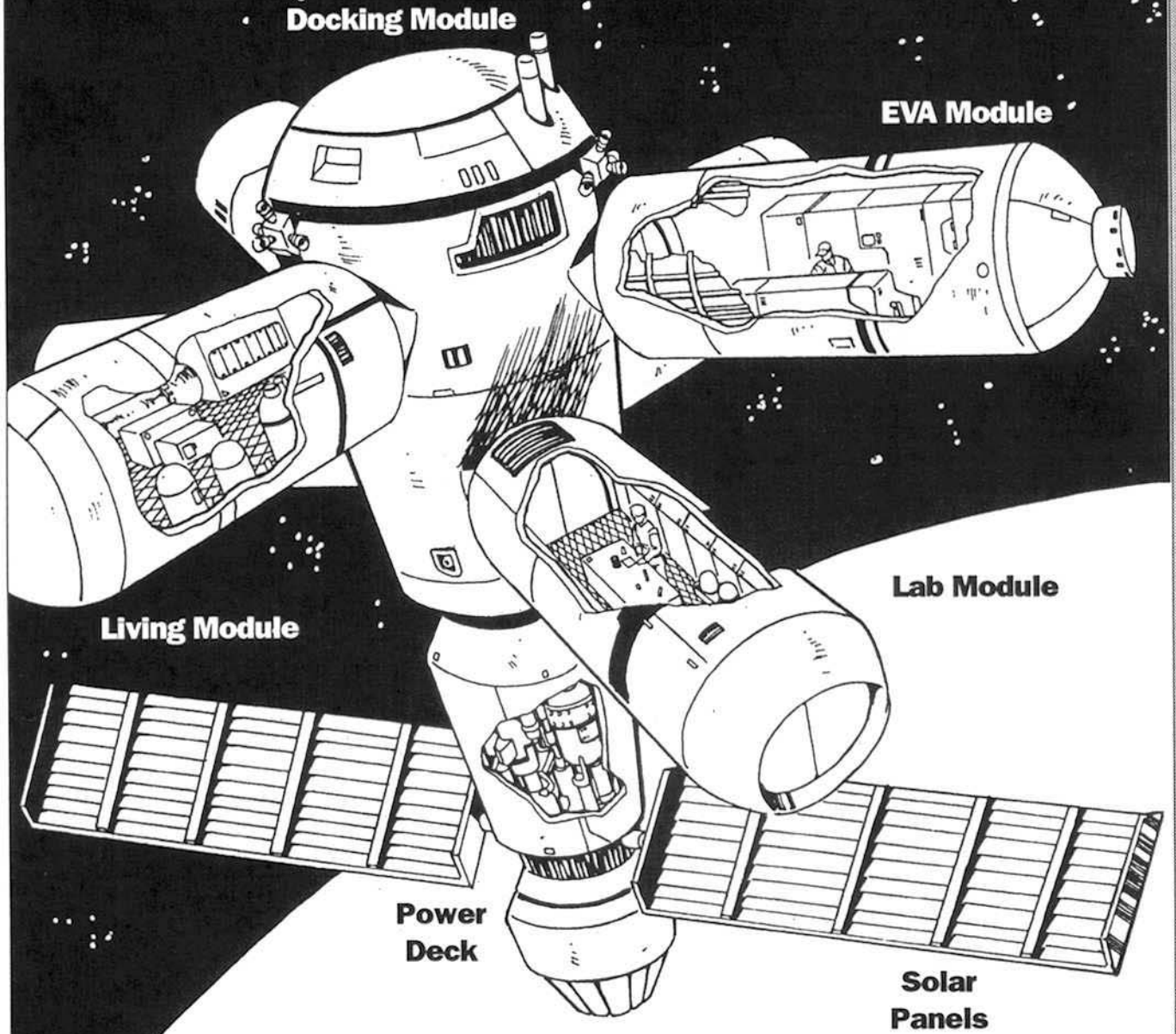

the ESA to the highest bidders on a twenty year renewable basis. In turn, the ESA maintains emergency services, general security, and station upkeep. Police services and law enforcement are the exclusive province of Interpol; the intra-European police organization, under an agreement with the ESA, reserves the right of judicial power over criminal offenses.

O'NEILL COLONIES

The second step in the colonization of space was the establishment of the O'Neill colonies. Built along the cylindrical plan, the titanic colonies, named after the late space colonization pioneer Dr. Gerard K. O'Neill, are between sixteen and thirty kilometers long and six to eight kilometers wide. The entire inner surface is covered in earth, broken by running waterways and huge windows to allow sunlight to enter.

The ESA's O'Neill One was the first of the habitats, located at the L-5 LaGrange point. O'Neill Two (Galileo Cylinder), at L-3, was completed in 2017, followed by O'Neill Three (Paradise Station, a joint US-Japan project) at L-4 in 2018. With the Highrider Revolts, it is unlikely that future O'Neills will be built by ground-based governments. A much smaller technology testbed version, which currently serves as a spacecraft construction and maintenance depot, orbits at L-2, over the lunar Farside.

PLANETARY BASES

The third step in the colonization of space was the construction of permanently manned facilities on other planets. Colonies have been built on Luna and Mars, and other stations exist on the Martian moon Phobos and the asteroid Ceres.

TYCHO/COPERNICUS

While the two lunar cities are not exactly space stations, they do fall into the category of space colonies. Both were constructed underground,

using a combination of blasting and nuclear powered heat smelters. An extensive warren of heat fused tunnels open into central, park-like caverns. These caverns are topped with geodesic pressure domes (the glass is formed from smelted lunar sand). Besides creating open space for lunar colonists, these open areas also provide most of the air and recycling capacities.

Luna was actually easier to colonize than open space. Gravity already existed, and the ability to soft-land machinery had been possible for over fifty years. With the use of nuclear-powered heat drills, it was relatively simple to fuse the silicate lunar soil into glass-like tunnels. Pockets of buried ice were mined for air and water, while plants were brought in to create a viable ecosystem. By 1999, modular sections of the Tycho mass-driver were softlanded and reassembled, allowing raw materials to be catapulted into space to construct the Crystal Palace.

All this didn't happen overnight, of course. The technology to colonize space was already in place by the early 1990s. What was required was the will and international cooperation to apply what was already known, plus a driving need to do so, generated by a collapsing ecosystem and a degenerating society.

You'd be amazed what rats can do to escape a sinking ship.

With the Highrider revolts, the various governments clamped down on the planetary facilities. Key parts of the life-support systems have been modified so that they can be remotely detonated. This insures that what happened on the O'Neills won't happen elsewhere.

CHRYSE BASE

A joint US-Japanese venture, Chryse Base is the first facility built with nanotechnology (used to form Mar-

EUROPEAN SPACE AGENCY

Right now the single most powerful force in space, the ESA is an outgrowth of an economic consortium of European nations called the European Economic Community. With the combined military and economic forces of France, Britain, Greece, Spain, Belgium, the Netherlands, Ireland, Italy, Luxembourg, the United German Republic, Portugal, Denmark, and Austria (with Canada as an associate member), the "Common Market" nations control a disproportionate amount of the High Frontier. And with the USSR's continuing overtures to the EEC, it looks as though the so-called "Pacific Century" has in truth become the "Age of New Europe".



DEEP SPACE

ARTIFICIAL HABITATS

tian sand into structure walls). While the principles have refused to explicitly state so, the sheer speed with which it was built denies any other explanation.

ISIDIS BASE

The EuroSpace Agency venture on Mars. It is smaller (500 people to Chryse's 900) than its competitor, but the potential for growth is stronger. ESA is putting considerable effort over the next four years into moving up to 600 more colonists to the base.

HALL STATION

The spacecraft and communications way-station on Phobos is known as Hall Station, named after Asaph Hall (who discovered the Martian moons in 1877 while at the U.S. Naval Observatory). Oxygen and slag is mined from the surface. The gravity is so slight that almost all spacecraft can land for servicing, and smaller spacecraft are often carried by hand to their dock space.

KIRKWOOD STATION

Located on Ceres, alongside one of the NASA autominers, Kirkwood Station is the only regular gathering place in the Belt. The station has no permanent residents, but is occupied on a rotating basis. Science teams, wandering surveyors, independent miners—whomever comes by is welcome to open the facilities and make use of them. Accommodations are sparse, but they're better than nothing: supplies are stored here, and there is a small hospital (although by the time a prospector gets here, it's usually too late for help). The nature of orbital mechanics means that most prospectors tend to travel directly back to Earth, anyway.

HABITAT MODULES

Habitats are built with modules to allow the greatest flexibility. Modules can generally be interchanged among habitats of the same type.

Modules are described in the following manner:

Typical Cost: The manufacturer's suggested retail price. Used prices are generally 30-80% of this.

Crew/Passengers: The number of crew needed to operate the module, and the number of passenger berths.

Power: the types of power systems.

Sensors: The manufacturer and base detection rating of sensors.

Computers: The number, capacity, and programs carried for each computer.

Cargo Capacity: The number of cargo bays, and their capacities, as well as any restrictions on use.

Weapon Suites: The weapons and defenses carried in typical suites for this type of module.

Damage Points: The damage elements and overkill points of the module; it uses the same method as Ships. T=general structure hits is added to the list.

TYPICAL CORE

Cost: 40 Million eb; usually rents for 350K eb/month, split between multiple users if possible.

Crew/Passengers: usually none; can support a few techs overnight.

Power: solar, batteries; rarely nuclear

Sensors: limited

Computers: normally two with 1 or 2 CPU each.

Cargo Capacity: 5m³

Weapon Suites: normally none; sometimes chaff or flares.

Damage Points: T P T D T P 3 2 1

TYPICAL WORKSTATION

Cost: 20 Million eb; rents are dependant on the nature of the work. Materials research would generally be 200K eb/month, plus a share of the core rental.

Crew/Passengers: 6-10

Power: batteries; normally depends on core module for power.

Sensors: typically 25%; may be higher when scanning for research-related subjects.

Computers: normally one in each habitat section (1 CPU); one in the lab with at least 3 CPU. Most memory will contain research programs and data files.

Cargo Capacity: normally 10m³

Weapon Suites: none; sometimes 1 or 2 points of armor.

Damage Points: T T W T P T 3 2 1

AUTOFACTORY

Cost: 35 Million eb; usually rents for 350K eb/month, plus core charges.

Crew/Passengers: none; can accommodate 2-3 for brief overnight stays.

Power: batteries; normally depends on core module for power.

Sensors: typically 25%

Computers: normally one with 3 CPU, and two backups (1 CPU). Programs depend on the manufacturing process.

Cargo Capacity: 20m³ for finished goods, 20-30m³ for raw materials, and 5m³ for waste products. Waste cannisters are sometimes launched to burn up in the atmosphere.

Weapon Suites: normally none; some factories engaged in shady business may have a laser or two, but they take space away from the machinery. Usually Armor 4.

Damage Points: T T W T P T 3 2 1

BATTLESTATION

Cost: 50-75 Million eb

Crew/Passengers: 3-6; sometimes on automatic.

Power: solar, batteries, nuclear

Sensors: typically 70%

Computers: one with 4 CPU; at least two backups (2 CPU). Has some sort of auto-routine program that includes targeting.

Cargo Capacity: 10m³, plus ammunition storage (missiles, railgun slugs)

TYPICAL STATION LAYOUTS

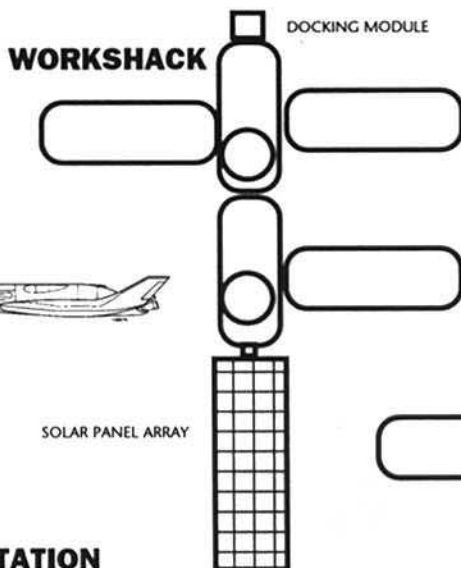
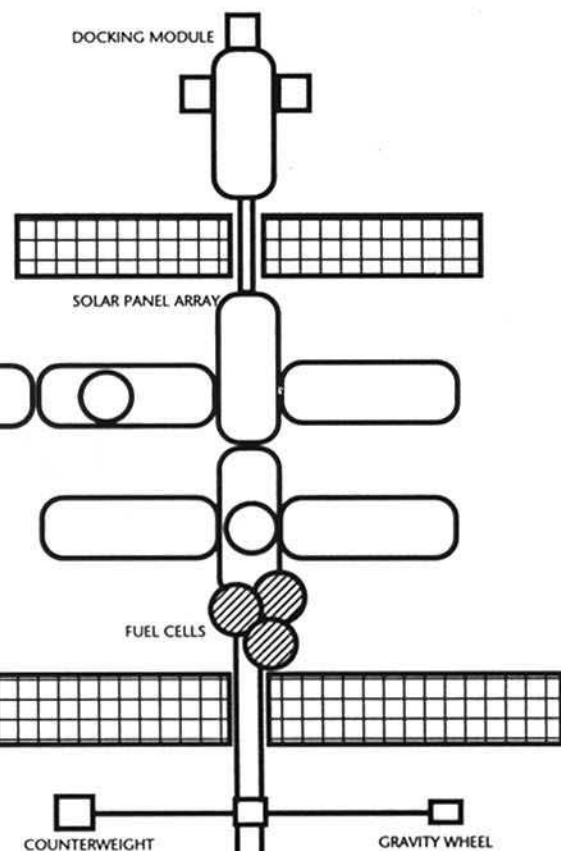
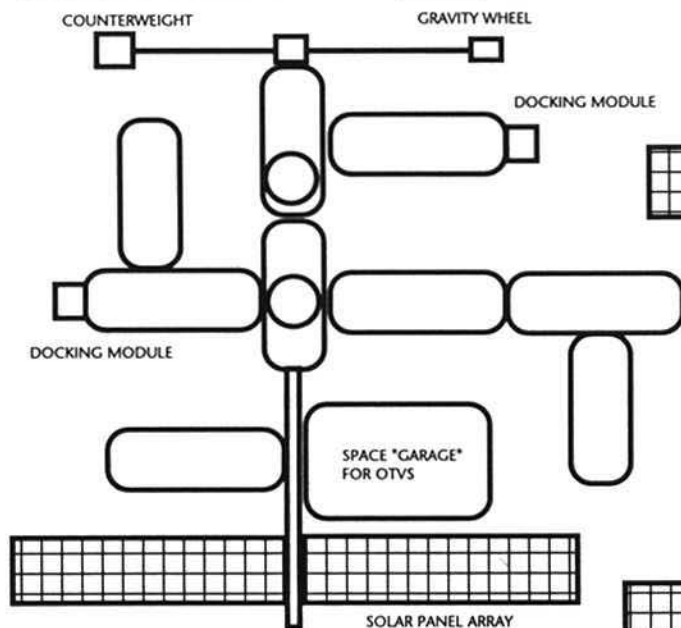
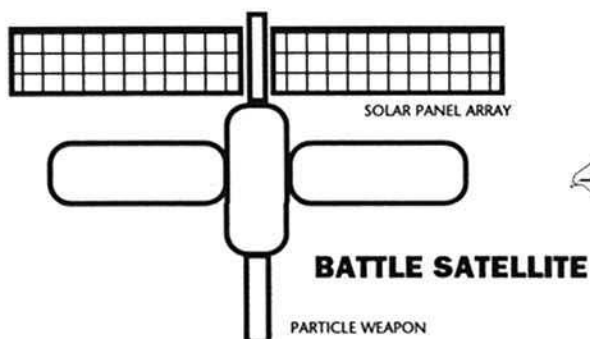
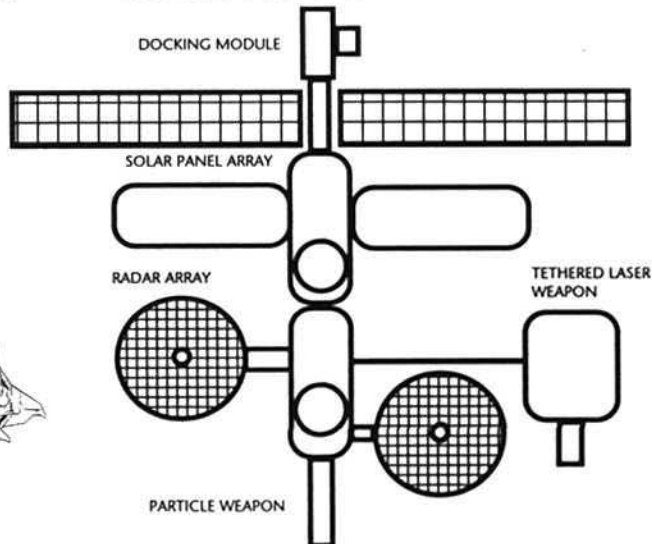
**RESEARCH STATION****TRANSER STATION****BATTLE STATION**

DEEP SPACE

ARTIFICIAL HABITATS

of 10-20m³. Some ammo is also stored outside.

Weapon Suites: lasers, 12-24 missiles, often a railgun, kinetic kill device, or particle beam. Jammers, chaff/flares, countermissiles. Usually Armor 4.

Damage Points: T W P D T W P S T S S 4 3 2 1

SMALL ORBITAL COLONY (L2 TEST-BED)

Cost: 200 Million eb for a 500m diameter colony.

Crew/Passengers: 15/200

Power: solar, batteries

Sensors: 35%

Computers: three with 3 CPU each, several backups with 1 CPU each. Typically has scientific and engineering programs available with appropriate databases, plus various utility and recreational programs.

Cargo Capacity: 50-100m³

Weapon Suites: none; if others of this type were built, they could be armed with lasers, missiles, and jammers. 2 points of armor.

Damage Points: T T W T P D P S W T P T W S T 8 7 6 5 4 3 2 1

CRYSTAL PALACE

Cost: at least 7 Billion eb

Crew/Passengers: over 5000

Power: solar, fuel cells, batteries

Sensors: 85%

Computers: one with 6 CPU, at least twelve with 4 CPU each, multiple dozens of smaller systems.

Cargo Capacity: 3000m³; capable of docking with up to 6 vessels at once, with the exception of Deep Space Explorers.

Weapon Suites: 7 lasers (3 in the center ring, 1 in each of the others), 30 missiles per ring, possibly a particle beam. Countermissiles, jammers, armor 2.

Damage Points: core cannot be hit until at least two rings are destroyed. Each ring: T T (Wx2) T T D T T (Wx2) T T S T T (Wx2) T T P T T 12 11 10 9 8 7 6 5 4 3 2 1. Core: T P T W T D T W T P T B 8 7 6 5 4 3 2 1

O'NEILL COLONY

Cost: about 4 Billion eb

Crew/Passengers: 20,000

Power: solar, batteries

Sensors: 45%

Computers: at least one with 4 CPU, at least twelve with 2 CPU each.

Cargo Capacity: 2000m³

Weapon Suites: none, armor 4.

Damage Points: (By their nature, it takes a lot to destroy an O'Neill; not as much to wreck one.) T T D T T P T T S T 18 17 16 15 14 13 12 11 10 9 8 7 6 5 4 3 2 1

GROUND BASES

These use the same damage system as orbital habitats with the following exception: ground bases simply have too many damage points to describe. When a certain amount of damage points are lost, the base loses the listed capability. Also, ground bases have no armor protection; the protective value of the planet is figured into the number of damage points. Note that exposed surface cargo can be hit in addition to the base.

TYCHO/COPERNICUS

Cost: Tycho, about 4 Billion eb;

Copernicus, about 6 Billion eb

Crew/Passengers: 12-18 thousand

Power: solar, nuclear

Sensors: 80%

Computers: at least twenty with 4 CPU, multiple dozens of smaller systems.

Cargo Capacity: Tycho, 5 Million m³ enclosed; Copernicus, 2 Million m³ enclosed

Weapon Suites: Tycho—main massdriver (12D10 damage), six smaller massdrivers (6D10 damage), 60 missiles, 3 lasers, jammers; Copernicus—three small massdrivers (6D10 damage), 12 missiles, 1 laser, jammers.

Damage Points: Tycho—200, with 50 overkill points

1] 30 points damage: main massdriver, sensors -30%, 5 missiles lost, 500K m³ cargo lost

2] 30 points damage: 2 small massdrivers, sensors -10%, 10 missiles lost, 500K m³ cargo lost

3] 30 points damage: 2 small massdrivers, sensors -5%, 10 missiles lost, 1 Million m³ cargo lost

4] 30 points damage: 2 small massdrivers, sensors -5%, 10 missiles lost, 500m³ cargo lost

5] 30 points damage: sensors -5%, 15 missiles lost, jammers lost, 1 Million m³ cargo lost

6] 30 points damage: sensors -20%, 10 missiles lost, laser lost, 1 Million m³ cargo lost

7] 20 points damage: remaining sensors, 1500K m³ cargo lost

8] Overkill points

Damage Points: Copernicus—80, with 20 overkill points

1] 15 points damage: 1 massdriver, sensors -20%, 3 missiles lost, 250K m³ cargo lost

2] 15 points damage: 1 massdriver, sensors -10%, 2 missiles lost, 250K m³ cargo lost

3] 15 points damage: 1 massdriver, sensors -10%, 3 missiles lost, 500K m³ cargo lost

4] 15 points damage: sensors -15%, 2 missiles lost, 500m³ cargo lost

5] 10 points damage: any remaining massdrivers, sensors -15%, remaining missiles lost, 250K m³ cargo lost

6] 10 points damage: remaining sensors and cargo lost

7] Overkill points

CHRYSE BASE (ALSO ISIDIS)

Cost: about 5 Billion eb

Crew/Passengers: 900 at Chryse, 500 at Idisis

Power: solar, nuclear

Sensors: 65%

Computers: one with 4 CPU, several backups with 3 CPU each.

Cargo Capacity: aprox. 750K m³ enclosed

Weapon Suites: believed to be 30-50 missiles, 3 lasers, jammer.

Damage Points: 70, with 50 overkill points

1] 20 points damage: sensors -25%, 10 missiles lost, 150K m³ cargo lost

- 2] 15 points damage: sensors -15%, 10 missiles lost, 1 laser lost, 150K m³ cargo lost
- 3] 15 points damage: sensors -15%, 10 missiles lost, 1 laser lost, 200K m³ cargo lost
- 4] 15 points damage: sensors -5%, remaining missiles lost, 1 laser lost, 150m³ cargo lost
- 5] 10 points damage: lose remaining sensors, missiles, cargo
- 6] Overkill points

HALL STATION

Cost: 600 Million eb

Crew/Passengers: approx. 50

Power: solar

Sensors: 55%

Computers: one with 4 CPU, four with 3 CPU each.

Cargo Capacity: 250K m³, approx. 30 ship berthing spaces
Weapon Suites: 10 missiles, 1 laser

Damage Points: 40, with 10 overkill points

- 1] 10 points damage: sensors -20%, 3 missiles lost, 100K m³ cargo lost
- 2] 10 points damage: sensors -10%, 2 missiles lost, 50K m³ cargo lost
- 3] 10 points damage: sensors -10%, 3 missiles lost, laser lost, 50m³ cargo lost
- 4] 10 points damage: lose remaining sensors, missiles, cargo
- 5] Overkill points

KIRKWOOD STATION

Cost: approx. 250 Million eb

Crew/Passengers: 100 man/days of accommodations

Power: nuclear

Sensors: 70%

Computers: one with 4 CPU, three with 2 CPU each.

Cargo Capacity: 200K m³

Weapon Suites: 2 small massdrivers, 6 missiles, jammer

Damage Points: 30, with 7 overkill points

- 1] 10 points damage: 1 massdriver lost, sensors -25%, 3 missiles lost, 100K m³ cargo lost
- 2] 10 points damage: remaining massdriver lost, sensors -25%, 2 missiles lost, 50K m³ cargo lost
- 3] 10 points damage: remaining missiles, sensors, cargo
- 4] Overkill points

O' NEILL COLONY

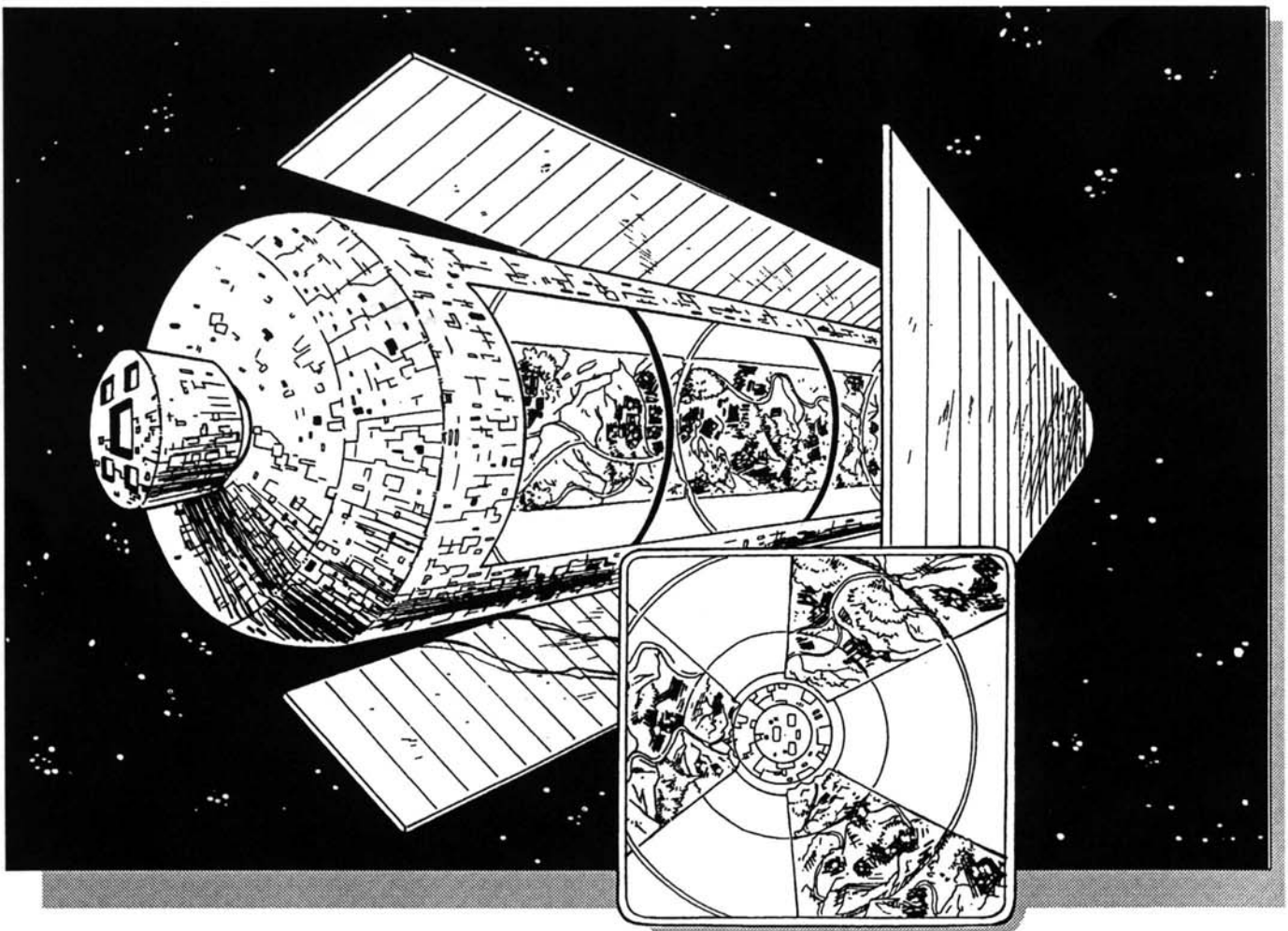

CRYSTAL PALACE

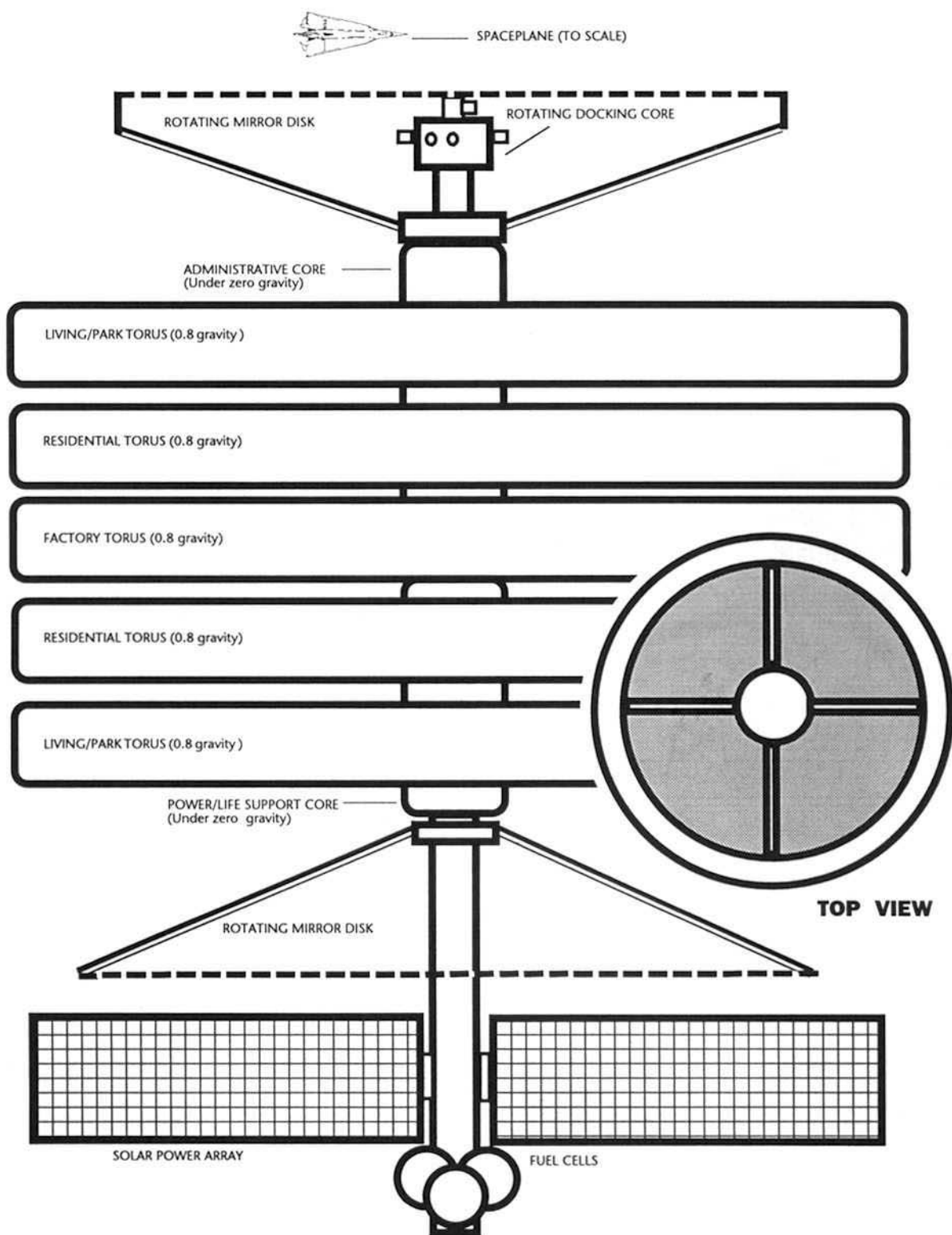

TYCHO MOON BASE

**This is a multi-level,
underground facility.
Population: 18,000**

- 1. Main Gallery**
- 2. Main Business District**
- 3. Living Quarters**
- 4. Main Control,
Atmosphere Plant and
Administrative Offices**

- 5. Factories**
- 6. Labs and Scientific
Areas**

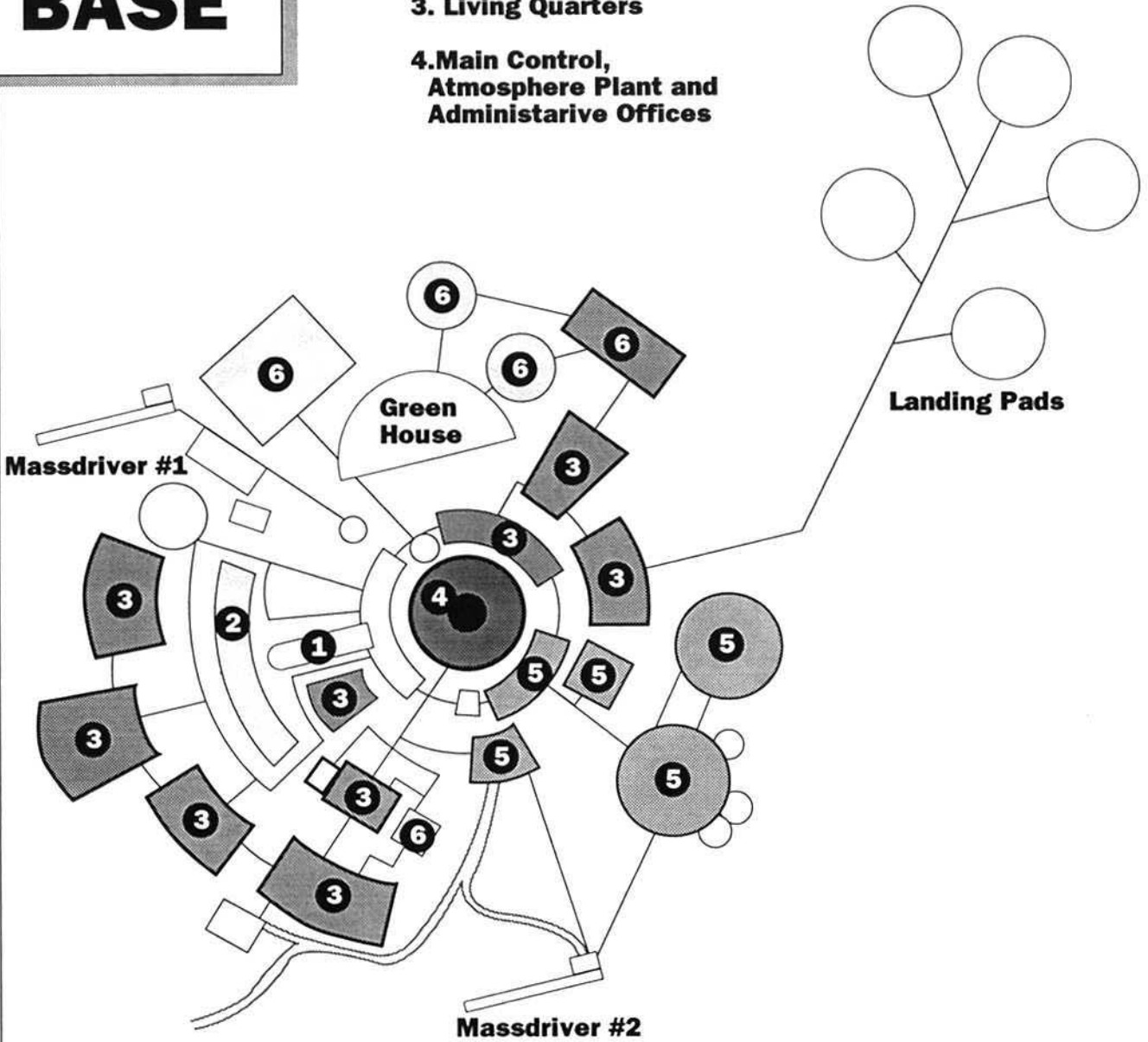

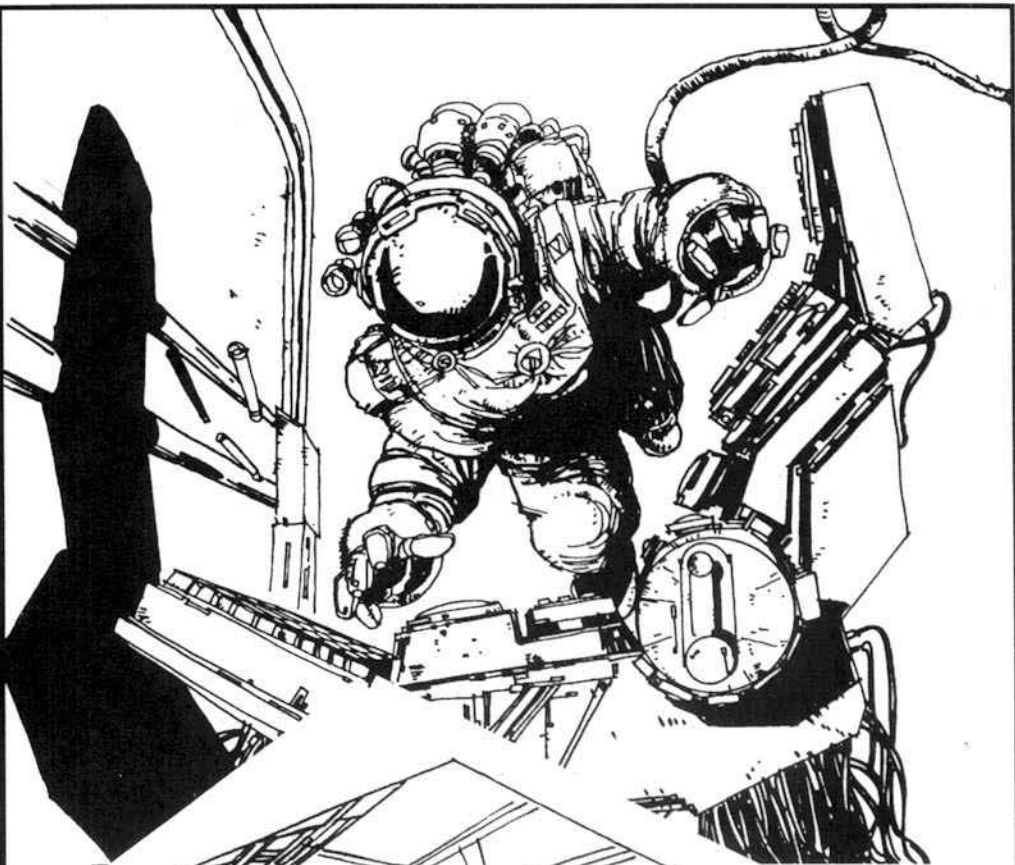
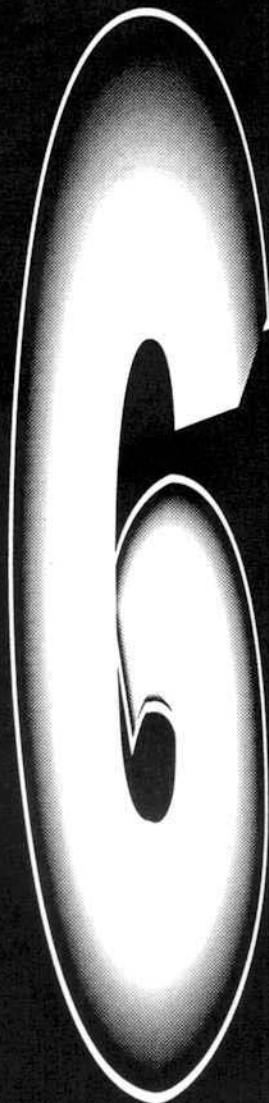

In the harsh environment of Space, it's those you live & work with that make the difference...

LIVING & WORKING IN SPACE

HIGHRIDER(S)

Highrider is an Earthside term used to

describe those who have been born, or spend most of their time working, in space. Highriders who have been born outside the gravity well share a number of common traits and most share a genetic heritage towards greater tolerance to zero gee, low air pressure and radiation. They are usually slightly weaker than groundsideers, due to lack of gravity (-1 mod to Body Type), but have tremendous stamina and determination.

As described earlier, the ESA Hireout has biased the orbital gene pool toward a large proportion (68%) of African base stock. The remaining portions are a mixture of European (11%), Asian (10%), Middle Eastern (1%), Soviet (4%) and American (6%).

ORBITAL CULTURE

A strong tribal culture pervades the Highrider society. Institutions such as manhood rituals and rites of passage exist throughout the Orbital Zone and extend into the colonies on Luna and Mars. Although the authorities have attempted to discourage these activities, they still flourish, particularly in the "free" habitats. At the L-3 colonies young men and women chance a nerve-racking journey from the main cylinder out to the remnants of an ESA battle sat which was destroyed in the O'Neill Wars. Using only a handheld EVA unit and a one-hour respirator pack they scrounge in the wreckage for a token of their achievement before jetting back to their awaiting friends. The return journey itself takes almost an hour, without mistakes.

There is an extensive oral history in orbit. Highriders are fond of telling stories and legends, and have constructed entirely new mythologies based on life in space (or "The Dark", as it is often called). These cultural

identifications have, to some extent, been absorbed even in the technician and managerial classes, expanding from their original African roots to encompass Asian and European legends. Their cultures thus combine the best of African, Asian and European styles, with bold colors and a vibrant exotic urgency.

The space environment is dangerous. Highriders tend to be fast-reacting and level-headed, or dead. Highriders are usually well educated—in isolated workshacks and construction projects there is little to do but read or talk. Most Highriders can speak several languages; however, they have developed their own dialect, the orbital version of Streetspeak, which is known as *The Word*. The Word includes smatterings of French, German, Japanese and a variety of African dialects and is both musical and efficient. Most Highriders can also manage a conversation in several of the individual component languages.

Space is crowded and workshacks usually don't provide much in the way of privacy. Like the Japanese, the Highriders have evolved many social conventions to help create a sense of privacy. For an outsider this can lead to some uncomfortable situations. In space there are no nudity taboos (not after the first time you don a skinsuit with someone else helping), but it is considered rude to stare while someone is undressed. Personal belongings are few and the "kit" or "outfit" contains the Highrider's most private things. This includes clothing, a rad detector, a water flask and a small personal respirator. Every Highrider also carries at least one "Goop Ball" in case of a pressure violation.

Highriders are slow to anger but are extremely nasty when riled. An easy way to upset a Highrider is to do something really stupid to violate a pressure seal, like firing a gun inside

Some Highrider Slang

Aerials: To do zero-G gymnastic/acrobatic stunts

Apogee: The best.

Breath Vac: To run out of air.

Belt, Belting: The Main Asteroid Belt. Also to live or work in the Belt.

Chaal: To be tough.

Config: To arrange something; as in "I configged to dock with her".

The Dark: Space.

Delta'd: To make maximum speed to somewhere.

Dirt Sniffer: See Groundsider

Drop Out: Return to the gravity well, i.e., Earth, Luna, Mars ...

Dock: To meet someone. Also to have sex.

Go LEO: To leave the gravity well to Low Earth Orbit.

Groundsider: Someone who is rarely in space.

Gee: Weight or gravity.

Goop Ball: A ball of sticky polymer which can be used to temporarily seal small pressure violations.

Grab Gee: To spend time in a gravity field, usually to counter the effects of prolonged zero gee.

Grav: Same as gee.

Kranston: To become violently spacesick; as in "When we hit LEO the dirt-sniffer pulled a Kranston maneuver."

Some Highrider Slang (cont.)

Popsicle: Frozen corpse, usually from a space wreck.

Rad: Radiation. Also a dose of radiation.

Salv: Retrieve space junk, usually for reward.

Signal: Personal style, i.e., clothes, suit decorations, tattoos, etc.

The Word: The spacers' own common

a habitat. Within the cultural groups there are close bonds and a Highrider will always back up another Highrider in need. Anger a Highrider and you'll have an entire Workgroup down on you—hard. Most Highriders are proficient in some form of martial art and highly adept with a knife. In most cases they disdain guns; not only are they risky to use, but due to recoil effects they are invariably less lethal than a knife in the right hands.

The O'Neill Wars have left an aftermath of anger and distrust which pervades space culture. In the so-called "free" habitats, including O'Neill One and the Galileo Cylinder, strangers receive a cold reception. Any unexpected vehicle which closes on the space of these habitats and cannot easily identify itself is quickly met by several well-armed Deltas and a boarding party. Refusal to accede to their authority will quickly escalate into the use of force.

DRUGS AND SPACE

An alcoholic Highrider is a dead Highrider. The same goes for Smash, Crack, Dorph and most of the nasty synthetic nightmares that pollute the streets and riddle its population. These kind of drugs blur your reactions and slow your reflexes, both certain to kill you soon enough. There are no Dorpheads in space.

Also, Highriders don't smoke. Ever. If it isn't bad enough that smoking fouls the air scrubbers and messes up electronics (the smoke has a nasty habit of carbonizing around electronic components), it also really screws up your lungs. Remember, in space air is the most precious thing you have.

This doesn't mean space is "clean." Highriders go for fast highs that give a blast and then leave their brain and senses clear. Rapidly dispersing aerosols, such as nitrous oxide, are popular and many new drugs have filtered into the Orbital conscience since the early days. Stimulants are

no longer frowned upon; rather, they tend to be taken in a group context as part of the social interaction. Many of the newer drugs, rather than just providing a "high", also boost reflexes or intelligence, and many of these come complete with their own forms of addiction.

THE DANCE

The most common Highrider addiction is the braindance, a neural hookup which allows the user to "live" in a pre-generated artificial reality (much like early net-based interface programs). Interacting with the Dance is a lot like netrunning through a controlled Virtual Reality. Once in the Dance, a participant may "watch" a sim (audio/visual/tactile simulation), which is today's equivalent to the old-fashioned "video." In a sim you normally take the part of one of the characters, usually the lead role, and get to interact with the story. Masters at the sim engage in one-to-one or group competitions, building new challenges for one another with special "gaming" sims. For a more detailed look at Braindancing, see the *Cyberpunk 2020* supplement, *Rockerboy*.

A NEW SKILL - BRAINDANCE (INT-BASED)

This skill is similar in some respects to the Netrunner's "Interface" skill in that it measures the ability to respond quickly to activity within the Dance. Rather than executing programs, though, the participant must use his imagination/intellect to effectively steer the course of the stories. The better his ability, the more control he has over the running of the Dance.

For example: George has run a few Dance sessions and has a Braindance skill of 1. He is currently in a Western sim and walks into a bar. He quickly recognizes a familiar figure in the bar. It is the famous gunslinger Texas Jim, who is out to kill him. George reaches for his Colt 45 to gun down

the villain, but, the town sheriff shoots him dead for attempting to draw a weapon inside the bar.

Cherice is a true expert who has spent many hours in the Dance. She is competing against another Highrider in a generated sim, playing poker. Cherice is calm, confident that she only requires an ace to win. Concentrating on the sim, she requests a new card from the dealer, while across the table her opponent looks at her with a smile of triumph. The card slides across the table and Cherice turns it over casually—an ace. She smiles sweetly and exits the sim for some food.

SO, WHAT DO THEY DO?

Highriders can no longer be considered

the “working class” of space. They are well educated and hold positions ranging from construction workers to pilots, scientists and colony managers. All of the existing *Cyberpunk* character roles fit equally into the space culture with their own Highrider-style twists. For example, a Rocker is more likely to be adept with vocals and story-telling skills than massed ranks of high-powered amps and an axe. The most flexible space class is the Nomad, who may be a commercial or military pilot, a pioneer into the outer reaches of the Belt, or a modern space pirate. The Space Careers Table lists the relative percentages of each type (a fast encounter table for referees) as well as the basic class types each standard *Cyberpunk* character will fall into.

ORBITAL CAREERS

Many of the potential careers available in space are similar to the Nomad character role, being suitable for these roving and hardy individuals. Characters electing to take these careers will be generated as normal. Those characters who have been born in space (must be age 25 or lower) may also take advantages in avoiding spacesickness (pg 24) and in *Zero Gee Maneuver* Skill. Several



new character classes are available for space-based individuals:

WORKGANGERS

The largest portion of the orbital population is still maintained within the many construction crews and operational staff who make the running of habitats and workshacks possible. Workgangers are experienced in using spacesuits, EVA packs and workmodules. Tough and self-reliant, workgangers are also experienced in Zero Gee Maneuver and Combat. Special Ability: **Workgang** (a variant of Family). The “Work-gangers” constitute the largest extended “family” imaginable and their influence extends throughout the orbital culture.

Skill Package: Space Survival, EVA, Zero-G Maneuver, Operate Hvy. Machinery, Pilot (OTV), Basic Tech, Electronics, Expert (Construction Techniques), Strength Feat

SPACE CAREERS TABLE

01 - 25
Workganger (Nomad)
26 - 35
Support (Fixer, Media)
35 - 55
Technician/Medtech/Biotech (Tech)
56 - 60
Corporate (Corp)
61 - 66
Security (Solo)
67 - 72
Marine (Solo)
73 - 78
Shuttle Pilot (Nomad)
79 - 84
OTV Pilot (Nomad)
85 - 89
Military Pilot (Nomad)
90
Salver (Nomad)
91 - 94
Entertainer (Rocker)
95 - 00
High Ranking Official (Corp)

PILOT

The rare breed who “fly” the many commercial, corporate and military vehicles which clutter space, and control much of the transport of equipment and personnel. Special Ability: **Brotherhood** (a variant of Family). Like Nomads on Earth, these characters are often individualistic and adventurous, but have a network of other Pilots always ready to back them up.

Skill Package: Space Survival, EVA, Astrogation, Pilot (OTV), Pilot (Spaceplane/Shuttle), Basic Tech or Electronics, Programming, Mathematics, Physics

SALVER

As the number of workshacks, shuttles, laser sats and even small habitats increases exponentially, many disused hulks or wrecks litter the orbital space. This new breed of

DEEP SPACE

LIVING & WORKING IN SPACE

individual scouts around and collects these disused relics, which sometimes contain a wealth of equipment or perhaps even a forgotten corporate secret. Often themselves using almost derelict shuttles or OTV's to search for the illusive "strike," Salvagers wander the forgotten orbits. Of course, sometimes there is mileage in "Salving" something which wasn't quite dead yet. Special Ability: **Salvage**. This encompasses the ability to spot a piece of valuable space-junk in the first place and to know how to harness it without crippling your own craft. It also functions as the Techie's ability of **Jury Rig** at half level. Most Salvagers are also pretty decent short distance pilots, and are usually handy with a gyrojet pistol in a scrape. Salvagers usually know several Fixers who help find buyers for their wares.

Skill Package: Space Survival, EVA, Zero-G Maneuver, Astrogation, Operate Hvy. Machinery, Pilot (OTV), Basic Tech or Electronics, Awareness/Notice, Melee or Handgun

MARINE

Both governments and corporates are fitting out elite squads of cybered warriors with armored work-suits and heavily-armed spaceplanes. These squadrons patrol sections of space and are a law in their own right. Special Ability: **Space Combat**. This skill is added to both Zero Gee Combat and Zero Gee Maneuver when involved in space-based combats and reflects the highly specialized training these individuals have undergone to become adept at combat in space.

Skill Package: Space Survival, EVA, Zero-G Maneuver, Zero-G Combat, Awareness/Notice, Pilot (OTV), Driving or Motorcycle (for Moon/Mars buggies/trikes), Melee or Handgun, SMG or Rifle

ORBITAL SKILLS

The unusual environment of space introduces new skills which must be learned if characters are to success-

fully operate in space. With the exception of Astrogation these skills must be learned by experience. The reflex skills may be chipped but cannot be adapted to without zero gee experience. If spacesick, you will be unable to learn a chipped skill until cured.

ZERO-G MANEUVER

(REF based)

This skill is the ability to maneuver in low or zero gravity conditions. It allows a character to kick off surfaces and catch himself on the rebound, make turns or flips in mid-air by body movements, and to hold position if needed. Orbital-born characters automatically have this skill at +3, and may buy it at higher levels using IP. In order to acquire Zero-Gee Maneuvering, you must first get used to the conditions of weightlessness. This isn't easy for everyone. Each time a Groundsider character encounters a new condition of weightlessness, such as crossing an airshaft, finding himself suspended at a height without visible means of support, or some other sudden zero-g shock, he must make a Cool roll (Cool + D10) higher than 10 or be momentarily paralyzed by fear for 1D6 turns. Until the character has successfully made five such rolls, he will be considered unadapted to zero gee and unable to master this skill. Once adapted, he need not make any further Cool rolls.

ZERO-G COMBAT

(REF based, IPx2)

Also known as *rei-ju-ryoku-ryu*, this is a specific fighting style developed for use in zero gravity. This skill replaces Martial Arts or Brawling when you fight in a no-gravity situation (if you were to use those other combat styles in 0-G you would end up a helpless spinning tangle of arms and legs). The training also teaches the character how to use recoil weapons in zero gravity. When firing a recoil weapon, he may add this Skill to the required Recoil Save Roll (pg. 25). You must have at least three points

in Zero Gee Maneuver Skill before you can acquire this skill. Your Zero Gee Combat Skill can never be higher than your skill in Zero Gee Maneuver.

EVA

(REF based)

How to use EVA packs, hand-held thruster units, etc. Difficulties for such maneuvers as approaching habitats, rendezvousing with another person, and so on, are set by the Referee.

SPACE SURVIVAL

(INT based)

When an emergency occurs in space you have little time to respond and you can't afford to get it wrong, otherwise you might find yourself breathing vac or glowing in the dark. This skill allows you to know the proper procedures during emergencies. It includes how to use a goop ball; how to cycle an airlock; how to read a personal rad meter; what to do and where to go in a solar flare. Referees may use this skill to determine whether a character knows a given piece of important information about day-to-day survival in space.

SPACEPLANE/SHUTTLE PILOT

(REF based, IPx3)

How to pilot a spaceplane or shuttle. Knowledge of scramjet engines, how to dock with stations (Difficult task) and how to make a proper orbital reentry (Very Difficult) without burning up in the atmosphere.

OTV PILOT

(REF based, IPx2)

The skill of piloting OTV's and other small cargo-type spacecraft. This skill allows the character to make soft lunar landings (Very Difficult task), dock with space modules (Difficult) and maneuver an OTV through space.

ASTROGATION

(INT based, IPx2)

This skill allows a character to calculate a spacecraft course using computers, course tables and navigation

beacons (Difficult task). Without these navigation aids the difficulty of this task increases to Very Difficult.

THE ORBITAL CHARACTER

Orbital characters of all types may use Lifepath as normal. Referees should adjust situations to reflect the Orbital background.

WHAT DO THEY WEAR?

The rigors of space have standardized personal equipment to a minimum. The most common outfit, known as a slap-suit, is a loose coverall with a variety of pockets (with velcro fasteners) and covered in patches signifying the wearer's allegiances. These include workgroup, corporation, and workshack and station patches accumulated over many years. Short sleeves are also common, but dresses, skirts and kilts are NEVER seen—in zero-gee dresses end up around the wearer's head!

Many workganger groups go nude, or close to it, within their home environments. Hair is either short or tied back—or else it also ends up in your face!

Highriders aren't big on make-up, complex hairstyles or accessories such as long earrings or necklaces. These last can be a nuisance, and dangerous, in space. Jewelry is simple, to avoid entanglements in zero gee, and many workgangers affect tribal scars or tattoos. Perfume is never worn - in the enclosed confines of a workshack or OTV even the best perfume gets pretty oppressive.

WHAT DO THEY EAT?

Hydroponic tanks not only support growing plants but also small aquatics. The Highrider diet runs to vegetables, tank-grown seafood, algae and dried starched like rice and noodles, all covered in thick (to hold it on the plate), usually highly spiced, sauces.

Of course in an isolated workshack the old preprocessed food paste tubes may be the only option.

Food is packaged in special preparation labs in the spin gravity sections of larger stations. It is packed inside microwaveable bags, with all the extra water removed and recycled, or in recyclable dishes covered in plastic wrap (also microwaveable). Crumbly foods are avoided; you won't see much bread in space.

Drinks are packaged in airtight bags with drinking straws as part of the container - hot drinks like coffee have small creamer and sugar packs as part of the container. One just squeezes in however many portions are desired, then microwaves the entire package. The one drink you won't ever see in orbit (except on the Palace and maybe in the LSs) are carbonated sodas or beer; these are too likely to end up as impromptu missiles in a workstation's zero gee.

CYBERWARE IN SPACE

In space you rarely see the great clunking cyborg monstrosities which prowl the urban ruins. The cascading radiation and electromagnetic effects of LEO tend to make standard cyberware malfunction. This depends on the local radiation/magnetic levels, but for most orbital habitats there is a 10% chance for every week spent in orbit that a given piece of unshielded cyberware will malfunction. Having an eye black out is annoying, but when a cyberleg starts pumping uncontrollably it becomes downright dangerous, especially if you are in zero gee at the time. This means that orbital cyberware must be shielded against stray electromagnetics, which increases the cost by 50-200% depending on the item and where you are at the time.

In addition, most really serious cyberware is weapons-intensive and includes high caliber projectile weapons, rocket launchers and other ki-

netic weapons. In low-gee, pressure-sealed environments these weapons must be replaced with less lethal knives or reduced velocity versions. Flechette weapons can be installed on a 24-hour turnaround by most competent orbital techs, at a cost of about 150-200eb per installation (plus the weapon cost). But then, that's 24 hours when you don't have a left arm, right?

Even less obvious modifications like scratchers can prove a problem in space. Try putting on a skin suit when your hands are terminated in 2cm long razor sharp carbo-fibre blades, and don't ever unsheath those rippers in a vacuum.

On the other hand, certain forms of cyberware modification are very common in space. At least 40% of Highriders have replaced both eyes with (shielded) cyberoptics, allowing them to dispense with heavy goggles and glazed helmets. Radio splices are also common, as are various forms of reflex and sensory boost. With the increasing availability of nanotechnology, most Highriders are also investing heavily in bioware for everything from greater strength to radiation protection. Bioware is far more readily available in orbit than groundside. It is mostly constructed in the orbital factories and laboratories and is usually cheaper (10 - 20%) to purchase as well.

In space, subtle is best.

POLITICS IN SPACE

Nobody controls space. Almost everyone THINKS that they control a piece of it. The vastness of scale involved means that everything, even communications, takes time and money. Most large habitats and each of the colonies have their own "local" administrative and law enforcement agencies.

The hundreds of isolated workshacks, factories, laboratories and smaller habitats owned by corporations and Earth-based governments are controlled by

the central administrative processes of their individual corporations and governments. In many cases a head technician or corporate lackey runs the day to day business and has the final arbitration in disputes. Larger corporate or military installations have their own forms of police force, operating under whatever local rules they see fit.

ESA still effectively controls the largest portion of inhabited space through the direct management of Crystal Palace, Paradise Station, the Tycho and Copernicus bases on Luna, the Mars Isidis base and hundreds of workshacks and satellites. They have an even larger sphere of influence through the EEC-controlled Interpol, which polices many of the independent transfer stations, Orbital Air facilities and flights, and all ESA-maintained habitats and colonies. Interpol agents are highly skilled and have wide ranging authority wherever they are authorized to act.

In space, whoever controls the atmosphere, food and water supplies makes the rules. It also helps to be on the team with the most weapons.

THE "ORBITALS" —SPACE BASED CORPORATIONS

While most large Corporations have been surprisingly slow at moving their operations off "dirt," there are several notable exceptions. Apart from the two major Corps (IEC & UC) listed earlier, many smaller operations have sprung up in the power vacuum which accompanied the real vacuum of space. The new corporate arena of orbital control is, if anything, dirtier and more highly contested than the somewhat stagnant Earthside version. After all, in space there are NO rules.

Orbital construction and manufacturing have become the largest growing areas of industry available to any corporation, and the rapid expansion of humanity into the colonies on Luna and Mars are opening vast

new areas of exploitation. Characters will often become sandwiched between corporations as they vie for control of new technologies and new markets in a corporate arena that makes Earth look like a children's playground. Several new small corporations have appeared recently and are taking advantage of the opportunities which abound in orbit and in the colonies.

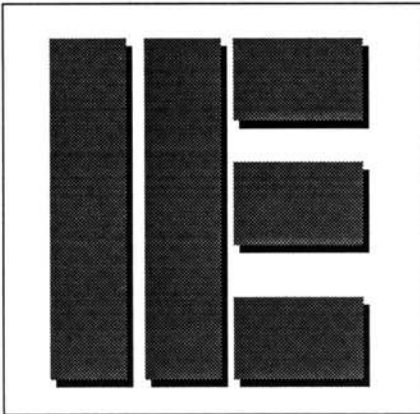

International Electric Corporation

For a detailed description of IEC refer to the *Cyberpunk* supplement, *Corporation Report 2020, vol.1*

Main business: General Manufacturing

Headquarters: SuperLink research station.

Groundside Installations: Berlin, London, Paris, Stockholm, Moscow and others.

Orbital Facilities: Three manned research laboratories, a Lunar complex, a major OTV construction facility, between twelve and fifteen autofactories.

Name and location of major shareholders: Erich Kessler at SuperLink station, 8%; in conjunction with Berlin Industrial Investments, 38%

Total Employees: 800,000

Troops: 50,000

Covert: 1300

Utopian Corporation

Main business: Nano-construction

Headquarters: Utopia - a private orbital facility/laboratory

Groundside Installations: London,



Los Angeles and Rome.

Orbital Facilities: Seventeen autofactories and nine manned laboratories.

Name and location of major shareholders: 80% of the shares are owned in equal proportions by Dr. Sergeii Ranon, Crystal Palace; Dr. Charon Twine, Utopia station; Dr. Carlos Renbro, Paris, France; and Dr. Janet Harnes, Los Angeles.

Total Employees: 21, 000

Troops: 1,500

Covert: 230

Background: As described earlier, Utopian Corporation was formed by a group of brilliant and disgruntled Microtech scientists. After selectively leaking small amounts of crafted Bioware into the street market in 2017, UC has begun manufacturing drugs, high-technology components, skinsuits and other newtech creations which far outstrip the competitive offerings. Utopian tries to keep a low profile, as it would be an attractive target for giants such as EBM and IEC. However, it is already far larger than its competition realizes.

Equipment and Resources: Utopian Corporation has fourteen armed deltas, three private spaceplanes, twenty five OTV's and four battle sats. Its security forces are always armed with the latest and most powerful weapons available. The corporate policy of distributing key personnel and facilities over a wide area makes them difficult to harm.

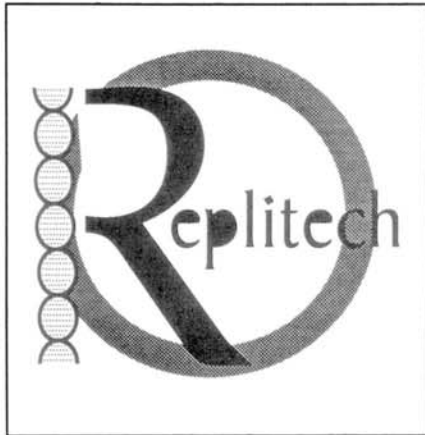

Replitech

Main business: Genetic Engineering
Headquarters: Crystal Palace
Groundside Installations: None
Orbital Facilities: Three autofactories and two manned laboratories.
Name and location of major shareholder: Dr. Alexis Yulo, Crystal Palace, holding 35% of total shares.
Total Employees: 2,500
Troops: 15
Covert: 3

Background: Replitech was founded by a small group of Russian scientists with American corporate backing in 2018 and is almost entirely based on experimental work with genetic wheat varieties which could be grown effectively in hydroponic vats. Since then they have developed several highly successful food produce variants which are now used by most major space habitats. Replitech is expanding rapidly but, because of its small size and limited troop resources, has invested heavily in external military protection. It is one of many orbital companies which has made use of Lazarus Corporation's new "Orbital Strategic Guard" facility to its distinct benefit.

Equipment and Resources: Replitech has seven OTV's and three deltas which rotate between its installations. Most if its troop resource is utilized as anti-infiltration police within its own facilities.



Terra Nova

Main Business: Environmental Technology
Headquarters: Paradise Station
Groundside Installations: New Mexico, Earth (Research) and Copernicus Base, Luna (Support).
Orbital Facilities: Four autofactories and eight manned workshacks.
Name and location of major shareholder: Yohan Libewitz, Paradise Station, holding 20% of the shares.
Total Employees: 3,400
Troops: 85
Covert: 5

Background: Terra Nova is a joint Soviet/American venture specializing in space environment construction and support. Terra Nova originally formed from the team which designed and constructed the "life support" systems at Copernicus Base on Luna and has since patented several design ideas which have been used in atmospheric processing plants in Paradise Station and the joint NASA/JAB Mars base at Chryse Planitia.

Equipment and Resources: As a small corporation Terra Nova relies heavily on the support of its employers at the various installations. Terra Nova has four OTV's and two armed delta's but has little access to heavy weapons or large scale orbital transport facilities.



Mitsubishi/Koridansu

Main Business: Orbital Design and Construction
Headquarters: Mitsubishi Torus—a privately owned micro-habitat containing approximately 500 occupants situated at L-5
Groundside Installations: Tokyo, Hong Kong.
Orbital Facilities: Four autofactories and eight manned workshacks.
Name and location of major shareholder: Wholly-owned subsidiary of Mitsubishi and Koryidansu corporations.
Total Employees: 14,000
Troops: 240
Covert: 35

Background: Mitsubishi/Koryidansu maintain intellectual property rights to the basic workshack module expanded upon by virtually all Japanese corporations developing and manufacturing orbital workshacks and autofactories. Mitsubishi/Koryidansu are still the largest manufacturers of small orbital facilities and gain royalties from the design patents on their original concepts. Their products are famous for reliability and spacers have a saying—if you have to live in a workshack "make it a Mitsubishi."

Equipment and Resources: Twenty three workshacks, eighteen autofactories, eleven armed deltas, thirty OTV's, fifteen other small orbital habitats and substantial orbital lift facilities and ground-based resources. Mitsubishi/Koryidansu can also call upon the

DEEP SPACE

LIVING & WORKING IN SPACE

massive combined resources of its two parent companies, making it one of the less desirable targets for any potential corporate takeover.

LIVING IN THE BELT

The Belt provides a promise of vast wealth for those foolhardy enough to risk its dangers. Although automated factories have already begun sucking some of the larger asteroids of their minerals, the real gains lie in a rare class of smaller asteroids which are particularly mineral rich. A single such silicate- or iron-rich asteroid can make its discoverer wealthy. Since many asteroids are conglomerations of earlier, smaller pieces, the actual lode-bearing component may be deep within the core, relatively hidden to the broad sweep performed by remote sensors and automated factories.

The few Highriders who have so far risked their lives and survived in the uncertain precincts of the tumbling asteroids are the hardest and most daring individuals. After hitching a ride with an exploration or corporate vessel they set out in their own deep space OTV with a hold full of supplies. Months later they may return empty-handed or be found frozen with the wreck of their craft by a later expedition. Several Belters have honeycombed living quarters out of a medium-sized asteroid and settled down to live there while waiting for a major find.

As well as risking the vagaries of the myriad huge tumbling members of the belt, they face another, man-made threat. The newer automated factories spawned by JAB and the large corporates are "Hunters," so called because they move between asteroids drilling into their cores. They look for deposits of particular materials and then move on to another if unsuccessful. These roving machines pay little attention to

Belters themselves and will happily core and begin mining an asteroid even if an unfortunate Belter has set up camp there. Considering the thousands of objects actually within the Belt the chance of an accident is currently remote, but as the number of factories and Belters increases the danger becomes steadily more real.

Even with these dangers the pull is still there and has been glamorized by the well-known story of "Mad" William Torso, who returned after two months in the Belt claiming he had found the "big one." Mad Will has since retired to Crystal Palace, where he lives permanently and earns a steady income advising others who intend to chance the Belt.



COLONIZING NEW WORLDS

For many the rigors of life in orbit and constant exposure to zero gee do not present an attractive picture, yet they do not wish to remain trapped among the decaying remains of Earth's civilizations. For them, the colonies on Luna and, more particularly, Mars provide the lure of freedom and a new life. The Martian colonies desperately require skilled technicians, doctors and scientists to aid the task of building a society on this harsh new world. Active advertising campaigns, particularly by ESA and NASA, present an idyllic view of life on Mars; they talk about air which is free of pollutants and a non-violent society where everyone is working together in a spirit of comradeship toward a common goal. Attractive packages are provided to highly skilled individuals to motivate them to sell their earthly belongings and undertake the arduous journey to Mars.

As a result the off-Earth colonies are expanding rapidly. In truth, however, conditions "off-world" are relatively basic. Both ESA and NASA maintain rigorous controls on the personnel who are allowed into the colonies, and each colony is managed by a strict colonial government reporting directly to its parent organizations. Furthermore, JAB, who manages over half of the population at the joint Chryse Planitia facility, has completely separated its portion of the community into a self-contained "micro-world" where the benefits of traditional Japanese culture and work ethics are placed above all other concerns. There is little place for individualists in these colonies and adherence to colony regulations is strictly enforced for the safety of all occupants.

The populations of the colonies are made up of approximately 40% workgangers, many recruited from orbit on the lure of better conditions



(which usually aren't really there); 35% colony managerial, scientific and security staff reporting directly to the individual colonies' management board; and 25% colonists who have taken individual contracts for employment and living space within the colony. These colonists do not directly work for the controlling body, such as ESA, but are on long-term (minimum five year) guaranteed contracts directly with the colonial management boards.

TERRAFORMING

Terraforming is a relatively new science which is concerned with the modification of entire planetary atmospheres and eco-systems to make

them suitable for human colonization. Of all of the planetary bodies in the solar system only two are positioned such that they could easily be modified to sustain human life. The others are either too small to maintain an atmosphere, have too large a gravity field, are far too hot or cold, or are bathed in waves of lethal radiation.

One of these bodies is Earth. Humanity is successfully modifying the atmospheric conditions and ecologies of Earth so that it becomes progressively LESS suitable for sustaining life.

The other is Mars. In the past, Mars has had a substantial atmosphere and water has abounded upon its

surface. Differing conditions in its development have led to its current state, a cold dry world with a thin atmosphere. This is potentially reversible. Water and many of the gases necessary for a substantive atmosphere remain locked in its polar ice caps and rocky surface. It is feasible that this potential atmosphere could be unlocked and, as the temperature rose, that much of the trapped water would flow again and Mars would once more see rivers flowing across its surface. Although currently a long-term dream, there are already several research projects, led by the Japanese Mars Research Laboratories, actively pursuing the redevelopment of a Martian atmosphere.



RED CONFLICT: A Space Adventure

The following scenario is designed to thrust the characters into the expanded world of Cyberpunk in 2025 and the Deep Space arena. Characters from an existing campaign can easily be integrated into this scenario. However, it is somewhat of a one-way ticket into Deep Space and it is not intended that characters return to groundside. At least, not quickly. You may wish to create new characters for this run; it could also be the basis for an entire space-based campaign, similar to the movies *Outland* or *Alien*.

It would be advisable if one character involved in the scenario has substantial Netrunning skills. At least one combat-trained individual should also be available.

PART ONE: GROUNDSIDE BLUES

It is 2025, somewhere. A favorite bar. A jail cell. Deep in the 'face. The characters are approached by a fixer with a small problem and a pile of euro to solve it.

If the characters are part of an existing campaign then replace the fixer described with someone who is familiar with the characters. The fixer has been contacted by an anonymous corporate and commissioned to find an infiltration team, fast. He is backed up by a competent solo who will provide the characters with some serious trouble if they decide to play rough.

The fixer is short, dark-skinned male who wears a cheap suit which attempts to masquerade as an expensive suit and fails badly. He introduces himself as Carlo Santos, addressing the characters in Street. The jumble of words rattle quickly in a guttural tone, underlined by a Mediterranean accent.

"I have been commissioned in rather a hurry to find an extraction team. I

can make an attractive offer if you are willing to accept the contract. The initial details are provided within this envelope. Obviously you should treat all information regarding this conversation, and the content of the envelope, as strictly confidential. I assure you that you will be under surveillance until after the operation is complete, whatever your answer."

Carlo hands the character(s) an envelope (or equivalent). It contains 4,000eb and a single sheet of opaque plastic inside a plain folder. The plastic sheet has printing on one side which reads:

Precis - target 209.

Minimum requirement:

4 personnel, includes 2 x combat specialist, 1 x technical. Medical skills and Netoperative also preferred.

Function:

Minimal exposure extraction of corporate personnel.

Target profile:

Male, Caucasian. Age 46 years. Non-combatant.

Equipment:

Team to provide own equipment including weapons and software. An AV-4 Tac will be provided with experienced pilot if necessary.

Compensation:

5,000eb per team member, 20% in advance. Own expenses payable by team members.

Notes:

Damage to spurious equipment and personnel is not required.

After two minutes the plastic sheet disintegrates quietly, literally falling apart without warning into a fine dust. If the characters enquire about the money contained in the envelope Carlo will reply.

"This is to ensure your silence."

Carlo is rather impatient. He requires an answer and will try to obtain one before he leaves. If the character(s)

Carlo Santos

ROLE: FIXER

INT 8, REF 7, COOL 8, MA 5, BODY 5, TECH 6, ATT 7, EMP 6

CYBERNETICS: One Cyberoptic with low-light and camera; One set of plugs (right wrist); Cyberaudio with radio splice, digital recorder and amplified hearing.

SKILLS: Streetdeal +5, Streetwise +6, Wardrobe & Style +2, Persuasion & Fast Talk +4, Human Perception +3, Seduction +2, Gamble +6, Handgun +2.

OUTFIT: Trauma Team™ card, Federated Arms X-22 one-shot.

July Keyes

ROLE: SOLO

INT 6, REF 9 (11), COOL 7, MA 6, BODY 6, TECH 3, ATT 6, EMP 3

CYBERNETICS: Two Cyberoptics, Left: with IR, Targeting scope and Anti-dazzle, Right: Dartgun and Anti-dazzle; One set of plugs (left wrist); Kerenzikov Booster (+2); Rippers.

SKILLS: Combat Sense +3, Handgun +5, Rifle +2, Melee +7, Brawling +5, Athletics +4, Wardrobe & Style +2, Shadow +5, Streetwise +2.

OUTFIT: Smart-chipped Federated Arms X-9mm Medium Autopistol.

COMMENTS: July is a nasty piece of business and is particularly unpleasant, and skilled, at hand-to-hand combat. She is extremely fond of using whatever dirty trick will give her the edge in a combat and is equally at home with an auto-pistol or a jagged broken bottle.

DEEP SPACE

RED CONFLICT

DAWN SECURITY FACILITY

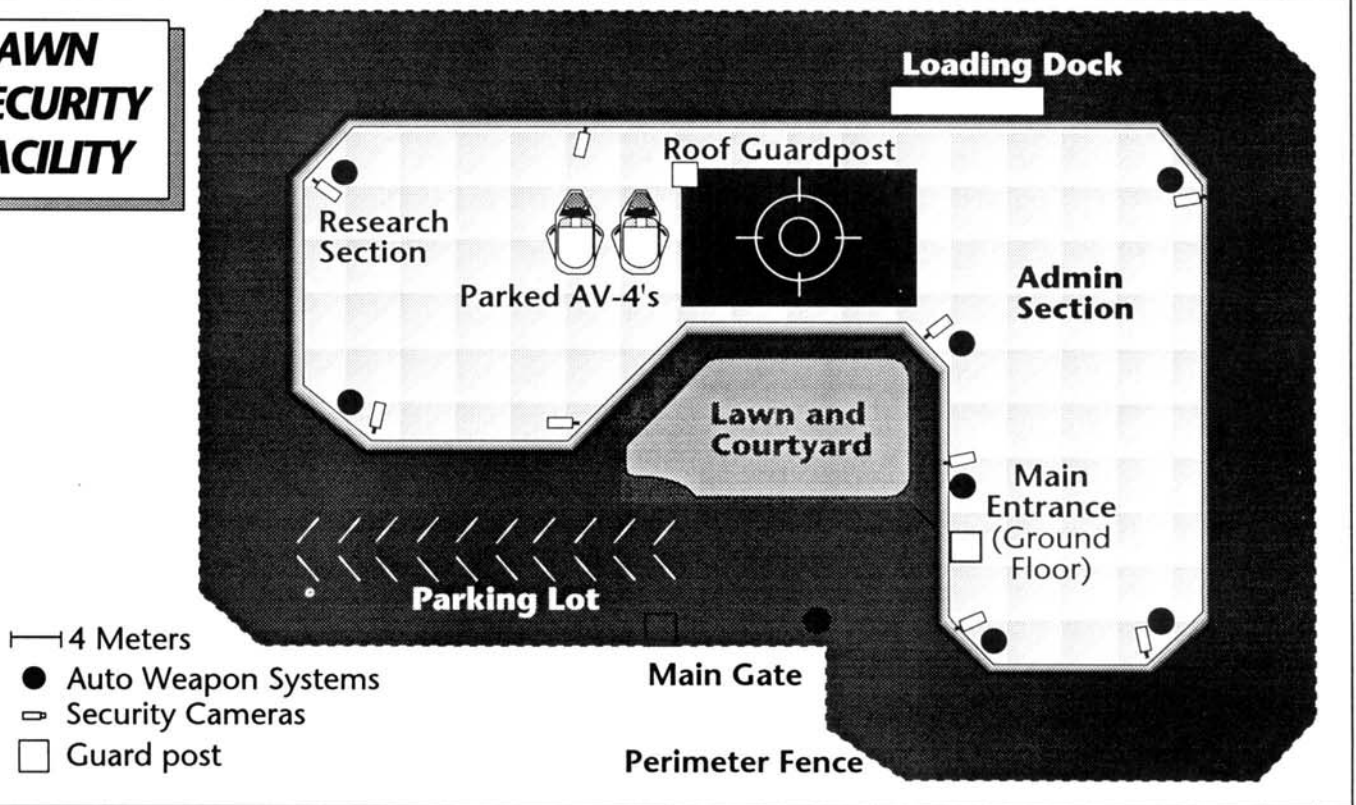

do not wish to accept the contract he will go elsewhere. Once the characters accept (of course they'll accept—eventually they will get bored with rolling new characters and having the same encounter!) Carlo hands one character a mini-cd which will fit any standard reader. He turns to leave, saying only:

"This matter is our little secret. You understand, yes?"

If the encounter occurs in a public place then any character making a MODERATE Awareness roll notices a woman across the room who appears to be watching the interchange. She catches Carlo's eye for moment, nods slightly and then disappears from sight.

If the characters follow either Carlo or July, they both leave in separate cars and are soon lost in City traffic. If they take any violent actions against Carlo then the woman, a solo named July

Keyes, will act to protect him and will not hesitate to open fire if necessary.

The mini-cd can be read by most equipment, including any Cyberdeck. It begins with a warning that the information contained within is confidential, etc, etc. It then imparts the following information:

The target for the extraction is a communications technician named Alexander Wilk, who is currently employed by a medium-sized electronics firm called Dawn Electronics. The company is relatively new and the characters are unlikely to have heard of it. A simple Net check reveals that Dawn has won several large contracts recently for the supply of advanced communications systems, and is growing rapidly. Suitable research will reveal its main competitors would be Smith Communications, Worldsat and IEC.

Although Dawn has a small office in the nearest major city, this is simply

a marketing front and cannot even provide useful Net access to internal systems. Dawn maintains a secure compound fifty kilometers north (unless that's in the ocean from your home town!) of the city which contains its R&D division. This is where Dr. Wilk works and, currently, lives.

Wilk has been contacted by your prospective employer and offered a position which, it seems, he has accepted. His current contract continues for four years and does not provide a polite clause for him to leave, particularly not to work for a competitor trading corporate secrets. Each evening he strolls around the grounds from 5.30pm to 5.45 pm to "take some air." In two days you are to provide a little more "air" than normal.

The AV-4 is to be collected from a private area near the Dawn facility and, after extracting Wilk from the compound, you are to deliver him to

DAWN NET MAP

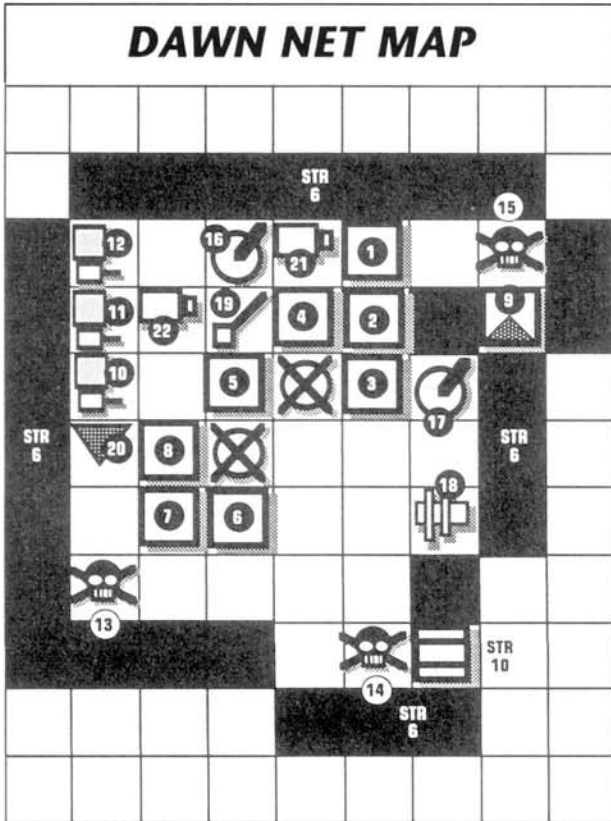

Thirdly, the characters' employers found out about the decoy and have planned a new operation to extract Wilk. However, they cannot afford not to continue with the original operation without arousing suspicion. Thus they have hired a crew of expendable independent operators to continue with the original plan as a ruse...

Enter the characters.

They may take whatever equipment they require with them on the strike. Dawn's complex has several weaknesses which the characters may attempt to exploit.

a third location. You will be met there by a representative from your employer and your vehicles, etc. will be waiting at the new location.

The CD provides a map of the Dawn compound, indicating major locations and defenses. It also details available Net access for the compound computer system, which is described in more detail below.

What the characters don't know is ...lots actually.

Firstly, Wilk isn't so much an engineer as a bio-engineer. He has developed a neat way of interfacing implanted communications equipment so that it can be used without any need to "sub-vocalize," and is virtually unnoticeable even when in use.

Secondly, Dawn found out about the extraction plan three days ago and has substituted a "decoy" Wilk to sabotage the attempt.

WEAKNESS 1

Although the computer system within the compound cannot be accessed directly through the Net, a high security Net access line is provided between the compound computer systems and the company's management, who are located in Tokyo. This line can only be accessed by either breaking into the headquarters computer system or physically tapping the phone company circuits. It is protected by several layers of software. The final defense is a Hydra Systems program known as "The Gates of Hell" (as described in the sidebar). The Dawn version currently has loaded Knockout, SeeYa and Watchdog.

The characters have been provided with the Net access code for the Dawn headquarters complex and the ID of the secure line.

Once within the compound computer it is possible to disrupt the

Gates of Hell

Class: Anti-Personnel (Carries 3 programs)

Strength: 5

MU: 4 + MU of contained programs

Gates of Hell is the equivalent of a Demon program for use AGAINST netrunners. It stores several Anti-Personnel and/or detection/alarm programs to prevent illegal entry into a system and provides the netrunner with a 'false' view of NetSpace to confuse and delay him. The stored programs all act at the strength of the Gates of Hell, i.e., 5. Unlike Demon series programs, the associated software isn't "packed" to save space, so there is no speed disadvantage. If the host Gates program is "killed", all carried programs are also de-rezzed immediately.

ICON: None, actually. The Gates of Hell looks like a standard section of the netgrid and creates false (Str 5) data walls which shift and change each time a runner tries to negotiate them. When a stored program is activated it seems to extrude out from a nearby wall to attack the runner, taking on its normal ICON.

DAWN NET KEY

- 1] Admin files
 - 2] Conference files
 - 3] Gates of Hell storage and System maintenance files
 - 4] Blueprints, Assembly instructions, Research files
 - 5] Blueprints, Assembly instructions, Research files
 - 6] Working Memory
 - 7] Gates of Hell storage
 - 8] Blueprints, Assembly instructions, Research files
 - 9] Long Distance Link to Tokyo HQ
 - 10] Workstation Group A
 - 11] Workstation Group B
 - 12] Workstation Group C
 - 13] Hydra
 - 14] Pitbull keyed to Sysop
 - 15] Pitbull keyed to Sysop
 - 16] Perimeter Alarms
 - 17] Interior Alarms
 - 18] Mini Auto-assembler for electronic components
 - 19] Main Gate
 - 20] Holo Display system for designers
 - 21] Cameras covering Lawn area
 - 22] Cameras covering research area
- USUALLY TWO SYSOPS ON DUTY AT ALL TIMES

Dawn Guards (8):

ROLE: SOLO

INT 4, REF 8 (9), COOL 5, TECH 4,
LUCK 5, ATT 4, MA 6, BODY 8, EMP 4.SKILLS: Combat Sense +3, Rifle +4,
Handgun +5, Submachinegun +4,
Athletics +3, Awareness +2, Stealth +1,
Melee +6CYBERNETICS: Plugs, Reflex Boost,
Optics with target/infra-red.PERSONALITY: "God, this job's a
drag."OUTFIT: Medium Armor Jacket, Light
Helmet, Federated Arms X-9mm
medium autopistol or H&K MPK-9
medium submachinegun. Two of the
guards have smart-chipped weapons.COMMENTS: Dawn is still a small
outfit and these guards are rather low
grade. Nevertheless, they are well
equipped and know the compound
layout well.

compound security system and feed false information to the security staff and automated defenses.

WEAKNESS 2

The compound normally accepts power from the public grid. Some subtle technical work, strategically placed explosives, or even infiltration of the power company computer (details left to the referee) will force the entire compound to switch to the reserve power supply. While this switch occurs instantly and without noticeable interruption, the weapon systems cannot draw sufficient power until three minutes have elapsed. During this period, the power for the rest of the complex is provided from storage units while the generators reach maximum output.

WEAKNESS 3

A careful analysis of the maps provided to the characters and a successful Difficult vs. Electronic Security roll indicates that the NE corner of the compound is slightly "blind." It will take security an extra 15 seconds to respond to an infiltration from this section of the perimeter. After all, every little bit helps.

The perimeter defenses themselves are quite strong and a purely ground-based infiltration is likely to fail. There is an average of eight guards on duty at any time and their statistics are summarized in the sidebar.

As usual at 5.30pm "Dr. Wilk" steps from the research block and strolls slowly into the open. He stares upwards, as if surveying the heavens for stars. This may appear to be a curious action given the usual layer of photosynthetic smog obscuring the evening sky; however, Wilk always does this. As with so many brilliant minds, he is a little eccentric.

As the characters act there is much noise and confusion. Depending on the success of any covert anti-security operations there will be alarms

going off, weapons targeting on the AV-4, and guards firing automatic weapons to create a rain of death as the characters land. Amidst this chaos Wilk looks confused, but he will drop to the ground once the level of fire threatens to endanger him. At this stage he will make no action to indicate that he is the "target"; it should be obvious.

The AV-4 can land quite close to Wilk's position. If the AV-4 doors are opened then Wilk will attempt to leap into the vehicle. As he does a guard rakes him with automatic fire, bullets ripping across his torso as he lands inside the vehicle. Wilk collapses unconscious inside the vehicle. If any character moves to aid him they will discover that he is still alive, as most of the damage was absorbed by a Kevlar vest hidden under his clothing. He is still badly wounded and bleeding profusely.

Attempting to leave the compound is still no easy task. Even if the weapon systems have been damaged/disabled by the characters in some form they will be fixed quickly. Two heavy weapons train in on the fleeing AV-4 while two armed Dawn AV-4's lift off in pursuit.

Under this blaze of fire the characters flee. They can easily find the rendezvous point, but—the location is deserted and neither the characters' vehicles, an expected pick-up van for Wilk, nor any supporting firepower is on hand. Also there is those two AV-4's to think about.

Meanwhile ... what did the characters do with "Wilk" in the back? This is actually a Solo known as "Insider" Ronson. If he has been under medical treatment then an Average roll vs. *Medical Tech* (or a Difficult roll if he has simply been under close surveillance), reveals that his condition has improved rapidly. Unknown to anyone, including his employers, Ronson had undergone a treatment

of Lifesaver Bodyweave (*Chromebook*, pg.38) which has saved his life, along with Nanosurgeons which have been rapidly repairing the internal damage. If the characters search the prone form they discover a smart-chipped Sternmeyer Type 35 Autopistol hidden in a shoulder holster under his clothing. If the pistol hasn't been removed then Ronson will wake and, after two minutes of disorientation, will attempt to overpower the characters and radio for help. Ronson also has a small knife strapped to his left leg and carries a tiny homing transmitter taped inside his right armpit.

If Ronson wakes to find his pistol and the transmitter gone and the characters asking some serious questions about his identity he will divulge what he knows to the characters in the hope that they will let him live. He has a reasonable idea of why he was hired but doesn't know where Wilk is. He was supposed to play at being Wilk as long as possible in an attempt to trace the instigators of the plot.

If the characters haven't removed the transmitter then they will be hounded by further goons until they lose Ronson. He will use any distractions as an opportunity to flee.

Assuming the characters survive the entire episode they are undoubtedly pretty pissed off. Noone likes being sent on a suicide mission.

Curiously, the money promised for payment arrives as advised with a brief note indicating that their contract has been successfully completed. Their vehicles and any other equipment which were left at the AV-4 pick-up point all remain there; it is otherwise deserted. If an AV-4 pilot was provided he also turns out to be a freelance operative and is just as annoyed by the whole deal as the characters. Along with the payment they can always attempt to sell the now slightly damaged AV-4 on the

open market or even decide to keep it. Of course, the owners may come looking!

Either way the characters should be grateful to be rid of that particular employer.

Perhaps ...

PART TWO: TICKET TO RIDE

The characters will no doubt be rather on edge when, several days later, they are contacted by the fixer (Carlo?) who offered them the Dawn contract.

Don't forget to substitute your "own" fixer if available.

"My friends. I can understand that you may harbor some ill feeling toward myself regarding your recent contract. I would like to apologize as I personally was unaware that your mission was to be a 'decoy'."

Carlo grimaces as he says the last words.

"It appears that your actions in overcoming the inherent difficulties in that mission have come to the notice of your recent employer. I have been asked to offer you a further contract. I am assured that this one is completely legitimate."

If the characters agree to consider the proposal Carlo hands them a video-cd and indicates they should meet him at the same location in two days to give an answer.

Once again the CD contains the information the characters require. However, the content of the message is surprising. Rather than simply containing "information" the video-cd provides a visual message. It is delivered by an elderly gentleman, clearly of French descent, seated behind a huge wooden desk. The location, and the identity of the

"Insider" Ronson (alias "Dr. Wilk")

ROLE: SOLO

INT 8, REF 10, COOL 9, MA 6, BODY 8, TECH 6, ATT 7

CYBERNETICS: One Cyberoptic with IR, Targeting scope, Image Enhancement and Anti-dazzle; two sets of Plugs (one each wrist); Kerenzikov Booster (+2); Lifesaver Bodyweave; Nanosurgeons

SKILLS: Combat Sense +5, Handgun +6, Rifle +4, Melee +6, Athletics +4, Wardrobe & Style +9, Stealth +4, Shadow +3, Streetwise +5.

OUTFIT: Smart-chipped Sternmeyer Type 35 Autopistol, sharp knife, boring outdated suit.

PERSONALITY: Motivation: Highly professional but will take inordinate risks for money; Competence: Very; Aggressiveness: Controlled but potentially highly violent.

COMMENTS: If Ronson thinks he has any chance to overpower the characters and collect his payment from Dawn he will take it. Otherwise he will happily rat everything he knows since Dawn almost killed him. He will even team up with the characters if they want to hit Dawn again. Just for kicks, you know.

speaker, are unknown. He speaks softly, staring earnestly in the direction of the device which recorded the speech and clears his throat several times during the delivery.

"Ladies and Gentlemen. Thank you for considering our offer of further employment. You may find what I have to say next a little daunting but, be assured, I am completely serious. You will be well rewarded for your full participation.

"I represent the council of a small city. This responsibility is, as you can imagine, a great one. Recently, we have been faced by a problem which we cannot easily resolve. Certain individuals have begun causing a significant civil disturbance in our normally peaceful city. Their motives are purely personal but they are remarkably persuasive and have recruited a number of supporters. We have tried, so far with little success, to negotiate with these individuals and when that failed, to use force to disperse them. Unfortunately we have been unsuccessful.

"We, the city council, feel that this disturbance can only be removed by individuals acting from inside their ranks. To this end we intend to recruit others who cannot be traced back to us. That is why we have called upon you.

"We will pay all necessary expenses for the period of your employment. Further, each active member of the team will be paid the sum of 300,000eb on successful completion of the contract. You will understand why in a few moments.

"The period of employment will be for a minimum of three years. The reason for this length is quite simple. Our city is on Mars. We wish you to come to Mars in our employ, posing as colonists, and infiltrate a fanatical group who are threatening the safety of the entire colony. While small

now, they may grow to be a strong threat in the future. We can guarantee passage, including a return flight to Earth if you wish, for all participants in this exercise. If you agree you will each be paid 50,000eb up front as a retainer. The remaining amount will be placed immediately in a private account in each individual's name, with the requirement that it cannot be withdrawn until three years have elapsed.

"My colleague will contact you further to ascertain your answer. The next scheduled Mars flight leaves within two months and places have already been reserved. I urge you to consider this offer carefully.

"Thank you for your time."

Are they stunned yet ?

This is supposed to be an offer too good to refuse. If the characters are already wealthy offer more money. They shouldn't be able to say no.

Carlo will contact them two days later to request an answer. Let us assume they say yes.

Moving to the "colonies" is rapidly becoming the new dream for the untold millions still trapped in the polluted and violent cities of Earth. However, the cost of transporting and maintaining each individual is still crippling and so a careful selection process is involved. Firstly potential applicants must possess skills which are considered useful in the maintenance and growth of their chosen colony. Arduous acceptance tests and health checks ensure that only "productive" personnel are given the opportunity to join. They must also have sufficient resources to be able to reach one of the many orbital platforms where they can begin a journey to their new home. This ensures that the vast majority of street scum never get close to having the opportunity.

Of course it is unlikely that the characters fit all (if any) of these criteria. They have been provided with sufficient funds in advance to take passage to orbit and their new employers (being in control of the colony anyway) have provided suitable examination results to cover the characters' relative lack of skills. To aid in adoption into the colony each character is provided with a new identity and several skill/memory chips to facilitate the charade. Characters should attempt to adopt a role which most closely matches the skills they already possess. Further, during the journey to Mars they have a large period of "consciousness" within the Dance and can use some of this time to learn INT or TECH based skills. Each character can obtain up to ten (10) points of skill during this period; however, they cannot increase any skill more than +4 in this way. They must have, or obtain during the journey, the minimums listed to successfully adopt any given role. Any character who does not have a processor installation should undergo installation before the journey.

Medias and Rockers could maintain their existing roles fairly intact, as there is as much use for entertainment and news dissemination facilities in the colonies as there is on Earth. However there is limited scope for any real "action" for such characters, as the potential audience for either of these roles is rather limited. It is also clear that the colony management would actively resist the type of "trouble-making" most Medias or Rockers are involved in.

Some sample roles are described below:

ORBITAL CONTROLLER (SOLO)

The volume of atmospheric and orbit-to-surface traffic on Mars is increasing exponentially and must be carefully managed to limit the risk of an accident. Although much of this

traffic is monitored and managed by AIs these artificial systems are often too inflexible in their approach, particularly when dealing with a crisis. The automatic systems still lack the intuitive reactions of a human operator which can often avert a disaster before the recursive analysis routines of an AI have recognized a problem. The native instinct in a highly trained solo and high reflexes makes you a perfect candidate for this position.

Character requires minimum of:
Awareness +6, Aero Tech +4
Skill chips: Mathematics +2, Pilot OTV +3

SCIENTIFIC TECHNICIAN (TECH)

No trouble, dude. They want you to help research new ways of applying technology to suit the environment on Mars. Mind you, you'll need a little more than basic Math and Physics to get by. You will be designing new tools for exploration, construction and environmental monitoring for use specifically on Mars. You will also be helping test and refine newer technologies such as nano-technology and cryotank storage.

Character requires minimums of:
Basic Tech +6, Mathematics +4
Skill chips: Physics +3, Cyber Tech +2, Cryotank Operation +2

PROGRAMMER (NETRUNNER)

Your task is to help construct new software for the efficient operation of the colony. This may include software for maintaining specific automated tasks, such as running an electric tube-subway, or for scientific analysis of information, such as geological or atmospheric surveys. You are also required to help construct virtuals for education and recreation with the aid of the colony's AIs.

Character requires minimums of:
Programming +6, Basic Tech +2
Skill chips: System Knowledge +3 (Mars specific), Language (Meta I) +2

SURVIVAL TUTOR (SOLO)

Although the societies within the colonies are relatively small and stable they will undoubtedly grow larger and crime and violence will creep into their fabric. The young children being born on Mars cannot be raised to be naive and defenseless against these factors, particularly since they may come from outside the colony as time passes. You are required to teach the younger members of the colony the basics of personal defense and survival skills so that they can face the future. Of course, projectile weapons are generally unavailable in the colony and this is not a skill the management wishes taught.

Character requires minimums of:
Athletics +2, any one Martial Arts skill +5
Skill chips: Teaching +3, Martian Survival +3

SUPPLY COORDINATOR (FIXER)

You are required to manage the central distribution of equipment, drugs and supplies for the colonists. This also involves submitting orders to the Colonial Board for new materials, equipment or personnel resources. You will of course be tightly constrained in your actions by the Colonial Board, which actually manages all direct import and export into and out of the colony. Still there is bound to be some scope for your real skills in all of this bureaucracy.

Character requires minimums of:
Accounting +4
Skill chips: Library Search +2

STAIRWAY TO HELL

Catching an interplanetary cruiser is still, even in 2025, a difficult and complex process. The huge latticework structures of the 'Space Liners' must be kept well clear of the effects of planetary gravitational fields or risk immense stresses. Furthermore, the

nuclear propulsion units used to travel such huge distances cannot be used where the highly energized stream of exhaust particles could inadvertently rake across an inhabited orbital facility—it could easily cook the occupants alive.

The first step has changed little since the early 2000's. The characters board a newly commissioned Aries III spaceplane, finding themselves inside a plushly decorated craft reminiscent of the Boeing 747's of the 90's. The spaceplane takes off horizontally like a normal aircraft and climbs almost continuously until it leaves the upper atmosphere and docks with Johnson Space Platform. There are only three points of real interest during the spaceplane flight.

After forty minutes of reasonably stiff acceleration you are feeling somewhat uncomfortable. By now you are also feeling rather hungry and wondering why you haven't had more than a light snack. Just about now you begin to feel a slight tickling sensation in your inner ear. Anyone who hasn't been into space before also feels a similar sensation in their stomach (make an Average roll vs. BODY or lose that snack).

Also about now you are warned by a brief announcement to brace for a small jolt. Having reached the limits of the upper atmosphere the crew activate the rocket engines which take over from the failing jet units and push the craft clear into low orbit.

Welcome to Zero Gravity.

The stewards have begun taking great care in their movements and you realize exactly why the carpet on the aisles looked more like velcro than wool blend.

You probably feel lousy, but the view is just great.

After a seemingly interminable period you dock at the Johnson Space Plat-

form and are led to the customs area. In the unfamiliar zero-G environment you bump painfully into walls, doors and other hapless travellers. You can tell the locals. They sped off up ahead several minutes ago, skimming off the walls like dolphins in water. You hang (literally) around for another thirty minutes until you pass through customs and are searched, metal-detected, X-rayed and put through any other form of impersonal security procedure which Interpol can devise to ensure that you are not carrying any illegal drugs or weapons.

You aren't, are you?

Johnson Space Platform is just that: a large, roughly rectangular flat scaffold which is used to transfer between spaceplanes and shuttles to and from Earth, and OTV's which are used to travel from here to one of the larger space habitats or the moon. Your eventual destination is a deep-space cruiser, NASA's Explorer II, which is 'parked' in a stable position well outside the Luna orbit. You will be rendezvousing with a second, NASA-owned, OTV at the ESA-maintained L-4 orbital facility, an immense O'Neill cylinder known generally as Paradise Station.

You are bundled into a DS-OTV. It is much more cramped than the spaceplane and has no windows; it hauls you and eighty others out to the Luna orbit and the waiting Paradise Station. The trip, which takes twenty three hours, is extremely dull and much of it is spent sleeping or connected to braindance entertainment units. You actually arrive before you know it. Would I lie to you?

As the OTV has no windows to speak of, your first view of Paradise is an antiseptic-smelling corridor leading toward the disembarkation lounge. Here, still in zero g, you are put through more tedious paperwork, this time by ESA staff. Finally you are

led into a large cylindrical room which is slowly spun to match the rotation of the cylinder. As you step into the elevator which takes you down one end wall of the torus, you are treated to your first view of the habitat. The elevator is glass and you are now suspended 3 miles (5 km) from the 'ground' stretched out below (and above, and all around) you and extending 15 miles (25 km) to the other end of the cylinder. Hope noone here gets vertigo. Make an Easy vs. COOL roll or start clutching the rail in terror.

As you descend the terrain features below can be seen clearly. Meandering roads, scattered forests, rivers and lakes course between scattered suburban areas and office complexes. Nothing could be more different from the cluttered nightmare you so recently left groundside. It is a simply awe inspiring sight.

Several minutes later, feeling decidedly more comfortable already as the gravity has returned to 0.9 G at the cylinder floor, you are deposited at the base of the wall. A bank of information displays provide directions to most major locations within the cylinder and small electric shuttles stand waiting for passengers.

The characters now have two days to recuperate from the outward flight and the space version of 'jet-lag'. Since their accommodation is pre-paid and they each have (had) 10,000eb dumped in their accounts, they are quite comfortable. However, unlike Crystal Palace, Paradise Station is not an exotic playground for the rich. Rather, it is a fully operational living, self sustaining micro-world with a population of 150,000 semi-permanent residents. It still provides four-star accommodation, restaurants, casinos, bars, strip joints and most other forms of entertainment and relaxation. There is also plenty of room for "outdoor" pastimes such as tennis or cycling.

The characters should begin to realize after a short while that the entire place seems somewhat deserted. The world was originally constructed to contain several times its current population. ESA's increasingly dictatorial control of living standards, particularly for Workgangers, eventually sparked the famous O'Neill war. The ESA has retained control of this artificial world and most 'gangers fled for one of the other independent orbitals when they realized they were losing this particular battle. The 'gangers now call this world Hell.

Most of those who will be travelling onward to Mars on the NASA flight are stopping over at Paradise Station briefly before continuing on to rendezvous with the ship. Some, particularly the families, retreat to private rooms to spend their last time together before the journey. Many others, including some late additions to the crew and technical staff for the colony, take the opportunity for a final fling. The bars and casinos at Paradise gear up specifically for the brief burst of activity brought on by each new Mars flight. Not only the passengers themselves but friends, colleagues and even curious onlookers often gather together before such an event.

On the day the characters are to depart for the deep-space ship itself, a large "open-air" rock concert has been arranged. The lead band, a new orbital-based group called *Platinum Wave*, has had several medium hits with their mixture of chromatic rock and workshack blues. They are fronted by the popular groundside trio of Lazo, Sumi & Tenko, whose modernistic synthetic compositions invoke images of ancient Japanese culture.

In fact, Platinum Wave are becoming just a little too successful. Their latest hit, *Breathe Vac*, contains some pointed truths about the activities of several large orbital corps. One of

these corporations has decided to silence their voice before the band gains too much popularity to easily dismiss. In an empty office block almost a kilometer from the concert a sniper has been placed with a tripod-mounted Scorpion missile launcher equipped with a modified laser-guided missile. There are two armed solos in the crowd who have been briefed to terminate the band's leader if the sniper fails.

The characters would be foolish to miss the event. If they don't attend, then they simply hear about the assassination of the band's leader in the news on the following morning. If they are early for the gig then any character succeeding a Difficult roll vs. Awareness notices several security guards checking out the stage thoroughly and surveying the crowd as it begins to build. The guards all look extremely edgy, as if they are expecting some kind of trouble.

A large crowd well in excess of 3,000 people gathers for the event. The mood is rather more peaceful than the characters expect at a rock concert and is substantially different from the howling raucous confusion which surrounds the violent mobs at most groundside venues. Indeed, as Lazo steps onto the stage and begins crooning his opening chant, the crowd falls silent, mesmerised by the music. The opening set is a hit and the trio leave to rousing applause.

After a pause the band members from Platinum Wave filter onto the stage and quickly set up their equipment. As the crowd's expectation increases Janet Maul, lead singer and songwriter for Platinum Wave, struts onto the stage. Never one for subtlety, Janet begins belting the opening lyrics of her hit song, *Recycled and Raw*, even before she reaches the center. As usual, Janet is naked, but her body is clothed in streaming colors generated by her

synth-skin, which oscillates between garish swirling patterns and a video image of the band which also covers the entire backdrop of the stage. The music beats on and the crowd is clearly enjoying the show.

At this point the characters have a second chance at a roll. If a character succeeds a Very Difficult roll vs Awareness they notice a large goon nearby who appears to have a weapon chipped into his wrist sockets. A closer inspection and another Very Difficult roll vs Awareness and they identify the outline of a Federated Arms X-9mm pistol secreted under his clothes. The gun is decidedly out of place in an environment were even the Interpol police generally carry flechettes. If any character confronts the goon he will bolt into the crowd and attempt to flee the scene. If the characters pursue the figure, once clear of the crowd he will turn on his pursuers and draw a monoknife, but will resist engaging them in a melee. He snarls at the nearest character and calls out,

"Leave off, fool. This thing is bigger than you know and you won't get much help from the local police."

He will then attempt to flee the characters again. If they continue pursuit he will turn to fight and this time will kick in his Speedware for full effect.

Some distance away the sniper is already locking a laser sight onto Janet's weaving body. The task is complicated by the synth-skin patterns which tend to confuse the sight; however, it will take only a few minutes for the sniper to readjust the weapon and achieve a good aim. During this time any character who has cyberoptics with infrared has the chance to make a Difficult roll vs Awareness (AVERAGE for a solo) to notice the laser sight signature amongst the other swirling patterns on Janet's body. There is certainly

Goons 1, 2, and 3

ROLE: SOLO

INT 5, REF 9 (12), COOL 7, MA 4, BODY 9, TECH 3, ATT 4

CYBERNETICS: One Cyberoptic with IR, Targeting scope, Image Enhancement and Anti-dazzle; two sets of Plugs (one each wrist); Sandevistan Booster (+3);

SKILLS: Combat Sense +4, Handgun +4, Rifle +2, Melee +4, Heavy Weapons +2, Athletics +3, Stealth +4, Shadow +3.

OUTFIT: Smart-chipped Federated Arms X-9mm Autopistol, Kendachi monoknife, bad attitude.

not sufficient time to reach the sniper and attempt to disable him, even if the characters had a means of doing so. The characters are well back in a crowd of 3,000 people who are rocking hard to 65 decibels of pure noise. Gaining anyone's attention is a little hard right now.

If the characters contact the local authorities via phone link they are greeted by the usual:

"Oh, so you think someone is about to be killed. Right. A sniper you say. Can you give me a description of the assailant. Hair and eye color perhaps. No. Right. Can you give me the address of this sniper's current location. No. Right. Who did you say the victim was, a rock singer. Sorry, can you repeat that. Sorry, can you turn the radio down a bit, I really can't hear you very well."

Before they can get a useful response from this direction the sniper will strike.

Two courses of action which will be effective are :

1) Phone the concert organizer direct and tell them their band is about to get aced.

2) Cause enough of a disruption, like a small brawl, in the crowd to worry the already nervous band guards.

In either case above the guards will throw the lights and pull the band off. Even before they can broadcast an apology for this "short interruption," the stage explodes into a fireball as the sniper, reacting to the sudden and unexpected turn of events, attempts to catch the fleeing band. Several hundred members of the audience are injured by the explosion from the hastily fired missile. Janet and the band, however, manage to escape with only minor injuries.

If the characters fail to warn the guards, then the sniper attack catches

the entire band in a massive fireball which rips through the stage and rains fire upon the front rows of the crowd. Janet's shattered corpse is blown directly out into the crowd as people scatter in panic.

All those leaving for Mars, including the characters, are left with a final searing memory of the pointless violence rampant within both groundside and orbital societies. By now they should really be ready to leave.

ROCKIN' ON

Two days after arriving at L-4 the characters must pack again and return to the cramped confines of space, this time via a NASA-owned DS-OTV. They can gain one last wistful view of the cylinder as they ascend the elevator and weightlessness returns to plague them, before the doors close behind them. The SS-Roosevelt is an older model than the ESA transport and has a very basic interior. The security on this leg of the journey is even more severe than the earlier portion, mostly due to NASA's well founded fear of sabotage of their all-too-successful Mars program. Unless the characters can make an Average vs. BODY roll they find themselves ill again due to the effects of weightlessness. They may well be regretting any partying they have done in the last few days at Paradise Station. Another long eighteen hours passes before they dock with the first operational Mars-Earth Cypher, the DSS-Explorer II, and the pride of NASA's deep-space fleet.

After passing a final security check the characters, as part of over five hundred oddly assorted personnel, are led to an "introduction seminar" by an attractive American woman, who says little during the journey. The characters gain their first chance to view the craft as they are led forward, passing through several tunnels with large windowed sections affording an amazing view. The Ex-

plorer is a major feat of engineering. The characters have docked somewhere near the center of a large lattice of gleaming girders three miles long and over a mile wide. At the 'rear' of the lattice lie the two huge nuclear engines which provide the continual thrust required to reach Mars within a reasonable period. These are surrounded by a cluster of cylindrical fuel pods containing the nuclear fuel, in the form of measured pellets, which is used during the journey. At the 'front' of the lattice rears the impact shield, a thick polymer barrier designed to reduce the energy of small particles which may collide with the major axis of the ship during travel. Scattered through the remainder of the ship are a multitude of oddly shaped modules, as well as OTV's and landing craft for personnel and cargo transport. The ship's three 'gravity wheels' can also be seen, located in separate sections of the lattice. These provide a gravity environment for active crew, insuring that muscles do not atrophy during the long journey.

Eventually the group reaches one of the gravity wheels and are soon seated in a comfortable common room at 0.8G. After ensuring everyone has arrived and is seated comfortably, their guide proceeds to the front of the room. She speaks loudly and clearly, obviously delivering a well rehearsed presentation.

"Welcome to you all. My name is Julie and I will be your crew liaison during the waking periods of the voyage. If you have any problems or questions please don't hesitate to ask. This will also be my first voyage on the Explorer; however, I already know the ship's facilities quite well, as I have been living here for the last two months in readiness for this voyage.

"As well as the necessary crew we will be transporting 250 passengers including yourselves. Most of these

passengers will remain upon Mars, many taking residence at the joint U.S. and Japanese facility at Chryse Planitia. I would like to extend an early welcome to all of you who will be joining us at Chryse. We look forward to your membership in a thriving colony.

The remaining passenger complement consists of a number of scientists and, I believe, even some 'tourists' who will be making a return trip to Earth. There are also a significant number of colonists who will be joining the joint Euro/Sov colony at Isidis Planitia. We at NASA extend our best wishes for your journey and future success with our cousins at the Isidis base. "

Julie pauses briefly, as if to catch her breath. Any character making an Average roll vs. Awareness or Human Perception realizes she is also carefully checking the reactions of members of the audience to her spiel. It is not clear what she is hoping to find.

"Shortly you will be directed to enter the sleep compartments for the duration of the voyage. I can assure you these are quite safe. Not only have they been used without incident on several proceeding flights but most of the crew, including myself, will be using them during some portion of the journey. You may find the process slightly uncomfortable the first time but be assured it is completely safe. You will also be connected into the interactive entertainment system before the chamber is activated and you may use this to request aid at any time if you have a problem."

Several of the passengers around you exhibit the still red scars of recent socket implants. Now you understand why - the ship has insufficient resources to maintain a passenger complement of this size conscious for the entire journey. Instead the passengers, and portions of the crew, are placed into low tempera-

ture chambers which effectively removes the need for regular exercise and greatly reduces intake of nutrients. To keep the occupants sane during this long period of inactivity they are connected directly into the 'dance, an interactive computer simulation which provides neural signals to replace lost sensory input. From the 'dance you can experience blockbuster 'sims first hand, actually being the hero/heroine of the latest Hollywood creation. You can also browse the ship's library, something recommended for all colonists as a method of becoming familiar with the peculiarities of their new planet before they make a fatal mistake. You can even have conferences with your colleagues, though they aren't guaranteed to be private.

Around the characters the other colonists within this group begin saying their final farewells before entering the simulation. Young couples, escaping from the torrid muck of groundside existence, whisper quietly to one another while families make their shared goodbyes. Amongst all of this honest emotion the characters may begin to feel rather out of place.

Soon enough the characters are led to their individual sleepers. These prove to be daunting looking coffin shaped devices cluttered with an array of evil looking wires and tubes. In a rather impersonal, and only vaguely private, process each passenger must strip and lie prone in their chamber. Connection of the various waste tubes, nutrient feeds and interface sockets is almost impossible, usually requiring the somewhat embarrassing help of a steward/ess to help make the final connections. Once the 'face is connected the character quickly loses consciousness of the outside world, becoming absorbed in the artificially generated reality of the 'dance instead. The cover lowers slowly as a mixture of nutrients and nano-surgeons are

pumped into the prone form, and the temperature within the chamber drops.

Within minutes the characters are "iced."

DANCE THE LIGHT

Bright lights swirl before your eyes, their colors and brightness so dazzling it hurts. Yet, when you raise your arm to shield against the glare, it has no effect. Indeed, you realize with surprise, you appear to have no arm! Before you can begin to worry the lights dim, and the swirling slows to reveal a scene. You are seated in a room you have never seen before. It is remarkably well furnished and appears to be an ancient study. Shelves line the walls covered with all manner of books, videos and disks. Across a large desk sits a young man/woman (insert appropriate opposite sex) who is extremely attractive. He/she greets you in a sensual voice.

"Hello. I am your guide through the library. You may browse for information, select a new 'sim or simply relax. If you wish to contact another passenger I can relay a message to him. That door there (pointing to a large wooden door to one side of the room) leads to your audience lounge. From there you may easily address others. You may also request a shared 'sim for as many participants as you wish. Information about open group 'sims will be posted on the noteboard here, behind the desk, as they are instigated. You may initiate one of these yourself if you wish.

"Feel free to take your time."

The "library" is truly immense, carrying vast amounts of knowledge on almost every topic. Simply by asking the "librarian" the character can be provided with lists of books, movies, 'sims and interactive games which are all duplicated within the massive memory systems on board the Explorer. The ship's advanced AI's can manage these detailed simulations

Gaming Highlights

Wizards' Duel has become so popular that professional competitions have nearly achieved the status of the chess championships of the twentieth century. The Guinness Book of Records has two entries regarding the game:

Longest Recorded Game:

Between Harimaki Nughu and Tong Ghiyan, which lasted for 93 hours before the tournament was cancelled by officials. Both opponents began with the famous Jacob's Block maneuver, in which they each chose inert objects. Neither player was willing to break the impasse they had created.

Shortest Recorded Game:

Jonathon Shelly was disqualified in the French tournament in 2021 after his unfair behavior in the third round. During the first two seconds of the game Jonathon converted into a large land-mine and exploded, defeating his opponent. This tactic was considered to have broken an unspoken tenet of the game that participants should allow their opponents at least five seconds at the beginning of each session to orient themselves. This requirement has since been officially included in the Midden rule set.

for the entire passenger complement and crew with only a portion of their awareness, while still helping to run most of the ship's vital functions, plotting required course variations (usually due to magnetic disturbances) and performing scientific analysis for the active scientific team engaged during the flight.

The 'sim library is the modern day equivalent of the ancient "video libraries" which were common in the early 90's. In the 'sim you actually become a part of the story, with titles ranging from comedy, action, adventure and (of course) sex. With entertainment like this, time almost ceases to exist. Feel free to go to the wall here.

There are also well over a hundred other "sleepers" on the ship who can communicate and interact with the characters during the journey. Many of these are simply legitimate scientists, engineers, teachers or other skilled personnel and associated members of families. Others are higher ranking officials for NASA and JAB, while members of the ship's crew also spend some of the period iced. Some individuals of particular note are described below. Feel free to add as much detail as you like into encounters during this period.

THE VIDEO KID

During the voyage one or more characters will be challenged by this little nuisance to a game of "Wizards' Duel," an astonishingly popular game played entirely within the sim. The game is an electronic adaptation of a fantasy battle between wizards—each player "changes" into different objects or creatures in an attempt to "destroy" his opponent—and is enormously complex with millions of computer generated rules controlling the game play. The Kid has wasted many hours playing the game and is quite an expert. He is also a fourteen year old punk who just loves showing up these pathetic oldies.

If a character refuses the challenge, the Kid will heckle and jeer and periodically "drop by" to see if the character has changed his mind. He is a complete nuisance.

If you accept then you are in for a serious challenge. The Kid obtains a +2 bonus on his Brainsdance skill rolls when playing Wizards' Duel due to his familiarity with this particular game. He also has lots of nasty tricks up his sleeve.

If any character defeats the Kid then he will be suitably impressed. Thomas is the son of Alexis Short, a geologist who will be taking a position at the Isidis colony with his wife (Maria) and children (Stuart, Thomas and Anna). Thomas can provide an inroad to meeting his parents, who are extremely serious about their move and very interested in meeting other colonists who will be joining them at Isidis.

RUNNING HARD

As the journey progresses, the Netrunner character(s?) in the group will begin to hear rumours that one of the iced passengers on this ship has successfully "hacked" the ship's computers. They are unable to discover further details. However, they do ascertain that one passenger has also proven particularly adept at the 'dance simulations and competitions.

In fact, one of the passengers has found a loophole in the 'sim. She is a Netrunner named Sherie Phils who is moving to NASA's Chryse as a legitimate colonist, with much of her initial funding being provided by Highriders sympathetic to the cause of the rebellious colonists on Mars. Sherie will be a key player in the coming rebellion, as the colonists know they must disrupt computer services to the colony if any takeover bid is to succeed.

Sherie has discovered a "back door" in the simulation which allows ac-

cess to information on the other passengers, their backgrounds and skills. Sherie is specifically looking for someone who might be being brought in by the colony "government" to help stop the rebellion. (Someone like the characters.)

It isn't too hard to trace Sherie and discover that she is quite adept at 'sim competitions. Sherie is fairly curt and businesslike to most of the other passengers and will deny any Netrunning experience. She will be employed as a computer programmer at NASA and she has a valid background as a commercial programmer to explain her experience with the Interface.

If the characters watch her closely they may also be able to discover the "back door" exit to the 'sim. Both Sherie and the characters have well constructed fake backgrounds stored in the ship's computers and will learn nothing from these records.

COUNTERPLOY

Also in cold sleep heading for Isidis along with the characters are two solos who have been hired by the colonists to help them win the revolt. Like the characters, they have fake backgrounds but will be attempting to learn cover skills to "fit in" to new roles in the colony.

If the characters make a concerted effort to interview the other passengers during the voyage, particularly those heading for Isidis, then they have a chance to become suspicious of these solos even before they arrive. Any character attempting this type of activity must succeed in a DIFFICULT roll vs Human Perception for each passenger they are questioning. A successful roll allows them to identify that a particular passenger is (or isn't) legitimate.

DARK MOMENTS

Sometime during the journey - the characters have no real sense of when, although it can be considered

to occur near the "middle"—the characters find themselves drawn into a 'sim which is completely outside their control. This happens gradually, so that the characters don't realize their environment is being manipulated until they are already immersed in the new 'sim. Try to merge the following sequence smoothly into previous events. During this sequence the characters are completely isolated from each other and cannot communicate outside the 'sim. They are completely cut off from the outside world.

"You are walking. Slowly. The only sound you can hear is your own breathing, oddly muffled. As you look around you realize you are walking upon a huge plain, a desolate waste of sand and rock which extends off in every direction. You are alone."

The characters can now begin to interact with the 'sim. Each is wearing an advanced design of space suit which is equipped with an interface activated radio which any character can learn to use by making an Average roll vs. INT. The suit also provides biomonitors and atmospheric details via interface, although the characters cannot understand most of the data.

What the characters cannot find a way to do is exit the simulation—they must play it through to completion. If any character takes a foolish action such as unsealing the helmet, which requires both a Difficult roll vs. INT to discover the mechanism and a Difficult roll vs. REF to actually undo it, he suffers through the extremely unpleasant process of asphyxiating messily in the rarefied atmosphere of Mars. The computer provides an excellent simulation of his death until he blacks out in agony. That character is rendered unconscious for the remainder of this simulation and will suffer recurring nightmares for 1D6+2

The Video Kid (Thomas Short)

ROLE: PUNK
INT 8, REF 8, COOL 4, MA 3,
BODY 4, ATT 7, TECH 4,
EMP 5

SKILLS: Brainsdance +4
CYBERNETICS: Chipware
Socket and Processor.

COMMENT: Thomas is a bright lad who is just asking to get his teeth kicked in.

months. This causes a reduction of 1D3 + 1 REF for the same period.

A few minutes pass during which the characters can attempt to sort out what is happening, possibly make futile attempts to call for help, and hopefully realize that they are in a simulation of Mars. Then:

"You begin to notice a slight change in the quality of light in your surroundings. At first you cannot find any cause but after a moment you notice a darkening upon the horizon behind you. As you watch a thin band of dark brown begins crawling slowly above the horizon."

Oh dear. Not only is each character stuck in a simulation of Mars but there seems to be a Martian dust storm heading his way. With winds of several hundred meters per second carrying rocks the size of a human fist, this is not something to treat lightly. Yes, it is definitely heading his way. Fast.

A quick survey of the surrounding area will reveal that there are no land features, crevasses or even large rocks which the group could shelter behind. However, anyone making an Average roll vs. AWARENESS eventually spots a small bright spot toward the opposite horizon. This may, perhaps, provide some form of shelter. With the Martian surface gravity roughly 0.4G the characters find themselves bounding along in great leaps if they aren't careful. A successful Average roll vs. REF is required to avoid taking bruises from a hard fall. There is no danger that the helmets will crack or the suits puncture—this is a 'sim after all.

"You begin moving quickly toward the small spot on the horizon. Although it seems to become nearer surprisingly quickly, the thin band on the horizon has become a raging wall of fury rushing down upon you from behind. You had better find

shelter quickly. Ahead, the bright reflection begins to clarify into a regular structure. Soon it is clear that you have found a settlement; the large pressure domes bear testament to potential shelter, if only you can reach it in time."

Draw this out enough to build some real tension.

"Exhausted, your lungs almost bursting from exertion, you stumble the last meters toward a clearly defined airlock. To your relief the lights on the external access panel appear active and, indeed, a figure can be seen staring out through several feet of clear material which appears to form a viewport in this section of the dome."

About now someone should be expecting the airlock to crack open so that they can stumble to safety. It doesn't. Indeed, even activating the external access device has no effect. The figure inside is a male in his early forties. He watches the characters coldly, making no move to respond to any gestures or their attempts to open the lock. Their suit radios, except for their own cries of exasperation, remain silent.

"Behind you, the full fury of the storm can be seen. The wall of dust stretches beyond sight in each direction, towering several kilometers above you. Already the wind is picking up in your location, beginning to cause small eddies in the sand at your feet. Soon you are buffeted by gusts growing stronger every second and Martian dust rasps across your visor like sandpaper. The door refuses to budge and no response comes to your embattled pleas. No other form of shelter can be seen. Then the storm is upon you. You are quickly buried beneath tons of dust as it swirls down over the colony. You struggle but you cannot release yourself. Suddenly you find yourself gasping for air, unsure whether the

suit has malfunctioned or the supply is simply low. You realise you cannot find any indication of a problem. You begin to gag for lack of oxygen as the weight of the dust presses over you. Somewhere nearby a child screams."

At this point the characters black out in agony. An indeterminate period later they find themselves continuing where they left off in their previous entertainment, as if nothing had occurred. Attempts to question the system about what has happened provoke only puzzled questions. There has been no interruption to normal programming. The characters are mistaken. If anything had occurred the ship's systems would have reacted immediately to rectify the problem.

If the characters ask around they will discover that many other passengers experienced the strange sequence. If anyone bothers to cross-check they discover that only those passengers headed for Isidis were affected. None of the other passengers or crew noticed anything strange.

The 'dance continues as before and there are no further interruptions. Seemingly rather soon the characters are interrupted by the "librarian" system advising them that they will be brought back to being fully awake shortly.

They have arrived.

RISE AND MOAN

The reawakening process is actually quite painful, as muscles which have lain dormant for many months are forced to provide tension again. As the temperature is slowly raised and the nano-soup mixture being pumped into their blood is replaced by a new set of nano-surgeons to aid the reversal of cooling, the characters suffer severe muscle spasms and an agonizing case of "pins and

needles" in their limbs. Initially the chambers' restraints ensure they do not disconnect vital connections, and they must simply endure the pain. Soon, however, they have reached normal temperature again (actually they still feel freezing and are shivering with vestiges of cold) and are released to massage limbs and allow their eyes to accustom to light. Characters with cyber eyes have a distinct advantage as these components have been relatively unaffected by the cooling process.

Remember that cyber-limbs have been disconnected and need to be reactivated by a suitably skilled cyber-tech. Someone will get around to them, eventually.

Pallid, naked, and floating oddly in zero-G, the characters can wash (a damp sponge is provided) and dress. After a substantial delay a steward drifts past, requesting that all passengers follow him to the debriefing area. Entering the 0.8G environment of the gravity wheel now feels oppressive, as long unused muscles buckle under the renewed strain. As they enter the wheel each passenger is handed a small carrying tray which contains a flask of warm, evil smelling fluid and a dry brown biscuit. They are advised that, "These'll help get ya system workin' again." by a large Black male who appears to find something funny about the entire situation. At the front of the room their original guide, Julie, looks refreshed and comfortable. She has obviously been awake for some time in preparation for this portion of the voyage.

"Welcome again to you all. The DSS Explorer II, and all of us, are now parked in a holding orbit around Mars. After this session you will have a short wait as we begin to deliver passengers to the planet's surface. Fortunately, Mars' smaller size and lower gravity allow us to bring Explorer much closer than to Earth

and the landing vehicles will travel directly from Explorer to groundside.

"During the waiting period you will find that an excellent view of Mars can be gained from the observation port adjacent to this gravity wheel. Once you reach the surface we advise you to listen closely to all information regarding your new home. The Martian environment is still extremely hostile to humans and many rules and regulations exist for the safety of yourselves, and the others within your habitat.

"Have a nice day."

Each passenger is provided with an information pack which contains maps, information, regulations, survival hints, more regulations, and a variety of forms which must be completed for processing by the colonies systems. The characters may realize, if they succeed on an Average roll vs. Awareness, that the packs provided to those heading for Isidis Base, clearly marked with the ESA logo, seem rather thicker and more cumbersome than those for Chryse. That's good, old fashioned, European bureaucracy for you.

If the characters choose to make their way to the observation deck they are in for a treat. While the radiation shutters are partially closed to keep out the direct sunlight, the spectacle before them is truly awesome. Mars looms brightly in the distance, a glowing orb of ruddy red-brown suspended against the stark, speckled backdrop of space. Many of the colonists have come up here to obtain a first view of their new planet, most standing silently as they survey its details closely for the first time.

There is little else to do until the ESA landing vehicle arrives to ferry passengers to Isidis. A further delay is introduced as a number of ESA officials and special "guests" are trans-

ported by the first ESA craft to arrive, leaving the potential colonists to wait for a subsequent vehicle. The characters are some of the last to be ushered to the docking area where, once more in zero-G, they are packed into a Mars lander. This vehicle is similar to an OTV but is capable of landing directly on the Martian surface due to the highly rarefied atmosphere.

PART THREE: HOME SWEET HOME

The journey from orbit to the surface of Mars takes only seven hours, relatively rapid after the intervening periods, and the craft lands rather solidly. The lander docks directly with Isidis Base via a flexible docking module and the characters are ushered out into a waiting area. The lighter Martian gravity is rather uncomfortable and characters find themselves tripping over their own feet. Anyone failing an Average roll vs. REF finds himself sprawled face down on the ground. The docking area is connected to the main complex via an underground subway, through which runs a small electric train which can carry approximately fifty passengers. After a short wait the characters are treated to a smooth journey into the heart of Isidis Base, the administration wing. Here they are herded like sheep into a large open area for processing. Forms, scanners, inane questions, and more forms ad nauseum await the hapless colonist who might wish to start a new life at Isidis. Eventually the group is welcomed by the Mayor of Isidis colony.

Another boring welcoming speech is to follow. However, it is likely that the newcomers won't hear much of what is being said. Each character clearly recognizes the charismatic gentleman now presented on the enormous view screen situated on the far wall. While they have never met the Mayor of Isidis, he is all too

familiar. This is the face from their nightmarish excursion in the 'dance during the trip; the face of the man who watched the storm engulf them without lifting a finger to aid them.

But after all, it was only a 'sim and, no doubt, some form of malfunction at that.

The ESA staff and temporary visitors are being processed somewhere else, leaving the characters in a group of 325 new colonists who have travelled to Isidis to live. The colonists have all been accepted into the Isidis Base Colonization Program by virtue of their possessing skills which were considered useful to the operations of the colony. Each colonist, male or female, has been assigned a position within the colony structure. Children are enrolled in mandatory educational classes until age eighteen, after which they can either join the colony's workforce or opt for further rigorous education. All members of the colony are encouraged to undertake continual training to improve the overall skill levels of all participants. In a small colony such as Isidis there is no room for those who would wish to be carried by the system.

GATHER 'ROUND

Once the official welcomes are over, the characters and the other new colonists are led off to find their accommodations and become familiar with their new home. Each new colonist (or family) is shown around briefly by a more experienced colonist. After a brief tour which takes them to their living quarters they are led to another large area where, they are advised, there are regular meetings of the colonists' unofficial "colonial council" which has been voted by the colonists to represent their needs to the Isidis Base Management Board. These meetings are held every two months and are known as the "gatherings."

To help introduce the new colonists to life at Isidis the latest gathering

has been set for the day of their arrival. They are warmly greeted by fellow colonists and provided with a buffet of refreshments, the first real food the characters have eaten in a long time. The gatherings are usually chaired by Dr. Sergei Lerpovsky, the colony's head medic, who speaks clearly despite a pronounced Russian accent. He gives a rousing welcoming speech for the new arrivals and then spends twenty minutes discussing more mundane matters: costs of improved educational facilities for children, concerns over seals in Residential Module II, and so on.

By now the characters are probably asleep. Eventually the new colonists are able to retire for some well earned rest in their new beds. The characters no doubt now understand why the gatherings generally get such small turnouts.

SETTLING IN

From here the characters are essentially on their own. They have been provided with a security code and password for the one of the colony's three main computers, which will provide access into a secure area where they can leave and receive messages from their employer. Until their first briefing, however, they will obtain no response to messages left here. Each character has been provided with a cover and a position in the colony and these may offer a better future than life "back home."

The colony contains a truly mixed group of personnel. While many colonists are highly skilled scientists or technicians who have paid into the scheme in the hope of finding a better life for themselves and their families, many others are workgangers who were recruited from the orbital constructions well before the O'Neill wars. Since the eruption of the turmoil in orbit, relationships between this portion of the colony and the base management have become strained.

The colony itself maintains a small "police" force known as the Colonial Militia. This appears to be tolerated by the base management as a small compromise to growing complaints that the colonists have little power in management of their own lives. The militia are provided only with tasers. No projectile weapons or armor is allowed for use by colonists.

Life as a colonist is rather dull. The accommodation is much smaller and less comfortable than suggested by the many advertising campaigns held by ESA in the European continent, and the variety of food from the vats and small number of bio-engineered stock is limited and usually rather bland. The 'gangers use vast quantities of spices to enliven their food, usually making it inedible to most European palates. Within a few days many of the newer colonists are grumbling about the conditions and threatening to complain.

The characters are free to wander around a large portion of the complex. However, a substantial portion of the management wing is restricted to official (ESA) personnel and is off limits. If the characters try to sneak or force their way in they will discover it is well secured and that access is impossible. It is also guarded by well trained goons carrying smart-chipped flechette rifles. As days roll into weeks and little happens the characters will rapidly become bored. It is unlikely that any of them are really cut out for colonial life.

Neither, of course, are many of the colonists. However, most of them do not have anything to return to and must make the best of circumstances here.

FIRST ORDERS

After the characters have been in the colony for five weeks they each find themselves visiting the management wing of the base for various reasons. Eventually they are all led into the

same room which consists of a number of comfortable couches and a large bar. They are left to "make themselves comfortable."

Two minutes later a stranger enters the room. He introduces himself as Robert Forrin, a member of the Isidis security forces in charge of internal security. He assures the characters that the room is secure from outside prying and begins to brief them on the details of their "mission."

"By now you have had an opportunity to blend into life in the colony and adopt your new personas. I am sorry that this process has taken so long, but we wish to ensure that no one suspects your real purpose here. This will hopefully be our only direct meeting until you have completed your period of employment here. Any further information you require, or messages we may need to deliver to you, can be relayed through the secure Net area we have already provided for your use.

"The entire colony is under threat from a serious attempt to undermine our authority. We believe this is being led by several individuals who see themselves as Martian 'crimelords' and who have an illicit trade in drugs and weapons with Chryse Base and individuals already stationed in orbit around this planet. We have outlawed personal weapons and many drugs for the good of everyone in the colony. However, we have appropriated several samples of both which have been smuggled in without our knowledge. We have also discovered that these so called rebels have an important ally at Chryse Base who uses the cover name of 'Sandman.' We have been unable to discover his identity or role in the plot.

"We must find out who the key players are in this dissident group and who their main contacts are outside this base. We must also pinpoint this 'Sandman' and block his usefulness. We have not been able to

progress in this matter ourselves and we are counting on you to gather the information we require. The management of this base will NOT allow anyone to jeopardize the safety or success of this colony. Remember, you are being well paid to aid us, but do not take us lightly. If you attempt to cross us you will sincerely regret it."

Robert has access to all the information ESA currently knows about the "rebellion." The information he can provide the characters is, however, limited. There are several colonists who are considered to be potential dissidents and there are also two workgangers who Forrin believes are the main trading link with Corps and individuals in Mars orbit. Precise information is provided on each of these individuals and is described in detail in the following sections.

Forrin has not been willing to alert these individuals by restricting their activities. He has hoped they would lead to the location of other members of the group and possibly to the position and identity of the corporation/s involved. He hopes the characters may be able to use them to discover further information.

The characters may also request equipment from Forrin, as this is the first direct contact they have had with their employers. Clearly there is a limit to anything the characters can possess without risking their covers. Any character who has a cyberlimb can have a flechette pistol installed in it; however, Forrin recommends that any other character who requires weapons should apply to join the militia. Not only will this give them access to Rubin (see below), but it will provide an excuse for their possession of weapons. Forrin stresses that any weapons should only be used as a last resort as it may compromise their positions.

Netrunner characters can also be provided with a cyberdeck (See

sidebar, pg. 92). They are reminded that they are under contract to the management board and that any "subversive" infiltration against the computer systems on the base would be considered grounds for termination of contract. They can also be provided with several programs, including a boosted version of Invisibility with a strength of 4, which Forrin explains will help them trace others who might attempt to disrupt the operation of the colony's computer systems. He stresses that the programs that have been provided will trigger an alarm if used against any of the Isidis Base defenses. Forrin will NOT provide a Netrunner with any more support than this—he has his own pet Netrunners on standby for when things get rough.

Forrin then indicates that the meeting is completed. The characters are led back off in different directions to complete their original tasks, armed with at least a little more information than before.

It is likely that, given few other avenues, the characters may attempt to become familiar with the personnel that Forrin has indicated may have some involvement with the disturbances against the base management. The following sections provide some information for encounters with each individual.

DR. SERGEI LERPOVSKY

Sergei is the colony's head medic and is described by Forrin as a "stubborn Russian fool." Lerpovsky originally worked in a major hospital in Moscow as one of their leading experts in trauma surgery. He had become exceedingly disillusioned by the lack of facilities available to him and could see no sign of improvement in the mediocre lifestyle afforded to him and his family. After a brief visit to Europe, where he was introduced to many new techniques and trained in nano-surgery, he enrolled in the Soviet colony program.

Modem:

Solaris VI cybermodem,
Speed +5, Memory 20mu,
Data Walls +8

Programs Available:

Bloodhound

Strength: 3
MU: 5
Type: Detection

SeeYa

Strength: 3
MU: 1
Type: Detection

Invisibility

Strength: 4
MU: 1
Type: Stealth

Force Shield

Strength: 4
MU: 2
Type: Protection

Killer IV

Strength: 4
MU: 5
Type: Anti-Program

Hydra

Strength: 3
MU:
Type: Anti-Demon

Afreet

Strength: 3
MU: 3
Type: Demon

Jack Attack

Strength: 3
MU: 3
Type: Anti-Personnel

Firestarter

Strength: 4
MU: 4
Type: Anti-Personnel

As the characters have already discovered, he, is now a prominent figure in the colony and chairs most of the gatherings held to discuss the colonists own affairs. Sergei will readily discuss his views on life, and the future of the colony, with the characters. He is convinced that the colonists should be given the same authority and access to the base as ESA and Soviet staff members and should be the controlling voice in any decisions which affect the colony as a whole.

RUBIN HANAUB

As head of the Colonial Militia Rubin is in a strong position to influence the other colonists. An ex-member of the Indian national military, Rubin is both an excellent leader and tactician and is determined to see that the colony never suffers from the kind of internal disputes which so disrupted his country. He believes that the militia will provide a suitable deterrent from future civil unrest within the colony itself. However, he feels that the dictatorial methods of the current management are at odds with the purpose of the colony as a whole. Rubin is one of the few colonists who seems able to bridge the gap between workgangers and "others" and is well respected by most members of the colony.

MARGARET HILTON

Margaret is a strong willed Communications Engineer who arrived in the previous influx of colonists. She is apt to argue with anyone given the slightest provocation. It is difficult to have a conversation of any sort with her because she is so liable to take issue with something. Margaret feels that the base management is a bureaucratic monstrosity which is trying to crush her freedom. She also considers that the dissenters such as Dr. Lerpovsky are just trouble makers who will get everyone else into trouble. It doesn't help anyone that she is actually right in both cases.

ERICK JONS

A shuttle pilot who ferries supplies and personnel between Isidis and the orbital stations, Erick proves to be impossible to meet casually as he seems to avoid strangers at all cost. Attempts to phone his accommodation or leave messages for him will be ignored, and if the characters ask about his location, other workgangers will simply shrug, saying, "Oh Erick, he's probably off somewhere on one of his trips. I'd try again next week if I was you."

If the characters haven't come up with a VERY plausible excuse when they try to contact him, then Erick will quickly become suspicious of their motives. If this happens then one of the characters will be "tagged" as described in more detail shortly.

PALLA KARMULIN

Palla drives construction equipment for the base and is currently engaged in a rostered shift at the planned Olympus colony site. She is a dealer of most things illegal and has begun a small trade in illicit drugs and equipment. Palla has several main sources which include Erick, who scavenges equipment and drugs while in orbit, several individuals from the growing Chryse Base (where trade is somewhat less restrictive), and a small group of Highriders living in orbit around Mars who provide the best line for drugs and weapons.

Palla is extremely dangerous and has several colleagues within the workgangers who provide her with some "muscle" if required. She already has several weapons stashed in the base and only a few chosen individuals know the locations. As with Erick, Palla will become suspicious quickly unless the characters are very subtle in any approach. If they are too obvious then she will arrange the following "tag" herself.

"TAGGED"

If the characters alert either Erick or



Rubin Hanaub

ROLE: SOLO

INT 8, REF 7, COOL 9, MA 6, BODY 8, TECH 5, ATT 8, EMP 9, LUCK 5

SKILLS: Combat Sense +6, Endurance +2, Oratory +2, Leadership +5, Social +2, Awareness +4, Expert (Small Unit Tactics) +4, Library Search +2, Space Survival +3, Athletics +3, Zero Gee Maneuver +3, SMG +4, Rifle +3, Melee +3, Stealth +3, Basic Tech +4, Demolitions +2, Electronics +2, Elect. Security +1

CYBERNETICS: Basic Processor with Smartgun link and Sandevistan boost; one set of plugs (right wrist); biomonitor

COMMENTS: Firm, capable. Supportive of the colonist's position, but against disruptive violence.



Erick Jons

ROLE: PILOT

INT 7, REF 7/8, COOL 6, MA 7, BODY 6, TECH 6, ATT 5, EMP 3, LUCK 4

SKILLS: Brotherhood +3, Astrogration +5, Physics +2, Programming +2, Awareness +4, System Knowledge (Mars Colonies) +2, Pilot OTV +6, Space Survival +3, Pilot Spaceplane/Shuttle +3, Zero-G Maneuver +4, EVA +5, Basic Tech +3, Handgun +4, Electronics +3, Weap

CYBERNETICS: Basic Processor with Vehicle link, Smartgun link, and Sandevistan boost; two sets of plugs (one each wrist); biomonitor; enhanced antibodies; Adrenalin booster; cybersoptic with antidazzle, teleoptics, targeting

COMMENTS: Cautious and competent.



Palla Karmullin

ROLE: WORKGANGER

INT 9, REF 7, COOL 8, MA 4, BODY 5, TECH 7, ATT 5, EMP 5, LUCK 7

SKILLS: Workgang +6, Intimidate +2, Streetwise +6, Human Perception +3, Awareness +3, Education/Gen.Know. +4, Expert (Construction) +6, Space Survival +4, Op.Hvy.Machinery +5, Zero-G Maneuver +3, EVA +3, Basic Tech +3, Handgun +3, Melee +3, Pharmaceuticals +3.

CYBERNETICS: Basic Processor with Vehicle link; one set of plugs (both wrists); biomonitor; voice synthesizer; Slice 'n Dice

COMMENTS: Dangerous, careful, formidable.

Palla or are just downright obvious in their investigations then one of the characters will be seduced by a young African woman named Anetta Tula. This will happen gradually and may be easy to slip in if any of the characters are have particularly large egos or over-active hormones.

Anetta knows little of any use to the characters or their employers. She has spent most of her life in orbit, having been brought from Earth as a child in the initial Hireout by ESA. Anetta is addicted to a nasty synthetic drug known as Starlight, a euphoric which also generates a +1 increase to INT during use it is highly addictive and very expensive. The drug is also very rare in orbit and at Isidis, Palla is the only current channel. Handy for Palla really.

Having spent almost her entire life in low gravity Anetta is tall and rather frail looking but very attractive. Anetta works as a chemist in the ESA laboratories and was hooked onto the drug by a "friend" during a party. She is unwilling to admit to the authorities that she is an addict, fearing that she may be thrown out of the colony by the management, and has hidden the fact from all but a few workgangers. Unfortunately, to ensure her supply of the drug, Anetta now finds herself an unwilling pawn in Erick and Palla's game. Anetta will play her part well mostly out of fear of losing her supply. However, she is also a rampant flirt who drops men as quickly as she finds them. Her "talents" tend to be rather wasted in the limited environment of the Mars base, and Anetta is one of the few workgangers who really looks forward to the arrival of a new group of colonists.

Anetta Tula

ROLE: Tech (Chemist)

INT 8, REF 5, COOL 4, MA 6,
BODY 5, TECH 8, ATT 9, EMP 7

SKILLS: Wardrobe & Style +3, Human Perception +4, Seduction +5,

Social +3, Persuasion +4, Chemistry +6, Mathematics +4, Athletics +4, Zero Gee Maneuver +8, Zero Gee Combat +3, Basic Tech +4, Paint +3.

CYBERNETICS: One set of plugs (right wrist)

COMMENTS: This is one lady to look out for.

Anetta has no knowledge of any plots or anything of relevance except her own suspicions that something is going on. She will strongly deny any suggestion that she was set up to check on the characters and she can be very convincing when required. She has been asked simply to "get close" to one of the characters and try to find out what they are doing. If the characters discuss anything relevant to the real mission or employer while Anetta is around, then assume this is relayed directly to the workgangers and act accordingly.

If the characters resist Anetta's charms then she will sulk off and seduce one of the other colonists instead, just to get back at them.

STRANGE RELATIONS

The next event is only witnessed by one character. Preferably pick the one most susceptible to pathos.

At some point the character is on the inner boundary of the general colony area, near the ESA administration block. A large glass window at this location affords a view of the Martian surface and, across some distance, to another similar window in a corridor in the private ESA sector. As the character glances out at the Martian landscape his attention is captured by a movement within the opposite corridor. A small figure, apparently that of a young child, races past the window toward the end of that corridor section. Seconds later several heavily armed ESA guards do likewise. If the character

continues watching they see the guards return, now dragging the kicking and screaming form of the child. Obviously the character cannot hear anything which is being said, or yelled, from this distance.

Unless the character is making some attempt to shield his presence from the guards on the far side there is a chance, if the character fails an Easy roll vs. LUCK, that he is spotted watching. As the figures disappear beyond the wall at the far side the character is left with a strange feeling that something, other than the obvious nature of the events, was seriously wrong with the scene he has just witnessed.

This thought plagues the character. However, he cannot place the cause for his concern. Hopefully he will recount the encounter to his colleagues. As he is midway through describing the scene, it suddenly occurs to him what was wrong.

The child's arms were too long.

FIRST CONTACT

An uneasy peace reigns for almost two weeks, during which the characters will draw blanks on any lines of inquiry. Several other individuals are placed under house arrest over the next few weeks and it becomes clear that even "private" quarters are not as private as had been imagined. During this period the characters begin to notice many of the workganger members of the colony involved in short meetings, often catching glimpses of a curious sign language being used in brief exchanges. Any attempt to question the individuals concerned draws only blank looks of surprise. If the characters push questioning too hard they find themselves confronted by raw distrust and anger. Either way they cannot discover anything further.

Something is, however, obviously going on.

If the characters begin asking around about the child they saw, or make any reference in general company to experiments or genetic developments, they will find that most of the colonists cannot shed any light on the mystery. Similarly, if the characters begin asking around about anyone called Sandman (or Sandy) they will generally only receive blank looks. If they ask Dr. Lerpovsky he will look quite concerned and say, in a hushed voice:

"I have suspicions that there are things going on in orbit around Mars which should not be allowed. I do not know anything for certain though and, if you will take the advice of a paranoid old man, you will not say this thing too loudly."

If the characters question any workgangers about Sandman or the child they will receive slightly odd looks but still not obtain any further information.

Once you feel that the characters have made enough inquiries to become noticed then they receive a brief note which reads:

If you wish to find out more about me you and your colleagues should meet my representative at lock D3b with suits at 1700 hours tomorrow.

Sandy

The note is hand-written in flowing script and looks curious to the characters, who probably have rarely (if ever) seen a document created using an ink pen. Attempts to match the writing to that of any colony member, past or present, fails.

The following "afternoon" a brusque heavyset African male awaits at lock D3b. He makes little conversation, simply indicating that the characters should follow him outside, and refuses to answer any further ques-

tions. He trudges slowly to the vehicle bay and climbs into the cabin of a survey vehicle, directing the characters into the aft passenger cabin, which has seating for up to ten occupants. The cabin only provides sufficient room for the driver and he will refuse to impart any information regarding their destination. He will indicate as many times as necessary that the characters should refrain from conversation over the suit radios.

Once inside the vehicle the cabin is pressurized and the characters can remove their helmets. Conversation can resume; the African (separated from the characters by a securely locked door into the cabin) refuses to join in. A few moments later and the vehicle hums to life, moving slowly onto the rocky terrain and then weaving its way across the Martian desert as its navigation equipment skirts crevasses and faults in the parched soil.

The vehicle travels for over an hour, bouncing across the Martian landscape. Through the observation ports the characters can watch their progress across the barren terrain. They appear to be heading well away from any form of habitation; even Chryse Base is in the opposite direction from their current course.

Simultaneously an alarm pierces their conversation and the survey vehicle is thrown violently forward. Beneath them a huge section of soil and rock gives way, as the seemingly solid ground collapses into a yawning crevasse. Although the area had appeared sufficiently solid to the sonar, the vehicle's vibrations caused an unfortunate harmonic disturbance which loosened a large section of rock several meters below. Several hundred tons of rock, dust and survey vehicle slip down into a crevasse slightly wider than the vehicle itself.

Approximately ten meters below the surface the vehicle stops suddenly,

throwing its unfortunate occupants violently about. At this point the crevasse has narrowed sufficiently and the vehicle is now firmly wedged, nose down, into the narrow gap. Rock and dust continue to fall past the vehicle for several minutes, dropping past and down into the depths of the crevasse, several hundred meters further below.

The characters are bruised and, in several cases, slightly concussed. They are otherwise unhurt and the compartment has retained pressure. They soon discover, however, that they cannot obtain any response from their driver. Interface sockets provide access to the vehicle's support systems, which indicate that the front cabin is no longer pressurized.

In fact the driver is quite dead, as the impact crushed both the nose of the vehicle and its occupant. The vehicle is completely inoperable and it is well beyond the character's abilities to salvage it. Although the exit is not jammed, anyone who attempts to leave the vehicle is presented with a view along a yawning chasm which extends hundreds of meters into darkness both out from the door and down. The walls of the chasm are approximately two meters to either side of the lock and extend upward to where light filters down from the hole left by their drop.

Further investigation reveals that the impact has destroyed most of the vehicle's electronics except for lighting and the status system itself. Life support, navigation and communications equipment are all inoperable. The suit radios are clearly of insufficient power to summon help and, although the suits can provide air (and water) for several days the characters will rapidly become hungry. Since no-one knew where they were headed, or in fact who was leaving in the first place, it may be some time before any form of search is organized.

They appear to be stuck. Waiting will prove fruitless and days may pass without contact while the characters are still unable to escape, or repair any of the systems damaged in the fall.

On searching the interior of the vehicle thoroughly the characters discover some climbing equipment in a small locker which could aid them in scaling the walls out of the hole. The equipment includes a pressurized "gun" for embedding divots and several hundred meters of polymer rope, with loops at one meter intervals. The climb out is still not an easy process, and is made more difficult by the unstable nature of the sand on the upper level of the hole. The first character to attempt the climb must succeed in two DIFFICULT rolls vs Athletics, and each later character must succeed in one such roll.

A character who fails a roll slips and plummets downward. If he is tied somehow then he will be saved by the tether, but will take 2D6 damage as he crashes against the rocky side of the chasm. A character who is not suitably tethered falls several hundred meters to his death. As the last characters reach the surface they accidentally dislodge a further section of the edge, which almost takes them back into the chasm with it. Under the weight of falling debris the crawler creaks loudly and then slips, dropping several meters further before being torn in two by a rocky outcrop. A resounding explosion follows as the leaking fuel meets an scaping torrent of oxygen from the storage tanks and leaves no question as to the state of the crawler.

Once on the surface the Martian terrain stretches in each direction and the characters have only a vague idea which direction to head. After an hour, however, the characters sight a small surface vehicle heading roughly in their direction. The vehicle soon changes direction and

heads slowly toward the characters, stopping nearby. A single figure in a suit steps from the vehicle and nods to the characters. Although the characters can easily communicate to each other using the suit radios, the newcomer does not appear to hear any of the communications and does not respond to them in any way.

Unknown to the characters, this solitary figure is their target. His name is George Tarant and he is a genetic engineer working for NASA at Chryse Base. George is also a competent netrunner and a technology buff who has melded so much cyberware with his body he is suffering from advanced cyberpsychosis, resulting in severe schizophrenia and dual personalities. He is both George Tarant and "Sandman", the figure whom ESA security believes is masterminding the colonists' revolt against them.

Several years ago, when the main computer installations at Isidis were just being completed, George performed several "runs" against them. As a budding genetic engineer, George figured he might find some useful secrets in the ESA and JAB files already stored there. What George was looking for was something useful for his work, perhaps new breeds of fish, or plant food which grew better in culture, or even something which could survive and grow in the airless waste of Mars. What he discovered were files on "Project Adapt", a project funded by several major corporates, including ESA, to genetically engineer organisms suited for life in orbit and on the surface of Mars. Of course ESA wasn't bothering with animals or plant—this research was on humans.

George has had only minor contact with the rebel workgangers, who have provided him with programs and weapons, and knows nothing of their plans to replace the ESA man-

agement board. He has begun a personal campaign, mostly through the Net, to attempt to disrupt the experiments in the "Adapt" project which he feels are immoral. His major complaint is regarding the project's "failures", which are either killed or used in further experiments either in orbit or in isolated sections of Isidis Base. It was one of these failures that one of the characters saw trying to escape from her captors. George has managed to gain the support of several workgangers at Isidis, who feel that the more active resistance against ESA, the better for their own cause, and they provide him with inside information about ESA activity.

"George" is quiet, introverted and intelligent. In this personality he is unaware of the vast amounts of cyberware now grafted into his body and does not use them even in emergencies.

"Sandman" is extroverted and violent. The change between personalities is abrupt and spectacular, culminating in activation of patterns within his cyberoptics which cause them to glow a deep swirling red, giving him a look of manic determination. In this personality he sees himself as the protector of the "new race" of genetically bred misfits which are being dumped onto Mars and in orbit by the corporates. He will use any means necessary to protect himself and his "charges" and to stop further tampering with genetic material by the corporations.

During the early portions of this encounter "George" remains calm. However, he appears constantly distracted, as if thinking of other things. He is clearly uncomfortable in the presence of several strangers but seems to be putting himself out to help them. George had arranged to meet with the characters (the crawler was an accident) because he has heard they were asking about him or

the mutant child, and believes they may be sympathetic to his cause. If the characters attempt to detain him or use force in any way then he will initially attempt to laugh off their actions as paranoid and foolish, insisting on his cover. If they persist, or clearly intend him harm, then he will become angry and the switch in personalities will occur.

The suit is a modern design but is obviously different from those of the characters. A NASA logo adorns the front but no other markings can be seen. The figure inside is a male, possibly in his late 30's with thinning hair and clear blue eyes which dart between each character. He looks slightly perturbed and directs them into the vehicle. It is an older design and not pressurized. After a short and bumpy journey they arrive at a temporary pressure dome, of the type used by Martian residents in emergency.

Once inside, the characters and their strange host can unseal their suits. Their host introduces himself, in a pronounced American accent, and explains that he is currently taking a vacation while he collects some rock samples for his growing collection. He also claims that his communications equipment, including his suit radio, is malfunctioning and no longer appears to work. Inside the pressure dome the scene fits that of a temporary base camp, with equipment and survey holo's littering the ground.

George is a curious introverted chap who seems uncomfortable with their presence. His eyes dart from one character to another quickly, as if he is unsure where to rest them. He talks constantly, prying the characters for information about their homes, families and occupations. If the topic does not come up itself then George will ask innocently about their own vehicle and whether there was anyone else in the crash. He will

look upset at any news that their driver has been killed. He will not admit to knowing him and claim only that he hates pointless deaths. A successful Psychology roll at this point suggests that the questioning is earnest and the George is simply trying to make conversation. Any character succeeding in a Difficult roll vs Psychology gets the impression that there is much more to George than is apparent. They cannot, however, gain any more than a disquieting feeling about their host.

Eventually George begins asking about the Isidis management. He claims to have heard rumors that many colonists are unhappy at Isi is and wonders if this is true. If the characters admit there are problems George offers any help that he, and his colleagues, can provide.

If the characters mention the disfigured young girl in George's presence he will appear extremely upset.

"As a genetic engineer I can only presume someone is tinkering with human genes. Such things are illegal, and rightly so. I cannot believe anyone would perform such experiments but I expect the corporations are still content to live by their own laws. You say they had this child in the base itself. It is unthinkable they should be so bold."

George will pry them for any further information on the encounter and asks, if they see anything further, to let him know at Chryse Base, where he will report the information to the authorities.

If asked about the "Sandman" George looks startled and will ask the characters for more information. He denies any knowledge of who "Sandman" actually is, saying:

"Actually you are referring to a myth. Although its origin is lost, I know that many Highriders in orbit held similar



George Tarant (alias Sandman)

ROLE: NETRUNNER
INT 8, REF 8, COOL 3, MA 5, BODY 7,
ATT 5, TECH 7, EMP 0 (6 see note)

SKILLS: George: Interface +4,
Awareness +6, Neural Symbolic
Language (NSL) +6, Programming +3,
System Knowledge +3, Athletics +2,
Basic Tech +5, Cyber Tech +4,
Electronics +4

"Sandman": Interface +2, Awareness
+7, Leadership +4, Athletics +6

CYBERNETICS: Cyberoptics (both eyes)
with Image Enhancement, Anti-dazzle
and Color Shift; Cyberlegs (both) w/
Realskinn, Rad-shield and Reinforced
joints; Cyberarm (Left) w/Realskinn,
Rad-shield and Micro-missile launcher;
Pain Editor; Chipware Socket and
Processor.

(Continued on page 98)

George Tarant (alias Sandman—cont.)

OUTFIT: At his base he has access to a wide variety of tools and weapons. At minimum he carries: Memory chips - Martian Survival, Euro culture; Reflex Chips - Handgun +2, Pilot Crawler +2; Technica 15 Microwaver.

COMMENTS: In addition to all the comments above it should be noted that the schizophrenia has resulted in true personality separation. Curiously the massive amounts of cyberware melded into his body has not resulted in destructive reduction of "Humanity" for the entire personality. Rather it is "George", who is unaware of the Cyberware, who suffers the mind-numbing EMP reduction, while the "Sandman" seems both charismatic in his personality and able to fully utilize his cybernetic enhancements. This is a potentially disastrous situation which will, eventually, culminate in a massive and violent nervous breakdown.

beliefs before the O'Neill wars. They said that a leader would come amongst them and lead them to victory against the oppressors. In this case, the oppressor was mainly ESA and its domination of the orbital habitats."

He smiles as he speaks.

"The Highriders felt that ESA was crushing their freedom and that they, as the real citizens of space, had the right to rule their own lives. In the end, of course, this happened. Unfortunately many lives were lost in the process."

George pauses, standing as if to get himself a drink, then sits again uncomfortably as if he had forgotten something.

"Many of the colonists here on Mars, particularly at Isidis, came from the early orbitals. Obviously they carry with them a similar cultural heritage. Of course, for them the battle is yet to be fought."

George looks at each of them for a moment, his eyes gleaming with a new intensity. Then he relaxes again and the characters are left feeling that perhaps they had imagined his momentary change of mood.

The conversation can now proceed in two ways.

One: If the characters manage to maintain a facade of concern about the base management and in particular about the young girl, George will eventually lean forward and say quietly:

"My friends, you seem sincere in your concern about the behavior of the official management at Isidis. I am simply a genetic engineer who is concerned about misuse of my science but I have friends who are also concerned about these things. Are you willing to help us?"

If the characters agree, he will continue.

"You are new at the colony and it is unlikely that you will be suspected of anything yet. I believe that ESA is performing illegal experiments on genetically engineered humans at the base, as well as in orbit. Indeed I have collected some information already on their project. I require more conclusive proof before I can expose this to the authorities. If you can collect such proof then I will be eternally grateful."

It is likely that the characters will ask George what they may expect in return, or at least what he can provide them to help. He will look a little perturbed and respond,

"As I said earlier, I am a scientist, not a spy. However, there are others who may be willing to provide you with equipment and, perhaps, may also have use for your services. I will contact them over the next few weeks and see if they wish to discuss things with you further."

Shortly thereafter George suggests they return to Isidis. He drops them a few hundred meters from the base but refuses to go nearer and will politely refuse any offers of hospitality, claiming he has things he needs to do. He departs, saying,

"I will contact you again soon. Look for me in the Net in the next few weeks once I have had time to discuss your requirements with others."

Two: Alternatively the characters may confront George and insist they believe he is Sandman. This conversation will become confused since, although George is actually Sandman, he is not involved with the workganger plot. He will eventually become angry and attempt to don his suit and leave the characters. If they attempt to detain him then he will become violent and attempt

to use force to escape. The characters will want to be careful—remember this is only a thin pressure shelter and even a flechette will puncture the seal. Assuming that most of the group has joined this venture then they should be able to overwhelm George eventually. Investigation of his shelter reveals:

- The radio has been tampered with (apparently by George) and can easily be fixed. The characters can then use this to contact the base.

- As well as the legitimate contents of the shelter they find a microwave pistol and several maps of the Martian surface which are covered in annotations. It will take hours to sift through the scrawled notes, most of which refer to rock collections. However, the map also contains a reference to the location at which George usually meets his contact from Isidis. This cannot be done until they return to the base. Once translated it indicates that George is expected to rendezvous at this location again in 16 days time. There appears to be no information about how to reach the contact earlier. The characters can determine that the location of the meetings is well within range of the Olympus construction site where many of the workgangers are based on shifts of several weeks' duration.

On returning to the base the characters have a great deal of explaining to do. The bureaucrats in the base management (who obviously do not know that the characters actually work for ESA) will be furious at the loss of the crawler and will question each character in turn as to why they were engaged in such reckless activity.

If the characters check the story which George provided them then it can be easily verified by Chryse Base.

Only hours after their return the characters are confronted by an en-

raged workganger in a public area. Although they vaguely recognize the African he is not well known to them. He does not bother with introductions and is clearly extremely angry.

"What can have happened out there that you return without our friend? Do you not even have the decency to return his body to us? Are we really expected to believe that he was stupid enough to drive head first into a chasm, or that the radios simply malfunctioned!?"

Any attempt to reason or calm the annoyed colonist is a failure. He snaps "We will not forget this," before storming off.

GATHER, DARKNESS

As the end of the characters' second month on Isidis draws near, the mood within the colony undergoes a sudden shift. This is provoked by two incidents, which occur within the same week.

Firstly, the management board issues a colony-wide statement.

"Due to several recent cases of damage to colony equipment and vehicles resulting from careless use during unnecessary outside excursions,

all future use of colony vehicles must be approved by the management board. Any member of the colony who wishes to use colony property, other than their personal worksuit, to travel outside the confines of the base must submit an appropriate authorization request to the appropriations committee.

"We are sure you will join us in supporting this requirement to improve the safety and effectiveness of the base for all residents.

"Thank you."

The characters may wish to lay low after the publication of this statement since they were clearly at least partly responsible for its appearance. Secondly, Thomas King, one of the members of the colonial militia, is arrested by the security forces for allegedly possessing unlicensed firearms. An official statement is issued which indicates that Thomas has been found guilty of infringements which endanger the base security and will be held in custody until he can be returned to Earth on the next available flight. His family are advised that they are free to leave with him if they choose. This action angers many colonists, particularly Rubin Hanaub.



Tempers are now running high and mutterings indicate that a response to these actions will be the main item at the next gathering, which is to be held later that week.

The meeting attracts a large turnout of adult colonists, 795 in all, but few workgangers are evident. As usual it is chaired by Dr. Lerpovsky, who rapidly dispenses with the general business and then calls the crowd to attention. In a voice tinged with concern he begins.

"I would now like to ask any of you, particularly new arrivals, who do not wish to be disillusioned by the gripings of a few old timers to leave the meeting."

There is some surprised shuffling at this comment but, predictably, no one leaves. Shrugging his shoulders, the doctor then requests the militia, possibly including some of the characters, to check that the corridor outside is clear and to lock the doors. An Average roll vs. Awareness will indicate that unlike most of the rest of the colony this room is free of the ubiquitous security cameras which monitor most public areas. The doctor then continues.

"We came here to find a new home, and to escape the crowds, pollution and despair of Earth. But here we do not find freedom. Here we may only go where we are told. We may only visit the outside when it is acceptable to do so. We may not carry guns and, worst of all, we do not have a voice as to the future of this colony or planet.

"Are we children to be treated so?"

The doctor's speech has become progressively more impassioned as he has gone on. While the new-comers sit quietly many others are nodding and murmuring vigorously. It is evident that these are not isolated complaints.

"Our requests, pleas and petitions have gone essentially unanswered. Why are our food sources still so limited? Why do we obtain only under-grade equipment? What is happening to the terraforming project and why are we, the people who must build a new life here, not consulted about its progress?"

A tall woman within the crowd stands and calls out, sarcasm evident.

"Perhaps, doctor, we should move to Chryse, or even back to Earth. Would it be better there?"

"No, Margaret. No doubt it wouldn't. But we cannot stand by and watch these corporate lackies run this planet, perhaps destroy its potential, for their own gain. I will not live under a dictatorship, no matter how benevolent. We must seize control of our own futures. We, the colonists, now comprise over two thirds of the population of this colony. It is time we were given input into those decisions which affect us, our children and the generations to come."

You can extend this discussion as you see fit. The doctor suggests that the colonists can easily arm themselves with "weapons" if required, by adapting engineering tools they already possess. The tone of his voice indicates that he has already taken this action himself. He believes that the colonists' superior numbers will allow them to conduct a bloodless coup and obtain control of the communications equipment, weapons and main transport systems. It becomes clear that other than the doctor, only a handful of colonists are willing to risk active involvement in any 'subversive' activity against the current management. The small workganger contingent, mainly of Afro-American descent, seems curiously reserved during the meeting.

The meeting ends with the doctor urging everyone to prepare for a

possible confrontation and to return to the meeting room the following night ready to grasp their destiny.

Do the characters report on the meeting? They easily overheard the names of all those involved in the plot and the ringleader is clearly the doctor. Perhaps the contract will prove far easier to complete than their employers had anticipated.

Even if the characters do not report the incident, the doctor and the other members of the 'conspiracy' are placed under house arrest the following day by heavily armed and armored ESA guards. A statement is issued by the mayor which advises that certain civilians have been restrained in the interest of security, and that subversive actions against the official Isidis Management Board will not be tolerated.

Are the characters beginning to feel like heels yet?

PART FOUR: MUTINY

By now the characters may be starting to gain a picture of the size of the problem at Isidis.

Firstly: The colony is substantially run by the ESA and there are many colonists with Highrider backgrounds who intend to usurp power from the ESA on Mars, just as they did in many places in orbit during the Highrider war.

Secondly: The remaining bulk of the colony are disenchanting with the current management for a variety of reasons. Feelings within the colony run high as the issue of the colony's future is seen as a matter of life and death to those who intend to remain and bring up families on their "New World."

A large percentage of the colony is directly involved with the dissenting workgangers in some way and it will be difficult for the management

board to round up the culprits. Thus the security force has decided to allow the workgangers to revolt and, once they have determined who is leading the activity, crush the revolt and deport its leaders. Forrin and his cronies hope that the characters will help them pinpoint the leaders and may help limit the success of the revolt itself if the characters can become sufficiently entrenched with the rebellious group.

The characters may now mess about for some time in the colony. It will eventually become clear that they need to contact the rebel workgangers directly somehow. There are a variety of ways in which the characters may be able to build enough interest in themselves so that the workgangers will chance a meeting with them. Several encounters are provided below which may provide hooks for generating a meeting with a workganger representative. The best option for the characters will be to attempt to trade some information to them. Forrin "leaks" the characters a detailed map of the ventilation system within the management wing, information which the colonists do not have and view as extremely valuable.

Although virtually everyone in the colony could be considered to be "involved" in the unrest which is building, there are several key players. It is unlikely that these individuals will ever openly reveal to the characters that they are in some way "in charge" of the rebellion. However, the characters may be able to deduce that some of these individuals are particularly influential, especially with those colonists who are from orbital backgrounds. These individuals are described briefly below. It is these four, along with Palla and Erick, who the council is really after to disperse the bulk of the unrest in the colony.

Bill Burke

By the time the Highriders finally

revolted against the ESA in the orbital colonies around Earth many Europeans and Asians had mingled with the African base stock and considered themselves part of the orbital culture. Bill, who in those days used his real name of James McIvoy, was a delta pilot for Orbital Air running protection flights alongside the commercial liners when times got rough. Although in the pay of ESA, Bill never really liked their way of doing things, especially not the way they treated people.

When the storm blew up and Highriders all over orbit took up arms against the ESA, Bill gunned his delta into the free orbits and began using ESA troop carriers for target practice. Unfortunately his home, and many friends, were lost when the ESA successfully held Paradise Station against the Highrider revolt. Several days later Bill's crippled ESA delta limped into dock at O'Neill One with a gaping hole in one side and most of its engines blown apart.

Bill now works as an electronics technician at Isidis and is just biding time until he can have another crack at the ESA. This time he doesn't intend to lose.

Tara Hartley

Tara is probably one of the few people at Isidis who doesn't have some kind of a gripe with the ESA. She isn't really bothered by them much at all. However, Tara came to Isidis over two years earlier with her husband as part of a Soviet-funded scientific team to help survey Mars. Tara and her husband, Michael, were specialists in electromagnetic radiation and were to chart the Martian ionosphere in detail to aid orbital navigation and placement of satellites. Two months into the studies, Michael was killed when his suit, provided by the Soviet team, malfunctioned. Due to poor procedures used by the Russian crew, help arrived far too late and Michael's corpse was dragged back into the



Bill Burke

ROLE: PILOT

INT 7, REF 7, COOL 8, MA 7, BODY 9,
TECH 5, ATT 5, EMP 6

SKILLS: Brotherhood +5, Pilot Delta +4, Pilot OTV +2, Zero-G Maneuver +5, Zero-G Combat +3, Space Survival +3, Awareness +3, Basic Tech +4, Handgun +1, Melee +5, Heavy Weapons +2, Programming +3, Russian +2, German +2

CYBERNETICS: Basic Processor with Vehicle link; two sets of Plugs (both on wrist)

OUTFIT: Skinsuit, Tool Belt with micro-tools, Kendachi monoknife, bad attitude towards ESA.

DEEP SPACE

RED CONFLICT



Tara Hartley

ROLE: TECH

INT 8, REF 5, COOL 4, MA 5, BODY 6, TECH 6, ATT 7, EMP 4

SKILLS: Jury Rig +3, Electronics +5, Physics+5, Mathematics +5, Basic Tech +2, Programming +5, Pilot OTV +1, Zero-G Maneuver +2, EVA +3, Space Survival+2, Awareness +2, Melee +2, Education/Gen.Know. +5, Russian +2,

CYBERNETICS: Basic Processor with Machine/Tech link; one sets of Plugs (on wrist); Chipware socket

OUTFIT: Skinsuit, Tool Belt with micro-tools, Kendachi monoknife, bad attitude towards ESA.

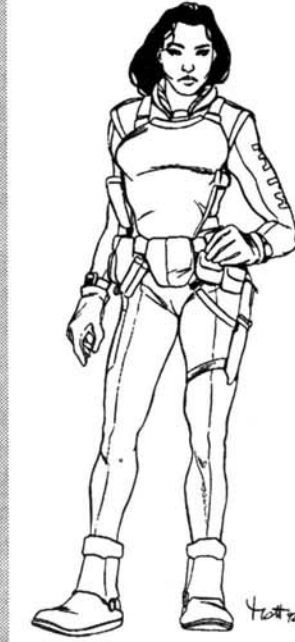

Angellna Tomas

ROLE: MEDTECH

INT 9, REF 6, COOL 5, MA 6, BODY 5, TECH 7, ATT 8, EMP 8, LUCK 6

SKILLS: Medical Tech +3, Human Perception +4, Persuasion +3, Biology +6, Chemistry +6, Diagnose Illness +2, Cryotank Operation +3, Pharmaceuticals +4, Library Search +3, Zero-G Maneuver +2, Space Survival+3, Awareness +2, Basic Tech +4, Education/Gen.Know. +6, French +1,

CYBERNETICS: Basic Processor with Machine/Tech link; one set of Plugs (on wrists); Chipware socket; Biomonitor

OUTFIT: Skinsuit, laptop computer, portable autodoc unit, Dynatech hand taser, chips for Handgun +2, Space Survival (Mars) +3, Martial Arts (GMs choice) +2



Shamat Hulith

ROLE: MEDTECH

INT 9, REF 7, COOL 6, MA 6, BODY 7, TECH 7, ATT 6, EMP 6, LUCK 9

SKILLS: Medical Tech +5, Human Perception +4, Persuasion +4, Leadership +2, Biology +2, Botany +4, Zoology +3, Diagnose Illness +2, Cryotank Operation +3, Electronics +3, Library Search +3, Awareness +4, Basic Tech +3, Education/Gen.Know. +4, French +2, Athletics +3, Handgun +3, Stealth +2

CYBERNETICS: Basic Processor; one set of Plugs (on wrists); Chipware socket

OUTFIT: Skinsuit, laptop computer, hands-free comset, rocket "popper" with reloads, Dynatech hand taser, chips for Space Survival +2, Melee +2

workshack with a look of pure agony locked on his features. A distraught Tara has kept on with the work they came to do, but she has a violent hatred of the Soviets and their methods and would like nothing better than seeing them driven out of the base entirely.

Angelina Tomas

Angelina is a talented African biochemist who had a budding career with an orbital-based corporation at Crystal Palace, before the ESA forced the corporation to close due to its supposed involvement with the Highrider revolt. Angelina suddenly found herself out of work and trying to survive in the immensely expensive environment at the Palace. She discovered to her dismay that other corporations didn't seem to want to get involved with those who were associated with her previous employer.

Eventually Angelina fled to Mars where she can make only limited use of her skills. Angelina would like to see every ESA employee at Isidis thrown out the nearest lock, without a suit.

Shamat Hulith

Shamat has come to Isidis directly from groundside, but that doesn't prevent him having a real gripe against the ESA anyway. His parents were both killed by a misdirected rock thrown by the ESA mass-drivers on Luna during the first orbital conflicts.

Shamat has essentially come to Mars looking for a chance to disrupt the ESA foothold within the colony. He is an extremely bright African male who performs genetic engineering experiments on plant life for atmospheric reprocessing and is a firm advocate of the plans to terraform Mars. Shamat is in contact with George (Sandman) and is well aware of the ESA manipulation of human genetic material in the orbital labs.

He is also becoming convinced that the ESA is stalling research into terraforming purely so that it can control the influx of personnel onto Mars and attempt to instigate a Mars-based government with a substantial ESA presence.

THE RUB

The workgangers include a well trained group of over thirty-five individuals who are skilled at combat, as well as the two Solos brought up from dirt-side. They also have two Netrunners, one at Isidis and one currently at Chryse Base (Sherie Phils—see later). They also have a problem...

There isn't much point taking over the colony if they can't access the management wing. So far the workgangers haven't been able to find anyone inside the ESA structure they can trust to help them, and they have little chance of gaining access to the complex without being noticed. Originally one of the colonists, Thomas King, was supposed to infiltrate the management wing just before the strike and ensure the workgangers could gain access. He is now under detention by the ESA. As a fallback the workgangers had convinced Rubin Haubes to help them if Thomas failed. Raubin is under house arrest however, and also of little use. In desperation they had hoped that Sherie might be able to access the internal security systems via the base computers; the system has proven too heavily guarded. Thus the workgangers are currently looking for someone else within the colony who might be willing to help them.

The characters look like a potential option. They are relatively new and thus it is unlikely that the management will suspect them. They seem interested and willing. Obviously the workgangers aren't taking any chances but they certainly have a motivation to talk to the characters if they play it right.

HARDBALL

If a Netrunner character is spending any time in the Net (See Net Map, Pg. 117) then they will have the following encounter:

The character notices a movement behind him in the Net and turns to glimpse another 'runner in the system nearby. This runner is not a usual sight inside the Isidis net-grid and the character will not recognise the ICON. In fact, it is Sherie Phils, who he should have bumped into during the journey to Mars. There is no reason for either of the two runners to recognize each other from this encounter.

Sherie Phils (See pg.112)

Sherie is attempting a run against the Isidis colony system to gauge the strength of the defenses around the power generation and atmospheric processing plant controls. Unfortunately, her Invisibility program has just crashed and she is momentarily engaged in re-starting it. If the character currently has Invisibility running then he is not noticed and he watches Sherie activate Invisibility and fade from view. He may attempt to follow using programs such as SeeYa and his own stealth routines.

If the character follows using Invisibility has four turns before Sherie detects him. If he uses the Bloodhound routine she will notice immediately. Once Sherie detects the character she will begin to take offensive action. Unlike the 'dance encounters, Sherie is now well stocked with serious software and will not allow anyone to jeopardize her mission. Clearly Sherie is no fool and she will attempt to jack out if she believes she is in real danger at any time.

The encounter with Sherie should indicate to the characters that the opposition is active and may be planning something in the near future. It may also provide an opportunity for



Sherie Phils

ROLE: NETRUNNER

INT 8, REF 6, COOL 7, MA 5, BODY 5, ATT 5, TECH 3, EMP 4

SKILLS:

Interface +6, Awareness +6, Programming +5, System Knowledge +6, Athletics +4

CYBERNETICS: Chipware Socket and Processor.

OUTFIT: Elysial cyber-modem, Speed +4, Memory 20mu, Data Walls +6

Programs loaded:

Balron (5): Worm, Hammer, Speedtrap, Wizard's Book (all at -4 to deck speed)

Afreet (3): DecKRASH, Hellbolt (both at -2 to deck speed)

SeeYa (3)

Invisibility (3)

them to offer a trade of information through Sherie.

DON'T allow the characters to capture or trash Sherie this time as they will get another opportunity later.

SANDS OF TIME

If the characters are waiting for George (Sandman) to contact them, he will pay a visit to one of the Netrunners in a public section of the Isidis Base Netgrid. George will not use his Sandman ICON during this encounter but a simple weefle-runner outline which he uses for such occasions. The meeting will be brief and to the point. If the character attempts to detain or attack George during the encounter he is equipped with the following equipment/programs.

Cyberdeck: Private manufacture, Speed +3, Memory 10mu, Data Walls +2

Programs loaded: Reflector (5), Force Shield (4), Replicator (3), and Invisibility (3)

George carries with him a small file which holds the details of Net location at which the characters can leave messages to be collected by George or his colleagues.

"Greetings again my friend. It seems my colleagues would be interested in your services but do not seem convinced that you currently have anything to offer them. If you can provide some token of your good will you will find what you need here and I hope to see you again soon. I have been asked to warn you that any attempt to double cross us will be dealt with harshly, although I am sure their concern is unjustified. We must stop this evil which is being done. It is too much, what they are doing."

Once the character has copied the file George jacks out and his ICON simply blinks out of existence.

UNFRIENDLY NEIGHBOURS

If the characters have had George apprehended by the ESA he will simply "vanish" without a trace. The workgangers who were helping him will eventually realize that something is seriously wrong when he doesn't arrive for the arranged meeting and, particularly after the curious death of their colleague in the crawler, will turn to the characters for an answer.

This will culminate in some or all of the characters being "ambushed" by several workgangers in an isolated part of the base. The 'gangers are angry and the situation could easily end in a violent tussle if the characters don't handle things gently. One of the workgangers has a flechette pistol hidden under his clothing and two others are carrying knives. However, the characters may be able to bluff their way out of any violence.

NEGOTIATIONS AND CONTRACTS

Eventually you should have the characters arrange a meeting with the rebels. If all else fails then they receive a message from Forrin urging them to initiate a discussion quickly as he believes the dissidents are almost ready to use violence against the colony.

The workgangers are fairly desperate and will agree to a meeting with the characters. They will indicate that the characters should meet with them after normal hours at an isolated location within the colony. None of the "leaders" of the group will be present, nor will Erick or Palla, but the workgangers will send several representatives who have a somewhat lower profile.

The two representatives, African males by the names of Khual Chantha and Fogrin Humal, are construction workers with indirect involvement in the dissident group. Both men are single and originally worked on con-

struction of Paradise Station, but were drafted to Mars well before the O'Neill wars. Both men owe Palla money and have agreed to act as intermediaries for the rebels in order to reduce their mounting (drug-related) debts.

The information the characters have regarding the management wing layout is of substantial value to the rebels and will be seen as a distinct sign that the characters are willing to help. If the characters refuse to deal with the two "goons" and insist on meeting one of the rebellion leaders, they will initially be refused. However, eventually they will be met by Shamat Hulith. The rebels will initially try to convince the characters to help by pointing out that the future of the base is as much an issue for the characters as the rest of the colonists. If that doesn't work they will point out that the colony is mostly run by the ESA, which is well known for always having its own interests at heart. The rebels will even admit knowledge of the Adapt project in hope that the characters will back them.

If all else fail the colonists may be able to raise up to 50,000eb to try to pay the characters off. Of course since the information is a ruse anyway, it is of little concern to the ESA what actually happens.

VIVA LA REVOLUTION

If the characters stick with the ESA they stand to gain a substantial reward, but they must remain on Mars for the entire three years of the contract and co-exist with many colonists who may well begin to guess their part in the whole deal. There is also the question of whether, given that the characters now know about the Adapt project and the true situation for colonists at Isidis, that the ESA will really allow them to return to Earth. Accidents do happen, after all.

The colonists are largely in the right. However, it is unlikely that the characters

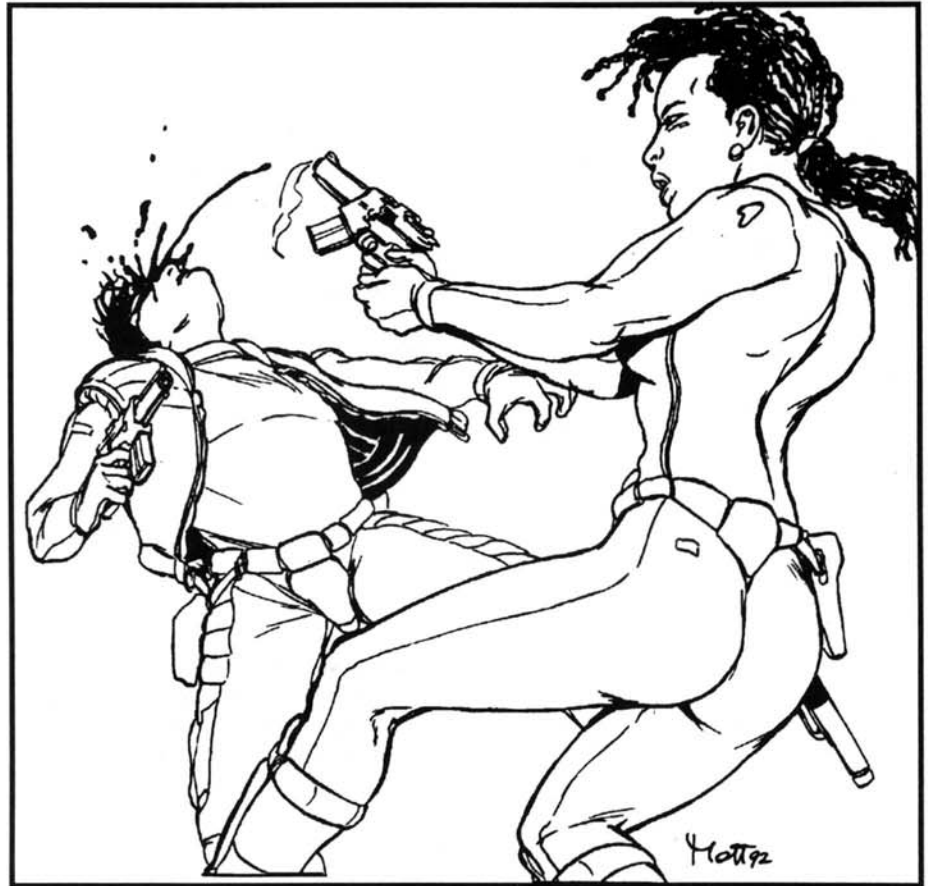

will act on purely moral grounds. If they help the colonists they can certainly expect a strong position in the new hierarchy which must be built to replace the current administration. Building a new life at Isidis may be highly preferable to returning to the muck-ridden violence of Earth. Regardless of whether the characters have become involved with the rebels or not, they will mount their attempt three weeks later. This can have several results:

1) The characters have helped to set the workgangers up and the revolt fails. The ESA uses a decided amount of unnecessary force, killing or injuring many colonists in the process. The leaders are captured or killed and the colony restored to full control by the management board. The remaining ringleaders, including Palla and Erick, are deported back to Earth to face trial by the European courts.

2) The attack occurs without direct involvement by the characters.

3) The characters choose to aid the workgangers and set up ESA. In this case the characters' unique position as ESA moles provides them with an opportunity to gain access to the management wing, as well as extra weapons, and they can provide a substantial element of surprise for the colonists.

The colonists believe they can force the joint ESA and Soviet "benefactors" of the Isidis base to accede to their requests for overall decision making power of the base if they can assert control of four main sections of the colony. It should be remembered that virtually all facilities within the colony are duplicated to ensure continual operation in the case of a disaster in one sector.

Sherie Phils Revisited

The same ROLE, SKILLS, CYBERWARE, and OUTFIT as before. (See page 112).

Programs loaded:

Balron (MU5, Str5): Worm, Krash, Hammer Wizard's Book (all at -4 to deck speed)

Hellbolt (MU4, Str4)

SeeYa (MU1, Str3)

Invisibility (MU1, Str3)

Armor (MU2, Str4)

Killer VI (MU5, Str6)

COMMENTS: Dressed to kill.

Sherie will use everything in her kit without reservation and, if forced out of the net, will jack back in and keep trying. She has a reserve Elysia II (standard) cyber-modem and backup copies of all programs ready if necessary. Sherie came all the way from Earth for this run and she intends to make it, or die trying.

• Atmospheric processing plant

Situated in the lowest levels of the base there are two separate plants which recycle all air, water and waste products from the colony for re-use. They maintain the atmospheric conditions in all portions of the colony. It is possible to alter atmospheric conditions in various parts of the colony from this facility, although sections of the colony cannot be sealed off, as manual overrides exist on all internal doors for safety reasons.

These plants are easy targets for the colonists as they are manned primarily by colonists (workgangers) and can be sealed off and defended by a relatively small force.

• Power Generation Facilities

Isidis Base is provided power via solar cell arrays, backed up by two nuclear fission generators located 1km on each side of the main base. These stations are automated and are run entirely by independent AI's without human intervention. Gaining direct access to the generation facilities is virtually impossible. The distribution of power within the colony is controlled through a room located near the atmospheric processing facilities. Power distribution to the colony is also computer-managed. The room is accessible by maintenance crews and usually manned by two technicians.

Disrupting power supply to any portion of the base can have a disastrous affect on the operation of the entire facility and the colonists are unlikely to tamper with this facility except as a last resort.

• Communications

The main communications headquarters for the colony is situated centrally within the management wing and is a difficult target. The second facility lies in a joint section of the colony and is generally guarded by a single guard. Due to growing

concern that a revolt may occur two guards have been posted at this location and both are lightly armored and armed with flechette pistols.

The colonists hope that capturing this facility will allow them access to incoming and outgoing communications facilities. The communications rooms can be shutdown from the power distribution facilities and via the main computers.

• Computer Facilities

The hub of the colony is the base computer installations, which provide daily management of virtually all support systems within the colony. These facilities are located within the management section of the base and are protected by both armed personnel and automated security systems. Most other facilities within the base can be controlled and disabled directly via the base computers and, without gaining control of these facilities, any revolt within the base is destined to fail.

The main force of the colonists' attack will be aimed at gaining access to the computer facilities and thus essentially gaining control of the entire base. It is here that any serious combat will take place and that both the colonists and management forces will be willing to use force to gain their objective.

DOWNTIME

At 7:00pm Sherie Phils (see new sidebar), guarded by the two solos who accompanied her from Earth, begins a Net run against the colony computer system from a cross-wired high security line. Sherie has been smuggled into the base and is backed up by a second Netrunner, a workganger named Robert Saler. They are both concealed in a ventilation duct in the lower portions of the base and it is virtually impossible to physically locate them. Sherie has recently upgraded both her cyberdeck and software and is making a

last ditch attempt to disrupt the security monitoring and control portions of the base computer systems as the majority of the workangers position themselves to overrun base security forces.

If the characters' own Netrunner attempts to block Sherie from her objectives in the Net he tracks her down to be faced with the following events. Read the following:

Far ahead of you within the maze of the outer defenses you see another 'runner, a familiar figure who is one of the sysops. Suddenly the runner pauses and activates a program. In front of him a huge metallic skeleton appears dressed in black robes and wearing a blackened crown. Though you may never have seen a Liche program, you have heard many stories of its strength and the horrible affect it has on its victims. There is a flicker of energy and a third figure appears. This figure's ICON is a slender woman dressed in a dancing gown of flames and holding a vast scimitar in one hand. The skeleton reaches toward the woman with a hideous laugh but is struck full on by the figure's sword and, with a cry, dissolves into a rotting pile of flesh.

Without pausing the woman holds out her hand and you see a bolt of crimson energy flare from her palm and strike the startled sysop, who reels backwards. A second bolt of fire lances out toward the hapless 'runner, who cries out in agony and then vanishes—you cannot be sure whether he has jacked out or been rendered unconscious, or even killed.

There is a flicker and the woman fades from view.

The character may well choose to tackle Sherie. Of course he still doesn't know that Sherie is backed up by Robert, who is just behind her in the Net. The two invading Netrunners will attempt to ditch any pursuit and push their way into the central pro-

cessor sections, where Sherie intends to selectively disrupt the security processors. If the character closes and appears to be overcoming Sherie then Robert will move in and attempt to stall the character while Sherie proceeds.

MOVING IN

While Sherie begins her Net run there is a different kind of activity occurring far above her in the upper levels of the base. Almost the entire population of workangers, many armed with knives or flechette pistols, have moved to pre-determined locations around the base and are preparing to overrun the security forces. Sherie has five minutes leeway to attempt to disrupt at least some of the security systems before the colonists move in, regardless of her success or failure.

The initial attack begins as colonists, armed with tasers, overcome several security guards posted at the main access to the management wing while others secure the atmospheric and power distribution facilities. Depending on Sherie's success, and her encounters with the characters within the Net, they may be provided with a delay before any alarm is raised. The colonists also move to seal off the auxiliary communication room and to block access through all airlocks within the colonists' portion of the base to stop security forces entering from outside.

Three small groups of colonists are also converging on the computer facility via the ventilation ducts, hoping that they may be able to gain access through the ventilation system and overpower any guards installed inside the computer facility itself. Two similar groups are crawling toward the security control center and all five parties should reach their destinations just as the deadline on Sherie's efforts expires.

As a small force of angry colonists storm the management wing and

Robert Saler

ROLE:NETRUNNER
INT 7, REF 7, COOL 6, MA 7,
BODY 6, ATT 8, TECH 6, EMP 5

SKILLS:

Interface +3, Awareness +3,
System Knowledge +3

CYBERNETICS: Chipware Socket
and Processor.

OUTFIT: Zetatech 7710 cyber-
modem, Speed +4, Memory
20mu, Data Walls +4

Programs loaded:Balron
(MUS,Str5): Flatline, Hellbolt (both at -2 to deck speed)
Flatline (MU2,Str3)
Hellbolt (MU4,Str4)
Reflector (MU2,Str5)
SeeYa (MU1,Str3)
Invisibility (MU1,Str3)
Armor (MU2,Str4)

COMMENTS: Robert is a workganger who has built up substantial Netrunning experience. He is not sufficiently capable of attempting the base run himself but will shadow Sherie and help defend her from other Netrunners and defensive programs where possible.



ESA Guard

ROLE: SOLO

INT 5, REF 7, COOL 6, MA 5, BODY 7,
ATT 4, TECH 2, EMP 3, LUCK 4

SKILLS:

Combat Sense +4, Awareness +2, Zero-G Maneuver +5, Zero-G Combat +3, EVA +4, Space Survival +3, Handgun +3, Athletics +2, Intimidate +1

CYBERWARE: Cyberoptic with Anti-dazzle and Targeting; Pain Editor; Chipware Socket; Basic Processor with Smartgun link and Kerenzikov Boost +1

OUTFIT: Uniform, Armor vest (SP 10), Standard Spacesuit, Silver Shadow flechette pistol or H&K P-11 rocket pistol (P 0 J P 4D6/6mm Rkt 5 1 VR—treat as gyrojet, see *Eurosource*, pg.74 for details), Breather set, Hands-free Comset.

push downward toward the computer nerve-center, alarms begin ringing at security central. The management have been expecting this action from the colonists for some time and are already well prepared. Once an alarm is given the various sections of the management wing will be isolated within thirty seconds and control facilities, including the auxiliary communications center and power distribution rooms, will be disabled. Forrin and his colleagues see no reason for the security forces to directly engage the colonists in conflict unless absolutely necessary - in most cases they will simply seal the intermediate doors, preventing further access into the management wing, and wait for the colonists to give up. As long as the management board maintains control of the main communications facility, computer installations and security control center, the colonists can gain little ground.

If all goes according to Forrin's plan then:

The colonists soon find themselves sealed in various portions of the colony unable to continue forward, and unable to return. Key areas such as the atmospheric processing plant and power control room are protected by security-controlled lasers and colonists attempting to hold these positions against the management board are advised to leave immediately as hidden wall sections slide back to reveal the daunting glint of a laser barrel targeting their movements. The lasers will be used if necessary.

The colonists edging through the ventilation shafts soon discover that reinforced grills have been inserted in all access shafts. They cannot be cut without heavy duty equipment and a substantial delay. As they are debating their next moves, security forces appear behind them and quickly overpower the small resistance they can mount.

In the Net Sherie may reach the processor core. However, she will be met here by two Interpol-trained Netrunners toting ultra-modern cyber-decks and an array of lethal black-IC. These 'runners will ensure neither Sherie nor Robert can jack out (using Glue and Jack Attack). Robert, who is clearly less capable, will simply be fried using a Firestarter while Sherie watches, helpless. The 'runners will then turn on Sherie, who screams in agony as a Liche rips away her forebrain, implanting a controlled personality in its place and leaving her a simple-minded idiot.

There are only two scenarios in which the colonists could succeed, both requiring the help (rather than hindrance) of the characters:

- 1) Sherie reaches the central processing core of the security systems backed by one or more Netrunning characters and begins opening doors and disabling security lasers within the various sections of the colony. The support of at least one extra Netrunner should be sufficient to put the advantage on Sherie's side and allow them to defeat the Isis Icemen.
- 2) The characters use their position with the ESA to get inside the management wing during, or just before, the revolt begins and aid the colonists in gaining access to the computer rooms. They can also help to implant false information with Forrin about when the disturbance will occur and who the major players will be. The more confusion generated the more likely the activity has to succeed.

Since neither of these options is really likely to occur, it is probable that the colonists' revolt will fail and its leaders will be arrested and deported to Earth. The characters must now bide their time until the contract expires. Of course there are several workgangers who are extremely sus-

ISIDIS NET AND KEY

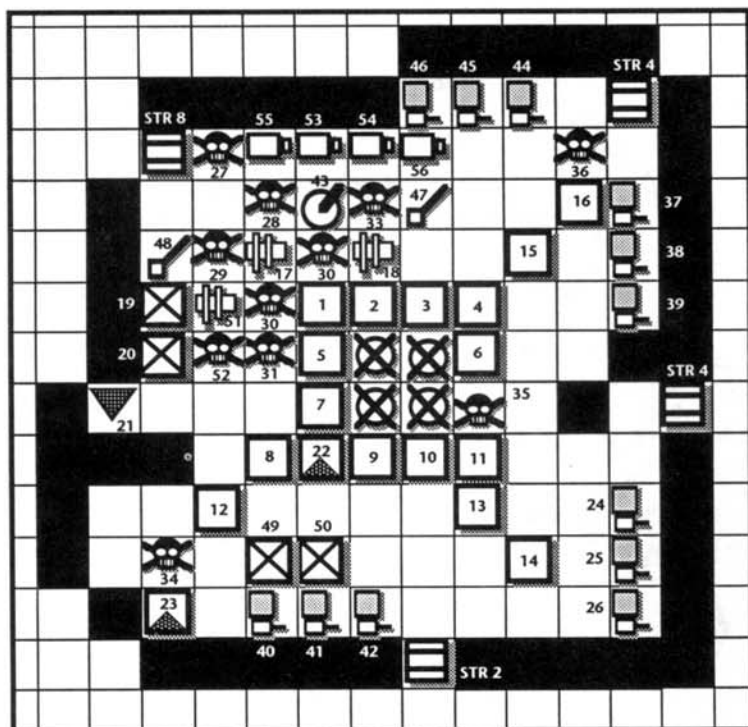

ISIDIS MAIN SYSTEM NET KEY

4 CPU, INT 12, DATA WALL STR 6

USUALLY ONE SYSOP ON DUTY AT ALL TIMES

Intellectual AI, observational reactions, geometric ICON

1] Confidential correspondence

[file lock STR 4] 10MU

2] Security files [file lock STR 4] 10MU

3] Admin records 10MU

4] Traffic and Commerce records 10MU

5] Project: ADAPT and related material [file lock STR 6]

10MU

6] Traffic and Commerce records 10MU

7] Admin records 10MU

8] Construction and Vehicle logs 10MU

9] Admin records 10MU

10] Reserve MU storage 10MU

11] Scientific research files 10MU

12] Scientific research files 10MU

13] Virtual study/research SIM 8MU

14] 3 Virtual teaching SIMs 4,4,2MU

15] Scientific research files 10MU

16] Scientific research files 10MU

17] Air recycling plant controls

18] Water recycling plant controls

19] Videoboard for space traffic control

20] Videoboard for space traffic control

21] Holo display for space traffic control

22] Long Distance Link to Paradise Station

23] Long Distance Link to Chryse Base

24] Colonist workstations

25] Colonist workstations

26] Colonist workstations

27] Bloodhound

28] Flatline

29] Knockout

30] Knockout

31] Stun

32] Flatline

33] Wolf (*ChromeBook 1*, pg.91)34] Guard-Dog (*ChromeBook 1*, pg.91)

35] Wolf

36] Guard-Dog

37] Colonist workstations

38] Colonist workstations

39] Colonist workstations

40] Colonist workstations

41] Colonist workstations

42] Colonist workstations

43] Admin Block alarms

44] Admin workstations

45] Admin workstations

46] Admin workstations

47] Primary airtight access doors to ESA wing

48] Primary airtight access doors to ESA wing

49] Videoboard in common areas

50] Videoboard in common areas

51] Power plant monitoring and power distribution

52] Knockout

53] Surveillance cameras in common areas

54] Surveillance cameras in common areas

55] Surveillance cameras in lab/manufacturing areas

56] Surveillance cameras in lab/manufacturing areas

picious of their role in the failure of the rebellion and the characters may find life in the colony becoming increasingly unpleasant for them as time passes.

If the rebellion is crushed by the ESA but the characters have failed to warn their employers, then they discover their contract has suddenly elapsed and they are arrested and

dumped unceremoniously at Chryse Base to fend for themselves until they can find a way to return to Earth. Maybe now they wish they had helped the colonists ?

Of course, if the colonists do succeed, it will be partly due to support from the characters and they will be welcome to stay if they wish to help build a brave new world

ESA Security Officer

ROLE: SOLO

INT 6, REF 8, COOL 7, MA 7, BODY 6, ATT 5, TECH 5, EMP 3, LUCK 4

SKILLS: Combat Sense +5, Awareness +4, Zero-G Maneuver +5, Zero-G Combat +4, EVA +4, Stealth +4, Space Survival +3, Handgun +3, Electronics +2, Intimidate +3

CYBERNETICS: Cyberoptic with Anti-dazzle, Targeting, and IR; Chipware Socket; Basic Processor with Smartgun link and Kerezikov Boost +1; Adrenal Booster

OUTFIT: Same outfit as guards; change Armor vest to hidden Kevlar T (8 SP), add Dynatech Hand Taser. Access to any rovers, buggies, or hoppers needed.

ESA/Netwatch Security Runner

ROLE: NETRUNNER

INT 8, REF 7, COOL 6, MA 5, BODY 6, ATT 5, TECH 7, EMP 5

SKILLS: Interface +4 or +5, Awareness +4, System Knowledge +4 (Mars specific), Programming +6

CYBERNETICS: Chipware Socket and Processor.

OUTFIT: EBM 7-0 cybermodem; Speed +5, Memory 20mu, Data Walls +7

Programs Loaded: GM's choice, depending on how nasty he wants to be, but definitely Glue, Jack Attack, and Firestarter.

ISIDIS BASE MAP

Road and Landlines to Reactor #2

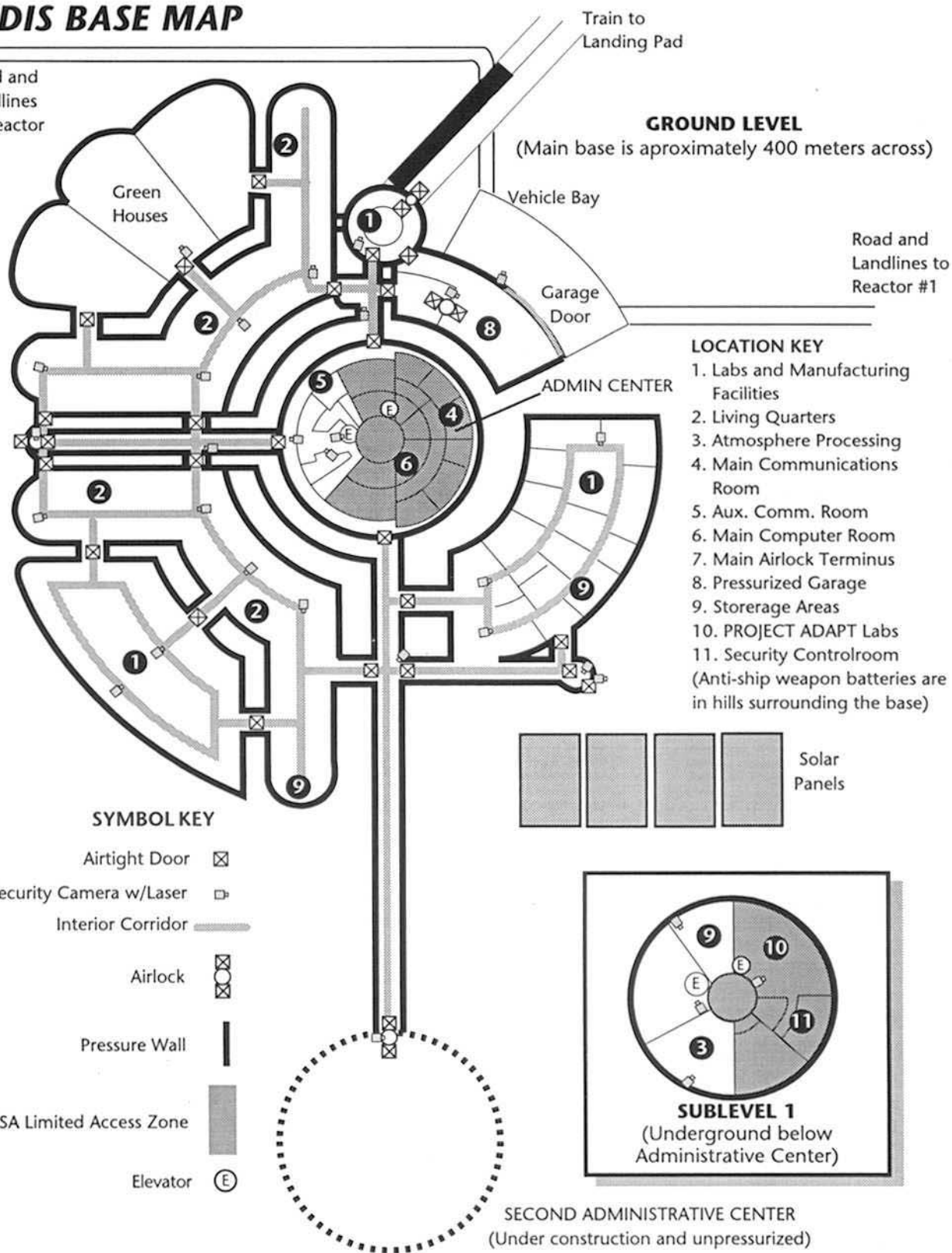

SELECTED REFERENCES

- 1) The New Solar System
J. Kelly Beatty and Andrew Chaiken (Editors)
Cambridge University Press / Sky Publishing
Third Edition (1990)
- 2) Pioneering The Space Frontier (The Report of the National Commission on Space)
Bantam (1986)
- 3) The Science in Science Fiction
Peter Nicholls (Ed)
Michael Joseph (1982)
- 4) Cosmos
Carl Sagan
Macdonald (1981)
- 5) Space Travellers Handbook
Michael Freeman
Golden Press (1979)
- 6) The Road to the Stars
Ian Nicolson
Cassel Australia Limited (1978)
- 7) Engines of Creation: The coming era of Nanotechnology by K. Eric Drexler
Anchor Press/Doubleday (1990)
- 8) Space Weapons
Frank Barnaby
Gallery Books (1984)
- 9) The Encyclopedia of Space
Nicholas Booth
Mallard Press (1990)
- 10) Space Almanac
Anthony R. Curtis
Arcsoft Publishers (1990)
- 11) An Illustrated Guide to Space Warfare
David Hobbs
Simon & Schuster (1986)
- 12) Foundations of Astronomy
Michael Seeds
Wadsworth Publishing Co. (1990)
- 13) Introduction to Space Dynamics
William Tyrell Thomson
Dover Publications, Inc. (1986)
- 14) Selected issues of *Scientific American* magazine
1977-1979, 1985-1988, 1990-1992
- 15) Selected issues of *Sky & Telescope* magazine
1987, 1989-1990
- 16) Selected issues of *Final Frontier* magazine
1988-1992

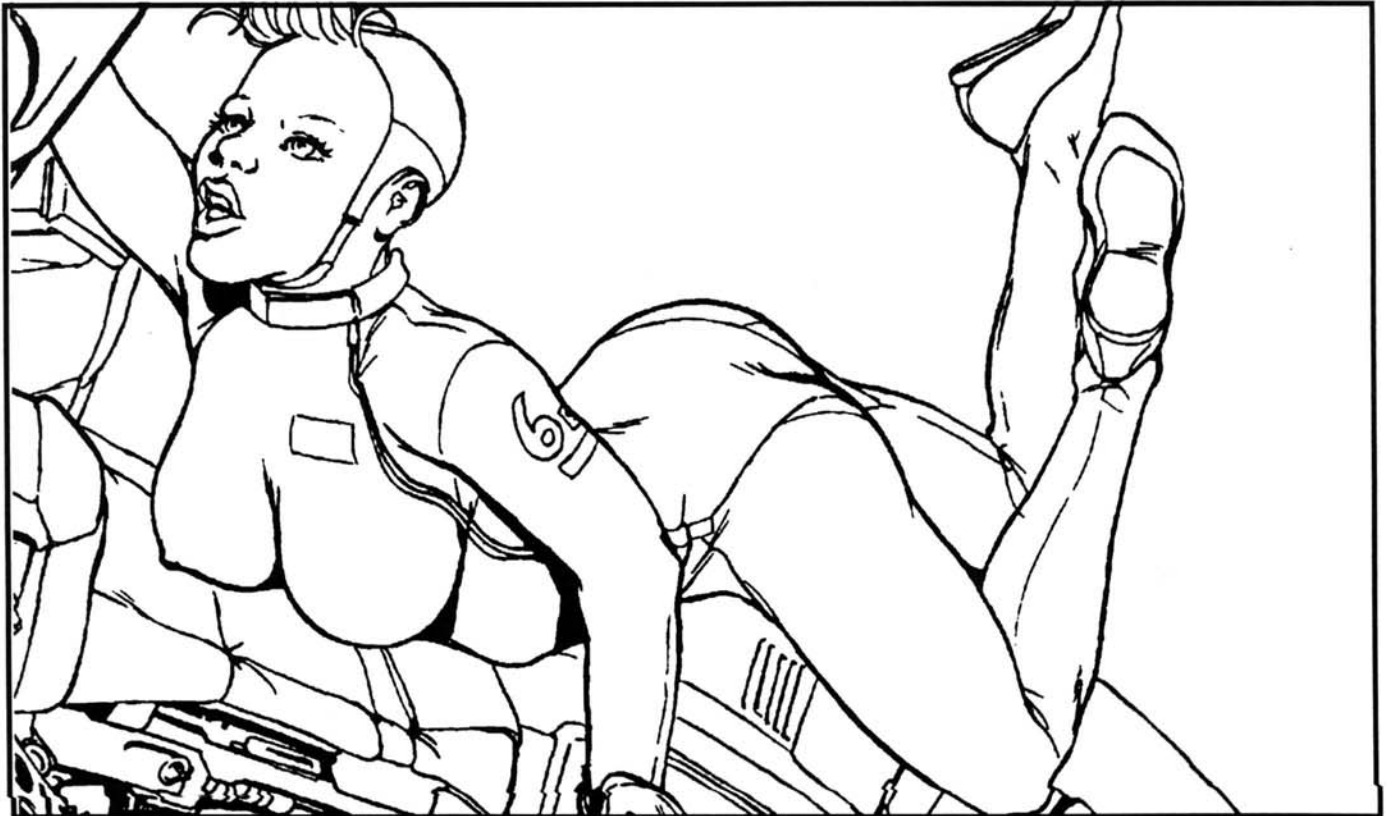

CYBERPUNK GENERATION

THE TIME FOR CHANGE IS NOW: EVOLVE OR DIE

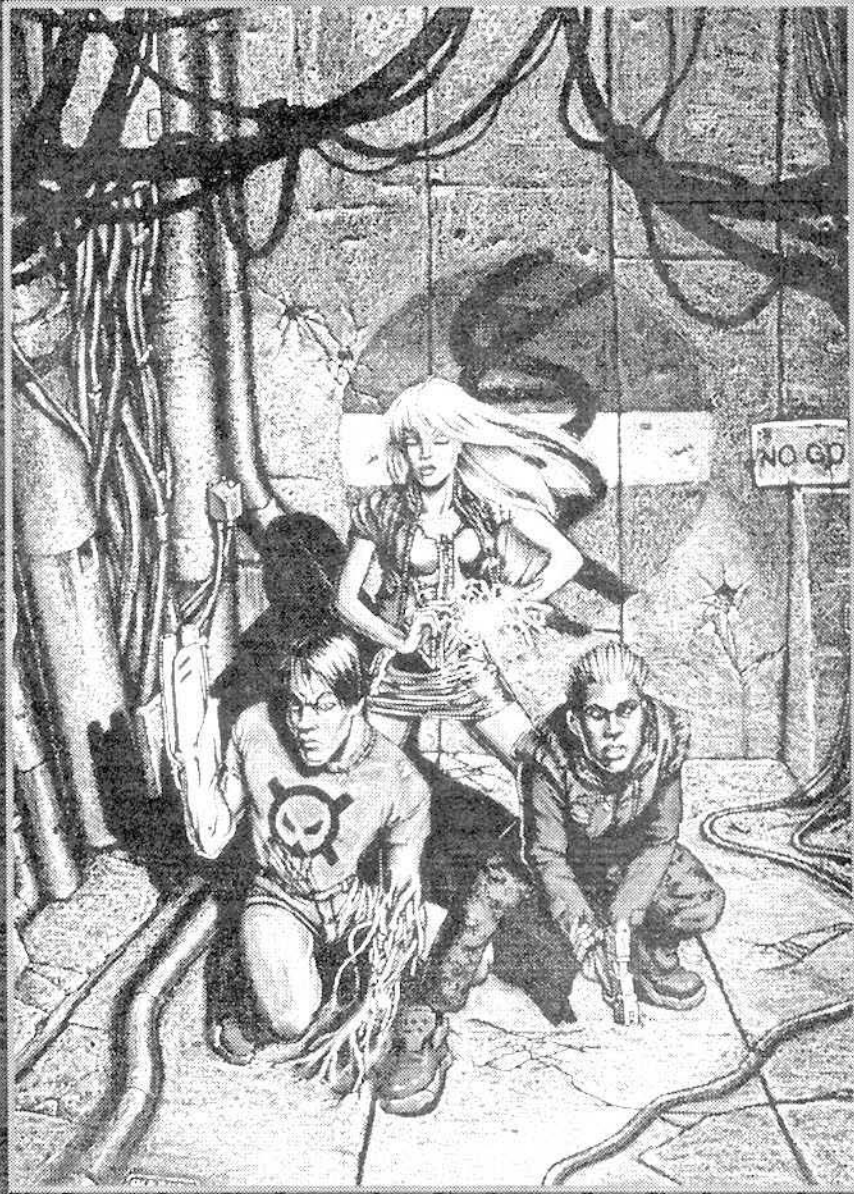

THE BATTLE FOR THE CYBERPUNK® WORLD BEGINS HERE

BEYOND THE EDGE

The Earth turns silently below, a ball of seething humanity, trapped in an ever-more polluted environment. Meanwhile, desperate Edgerunners battle greedy Corps for what "good" living is left. Mankind has only one place left to go...up...and out.

Out to a place of absolute cold and perfect clarity, where immense cylinder worlds spin in the sky; needle-like deltas speed on intercept courses, and spidery orbital vehicles surround the titanic white lattices of the Far Planetary explorers.

Humanity is reaching—for Deep Space.

Enter the Future of *Cyberpunk* with **Deep Space**, the continuation of the *Near Orbit* saga. The timeline has been extended to 2025 as the first generations of Highriders struggle for freedom from groundsider control. Lunar colonies are the norm, and the skies are crowded with corporations jockeying for position on this new economic frontier. At the same time, government and private enterprise take their first steps on Mars and into the Belt, in search of knowledge and resources. And what will new missions find inside the Gas Giants?

Deep Space expands *Near Orbit's* vehicle/equipment lists and contains maps of the Tycho/Copernicus Lunar colonies along with Mars' Chryse Base. As a bonus, we include the adventure **Red Conflict**—unrest among the scientific stations of Mars!

Let your *Cyberpunk 2020* campaign break the shackles of Earth, and reach for the unknown with...

DEEP SPACE

CONTAINS ALL PREVIOUS MATERIAL AND COMPLETELY REPLACES THE ORIGINAL NEAR ORBIT!

CP 3211

ISBN # 0-937279-35-8



A CYBERPUNK SOURCEBOOK

**R. TALSORIAN
GAMES, INC.**

Copyright © 1993 R. Talsorian Games All Rights Reserved. Cyberpunk® is R. Talsorian's trademark name for its adventure game of the dark future. Deep Space and Near Orbit are trademarks of R. Talsorian Games Inc. All Rights Reserved. All incidents, situations, and persons portrayed within are fictional, and any similarity, without satiric intent, of characters living or dead is strictly coincidental.