

CHROME

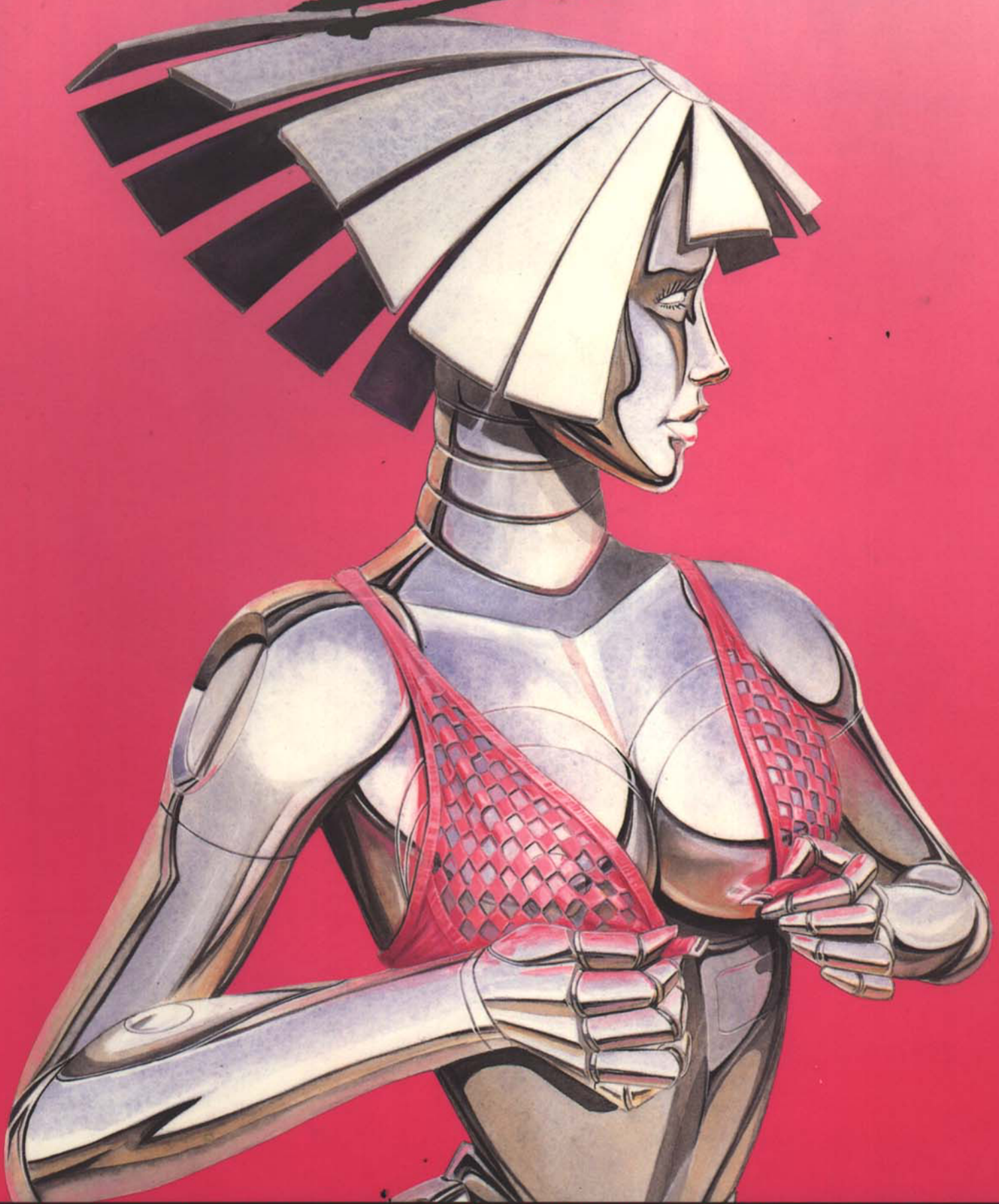

WEAPONS • ARMOR • CYBERWARE • FASHION • VEHICLES • CHIPWEAR

A SUPPLEMENT FOR

CYBERPUNK

R. TALSORIAN
GAMES, INC.

CHROME

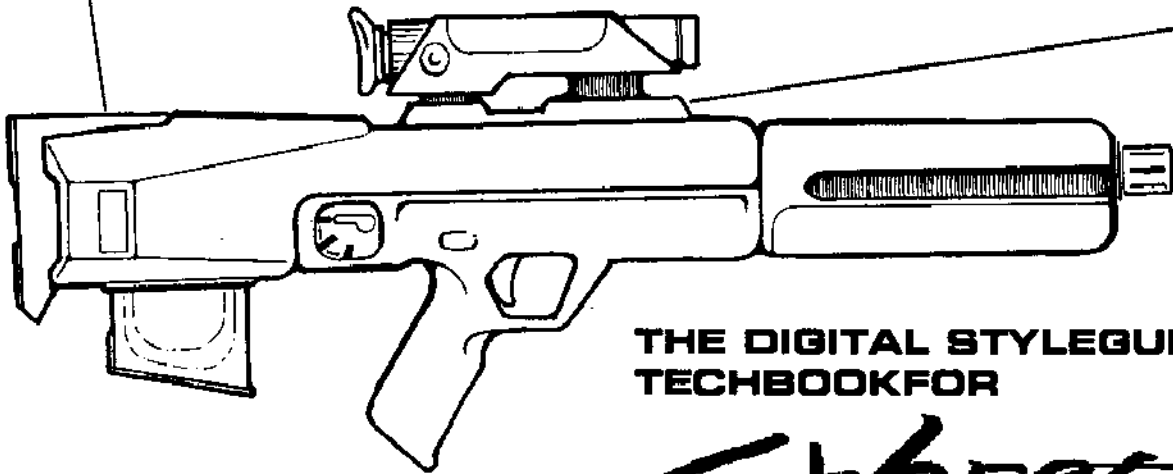
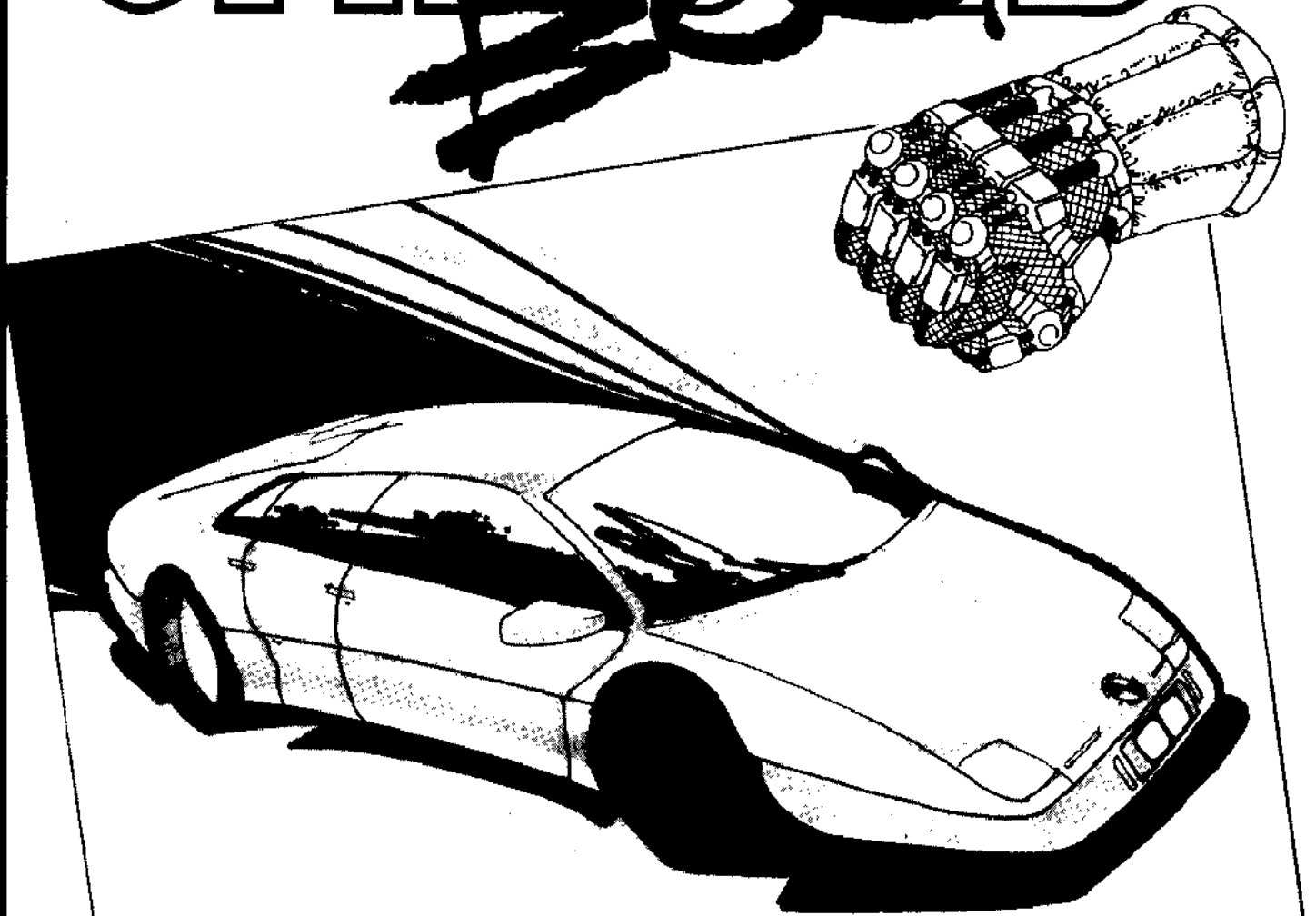

THE DIGITAL STYLEGUIDE AND
TECHBOOK FOR

CYBERPUNK

2 0 2 0

INTRODUCTION

IF YOU'RE *CYBERPUNK*, YOU'RE GONNA LOVE THIS BOOK.

I KNOW I DO. IT'S GOT ALL THOSE THINGS I NEED WHEN I DO A *CYBERPUNK*® RUN; GADGETS, GEAR, NIFTY LOCATIONS AND SLICK NEW TOYS. IN SHORT, THE NON-ESSENTIAL NECESSITIES—CHROME—FOR A GOOD *CYBERPUNK*® GAME.

THE **PERSONAL ELECTRONICS** SECTION STARTS YOU OFF WITH A BANG: LOTS OF GADGETS THAT PLAYERS ALWAYS IGNORE UNTIL THAT MOMENT WHEN ONLY A LEFT-HANDED WRENCH WILL DO THE JOB. THE **VEHICLE** SECTION'S SET UP TO GIVE A REFEREE AN OVERVIEW OF A WIDE VARIETY OF 2020 MOVEWARE; NOW YOU'LL KNOW WHAT A NOMAD RIDES AND WHAT A BOOSTER GANG CAN MUSTER AGAINST A POLICE BARRICADE.

CHECK OUT THE **HOUSING SECTION** FOR IDEAS ON LIVING CONDITIONS IN 2020. WHETHER YOU NEED A LUXURY PENTHOUSE WHERE THE PC'S CAN MEET THEIR CORP CONNECTION, OR A SLEAZY COFFIN-HOTEL AS THE BACKDROP TO A DRUG DEAL, YOU'LL FIND IT HERE. JUST FOR FUN, WE'VE ALSO ADDED **EXECUTIVE SERVICES**; THE PEOPLE WHO GET THINGS DONE FOR YOUR *CYBERPUNKS* (AND INCIDENTLY PROVIDE THEM WITH ALL KINDS OF ADVENTURE HOOKS!) LASTLY, THE **COLOR FASHION SECTION** GIVES YOU THE LOWDOWN ON WHO WEARS WHAT AND WHAT'S TRULY SUPERCHILLED THIS YEAR.

OF COURSE, WE'VE ADDED LOTS AND LOTS OF FUN AND DEADLY **WEAPONS** FOR YOUR SOLDS TO PLAY WITH, AS WELL AS NEW **CYBERWARE** AND **CHIPWARE** FOR EVERYONE. THERE'S EVEN SOME NEW (AND NASTY) **SOFTWARE** FOR THE NETRUNNERS. SO WHATEVER YOUR *CYBERPUNK*® GAME' IS LIKE, YOU'LL FIND AT LEAST TWO DOZEN THINGS HERE THAT YOU'LL WANT TO USE.

CHECK IT OUT. LIKE I SAID, YOU'RE GONNA LOVE THIS BOOK.



**R. TALSORIAN
GAMES, INC.**

PUBLISHED BY R. TALSORIAN GAMES
P.O. BOX 7356, BERKELEY, CA. 94707
COPYRIGHT ©1991 BY R. TALSORIAN GAMES, INC.
CYBERPUNK® & *CHROMESBOOK*™ ARE TRADEMARKS OF
R. TALSORIAN GAMES, INC. ALL RIGHTS RESERVED.

CONTENTS

ELECTRONICS & MISCELLANEOUS	3-16
VEHICLES	17-28
CYBERWARE	30-40
WEAPONS	41-55
FASHION	56-64
EXECUTIVE SERVICES	65-71
CHIPWARE	72-78
HOUSING	77-89
SOFTWARE	90-92
PRICE LIST & INDEX	93-98

CONTRIBUTORS

C-CYBERWEAR G-GADGETS S-SERVICES
H-HOUSING V-VEHICLES VR-VARIOUS
SW-SOFTWARE CH-CHIPWEAR W-WEAPONS
F-FASHION

COLIN FISK (S)
DAVE HARMER (G+C)
MIKE MASARATI (V)
MIKE POND SMITH (VR+SW+W)
DEREK QUINTANAR (VR+SW)
MIKE ROTOR (C+G+SW)
JOHN SMITH (W)
KEVIN STEIN (H)
WILLIAM TRACY (C)
KARL WU (F)
ANDREW STRASSMANN (C)
BEN WRIGHT (C+G)
JEFF HEXTER (C+G)
GLENN GODDARD (G)
MARCUS PREGENT (C)

ARTISTS

JUSTIN CHIN
SHON HOWELL
SCOTT RUGGELS
KARL WU (COLOR)
SANDY COLLORA
MIKE POND SMITH
BEN WRIGHT

LAYOUT & PRODUCTION

DESIGN BY TED TALSORIAN
LAYOUT: DIANA GOLDMAN, D. QUINTANAR
CUTOUTS BY MIKE MACDONALD
COVER BY MIKE EBERT, © 1990.
COVER DESIGN MIKE POND SMITH & MATT ANACLETO

EDITING

DEREK QUINTANAR, SENIOR EDITOR
WILL MOSS
COLIN FISK
MIKE POND SMITH

DEDICATED TO E4 MIKE FIERCE AND
THE MEN & WOMEN OF THE 602ND
MAINTENANCE COMPANY, U.S.
ARMY. ALWAYS *CYBERPUNK*.

ELECTRONICS

& Miscellaneous Techware

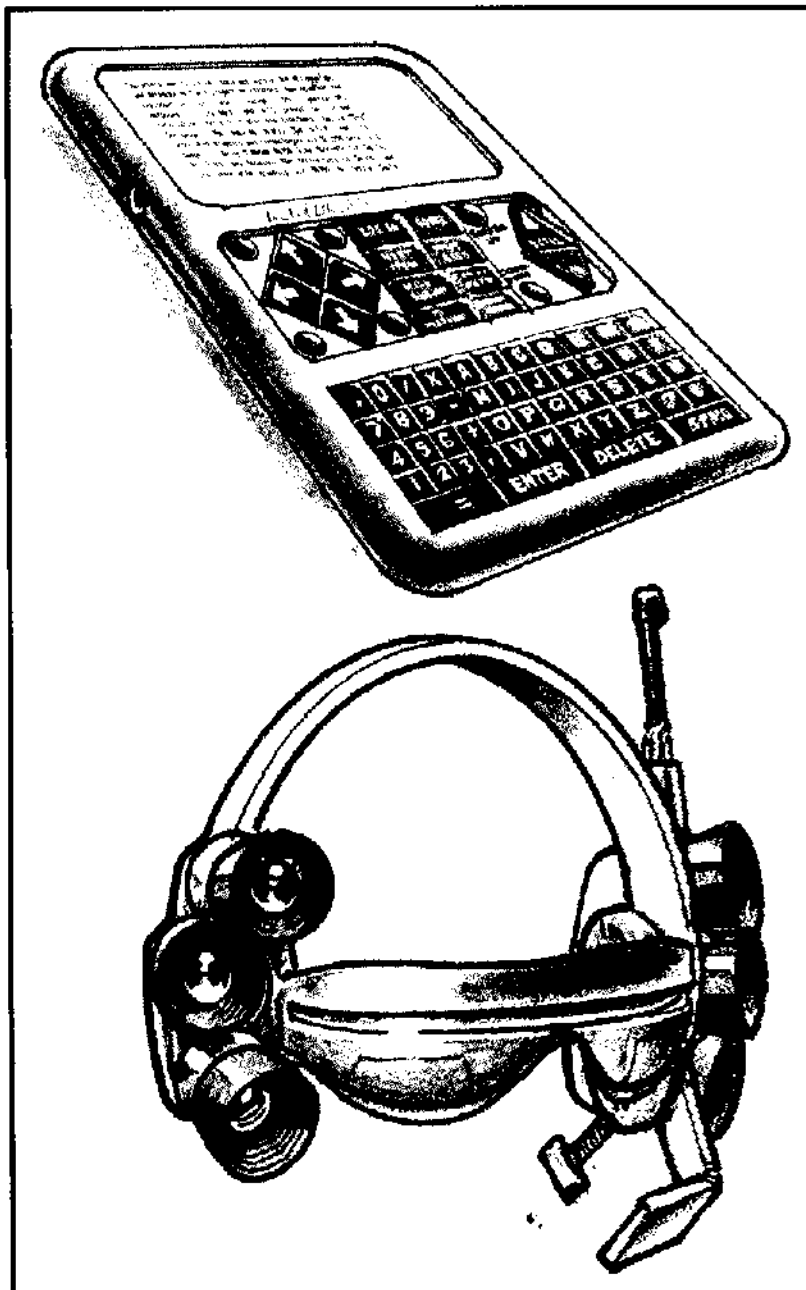

"Whether it's communications, security, information services or just plain entertainment, this year's Chromebook offers numerous personal equipment entries for the discerning cybernaut. If you're a Netrunner, make sure you interface with our new Utility Sneaksuit or Deck Security systems. For the Rockers, Telectronic's compact Digital Studio may be just what you've needed. There's digital weapon links and speedgear for the Solos, and Cybercam links for the Medias. And of course, Worldsat's integrated Office Commo system for the well-heeled Corporate..."

—The Chromebook download for January, 2020

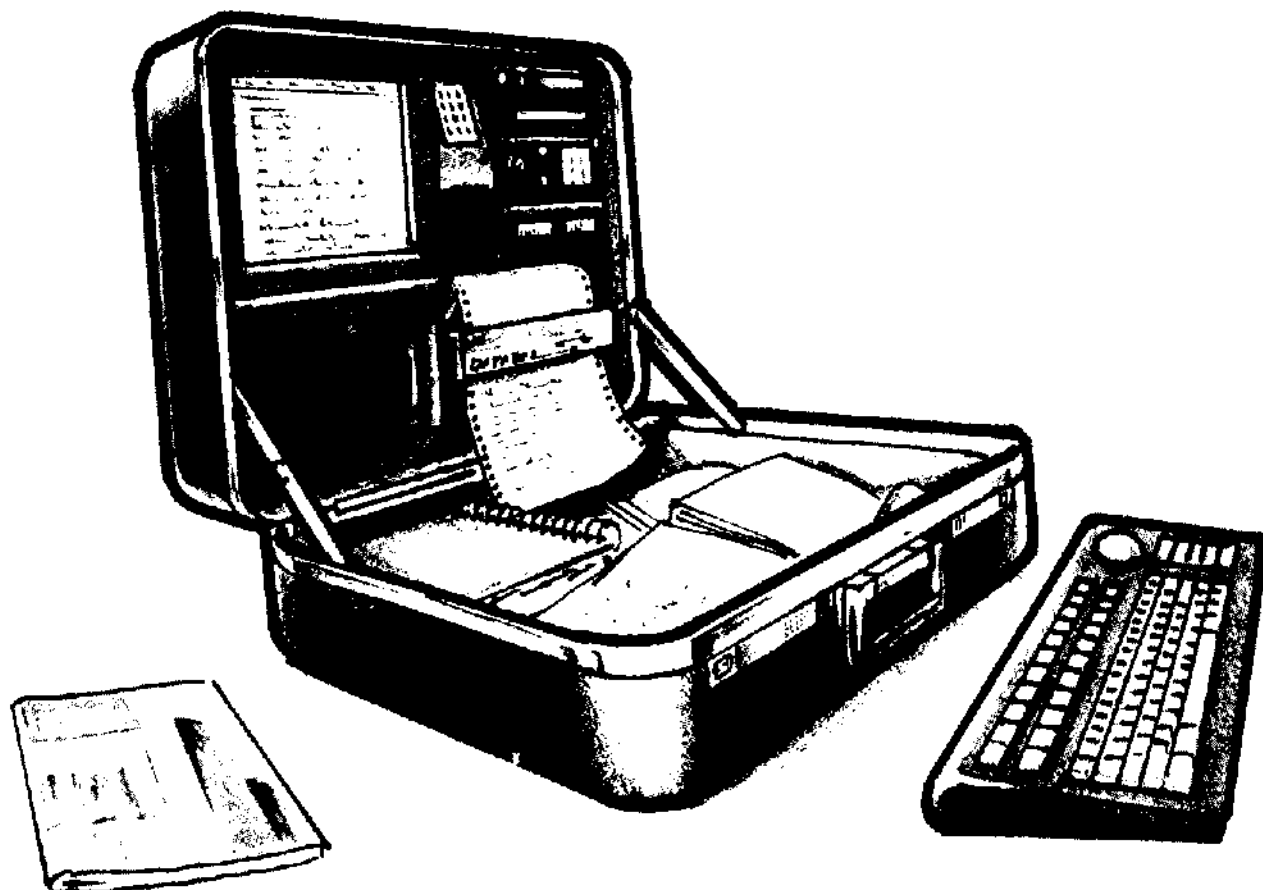

Advanced Communications Suitcase 800eb.

Keep in contact with your business!

Datatel's new Advanced Communications Suitcase has the equipment required to let you stay in touch anywhere in the world, or in orbit. This sophisticated system begins with a 48 MHz personal computer (See Laptop Computer, 'Punk 2020 equipment section.) with on-line memory and drive, linked to a plug-in portable Cybermodem (speed +2, 20MU, data walls +4, vidboard, chip reader). The system also includes a standard cellular phone, mini-fax, and optional short-wave capability (add 800eb. for short-wave radio).



TRITECH

Line Tap Detector 60eb.

Who's listening to your phone?

Tritech's inexpensive line tap detector measures changes in line impedance to inform you when anyone is listening in on your conversations. Green, yellow, and red lights tell you when the line is clear, monitored from an extension, or tapped. This device will not detect surveillance of cellular phones or fiber-optic networks.



TRITECH

Linozap™

350 eb.

Line Tapped? Now clear it!

Simply press the button on the unit and 50 Kv of electricity will fuse the circuits of any listening devices attached to the line. An isolated transformer protects your own phone from damage. Be totally sure your line is secure.

Warning: willful destruction of private property is a crime, and interfering with a legal tap is a felony. The Manufacturer does not condone any illegal activity or illegal usage of this device. Manufacturer assumes no liability for damage to phone lines from use of this product.

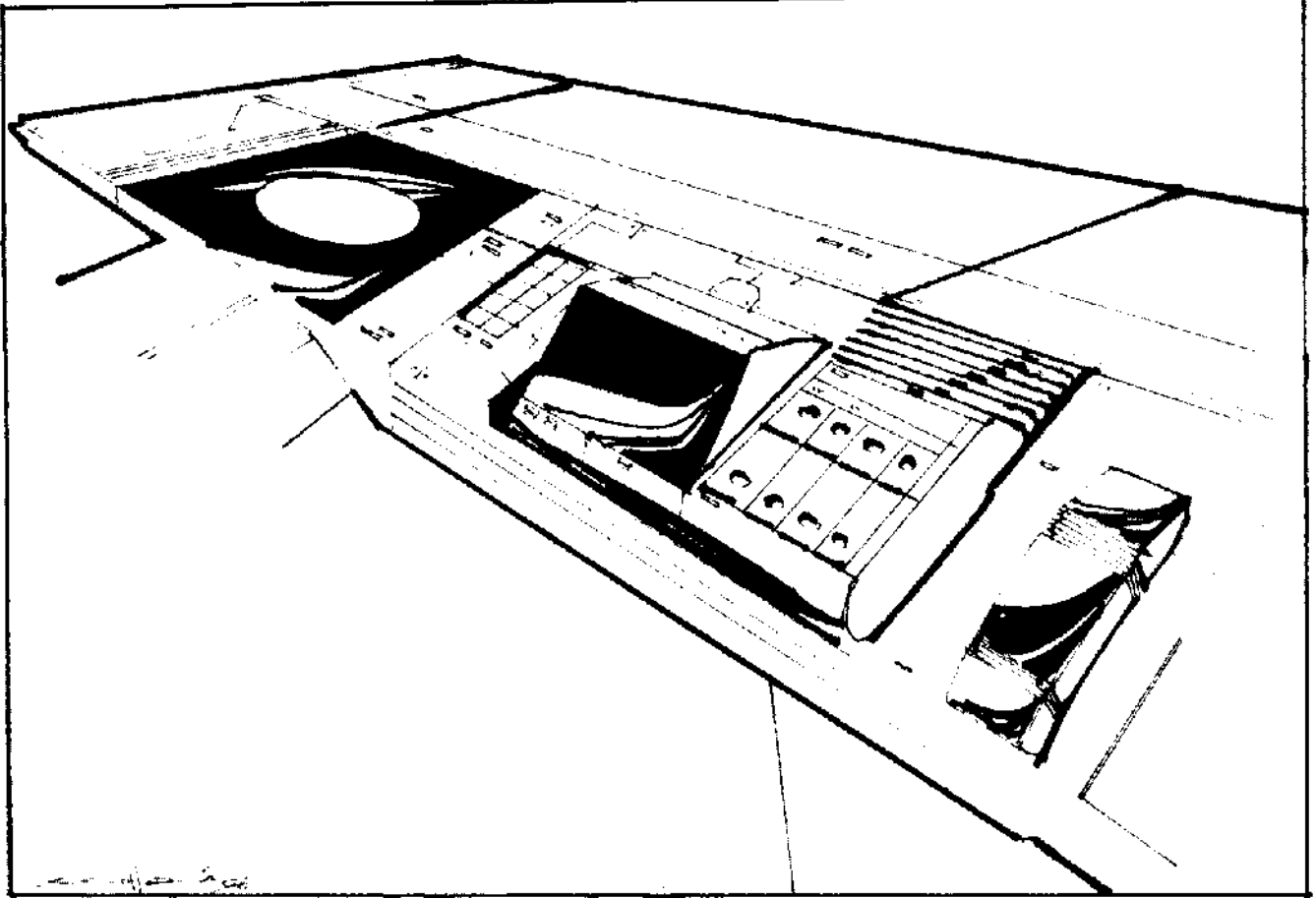

Office Communications Suite

1000eb.

The Ultimate In Corporate communications!

Worldsat's integrated Cellular Phone/Fax/Message Machine system allows the enterprising executive to handle and manage his communications easily and efficiently. The answering machine keeps you from missing those important calls with a beeperless remote, and has a remote fax alarm as well. A built-in switching device selects between fax and voice transmissions automatically, preventing the annoyance of hearing the fax tone when you pick up the phone. The cellular capability can be carried on a standard cellular account, providing access anywhere service is available. And the printed transmission report logs all fax calls with error checking, all voice calls including number called and connection time, and all incoming calls, whether fax or voice. The system can also include a video intercom for a low extra cost. Office vid system 1100eb. extra.



Cab Hailer

150eb.

Never be without a ride again!

Checker Systems Incorporated announces its new cellular Cab Hailer. Only 7cm x 5cm x 1cm, it is lightweight, convenient, and practical. Accepted in 36 member countries, the Cab Hailer automatically calls the nearest available cab to your location, ensuring prompt service. Simply plug the unit into any DataTerm outlet (found in airports and major hotels), and the local call numbers and frequencies are loaded into its memory. When you need a cab, simply lift the safety and press the call button. The closest vacant cab will promptly arrive (1D6 minutes) to carry you to your destination. Never worry about fumbling for change, either, as the Cab Hailer automatically processes billing for the fare, including the tip (itemized statement is sent to you each month). Additional activation charges: 10eb./month plus fares.

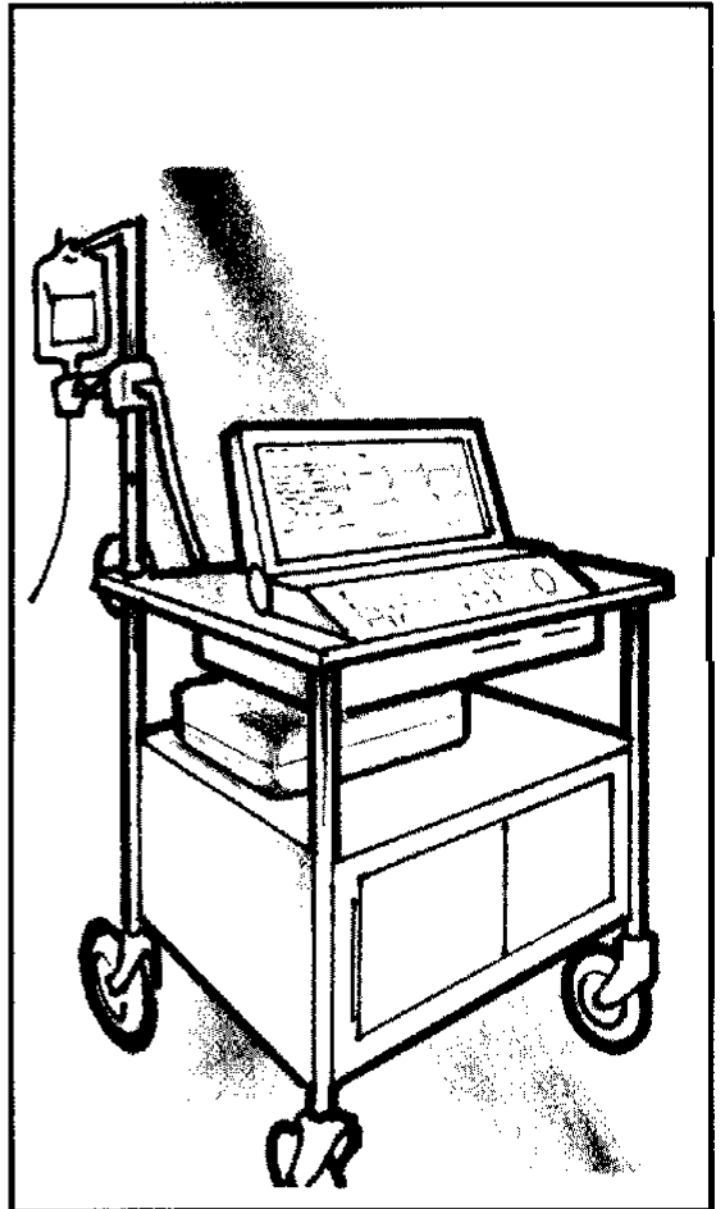
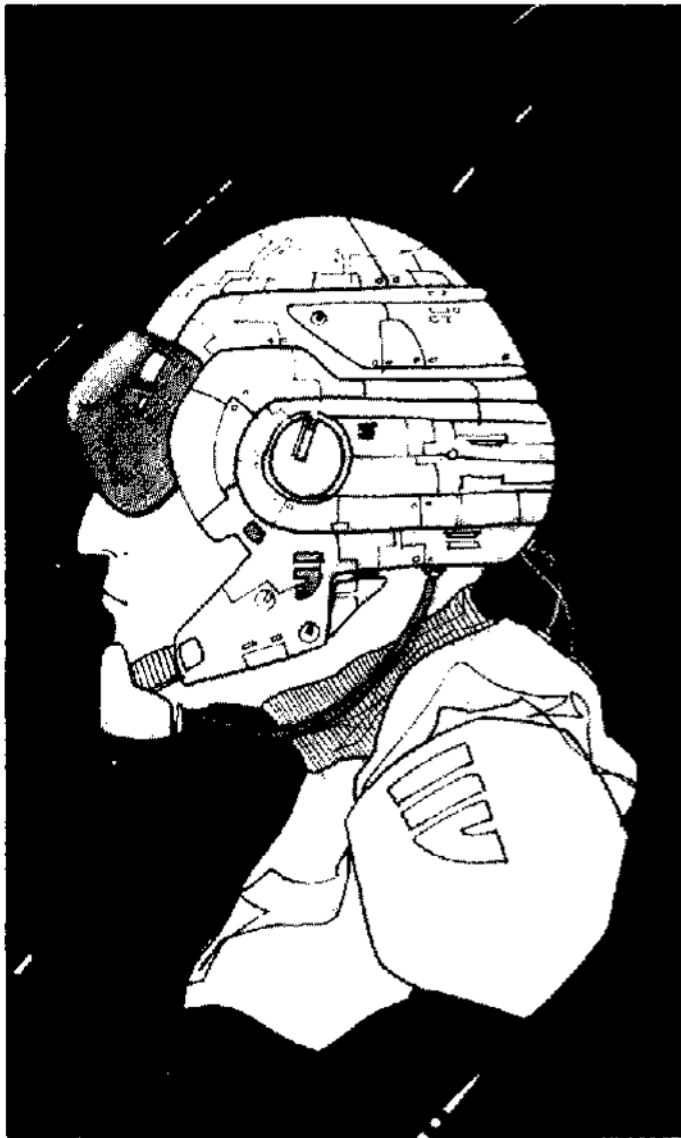

Microtech
HEADGEAR™ CYBERMODEM TECH

HEADGEAR™
Cybermodem Helmet
4100eb.

Elegance in form and function!

This injection-molded, impact-proof helmet (SP 16) houses a sophisticated cyberdeck complete with reflex-translators, neural interface jacks, and utility program drives. HEADGEAR™ also contains a heads-up info display and radiolink. Weight 4-4.75kg. See your Microtech dealer for further details. (Portable deck, MU 10, Speed +2, Data Walls +2).

BODYWEIGHT
 Life Preservation Systems

Life/Support®
500eb.

No long-runner should be without one!

The latest support option from Bodyweight. When this package is connected to a cyberdeck, a biomonitor watches the user's condition, controlling an IV drip for feeding and a catheter to take care of bodily functions. Such a system is relatively small (about the size of a PC monitor), and can keep the body going for approx. 72 hours of constant work within the Net. Weight 1.3-2kg.

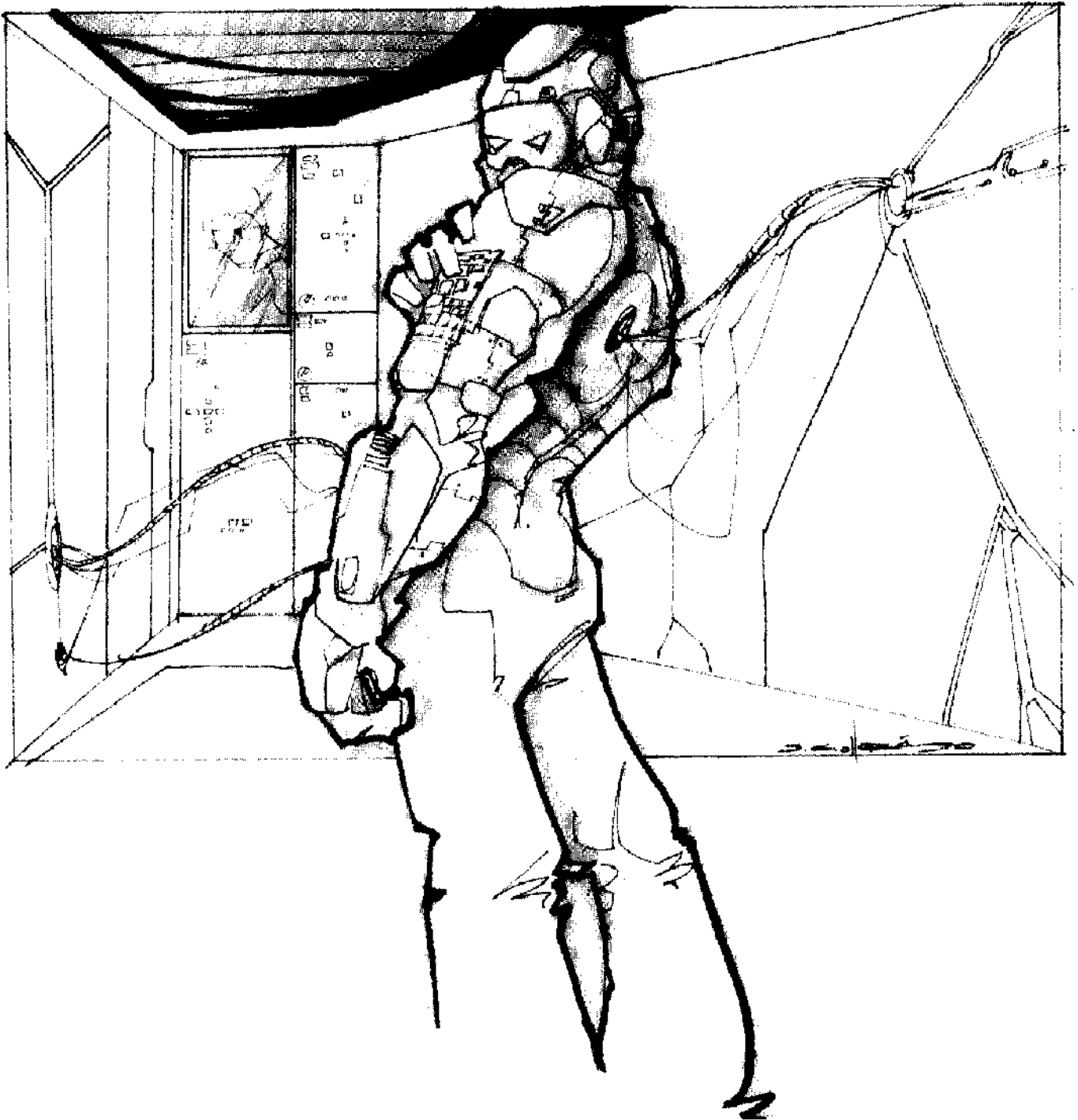

Net-Runner™ Cybermodem Utility Suit

6300eb. (Portable deck, MU 20, Speed +1, Data Walls +3),

7800eb. (Cellular deck and IR Sneaksuit options)

Walking simplicity with compact power!

A fully-functional, netrunning cybermodem system in a ready-for-action configuration. The collar houses the deck's reflex-translators and neural interface jacks. Control surfaces, a 20MU memory bank, and a keypad are located on armpacks, and utility/interface programs are loaded into a belt-mounted processor. All systems are connected by fiberoptic cables which run through the multi-ply kevlar bodysuit (SP 12, available in many styles, colors, and fabrics; including light-absorbent, IR-reducing sneaksuit weave). A biomonitor and wide-band radio commlink are included in the package. Very popular with assault-programmers and commandos. Weight 3.25kg.

Smartlock Door Security System 250eb./level

If you know security, you know Smartlock™.

Stop those midnight entries, and keep tabs on your guard forces! A Smartlock can be installed on any door, safe, or terminal, requiring that the user actually plug into the lock via an interface cable and communicate the correct combination code (or other data required) in order for the lock to open. An additional option for 220eb. requires that a guard jack in at certain preset times or a police alarm sounds.



Mini-printer 125eb.

Equal in size to the pocket computers or portable cyberdecks it's linked to. Uses 500 foot register paper (1eb per roll) and a tiny laser printer head.

Paper Shredder 500eb

Secure your trash!

Prevent loss of valuable corporate secrets through improper waste disposal. This Arasaka-designed paper and disc shredder destroys both hardcopy information and computer discs at an economical price. Advanced safety features prevent injury to the operator.

Auto Punchout 330eb.

What you're reading may save your life!

Worried that somebody's slipped a Brainwipe into your bank file, ready to fry you the next time you check your balance? (If you're not worried, you should be.) Then MinFac's new Auto Punchout is the hardware for you. These analysis plugs instantly disconnect you when it detects any current stronger than a data signal. Bad news for Netrunners, though—the extra circuitry that signals must pass through slows the user's Netrunning Initiative Roll by -5.

EBM EUROBUSINESS MACHINES CORPORATION

EBM Carfaxx© 2002 500eb.

EBM's new portable cellular fax machine combines the convenience of cellular with the business power of fax, giving you mobile fax transmission from your car. Perfect for the traveling businessman, this fax machine is fully compatible with all standard fax devices. When your car is your office, give it full office potential with the EBM fax machine. Can be linked to DataTerms and most vehicle short-wave systems.

Telectronics® Telectronics Telectronics

Sonar Scanner 50eb.

Never get stuck in the dark.

Telectronics' Ranger is a hand-held sonar sensor with dual functions. First, it accurately measures distance to, and the dimensions of, the nearest solid obstruction. Second, it serves as a motion detector within a 120m. radius. Weight .2kg.

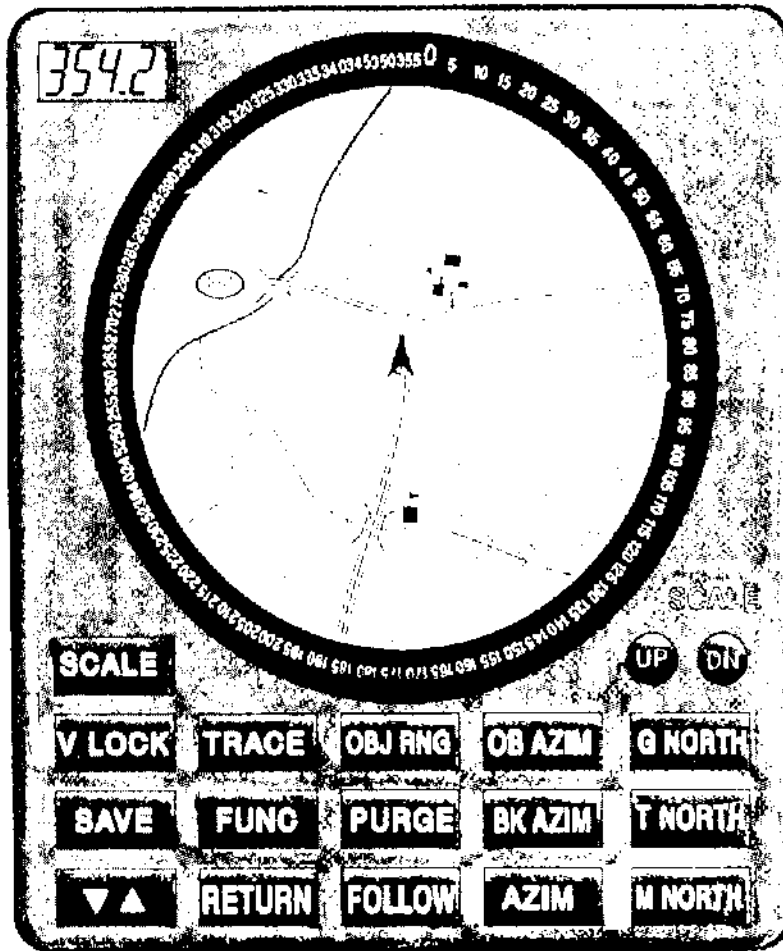

DataTel's Mapmaker®

500eb.

It's late, it's dark, do you know where you are? DataTel does.

The Mapmaker serves as a portable inertial tracking computer, pre-programmable with the exterior dimensions of an area as well as specified mapping symbols. It will mark progress through unknown terrain, showing position in relation to the starting and current positions. The path, and any noted surrounding area, are recorded in its memory. On traceback mode, the Mapmaker provides warning via audio signal, visual, or both when the return course deviates from its entries. Weight 1kg. Note: for 400eb. more, a Navstar satellite link system can plot your true Earth position to within 10m.

Netrunner Flip Switch 135eb

Never let your guard down!

The Flip Switch system allows the netrunner to 'flip' from his perceived position in the Net to reality and back at a thought. A good way to check up on things when you're 'running during a crisis situation. When 'flipped' into reality, the netrunner's signal remains where he was, and he is still vulnerable to attack by ICE within the Net. The reality view is projected onto a 2m x2m "window" in the Net, giving the view the Netrunner would normally see out of his own eyes.

Deck Security System

400eb (thumbprint)

1000eb (retina)

Keep your deck to yourself!

This Cyberdeck Security System consists of a thumbprint scanner which is connected to the deck's CPU. Unless a pre-programmed print is used, the deck will not operate. A secondary monitor checks blood flow, so that a dismembered thumb cannot be used. The more advanced version uses a retina scanner (if the subject has cyboptics, it checks the serial number of the optic).

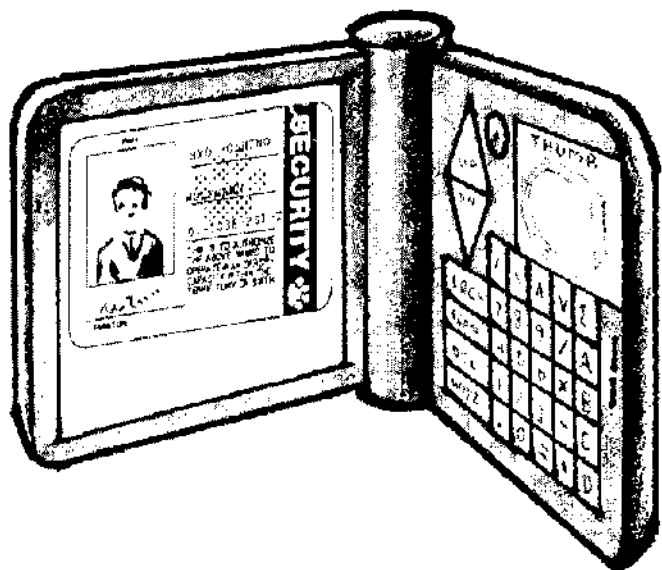

DataTel

Image Wallet 100eb.

Information at a moment's notice!

From DataTel, a completely self-contained electronic documentation carrier. The Image Wallet is the wave of the future: by pressing the owner's thumbprint on the cover, documents' images will be flashed on the surface of the wallet one at a time (the owner may specify specific documents). Registration cards, ID, and other types can then be optically scanned. Weight: .1kg.





WorldSat

COMMUNICATIONS Newsviewer 100eb.

Always be on top of information in today's world.

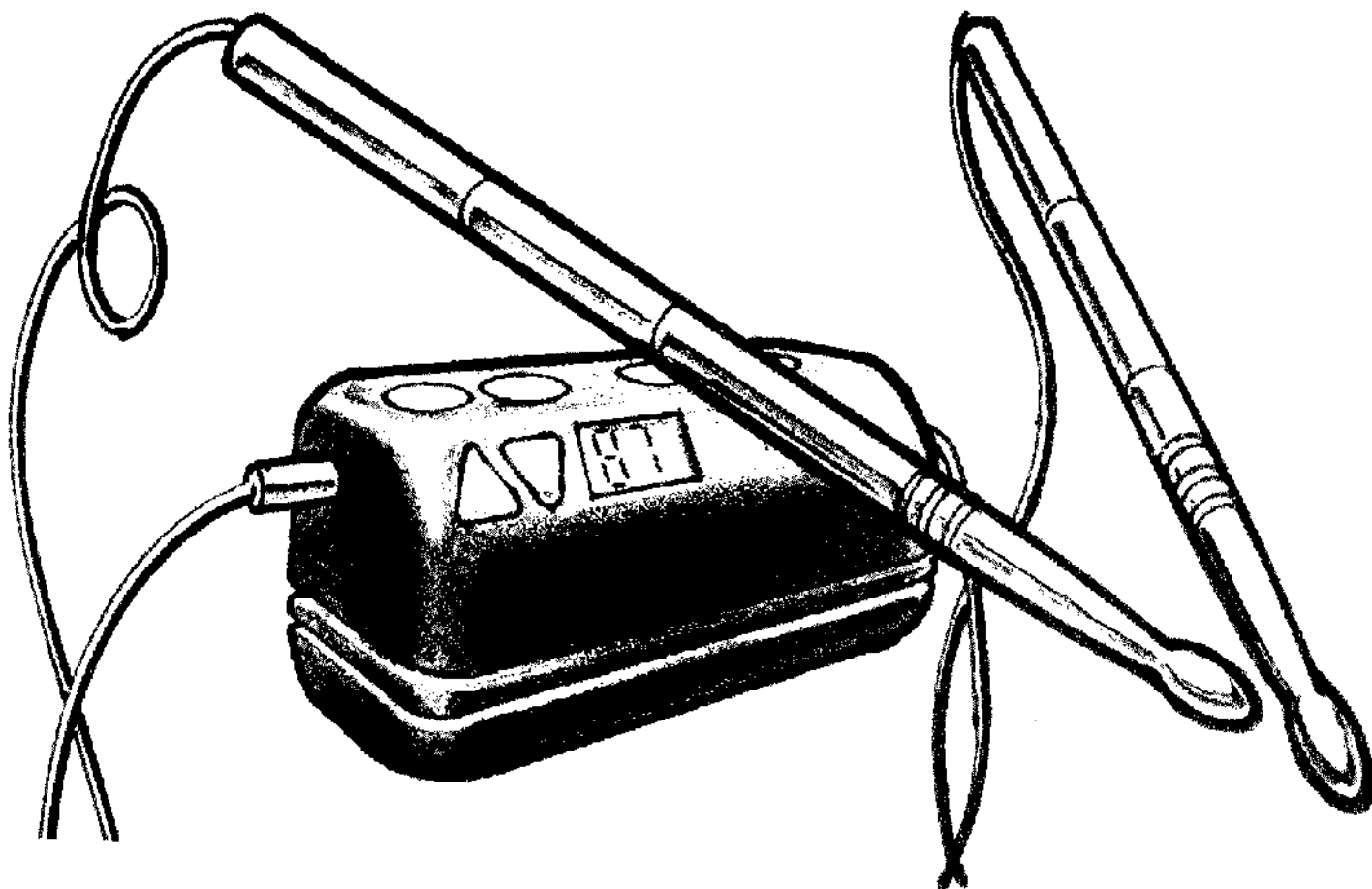
The Newsviewer is WorldSat's portable dataterm download device, aka, the "Newsdeck". News preferences can be audited by logging on by thumbprint. The system will then review stories in the order desired, working from a menu of story headlines. It can also be set to alert the user to breaking stories (monitoring the mediacorp broadcast bands for their distinctive "alert" codes). Weight: 0.1kg, rental fees 2eb.an hr.



DPI Smartsticks

800eb.

Bringing drums into the silicon age.

This new cybernetic instrument brings the drums into the silicon age. Smartsticks consist of two hand-held, drumstick-style tactile reactors, cables which lead from the sticks to an on-belt synthesizer package, and interface cables to link the synth-pack to the player's plugs. The result is a +1 on *Play Drums* skill, but with the added advantage of being a synthesizer: any percussion sound can be programmed and accessed by striking a 'stick' on a solid surface (drums, walls, heads). The synth-pack is radio-linked for amps or speakers. Dealer's prices may vary.

**Sleep Inducer
85eb.**



Everyone needs their rest; some just need it quicker!

Tritech's Sleep Inducer, aka, "The Russian Sleep," consists of a small device with electrodes which are placed on each eyelid and the nape of the neck. A small current then passes through the brain putting a person directly into deep sleep. Users can get a full night's sleep in two or three hours. If not turned off via the integral timer, the user will eventually be awakened by hunger. Weight under 0.5kg.

Fireproof Clothing

Fireproofing and high fashion !

Salamander Line— New from Savagery Fashions, the first line of fashionable fireproof clothing! Overcoats, jackets, pants, and hats that cannot burn. Make your style equal safety with Savagery's Salamander Line! Base Costs: Multiply by Style, as on CYBERPUNK 2020, pg. 58

- Coat 110eb
- Jacket 100eb
- Shirt, hat 65eb
- Skirt, pants 75eb
- Overcoat 250eb

Game Effects: This wardrobe acts as SP 20 protection against all FIRE damage only.

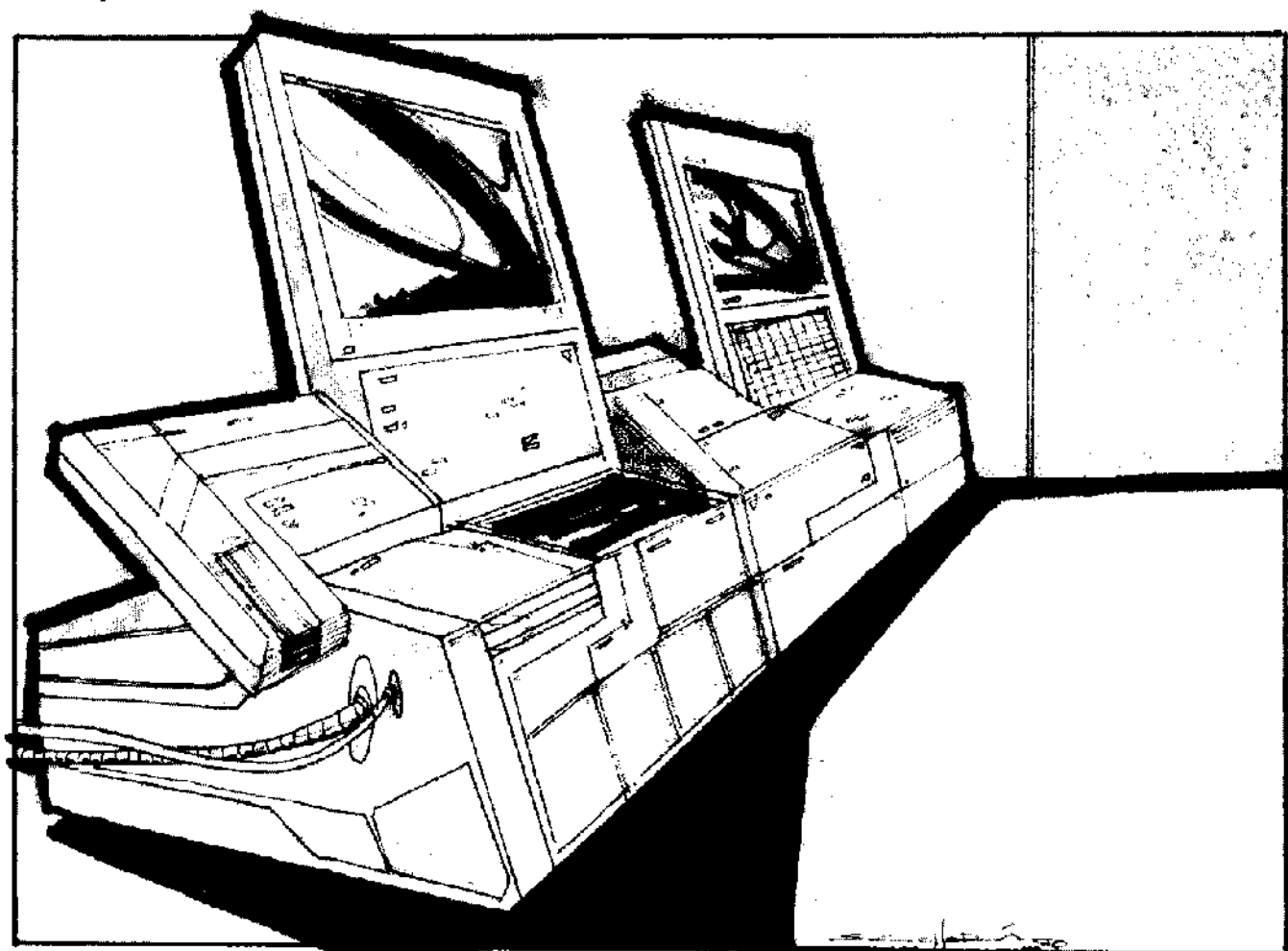

Digital Recording Studio

12,000eb

Record your own audio chips!

Telectronics' professional quality digital chip recorder records up to ten chips simultaneously. Wide-band frequency capability gives the T-2020 a full 20 to 65 thousand Hz recording at 0.00001% THD. A sixteen channel multi-tracking SMPTE mixer provides the solo musician the ability to sound like a full band. The T-2020 is approved by the World Musicians Exchange, and was used by Sarah O'Connor to produce her recent Top Ten hit *Loving at the Speed of Light*. Fully SmartMIDI compatible, the T-2020 uses state of the art mixing circuitry to balance the sound, and recording sampling technology to assure that duplicated copies will be 99.999% error free!

Digital Weapon Uplink 500eb.

Techtronica's advanced smartgun model, the Digital Uplink Diagnostic (aka DUD Smartchipping) monitors the status of your smartgun and feeds readouts to your TimesSquare Marquee cyberoptic. Information includes rounds fired, barrel temperature, and the maintenance state of the weapon's action. In case of a jam, this option will automatically tell the user the problem, adding +2 to his TECH roll to unjam the gun.

DUD Smartgun Controller 720eb.

Your gun's never out of reach!

A DUD option, the package consists of a vocalizer chip, voice-recognition processor, and mini-pickup mike. The weapon can give its user data via cyberaudio rather than TimesSquare, plus the owner can program the smartgun to be *voice-activated* (no cable needed!). Example: If a solo's weapon has been dropped, and it's pointing at the target (1 in 6 chance), he can order it to fire!



MICROCYBERNETICS

Cybercam EX-1 1200eb.

No media should be without one.

A headset-style multi-format newscam, the Cybercam EX-1 has interface connections allowing for visual synch with cyber-optics and audio, as well as graphics, logos, and on site editing of tapes and live footage! Recommended by Net 54 techs, and produced by Raven Microcyb on a Nikon America design. Weight 2.2kg.

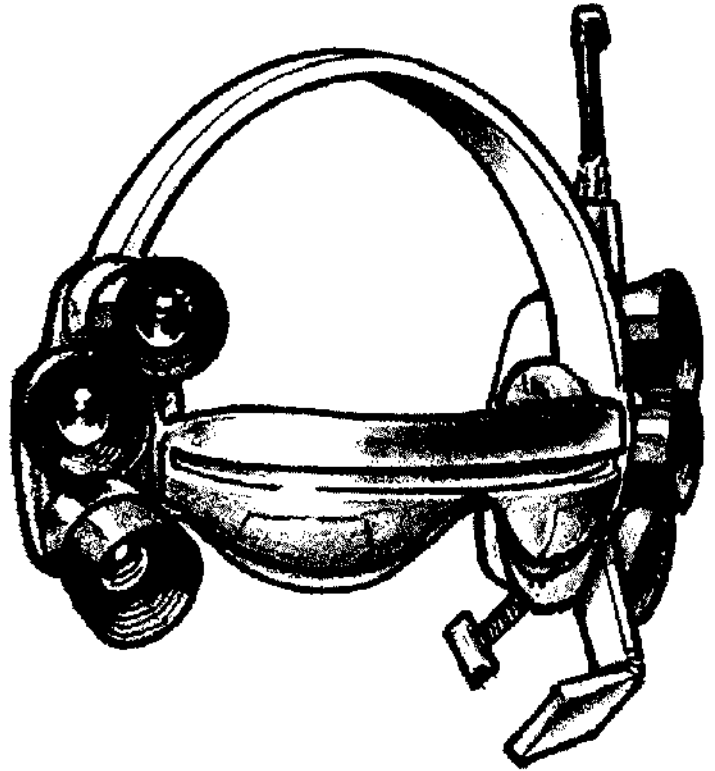

ID Badgemaker 500eb.

Make your own ID badges!

Perfect for the small corporation or club, the Danshi ID Badgemaker produces professional quality solid-plastic, keycard, and photo-ID badges. Upgrade your security for a low, economical price, and protect your employees. One easy to use, simple unit lets your security worry about security, not administrative duties. An additional 200eb. will allow Tennerec LTD's CookieCutter™ smartgun cut-out system (*Solo of Fortune*, pg. 22) to be interfaced with Danshi ID's.

Detcord High Explosive 900eb./pack

Need to make entry quick ?

Detcord— Used primarily for hostage-rescue situations, detcord is a rapid-opening system, containing explosive charges in strip form. It can be used to blow precision holes through doors, steel, and brickwork, and is detonated by a wire-controlled button in each 10m package.

Game Effects: cuts through up to SP40 armor like a cutting torch in 1 turn.



CYBERMATRIX

Speedholster 100eb.

There are two types of people in 2020, the quick and the dead.

Speed Draw® holsters— Be your own John Wayne with CYBERMATRIX'S new spring-loaded reflex holsters. Available in many configurations including hip, shoulder rig, leg, and back rigs. Plus, the ever-popular *Handlauncher* will give your enemies a little surprise from up your sleeve! (Adds an extra +1 to Initiative when you declare a fast draw.)

Temperfoam Furniture 80-140eb per piece

For the Mallplex conapt or just for fun!

Foam furniture which shapes itself to the individual user. It has a feel similar to a firm and stable gel. Weight varies.

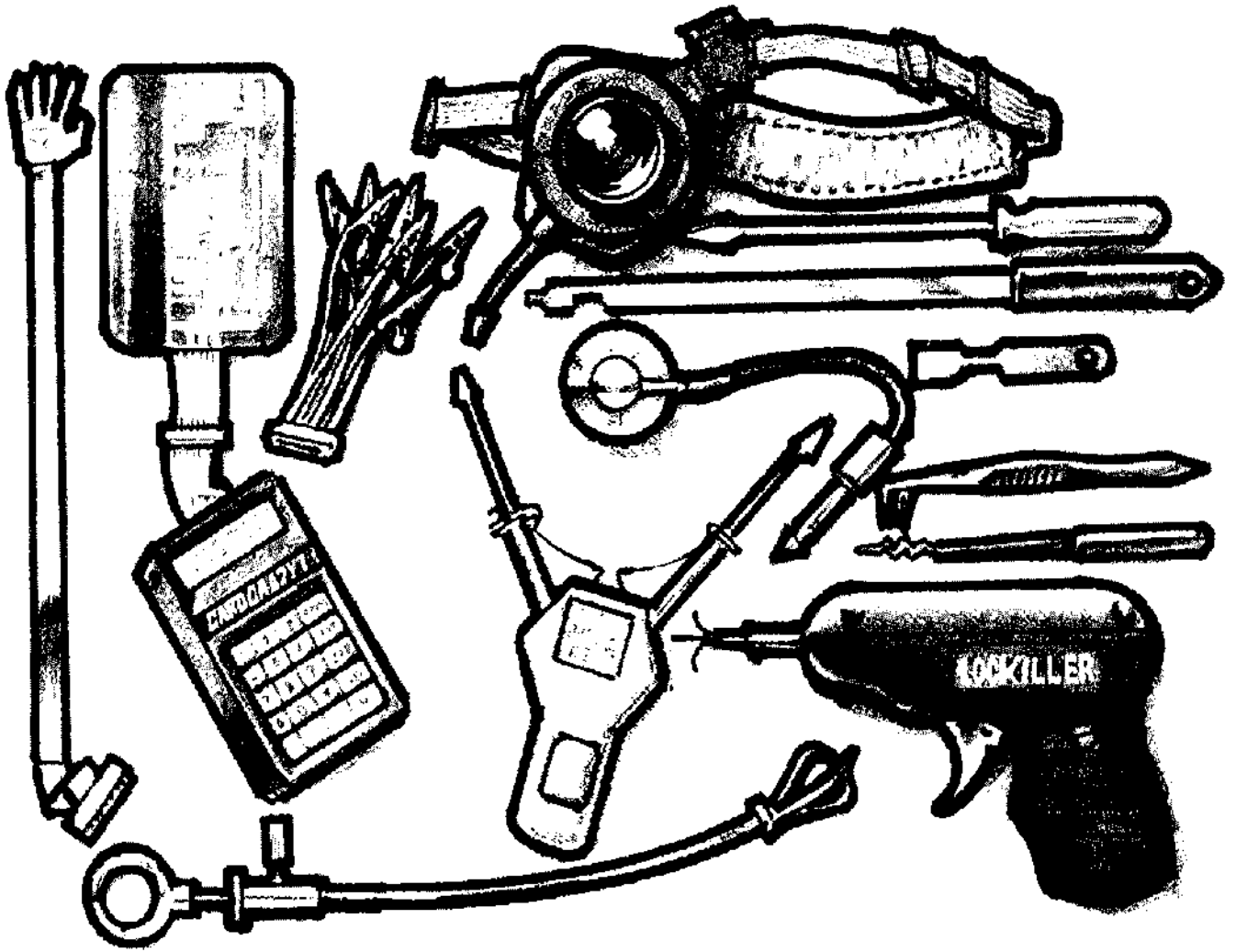

Advanced Alarm Removal Kit

290eb.

This package contains state-of-the-art intrusion devices, including insertable circuit breakers, a bypass analyzer, logic probes, microwave reflectors, ultrasound absorption plates, and micro-manipulator tools. Using the kit adds +1 to all TECH rolls made vs. card/voco-locks, security scanners, and movement sensors. Weight 3kg.

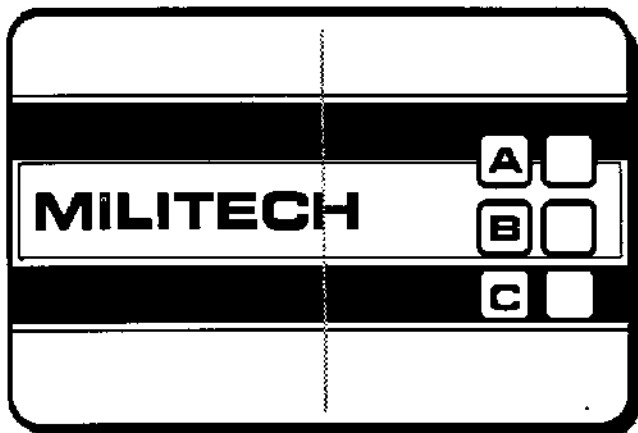

Personal Body Alarm 400eb.

plus 300eb./month. and ammo and medical fees upon extraction.

Never be caught alone again!

Originally developed for prison guards and perfected by Militech, the personal body alarm is now available to the public. Similar to a Trauma Team Card, this unit works upon manual activation. Simply break the card, and the nearest contracted security squad arrives to evacuate you from the vicinity of the danger. Ammunition and medical fees are a nominal extra.

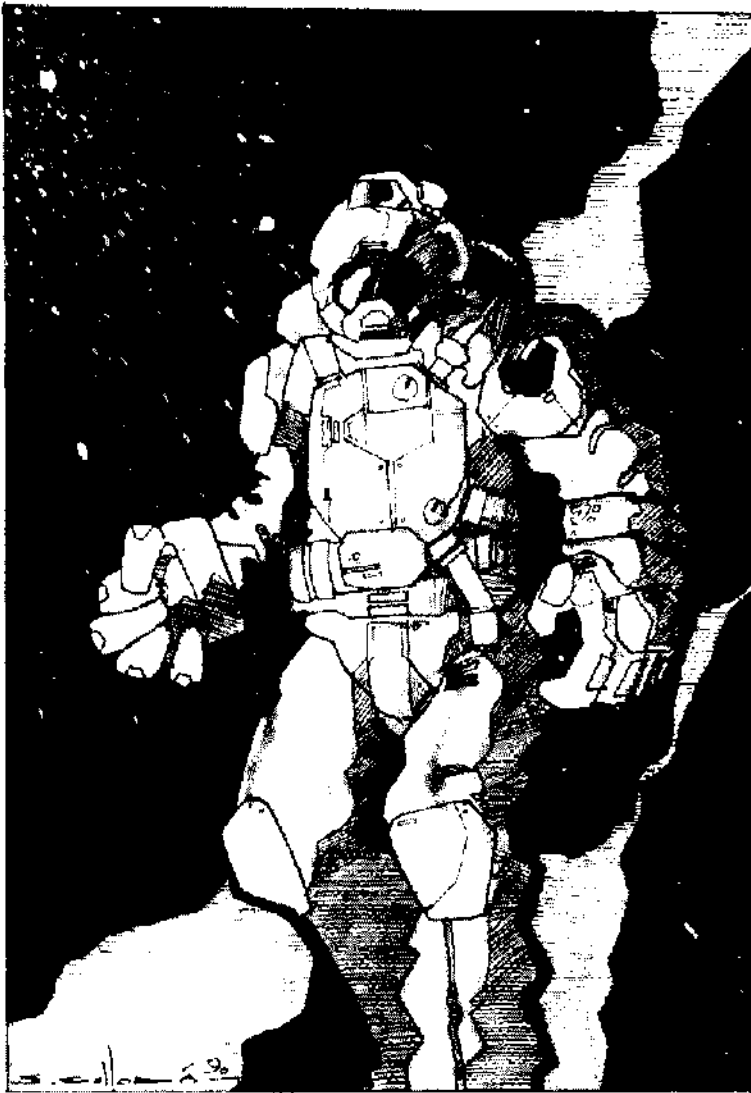

**Diving Suit
6000eb,**

plus 100eb for a 30min. tank of L.B.M.
(up to 4 tanks can be carried during a dive)

The suit that set the world record!

On July 13, 2011, Bryan LeShawn dove to 12,645ft. in the deepest independent suit dive ever recorded. His edge? The Poseidon Fluid Breathing Suit. The liquid breathing medium equalizes the pressure in the lungs, preventing the former problems of extra deep dives. Dive where no man has ever gone. Explore sunken galleons unknown. Walk the decks of the *Titanic*. The Poseidon Suit can take you deeper than any other diving method around, and is produced exclusively by the Hydrosubsodium. Maximum recommended depth is 10,000ft.

Note: there is a 20% chance that a person cannot tolerate the liquid breathing medium, and therefore cannot use the suit. Also, a diver will be at -2 to his Body Type stat for an hour after the dive while his respiratory system readjusts.

GIBSON



BATTEGEAR®

**IR Combat Cloak
450eb.**

A must for night missions!

A loose-fitting, mackintosh-style garment from Gibson Battlegear which absorbs IR emissions until the wearer can safely bleed the heat off. Then the cloak bleeds the heat in a random pattern so it does not appear to come from a human source. (-5 to Awareness/Notice when using IR.) Weight 2kg (EV2).

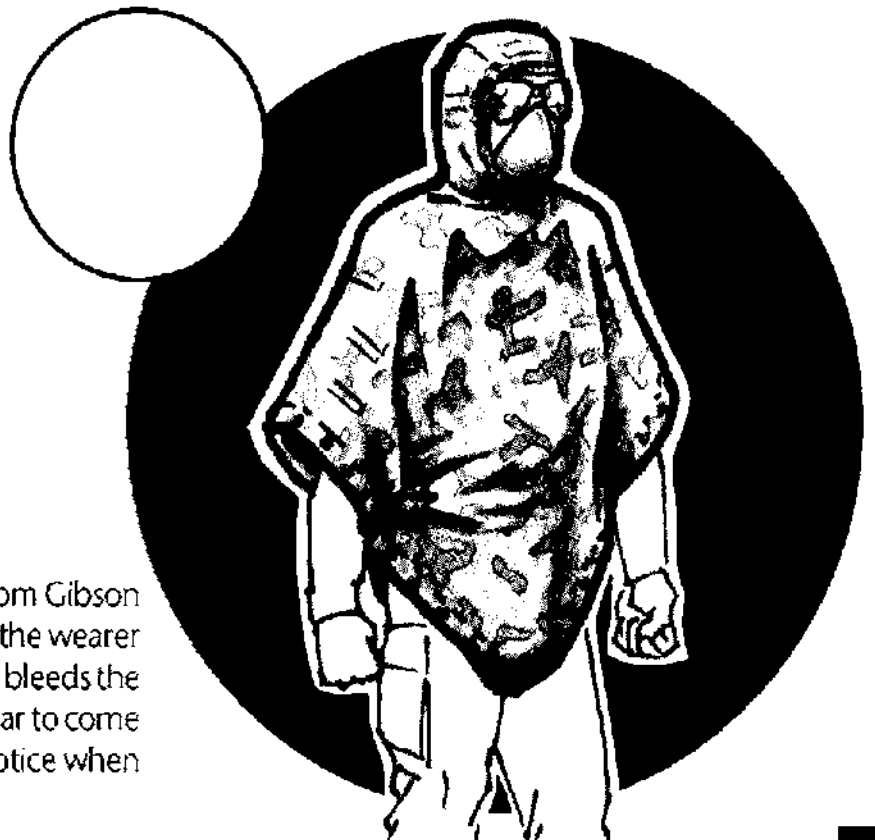

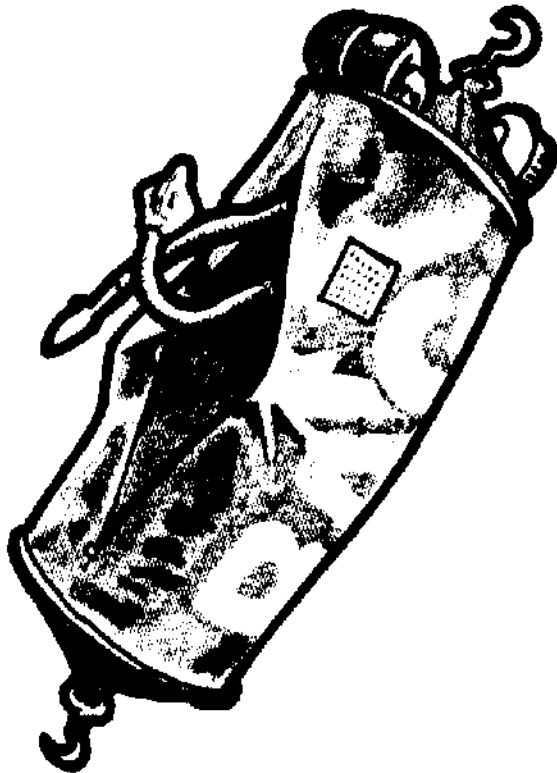

Slosh Bag 65eb.

A 'sleeping bag' style bath for use in 0-G situations. The user puts on a respirator, gets into the bag, seals up; and fills it with water through a special valve. After draining into your station's recycling tanks, rinse with disinfectant included. Weight: 2kg.

Travel Kit 150eb

Keeps you prepared for any trip!

The Complete Travel Kit contains all you'll need for an overnight stay. Lightweight, convenient and economical, the kit contains a sleeping bag, inflatable pad, first aid kit, nylon carrybag, flashlight, toiletries, and 6 disposable sets of pajamas; just what you need to stay sharp when away from home. The entire package only weighs 5 kilos. 10 extra sets pajamas 10eb.

Shower-in-a-Can 3eb.

Have you ever had to spend the night in a cramped 'cube outside a busy airport because your plane was delayed? Ever been peeved by the lack of available showers under such conditions? Shower-in-a-Can is the answer. Just spray yourself with the patented, 100% safe disinfectant/deodorant foam, wipe it off, and you're ready to go!

Power Grid® Solar-Electric Panel 100eb

Power without plugs!

Got to run something, but don't have access to the juice? Power Grid Inc.'s new solar panel is just the thing. Set the Grid® in a sunny window, plug any 110 household appliance into it and it'll provide current for free. Or link several together with the built in adapters. Each panel powers one 110 volt device, and you can plug the total grid into a central extension cord (25eb.) to power a whole conapt for free!

Medieval Armor 3500eb

Own your own suit of armor!

Have your own personalized suit of authentic reproduction armor made to fit out of modern steel (SP 14, EV 6). A great addition to your living room, or for wearing to parties in the Combat Zone! Two models are available, *Standard* for regular use, and *Maximillian* for those who want to cut a swath of steel style (10,600eb.).

Flavored Cigarettes

NEW! From Biotechnica!

Sample Biotechnica's newest creation, with real, genetically engineered, tobacco. Biotechnica's special line of flavored cigarettes promises enduring smoking pleasure. 2eb./pack, 15eb./carton.

The following flavors are available:

REAL MAN—Jalapeño	TRAILMASTER—Smoked Beef
SWISS ALPS—Chocolate	FIELDS OF GREEN—Strawberry
ITALIANO—Pizza	HAIGHT STREET—Hashish

Bar-in-a-Briefcase 100eb.

Party on the Road!

The Bar-In-A-Briefcase has everything that you want for a party away from the crowds. Two liters of assorted liquors and mixers, plus a menu display and mixing instruments let you give an executive-style party for up to ten people. Great for the traveling businessman, or a private party for two.

Vehicles

NEW DESIGNS 2020

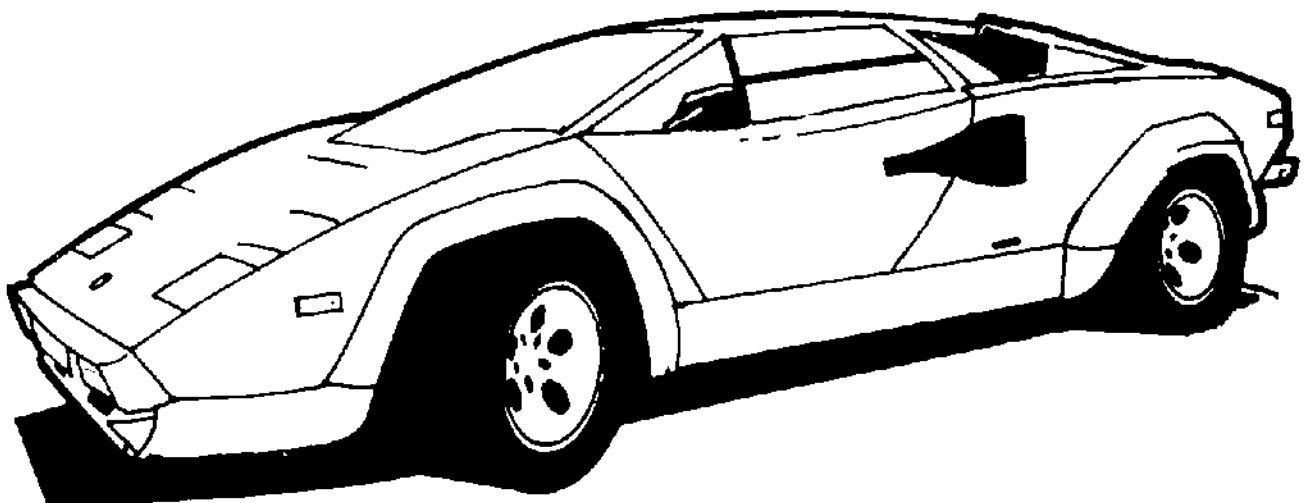

1000hp powered CyberTech replica. 59,000cpi.

"You have to get there somehow, even in the far future. But you can have a lot of choices about how you get there. These days, we have sleek cyberbikes and streethogs for the Nomads. High powered roadsters for the Corps and Solos. Combat Aerodynes, helicopters and assault vehicles for Cops, Medias and combat professionals. And finally, Postholocaust highway horrors like the dreaded Punknaught, scourge of the freeway and terror of the open road. It's all there—you just have to have the guts and the euro to claim it..."

*—Mister Ice
Head of Design, Technix Inc.*

CASCADE

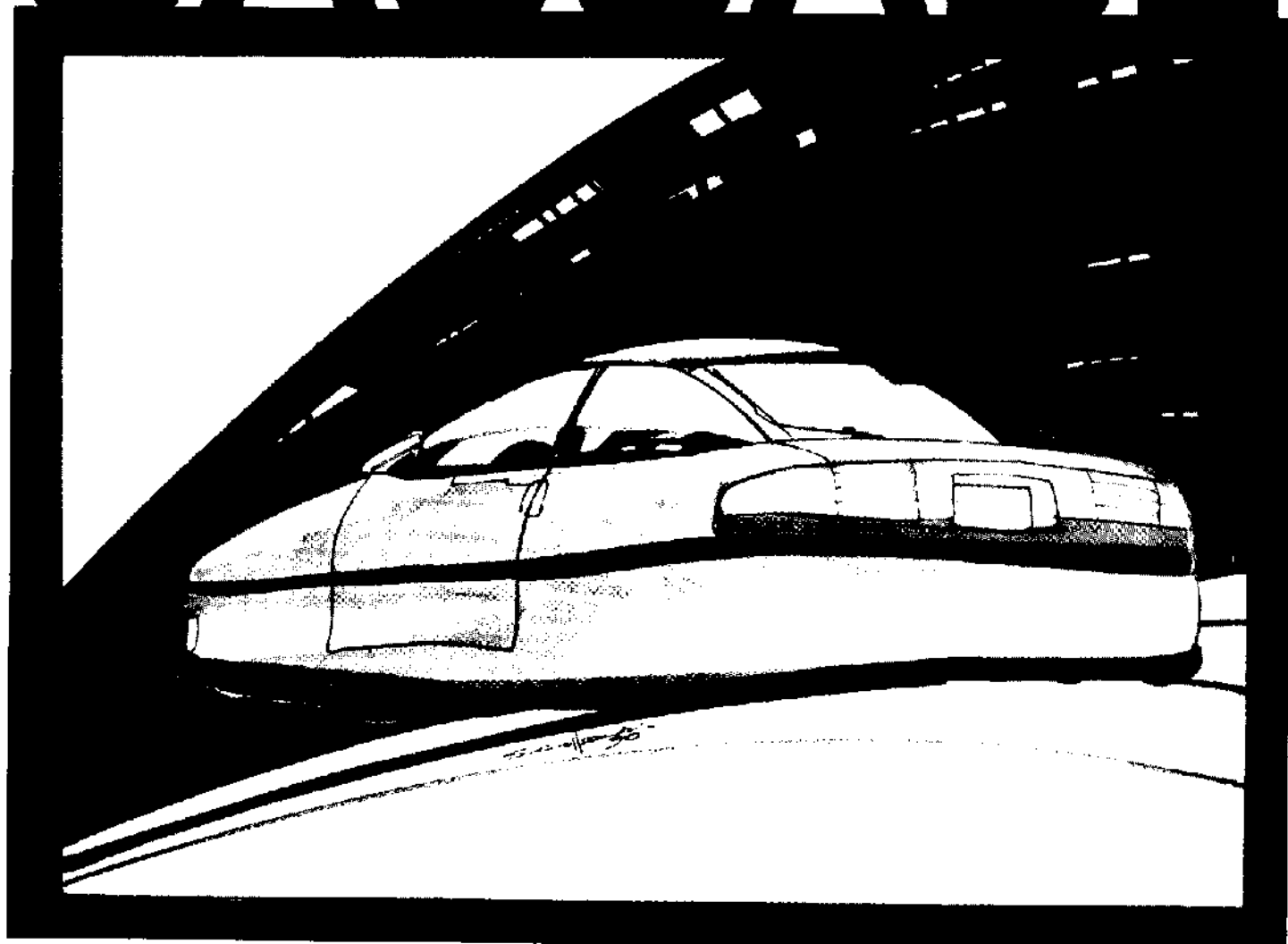

The Bensen Cascade

58,000eb.

Racetested for optimum performance, this new model from Bensen carries the tradition of the ultra-fast sport hover into a new decade. The '20 Cascade is the epitome of newtech: its electronics, avionics, powerplant, and luxury are all tomorrow's models today. Gutwrenching acceleration on the straights, bloodcurdling handling in the turns terrifies the uninitiated; only a master (Drive Skill of 8 or greater required) can control the Cascade. Worldspanning access via cellular link keeps you in touch, and the fastest multiprocessors keeps control a thought away with standard interface plugs. Only Night City's best is good enough. Are you?

Comes in two colors: black as usual, and new for 2020, chrome.

Game Stats: Top speed 260 mph; can leap up to 3m off the ground but requires a control roll (DIFFICULT) to avoid scraping ground on landing. Full onboard computer systems, including limited autopilot (straight line with no more than 10 turns) and interface controls. SDP: 40 SP:12.

BMW 9018s

BMW 9018s

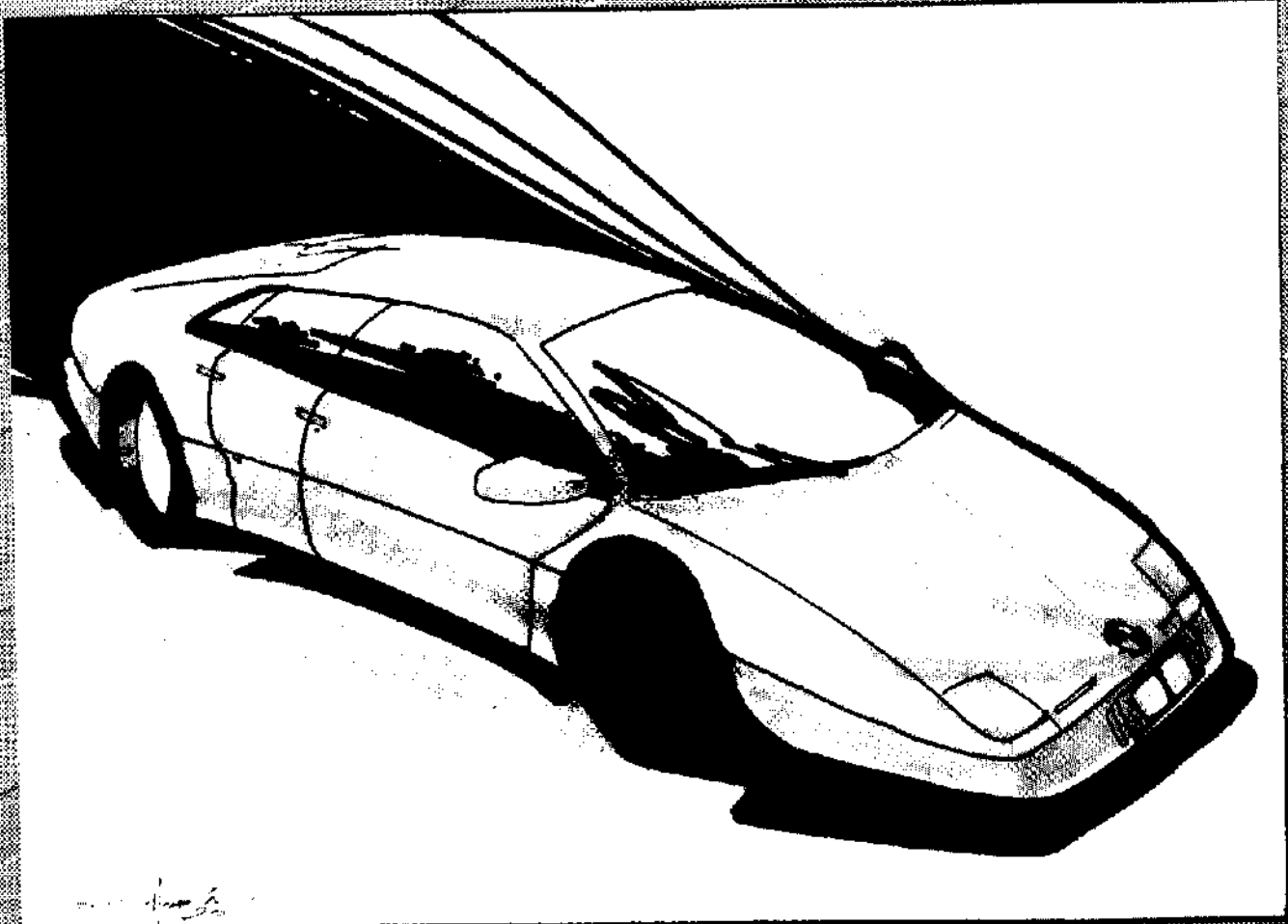

BMW 9018s

The BMW 9018s

100,000eb.

Only the most elegant performance sedan ever engineered. Built for style, built for comfort. Space for six, every luxury. Handmade. Nothing more need be said.

Game notes: Top speed is 210 mph. SDP=90, full armor SP=24. Full cybernetic controls for the driver. It doesn't have options, they ask you what you want, then they build it: car fax and phone, multi-channel TV/VCR, laptop computer, limited microwave relay link, wet bar and snack case, deluxe SegAtari cybergame system, endangered fur upholstery, quad-surround stereo, SilentTalk anti-surveillance system; you name it.

THUNDERGOD

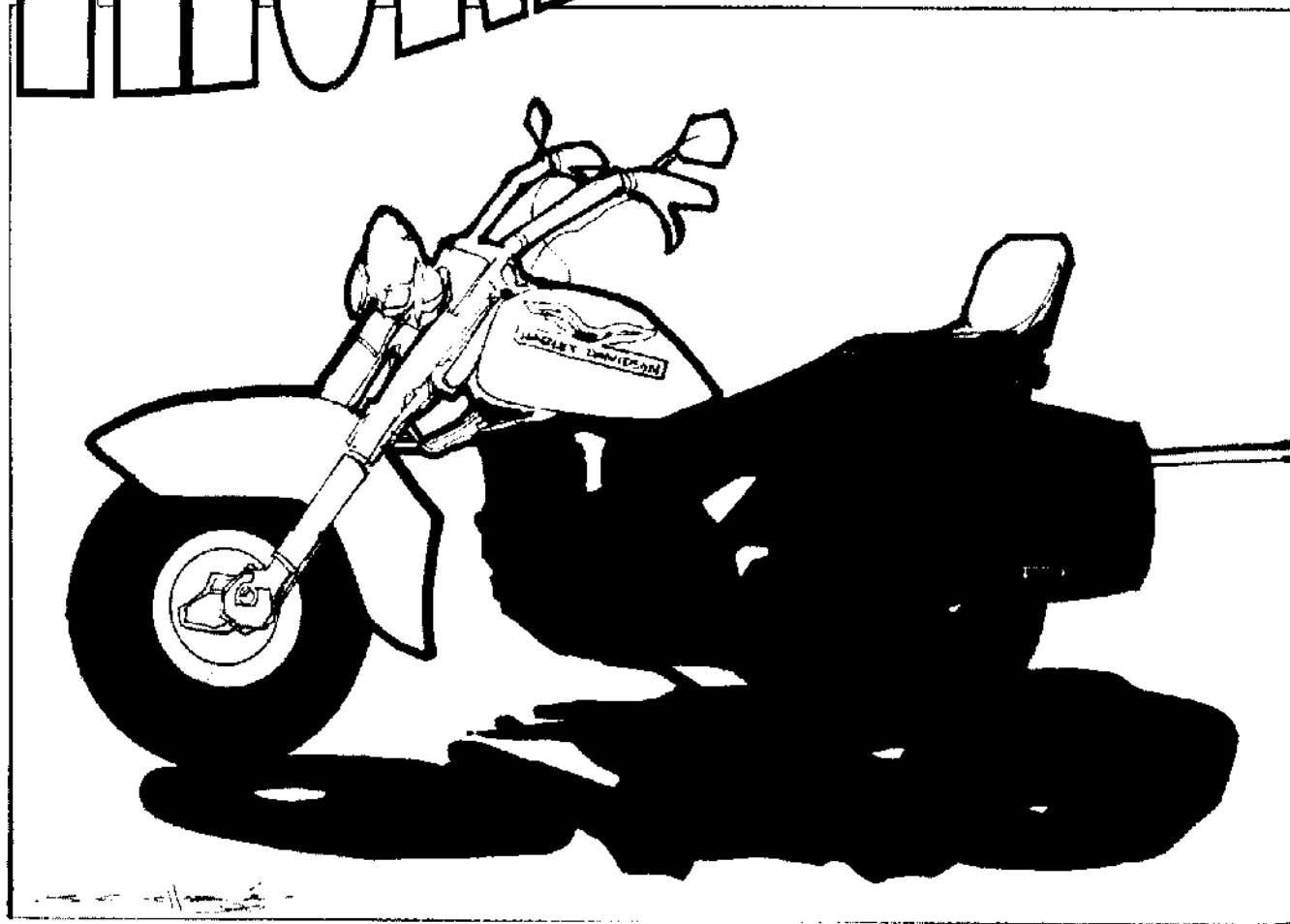

Harley-Davidson Thundergod

5040eb.

Not only newest bike from Harley, but the best ever! The horsepower of a sportscar (perched on two wheels via fully computerized suspension) turns this motorcycle into a rocket. The chassis is sturdy enough for long hauls with only cursory maintenance, and the onboard electronics are modular for easy repairs and upgrades. Two people can ride comfortably, and their outfit won't slow the bike down. Tough enough, fast enough—bike enough for today's road.

Game Notes: the Thundergod is a hog for a new decade, a favorite with many Nomad packs. It is fully cyber-capable, and will run on CHOOH2 or hydro fuels. CB is standard equipment, and there is lots of room to add extra electronic goodies—the Thundergod was designed for a custom electronics suite. Base price for the bike is 4640eb; add 950eb for cybernetic controls. The frame is SDP35, unarmored. Cruising range is 600km.

Shiva

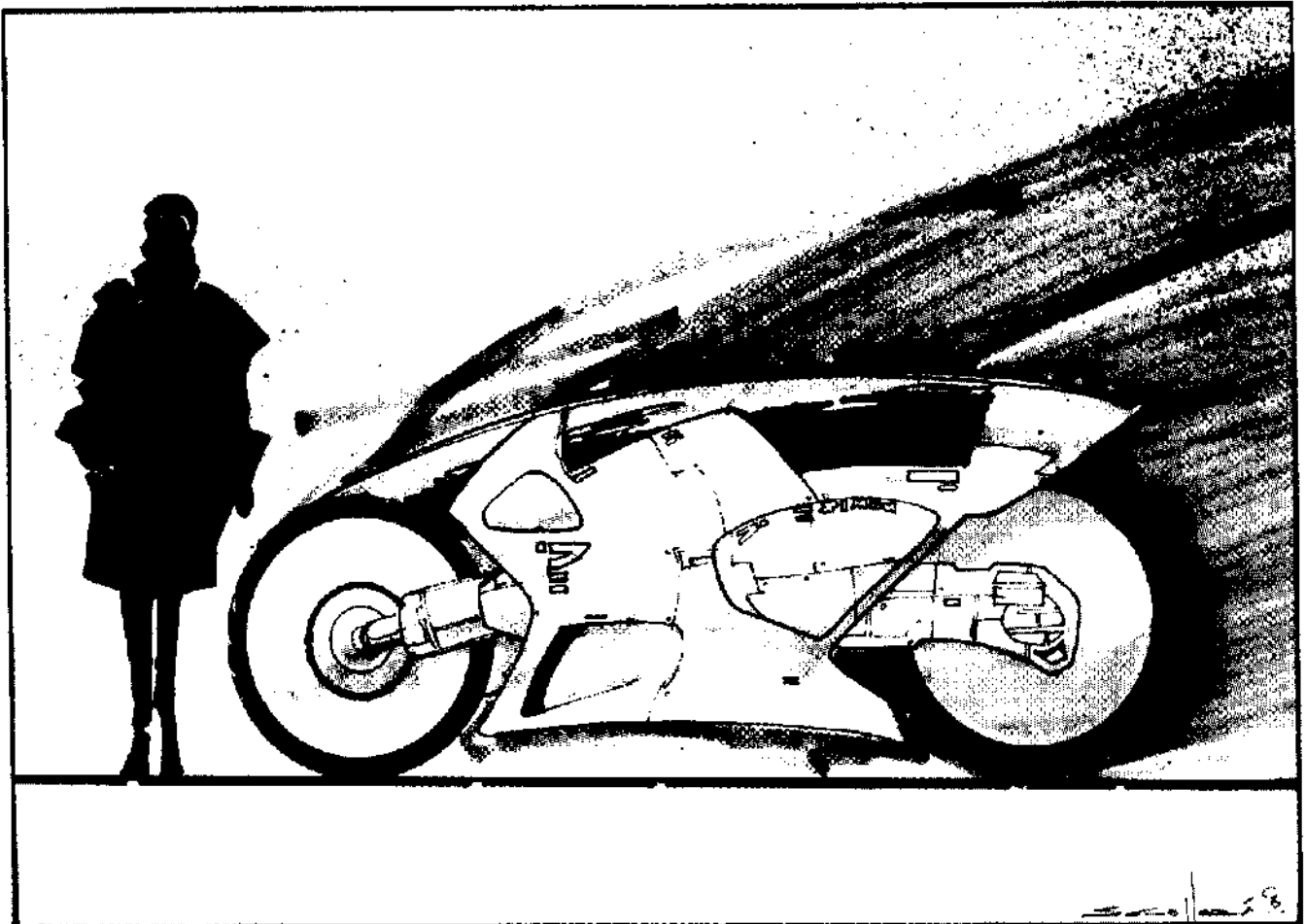

Shiva

Kundalini Roadworks Shiva®

8000eb.

The Shiva is the first high-performance motorcycle entry from Kundalini. Following in the tracks of their highly successful personal and utility vehicles, the Shiva promises spectacular performance for the E-buck. Rated at over 260kph on racetracks, its cyber-assisted suspension will keep you upright on rough surfaces at close to its theoretical maximum. Its acceleration is comparable to other speedbikes, and its handling belongs on a racetrack, not the street. But there it is; fast as a laser, blacker than night.

Game Notes: the Shiva is indeed highly maneuverable (reduce DIFF for all maneuvers by 5 pts), and fast as well. Just don't take off too fast with a passenger on the back. Top speed on city streets is 250kph! It can pull almost a G with a skilled rider, expect it to make almost any corner. Interface plugs can be added easily. Range is 400km. SDP=32.

Pedicab

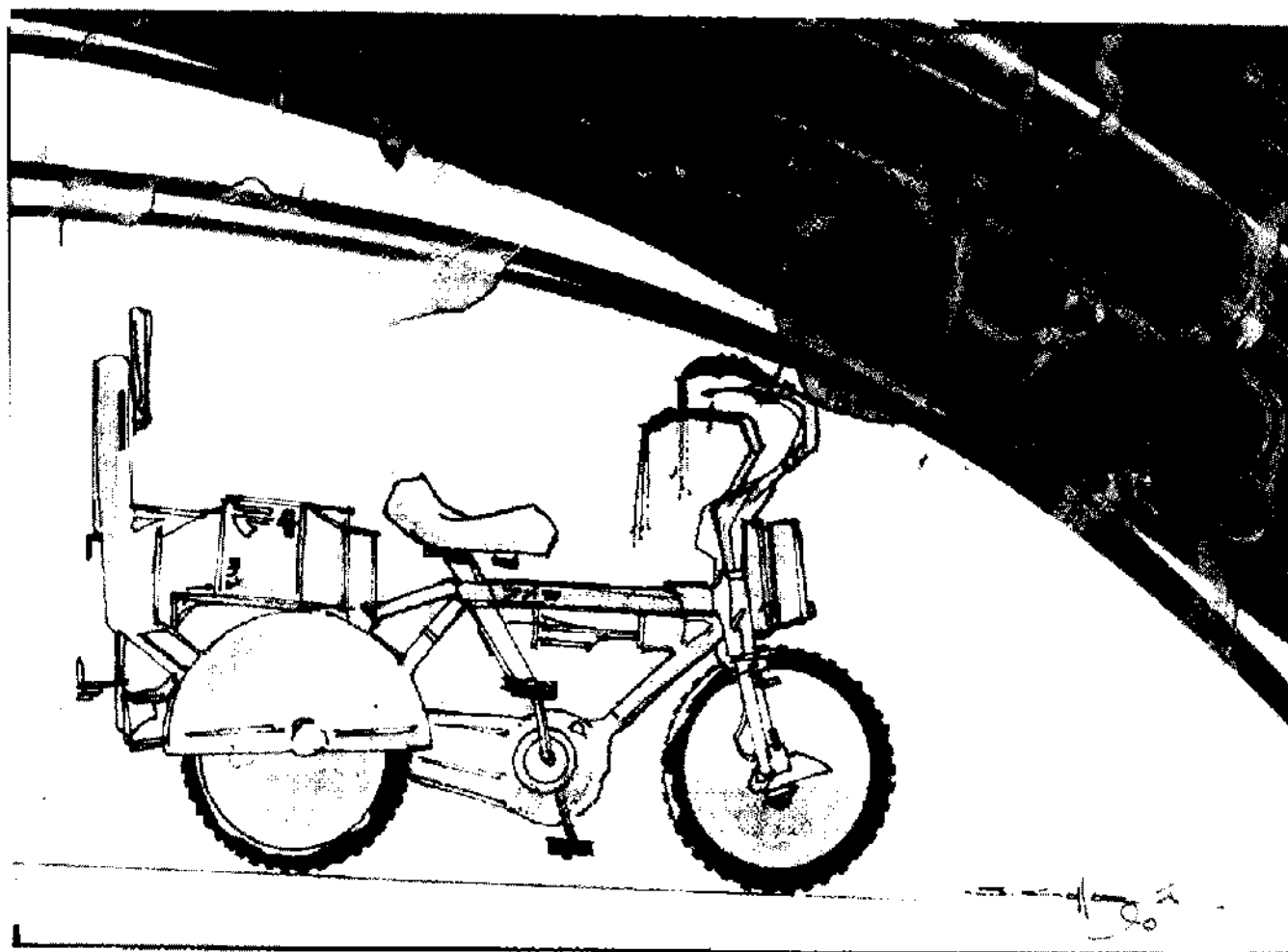

Pedicab

1200eb

They're everywhere, and they'll take you anywhere. One man pedalling away replaces an expensive motor, and for fuel; he eats. The typical pedicab seats two with a minimum of cargo. The fare is usually 1.5eb. per mile. Heavy people pay extra. Top speed is 25 mph on level ground, down to fifteen if fully loaded. Speed is somewhat higher downhill, but make sure the brakes are working properly before you let the driver coast down a big hill. Pedicab drivers are wonderful sources of information, if properly tipped. And if properly motivated (gunfire usually does the trick), Pedicab drivers can occasionally get up to thirty mph.

Game stats: SDP=15, but gunfire has a 75% chance of doing only cosmetic damage as there isn't a lot on a pedicab that can stop a bullet. Or protect the passengers.

New American Autoworks®

Ambunaught

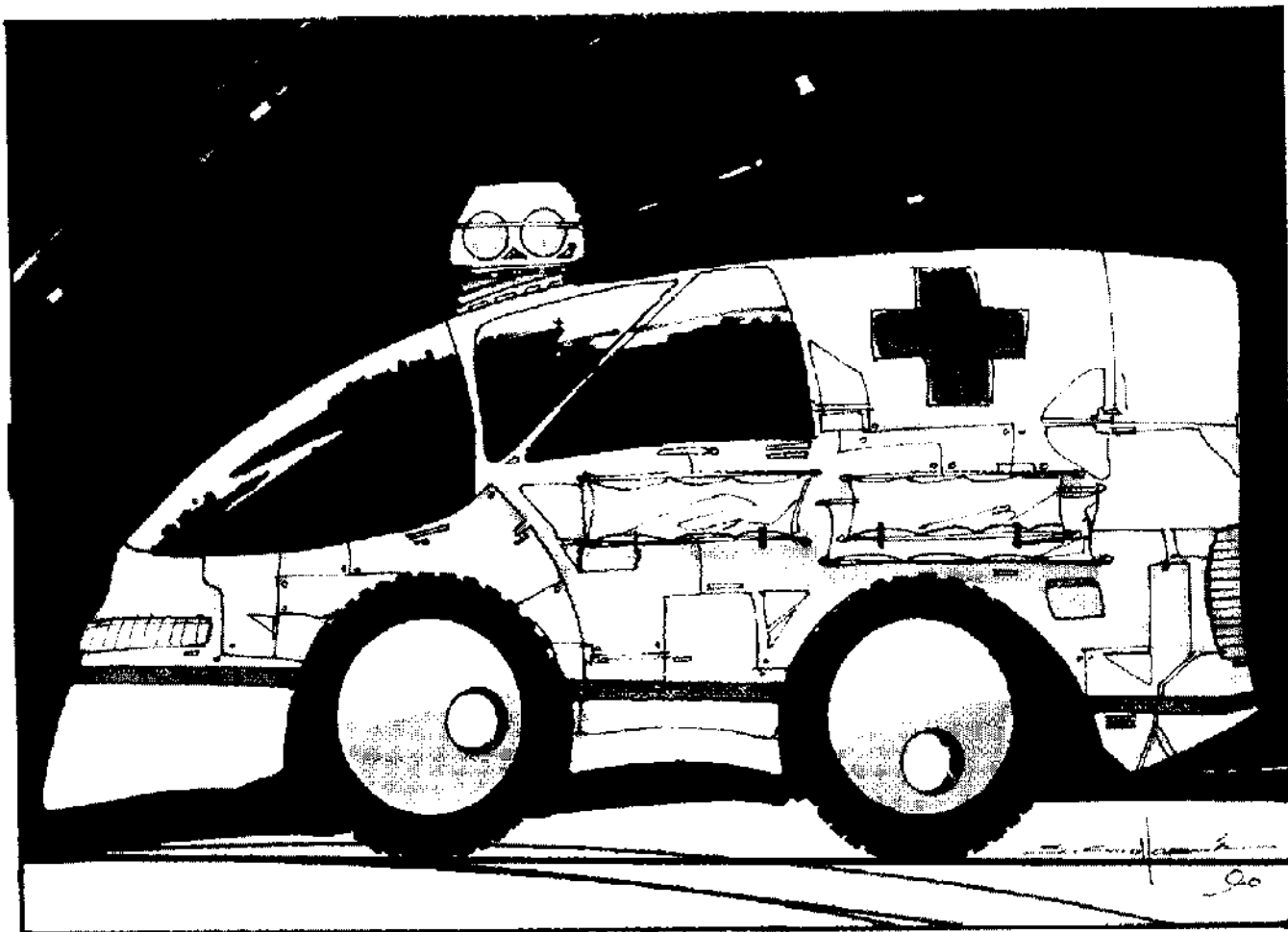

**New American Autoworks Ambunaught.
76,000 eb.**

Paramedic crews are exposed to the worst situations, often expected to rescue people from active firefights, or to brave fire-and-explosion-prone areas. The NAA Ambunaught is the answer to their prayers. The Ambunaught has the smoothest ride possible on four wheel drive, capable of crossing the roughest ground any city has to offer. The outer shell can resist fire from all small-arms and light AT weapons. The Ambunaught is also environment sealed and completely fireproof. Space is available for up to 4 patients on stretchers and two working paramedics. Would you ride in anything less?

Game notes: The Ambunaught is really well armored, capable of resisting fire from most small arms, although it does have some chinks. Next year's model is supposed to float, too. Its sealed environment capability is 16 man/hours of life support. They are resistant to heat and have a non-flammable exterior. It also has a full roll cage and can easily survive up to two tons dropped on it. Top speed is 72 mph. on flat ground, 30 mph on rough. SDP= 120, SP=40.

RIOT-VIII

ARASAKA

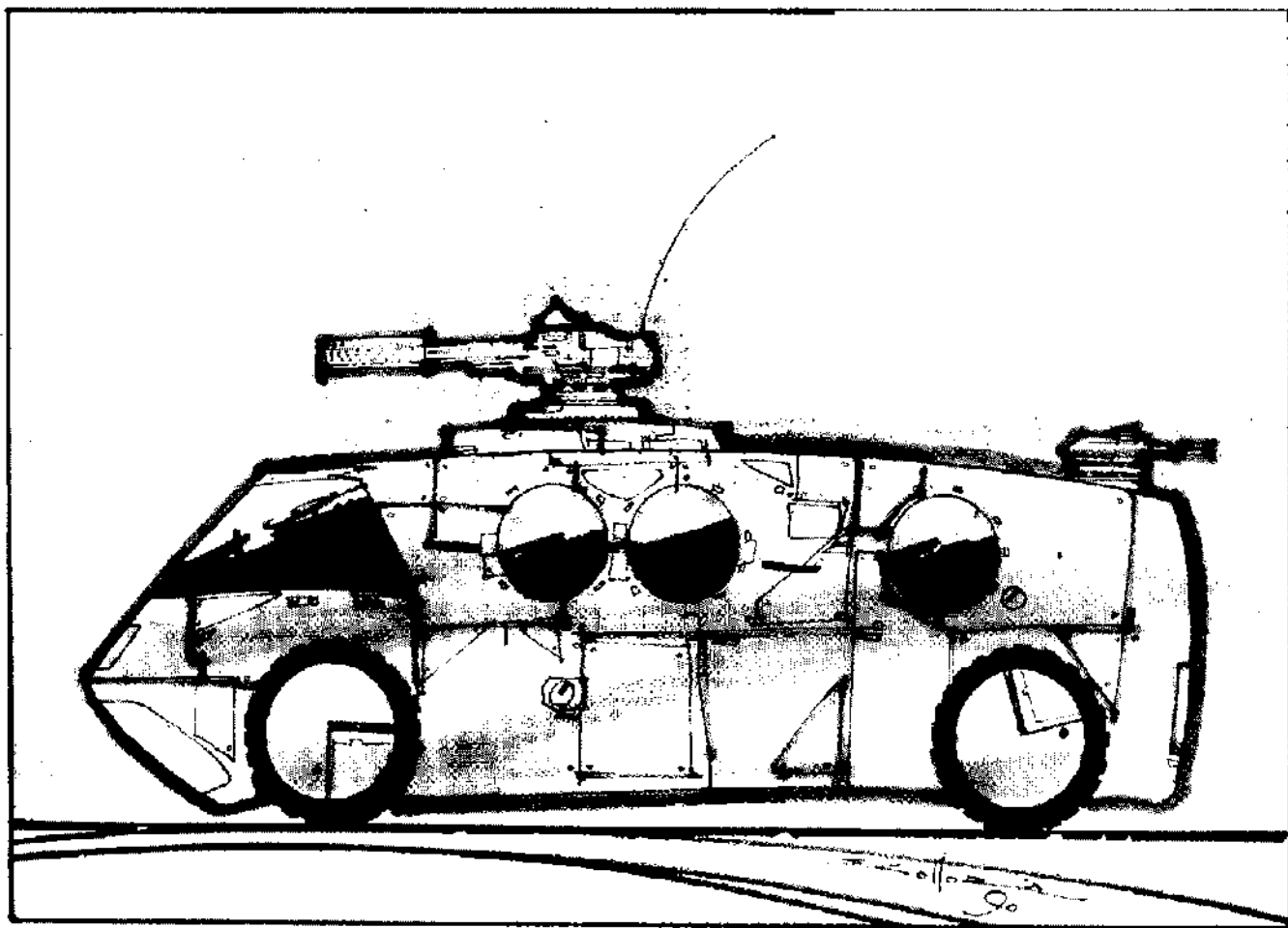

Arasaka Riot-VIII

250,000eb.

When the great unwashed come knocking at your door, you'll want to have a Riot-VIII waiting for them. The Riot-VIII is a state of the art crowd control/suppression vehicle. Enhancements over the old generation of riot control vehicles include: fully fire-resistant hull designed to shrug off Molotov cocktails; water cannon with 10 minutes of spray and a new steam function (pat. pend.) that will break up the most determined riot with only minor scalds and burns; fully cybered control system including a satellite uplink that allows the board of directors to handle a situation with that personal touch. And this new generation of crowd control vehicles is capable of operating in the most rugged of urban environments for days if necessary. Riot at your downtown facility? Call 1-800-ARASAKA now and our representative can have vehicles in operation within 120 minutes or less. You have our word. We'll be there.

Game Notes: Top speed is 120mph. SDP=200, SP=30. Crew of two, and up to 8 riot police. Troops carried are not fully enclosed, but are under 75% cover. The water cannon is turreted- 360° traverse. Water cannon range=30m; 10m for live steam. There is also a grenade launcher on the cab roof; 180°. arc carries 18 standard grenades, 300m range. The watercannon's effects are up to the individual Referee, keep them an unknown factor; unknown, but potentially extremely painful.

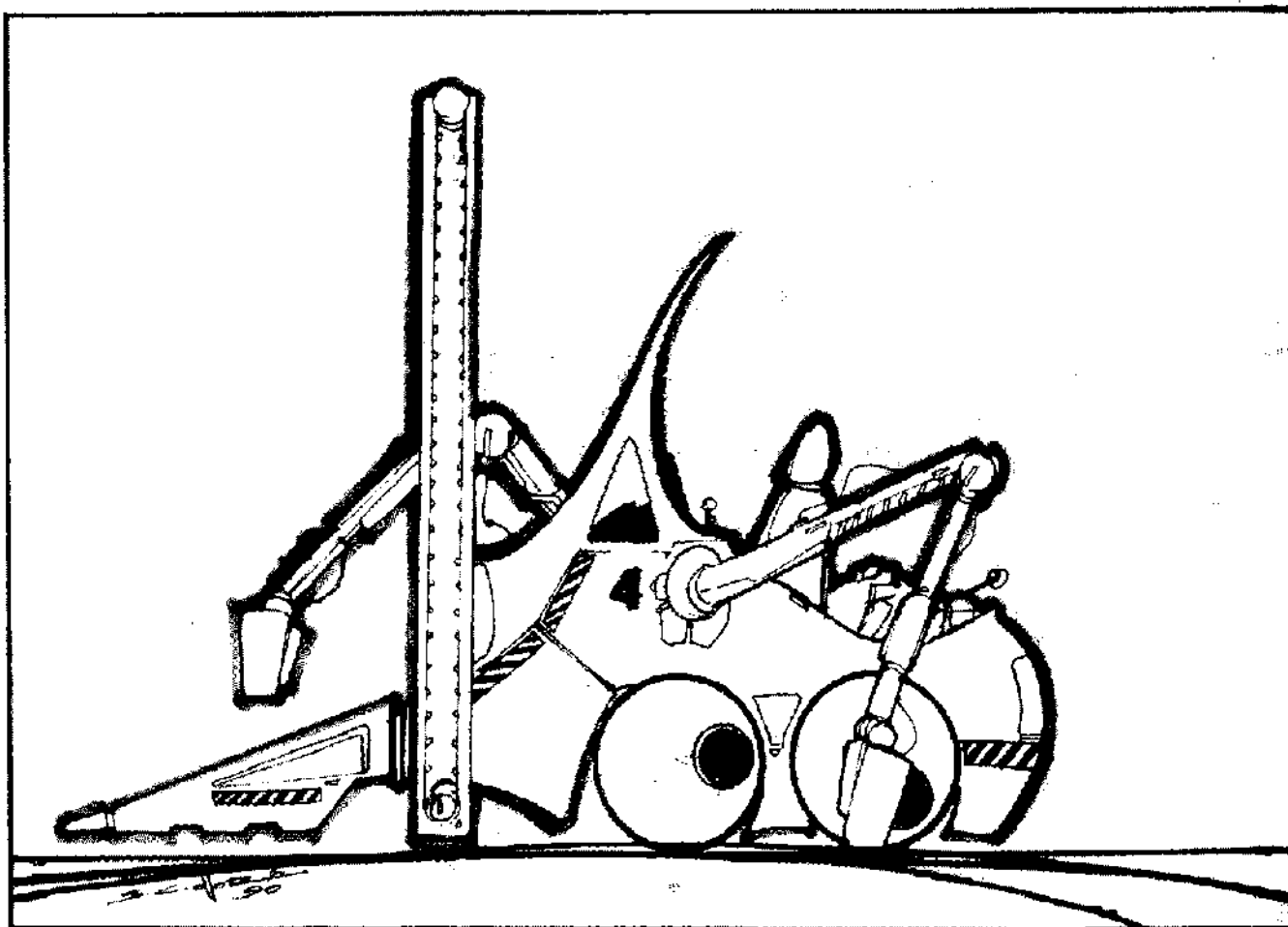

The GM/Hyundai Worker Bee

5,000eb

Cargo transport in a secure installation is at best a routine task. Free skilled workers for more important tasks by letting the Worker Bee take over most of your warehouse duties. Each Worker Bee is a semi-autonomous robot slaved to a controlling program in your mainframe. The Bee can carry up to two metric tons of cargo; half that on the main forklifts (the rest on the cargo bed), and the secondary arms can lift 400kg. Packages as small as an egg or as large as a crated Bell-15 Autogyro are easily manipulated. Onboard computers reduce the drain on precious mainframe time. They work twenty-four hours a day, never go on strike, work in the dark, and are engineered for maximum reliability.

Game Notes: The Worker Bee is typical of the remote vehicles controlled by computer systems. They are found in those industrial facilities *Cyberpunk* PC's are so fond of breaking into. They have an SDP of 60 and their tough construction is worth an SP of 20. They move at a maximum speed of 25 mph, much less when not on a smooth surface. There is a limited control station on board, just watch out for the arms—the working programs assume nobody is on board.

BELL AERONAUTICS

SPY EYE

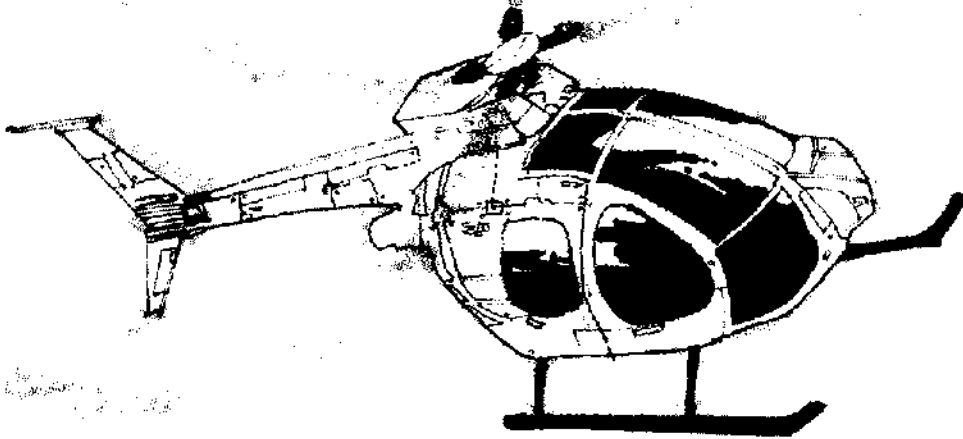

Bell Spy-Eye 18

206,000eb.

This ultra-modern helicopter is designed for the news-team that needs mobility, but can't afford an AV. The Spy-Eye is almost as fast as an AV-4, but at half the price. A Spy-Eye can give your team the edge it needs to beat the competition to the story, with full onboard computers and scanners that make the chopper a video lab in the sky, first on the scene, and first on the air. In dangerous situations you will find that the Spy-Eye is as safe as a police chopper. Although unarmed, this chopper is well-armed and maneuverable enough to get out of harm's way while filming. Satellite uplinks are a standard feature. Options include onboard Cybermodem and IR baffling to defeat AA missiles and other IR scanners (-30% vs missile hit %). The Spy-Eye is capable of operations at night, in bad weather, or through a cloud of smoke while going for that dramatic footage.

Game Notes: the Spy-Eye seats four in the relative safety (SDP=65, SP=12). The sensor net is of high quality. The airframe comparatively is pretty cheap, but the electronics are first-rate. Stations tend to use these as backups, stringers, and expendables, so the state-of-the-art equipment goes on AV's. Airspeed is 280mph, and maneuverability is high compared to other choppers (-2 from all maneuver rolls).

SIKORSKY-MITSUBISHI

DRAGON

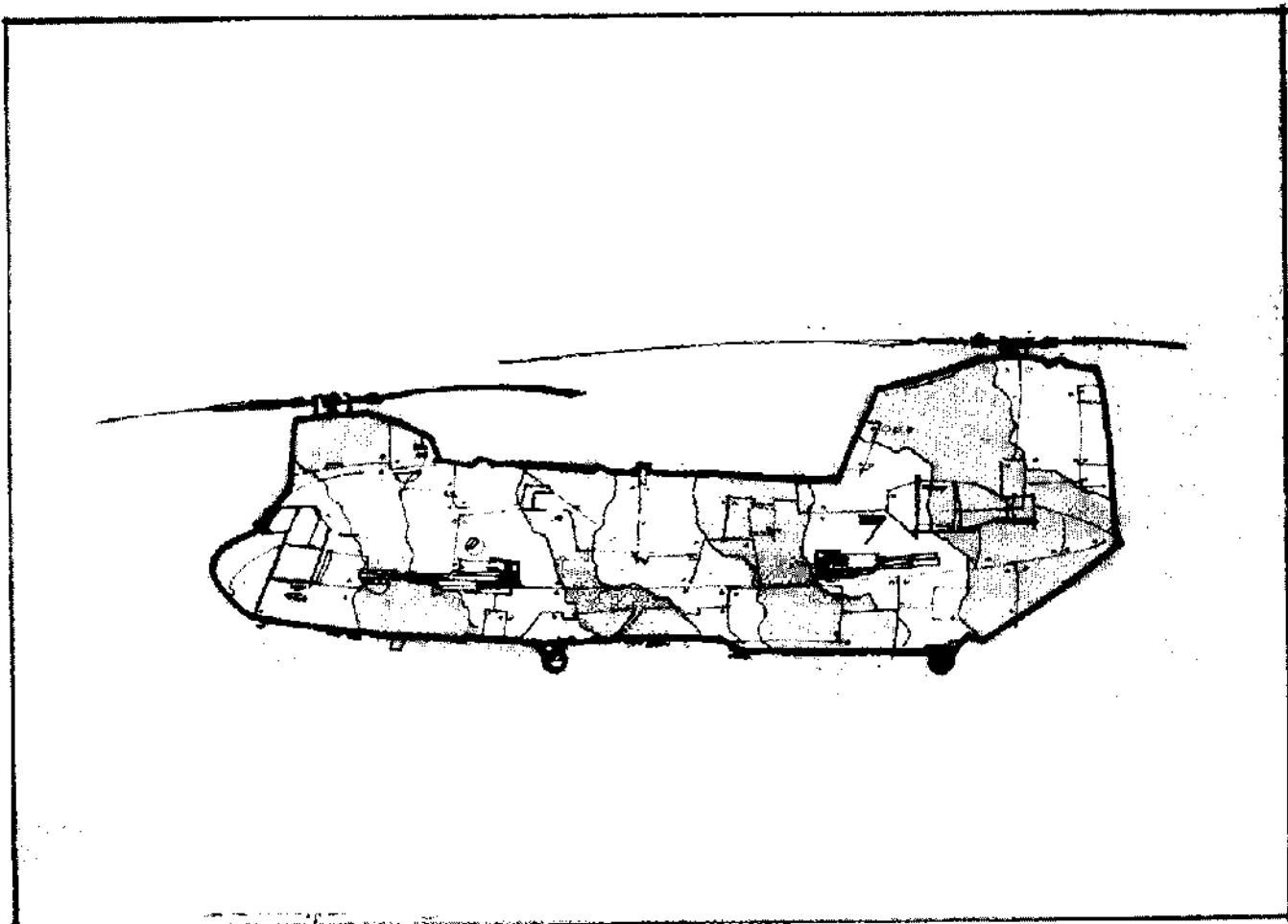
**Sikorsky-Mitsubishi Dragon****2.5 million eb.**

Following a design philosophy dating back 40 years, the SM-Dragon brings thirty troops and devastating firepower to the battlefield. And brings it quickly. This huge helicopter travels at 350mph when fully loaded! A salvo from a Dragon can cool off the hottest LZ. Rockets, miniguns, grenades, and machineguns add up to the deadliest helicopter in the world.

Game Notes: the Dragon is the most dangerous thing most Cyberpunk players will ever see. Use it as you would a real dragon—to kill big things and frighten small children. The Dragon's top speed unloaded is 420mph. It is armored to an SP of 90 and has 400SDP. Hard To Kill. Its armament is colossal (choose any 8 heavy weapons from the *Solo of Fortune* and *Cyberpunk* books to arm it). Use it for destroying whole city blocks.

AV-9

Combat Assault Aerodyne

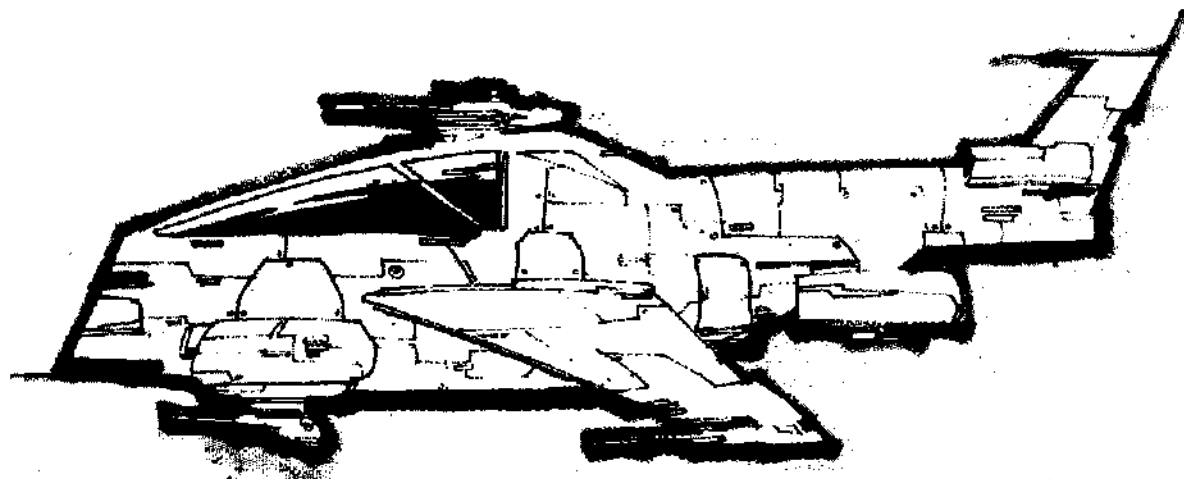

The AV-9

1.3 million eb.

The big brother to the well known AV-4 is about to make itself known! Imagine a modular-design AV where the base unit is a combat-capable vehicle. Visualize a command center with space for you and your staff to observe a battlefield with the AV-8's ultramodern sensors. Imagine the devastating firepower of a chaingun, two grenade launchers and up to four (!) outboard rocket pods. See a troop transport with space for ten of your best, delivering them where you need them, when you need them. See all this in one package, then call your salesrep before the other guy does.

Game notes: The AV-9 has a slot for a module which can contain either troop space, ordinance, or an airborne command post. It takes 10 minutes for a field crew to replace modules with full equipment. Weapons are also modular, except for two grenade launcher turrets (180 degrees each). Two heavy weapon hardpoints are fitted to the belly with power, sensor and ammo feeds into the gunship module (not usable with other modules). The outboard stabilizers may have single MG turrets and one pylon beneath each stabilizer. You get quad-fire capability by placing one rocket pod on each stabilizer, and using the belly mounts for rapid-fire launchers feeding from ammo stored in the module.

Top speed is 400mph, operational radius is 400 miles. SDP: 180, armor: SP 45 All AV-9 modes have all-weather capability, and active & passive IR sensors. A trained squad can dismount (via ropes) in 10 seconds without the vehicle ever touching ground. Weapons suite: Grenade launchers use standard grenades in a turreted launcher with a 750m range, ROF-2 and 30 rounds ammo of up to two different types (selectable each turn). Rocket pods are equivalent to the Militech RPG-A, but have an ROF of 8! They fire straight ahead with a firing angle of +/-15° off the flight path. Normal tactics are to "walk" the rockets ahead of the vehicle as it makes its strafing run. They carry either 24 (outboard pods) or 72 rounds (belly mounts, gunship only). MG's are cyberlinked MMG's firing 5.56 mm ammo, use stats for the AKR 20. Ammo=200 rounds (or 500 in the Gunship module).

PUNKNAUGHT!

Maximum violence, Maximum speed!

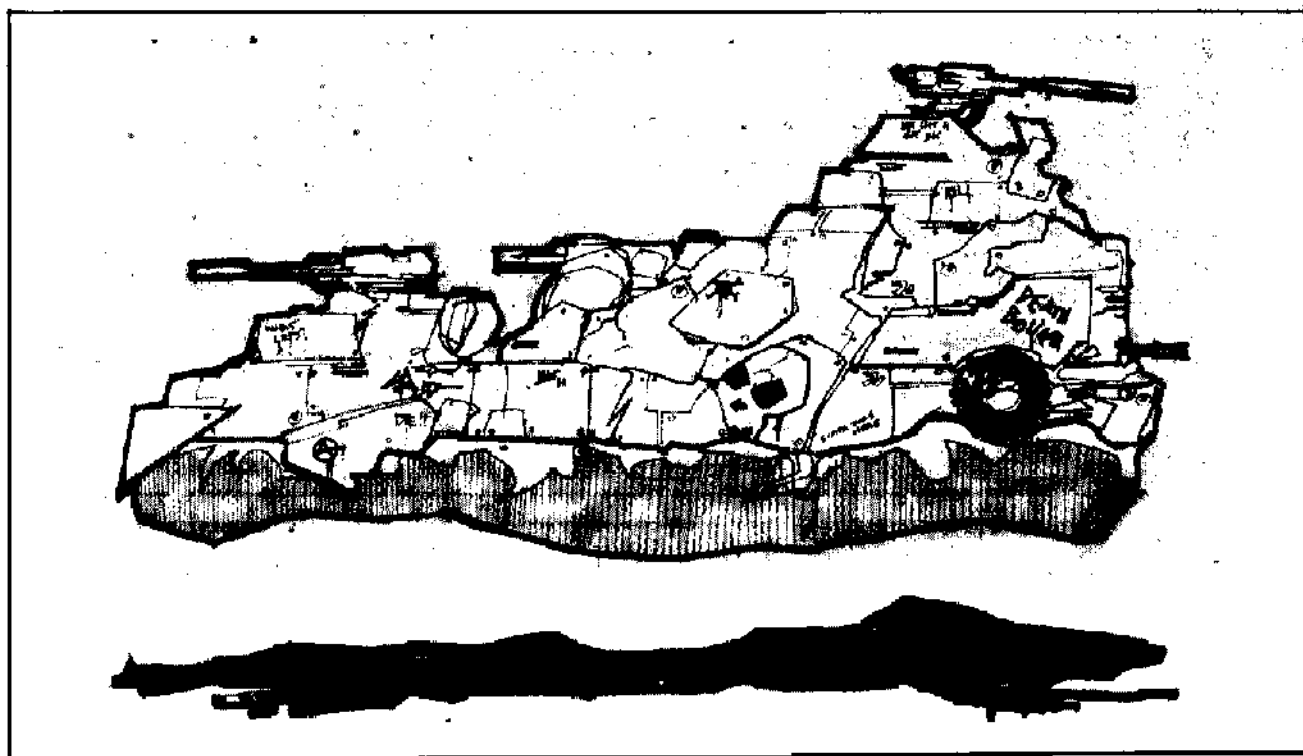

The Dreaded Punknaught!

Unknown

Every riot cop's nightmare. Take the engines from three or four downed AV's, weld them into an amalgamation of buses, flatbed trailers, and assorted junk, tack on all the weapons you can scrounge and send it charging into a police line—watch the cops scatter!! A typical Punknaught is capable of hovering a meter or two off the ground and with enough of a start can make fifty kph. They can carry twenty or thirty passengers and a crew of about a dozen. Each Punknaught is unique, and bears its own name.

Punknaughts have been built and used in London, Chicago, New York (twice), Night City, Osaka, and Manila to name the most notorious instances. They are built by gangs to smash police lines, break martial law, and engage in sheer destruction and ultraviolence. A Punknaught is a tenuous combination of machine; few gangs can support one for long, though many try. Typical armament is homemade rockets and light machineguns. Heavier guns weigh too much and eat power for servos and controls.

Game Notes: A punknaught is the streetgang's answer to the Sikorsky-Mitsubishi Dragon—if they can build one. Construction takes from a week to a month, and uses lots of scrap metal and welding torches. As a general rule, each AV engine can lift one bus or flatbed trailer in the assembly. Tradeoffs can be made for weight to allow more than the absolute minimum of armor, and no more than two gun mounts per unit (one engine's lift capacity) without serious weight problems. Lots of people can crowd on; boostergangs love these things, and love to party with them. Each 'unit' has an SDP of 60 to 80. Most areas are unarmored; controls, engines, and (hopefully) ammo and fuel are the exception, with an SP of 20 as average. Exact design (weapons available, number of engines) is up to the referee and not the designers! These things are very dramatic, and just the building can make opportunities for many adventures. Rumors exist of more advanced versions being built, but these have been ruthlessly suppressed.

Cyberware

NEW ENHANCEMENTS ON THE CYBER EDGE

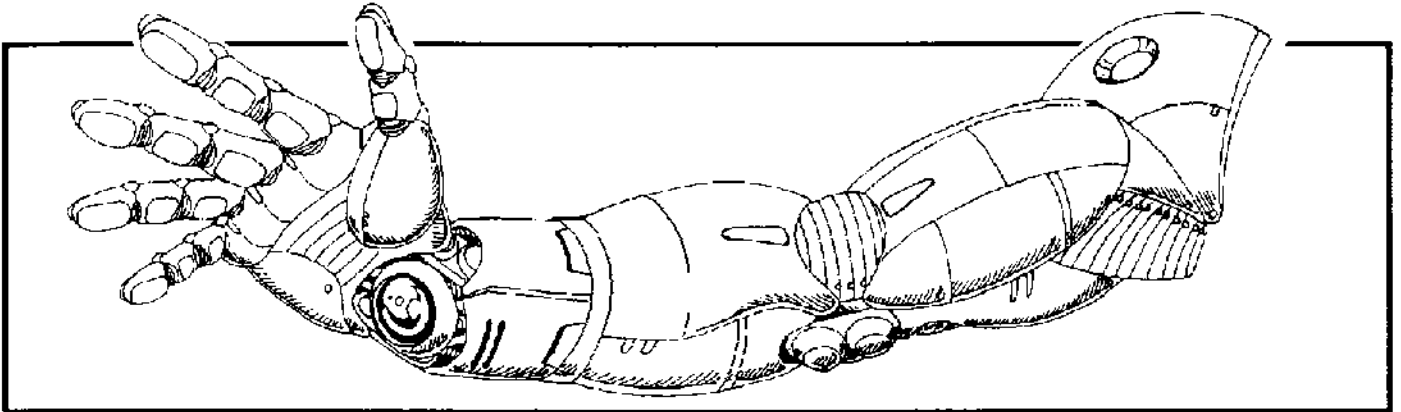

"You can't be a Cyberpunk without Cyberwear. It's what sets you apart from all those other toesuckers walkin' the Street. You know — victims..."

—Ripperjack

"The new stuff on the Street is' supa-chilled. You got optional hands, plug-in guts, skate feet now. Stuff in a couple o' rockets and cover da face with the maximum Optishield, and yo be ready, chombatta. You go make tread marks all over da tough guy's backs."

*—Lord Molo
Leader of the Boogiemen*

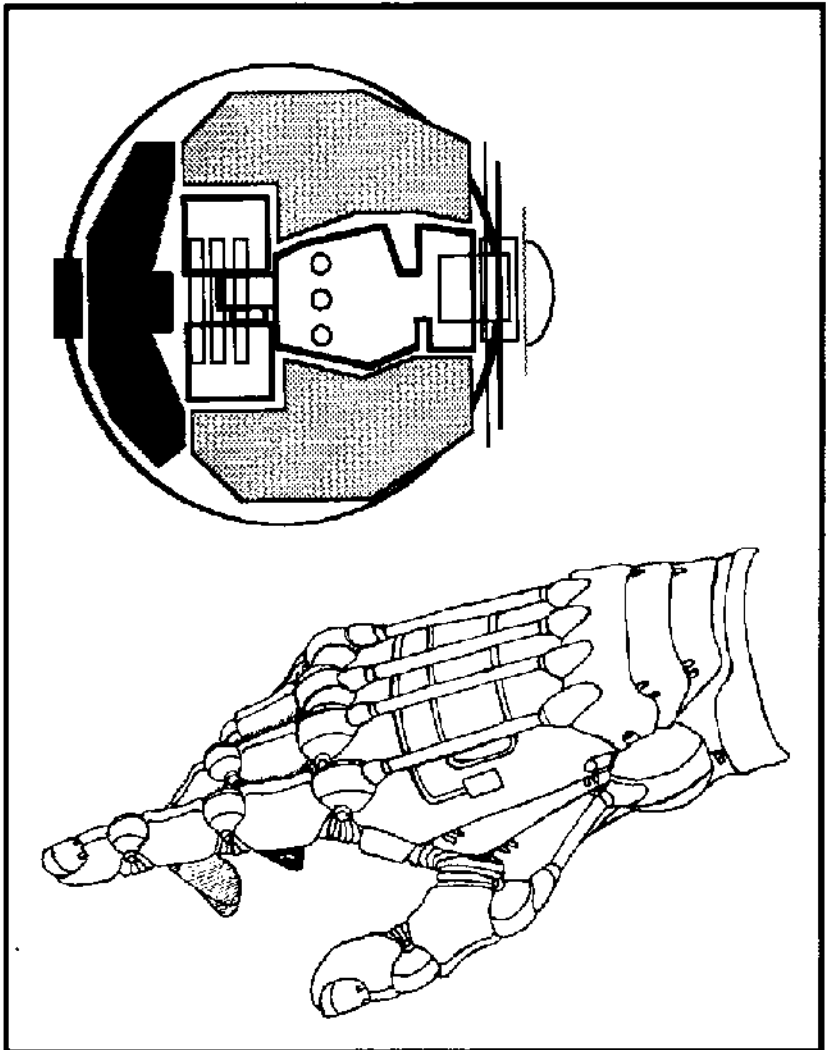

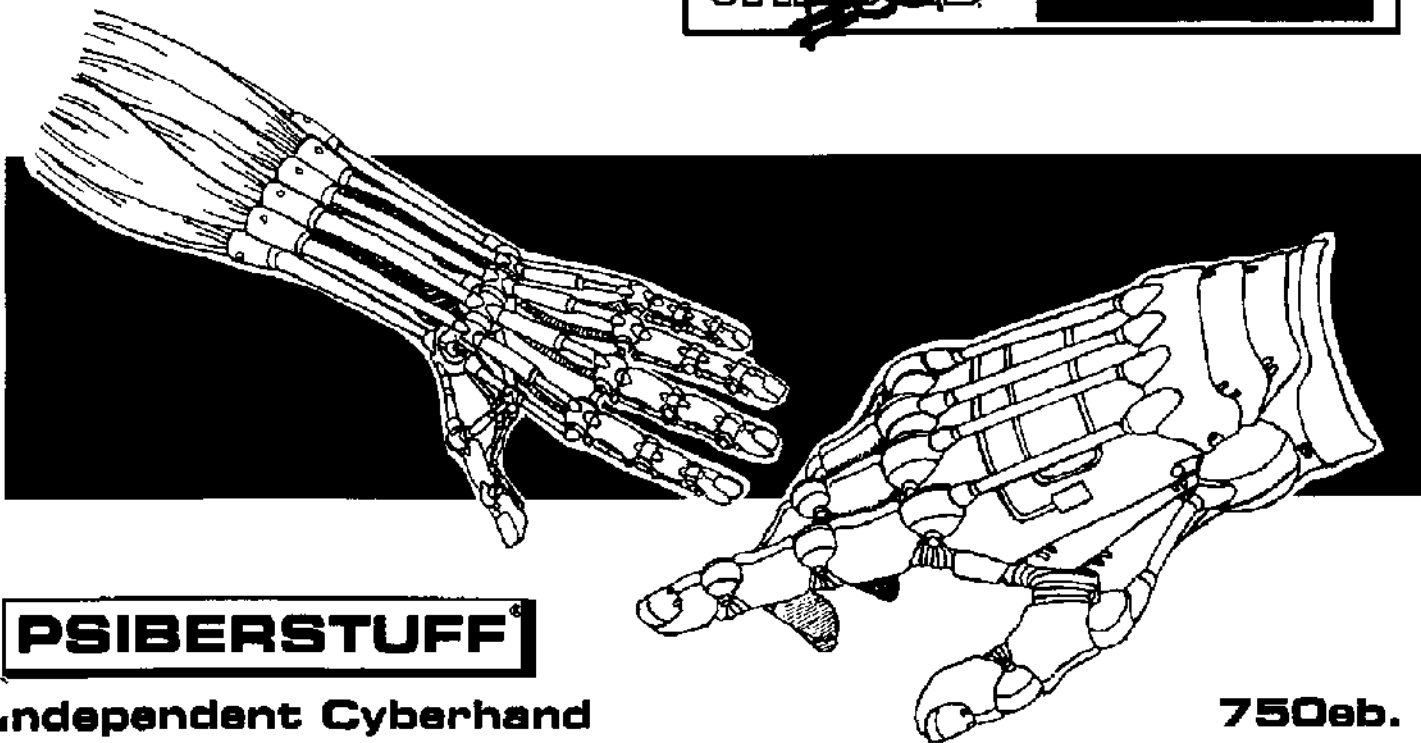

PSIBERSTUFF®

Independent Cyberhand

750eb.

For those who've lost a hand, not an arm and a leg!

From Psiberstuff—This new cyberhand has a 1D10 crushing strength (it doesn't have the actuators of an entire arm backing it up), and can hold 4 optional fingers (or 1 option installed in the hand as a whole). The hand takes 7pts.(structural damage) to cripple and 10 points to destroy. RealSkinn™, Superchrome®, or armor coatings are 100eb. each. HC=1D6.

KIROSHI®



OptiShields® 300eb.

Ultimate in style and function !

For maximum effect! Kiroshi Opticals has introduced their new Shields for those who KNOW that style is everything. The bulletproof mirrorshades are built into housings in the forehead and orbital ridge. These mirrored lenses enclose the eyesockets and have a SP of 8 (1-3 on d10 for a headshot to hit the lenses). The eyes are permanently protected from all irritant gasses and the Anti-dazzle feature is standard. HC=1D6+2.





Dynalar Technologies

DIGITS® Cyberfingers

A new line of cybernetic fingers from Dynalar Technologies! Compatible with any standard cyberhand or cyberarm; easily installed in the privacy of your own home.

a) Dartgun **100eb.**
Compressed-air dart (3m range) similar to cyberoptic weapon from CP 2020. HC=2.

b) Lockpick **50eb.**
A concealed and "handy" breaking and entering tool. HC=.5.

c) Light Pen **45eb.**
Used to write on computer screens and graphics tablets. HC=.5.

d) Mini Light **25eb.**
A narrow beam 25m in length. Batteries are replaceable (1eb); last 12hrs. HC=.5.

e) Finger Bomb **150eb.**
To be detached and thrown, it inflicts 2D6+3 damage to all targets in a 3m diameter. Caution: Black market cyberware in some states. HC=2.

f) Scissors/Wirecutters **50eb.**
A pair of cutters is built into the middle and index fingers. They inflict 1D6/3 if used as weapons. HC=1.

g) Mace Sprayer **150eb.**
Holds 2 bursts of incapacitating mist (-4 to REF and Awareness skill for 1D6 combat rounds). An Average difficulty roll to hit the facial area if target is surprised; a Very Difficult roll if not. HC=2

Dynalar has all these and more—act now and we'll buy back your used cyberfingers at 30eb. each!

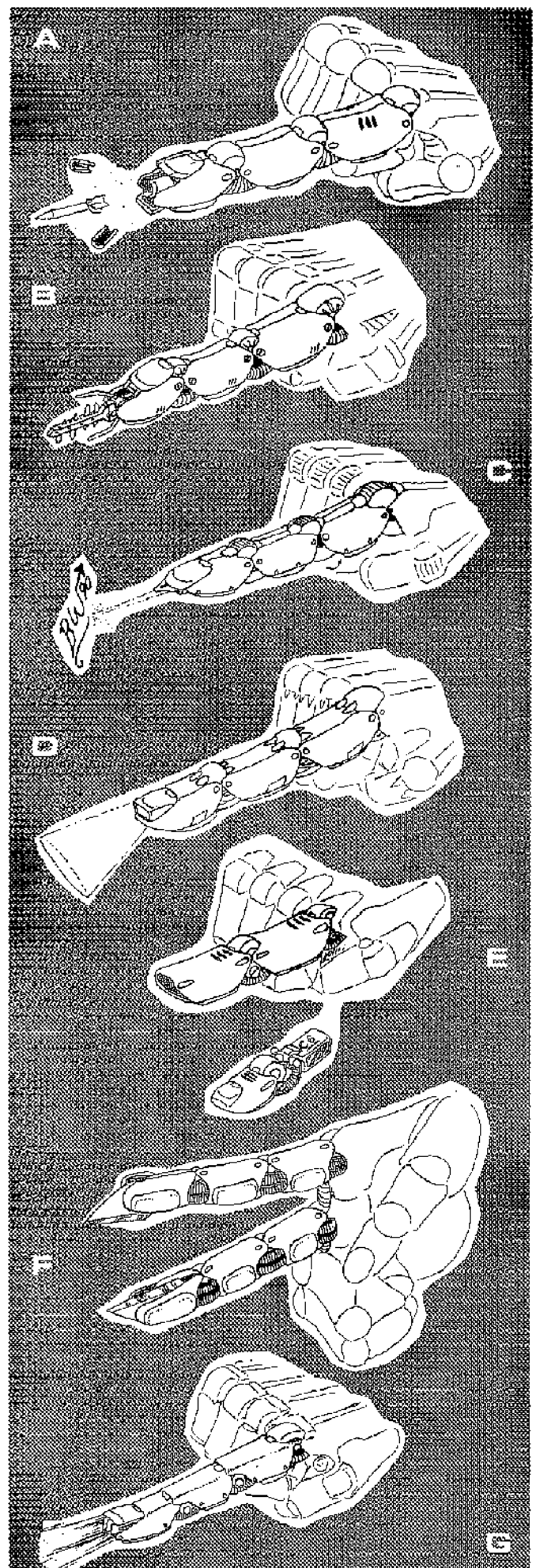

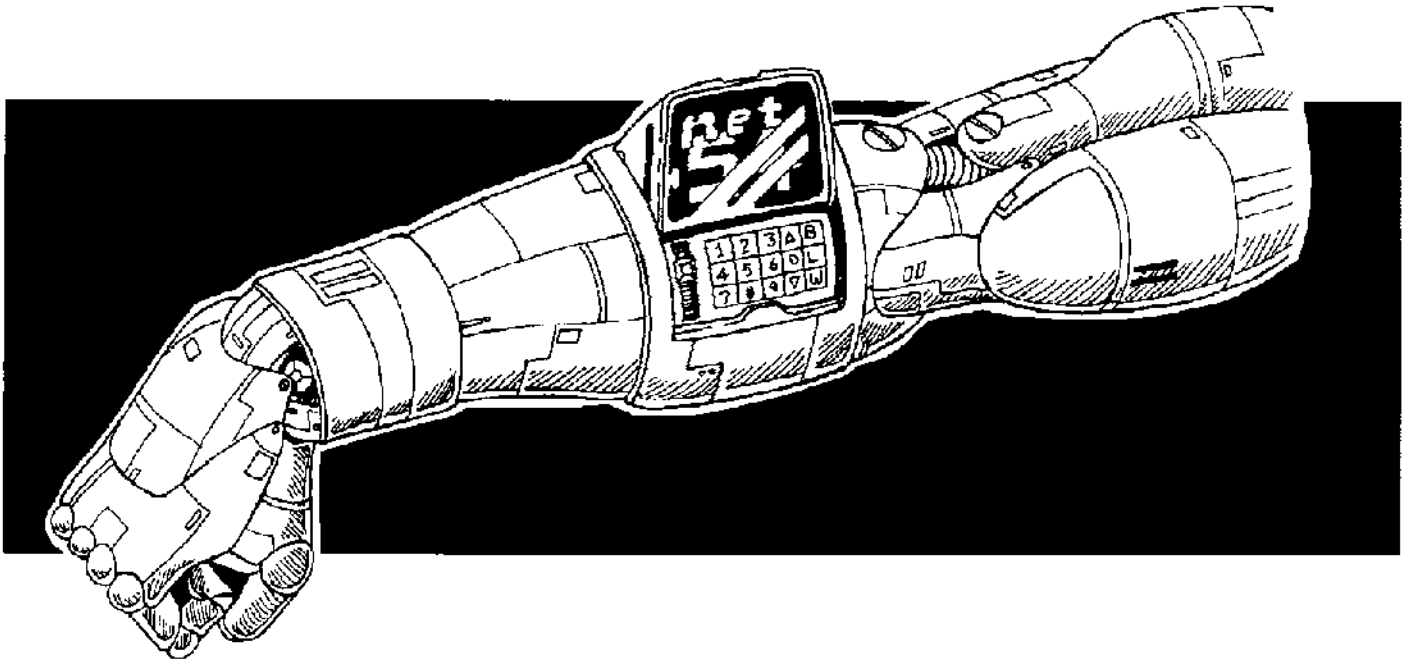

Watch-Man®

180eb.

Cyberarm option from *Psiberstuff*. This miniature TV can be installed into any cyberarm, giving the user a 7.5cm x 5cm screen to watch when he needs to get the news, replay video chips, or is just bored. HC=1.

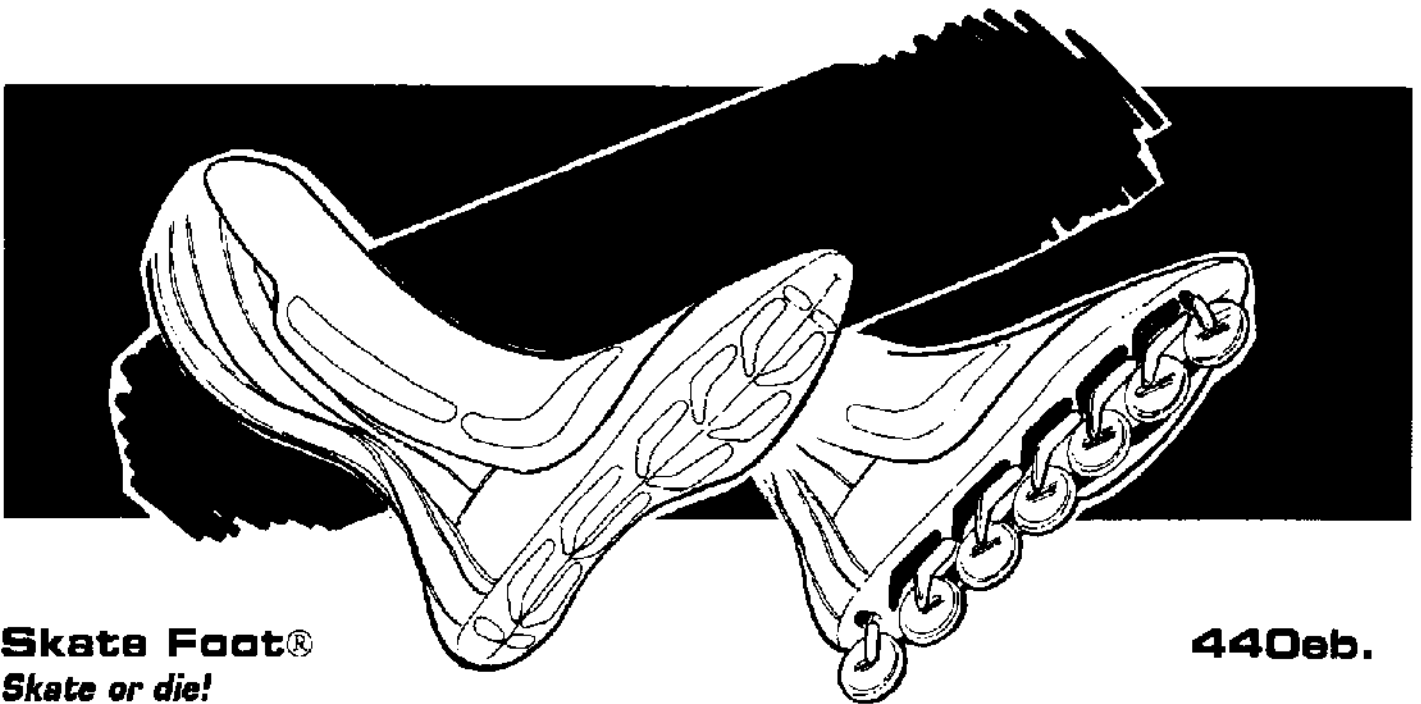

Skate Foot®

440eb.

Skate or die!

This motorized foot module (for installation in cyberlimbs only) is fitted with four chain-driven, super-grip wheels which fold up behind the heel when not in use. Once activated, micro-hydraulic servos slide the wheels down beneath the feet and... ZOOM!! Beat the rush hour traffic by reaching speeds of close to 35mph (an effective MA of 20+ !) in under half a minute (but beware of road rash). HC=1D6. NOTE: subject needs *Skating* or *Athletics* skill for effective use.

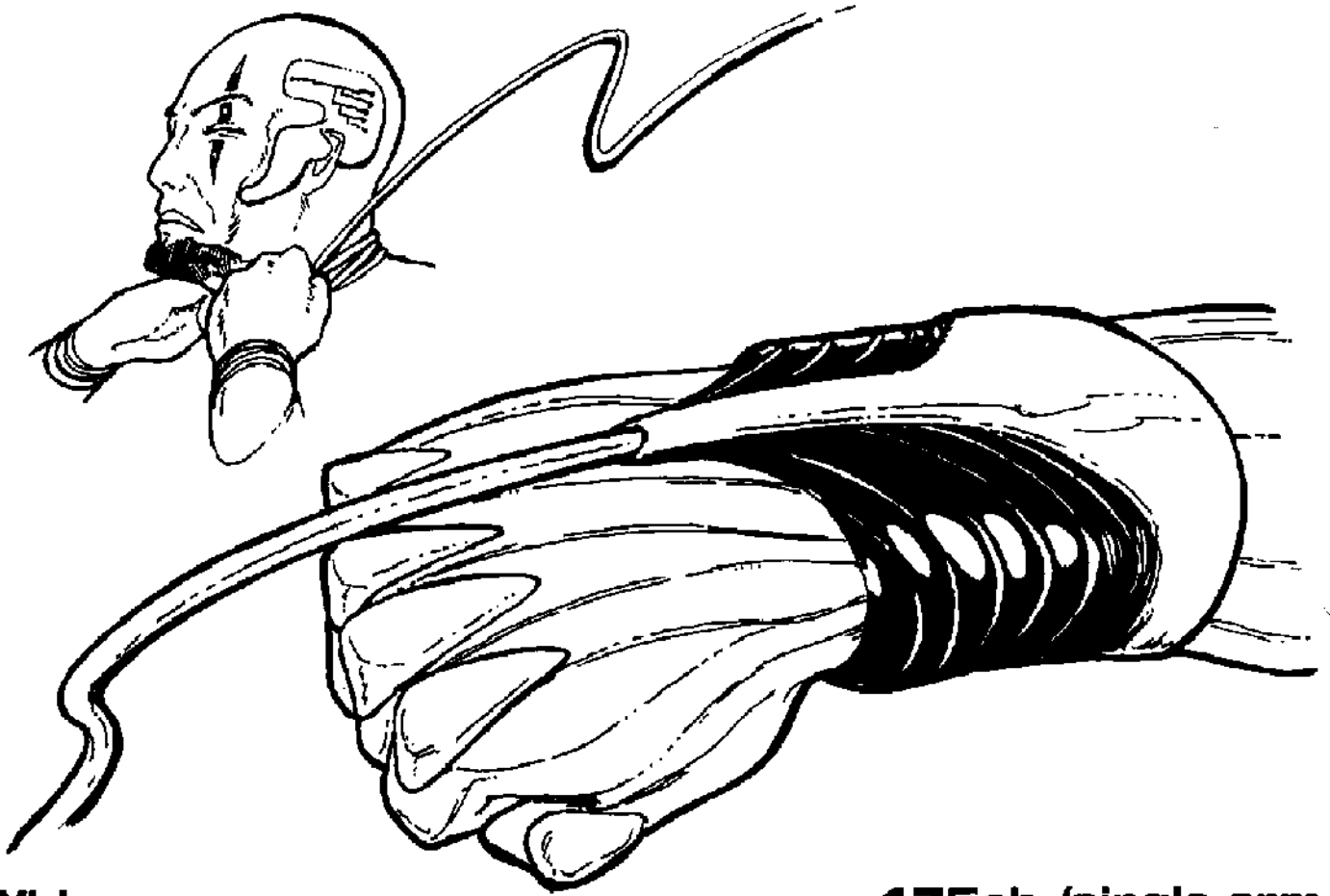

Whip

475eb./single arm

Always keep your enemy within reach !

Cyberarm option. A 2.2m long alloy tentacle that can either whip for 1D6/2 damage, strangle for 1D6 damage per combat round (target must make Difficult BOD or REF roll to escape), or act as a short-range grapple. HC=2D6.

LimbLink™

100eb.

Cyberarm option. Using a "smart"-monocle on a cable connected to the cyberarm's limb-control interface, this turns any cyberlimb pop-up gun into a Smartgun (+1). You do not need a separate neural processor module for this link. HC=1.

Magnetic feet/hands

60eb./pair of limbs

Small electrostatic adhesive surfaces are placed in the soles or palms of cyberlimbs. These are for use in Low Earth Orbit, allowing the subject to walk on walls and ceilings. HC=0.

Gas Jet

275eb.

The last word in chemical warfare.

A pressurized cannister of gas (any type) with a 6 use capacity is installed in a cyberlimb (normally the arm). Range is 2m. Effects depend on the type of gas used (sleep, blister, nerve, poison, etc.). HC=1D6+3.

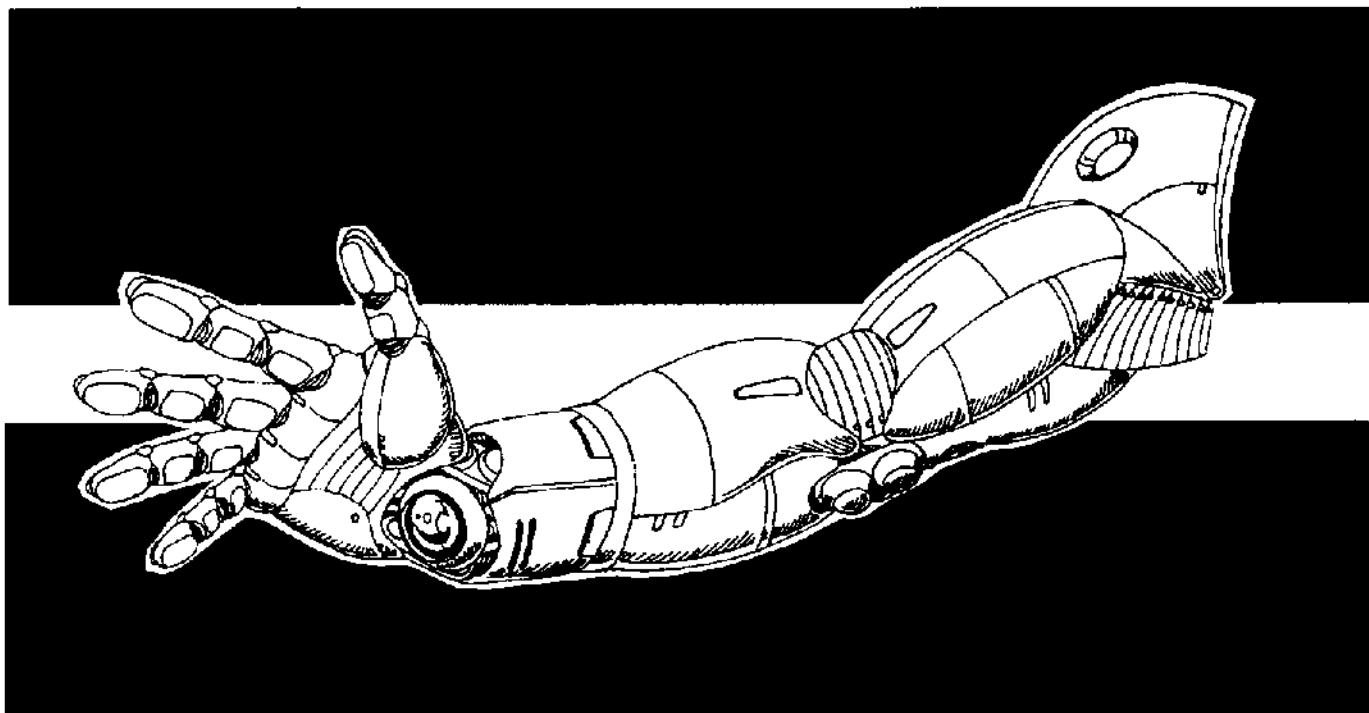

Flashbulb™

250eb.

Make 'em "see the light"—for the last time.

A 20,000 candlepower strobe installed in the palm. It effects a 4m diam. cone with a 6m range. Target must make a Difficult REF roll (add *Dodge* skill) to shield eyes. Failure means an Impossible COOL roll (add *Resist Torture* skill) to avoid convulsions or psychomotor paralysis for 1D6 min. Surprise attack increases REF roll to Very Difficult. Cyberoptics or goggles with anti-dazzle make a person immune to this type of attack. HC=1D6/2.

Wet Drive

320eb.

+175eb./extra memory

Computer crash? Never lose critical data again. Forgetful secretary? No longer. Intruding Netrunners? No problem.

Installed at the base of the skull, CYBERMATRIX's new silicon solid-state storage allows the user to store 1MU of file-only memory in the head (the Read-Write Memory is loaded and downloaded through interface plugs). A code-lock can be applied, if necessary, and the data will be loaded or downloaded only after the access code is entered. The user cannot access the information, but it's a very secure place to store hot data. Order soon, and get an extra 1MU of storage for only 175eb. HC=1D6.

Voice Pattern

350eb.

An AudioVox option (of dubious legality) which, when used in conjunction with cyberaudio, Wearman, or interfaced to a sound system or audio tape/chip player, allows the user to exactly emulate the voice pattern of another person.

Game Notes: this allows the player to pass for someone else in conversations and fool voiceprint scanners. HC=2.

Forked Tongue

350eb.

Now anyone can be a smooth talker.

Employing ultrasonics, this A-Vox option (also dubiously legal) makes a listener subliminally susceptible to suggestions (+1 to use of *Persuasion/Seduction* skills). HC=2

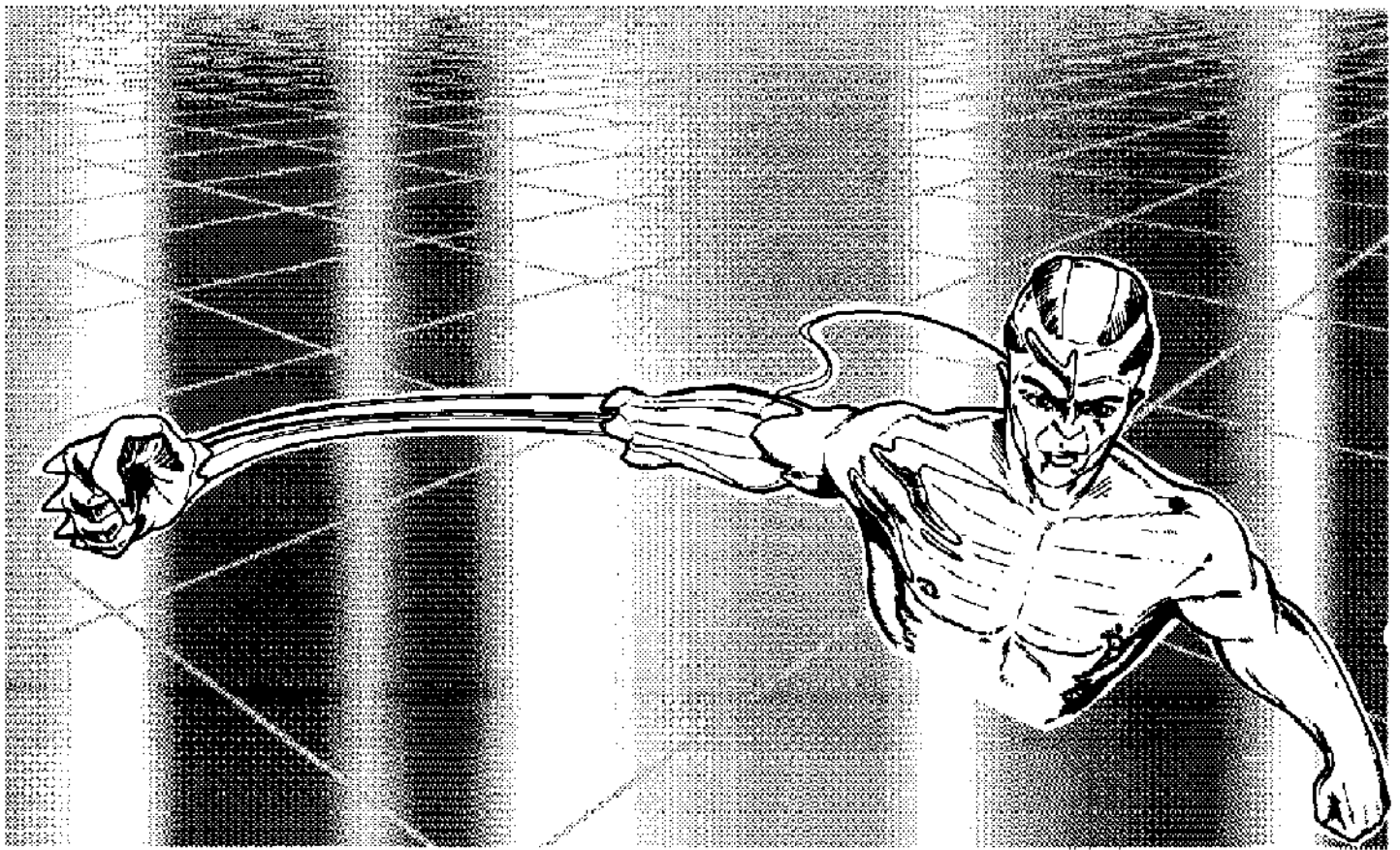

Mace Hand

300eb.

A very heavy hitter! The Mace Hand is a high-density, weighted club which can be smashed into a target, delivering 2D6+1 damage (1D10-2 when used as a fist). Furthermore, the Mace can be extended on 1 meter of heavy cable, allowing a longer range and flexibility of attack (1/2 damage gets through a parry). A must for devoted combat gangs! HC=3.

Game Notes: The Mace Hand is not well articulated; there is a permanent -2 REF penalty for any actions attempted with that hand.

Icer™

200eb.

Cyberarm option. A CO₂ fire extinguisher built into the forearm. Range is only 2m. If used as a weapon, target must make a Difficult REF roll to avoid being blinded for 1D6/2 combat rounds. HC=1D6/2.

RAVEN®



MICROCYBERNETICS

Rebreathers

700eb.

Tired of having to buy a breath? No longer! Living in the Big City? Why wait for consumption or cancer to get you tomorrow when you can have Raven Microcyb's new organware today? With their new Rebreathers, the lungs are cyber-enhanced with synthetic filters and O₂ superchargers. A breath can be held up to 15 minutes! RM's Rebreathers can be adjusted by a doctor to filter out toxic gasses 55% of the time (but not surface irritants like mace or mustard gas). HC=1D6+1.

Cutting Torch

100eb.

Cyberhand option. Equivalent to a blowtorch with a 10cm flame, 2.5 minute duration. Does 1D6-2 damage if used in combat. Can cut through metal, plastic or wood up to SP 20. HC=1D6/2-1.

Derringer

220eb.

Cyberhand option. 2-shot pistol built into cyberhand, with stats equal to 5mm Budget Arms C-13 (P•1•P•E•1D6(5mm)•2•2•ST•50m). HC=1D6.

BODYWEIGHT

Life Preservation Systems

Decentralized Heart **1300eb.**
Reduce vulnerability, increase survivability!

Don't put your heart on the line. Replace it with synthetic implants that disperse the chambers, main arteries, and main veins to three areas within the torso. This cuts down on the critical damage done by a single wound. With this implant, a player adds 2 to Death Saves caused by torso injuries. HC=1D6+4.

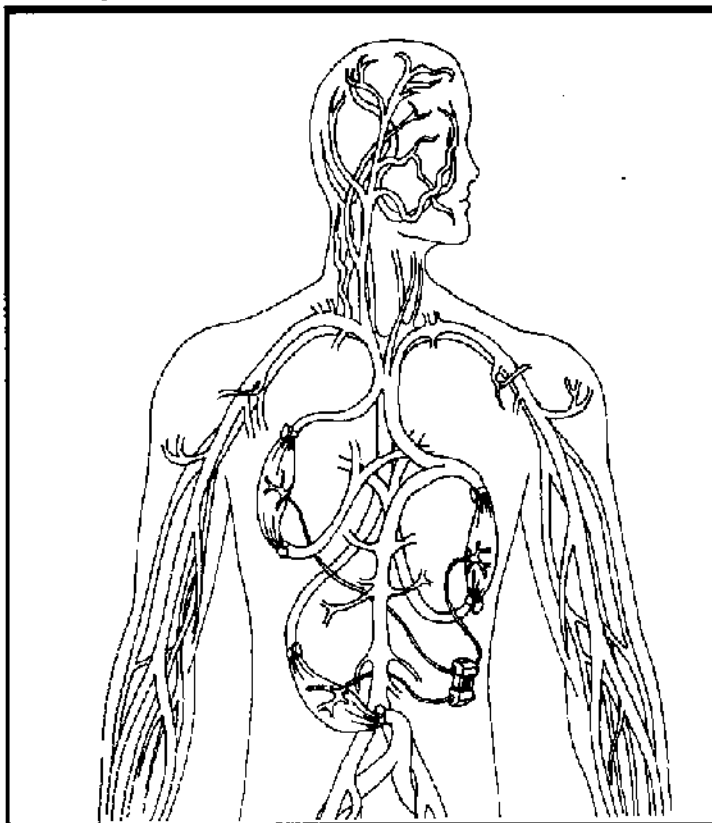

PACESETTER® Sport Heart **900eb.**

Bodyweight now offers a new sporting heart for the physically oriented. This rapid-action turbopump implant is capable of increasing circulation many times over, effectively boosting physical performance. This will temporarily boost Movement Allowance and Body stats by 1 when the heart is kicked into "overdrive." (Game effect: this alters run/leap/lift and all BOD skill rolls except BTM and Death Saves. Death Saves are at -1 due to cardiovascular overpressure.) HC=1D6.

Surgeon General's Warning: use of such organware for more than four minutes can cause torn ligaments, muscle damage, and hyperventilation (At the time limit, roll a D10, if roll is under your normal BOD stat, no effect. Subtract 1 from your BOD for every minute over 4 you use the implant. If the roll goes over your stat, take 1D6 damage and halve your BOD stat for the next 4 minutes!).

T-MAXX "Cyberliver" **450eb.**

No more DUI's!

You can party longer with the T-MAXX Cybernetic Blood Filter. Micropore Filter units equipped with the new T-mx2 electrochemical diffusion process can filter out up to 98% of blood alcohol, and even remove most cardio-vascular transported poisons. This unit protects you from the adverse effects of drugs such as Smash, 'Dorphs, even Purple Pause. Enjoy the party without the side effects. (The character gets a +4 to all stat rolls involving the effects and addictiveness of drugs and ingested poisons, plus 90% effectiveness in neutralizing all types of alcohol.) The new, deluxe T-MAXX II (850eb) is equipped with a convenient fluid rerouting system, to let you enjoy a night off. HC=1D6.

PACESETTER 2000™ Overdrive Heart **985eb.**
More power, more action, greater endurance!

Pacesetter 2000™—"I couldn't have made my 83rd home run without the Pacesetter 2000! That extra pulse of power really made my season!" Baseball superstar Ray Isaac and other world-famous athletes agree—the Bodyweight Pacesetter 2000 is the *ultimate* in high-performance organware. This sophisticated heart's "overdrive" boosts Movement Allowance and Body stats by +2 when activated. *Power On!!!* HC=1D6 (Effects and penalties are the same as the original Pacesetter, except that the safe use time is only two minutes.)

TimesSquare Plus™ 500eb

Never forget. Always where you need it. Information to make you a maximum cyborg! NEW From ZETATECH! Just recently declassified, the new TimesSquare Plus™ cyberoptics upgrade integrates your cybereye with a cognitive-reflex processor and a DataTerm link or chipware plugs. Special chipware allows visual recognition, identification, and information retrieval. Full integration with the Farley File™ database allows you to access needed information easily and quickly, displaying the records on your Times Square Plus marquee. This upgrade can also be used with the new Video Imager cybereye. (See the Chipware Section, pg. 76 of this catalog for further information.) Takes 3 options. HC=2. Half price if done as an upgrade.

Wearman Mark II 200eb.

Nobody wants to go 'borg for a sound system!

Do you long for the luxury of cybernetic stereo, but can't have one because the doc says your body won't handle full cyberaudio? Advanced Audio Systems comes through again with the newest generation of audio entertainment! The Mark II Wearman implant can be installed at any clinic in an hour and a half—micro speakers are housed in the bone of the skull next to the ears, and a laser-optic reading surface is located beneath the ear. Simply place the microdisk into the synthi-skin pocket and rock on!! HC=0.

Tazer Grip 180eb.

Cyberarm option. Miniature electrical contacts in the thumb, first, and middle fingers deliver a multi-Kilovolt static charge to the target. Effects are equal to the hand-held tazer ("Punk 2020, pg.53). HC=2D6-2.

E-Monitor 185eb.

If you make a mistake in space, odds are, you won't live to make another.

Going LEO? Worried about the vac sneaking up on you? The Cyber-Sniffer™ brand e-monitor is the ultimate environment tool for the highrider of tomorrow. The Sniffer has a built-in barometer to check air pressure and can be programmed to observe and report on physical symptoms caused by changes in pressure or atmosphere composition (it will monitor levels of CO₂, oxygen, C-monoxide, and nitrogen with 90% accuracy). The information is displayed via subdermal LEDs on your arm or leg. An excellent way to know when the air is going bad or cabin pressure is too low. Along with all these features, electromagnetic hardening is standard. HC=1.

Mag-Duct™ Spots 220eb.

For the fashion minded !

For those who are appearance conscious, but still need an interface, DSI's sub-dermal magnetic induction plug allows full interface ability while retaining your "unspoiled" appearance. Implanted just below the skin (with only two metalized "spots" showing), a wristband and cable jack allow you to plug into your cyber device, reading the signals by mag-field induction. (No cybermodems; -1 to interfacing controls with all other devices.) The manufacturer suggests using low-impedance cables with this installation. HC=1D6/2.

Gyro-Stabilizer 1000eb.

Raven Microcyb's gyro-implants give the cyber-man of today perfect balance! Using an automatically triggered gyroscope and balancing fluid reservoirs mounted in the skull, the subject will not suffer from dizziness due to a sudden change in orientation. This provides a +2 on Space Sickness die rolls (*Near Orbit*, pg.12), and an automatic +1 Skill in *0-G Maneuver* (*Near Orbit*, pg.13). The owner will also have a +1 bonus to any *Athletic* skill maneuver involving extended balance. HC=1D6.

Dodgeball™ 440eb.

You'll be one step ahead of them!

This cyberoptic option from Kiroshi Optics consists of a logic processor keyed to predict movements of the human body according to established patterns of body language. The device will enhance the user's close-combat capabilities, allowing him/her to predict an opponent's offensive or defensive actions. This increases the user's Brawling, Martial Arts, or Melee Weapons skill by +1. The user must observe his opponent for 3 regular turns (30 sec.) in order to 'work in' his moves. Uses 1 option space. HC=1.

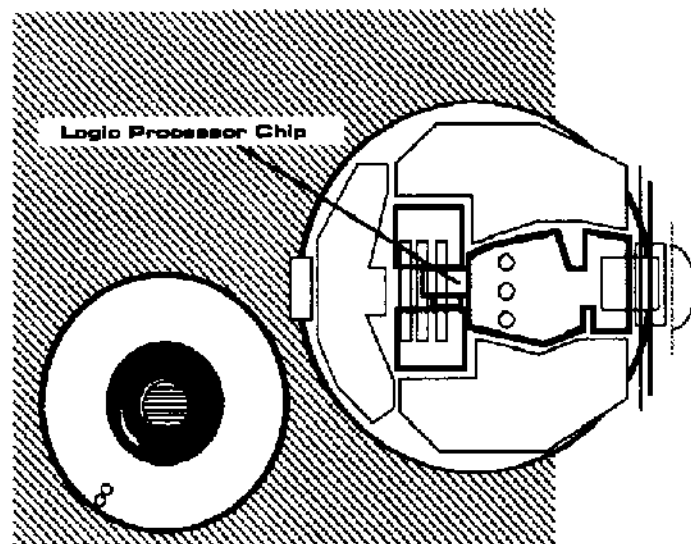

Video Cam/Transmitter 330eb.

Never miss the picture, with Kiroshi.

Cyberoptic option. Sends whatever image the subject sees as a constant live feed to a remote monitor. Range is 1 mile. Takes 4 options. HC=1.

Lifesaver™ Skinweave 4,500eb.

Reading this ad could save your life !

An enhanced version of the *Enhanced Antibody treatment* (2020 pg. 75), Lifesaver also incorporates a limited form of skinweave similar to *SpraySkin*. It seals torn blood vessels and counters the more extreme effects of shock. The patient therefore advances Death Levels once every four minutes instead of once every minute. Critical wounds do not advance to Mortal as long as the patient isn't exposed to rough treatment, and the healing rate is +1 point/day. Each time the subject sustains a wound higher than Critical, he/she needs a maintenance treatment costing 1000eb. HC=(1D6/2)+1.



Video Imager 350eb.

For images only you need to see.

An advanced form of TimesSquare, this option allows the user to receive vid images (via telecommunications transmission or interface plugs) that are displayed internally. Takes 2 options. HC=2.

Anti-Plague Nanotech 1,750eb.

Improved antigens and mutated T-cells provide increased immunity against serious diseases. A number of pharmaceutical companies provide updates to maintain parity with the latest biowar developments. The user gets +3 to BOD rolls vs. contracting diseases or vs. the effects of biowar agents. HC=.5.

Cyberoptic Teargas Sprayer 200eb.

Why carry mace? Just look him in the eye.

A one-shot burst of gas with a 1m range, blinding target for 1D6 turns. Cyberoptics are affected. It requires a Very Difficult roll to hit the facial area, dropping to an Average roll if surprise is achieved. A failed roll may affect the user! (Referee's choice) Takes 2 options. HC=2.

Frequency Changer 100eb.

This circuit switcher gives the user an option of up to 6 channels on his radio splice. HC=0.



Gang Jazzler

600eb.

"Shocking" newtech from CYBERMATRIX!

The installation consists of small, highly conductive needles housed in insulated forefinger sheaths. These are wired to a powerful minibattery. This battery, located in the forearm, has enough of a charge for 3 lethal surges (if the victim fails a BOD roll of 20, he is immobilized 1D10+1 minutes; if he's hit in the head or torso and rolls less than 15, he's dead. He may add his *Endurance* skill to this roll). Soft body armor up to SP 3 can be penetrated. Contact (a solid combat grapple) with cyberware has a 10% chance of completely shorting out non-insulated cybertech. Gang Jazzlers are black market cyberware in most judicial regions. HC=2D6+3.

WEAPONS

ADVANCED COMBAT TECHNOLOGY 2020



Goncz-Taurus Autopistol (pg. 44)

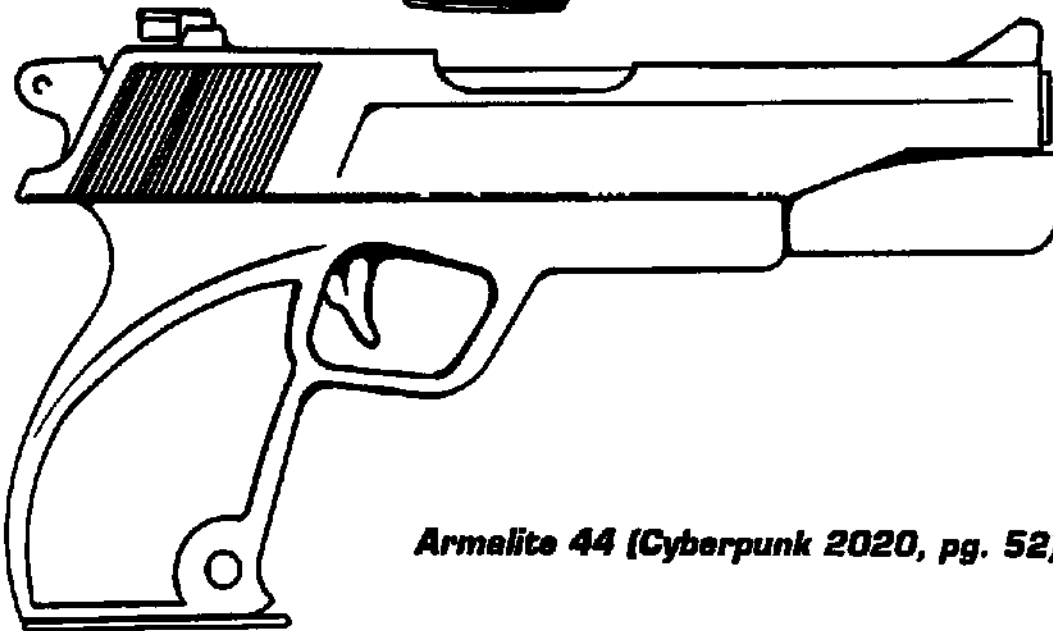

Armalite 44 (Cyberpunk 2020, pg. 52)

"On the Street, there's no room for excuses; for hardware that doesn't work or equipment that doesn't perform. You can't demand a refund with a bullet in the brain, and a lawsuit's pretty problematical when you've been parted out to the local body bank. You want the best weapons euro can buy, because the alternative is the costliest of all— your life."

*—Morgan Blackhand
The Enforcer's Handbook, 2017*

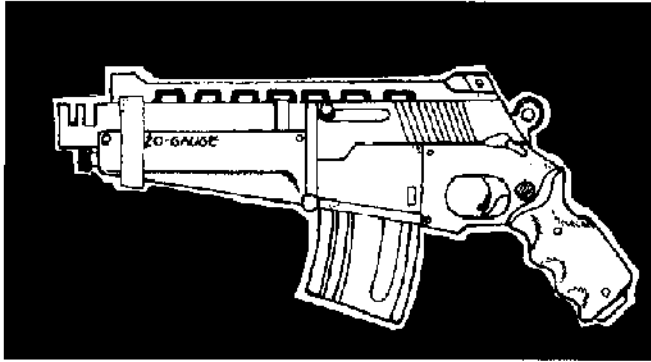

Militech Crusher SSG 450eb.

SHT -1/-3 J C 3D6/1D6+2(20 Gauge) 6 2 ST

This pistol-sized shotgun was developed during the 2nd Central American Conflict for close combat and roomsweeping duties. The Crusher is a handy weapon in 20ga., with its box-type magazine and 10in. barrel, but not very accurate.

Game Notes: due to "whipper" styling — stockless, short barrel; the weapon is -1 to 12m, -3 to 25m, and ineffective beyond that. The damages correspond to the two ranges.

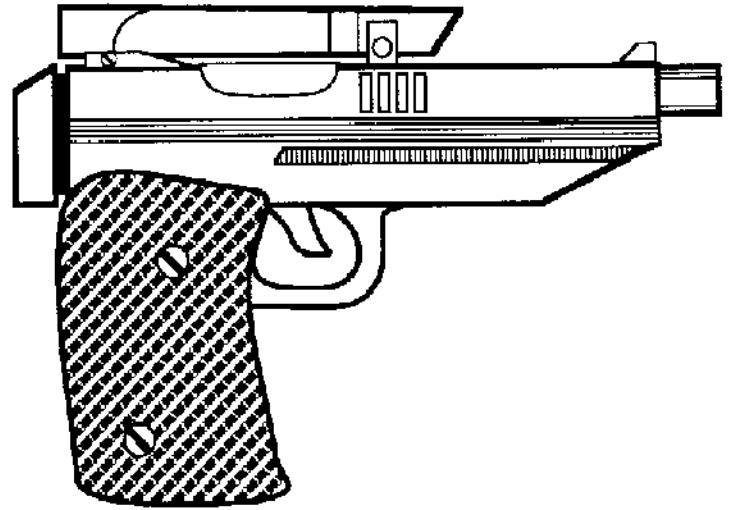

Budgetarms Laser-Niner 675eb.

P 1 J/L P 2D6+1(9mm) 15/35 1/3/20 ST*

A quality auto/machine pistol, sleek in design, which fires 9mm caseless rounds. Made to security specifications, it is built for combat, employing an integral lasersight and 3 round burst/full-auto firing mode. It has a 15-shot magazine, but for assault ops it can be fitted with a 35-rnd. "snail" clip (concealment rating goes up to "L" when the snail clip is loaded).

Game Notes: normal WA rating drops to 0 if SmartLinked, due to integration of existing laser sight.

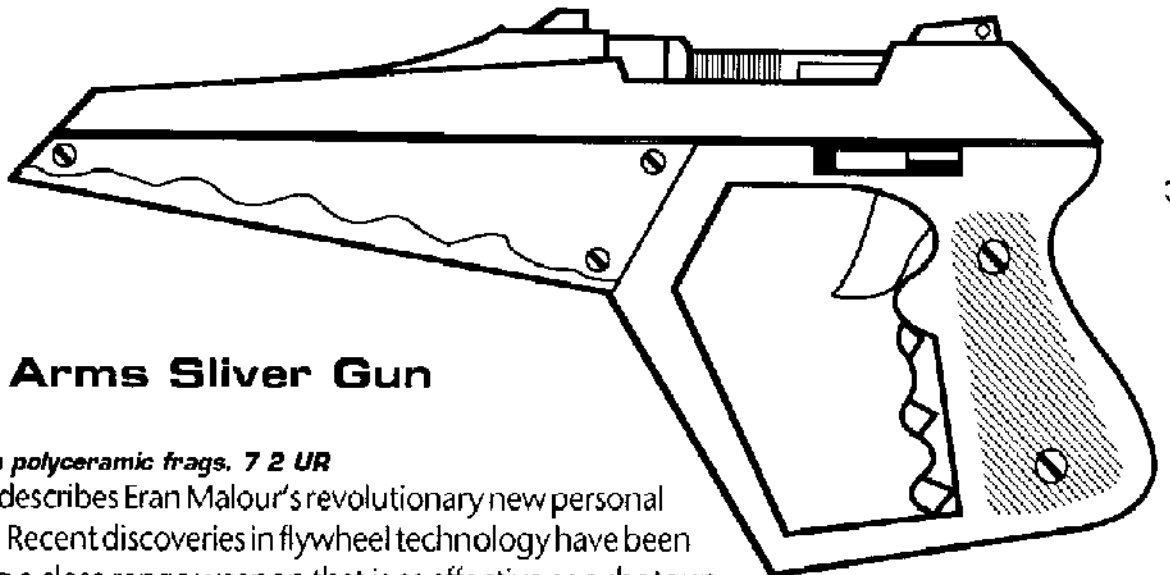

Malorian Arms Sliver Gun 375eb.

P 0 J P 2cm x 2cm polyceramic frags. 7 2 UR

Quiet and deadly describes Eran Malour's revolutionary new personal defence weapon. Recent discoveries in flywheel technology have been utilized in creating a close range weapon that is as effective as a shotgun but no louder than an electric toothbrush. The sliver gun uses a squeeze cocking action to activate the four inch flywheel. When triggered, the wheel presses against a polyceramic block creating a multitude of sharp fragments traveling well in excess of 1200 feet per second! The internal power cell can spin the flywheel up to eighteen minutes before replacement (cost per cell: 7eb.). The sliver gun is also available in a accessory cyberarm version (HC=1D6+2).

Game Notes: Cyberarm version retails at 550eb. (2D6 Fragments/hit, each 1D6/2 damage; treat as knife for armor penetration) HC=1D6+2

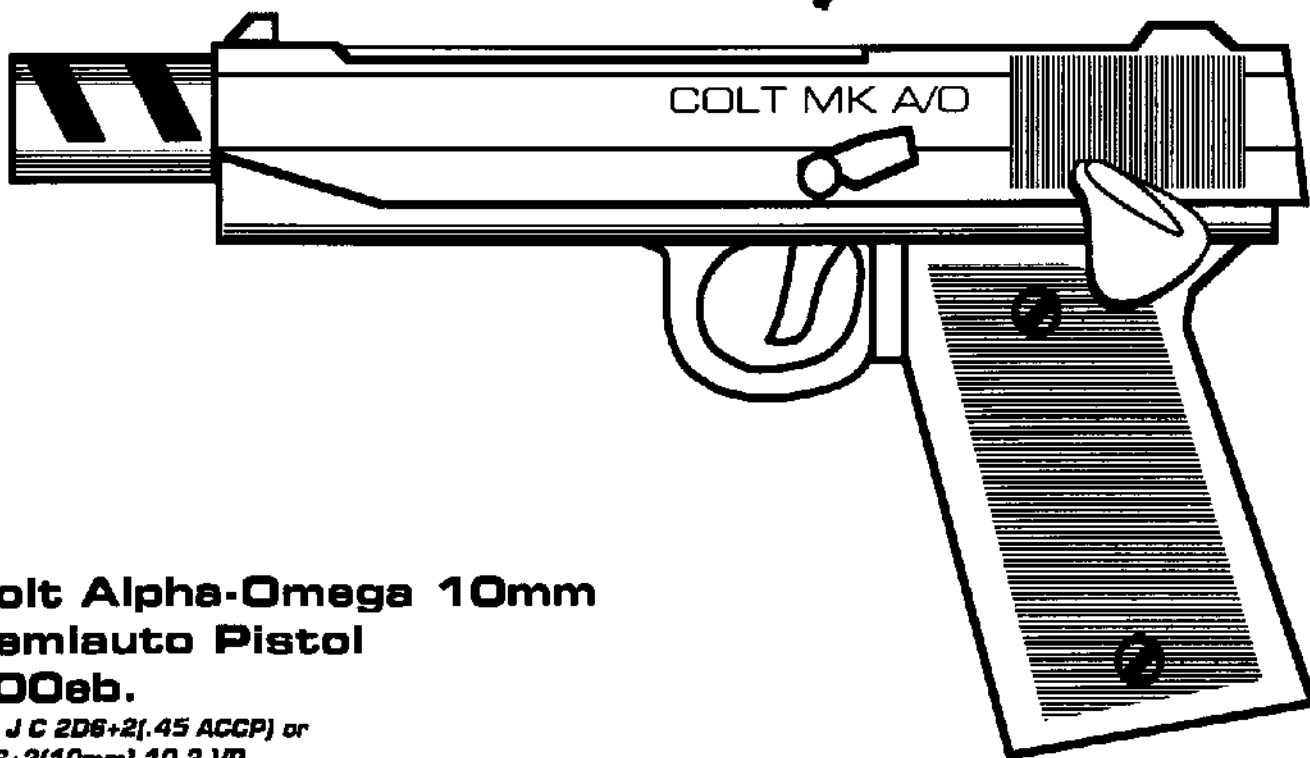

**Colt Alpha-Omega 10mm
Semiauto Pistol
500eb.**

*P 2 J C 2DG+2(.45 ACCP) or
2DG+3(10mm) 10 2 VR*

For over a century, Colt Firearms has been producing, and improving, the definitive semiautomatic pistol. From the M1911a1 .45 Colt to the present Alpha-Omega, Colt has strived for excellence. The Alpha-Omega is a semiauto, double action pistol. It has a ten round magazine in the shooter's choice of .45 ACCP or 10mm caseless. The pistol comes with a barrel compensator and shooter's interface as standard factory options. It may also be ordered with a Nikon COT sight system (*Solo of Fortune*) for an additional 3900eb.



**Glock Thirty Machine Pistol
705eb.**

MP 2 J/L C 2DG+3(10mm) 20/30 1/3 VR

In time for their thirtieth anniversary, Glock Int. introduces the latest in the further development of their famous line of semi-auto pistols. Glock has taken their 10mm Glock-20, given it a selective single shot or three-round burst capability, gas porting on the barrel for excellent controllability, and thirty 10mm cartridges per magazine. These features, plus Glock's time tested quality and accuracy, creates a fine example of Austrian workmanship.

Note: this pistol can also use the standard 20 rnd pistol magazine making it slightly more concealable and compact (P).

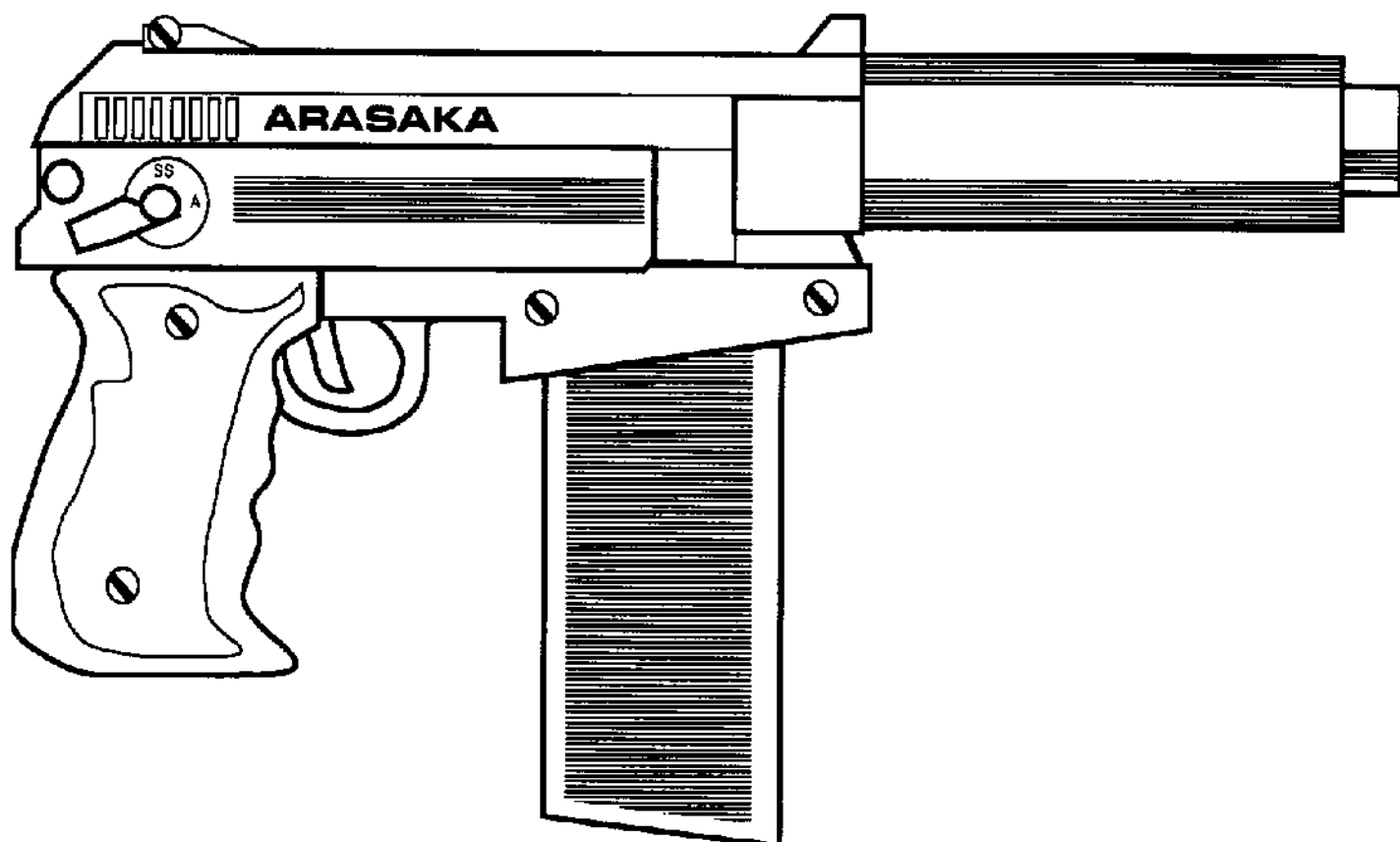

Setsuko-Arasaka "PMS" Advanced Sub-Machine Gun 1150eb.

SMG 1 L P 108+2(7mm) 40 20 ST

For the wanna-be technoninja, Setsuko-Arasaka (a division of the parent company) is now producing their Police/Military/Security SMG in the United States at their new automated plant in Night City, California. Designed for low-profile corporate security and paramilitary forces where discretion is valued over raw firepower, the weapon fires a sub-sonic, caseless 7mm bullet paired with a built-in Sonex suppressor. Early models of this weapon gained the reputation of being fussy about ammo and rumors that the weapon interface caused peripheral vision hallucinations. These problems were due to subcontractors substituting inferior or non-spec parts. The new PMS has been put through exhaustive testing to overcome all earlier problems with this weapon.

Note: non-smartlinked version is 200eb. less.

Goncz-Taurus Pistol 200-275eb.

P O J E 208+1(9mm)15 2 ST

300-400eb. (Selective-fire version)

MP -1 J C 9mm 15/30 2/10 ST

Standard officers-issue weapon in the Pan-Americas, and for many years illegally smuggled into the southwestern United States; this pistol has been made famous by that notorious nomad gang, the *Bat People*, and their leader, "The Brian." Don't be fooled by cheap Mexican or underground knock-offs! The G-T Pistol is manufactured by Taurus Brazilia De Brazil to their exacting standards and imported by De Santos Ltd. Two versions of this weapon are available: the 9mm semiautomatic, and the machine pistol version with a selective fire capability. A sturdy and reliable pistol at a very competitive price, with the choice of fifteen or thirty round magazines available. Dealer's prices may vary.

Malorian Arms Heavy Flechette Pistol 595eb.

P 1 J C 1DB+1(4mm AP Flechette Proj.) 25 2 ST
Disposable magazines are 14eb.

Firing a single 150 grain, 4mm dart at over 1700 feet per second, the Malorian Arms heavy flechette pistol is second to none in flechette handgun technology. Using a liquified gas combustion system, this semiautomatic pistol packs a rifle-round wallop in a handgun-sized package. The rechargeable liquid propellant reservoir can fire over two hundred rounds before needing a refill (30eb). The large magazine capacity make this weapon a favorite with firepower freaks everywhere. Eran Malour has specifically designed his new flechette gun with the "enhanced" customer in mind. The weapon comes chipped from the factory; safety interlocked and encoded to the owner, so use by anyone else is impossible. This feature is a definite plus to anyone needing a strong

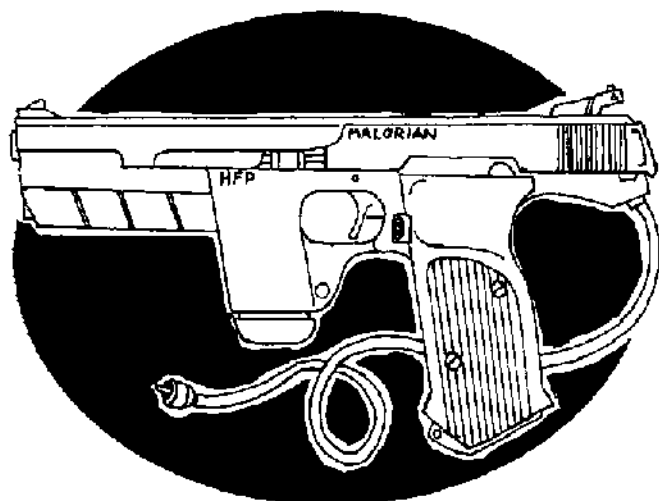

home defense weapon but who worries that their children might hurt themselves with an accidental discharge.

Note: Dense metallic bolt has double the AP effect (armor is $\times 1/4$). User must wear a special "safety-chipped" wristband, or have the safety chip in a wrist socket.

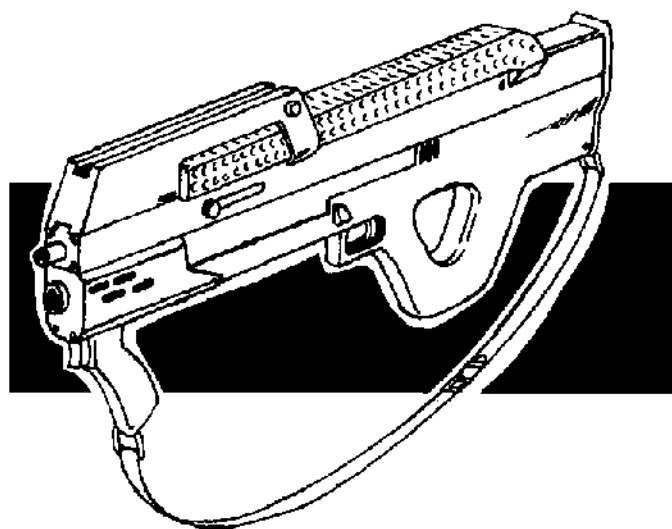

Militech M-31a1 Advanced Infantry Combat Weapon 1695eb.

RIF 2 N R 4D6(4.5mm) 150 30 ST/VR

Two years ago, the Provisional United States government proposed a new competition to select an advanced infantry combat weapon. The armed services committee felt that the military had a fine weapon already, and decided to create an impossible set of design parameters to purposely set this weapon program back at least ten years. The first and only

entrant in the competition was the M-31a1. Militech had developed a new grenade launcher firing a projectile no larger than a 10 gauge three-inch shotgun shell, but with performance almost equal to the original M-79's 40mm grenade. Malorian Firearms had recently patented a new weapon system called "liquid propellant action" but didn't have the capital to develop anything more than a working prototype. Eran Malour offered the license to Militech and in just eighteen months, the M-31 advanced infantry combat weapon was in production. The M-31a1 is an over and under configuration with a 4.5mm caliber assault weapon atop a pump-action mini grenade launcher. The liquid propellant action functions more like an old style gasoline motor in that a propellant and oxidizer are mixed in a firing chamber, then electrically fired by pulling the trigger, launching a 4.5mm copper jacketed bullet (50 grains), and cycling the action to feed the next round into the chamber. One of the requirements of the government contract was a magazine capacity of at least 100 rounds. The M31a1 magazine holds 150 projectiles and the propellant necessary to fire them. Paired with the grenade launcher, this design has proven to be an efficient and deadly combination.

Note: see pg.46 for stats on mini-grenade launcher.

Militech Mini-Grenade Launcher 255eb.

MGL(pump) -1 L C Mini-Grenade/10 Gauge 4 2 5T
475eb.

MGL(drum) ON P Mini-Grenade/10 Gauge 16 2 5T
Militech has developed a new grenade projectile sixty percent smaller in size (25mm x 90mm), but having the same range and effect as the standard 40mm grenade. Two styles of launcher are sold by Militech. The first is a pump-action, shotgun-style launcher with a tubemagazine holding four rounds. This version is the one normally mated onto Militech's M-31a1 Advanced Infantry Combat Weapon (see pg. 45), or the Militech 10 Submachinegun (pg.51). The second design (shown here) has a large rotary drum with a sixteen round capacity, constructed on a modified Militech 10 frame. This weapon's settings allow a shooter to select between the ammo types that have been loaded. For example, the shooter could

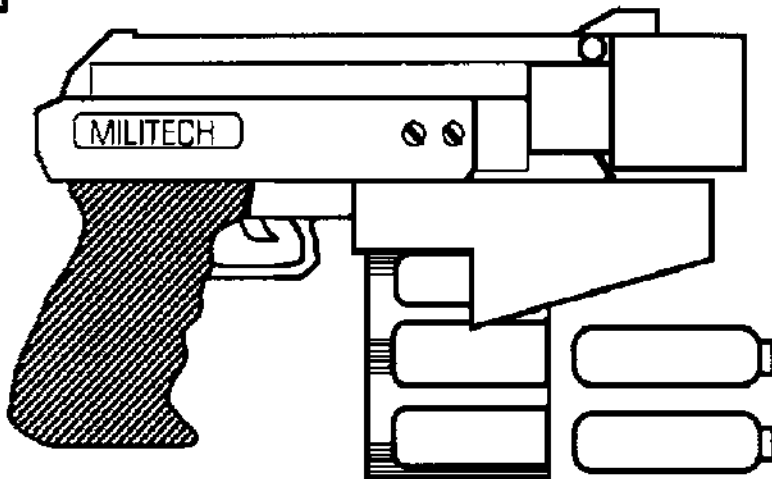

fire a tear gas shell, select an HE round, fire the HE, and then select a multiple flechette round, all without reloading! The weapon automatically rotates the drum to place the specified type of round into the chamber. Both weapons can also use 10 gauge shotgun ammunition.

Note: ROF drops to 1 if the shooter is selecting new ammo types between firings.

Mini-grenade munitions: HEP 5D6 (damage is 1/2 real, 1/2 stun-only; armor has no effect and is damaged 2 lvs.), Fragmentation 2D6+1 (5m diam.), Antipersonnel Flechette 1D6 (2D6 hits/shot), Smoke or Tear Gas (5m diam., see *Cyberpunk 2020* for effects.)

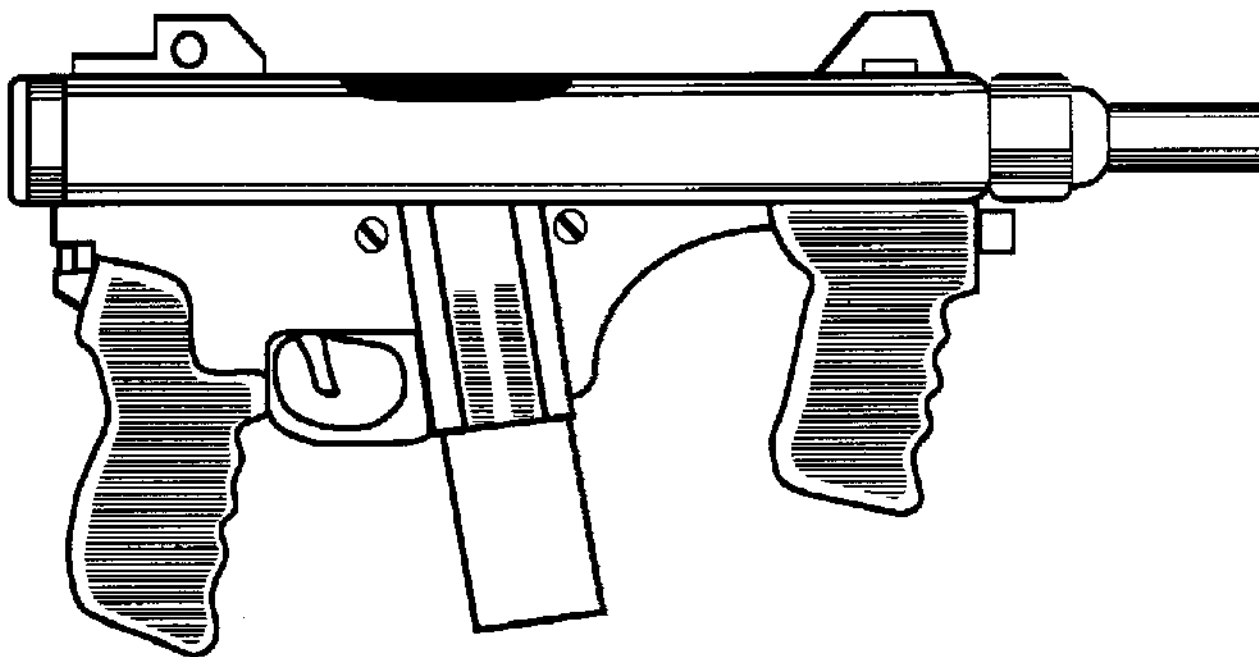

Beretta M-24 Advanced Sub-machine Gun 1250eb.

SMG 2 L P 2D6+1(8mm) 50 25 VR

The NEW standard-issue SMG for Interpol. Beretta Euroarms has set new standards in weapon technology with their M-24 sub-machine gun. Using the time-proven M-12 SMG as the basis for this new weapon, they incorporate features such as an integral smart link, large magazine capacity, and a recoil compensator. This makes a total weapon package that will fill the needs of any solo.

Note: non-smartlinked version may be had for 300eb. less

EMP Grenade

Cost: @ 200-400eb?

GRN 0 P R High Energy/ Electronic 1 1 varies

Are you a fifty kilo weakling? The metal dweeb next door won't tone down his chip box? Is your action being electromuscled by some borgboy in a bad thousand-yen suit? Put that chipped beef on toast with this "soon to be patented" Veg-o-matic Electromagpulse Grenade. Manually or remotely detonated, this munition will produce an electromagnetic pulse with a very limited range (approx. 10m dia.) that will scramble electrons, wipe chip memory, and teach any chromedome how to do the Dying Cockroach. If you're interested in this or any other electronic marvels, lay a query line at Night City's Boogie Board for the "The Great Neeso".

Note: We received a single EMP Grenade for testing along with payment for this ad. The instructions claim that when detonated, the grenade does not explode, but fuses its internal mechanism five seconds after arming. We tested the grenade among a group of volunteers from the shipping dept. and found that the more heavily augmented a person was, the longer it took for the effects to wear off. We estimate that internal cyberware came back on line in about four minutes and cyberlimb functions were regained in about ten minutes. Even a person with no cyberwear whatsoever will have orientation loss for about ten seconds. MRAM chips are totally lost unless shielded against EMP but our shipping manager's augmentation was unaffected, due in part to its L-5 origins.

DCR Rifle Grenades

@50eb./round for frags and others

100eb. for Anti-Tank

RGRN -1 N P varies 1 1/2turns VR

RGRN 0 N P Anti-Tank 1 1/2turns ST

With the addition of a 22mm muzzle adaptor (200eb), any rifle may fire the DCR line of rifle grenades. The use of a bullet trap design developed in the 1970's allows the shooter to fire conventional ammunition and also launch a rifle grenade up to 150 meters away! These small finned projectiles carry a warhead capable of doing as much damage as a standard grenade. It packs the same punch, but at a tenth the cost of a grenade launcher.

Note: the muzzle fitting for launching grenades can be installed on any paramilitary rifle by a competent tech for about 50eb.

FEN Dz 22 "Saucer Grenades"

65eb.

GRN 1 P P HE/Frag 1 1 ST

Introduced at the Paris Weapons Exposition by Fabrique Europa Nationale. These hand grenades have a liquid explosive filler in a aerodynamically saucer-shaped (4.5" dia. x 0.6" thick) grenade body (+2 to Athletics skill). Arming the grenade is achieved by turning the trigger button clockwise. Pressing the same button will allow a six second delay before detonation occurs. One hundred-sixty hardened steel pellets create a zone of fragmentation fifteen meters in diameter (Damage 2D6+3). This grenade has a rubber edge to allow the user to carom it off objects. Because of the way one throws the grenade, colorful nicknames such as "Frisbee O' Death" and "Perforation-Puck" are often used to describe this product.

FEN Dz 25 "Det Card™"

120eb.

GRN 1 P P HE 1 1 ST

Another nifty new design from those clever folks at Fabrique Europa Nationale. The Det Card is a credit-card sized wafer of C-4, stabilized with a plastic shell, and ignited by a tiny detonator chip imbedded in the card. Simply snap the card in half, place it where desired, and it will explode in twenty seconds. Just right for noisy B&E jobs. Available in Trauma Team™, Euro-Worldbank, and WNS press card formats.

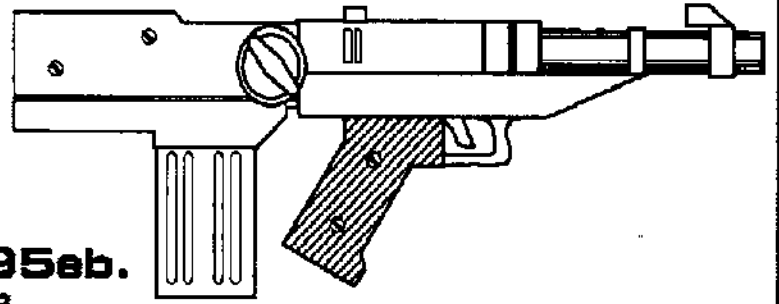

Malorian Arms Sub-Flechette Gun 795eb.

SMB(F) 2 J C 10mm (multi Flechette) 10/30 3/35 VR

Malorian Arms has beaten the competition to the punch with their new flechette sub-gun. A bullpup - configured weapon using a rotary bolt system similar to the proven M-95/G-11 operating system. This weapon uses the new 10mm caseless flechette round containing six steel penetrators capable of defeating any ballistic cloth (Kevlar) body armor in present use. Equipped from the factory with three round burst/full-auto capability, and an integral compensator. Ammunition magazines come in ten and thirty round capacities.

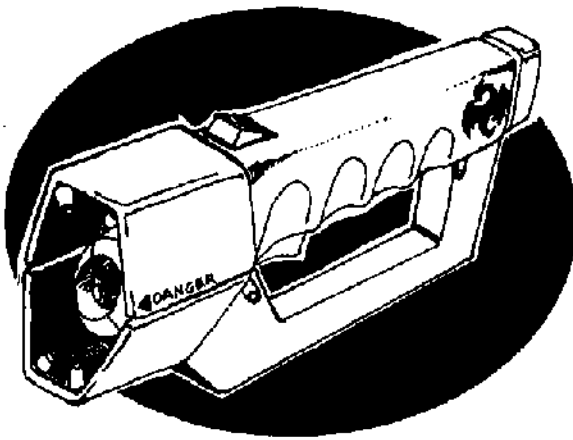

Kendachi Dragon 660eb.

EX O J P varies 4 1 ST

This hand-held flamer provides destruction at your fingertips. The ignition must be activated 1 combat rnd. before firing. Creates a 4m flame, doing 2D6 spread over 2 random body areas 1st round, 1D6 to 1 area 2nd rnd. Only hard armor, or soft armors of SP 15+ will protect the target. All soft armors will be damaged 2 lvs. instead of 1.

GPz-78 Mini-Grenade 40eb.

GRN O P P HE/Frag 1 1 VR

A very small hand thrown grenade (1.5" diam.) using a HDX explosive filler. Because of its size this grenade is very concealable but its blast effect is limited to only three meters (Damage 1d6+2). Licenced to Gremyenko of Moscow by DutchArms LTD.

Militech Military/Police Shotgun 300eb.

SHT O/-1 N/L C 4D6(12 Ga.) 8 2 ST

A gas operated, semi-auto shotgun with an eight round detachable box magazine and folding stock. A hard-working weapon for the hard-working corporate MP. May be ordered in either twelve or ten gauge (six round capacity, no folding stock).

Note: 10 gauge ammo does 4D6+3 damage, 12 gauge is 4D6. Second Acc. and Conceal. ratings are for stock folded.

Biotech-Askari Motion Restraints 60eb./bomb, 25eb./release tube

EX O P P Special 1 1 UR

A fine, gossamer-web polymer material dispensed by hand-thrown bomb. It allows slow, steady movements, but clamps down instantly on quick or violent motion. 1m radius effect; a Very Difficult REF (use *Dodge/Escape* skill), or Near Impossible BOD (use *Strength Feat* skill) roll to get free. The release catalyst comes in a 10-use squirt tube; otherwise, wait 30-40min for chemical breakdown.

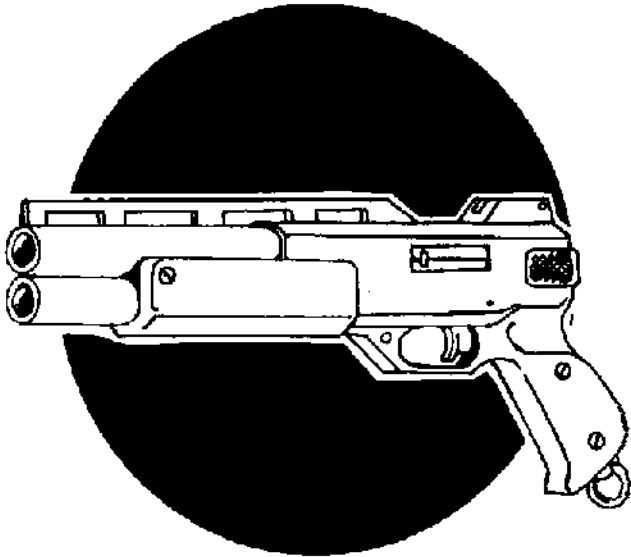

Stundart Pistol 109eb.

P -1 J C Stun/-1 Save(.45 cal low-V dart) 2 2 VR

A new addition to our catalog comes from Pursuit Security Incorporated. For the solo needing a non-lethal alternative, the stundart gun is an excellent choice. This weapon is an over-and-under double-barrel breakopen configuration. The stundart ammunition itself consists of a special low velocity (400 fps) .45 caliber plastic cartridge. The projectile is a pronged copper-jacketed capacitor capable of storing a charge of up to 70,000 volts! The dart-like projections allow the round to deliver its charge through heavy clothing, fur, and even some ballistic cloth armors (penetration of soft armor up to 5SP is possible). Incapacitation is instantaneous and lasts up to one hour.

Note: This weapon is unsafe to fire with any regular ammunition (90% chance of misfire, 2D6-1 damage to shooter's arm). Projectiles are sold four to a package and have an expiration date for use.

Tachtronica Black-Zap Glove 90eb.

EX O P C Stun 6 1 ST

An electrified mesh glove with effects equal to a taser, powered by an armband battery pack. The Black-Zap can be use with either a grab a punch attack.

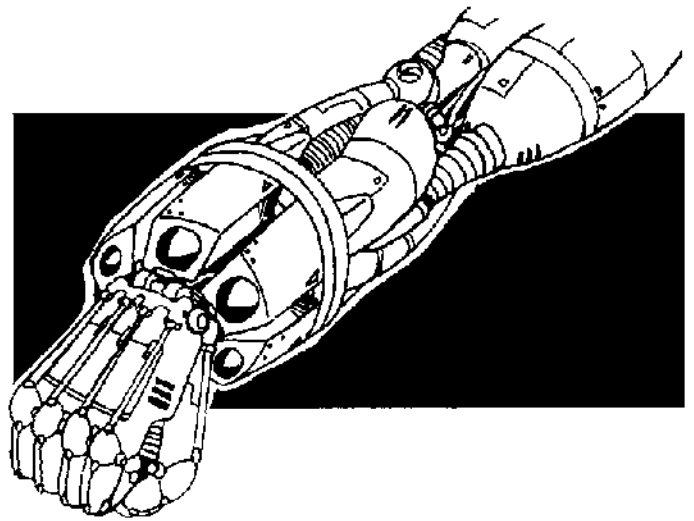

Rostovic Wrist Racate 380eb.

for launcher, rockets are sold in packages of six at 200eb.

MRL O N P 5D6(30mm HE) 6 3 ST/P

From our friends in the Eastern bloc comes a new weapon, the "Wrist Racate". This pseudo-cyberweapon consists of a cylindrical mini-rocket pod that rotates around a forearm fitting. It is capable of firing six 30mm HE rockets either singularly or in volley. Backblast is not a problem as each rocket is cold-launched by compressed air until ignition occurs about five meters from the launcher. Effective against personnel or structures (Damage 5d6, 3m diam.), the Racate can also be used in an indirect artillery support role. If looks are secondary to firepower, then this is the personal weapon for you. The Wrist Racate must be worn over a cyberarm or battleglove; it is too heavy and awkward for a normal arm.

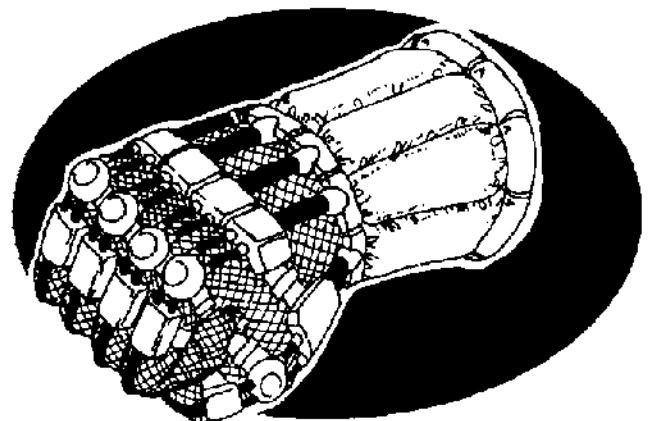

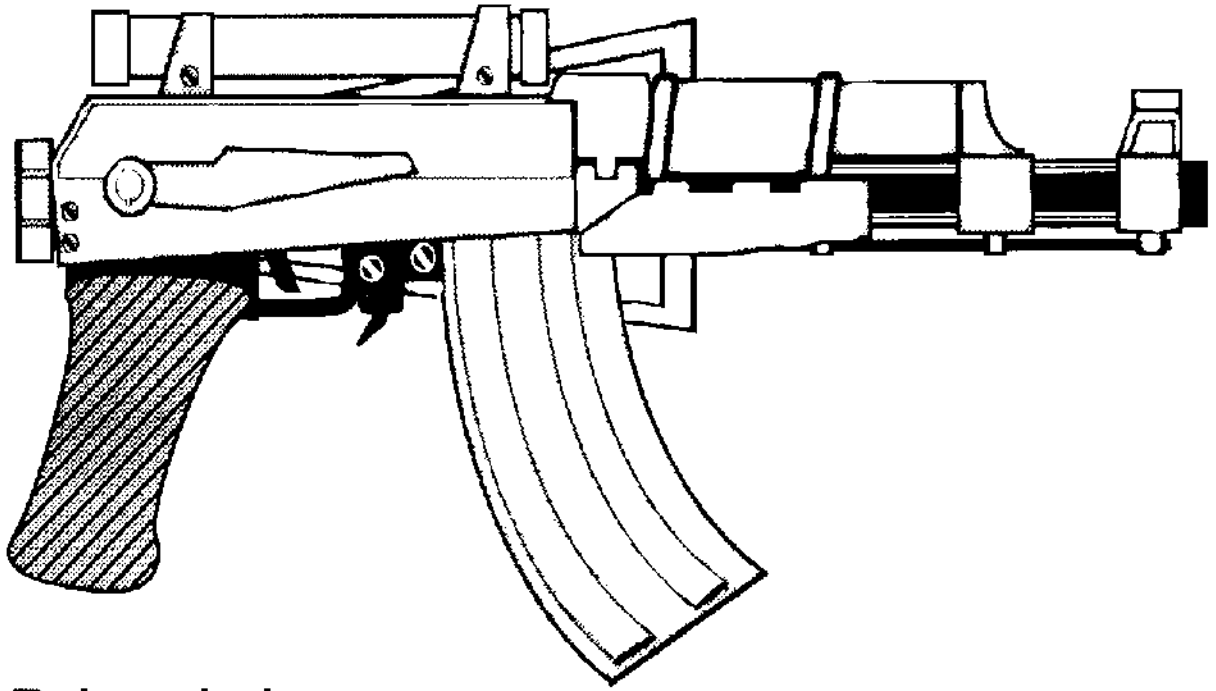

Darra-Polytechnic M-9 Assault Rifle 300eb.

RIF O N P 4D6+2(5.5mm) 40 25 ST

The first assault rifle using a caseless cartridge built entirely in the Hindu-Chinese Confederation. Designed to use the 5.5mm caseless (Chinese), this weapon's lineage is clearly Kalashnikov. Ballistic qualities are similar to the early Soviet 5.45mm used in the AK-74 assault rifle. Two things are readily apparent when you first pick up this weapon. The first is the lack of interfacing for the shooter. This weapon is designed for military forces in the Third World who don't fit their soldiers with chips and plugs. Second is the old-fashioned configuration in an age where bullpups are the style. Side-folding stock and a 1.2x optical sight are standard options on the weapon. Because of the large numbers of these guns exported out of the Hong Kong trade zone, and their very low cost; the M-9 has become a common sight in the Third World and on the streets.

Note: this gun normally uses special hollow-nosed ammo (armor SP is x2; any damage that penetrates is x1.5), standard ball ammo would do 4D6 damage.

Militech Mini-Gat Machine Carbine 695eb.

SMG O L P 1D6 [.22 caseless/5mm] 120 40 ST

The .22cal caseless (5mm) has never been taken seriously as a defensive round until now. The Mini-Gat is a 5mm five barrel gatling gun capable of emptying its helical magazine in under five seconds flat! Don't be satisfied with some machine pistol's dink thirty round clip when a Mini-Gat carries one-hundred and twenty rounds! It's electronically fired, operating from a rechargeable battery in the magazine. Famous bounty hunter/solo Crista Margaret, when asked about the Mini-Gat's firepower states, "I call it my garden hose— it makes planting all too easy."

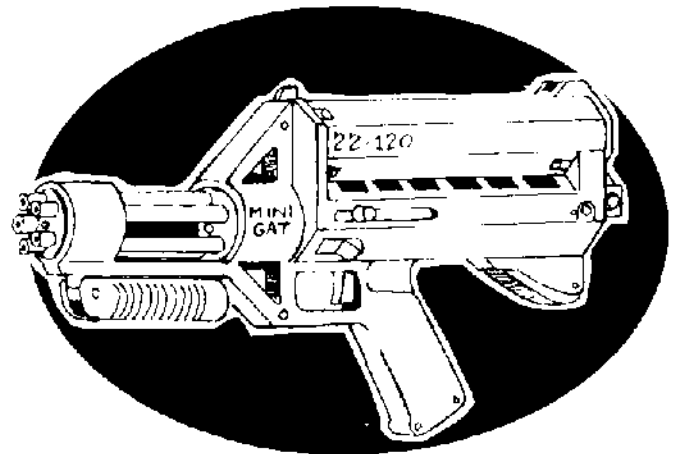

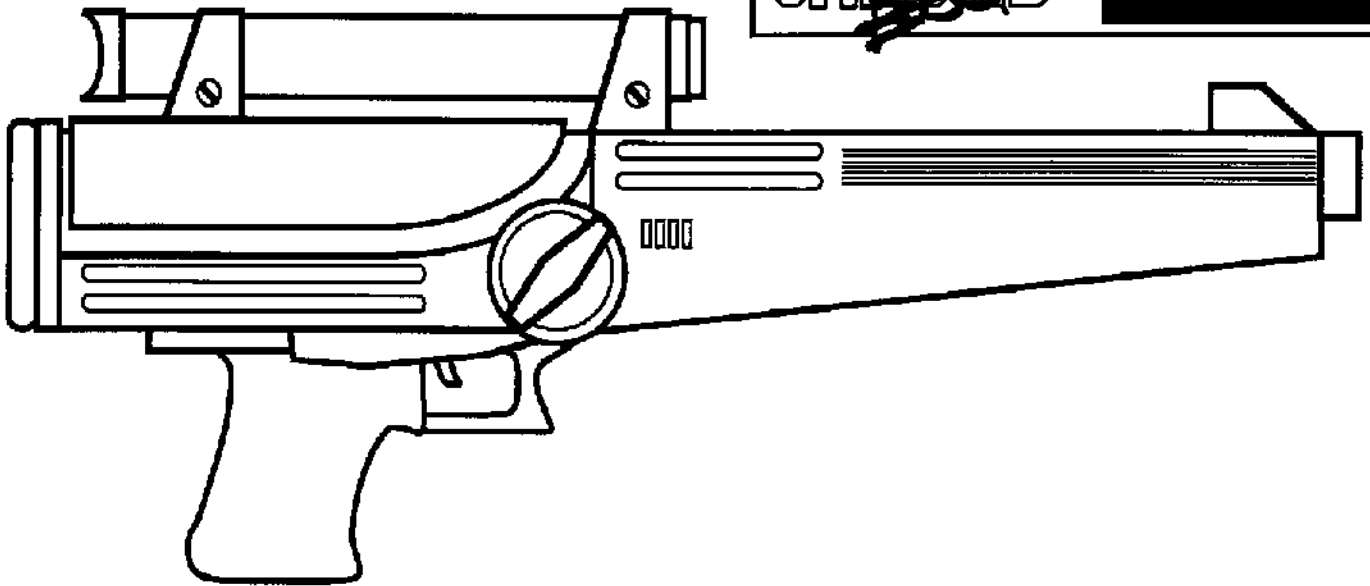

Heckler & Koch G-6 Advanced Squad Automatic 2050eb.

LMG 1 N P 5DB(6mm) 100 30 VR

In 2018, H&K decided to build a squad heavy weapon based upon the G-11/12 rotating bolt system. By scaling up the basic G-11 rifle by 50%, the desired weapon completed initial testing and was designated the G-6 squad automatic weapon. The caseless 6mm round is accurate out to 900 meters and the 100 grain bullet has a steel core to defeat body armor (SP halved). A gunner normally carries eight 100-round magazines. This light machinegun has full interface for the chipped soldier, and an integral 2x scope with cyberscopic triangulation and passive IR capability.

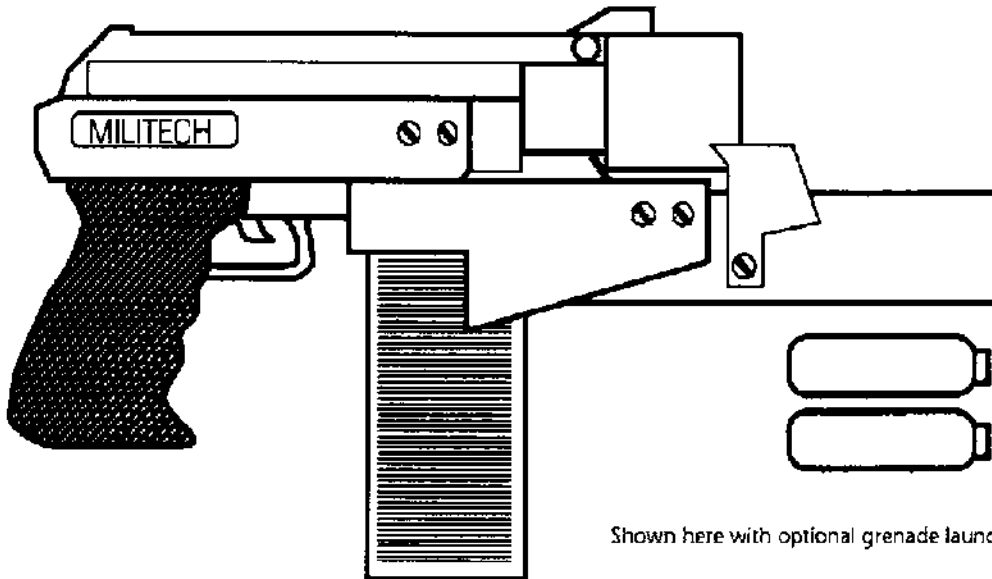

Shown here with optional grenade launcher (see pg. 46)

Militech-10 Submachine Gun 455eb.

*SMG 1 J E 2DB+3(10mm),
or 2DB+2 (.45 ACP) 30 20 ST*

Want value for your Eurobuck? Look no further than your nearest Militech dealer. The Militech Ten uses composite plastics and the most modern computer machining techniques to create a submachine gun that is light, accurate, and a pleasure to shoot. Available in two calibers: 10mm PlasticCase and the venerable .45 ACP. Factory accessories include sound suppressor, scope mounts, grenade launcher and interchangeable caliberkits allowing a wide choice of firepower. And Militech doesn't forget the fashion conscious with a choice of eight designer colors (red, blue, green, black, silver, cammo, gold, grey).

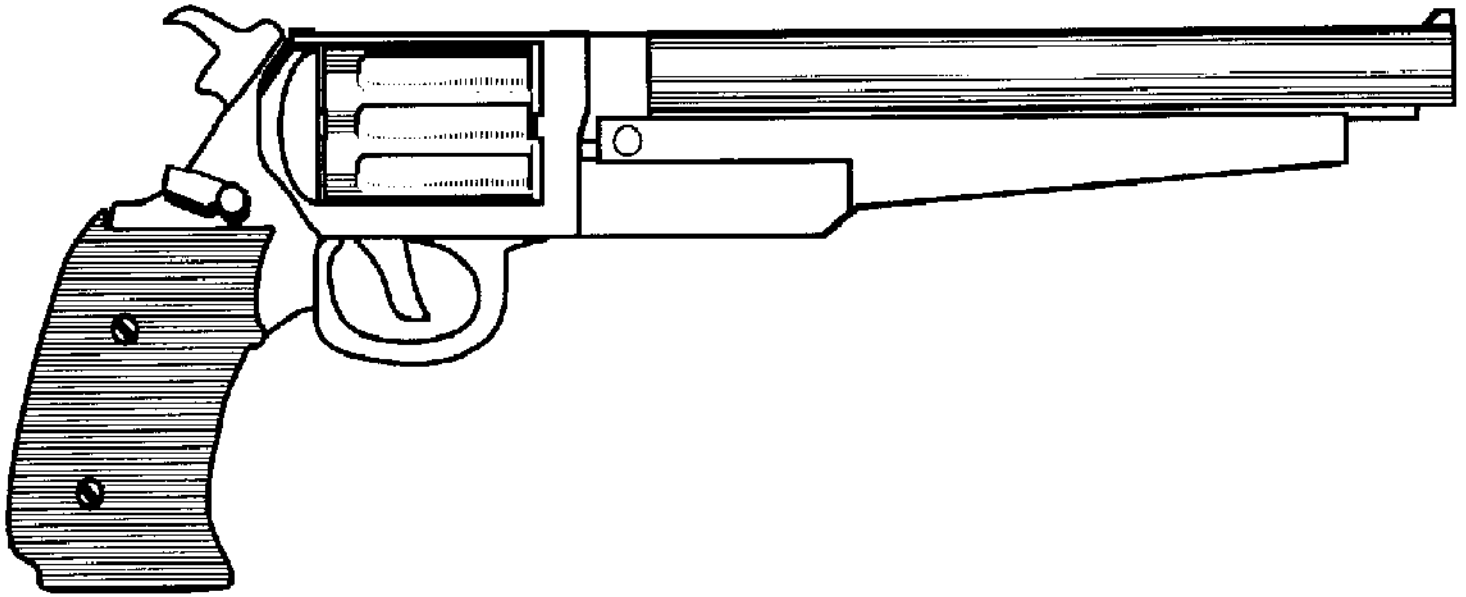

**Federated Arms 454 DA "Super Chief"
375eb.**

P 0 J P 406+3(.454 Casull) 5 1 VR

Originally conceived with handgun hunters in mind, the Super Chief is a double action revolver finished in stainless steel and chambered for the .454 Casull, a cutdown big-game cartridge specifically designed for large animals. A big success with people who like the challenge of handgun hunting, this weapon has also proven itself as a real manstopper when the situation warrants. It's also a very popular Nomad weapon.



**Malorian Arms 3516
4525eb.**

P-1 J R 606 (14mm) 8 1 VR

The most powerful personal handgun on the market today, Eran Malour developed this radical new design to the personal specifications of famous rocker Johnny Silverhand. "I wanted something that would drop a cyberpsycho'ed fan at 100 paces, no matter how metallated up he was," explains the enigmatic singer. "Price was no object." Malorian's design employs a rare, solid Orbital titanium frame, custom Dyna-porting® and a direct cyber interlink that locks the user's cyberarm in place as the weapon fires (required: cyberarm of Average Body Type, interface plugs, smartgun link). By special order only.

APEX Mobile Point Defense System
10,000eb.

LMG X N P 2DS+4(9mm CL) 400 40 ST

Got a perimeter to defend? An airfield to protect? Just want to get some sleep at night without worrying about streetgangs trashing your house? You want APEX. Based on the Phalanx automated weapons systems of the U.S. Navy, the APEX Point Defense System is a movable light machinegun, capable of defending a secure area by itself, or under the direction of a remote operator. Most Corporate aerodyne pads and rooftops are defended by larger and more expensive versions of the APEX, however, this little beauty puts maximum point defense control in the hands of even the smallest business or homeowner. And it only weighs twenty kg., allowing it to be carried to new locations easily!

The upper part of the APEX dome houses four computer-controlled motion sensors with an effective range of 200 meters. When a target moves across the sensor's 360° field of fire, the central mini-gun tracks the target, adjusts for movement, and fires. Sensors can be set for a specific target size, from that of a small rodent, up to a large vehicle. A hand held controller allows the operator to activate the APEX from as far away as a 1000 meters; the controller can also be used to activate individual APEX units by location (each one is assigned a number and frequency), or to deactivate specific units allowing the operator to enter at will.

The APEX unit is self powered, with a battery life of 50 hours (this may be extended by linking a solar panel to the unit). The internal drum magazine holds 400 rounds of 9mm Caseless Long ammunition (the same as used in the innovative Militech High Power-15 SAW [Solo of Fortune, pg, 50]). An automatic shut off will disable the weapon in the event of a jam, signalling the operator through the remote control. The APEX has a SDP of 20, and an SP rating of 5.

Range	+150	75	35	15
% To Hit	10	20	30	40

To determine hits, roll percentage for each target in range, then roll 1D10 for number of hits on each. Add 10% to hit percentage if target is moving at half speed or less.

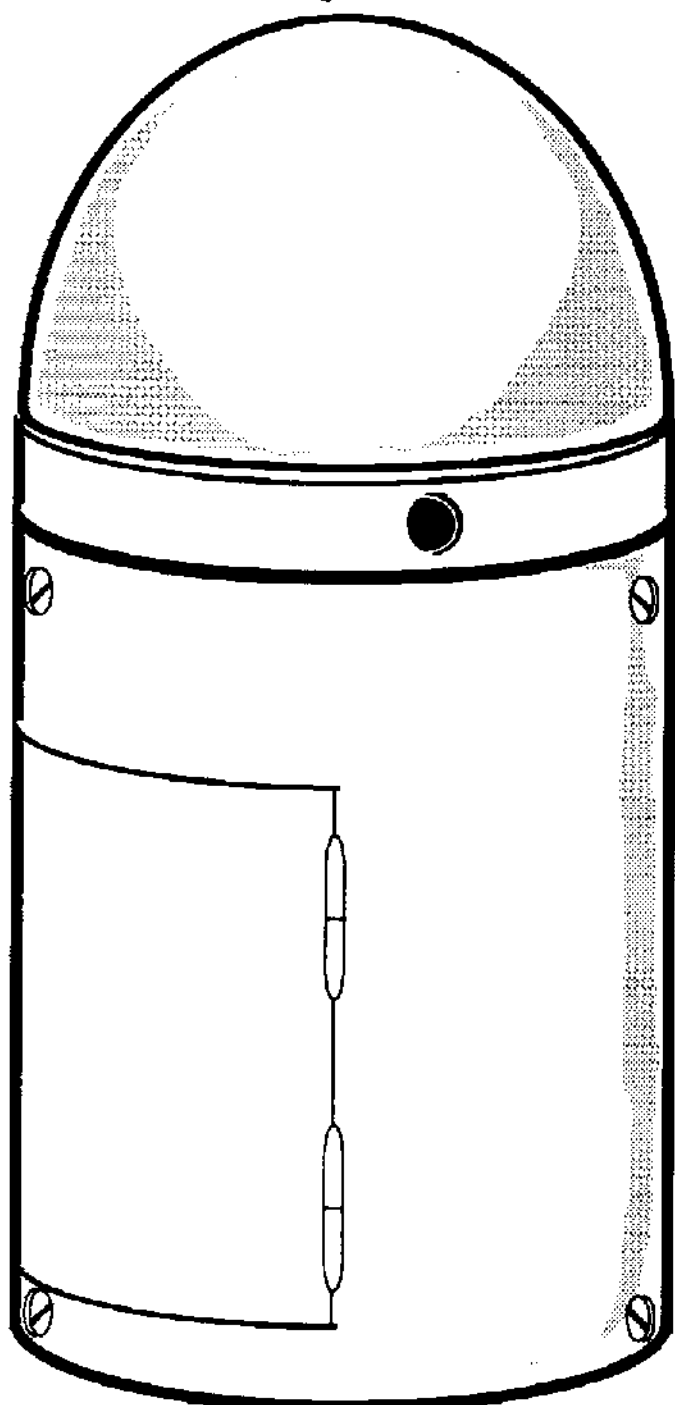
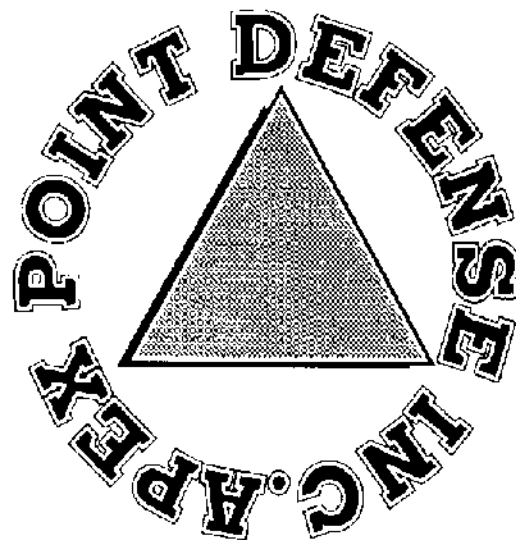

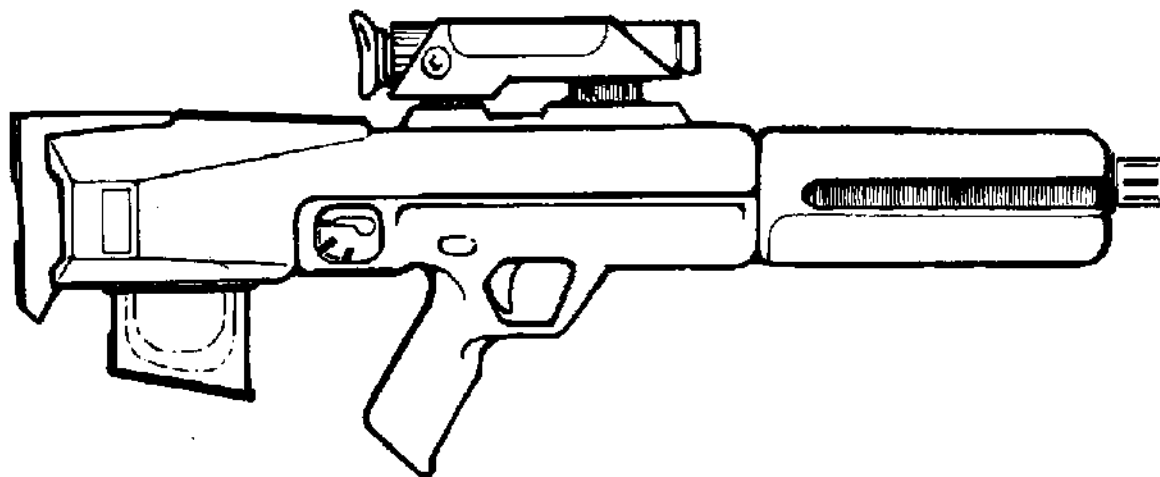

Federated Arms Light Assault 15 400eb./700eb. if "smart" rigged

RIF O* N G 5D6(7mm caseless) 30 3/25 VR

Federated's bid for the plastic-frame, bullpup configured, caseless market pioneered by H&K's G-11/12 and Stemmeyer's M-95A. As with all Federated products, this is a durable light rifle, with good accuracy and a low price. The LA-15 comes already rigged with smartgun interface plugs; the built-in optical sight is a welcome backup when the weapon is used by non-chipped troops. With its durability, adaptable sighting systems, and inexpensive price tag, you can expect the LA-15 to give Darra Polytechnic's M-9 (pg. 50) a run for the money in the Third World arena.

*Weapon is optimized for 3-rnd. burst; Acc. is 1 when firing in that mode.

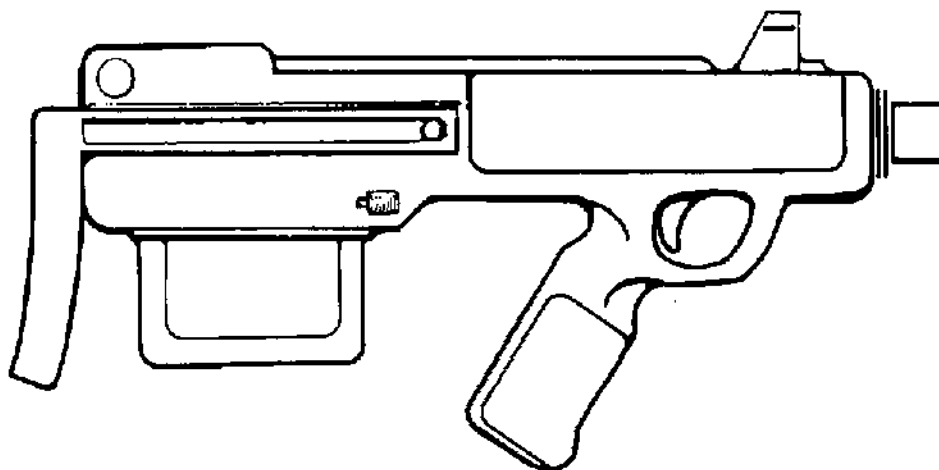

Stein & Wasserman Model F "Cyborg Assault" Weapon System 1650eb.

RIF O L P 13mm Mixed B 1 VR

The hot weapon for psycho-squads everywhere; the Cyborg Assault is the Rolls-Royce of close-in shoulder arms designed to stop the heavily enhanced. This bullpup rifle fires a wide selection of rounds (see below) and is muzzle-adapted for DCR rifle grenades (pg. 47) as well! The unique eight-shot box magazine with rotary feed can be loaded with all ammo types at once, and the selector switch allows the shooter to pick the load type by its number position in the magazine! A must-have for any C-SWAT team!

The low-pressure rounds have a 100m range, and the following assortment of ammo is available: HEP (high-expl. cratering) 4D6+2. Damage is 1/2 real, 1/2 stun-only; armor has no effect, and is damaged 2 lvs. API (AP Incendiary) 4D6+3. Armor SP is 1/2; 1st rnd. after hit target takes 1D6 extra, 2nd rnd. after, 1/2D6 extra. Armor does not stop this extra damage! Acid Shell (glass-lined container) damage and effects equal to Nelspot "Wombat" (Punk 2020, pg. 97), except duration is 4 combat rnds.

Kendachi Mono-Two 650/700eb.

*MEL 1 J/N P/R 2D6/4D6
..VR*

An improved version of the original Kendachi Monoblade, favored by corporate samurai everywhere. A thicker blade cross section re-enforced with Orbital crystal strengthens the weapon against parries (shatters on a 2 or less on 1D10), and bad cuts (no breaking on a fumble). For an additional 50eb, you can have a miniscule laser implanted in the hilt; while it has no effect on combat, the laser refracts with the crystalline blade, giving it the flaring neon glow of a movie "light saber". Blade tints include red, blue, white, green, violet, orange and rainbow. Sold only in traditional two blade sets.

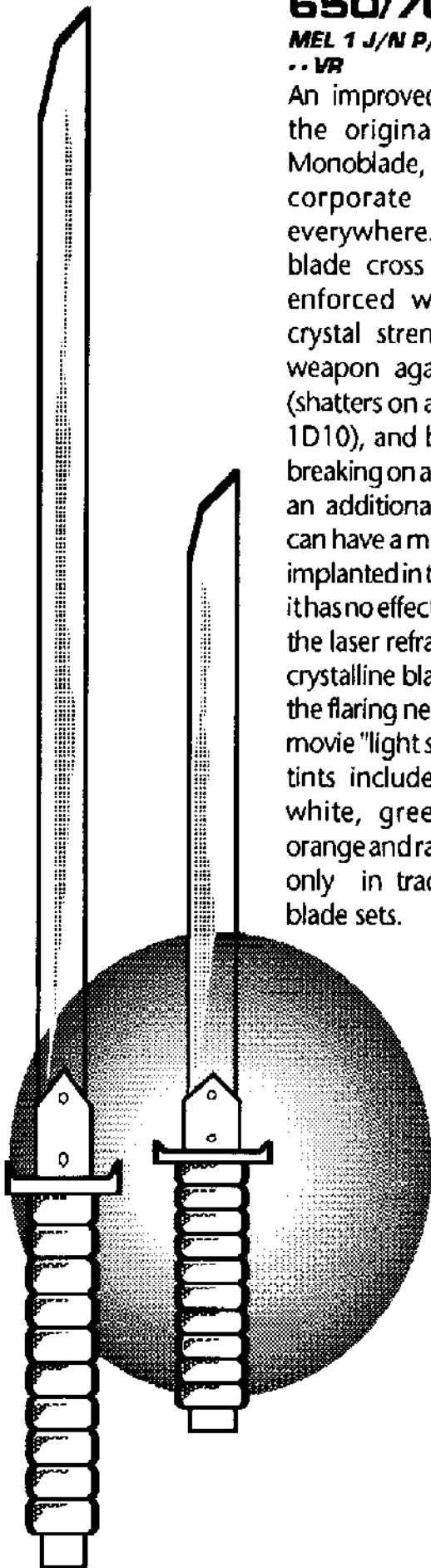

Kendachi M-33 Powersword 860eb.

MEL 0 L R 4D6 .. ST

Combining elements of the popular Kendachi monoline with a powered handle, the Powersword vibrates its molecular crystal blade 2000 times per minute. Combined with a microscopically serrated edge, this weapon literally chews its way through anything it encounters, including armor (soft armor SP at 1/4, hard armors at 1/2), metal, flesh and bone. The blade activates when the handle is gripped, but takes 1 combat turn. to "warm up." Although the current model is quite heavy (3kg) and fragile (breaks on a fumble, shatters on a parry check of 5 or less on 1D10), Kendachi is currently testing a new model for release in 2022.

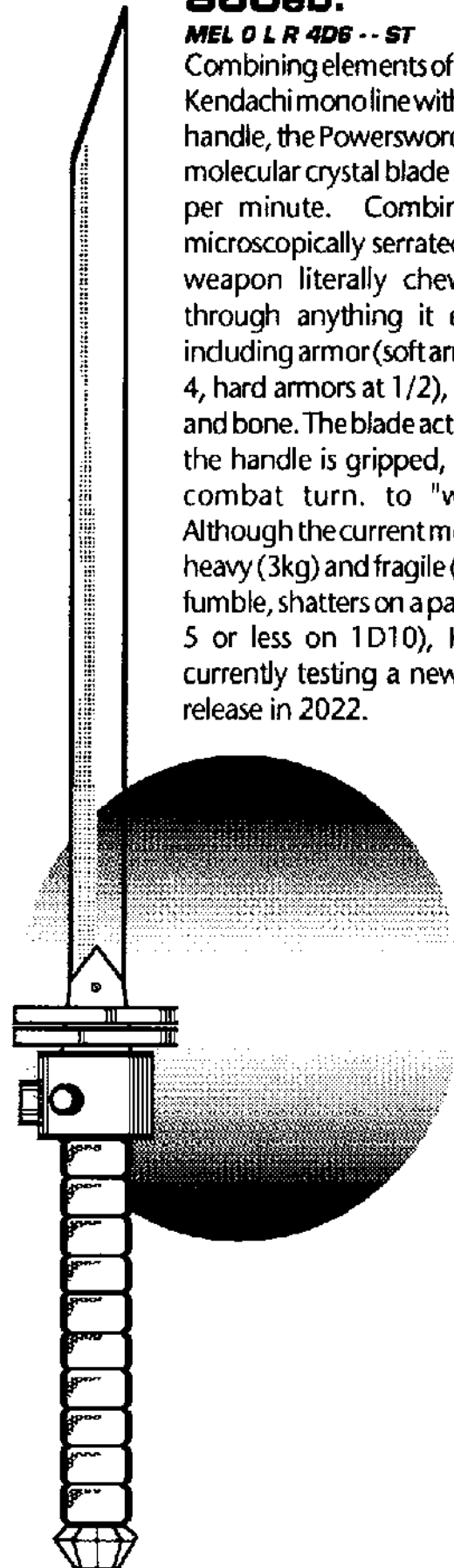

Fashion

Non

Style Substance Elegance

Non

"Frack! It doesn't matter what it looks like. What's the SP?"

—Ripperjack

"There's nothing as unforgivable as leaving a bad looking corpse..."

—Dr. Halman Thompson, DMS News

"Style not matter? Hey, the difference between a 20eb. handmedown and a 2000eb. Eji original is worth a clean million on the Street. When you look like you're the Man, people treat you like the Man. And that means respect."

—Phil "Nacho" Hernandez, Fixer



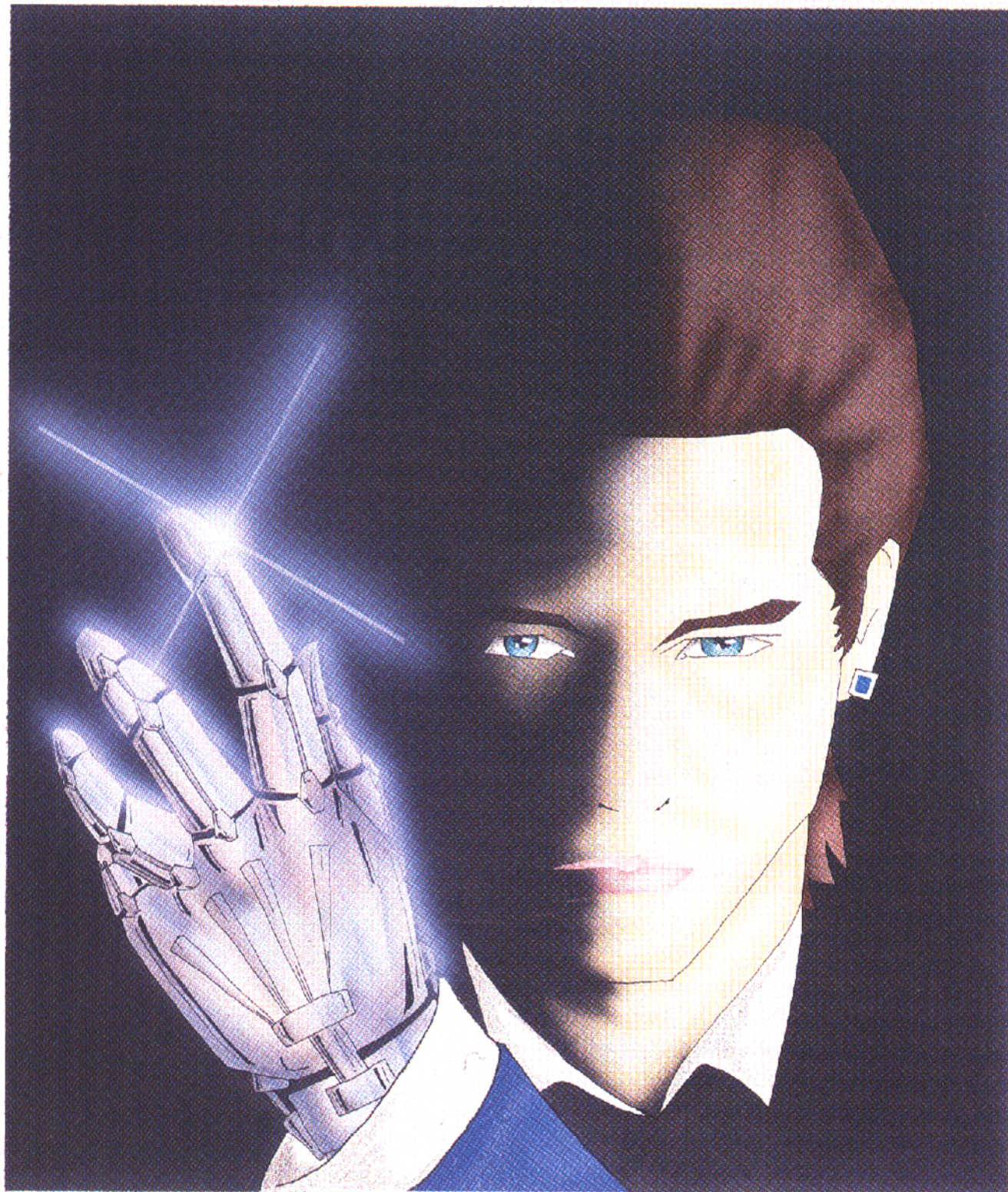

Psiberstuff

Slaves to Fashion: *Cryochilled* is a term used to describe the growing faction of individuals who believe that cyber-replacement of functioning appendages is the ultimate in self-expression. Today's cybernetics are as much a child of the designer's stylus as they are of the engineer's tools. Psiberstuff leads the pack with innovative looks and technology. Form and function no longer remain mutually exclusive. Pictured: Orbital Crystal Cyberarm for 7,000eb (SDP=60). Also available: Nu-Tek holographic "Wearman" option for the above (see pg. 58 for details).



Nu-Tek

Nu visions:

It's not enough to watch vids anymore. Make the scene—and be seen. The Wearman series from Nu-Tek is making its mark on our streets. On jackets (300eb.), skirts (200eb.), and many other types of clothing, video has never been more popular. Everybody's got their 10 minutes in the limelight, and now, everybody can watch themselves while they bask.

I love my Nu-Tek video jacket! I can pick up all my favorite videos, no matter what comsat they're beamed from! And the built-in chip reader lets me play my own recorded videos, or just replay the same image over and over!

—A Mallplex Juvieganger

Uniware

The Corporate look:

If you've noticed that things are looking better in the world today, it's not the governments of the world you have to thank. Many of the more public-oriented companies have started switching their uniforms over to ones designed by Uniware. Durable, functional and stylish, image-conscious corps no longer have to worry about having their great-looking staff wearing any old rag while on the job.

Uniware's given our Corp a whole new look: professional, competent and forward looking. From the new tunics for our Security people, down to the one piece minidress combo for our Secretarial Pool, everything Uniware makes is perfectly coordinated. And Company Logos are even included!

*—Shelly Yeats
Personnel Mgr., NET 54*

Item	Price
Vest	25eb
Pants	35eb
Boots	30eb
Skirt	35eb
Blouse/shirt	20eb
Dress	50eb
Torso Armor (SP 10, torso) ..	60eb
Legpads (SP 10, legs)	60eb
Utility Belt	15eb
Jumpsuit	75eb
Armorjacket (SP 14)	200eb
Armor Trenchcoat (SP 18)	300eb

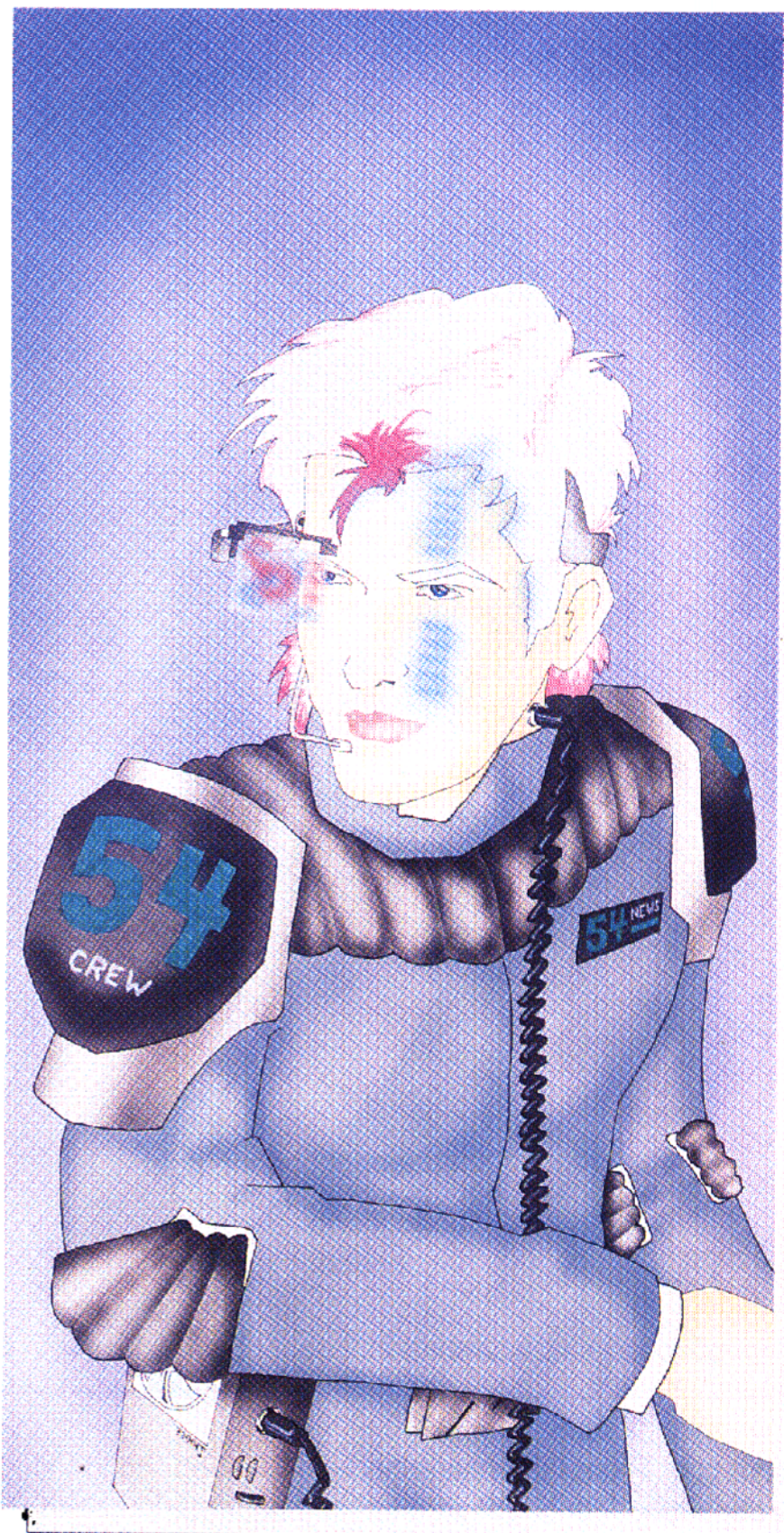

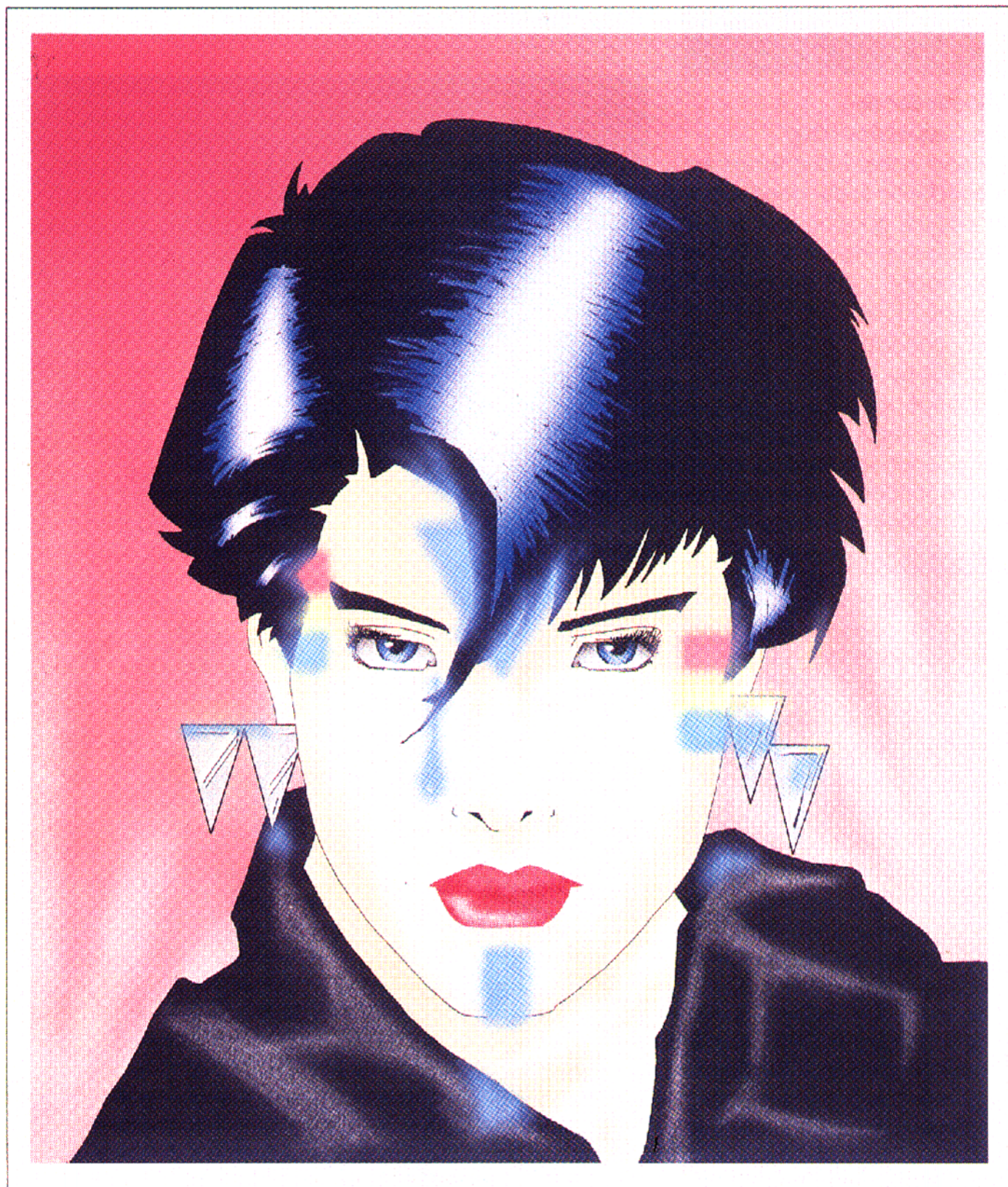

Image Fashionware

Artful style: With hi-tech art, your body becomes the canvas. Above, Vidstar Chantel makes the point with her trademark teardrop from Image Fashionware's *Bodyline* tattoo collection. In the past, cosmetic surgery could make anyone blandly perfect. Now, with *Bodyline*, you can be—uniquely perfect. Available: Trademarks & Logos (100eb), Stars & Shapes (50eb), Heat Sensitive Color Changers (120eb).

ICON America

Classic appeal:

Some things never change. When some things look this good — they never should. Leather has always looked HOT!! This jacket (300eb.), and skirt (100eb.) from ICON America are no exception.

I love what leather does for me. Smooth, sleek, in animal patterns and colors. Ostrich, snakeskin, tegu lizardskin; no matter where it comes from, it always looks good. And with the new tank-grown skins Biotechnica's coming out with, who knows what kind of leather they'll make next!

—*Sherri Glass*
WEN Braindance Star

Item	Price
Bomber Jacket	300eb
Tunic	220eb
Pants	250eb
Miniskirt	100eb
Long skirt	200eb
Gun Belt	60eb
"Gunfighter" Hat	100eb
Long Duster	500eb
Boots	150eb
Halfboots	100eb



It's true; you don't have to look good to be a street solo. But dressing down has its limits. You're not going to get the big jobs: extracting major corporates, guarding big-name vidstars, or covering media security on the important parties. For that kind of work, you have to look the part. The eurosolos I know have always been partial to Gibson when they're on the job; it's tough, durable, and has a lot of flair. For a young solo on the way up, you can't do much better; it's the enforcer's equivalent of the 500eb grey flannel suit.

—Morgan Blackhand
The Enforcer's Handbook

Gibson Battlegear **Street lethal 2020:**

Substance AND style. You've got to look good doing what you do; a professional but casual image. On one hand, protection is fine, as long as you don't let them think you're scared. On the other hand, style counts for nada if you're dead. Gibson Battlegear firmly addresses the issue by mixing armored acid-washed jeans (30eb, SP 16), a cotton T-shirt (10eb, SP 10), and a reinforced denim jacket (150eb, SP 14) with pieces of Metalgear-style hard armor (SP 25, prices var.) where it's needed most.

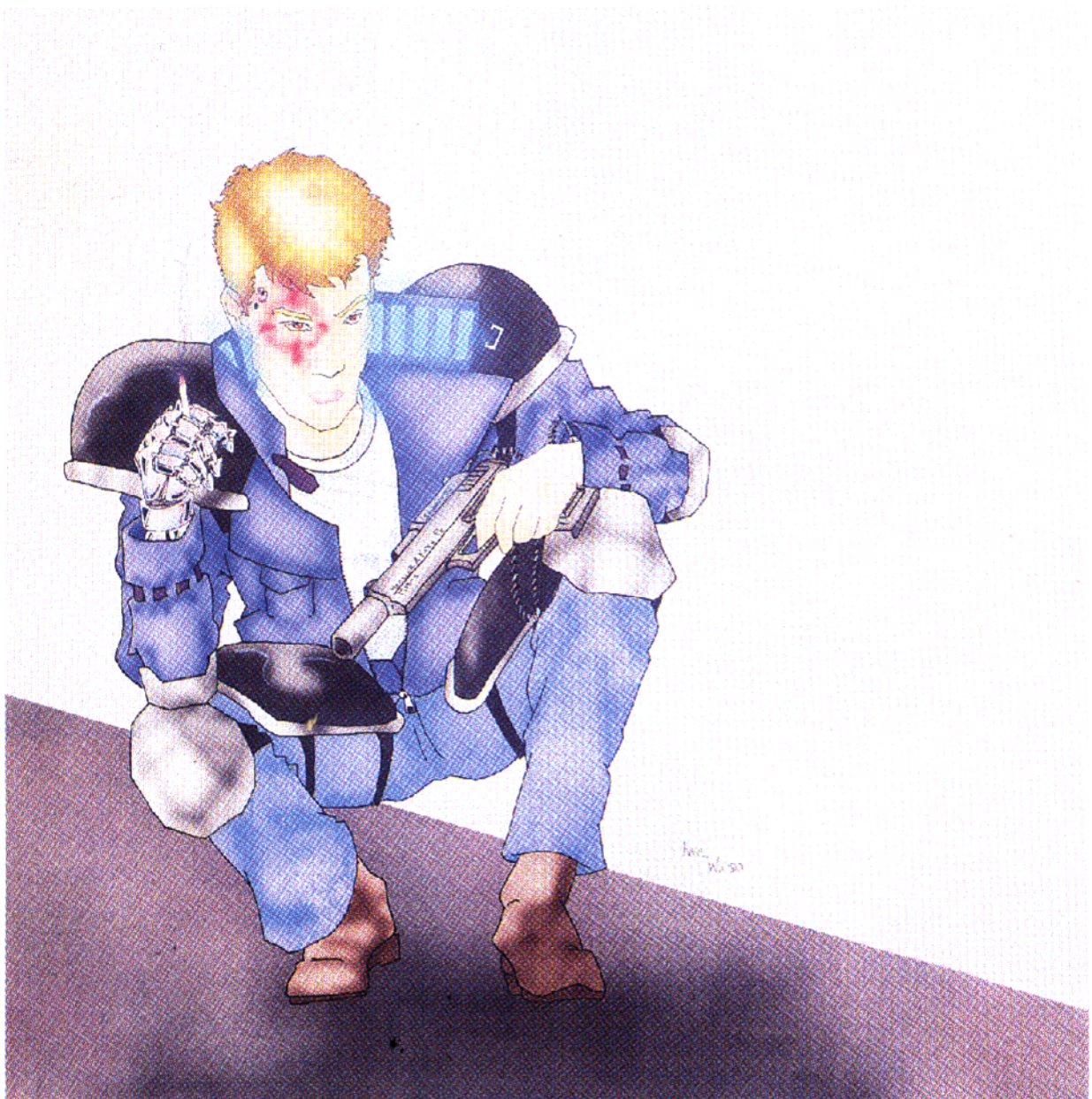



Tanaka's Exec Line gives me what I demand from a fine clothier. Real-silk shirts; cotton lightweights for summer. The suits are actually Italian wool, not synthetic, and cut with authority and attention to detail.

*—Ulf Grunwalder
EBM Board Member*

In Nihon, we make some of the best vehicles, computers and cyberware in the world. But the epitomé of the samurai spirit is embodied in the work of Takanaka's Executive clothing. Spare and exact, it shows us that the true master of business must not only follow the Way of the Sword, but also the Way of Art.

*—Seki Arasaka
Arasaka Advertising Division Head*

Item	Price
Jacket	800eb
Vest	500eb
Pants	700eb
Top Coat	1000eb
Full Armored Topcoat (SP 16)	2000eb
Matching Briefcase	600eb
Monogram Shirt	200eb
Tie	100eb
Cravat	100
Scarf	75eb
Cologne	150eb
Sword case	300eb
Cape	900eb
Opera Cloak (Armored SP 16)	1200eb

Takanaka *Exec* Line

Power in simplicity:

In our world of 2020, we sometimes forget— less is more. Understated power screams in every fiber of Takanaka's new *Exec* line. No gimmicks, no fancy syntha-cloth, nothing extraneous. There's no need for any of it. Anyone who can see knows that it's the person in these clothes that counts.

T A N A K A
EXEC
THERE IS NOTHING FINER



This summer's collection from Eji of Japan is the highlight of the season. Loose tunics with soft collars, daring armor-cape with the trademarked light panels Eji used in his Night City and Cyberpunk collections; it's all there for the Edgerunner on the go. And the best part—it's an affordable fashion option even for the kids in the Mallplexes.

—Action in Fashion Magazine, May 2020

Eji of Japan

Hi-tech flair:

If you dress like a Suit, no deck, (not even a Matrix-8) will make people think you're anything but a loser with an expensive toy. The look is it, and Eji of Japan seems to capture IT in their look. Designer jeans (50eb.), and a lamb's wool sweater (60eb.), topped off with the armored cloak with light panels (SP 14, 500eb.). It's a picture of confidence and taste.

EXECUTIVE SERVICES

"When was the last time you saw Saburo Arasaka doing his own laundry?"

—Spider Murphy

"Yeah, yeah, I hear the Solos down in Security talking all the time about the 'Edge'. They think you strap on a few cyberbits and you're set, neh? Up here in Management, we don't need metal. We need the people edge... Investigators unconnected with the Company for black ops work. Someone to sweep your conapt for hidden bugs. A tough courier service to get something cross-town so you don't have to dodge the Zone. Maybe even a little 'companionship' for a valued client...That's the real Edge."

*—Dave Whindam
Biotechnica*

Baskin

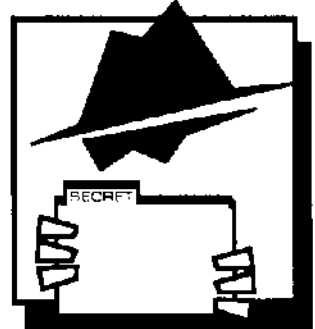

Undercover Inc.
"Always Discrete"

Habit

The Personal Service

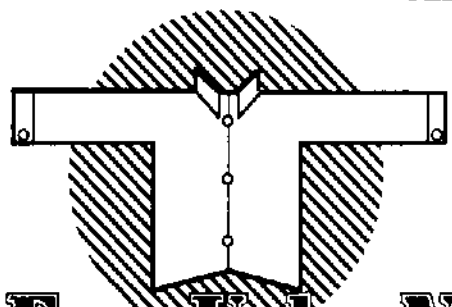

ExecUclean

Bodycure

"For A Lovelier You."

Williams Management

Apartment Services

Williams Management Inc. is the largest executive conapt management service in the world today. With offices in every major city, Williams will procure a conapt for today's business executive who is interested in relocating to another city, country, orbital, or just across town.

Williams Management incorporates its fee within the purchase or rental price of any unit under their contract. These fees (ten percent of purchase price or fifteen percent per monthly rental charge) are actually on the low side considering Williams Management has strict guidelines on all properties they manage and sell. Since Williams Inc. only works with their own properties, the aforementioned fee is already calculated into the price so that potential buyers/renters needn't worry about additional costs.

Complex Services Contract: The Complex Services Contract, or CSC, is a standard option available to those living in the larger, 500+ unit conapt buildings now dominating the City scene. For a basic fee (usually between 500 and 2000 euro per month), Williams Management will take care of those little details (maid service, pet care, video-cable feeds, food services, etc.) which are a bothersome part of a modern lifestyle.

Game Notes: Williams Management is one of the best ways to create a landlord service for Corps and other upscale players. Apartments are about 2-3000 eb. per month. If you wish, use the Corporate Flat on pg. 83 as a model for a standard conapt managed by Williams Apartment Services. Most of the following services in this section, with the exception of Party Time Inc., SyCust, and the International Companion Network, can be offered through a Williams CSC.

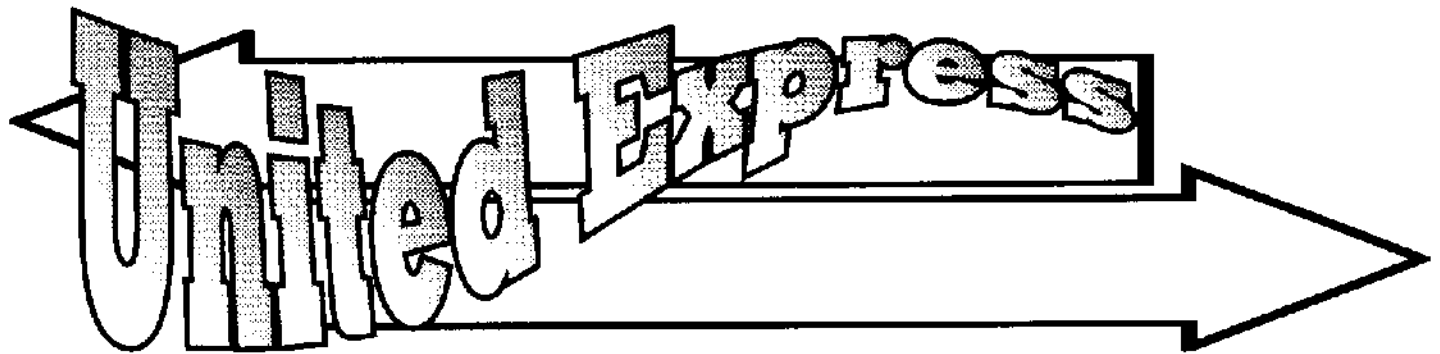

Worldwide Delivery & Courier Services

Whether it's not having to take the time to pick up groceries at the local market, or not being forced to personally hand over a contract to that unpleasant customer who insists that electronic devices are the curse of modern business; one of the most valuable services for the modern executive is a good courier. Of the thirty-seven multinational delivery companies, only United Express is large enough to have offices in all major cities and Orbitals, and carry an insurance policy which will cover any costs incurred through late delivery or damage to objects or documents being transported.

United Express has a set rate for common business items, such as contracts, models and prototypes. Said prices range from 25 to 650 eurodollars, depending on the speed, secrecy, special conditions and distance which you wish the package to be delivered. If the service involves a purchase, the delivery bill is usually 10 percent of the purchase price, with a 25 euro minimum charge to the recipient (remember, most delivery services give a thirty percent commission to their couriers in lieu of salary, so tipping a courier is unnecessary).



Whether you're having dinner for two—or two hundred, there is only one catering service to consider: Continental. While many other services offer a variety of food in a wide range of prices, only Continental has no surcharges for items which need to be imported. When you contract us, the only charge is a scaled fee with regard to the number of guests; we absorb any additional costs which may be incurred in the process of creating, serving, or the cleaning up of your meal.

Continental charges 200eb per dinner guest, up to 15. If there are more than 15 guests, the per-guest charge is reduced to 150 eurodollars. Included in this price is food preparation, dining set-up, service and clean-up. Continental has branches in most major cities, with some of the larger conapts employing a

smaller scale operation exclusively for its residents. It is recommended that you make reservations with Continental at least one week in advance, though emergency service can often be provided on one day's notice.

Do you want to go out, but don't have a clue of what to do? Let us make the decision for you. At Party Time Inc., we arrange for your evening's entertainment with a twist. The special part about this service lies in the mystery of where you're going and what you're going to do. And if you don't enjoy yourself, we guarantee a full refund.

Party Time Inc. is an entertainment service which charges a fee of 500 eurodollars per evening, or a flat monthly fee of 3000 eurodollars, plus an evening fee of 50eb. People subscribing to this service are given a comprehensive psychosocial evaluation to better understand their personalities so that Party Time may plan an evening's entertainment to their satisfaction. Interested subscribers who do not wish to undergo this evaluation forfeit the money back guarantee.

Game Notes: I think of this as a built-in adventure generator. No matter what else they're doing, Party Time guarantees that once a month your players be doing something interesting! Including maybe working for Party Time!





CLEAN SWEEP

Tired of that nagging suspicion that someone doesn't trust you? Afraid that you're giving away corporate secrets while you sleep? Now you can do something about it! Clean Sweep Enterprises offers the finest in data and electronic protection services. After we clean your conapt of any unwanted surveillance devices, we will come back on a monthly basis to recheck our work for one year, all for one low fee.

Clean Sweep Enterprises charges a yearly fee of 7000 eurodollars to keep your conapt clean of unauthorized surveillance devices. This cost includes an initial visit, eleven additional visits to do a routine sweep, and the rental fee of a Databox™. Should you wish to discover the identity of the person/organization who is trying to keep tabs on you, you will receive a referral to Baskin Undercover Inc., a private detective service under the same corporate ownership as Clean Sweep.

Just out—the Databox™: The Databox is an anti-surveillance device marketed by Gateway Securities, the parent corporation of Clean Sweep and Baskin Undercover. Containing its own five year power source, the Databox™ is a self supporting, EMP-shielded computer which monitors all frequencies of radio, microwave, laser, x-ray and ultraviolet radiation for unusual broadcasts. After its initial programming, only the owner can change, or add frequencies which the Databox™ will ignore. After all, what good is a device which warns you that you've successfully cooked a meal?

Game Notes: Clean Sweep's chance of finding bugs is based on the person installing the bug: Amateur (90%), Pro (60%), Master (30%).

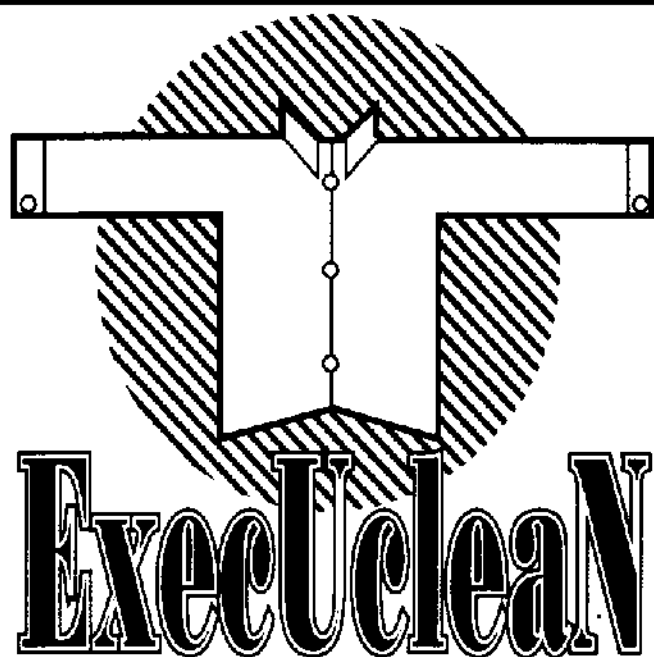

Game Notes: ExecUclean can also repair damaged armor clothing at a rate of 20% of the initial purchase price of the garment, restoring it to full SP.

Although laundromats still exist in the world of 2020, no executive would be caught dead sitting around in a pair of old jeans, fishing for quarters when the machine buzzer sounds. In today's world the new concept in drycleaning is ExecUclean Inc. With ExecUclean, there is no need to go hunting around the city for a laundering service; we have drycleaning offices in most large corporate plazas and conapts, and guarantee clean clothing within one hour, or you receive a thirty percent discount.

ExecUclean costs range from 15 eurodollars for a shirt and tie, 25 for a set of pants, 40 for a jacket, and an entire suit will cost about 100 euros to have it cleaned and pressed. There is a nominal 15 eurodollar charge for pick up and delivery should you wish us to retrieve your laundry for you.

Baskin

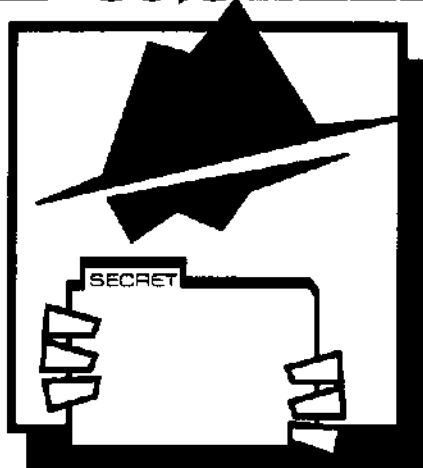

Undercover Inc. "Always Discrete"

Whether it's a simple information search or a complex counterespionage action, there is only one place you can go for guaranteed confidentiality. At Baskin Undercover Inc., we get your job done quickly and efficiently without sacrificing quality.

Baskin Undercover Inc. charges 200 eurodollars an hour plus expenses for basic investigative services including research, shadowing, phone/computer traces, confidential interviews and discrete, trial-admissible recording of meetings. Extra charges include an additional 100 eurodollar per hour charge if an operative is involved in a dangerous situation, an extra hourly fee of 150 eurodollars per extra operative needed and a flat charge of 5000eb if the subject being investigated is a target for extraction.

Baskin Undercover is a legal, private investigative service with a license to operate on six continents and the Orbital colonies. Advisory: If it is discovered that the duties to be performed by our service are not of a legal nature, we will terminate our contract immediately and pass on all information to the proper authorities.

Game Notes: Baskin is a good way for players to pursue an investigation while they're busy elsewhere. While it's up to the Referee to determine just how much Baskin finds out for the players, here are some guidelines: Basic Information (75%), In Depth Information (50%), Secret Information (20%).

By the time you get home from work you usually don't have the energy, or it's much too late to safely take your miniature pit bull for a walk in the park. That's when you call Pet Minders. Just like a regular babysitting service, PetMinders' sole concern is caring for the pet you keep for comfort or status. Whether it's this year's "in" pet, the African Wolf Spider (or any other exotic animal you may keep) your pet will pose no problem for our staff of well-trained, highly educated professional zoologists.

PetMinders charges a basic monthly fee between 50 and 5000 eurodollars, depending on the complexity of the care your animal requires and the amount of time you wish us to spend with your pet. This service includes at least 2 extended visits a week by our in-home caregivers, daily feeding (we pay for the food) and the weekly cleaning of your pet's waste facilities.



Game Notes: Besides providing pet care, PetMinders also locates rare and exotic pets for it's more exclusive clients. Whether these are stolen or just black market is unclear (and no one asks). Prices are anywhere from 1,000eb to a million, based on rarity (and Ref decision). PetMinders also does a booming underground business in endangered animal products and exotic animal meats.

Not as cute as you thought, neh?



SHOPPING SERVICE

When you're always on the go, you don't have time for grocery shopping. Allfood cooperatives have the solution to your problem. Simply place your order in the morning, along with the time you wish your food to be delivered and we'll take care of your weekly shopping needs.

Allfood cooperatives charge a nominal delivery fee of 10 eurodollars per delivery, plus an additional 25 eurodollar monthly membership fee. Included in this fee is the Allfood guarantee of the finest quality goods, plus membership discounts on items and services offered by other members of the Holt Coalition, an international conglomerate run by Maxcene Holt, consisting of Allfood Inc., PetMinders, Bodycure™, CompuShop, and Mark 24 convenience stores.

Game Notes: Sure, there are supermarkets in 2020, but who wants to waste game time shopping for food? All Food is a perfect dodge around this problem. It also exposes the players to all kinds of food-related adventure hooks, like poisonings, toxic emergencies, and the chance to discover firsthand if Soylent Green really is made from people.

**International
Companion Network**

When your profession demands high fashion one minute and practical kevlar the next, there is no better personnel service than the International Companion Network. Our skilled professionals have the looks to garner

the attention you want at a business party and the brains to make sure you get home after rejecting the competition's offer. When you need to look good while feeling safe, there is only one company to call: ICN.

The International Companion Network loans its personnel by the hour, day, week or month. Charges range from 75 eurodollars an hour, 750 a day, 4000 per week and our monthly charge is 10,000 euro. All of our professionals are trained in both social and protective skills, though we do offer specialists in certain areas of personal defense. If such a specialization is required, reservations must be made at least one week in advance.

Game Notes: Rent-A-Solo. Rent-A-Mistress. Rent-A-Hunk. This provides the players to ability to hire any of the above, or perhaps take part-time jobs as same.

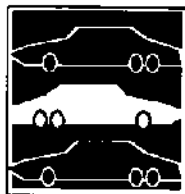

**Executive
Transportation
Service**

When you're not cruising around in the corporate limo, what other way is there to travel the city streets in style? At ETS, we offer a low cost, executive transportation alternative. Our employees are courteous and unobtrusive, discretely chauffeuring you to your destination in safety and style.

Executive Transportation Service charges 150eb an hour for the rental of an armored limousine, 500 euro per hour for an AV-4 and 850eb for hourly rental of a V-22B Osprey. The rental charge includes the vehicle and one ETS pilot/chauffeur (optional with proof of rentor licence). A deposit equal to four hours rental is required, unless your credit status is Diamond or higher.

Game Notes: So where does the party get an AV-4 to make that big extraction? Guess.

SYCUST
BODYWEAR & CUSTOMIZATION

Tired of the same old glittering chrome peeking out from under your sleeve? Want to make a statement with your new eyes in

something other than an unusual color? SyCust offers the finest in cybernetic customization for today's executive. Cybernetic customization possibilities are endless, but listed are some of the more popular options:

Tattooing: ever the popular method of expression, today's cybernetics, including eyes, can have a customized design etched onto the surface with no cost to your humanity. Our costs range from 20 eb for a simple design, up to 5000 eb for a complex design which may require anesthesia due to the length of time it will take to complete the customization. This charge can be reduced by 2000 eb by bringing in the piece of cyberware before it becomes a part of your body.

Unusual colorization: a classic option which involves covering the cybernetic in a two or three molecule layer of our special, non-scratch coating. The cost of this option is 25 eurodollars per cubic inch covered, with the exception of eyes, which cost 50eb per optical unit. Once again a nominal 2000 euro charge is added if surgery is required.

Limblite™: An innovative patented design, limblite™ involves the installation of a neural processor and a transparent plastic sheath which contains a light-sensitive fluid controlled by the processor. With this new option, you can change the color of your cybernetic limb by just thinking about it. The cost is high, 750 eurodollars, plus the 1000 euro charge for the installation of the neural processor. (HC 1d6-1 for the processor, 1-2 for the limblite™) If you already have a neural processor, a controlling chip can be purchased for only 700 eb.

Game Notes: Where do the players go to get the really flashy cyberoptions they dream up? This is the place! For four times the normal cost of the 2020 list cybernetic replacement, SyCust will build or modify the cyberoption as desired (subject to Referee discretion).

Habit
The Personal Service

At Habit, we not only teach you the basics, we refine you into the perfect executive. In addition to basic decorum, our specialists teach you how to act when dealing with all the different people you might come into contact with, including corporate owners.

Since it would be ungainly (as well as unrefined) to sit in a classroom to learn about manners, we assign each student a private tutor who comes to your home twice a week for lessons. Our course lasts six months, but it guarantees results, or we'll continue the lessons until you get it right for no extra charge. Our fee is 5000 eurodollars per course and includes the lessons, several catered parties to practice your new ways with other students, plus follow up sessions should they be needed.

Game Notes: For each 6 month course, add +2 to Social Skill, up to 2 courses



Bodycure
"For A Lovelier You."

Do you want to change the way you look, but don't want to undergo radical facial/bodily reconstruction? Now there is a another option: Bodycure™. At our exclusive salons, trained professionals will change the way you look and feel about yourself in a matter of hours, or your money back.

Bodycure™ is more than a makeover and a haircut, it is a total body rejuvenation process involving massage, hair restoration and shaping, manicure, acupuncture and an environment guaranteed to help you relax. A single bodycure™ takes 3 hours and costs 450 eb, though discounts are given if you purchase coupons for ten visits (4000 eb). Bodycure™ requires that you make appointments at least twenty-four hours in advance.

Game Notes: Each Session increases your Attractiveness by +2 for 1D6 days. You may only have one session at a time.

Figured: Neural Interface Processor Installed and Closeup

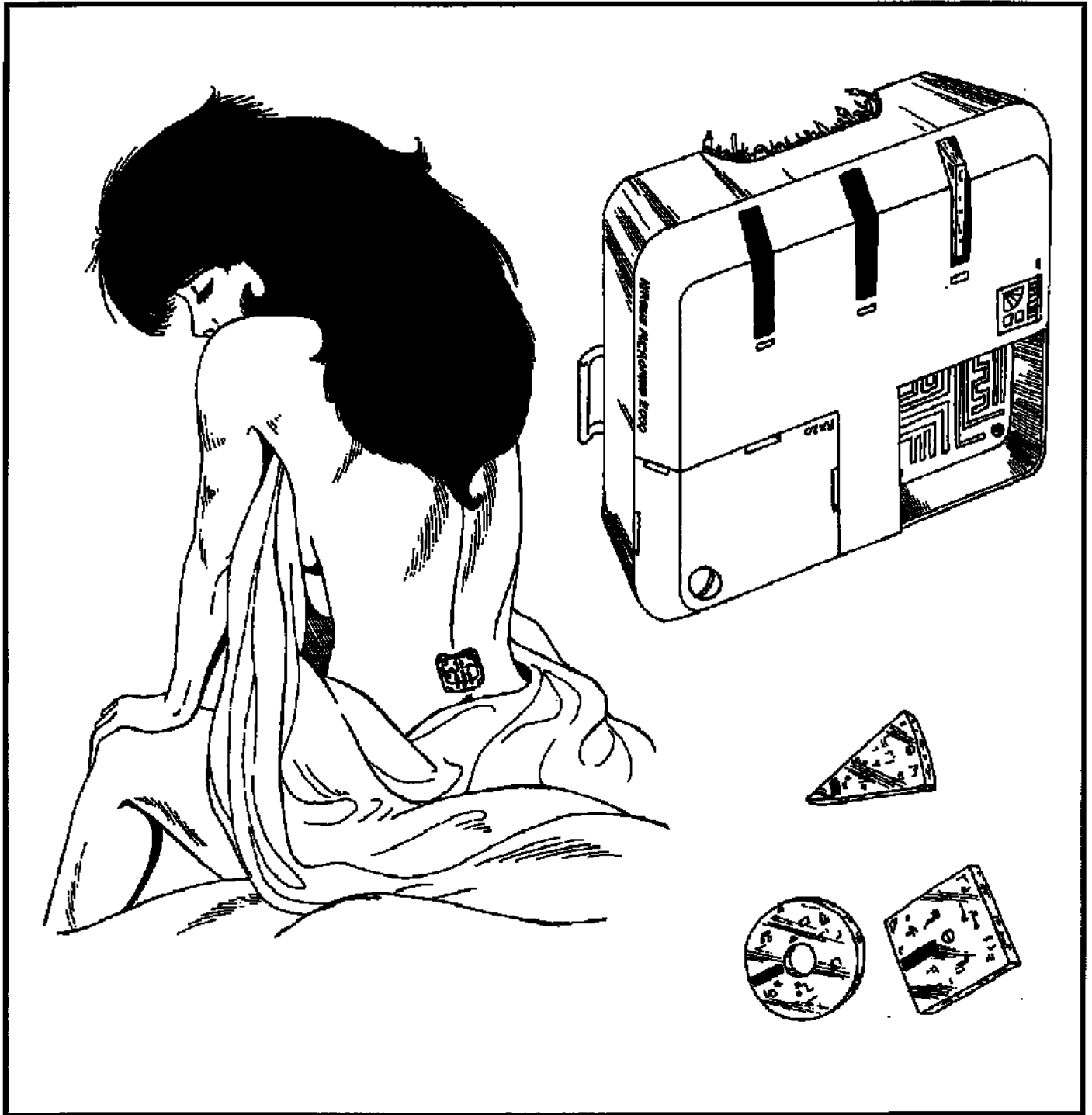

CHROME WARPER

Mindwear For the Future Edge

Security & Operative Chips

If you're holding the line on the Street, you need every edge you can get. Now access the latest in cyberchips and dataware from Digital Dimensions, the leader in paramilitary and police operations chipware since 2010!

M.O. Chips

A must for Cops and Bounty Hunters!

For 3 years, an East Coast police department (in collaboration with Digital Dimensions) has been working on what has been termed the most important development in criminology ever conceived. With the advent of the MRAM chip, criminal psychology experts have (aided by Microtech's AI division), developed several experimental "M.O.chips" of the city's 10 Most Wanted list. These chips plug into any standard chipware-processor socket and function basically as a memory chip. The chip contains a partial personality construct of the criminal, including all data police records have on the criminal's M.O., his contacts and character traits. This enables the investigator to better understand the criminal, and aid in speedier capture or termination. **Black Market Value: 1200eb.**

Game Notes: Recently, some of these chips have unofficially "appeared" on the black market. An M.O. chip will enable the chipped character to ask the referee one yes/no question, per successful INT roll (INT + 1D10 vs 15), about the criminal or his actions. One dangerous thing about M.O. chips is that the character must make a roll against his Empathy (EMP + 1D10 >= 10) when he first uses the chip. If he fails, his personality will shift to that of the criminal's (this is best done by good roleplaying, but if necessary, the character may have to become an NPC). The character will remain in this condition until the chip is removed (which he will not want to happen); if the character receives regular therapy, an EMP roll (EMP + 1D10 >= 12) may be made once per week. If successful, the character regains his personality.

Courier Chips (special CPM chip)

Worried about the safety of electronic data transmission?

Program our special Courier Chip with the data you want delivered and enter a ten character alphanumeric code; the chip will imprint the data (via processor) on a portion of the courier's brain. Then remove and erase the chip. The courier will be unable to remember any of the data until the alphanumeric code is spoken out loud to him. He will then recite the information verbally. While delivering the message, the courier will be in a trance-like state, and will not be able to remember afterwards any part of the data delivered. (Very Difficult to Near Impossible Interrogation skill check will get the information out of the courier, if psychological and chemical methods are used. This will not work if the courier has already delivered the message.) **Cost: 600eb**

Security Chips

Worried about people stealing your personal skill chips, or electronically retrieving erased info from your programmable chips? Use our new security chips. This special line comes in two types. One type, when erased, stays erased, the best

hacker can't bring it back. The other type is made of memory silicon that can be melted after being removed from the user's chip slot. (An IMPOSSIBLE Computer tech skill roll will recover material from the first type of chip; information on the second type cannot be recovered.) **Cost: 50eb/Type I + base price of chip, 75eb/Type II + base price**

Digi-Tone ID

This chip, when used with cyberaudio, or interfaced to a recorder or modem, can pick up and recognize a digital tone phone signal, allowing the listener to know what number has just been dialed. The actual number can be displayed via TimesSquare or Skinwatch modification. **Cost: 70eb.**

Special Operative Chip

Be prepared!

—Find yourself being dropped into the sharp end at the last minute? Have no fear, we've got just what you need. Our special operative chips are created to cover a number of hotspots around the world. These special chips provide a basic understanding of the local language and culture. In addition, the chip provides the user with knowledge of the basic geography of the land (including the detailed location of important cities and geological features). Chip provides *Language +1*, *Specific Knowledge[geography] +1*, and your choice of *Wilderness Survival +1*, or *Specific Know.[police practices] +1*, or *Culture +1*, or *Specific Know.[military organization] +1* for the country in question. **Cost: 900eb.**

Poser Impersonation Chip

Live an idolized life!

Just looking like JFK doesn't mean you know all about him, or how to act like him. Poser chips solve the problems; these chips provide all the information you need to exactly match your role model. Special feedback circuits even allow you to sound much like him. For an extra 200eb, biofeedback circuits will allow you to copy nervous gestures and habits that your role model displayed. Chips for a number of Poser gang favorites are available. (The chip gives the Poser *Specific Knowledge [subject person] +2*, and *Perform +1*). **Cost: 900-1100eb**

Game Notes: The above chip can be designed for a person still living, allowing him to be kidnapped and impersonated by someone that has been 'sculpted to look like him. However, it would take major euro to fund the investigations and surveillance needed to program the chip correctly.

Storage, Entertainment and Information Chips

Even if you're not one of the cyberelite, you can still get some leverage from the technological edge. Interface with these new entries from *DataEdge*, *Parts N' Programs*, and *SegAtari*.

PhotoMemory RAM Chip

Make the moment last!

A biochip capable of recording base cognitive patterns and emotions, effectively giving the user a selective photographic memory. Playback is not like being there, rather it emulates the process of remembering certain events or facts. (Make an Average INT roll to get a specific memory, the chip adding +2 Every 6hrs. over 24 raises the difficulty lvl. by one.) One RAM chip can hold approximately 24hrs worth of full memory. The chips are very expensive, but re-recordable. **Cost 1600eb., depending on the dealer.**

Memory Compression

More skills in a smaller package.

A new technology using pizo-electric crystals has allowed our researchers to come up with a higher rate of storage compression on skill chips. This has allowed us to place up to three skills on one chip, with very little quality loss. (Up to three skills can be placed on one chip, but the skill bonuses cannot exceed a total of +3. For example, the chip could contain three skills at +1 level each. The skills must be all Memory or all Reflex skills; the two types cannot be mixed on one chip. Since the skills are on one chip, they only count as one towards the maximum number of skill chips that can be run at one time.) **Cost is normal price/level for the skills, plus 200-400eb. for Memory Compression.**

Programmable Chipware

Save time and money!

Tired of wasting valuable company time on training new employees? Use our new prog-chips and Chip Programming Module (CPM). Simple job routines and company policies can be programmed into the chip via the CPM's keyboard and drive. (While the CPM/MRAM chips can provide basic knowledge on a specific procedure, they will not provide an actual skill level.) **Cost 50eb./chip, or 400eb./10 chips and 1000eb. for the CPM**

Mind Games®

The newest in recreational cybernetics: SegAtari Mind Games. Play 300 of today's most popular video games in that most unspoiled of environments—your mind. Usable with any standard chipware processor, the SegAtari 99-type Mind Game Chips make your mind the playing field. Try our most popular games: *Cyber Ninja*, *Mutant Death Race*, *Hackman 3* and *Brazil Invaders!* As if that isn't enough, you and your friends can interface (via any basic cables between your plugs) and play against each other! Buy it now! **Cost: 40eb. per gamechip**

Business Trip Chip—

Avoid those foreign faux pas!

As an executive, you may find yourself assigned to a foreign country that may be as alien to you as outer space. But stay chilled—we've got just what you need. Via Memory Compression, we've built business chips for a number of foreign countries, providing a basic understanding of the language, and information on the native culture and customs. So far we have chips for Japan, most of United Europe and the U.S., and hope to include the Sovs and certain African states as well. (This chip will provide its user with *Language +1*, *Culture +1*, and a choice of *Wardrobe/Style +1*, or *Business Law +1*, as applicable to the inhabitants of the country.) **Cost 800eb.**

Tourism Chip

Act like a Local! Or just look like one!

Visiting a foreign country can sometimes prove very embarrassing, especially if you don't know the language or customs. Thanks to help from expert tour guides, special chips similar to our business models have been created for a number of oft-travelled countries. Customs, law, and points of interest are among the knowledge included. (The chip contains *Language +1*, *Culture +1*, and *General Knowledge +1* for the country specified.) **Cost 750eb.**

New Skill: Culture. This specific knowledge skill provides the user with basic knowledge concerning the culture of a foreign country and its people. Without this EMP based skill, a character will have a +2 on other EMP skill rolls when dealing with a NPC from another country.

Space Chip

Visiting space? Don't leave Earth without it.

A busy executive never knows where the Corp will send him, and someday he might be sent out of this world. Utilizing Memory Compression and the latest biofeedback breakthroughs, we have created a chip that will help anyone visiting Near Orbit habitats and provide basic knowledge on how to survive Up There. (The chip provides the following skills: *Space Survival +2* and *Highrider Culture +1*.) **Cost 900eb.**

Maximum Lover Chip

Sure, you've got a Mister Studd. But it takes more than hardware to really interface right with a lover. Our new chip can tell you what to do (65K *Kama Sutra* database integral), when to do it, and what to say while you're doing it (thanks to a 154 line database, accessible via any cyberaudio or Times Square). Don't be tagged as an insensitive metal man! No matter what your Empathy rating, jack into *Maximum Lover* and be the man of her dreams (Add +2 to any Seduction check). **Cost: 1300eb.**

Biofeedback Chips

Take command of the future with the new twist in chipware technology. Don't settle for a chip that just transmits data, or teaches the body certain physical skills. These new designs from *BioTec* Σ send and receive messages directly to and from the brain! *BioTec* Σ ; the future in APTR!

Stress Chip

Are you plagued by tension headaches from office stress? Does close gunfire make you overly nervous? We've got a chip for you. This special biofeedback chip sends a message to your brain creating calmness and serenity, removing tension stress. (Not only does this chip provide relief from migraines and hypertension, but while chipped in, the user has a +1 bonus to his COOL for the purposes of combat morale. He also has a +1 to his EMP stat while using human interactive skills.) Cost 350eb.

Adrenaline/Endorphin Surge

If you want to ignore the pain of the bullet wound in your side, or just ignore exhaustion while working overnight on a business report, this is the chip for you! Signals are sent to the brain, blanking pain and exhaustion symptoms; plus 3 times every 24 hours you can signal for a spurt of adrenaline to give you the edge. Cost 800eb.

Game Notes: Pain/Exhaustion effects: with the chip in, food and sleep can be ignored for 48 hours straight. Skill penalties due to wounds can be ignored, except for head wounds. Once the time is up, or the chip removed, you must sleep 2 hrs. for every 1 hr. over normal rest times you have gone. During this period your stats are halved. Adrenaline effects: the user's BOD stat is increased by 1 for purposes of BTM, Stun/Shock saves, and skill rolls. This effect lasts 1 min. per use.)

Increased Neural Feedback Option

Utilizing the new biofeedback chip-tech, we have come up with new APTR chips. These new chips take half the learning time that the old chips took, but the increased neural feedback burns the chip out rapidly (within 24 hours of use). Currently, these new chips are only economical if you need the ability quicker than the old type would allow. ("Chipping in" is 1/2 the normal time needed, but the chip becomes useless after 24hrs. of use.) Cost equal to a normal APTR chip plus 400eb.

Ambidexterity Chip

Never be caught "short handed" again.

A biochip which augments the user's motor control, rerouting control energies across the body, and consequently making the user ambidextrous. Anyone using an ambidexterity chip can use two single-handed tools or weapons at the same time, thus receiving—under some

conditions—twice the normal amount of actions. However, because this chipware does not grant the user any ability to independently focus the eyes, actions performed with both hands must be directed at a single objective. Cost: 800eb.

Game Notes: If the character has twin cyberoptics, a second chip may be added for 250eb. that will allow independent action for each arm.

DeathTrance

Great party trick!

This rare APTR chip will, when studded in, allow you to put yourself in a death-like trance at any time (recovery from the trance is on a timer function). This trance includes lowering and almost total stoppage of heartbeat, respiration, circulation, and EEG activity (life functions can be detected on a *Medtech* roll of 25+). The trance takes 1-3 minutes to enter, and so cannot be used for most first aid purposes. This chip is useful for long trips in cramped quarters or extended periods of waiting. Cost: 1000eb.

Redundancy Loop

When you don't want to be perfect, just good enough.

You have to play tennis with the boss, but you've never played before. *No problem, you say; just chip in a Tennis APTR.* But what if the chip is so good, you actually win? That's where our new Redundancy Loop comes in. We can program an APTR chip so that at the right moment you'll err slightly, allowing the boss to win without it looking like you threw the game. We currently have chips for tennis, racquetball and golf (more are on the way). (Chips with Redundancy Loops will screw up at a crucial moment. At that moment the Ref should secretly make a skill check roll at the same time the player makes his. The lowest roll will be used to determine the success of the skill check.) Cost: 50-75% of a normal skill chip.

"Fish N' Chips"

A dietary biochip which serves as an appetite control device, set to reduce the level at which the user will feel full, thus keeping their weight down. Popular with fashion models and people suffering from eating disorders. Cost: 85eb.

Visual Recognition Chips

Cost: 100eb./level to +3 (Police chips are 200eb./lvl.)

For use with TimesSquare Plus™ (pg. 38), these new database chips from *Direct Dataware* can get you the most out of any direct visual stimulation cybersystem. And at a cost that's a bargain for any Corporate employer! [All V.R. chipware rolls are INT+chip+1D10+(any applicable *Specif. Knowledge*)]

Techle Chip

For IDing circuits, parts, tools, manufacturers, serial #'s, etc. Chip is only valid to date of manufacture.

Task Difficulty:

Easy Task-visual identification of tools, manufacturer's logos with address and phone, circuit diagrams.

Average Task-visually identify circuit diagram and purpose from printed circuit boards.

Difficult Task-identify manufacturer from product visual.

Very Difficult Task-identify manufacture date, location, etc. from serial number.

Corporate Officer Chip

The Corporate Officer chip allows recognition of Corp officers, documents, and other operations, giving limited biographies on certain personnel. Prices as above; quarterly updates are available at 50eb, 100eb and 150eb (based on level). These chips are only available to corporate employees.

Task Difficulty:

Easy-employee's name and position

Average-the above, plus spouse's name, children, home address, etc.

Difficult-the above, plus employment history, transfers, co-workers, special projects involved in, etc.

Very Difficult-full biography, life events, etc.

Police

Visual ID's on criminals and licenses. References for auto tag hot sheets and APB's, etc. Plus daily/weekly crime SitReps. These chips will pull felons' records, vehicle hot sheets, etc. at the listed difficulty levels. Misdemeanors require different chipping. European criminals are listed by INTERPOL weekly. Cost 200eb./lvl. up to +3. Daily/weekly updates are a one-time fee equal to 2.5x normal price, plus update terminal for 10,000eb.

Task Difficulty:

Easy-identify stolen plates, wanted person via driver's licence, CIA/FBI Ten Most Wanted on sight.

Average-visually ID local suspects, NCIC top 100 list.

Difficult-visually ID internationally wanted criminals from passport/ID card or rap sheet.

Very Difficult-identify nationally and internationally known/wanted criminals on sight, even with simple disguises.

Military

Uniform and unit recognition. Weapon/Vehicle specs from silhouette ID's. Prices as standard. Chips should be replaced

annually. Those older than two years can be bought for 1/2 price.

Task Difficulty:

Easy-nationality, name of force.

Average-the above, plus rank or general object specification.

Difficult-full technical specifications, unit standings.

Very Difficult-complete unit history, vehicle/weapon manufacturer's background.

Rocker

With this chip you can identify certain instruments, recognize songs (when interfaced with cyberaudio), and display specific sheet music to your cyberoptic. Music company execs and talent scouts can be IDed if their images are preprogrammed into the chip. Talent scout and executive images need to be updated each year (50eb). Cost 100eb./level up to +3.

Task Difficulty:

Easy-identify instrument (class and use), display pre-stored sheet music.

Average-identify name and company of major music corp execs.

Difficult-audio song recognition with HUD of sheet music.

Very Difficult- visual ID of record company scouts.

Secretarial

With this chip, you can put a full reference file for all of your employer's clients, contacts and associates on the tip of your mind! Files faces, cross references names, indexes birthdays, personal data, previous appointments, letters on file (recorded with optional camera implant), and a 100,000 number phone file.

Task Difficulty:

Easy-identify person by face, with reference to name & position.

Average- above, plus spouse's name, children, home address, etc.

Difficult- the above, plus any correspondence, memos and phone call records within the last two years.

Very Difficult- the above, plus personal facts, biography, birthdates of family members, presents and gifts given or received in name of your employer (very important in the Asian Theatre).



Housing

LIVING FACILITIES FOR
THE CYBER AGE

SLEEPCHAIR

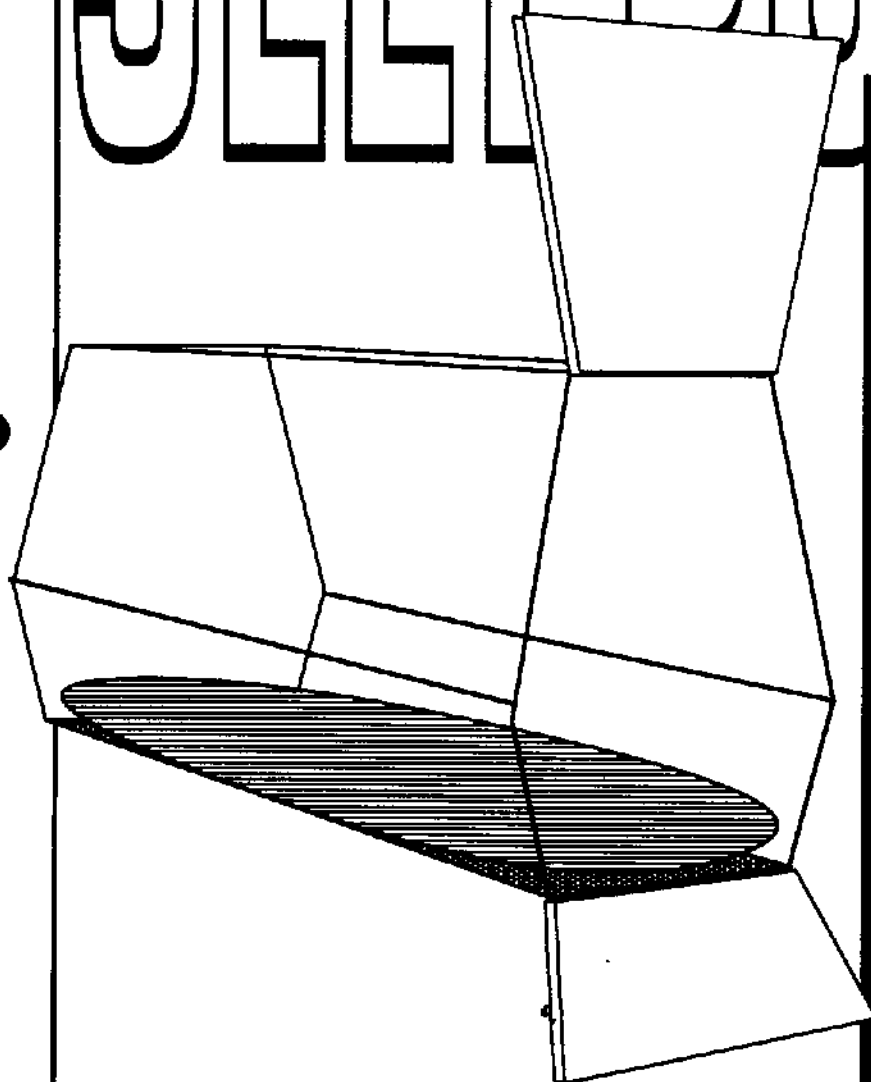

"You gotta remember; since the late 20th Century, having a place to live isn't a given. These days, you're lucky to find a sheltered alley or dumpster. You just can't assume you'll be able to rent a conapt anywhere you want, even if you have the euro to front the action. You gotta plan ahead..."

—Ripperjack

"I got a bike, I got a Drifter RV. I got a gun to keep 'em both. Don't nobody call me homeless."

—Nomad Santiago

Sleep Facility

ARASAKA ARASAKA ARASAKA

Comfort. Privacy. Security.

The Arasaka Sleep Facility provides all three at a reasonable cost. The ASF network is a series of sleeping establishments set up in nearly every city of the globe. Each building is equipped with hundreds of sleep cubicles, spacious enough to hold the largest man in comfort, yet inexpensive enough to fit that budget on the run.

Each Arasaka Sleep Facility has a resident lounge, where guests can get to know each other in a relaxed environment far away from the hustle and bustle of the city. In addition to that priceless commodity, there are also entertainment centers which provide access to over 180 channels, both public and cable, from around the world.

Many of the major ASF buildings near Lev Train stops, giving nearly immediate access to the city for those quick "getaway" journeys, or just a relaxing romp through the urban marketplace. Who can tell what can be found just around the corner? Maybe a new friend from another cubicle might know!

What you'll get for your 40eb.:

- A clean and comfortable sleep cubicle, satisfaction guaranteed.
- Full use of all Arasaka Sleeping Facility's lounge and entertainment centers.
- The chance to meet new and interesting people.

For small additional fees, the following services are also available:

- Electrical outlet. Only 10eb. per hour of use.
- In-cubicle television. Only a 50eb. deposit and a 5eb. fee.
- In-cubicle radio. Only a 25eb. deposit and a 2.5eb. fee.
- Private telephone. Only a 10eb. initial fee and 0.75eb. per minute.
- Heavy-duty lock. Only a 100eb. deposit and a 10eb. fee.
- Privacy option. Only a 1000eb. deposit and a 100eb. fee.

Comfort. Privacy. Security. Arasaka Sleep Facilities provide all these and more. Stay at one on your next trip and hide away from your troubles.

Inside A Sleep Facility: Sleep facilities (The Cubes) are large, box-like buildings, unattractive and depressing. They are pestholes of filth and degradation, catering to the misplaced, mistreated, or mistrusted of the world.

The only windows are on the first floor, where the lobby, main operator, entertainment facilities, and resident lounge are located. Each main operator handles requests from the tenants (which are typically ignored), as well as admits new guests and takes care of the money. He sits inside an armored room with SP 14 walls, with a 12 gauge shotgun nearby. There is also an emergency button to call the police or fire department, but these calls are also typically ignored.

A standard ASF has 800 cubicles broken down into 80 cubicles per floor, making the building around 11 floors. The extra floor of space is used for storage. The cubicles themselves are broken down in groups of four, stacked two by two. Larger facilities can have as many as 1,000 cubicles, and the largest, located in Tokyo, has 2,000.

Washrooms are located at the end of each hall and provide enough sinks, toilets, and electrical outlets for half the number of cubicles in the hall.

The train facilities are usually located at a platform adjoining the ASF, or sometimes inside the ASF, either running through an enclosed first floor terminal or through a sublevel.

Sleep cubes are 2m x 1.5m x 1.5m, providing just enough space for a man to sleep in relative comfort. The beds are slabs of soft plastic, permanently affixed to the floor and usually stained by unmentionable things

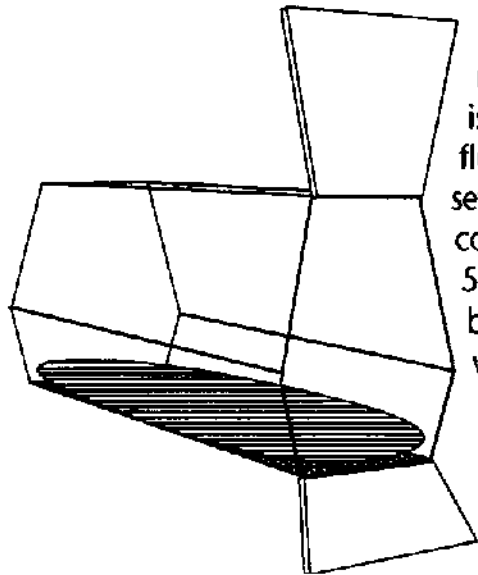

spanning all colors of the rainbow. Lighting is provided by two fluorescent tubes set into the upper corners. There is a 50% chance that both lights are working.

The door is much like a torpedo tube hatch, and the lock is little more than a bar

slid across the entry. (Difficulty to open = 6). The door is SP 14, and the walls are SP 20.

The television option provides a small set built securely into the ceiling of the cubicle. Reception and maintenance are poor in an ASF, and only a fraction (around 20%) of the 180 promised stations come in. Radios usually work better, giving nearly full access to all stations, at least in the immediate area.

Anyone trying to get inside the radio or television automatically sets off an alarm at the main operator's desk and immediately forfeits the deposit. Getting to the equipment is a Task Difficulty 10 vs the *Basic Tech* skill.

Price: 40eb/night + options.

What Goes on at an ASF: Everything from drug deals to sex games happens at a sleep facility. ASFs are a good place to pick up new contacts and a better place to get killed. Most of the action at a facility runs toward petty theft and similar crimes, but occasionally a travelling ripperdoc takes up shop in a cubicle, adding to the number of stains on the bed.

The chance to find some piece of equipment such as a gun or similar piece of hardware is Difficulty 8 against the *Streetwise* skill. Searching for a chump to do a crime runs between Task Difficulty 6 to 12 against the *Streetwise* skill, depending on the severity. Ripperdocs are naturally wary, and finding one is Difficulty 12 against the *Streetwise* skill.

Gambling is the most common form of entertainment at a sleep facility, especially since the televisions and radios usually don't work. Prostitution is the second most common form of entertainment. No roll is needed for either.

The heavy-duty lock (DIFF 18) is a must for any rational resident at an ASF. When a character checks into a facility, the Referee should secretly make an Intimidation check (DIFF 8). Success means the character's cubicle goes unmolested for one week. For every point below the needed roll, a thief tries to break into the character's cubicle. An equal roll means one attempt is tried. The Referee determines when this happens (whether or not the character is home). No more than five attempts can happen in a week.

The privacy option is little more than a bribe, and the actual price may vary.

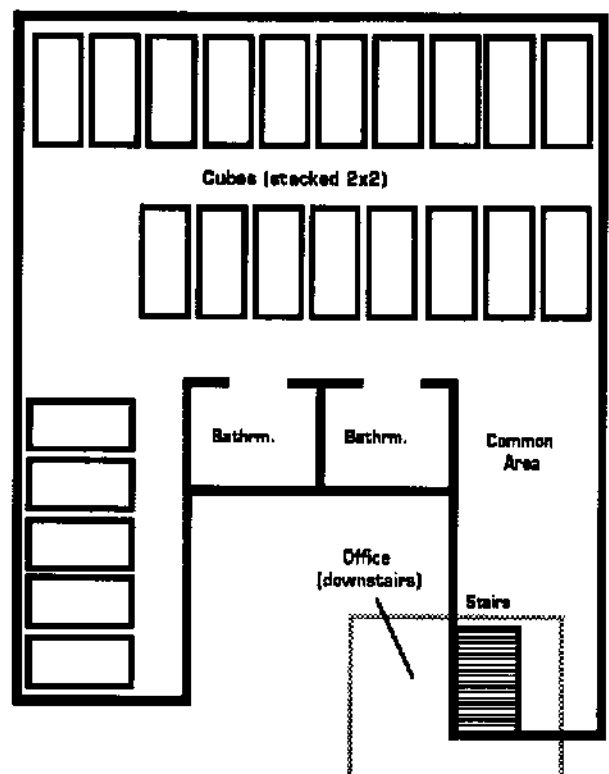

Security Services, Inc.

Professional Apartments

As a valued member of your company, you know that the right conapt is more than just a contract perk—it's a necessity. Security Services, the leading supplier of housing to the Corporate market, understands your requirements, and knows how to meet them by providing only what you expect: the best.

In designing these deluxe spaces, Security Services addresses the three greatest needs of all professionals. The first requirement is *style*. A fine conapt should reflect its owner's impeccable taste. Therefore, Security Services uses only the top floorplan and furniture designers, including such legends as Laubenstein, Bradstreet, and the ever-popular Nagano.

The next requirement is *communication*. How quickly can you be reached from work? Using the most advanced paging equipment, Security Services ensures that you can be contacted anytime, guaranteeing that you can make that "Big Deal" at a moment's notice. We offer a "hands-off" ten line phone system with hold, call-waiting, and conference calling, including a full-page, legal-quality Fax link for those "must-have" documents. Naturally, our sat/cable television and radio modules are second to none, receiving broadcasts from around the world with crystalline clarity.

The last and most important requirement of the high-pressure, high-opportunity world of the 21st Century is *security*. Whether it's protecting your work or protecting your life, we feel Security Services should be your choice. Store your important work in

a personal safe, hidden anywhere in your flat, with combination and location known only by you and our security experts. Protect your hard earned possessions with an ultrasonic security net, ensuring that anything larger than a small pet will set off an alarm. And with our off-line central alarm system, computer tampering and break-ins are impossible!

At Security Services, we believe the best security has that personal touch, which is why we provide all our apartment complexes with a team of expert security guards, armed and ready to defend *your* life and property. They'll check all visitors for identification and weapons, and call you for confirmation of your guests. There's also an in-house video camera system as an extra precaution.

Security Services also provides other invaluable services, such as valet parking for your automobile, maid service, and regular food deliveries by the meal, or by the week. We even provide pet care.

Only Security Services offers the Corporate Client so much:

- Your choice of three floor plans by the hottest designers today.
- Your choice of ten major furnishings, plus three major kitchen appliances.
- An advanced telecommunications system for those important conferences.
- Television and radio with satellite link-up to anywhere in the world.
- Your own private safe placed in a strategic location of your choice.
- Ultrasonic security; the best available.
- Trained, on-site security personnel and video security equipment.

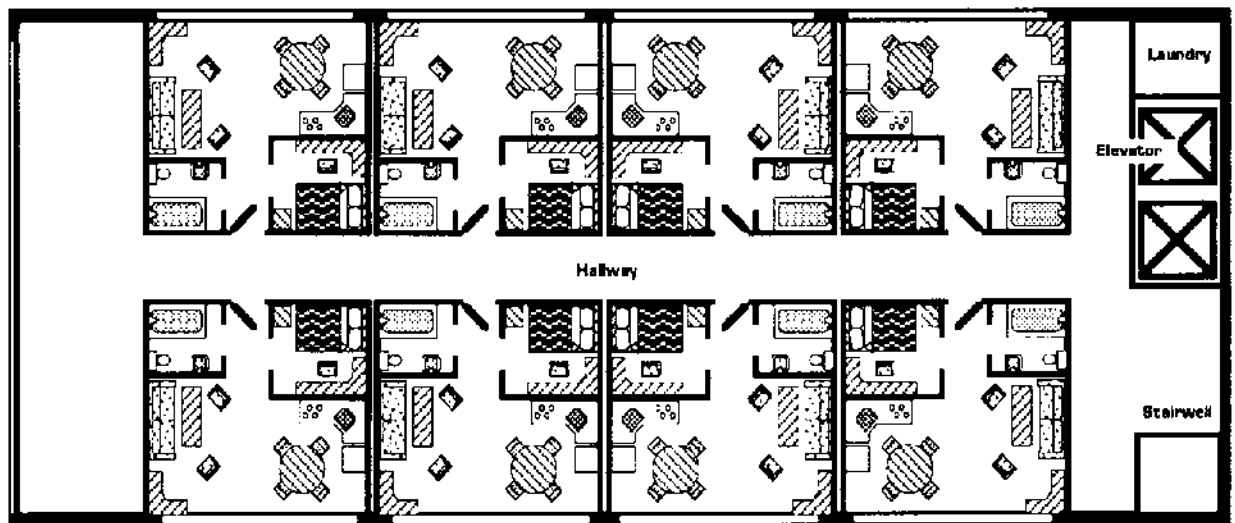
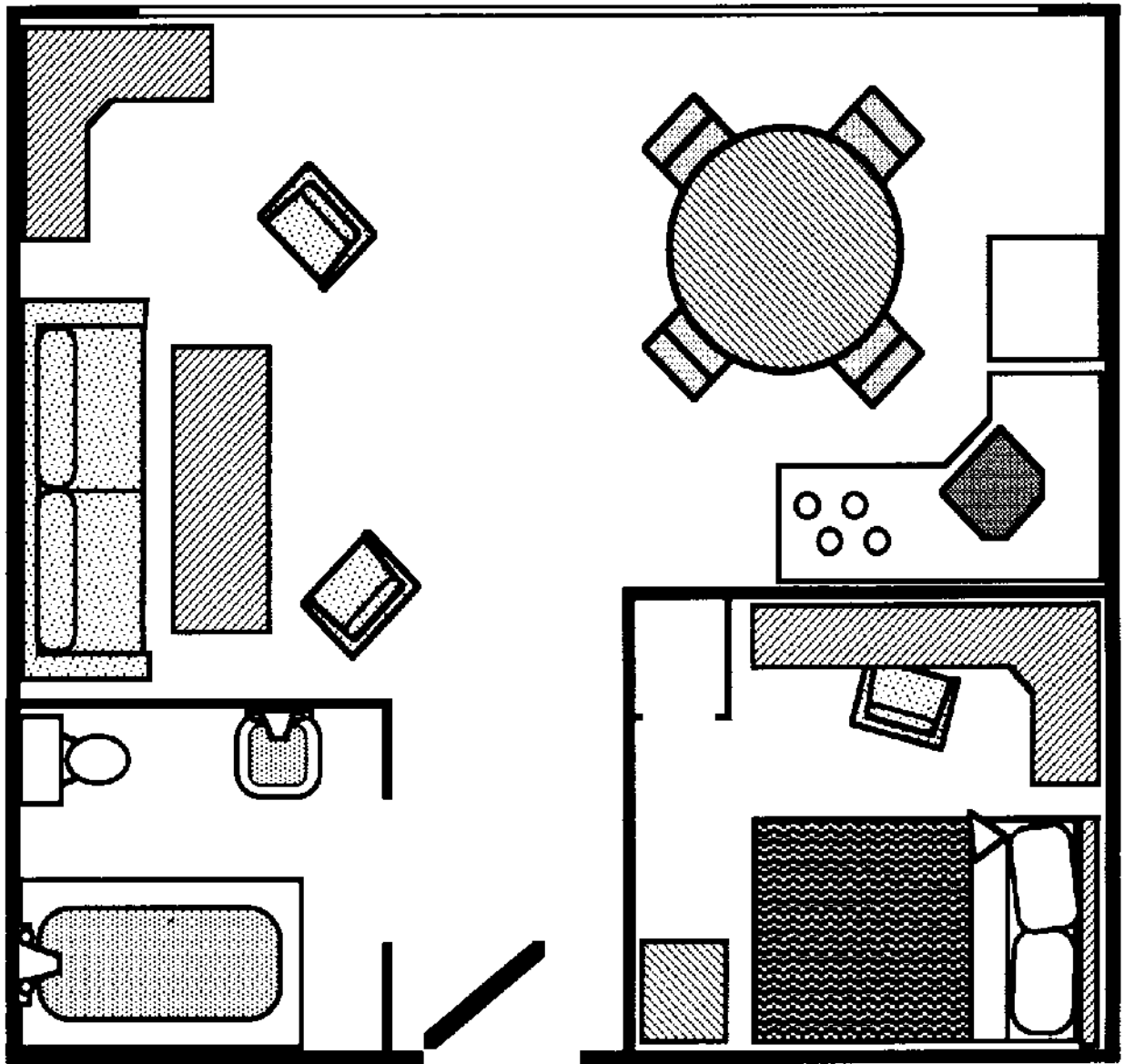

**CORP APARTMENT
& Typical Building Floor Plan**

CHROME HOUSING

Sound impressive? There's more. For small additional fees, you can get more furniture and even a fireplace for those romantic interludes. Food service can be upgraded to include exotic dishes from around the world. We can add pressure sensors to the floor and infra-red detectors to the walls for even tighter security. You can also store documents in our main building safe for extra protection. Don't see something you want? Tell us and we'll get it. There's no limit to the lengths we'll go to please you, the Corporate client

Live up to your company's high standards (and your own) by moving into a flat built by Security Services today. Think of everything we provide, then look at any other apartment around. We dare you to find better. Style, Communications, and Security. Security Services flats have all the necessary qualities for a healthier, more productive, corporate life.

Remember; when your Lifetime Contract comes up for negotiation, you deserve something more than just a Trauma Team account. As a valued employee, your Corporation has the option to offer you the best in management housing. When they ask you what you want, tell them Security Services.

Rental: 2500eb. per month

Notes on the Corporate Flat: In the 2000's, many Corporations hire housing services to provide living space for their most important employees. A corporate flat is usually offered to an employee for three reasons: the company needs a place where they can reach their worker; the company needs a place where they can spy on their worker, or the employee asks for it as a contract "perk" (living space being so hard to find in 2020). In any case, there will be some type of listening devices placed in the flat and the phone lines will be tapped (Detection Difficulty=18).

Extra furniture can be rented for a 20-50eb. fee. An upgraded food service is also available for 100eb. per week or an extra 20eb. per meal. Extra pressure and IR sensors cost 2,000eb. Using heavy security safe is a 100eb. per 10 pages of documents stored.

The ultrasonic sensor creates an invisible net of sound that sets off an alarm if broken. The net effectively fills the entire room and anything larger than a cat sets off the alarm. Characters with cyberaudio in the ultrasonic range are able to hear and pick out the emitters' locations. The chance to find a sensor is Difficulty 10 against Awareness.

The infra-red sensor beams are set up at shin level at the door and in the middle of all windows. Anything crossing a beam sets off an alarm. (IR-detecting cyberoptics can see the beams). Pressure sensors activate if when more than 2 kg are placed on them, and are located at doors and windows (Difficult to detect). Both ultrasonic and IR sensors have SPs of 6 and audible alarms.

When an alarm sounds, the guards call the Chief of Housing enroute to the conapt. One guard always mans the phones, while (1D6/2)+1 guards answer the alarm call. They are typically armed with pistols or shotguns; and wearing armored jackets.

The personal safe can be hidden in anything or placed anywhere, even inside an appliance or the ceiling. The safe's total volume is about one cubic foot. It is SP 24 and effectively impossible to remove unless inside something like an appliance. The building safe is located in the guard's room on the main floor and is SP 34.

The security measures have no central computer link, so they cannot be tampered with by Netrunners. Netrunners may, however, use the telephone and satellite links.

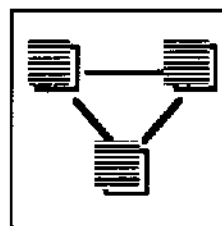
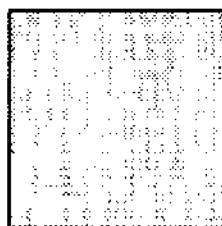

Security Services

STYLE • COMMUNICATIONS • SECURITY

Harris & Company

When there is no substitute. . .

. . . it must be designed by the craftsmen at Harris and Company, faithfully serving the world's aristocratic, professional, and entrepreneurial communities for over twenty years. Creating such masterpieces as the Network News 54 Broadcast Tower and the Orbital Air Space Center, as well as refurbishing historic Comisky Park, Harris and Company is the unprecedented master of urban design, catering only to the most exclusive clientele.

Harris and Company is proud to unveil their most recent creation, set among the venerable spires of beautiful San Francisco: Triumph Tower. Triumph is the finest skysrise built, a symphony of steel, glass, and gold, with authentic wood accents (a daring innovation by our master designer, Pat Stephens). Inside and out, Triumph Tower shatters all previous concepts of luxury and taste. Critic Otto Comejo of *Big Time Magazine* describes it as "Superlative!"

Offices, lofts, and residences will be available soon, but we at Harris and Company wish to extend this special invitation so you may attend the exclusive auction of Triumph Tower's pride, the **Masterpiece**. The Masterpiece is the only penthouse suite in the Tower, and is as unique and priceless as a Warhol Monroe. We need not go into detail of what wonders the Masterpiece holds for its final owner. Harris and Company's reputation says enough.

Contact your local broker for bidding dates and instructions. Don't pass up this opportunity to live in a work of art.

Opening bidding price: 800,000eb.

Luxury Penthouses and Conapts

Special Penthouses and Conapts

Notes on the Masterpiece: A perfect example of a high class apartment suite (suitable for ranking Corporates) the Masterpiece is accented with gold and wood; the frame is constructed from more mundane materials. The Masterpiece takes up two floors, the lower holding the kitchen, main living room, entertainment room, and various guest and washrooms, while the upper contains the master bedroom, workout room, and the master bath. The roof is also a helipad.

Everything that could possibly be crammed into a single dwelling can be found in the Masterpiece, and of course, everything is top of the line. All televisions, stereos, computers, and telecommunications are accessible from every room with the touch of a button.

The walls, doors, and floors of the Masterpiece are lined with honeycombed alloys and reactive armor, creating an effective SP of 40. The glass in the penthouse is lined with similar honeycombed (and microfilament) metals sandwiched between sheets of transparent polymers, SP 25.

Telecommunications is the most well-developed system in the Masterpiece. The penthouse has a link to the Harris and Company satellite, giving unlimited access to any other communications network in the world. This system includes a scrambler for privacy and a spectrum sweep option to search for specific broadcasts. The number of people that can conference call is virtually infinite.

The computer is almost as sophisticated. Used by the

normal executive or aristocrat, it can analyze the stock market or give the best guess of who to bet on in the next polo match. Accessed by a Netrunner, the computer is an awesome tool for espionage.

The computer comes with *Data and Code Gate Level III, Poison Flatline, Pit Bull, Aardvark, Dragon, and Zombie* (though this last is kept secret from the general public). The 'runner can hook up his own cybermodem through the Masterpiece computer, using it as a "carrier" for protection.

A persona duplication program called *Doppelganger* creates a data "scarecrow" that is targeted by black programs instead of the netrunner. In order for the Netrunner to be effected, the Masterpiece computer's defenses must be defeated first, the *Scarecrow's* second, (it has the same Net combat statistics as the 'runner), and finally the netrunner himself. Programs that wait for users like *Pit Bull* or *Hellhound* cannot track a user through the Masterpiece computer, since the *Scarecrow* is not a true image of the 'runner (although operating through a *Scarecrow* costs the Netrunner 1 point of INT for purposes of Net combat).

On the outside, the Masterpiece is protected by a radar net covering a two kilometer area, detecting anything with a surface area of greater than 2 square meters. There is also a close range motion sensor that detects anything moving along the perimeter of the penthouse. The radar and motion detector domes are SDP 30 and 10 each.

Inside, there is another set of motion sensors, as well as an ultrasonic and infrared network. Alarms on the inside or the outside alert guards on the first and twentieth floors (the Tower is 22 floors tall). The guards are highly trained and equipped with heavy weapons and SP 24 hardshell armor. If desired, the guards can enter immediately to deal with any threat; otherwise they will seal off the floor and wait for the Masterpiece's owner to let them in.

The alarm also lowers steel shutters (SP 40), to close off the windows. It takes a strength of 12 or better to lift these. If the radar detects an incoming intruder, the Masterpiece computer accesses its programs to

determine if the object is friendly or hostile (determined by the owner and a huge list of default settings). Hostile intruders on the rooftop and garden levels can be attacked by the six Apex minigun turrets (pg. 53) set on the perimeter of the penthouse.

In the event of an intrusion through the elevator or the garden/spa area, a close-range motion sensor will activate an electrical defense system that shocks up to six targets at a time with a multi-kilovolt electrical arc (1 to 8 D6 damage; the exact number is determined by the Masterpiece's owner). Like the miniguns, this system can be keyed to exclude certain individuals or vehicles.

Both internal and external security are operational at all times, and there is a backup generator in the Masterpiece's lower level in case of a power shortage. The generator also runs the computer and the elevator.

The computer controls access to everything in the penthouse, and everything is activated either by keypad or voice. The owner presets any guests in the computer's memory, in order to prevent false alarms. The defences can also be switched off by the owner's voice.

For an additional fee, the owner may also include a code-key in any of his cybergear. Scanners in the penthouse read the key and determine if it is the correct code. If it isn't, the alarms go off. Eye code-keys cost 200eb., finger or limb code-keys cost 100eb. Of course, removing the code-keyed piece of cyber-equipment from the owner will give an intruder access to the entire penthouse.

There are many options available on the penthouse. Harris and Company can provide a cook to live in one of the servant's quarters on a lower level of the Tower. Food can be delivered from anywhere in the world. Security can be increased or changed at a moment's notice.

This is the Masterpiece. Anything is possible.

MASTERPIECE

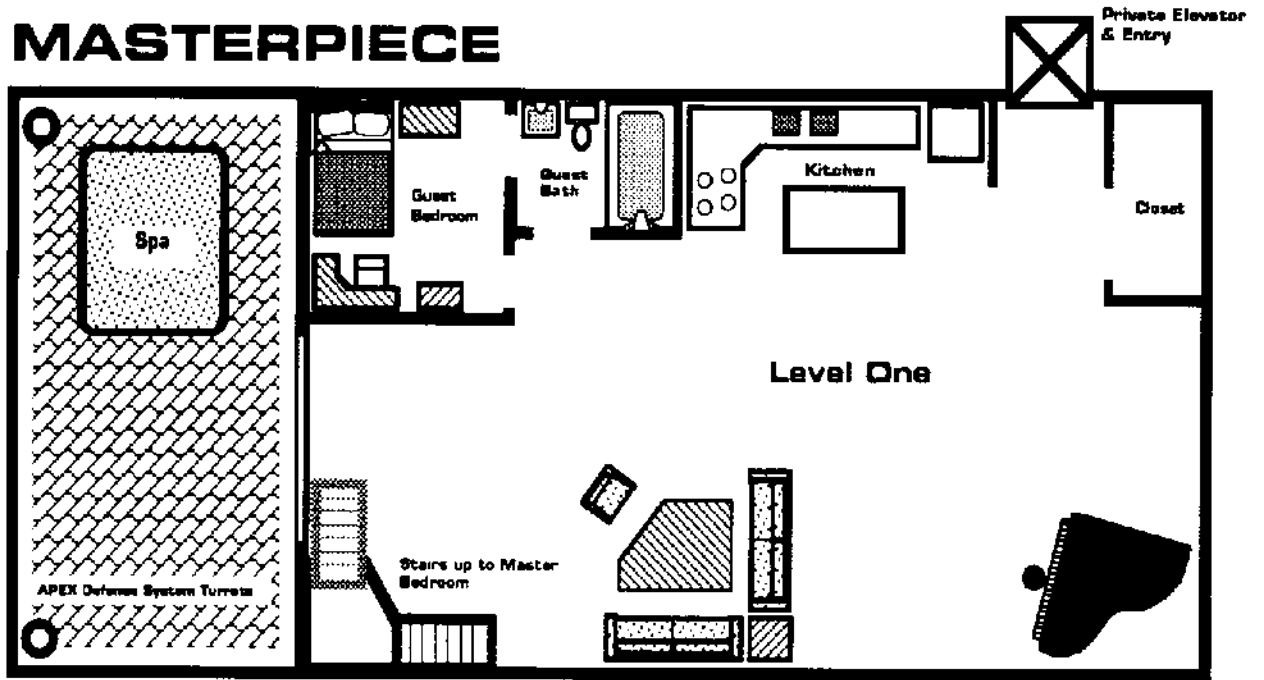

Level Two

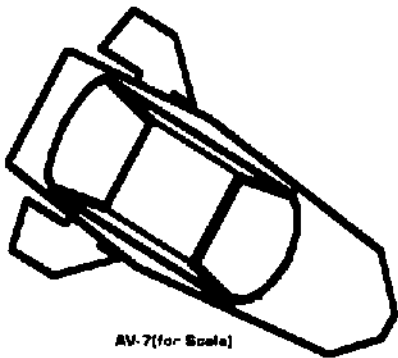
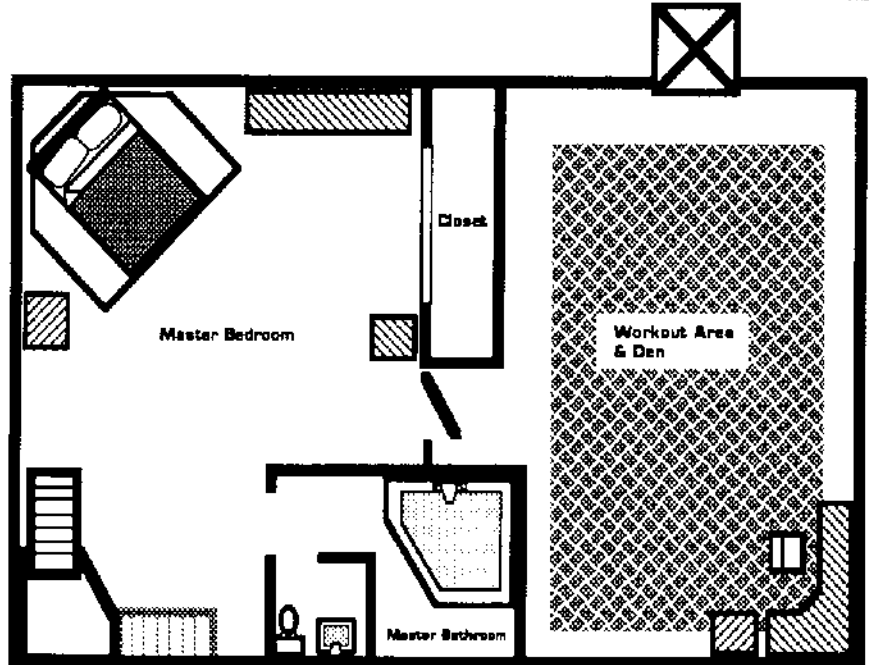

Roof Level

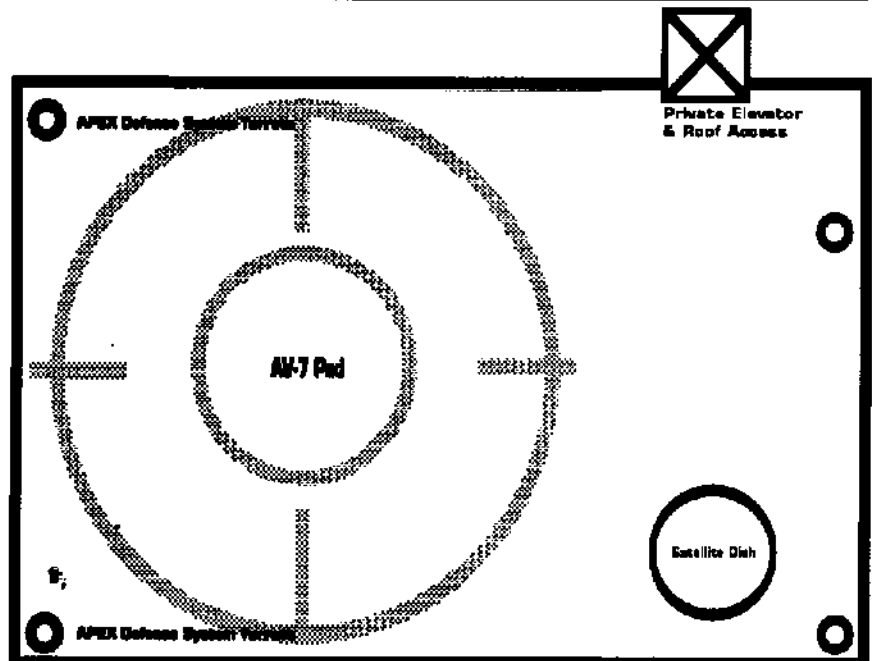

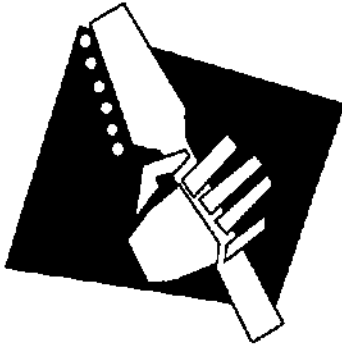

Silverhand Studios

"The difference between artists and normal people is that they leave their windows open when it rains.

— excerpt from *Zen and the Motorcycle Maintenance of Art*

In the days of the Renaissance, artists could get together to discuss their work, free from the pressures of business and the influence of those in power. Today, the mega-corps dictate what the masses see; they control and twist the work of the artist until it suits their overlord mentality: banal and sterile.

Now's your chance to interface the New Renaissance and join a revolutionary artist's community. I've bought warehouses in all sections of the city and converted them into low rent, low profile lofts especially for you, the visionary of the Edge. Whether you're a realtext writer, violence painter, rocker or virtual image creator, my plan is to promote the general welfare of talent; to make sure that talent can grow and develop free from the menace of little minds and Corporate control.

You can do anything you want in your loft. Paint it black, erect monuments to your gods, hang from the rafters and sing like a loon. Hold concerts and poetry readings and orgies. It doesn't matter to me. Just don't wreck the room for the next artist who will live there; that's a 'facer kind of attitude.

Remember; the future belongs to the minds that are free. Don't have it done to you. Be the actor, not the audience.

Johnny Silverhand

Rent: 600eb. per month.

About Silverhand Studios: Silverhand Studios is a private operation run by Johnny Silverhand, rockerboy and popular insurgent. A radical to the end, he wants to give artists a place to do their own thing, free from the manipulations of outsiders. To do this, Johnny has bought warehouses in many major cities and converted them into living spaces. Almost any shape and size studio can be found, some with plumbing and electricity, some without.

The average loft is a high-ceilinged room on the second floor of a warehouse with a dramatic skylight and a huge row of windows against one wall. The first level is usually completely empty, offering the artists a large gathering space. Depending on the warehouse, the structure may be wooden beams or corrugated steel.

In general, there are as many as twelve lofts per warehouse, and washrooms have been installed as needed. Cooking is electric and each room has a complete stove. All the housing is clean and vermin free.

The warehouses become communities, where the artists often get together to drink espresso, eat scones, and talk art. They all know how stereotypical this is, and find it ironically funny. Being among colleagues in such close proximity is conducive to learning, and each year one lives at an artist's community, one gains +1 to his respective artistic skills, up to +3.

There's a sense of secrecy to the communities; the general consensus is that the corporations could move in and take over or destroy the "work" at any moment. This make everyone a bit paranoid.

Cheap supplies (at discounts up to 70%) can be

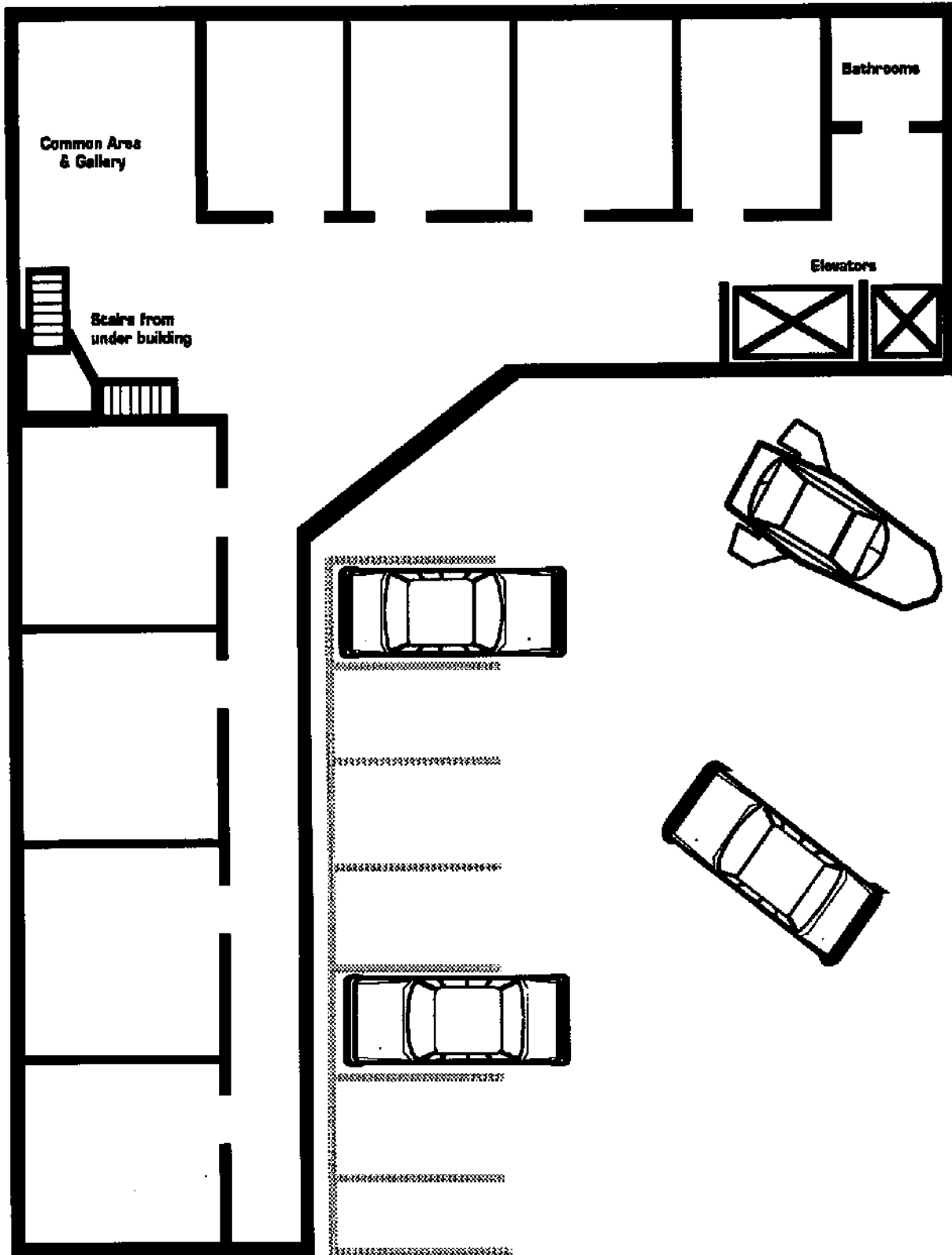

**SILVERHAND
STUDIOS**

obtained by the warehouse's "landlord," who is actually a contact to Johnny's creative agent. All the artists in a given community know how to get in nearly immediate contact with the landlord, (usually an out-of-work solo) who can also provide protection and an occasional hiding place for a particularly "sought after" artist. If an artist's life is in real jeopardy, he or she will be given the location of a warehouse in another city, and asked to leave.

The landlord can also find jobs for the artists so they can eat and pay rent. Silverhand isn't running a

charity, and he figures having to pay rent, as cheap as it is, keeps an artist from losing that hungry edge. There is, however, great leeway when it comes to payment, and artists in a studio often chip in and help pay for each other's expenses.

In addition to those duties, the landlord also tells Johnny when a particular artist is showing great promise. When this happens, Silverhand occasionally arranges for an art dealer to "drop by" the warehouse and look over the artist's work to determine if it has merit.

The Drifter

Mobile Environment

The return of a legend. . .

The legend is the open road, and now you can become part of it. Experience the thrill of travel in your own recreational vehicle from New American Motor.

Adventure is yours when you hit the web of concrete spanning the states. New American Motor's *Drifter* is the flagship of our RV line, providing the best in comfort, maintenance, and affordability. For comfort, the Drifter has two full beds, a comfortable couch, and a state-of-the-art video/audio system. There's also a complete cooking range with microwave and disposal.

Maintenance for the Drifter is simple. Using New American Motor's patented diagnostic computer and modular replacement system, even the most mechanically inexperienced person can fix the rare malfunction. The Drifter also has an auxiliary electric motor for those short intra-city hops.

The Drifter is the most competitively priced RV on the market. New American Motors offers the lowest finance rates (22.5%) and the highest cash back incentives.

Contact your New American Motors dealer for details today—and become part of a legend.

Price: 24,995eb.

About the Drifter: The Drifter is a large recreational vehicle with a twelve foot clearance. It holds three people comfortably. The beds are bunks, one atop the other, and the couch is long enough to sleep on. There is some storage space underneath the beds and the couch.

The kitchen area has a stove with four electric burners. The microwave is smaller than home

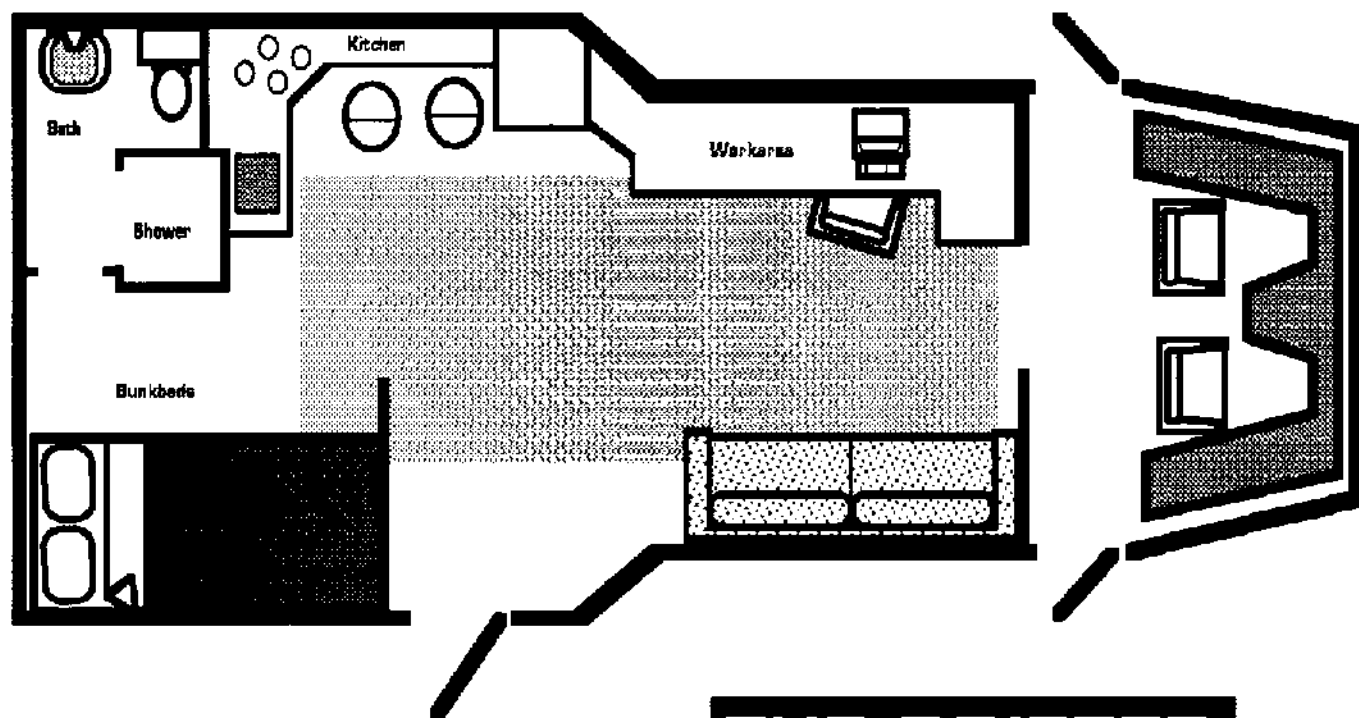

THE DRIFTER

models. The refrigerator holds about a week's worth of food and drink. There is a large water reservoir for two weeks of normal drinking, cooking, and washroom use.

The Drifter's gas tank holds 60 gallons of fuel, and the vehicle will also run on CHOOH_2 . However, the gas mileage drops from 25 to 15kpg when alternate fuels are used.

The auxiliary electric motor's battery has a charge good for about 320km. It takes six hours to recharge off a house outlet, and three hours off a higher output outlet, such as found in factories or special recharge facilities. All of the Drifter's electrical needs come from this battery, and excessive use of the video equipment or cooking range will drain it at a rate of @4km per hour of use.

The visual/audio equipment is a reliable television and stereo system running off a small solar collector mounted on the roof. The collector may be retracted in bad weather.

The Drifter has an SDP of 80, with an SP of 10. All glass has an SP of 10, and the tires have an SDP of 40.

The diagnostics system gives general repair information, such as "the engine needs oil" or "the carburetor needs adjustment". It does not give specific multiple system information, such as "the dirty spark plugs are causing emission problems which have affected the catalytic converter". The modular repair system gives a +1 on all Basic Tech repair rolls. The vehicle holds enough repair modules for ten simple jobs.

People use vehicles like the Drifter for a number of different purposes. Nomads use them to travel, since they are reasonably comfortable and affordable. Others use them as intelligence vans, installing optical and listening equipment for spying and counter-insurgency work. Ripperdocs often use them as mobile black-market cybertech hospitals.

SOFTWARE

DIGITAL DEMONS, DOWNLOADED DREAMS

"Net's gotten more dangerous since when me and Rache Bartmoss did the first pioneering... In those days, you could scream out to the Fringe of Netspace—frack!; way past Pacifica and out into the Orbital Loop without encountering a single ICON. It was wide open then; not even a Netwatch.

No more, choomba. You gotta watch your back every nanosec. You got cowboys zippin outa Fortresses the size of the the frackin' Death Star, loaded for the hunt with Soullkillers, Mindbenders—you name it."

—Spider Murphy





Wolf
Class: Disguised Anti-IC
Strength: 4 MU: 8
1500 eb.

This program is a *Killer IV* disguised as a *Watchdog* program. If triggered, the netrunner gets a Difficult ID roll (use *System Knowledge* and *Programming* skills, plus half your *Interface* ability) to detect its hidden ability. If the 'runner fails the roll, he is fooled by the program, and the *Wolf* gets a +1 to its initiative and attack rolls. *Speedtrap* will not detect *Wolf*, but *Smarteye* will. If you have *SeeYa* or *Hidden Virtue* running at the time of the encounter, they will ID the program as disguised, but not tell you its true nature.

ICON: To all appearances, it is identical to the *Watchdog* icon, except that it will flash entirely red as it attacks.



Guard-Dog
Class: Detection/Alarm
Strength: 4 MU: 5
720 eb.

A modified version of the original *Bloodhound* program, *Guard-Dog* was designed with *Invisibility* sub-coding. *Guard-Dog* alerts its owners if anybody is using a workstation or other in-system entrypoint, and indicates which station is active (it cannot be fooled by *Invisibility*). *Guard-Dog* does not watch the LDL inputs to a system, and can be eliminated by the standard *Killer* software, if the netrunner detects it.

ICON: *Guard-Dog* is invisible except for a flicker at the periphery of vision. If detected, *Guard-Dog* appears as a standard *Bloodhound*.



Bulldog
Class: Detection/Alarm
Strength: 6 MU: 6
660 eb.

A software upgrade of the *Watchdog* alarm, *Bulldog* (aka, *Watchdog v.1f*) was designed with higher-powered probe systems than its forerunner. Like the normal *Watchdog*, *Bulldog* alerts its owners to illegal entries in the system. This program can be fooled with *Invisibility* or *Replicator*, and can be eliminated with *Killer*.

ICON: A short, burly humanoid in metal armor. Sharpened

screws protrude from the plating, and a glowing visor is situated above snarling, canine jaws.



Smarteye
Class: Detection/Alarm
Strength: 3 MU: 4
620 eb.

Smarteye is a more precise (but weaker) form of *Speedtrap*. Unlike its predecessor, which only warns of programs within a certain radius, *Smarteye* will allow you to take a closer look. This program functions exactly like *Speedtrap*, but when an offensive program is detected, the 'runner may choose to identify exactly what the program is. If he does so, and the program is self-mobile or is monitored by another netrunner, it gets a detection roll ('Punk 2020, pg. 143) to recognize that it is being probed.

ICON: A spinning crystal ball; when a program is ID'd, the ball stops and the appropriate icon appears within.

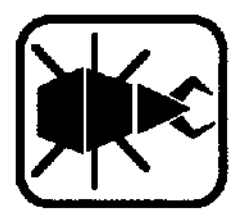

Termite
Class: Intrusion
Strength: 1 MU: 2
160 eb.

One of the earliest and most enduring programs, *Termite* is a favorite of really green weefle-runners because of its simplicity and low cost. Although not a very powerful program, it is quiet and easy to find. *Termite* only works on data walls.

ICON: A brown, fist-sized insect of fractal construction with bright blue eyes. It emits low-pitched bleeps as it burrows into the wall.

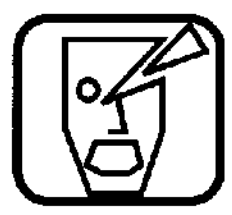

Psychodrome
Class: Anti-personnel
Strength: 4(5) MU: 11
14,000 eb.

This program employs a radical new approach to electronic counter-intrusion. *Psychodrome* does not attack the netrunner's body, but rather his mind: via its *Bloodhound* subroutine, it uses a direct sensory feed (like that of *braindance*) to fill the netrunner's mind with scenes/sounds of shock

and horror. If successful, the immediate effect is unconsciousness for 1D6 hours, plus a lasting side-effect. When a 'runner has been hit by *Psychodrome*, he must make an Average COOL roll once per day, or he cannot face returning to the net. When the netrunner makes the roll, he has overcome his trauma (until the next time he encounters the *Psychodrome*). The program is usually disguised as a code gate, memory unit, or other innocuous system location (sysop's choice). If keyed to the psych traits of a specific netrunner, its strength is 5 instead of 4.

ICON: If the attack is successful, the program places the netrunner in a virtual room of faceted, mirrored walls from which the sights and sounds of torture, death, and madness are projected at odd speeds and angles in rapid succession.



Vampyre II

Class: *Demon/Anti-IC*
Strength: 6 **MU:** 7
2300ob.

Vampyre is an extremely powerful variant on the *Demon* series of compiler programs, credited to the notorious Waycon Kidd. Very expensive and rare, *Vampyre* dismantles any target program it attacks, adding the "victim's" abilities to itself. The only type of programs *Vampyre* cannot absorb are other *Demons* and programs involving virtual realities (such as *Psychodrome*).

When *Vampyre* attacks a program, it rewrites the program into itself as one-time code, so that every program "eaten" by a *Vampyre* (up to a total of 6) can then be used by that *Vampyre* once, and then it is erased. This constant re-writing of code lines and activation of subroutines does put a strain on the program's logic systems, however: every time you activate one of the absorbed programs you must roll a D10 greater than the current number of programs stored. Failure means that the *Vampyre* has "crashed," purging all its stored programs, and rendering it useless until the 'runner leaves the net, removes the *Vampyre* from his deck, and reinstalls it.

ICON: A cadaverous figure in grey robes, with golden orbs for eyes, and a snarling mouth baring golden fangs. When it attacks, it transforms into a misty grey cloud, shot through with sparkling red lights. This cloud then covers and dissolves the other program's icon.



Bunnies

Class: *Anti-IC, Vampyre-specific*
Strength: 4 **MU:** 3
440ob.

Bunnies is a program designed by Wilson Wake, an enterprising 'runner who wanted to kill a *Vampyre* but didn't want to spring for *Assassin* software. When activated, *Bunnies* simply replicates itself, offering the *Vampyre* dozens of tasty subroutines to absorb. Since a *Vampyre* can only absorb 6 programs before automatically crashing, this program is very effective, if very specialized. The strength of the program represents the potential for initiating it before the *Vampyre* absorbs some other program.

ICON: A rapidly-multiplying bunch of burnished gunmetal colored bubbles. Each bubble has a set of the classic "rabbit ears" antennae identifying its front end.



Fatal Attractor

Class: *Anti-personnel*
Strength: 7 **MU:** 7
10,750ob.

A particularly nasty version of *Hellhound* credited to the infamous Waycon Kidd. Legend has it, the Kidd ended up as the loser in a romantic triangle, and used this duplicate of his ex-girlfriend to eliminate his netrunning rival.

The *Fatal Attractor* operates much like a *Hellhound*; it lurks around Data Fortresses waiting to pounce on intruders. However, instead of immediately attacking, it appears as a very attractive female netrunner who offers to help the intruder break into the system. The *Fatal Attractor* will cheerfully accompany the 'runner for 1D6+1 turns, then attack as a *Hellhound*.

ICON: An attractive young woman in a skintight bodysuit. Legend has it that the ICON is derived from the Waycon Kidd's old girlfriend; a System Knowledge check at DIFFICULT will be required for the target netrunner to recognize her—The Kidd installed a subroutine into the program that changes its hair, eye and skin color randomly; the *Attractor* can only be recognized by her face.

Prices

Electronics & Miscellaneous Equipment

Advanced Communications Suitcase	8000eb/800eb options
Alarm Removal Kit	290eb
Auto Punchout.....	330eb
Bar-in-a-Briefcase	100eb
Complete Travel Kit	150eb
Cab Hailer	150eb+10eb/month
Canned Shower	3eb
Car faxx	500eb
Cybermodem Helmet	4100eb
Cybermodem Utility Suit	6300eb/7800eb
Cyberdeck Security System	400eb/1000eb
Cybercam EX-1	1200eb
Detcord Explosive	900/pack
Digital Recording Studio	12,000eb
Digital Weapon Uplink	500eb
Fireproof Clothing	varies by garment
Flavored Cigarettes	2eb/15eb
Fluid Diving Suit	6000eb+100eb/extras
Flip Switch	135eb
Image Wallet	100eb
ID Badge Maker	500eb
IR Cloak	400eb
Line Tap Detector	60eb
Linozap	350eb
Mapmaker	500eb/400eb extras
Mini Printer.....	125eb
Newsviewer	100eb + rental fees
Netrunner Life Support Equipment	500eb
Office Communication Suite	1000eb/1100eb options
Paper Shredder	500eb
Personal Body Alarm	400eb+300eb/month
DUD Smartgun Controller	720eb
Replica Armor	3500eb/10,600eb
Solar Electric Panel	100eb
Sonar Scanner	50eb
Sleep Inducer	85eb
Slosh Bag	65eb
Smartlock Security System	250eb/level
Smartsticks	800eb
Speedholsters	100eb
Temperfoam Furniture	80eb-140eb/piccc

Vehicles

Arasaka Riot VIII	250,000eb
AV-9	1.3million eb
Bensen Cascade	58,000eb
Bell Spy-Eye 18	206,000eb
BMW 9018s	100,000eb
Harley-D. Thundergod	5040eb+950eb/extras
Hundai Worker Bee	5000eb
Kundalini Roadworks Shiva	8000eb
Mitsubishi Dragon	2.5million eb
NAA Ambunaught	76,000eb
Pedicab	1200eb
Punknaught	???

Cyberware

I=implant, B=bioware, BW=body weapon, O=cyberoptics, A=cyberaudio, L=cyberlimb, CW=cyberlimb weapon, N=neuralware

Anti-Plague(B)	1750eb
Cyberliver(I)	450eb/850eb
Cyberhand(L)	750eb+100eb/options
Cutting Torch(L)	100eb
Decentralized Heart(I)	1300eb
Dodgeball(O)	440eb
Digits(L)	25eb-150eb
Derringer(L)	220eb
E-Monitor(I)	185eb
Frequency Changer(A)	100eb
Forked Tongue(I)	350
Flashbulb(CW)	250eb
Gyro-Stabilizer(I)	1000eb
Gang Jazzler(BW)	600eb
Gas Jet(CW)	275eb
Icer(L)	200eb
Lifesaver(B)	4500eb+1000eb/extras
Limb Link(L)	100eb
Magnetic Feet/Hands(L)	60eb/pair
Mace Hand(L)	300eb
Mag-Duct Spots(N)	220eb
OptiShields(I)	300eb
Pacesetter Heart(I)	900eb
Pacesetter 2000 Heart(I)	985eb
Rebreathers(I)	700eb
Skate Foot(L)	440eb
Tazer Grip(CW)	180eb
Tear Gas Sprayer(O)	200eb
Times Square Plus(O)	500eb
Voice Pattern(I)	350eb
Video Cam/Transmitter(O)	330eb
Video Imager(O)	350eb
Wel Drive(I)	320eb+175eb/extras
Whip(CW)	475eb/single arm
Watch-Man(L)	180eb
Wearman Mk. II(I)	200eb

Weapons

APEX Mobile Point Defense System	10,000eb
Beretta M-24	950eb/1250eb
Bio-Askari Motion Restraints	60eb+25eb/extras
Budgetarms Laser-Niner	675eb
Colt Alpha-Omega	500eb
Darra-Polytechnic M-9	300eb
DCR Rifle Grenades	50eb/100eb
EMP Grenade	200-400?
FEN Dz 22 Saucer	65eb
FEN Dz 25 "Det Card"	120eb
Federated Arms Light Assault 15	400eb/700eb
Federated Arms Super Chief	375eb
Gremyenko GPz-78	40eb
Goncz-Tarus Pistol	300eb-400eb/dealer
Glock 30	705eb
H & K G6	2050eb
Kendachi Dragon	660eb

Kendachi Mono-Two	650-700eb
Kendachi M-33 Powersword	860eb
Malorian Arms Hvy. Flechette Pistol	595eb
Malorian Arms Sub-Flechette Gun	795eb
Malorian Arms Sliver Gun	375eb
Malorian Arms 3516	4525eb/special order
Militech Mini-Gat	695eb
Militech Crusher SSG	450eb
Militech M/P Shotgun	300eb
Militech 10	455eb
Militech M-31a1 AICW	1695eb
Militech Mini GL	255eb/475eb
Pursuit Security Stundart Pistol	109eb
Rostovic Wrist Racate	380eb
Setsuko-Arasaka PMS	950eb/1150eb
Stein & Wasserman Model F	650eb
Techtronica Black-Zap	90eb

Fashion

Bodyline Tatoos from Image	
Fashionware	50-120eb
Exec line from Takanaka	75-2000eb
Gibson Battlegear	10-150eb
Leather Series from ICON America	60-500eb
Psiberstuff Fashion Cyberwear	7000eb
Streetware from Eji of Japan	50-500eb
Wearman Series from Nu-Tek	100-300eb
Uniforms from Uniware	15-300eb

Executive Services

Allfood Inc.	25eb/month+10eb/extras
Baskin Undercover Inc.	200eb/hour-150eb/extras
Bodycure.	450eb/visit
Clean Sweep Enterprises	7000eb/year
Continental	150eb-200eb/person
ExecUclean	15eb-100eb/garment
Executive Transportation Service	150eb-850eb/hour
Habit	5000eb/course
International Companion Network ...	75eb/hr.-10,000eb/mon.
Party Time Inc.	500eb/day-3000eb/month
PetMinders	50eb-5000eb/month
SyCust	25eb-5000eb/job
United Express	25eb-650eb/package
Williams Management CS Contract	10-15% rent/month

Chipware

<small>A=APTR chip, M=MRAM chip</small>	
Adrenaline/Endorphin Surge(A)	800eb
Ambidexterity(A)	800eb+250eb/option
Business Trip Chip(M)	800eb
Courier Chip(M)	600eb
DeathTrance(A)	1000eb
Digi-Tone ID(M)	70eb
"Fish N' Chips"(M)	85eb
Increased Neural Feedback	standard price+400eb
Maximum Lover Chip	1300eb
Memory Compression	standard price-200eb-400eb
Mind Games(M)	40eb
M.O. Chip(M)	1200eb
PhotoMemory RAM(M)	1600eb

Poser Impersonation(M)	900eb-1100eb
Programmable Chipware	50eb+1000eb/extras
Redundancy Loop(A)	50-75% off standard prices
Security Chips	standard price+50eb-75eb
Space Chip(M)	900eb
Special Operative Chip(M)	900eb
Stress Reducer(A)	350eb
Tourism(M)	750eb
Visual Recognition Chipware(M)—Techie	100eb/level
V.R.C.—Corporate	50eb-150eb
V.R.C.—Military	100eb/level
V.R.C.—Police	200eb/level+10,000eb/extras
V.R.C.—Rocker	100eb/level
V.R.C.—Secretarial	100eb/level

Housing

Arasaka Sleep Facilities	40eb/night+10eb-1000eb/options
Harris & Company Masterpiece Penthouse	800,000eb+options
Security Services Corporate Flat	2500eb/mon.+extras
Silverhand Studios	600eb/month
The Drifter RV	24,995eb

Software

Bulldog(Detect/Alarm)	660eb
Bunnies(Anti-IC)	440eb
Fatal Attractor	10,750eb
Guard-Dog(Detect/Alarm)	720eb
Psychodrome(Anti-Personnel)	14,000eb
Smarteye(Detect/Alarm)	620eb
Termite(Intrusion)	160eb
Vampyre(Demon/Anti-IC)	2300eb
Wolf(Anti-IC)	1500eb

Index

Electronics & Miscellaneous Equipment

Advanced Communications Suitcase.....	4
Alarm Removal Kit.....	14
Auto Punchouts.....	8
Bar-in-a-Briefcase.....	16
Cab Hailer.....	5
Canned Shower.....	16
Carfaxx.....	8
Complete Travel Kit.....	16
Cybermodem Helmet.....	6
Cybermodem Utility Suit.....	7
Cyberdeck Security System.....	9
Cybercam EX-1.....	13
Detcord Explosive.....	13
Digital Recording Studio.....	12
Digital Weapon Uplink.....	12
Fireproof Clothing.....	13
Flavored Cigarettes.....	16
Fluid Diving Suit.....	15
Flip Switch.....	9
ID Badge Maker.....	13
Image Wallet.....	10
IR Cloak.....	15
Line Tap Detector.....	4
Linozap.....	4
Mapmaker.....	9
Mini Printer.....	8
Newsviewer.....	10
Netrunner Life Support Equipment.....	6
Office Communication Suite.....	5
Paper Shredder.....	8
Personal Body Alarm.....	14
DUD Smartgun Controller.....	12
Replica Armor.....	16
Sleep Inducer.....	11
Slosh Bag.....	16
Smartlocks.....	8
Smartsticks.....	11
Solar Electric Panel.....	16
Sonar Scanner.....	8
Speed Holsters.....	13
Temperfoam Furniture.....	11

Vehicles

Arasaka Riot VIII.....	24
AV-9.....	28
Bensen Cascade.....	18
Bell Spy-Eye 18.....	26
BMW 901Bs.....	19
Harley-D. Thundergod.....	20
Hundai Worker Bee.....	25
Kundalini Roadworks Shiva.....	21
Mitsubishi Dragon.....	27
NAA Ambunaught.....	23
Pedicab.....	22
Punknaught.....	29

Cyberware

I=implant, B=bioware, BW=bodyweapon, O=cyberoptics, A=cyberaudio, L=cyberlimb, CW=cyberlimb weapon, N=neurotware

Anti-Plague(B).....	39
Cutting Torch(L).....	36
Cyberliver(I).....	37
Cyberhand(L).....	31
Decentralized Heart(I).....	37
Derringer(L).....	36
Digits(L).....	32
Dodgeball(O).....	39
E-Monitor(I).....	38
Flashbulb(CW).....	35
Forked Tongue(I).....	35
Frequency Changer(A).....	39
Gang Jazzer(BW).....	40
Gas Jet(CW).....	34
Gyro-Stabilizer(I).....	38
Icer(L).....	36
Lifesaver(B).....	39
Limb Link(L).....	34
Magnetic Feet/Hands(L).....	34
Mace Hand(L).....	36
Mag-Duct Spots(N).....	38
Optishields(I).....	31
Pacesetter Heart(I).....	37
Pacesetter 2000 Heart(I).....	37
Rebreathers(I).....	36
Skate Foot(L).....	33
Tazer Grip(CW).....	38
Tear Gas Sprayer(O).....	39
Times Square Plus(O).....	38
Video Cam/Transmitter(O).....	39
Video Imager(O).....	39
Voice Pattern(I).....	35
Watch-Man(L).....	33
Wearman Mk. II(I).....	38
Wet Drive(I).....	35
Whip(CW).....	34

Weapons

APEX Mobile Point Defense System.....	53
Beretta M-24.....	46
Bio-Askari Motion Restraints.....	48
Budgetarms Laser-Niner.....	42
Colt Alpha-Omega.....	43
Darra-Polytechnic M-9.....	50
DCR Rifle Grenades.....	47
EMP Grenade.....	47
FEN Dz 22 Saucer.....	47
FEN Dz 25 "Det Card".....	47
Federated Arms Super Chief.....	52
Federated Arms Light Assault 15.....	54
Glock 30.....	43
Goncz-Tarus Pistol.....	44
Gremyenko GPz-78.....	40
H & K C6.....	51
Kendachi Dragon.....	48

Kendachi Mono-Two	55
Kendachi M-33 Powersword	55
Malorian Arms Hvy. Flechette Pistol	45
Malorian Arms Sub-Flechette Gun	795
Malorian Arms Sliver Gun	42
Malorian Arms 3516	52
Militech Mini-Gat	50
Militech Crusher SSG	42
Militech M/P Shotgun	48
Militech 10	51
Militech M-31a1 AICW	45
Militech Micro GL	46
Pursuit Security Stundart Pistol	49
Rostovic Wrist Racate	49
Setsuko-Arasaka PMS	44
Stein & Wasserman Model F	54
Techtronica Black-Zap	49

Fashion

Bodyline Tatoos from Image	
Fashionware	60
Exec line from Takanaka	63
Gibson Battlegear	62
Leather Series from ICON America	61
Psiberstuff Fashion Cyberwear	57
Streetware from Eji of Japan	64
Uniforms from Uniware	59
Wearman Series from Nu-Tek	58

Executive Services

Allfood Inc.	70
Baskin Undercover Inc.	69
Bodycure	71
Clean Sweep Enterprises	68
Continental	67
ExecUclean	68
Executive Transportation Service	70
Habit	71
International Companion Network	70
Party Time Inc.	67
PetMinders	69
SyCust	71
United Express	66
Williams Management CS Contract	66

Chipware

<small>A=APTR chip, M=MRAM chip</small>	
Adrenaline/Endorphin Surge(A)	75
Ambidexterity(A)	75
Business Trip Chip(M)	74
Courier Chip(M)	73
DeathTrance(A)	75
Digi-Tone ID(M)	73
"Fish N' Chips"(M)	75
Increased Neural Feedback	75
Maximum Lover Chip	74
Memory Compression	74
Mind Games(M)	74
M.O. Chip(M)	73

PhotoMemory RAM(M)	74
Poser Impersonation(M)	73
Programmable Chipware	74
Redundancy Loop(A)	75
Security Chips	73
Space Chip(M)	74
Special Operative Chip(M)	73
Stress Reducer(A)	75
Tourism(M)	74
Visual Recognition Chipware(M)—Techie	76
V.R.C.—Corporate	76
V.R.C.—Military	76
V.R.C.—Police	76
V.R.C.—Rocker	76
V.R.C.—Secretarial	76

Housing

Arasaka Sleep Facilities	78
Harris & Company Apex Penthouse	83
Security Services Corporate Flat	80
Silverhand Studios	86
The Drifter RV	88

Software

Bulldog (Detect/Alarm)	91
Bunnies (Anti-IC)	92
Fatal Attractor	92
Guard-Dog (Detect/Alarm)	91
Psychodrome (Anti-Personnel)	91
Smarteye (Detect/Alarm)	91
Termite (Intrusion)	91
Vampyre (Demon/Anti-IC)	92
Wolf (Anti-IC)	91

CHROME

SOME PEOPLE GO FOR THE **GOLD**. BUT THAT'S NOT WHY YOU'RE HERE.

YOU CAME FOR THE **CHROME**.

CHROME. THE STYLE IN "STYLE OVER SUBSTANCE." WHEN YOU'RE TRULY CYBERPUNK, YOU KNOW THAT IT'S NOT JUST WHAT YOU CAN DO, BUT THE WAY YOU DO IT THAT COUNTS. AND WHEN YOU HAVE THE RIGHT ACCOUTREMENTS, YOU CAN MAKE YOUR LIFE A STATEMENT. ALL YOU NEED IS A GUIDE TO THE CYBER GOOD LIFE; A BLACK MARKET SCREAMSHEET CATALOG DOWNLOADED INTO WHAT WE IN 2020 CALL A CHROMEBOOK.

CHROMEBOOK. OVER 180 THINGS TO MAKE YOU EVEN MORE CYBERPUNK. WEAPONS, ARMOR, FASHION, VEHICLES, LIFESTYLE, CHIPWEAR, CYBERWEAR—EVEN PLACES TO LIVE. IT'S A STYLEGUIDE TO BEING HIP AND CYBER; A SLICE OF THE EDGE THAT MAKES YOU MORE THAN JUST ANOTHER METAL MAN.

AND IT'S JUST THE PLACE TO SPEND YOUR HARD-EARNED EURO AFTER A TOUGH NIGHT ON THE STREET.

CHROMEBOOK. THE ESSENCE OF CYBERPUNK.

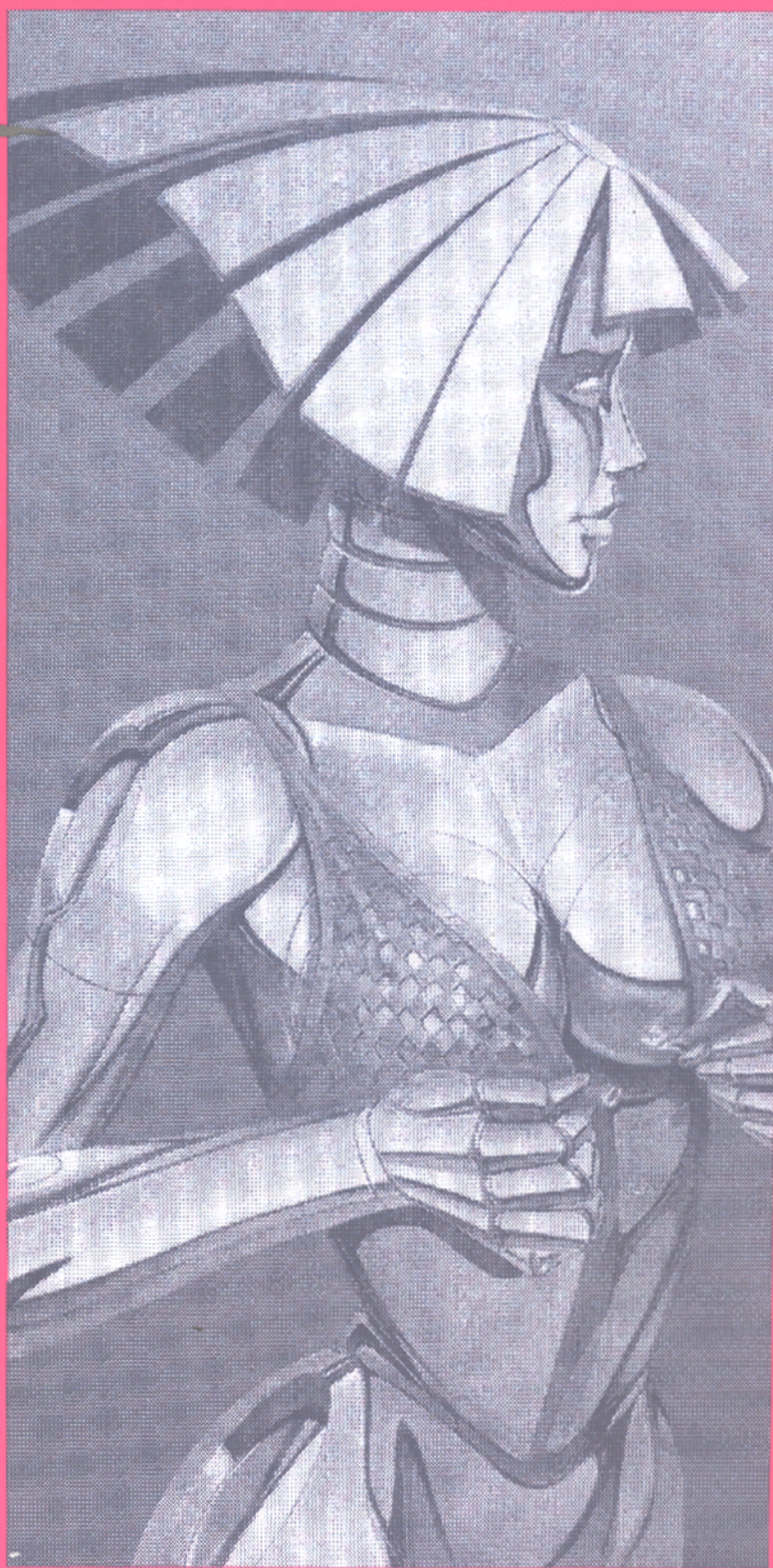

A SUPPLEMENT FOR

CYBERPUNK[®]

**R.TALSORIAN
GAMES, INC.**

PUBLISHED BY R. TALSORIAN GAMES
P.O. BOX 7356, BERKELEY, CA. 94707
COPYRIGHT © 1991 BY R. TALSORIAN GAMES, INC. CYBERPUNK[®] &
CHROMEBOOK[™] ARE TRADEMARKS OF R. TALSORIAN GAMES, INC. ALL RIGHTS
RESERVED.

**ISBN #0-937-279-17-X
CP 3701**