

a **CAR WARS**® supplement

2038
Catalog
Update



2038
Catalog
Update

UNCLE ALBERT'S®

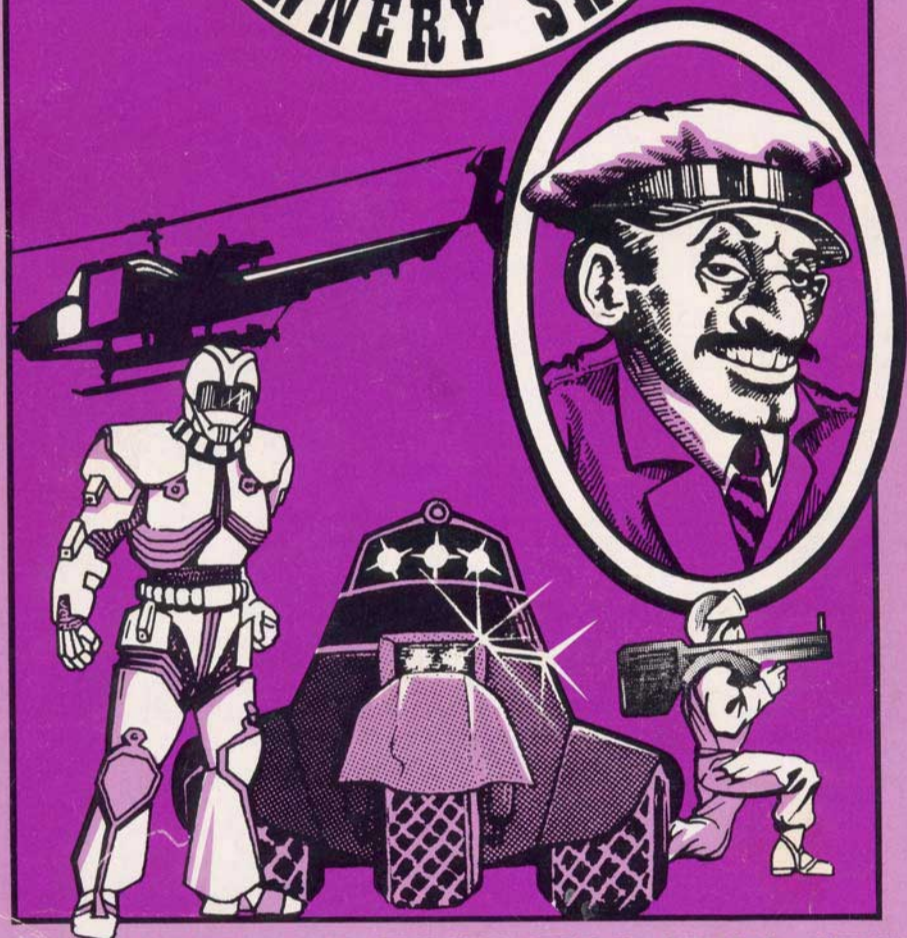

STEVE JACKSON GAMES

2038
Catalog
Update

2038
Catalog
Update

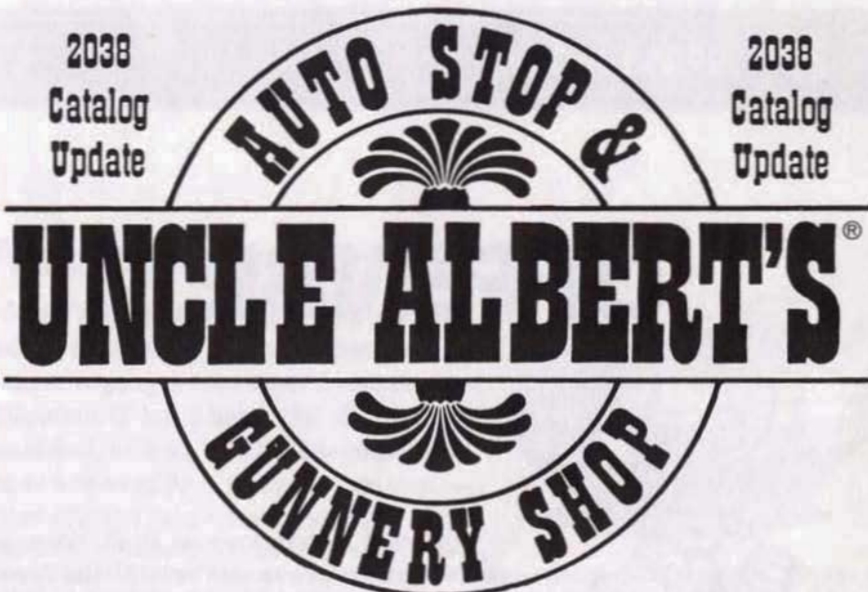

CREDITS

By Stephen Beeman and Martha Ladyman

Illustrated by Guy Burchak

Typography and Page Design by Melinda Spray

Production by M. E. Roome

Most of the *Car Wars* weapons and gadgets are new or are revised from their original appearances. The rest have appeared in *Autoduel Quarterly* magazine (Vol. 4/3 through 6/2), *Combat Showcase* and the *Uncle Albert's 2038 Calendar*. The rules herein are official and replace previous rules.

DESIGN CREDITS

Chris Allen (Portable Field Radio), Aaron Allston (Vehicular Computer), Stephen Beeman (everything else), Andrew Buttery and Mark Limburg (Hand-Held Flare Launcher, RL Flare Rounds), Mark Cook (Junk Dropper), Robert Critelli (Fire-Retardant Insulators, Rotor Armor), Jim Davie (Deadman Switch and Damage Sensor), Andy Egan (Weapon Concealment), Shawn Evans (Mini-Mechanic), John Ford (Gyroslugger, X-Ray Laser), Lonnie Foster (Spike Gun), Sam Hatcher (Impact Rifle), Scott Harring (Man-Portable Rocket Launcher, MediKit, Sloped Armor, Surface-to-Air Missile, Metal Tires), Randy Harrington (Mini Rocket Platform), Max Hutchinson (Riot Shield), Timothy Jaques (Blended Body Armor), Robert Jellinghaus (High-Temperature Ammo), Robert Kelk (Light Flamethrower), David Ladyman (Smart Link), Gareth Lowe (Zero-Space Turret), Norman McMullen (Assault Rifle), Scott Miller (Long-Range Radar), Ray Morriss (Improved Tail Assemblies, Retractable Landing Gear), Alan Raisanen (Extra Rotor Blades), Tim Ray (Flaming Oil Ammo, Ice Ammo, HESH Warheads), River City ADA (Semi-Trailer Emergency Plate), Jeff Roberts (Bazooka, Stinger), Norman Ruge (Windjammer), Ronnie Ruggiero (Tripod Gunshield), Paul A. Schreiber (Spider Mines), Ken Scott (Tow Bar), Craig Sheeley (Helicopter Maneuver Foils), Nicholas Spratt (Steelbelted Tires), Kent Suarez (Cycle Windshell, Tinted Goggles).

Car Wars, *Autoduel*, *AADA* and *Uncle Albert's* are registered trademarks of Steve Jackson Games Incorporated. *Uncle Albert's 2038 Catalog Update* is copyright © 1988 by Steve Jackson Games Incorporated. All rights reserved. Printed in the United States.

1 2 3 4 5 6 7 8 9 10

ISBN 1-55634-082-6



OFFENSE



You're in a showdown at High Noon, and you've got to prove you're still the fastest, meanest son-of-a-gun in town. Let Uncle Al help you drive the bad guys out into the sunset. You need guns? Uncle Al has guns . . . and rockets . . . and cannons . . . and lasers . . . and a whole pas-sel of other firepower, both hot-off-the-shelf and oldies-but-goodies, that a man would be proud to strap to his hip (or car). Let the other guy have a gang behind him; all you need is Uncle Al, the Duellist's Pal. Don't be on the losing side of a shoot-out — order today!



Dual Weapon Magazine

Uncle Al's crack researchers never rest! Now, just in time for the fall duelling season, Uncle Al is proud to present the two-fisted punch of the Dual Weapon Magazine. Now you can make doubly sure when you shoot them down that they *stay* down. Fully tested and guaranteed.

Dual Weapon Magazine — \$150, 50 lbs., 1 space, plus cost and weight of ammo. Must be attached to two identical linked weapons in the same facing. Like a normal magazine, this item holds the same number of shots as its weapon. However, this ammo is used by two weapons rather than one. If one weapon of the pair fires a shot from this magazine, the other must fire from the magazine as well. The DWM adds no DP to either weapon and is destroyed the instant one of its weapons is destroyed. This item may be combined with normal magazines and magazine switches, but rocket magazines are not available in a dual-weapon version.

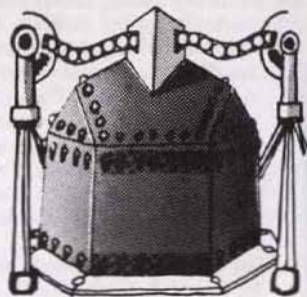

Variable-Fire Rocket Pod

Never know just how much firepower you need to take along? Tired of packing too much, or running out too soon? Avoid the embarrassment of being one rocket short in that crucial duel, with the VFRP. Now you can fire one, two or even three rockets at one time — so time efficient, and economical too!

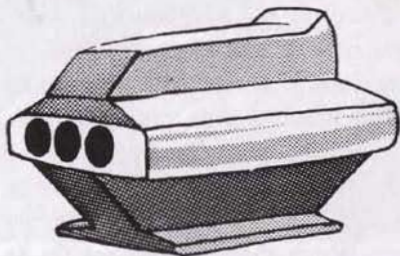

Variable Fire Rocket Pod (VFRP) — To hit 9, 2 dice damage, \$2,000, 200 lbs., 3 spaces, 5 DP (each point of damage destroys 3 active rockets), 15 shots, CPS 70, WPS 15. Loaded cost \$3,050, loaded weight 425 lbs. Loaded magazine costs \$1,100 and weighs 240 lbs. The VFRP can fire one, two or three rockets in one firing action. Roll separately to hit with each rocket, declaring the number fired before rolling for any.



Order one of the fine weapons on this page — either the sleek and efficient Variable-Fire Rocket Pod or the hard-hitting Blast Cannon — and receive a **free gift*** — this attractive and distinctive *longhorn hood ornament*! This tasteful item is the perfect complement to the high-tech look of these powerful weapons. Act now — don't delay! Supplies are limited!

* Free gift sent upon payment, or to pre-approved credit customers only.

Blast Cannon

Blast those turkeys into the next county with Uncle Al's own special Blast Cannon! This baby will make those other guy's guns look like water pistols! The sight of its sleek nose sticking out will add a touch of class to your fine automobile. Never forget, the race is not to the swift, but to the man with the biggest gun!

Blast Cannon (BC) — To hit 7, 4 dice damage, \$4,500, 500 lbs., 4 spaces, 5 DP, 10 shots, CPS 100, WPS 10. Loaded cost \$5,500, loaded weight 600 lbs. Loaded magazine costs \$1,050 and weighs 115 lbs. Burst effect (2" radius).



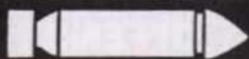

Spike Gun

IMPROVED!

Spice up your autoduelling! For those tired of the old method of dropping spikes, Uncle Al's own Spike Gun will add a little variety to your life. Now you can put your spikes where *you* want them — either under his car, or, just for grins, right into his tires! Watch those pedestrians fly as you come down the road! A Division 5 favorite!



Spike Gun (SG) — To hit 7, 1 die damage (see below), \$750, 150 lbs., 2 spaces, 2 DP, 10 shots, CPS 40, WPS 10. Loaded cost \$1,150, loaded weight 250 lbs. Loaded magazine cost \$450, loaded weight 115 lbs. Area effect. The spike gun can be fired like an oil gun to hit a specific square, leaving a ½" x ½" square of spikes that acts like a single normal spike counter. The spike gun can also be fired directly at a target (at a -4 penalty), doing 1 die damage to tires and pedestrians only.

The spike gun cannot use explosive-tipped spikes.

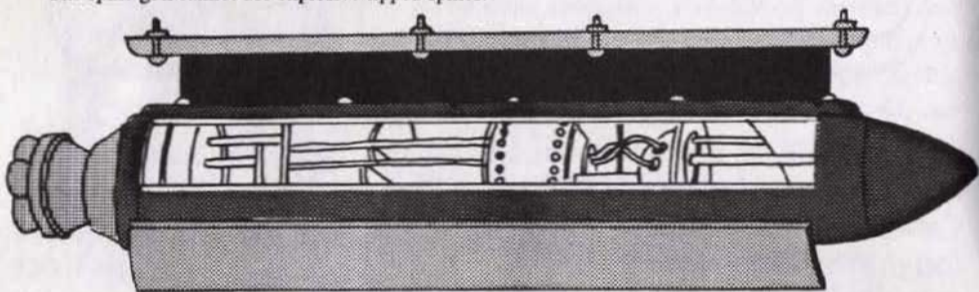

Surface-to-Air Missile

At last! The solution for those pesky helicopters that always seem to come around just at the wrong moment! With the SAM you can watch your worries fly away . . . or rather, crash and burn! Known to be responsible for the destruction of over ten TV news helicopters in the past year!*

** Uncle Albert naturally condemns such practices, and fully supports the activities of his news-gathering friends in the sky!*

Surface-to-Air Missile (SAM) — To hit 6 vs. air targets, 11 vs. ground ones, 4 dice damage, \$500, 150 lbs., 1 space, 3 DP. Single-shot weapon. Burst effect. A SAM may be mounted on rocket platforms and other accessories and may be made armor-piercing.

IMPROVED!

Radar-Guided Missile

Be sure of hitting a bull's eye every time with the amazing Herlitz and Son's Radar-Guided Missile System. Now you can sit back, relax and enjoy the show — this patented system will insure a score with no hassle, fuss or messy calculations! All you have to do is fire — what could be easier?

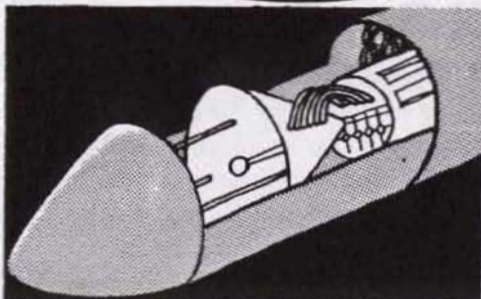

Radar-Guided Missile (RGM) — To hit 7, 3 dice damage, \$4000, 100 lbs., 1 space, 1 DP. Single-shot weapon. Burst effect. The RGM gets no "point blank" bonus, and the normal range penalties do not apply. Instead, there is a -1 penalty for every full 4" the target is closer to the firer than 24." The missile's maximum range is 72." RGMs suffer no penalties for visibility whatsoever; on the other hand, gunner and computer bonuses do not apply. The firer must have line-of-sight to the target at the time of firing; thereafter the missile must maintain LOS to continue tracking the target. The missile moves at 2" per phase and should be represented by a pedestrian counter. Do not roll to hit until the missile reaches the target. If the roll is missed, or if the missile loses line-of-sight to its target, the RGM hits the ground and explodes. This weapon may be placed on rocket platforms, rocket EWP's and in rocket magazines, and may be made armor-piercing.

IMPROVED!

Wire-Guided Missile

Need some help, but just can't afford the bucks for a RGM? Relax, help is on the way with the Herlitz and Sons' WGM! Same high quality, same high performance*, but for just a fraction of the cost. Proof that Uncle Al is *all* the duellists' pal, rich and poor.

* *With some minor exceptions; read fine print, below.*

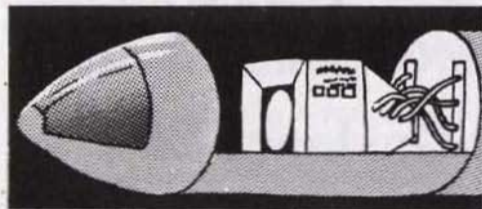

Wire-Guided Missile (WGM) — To hit 6, 3 dice damage, \$2000, 100 lbs., 1 space, 2 DP. Single-shot weapon. Burst effect. The WGM uses the same targeting rules as the RGM. Gunner and computer bonuses do apply, however, as do visibility modifiers. If the firer ever moves or loses line-of-sight to the missile, the WGM hits the ground and explodes. The WGM is in all other ways identical to the RGM.

A Note From Our Staff

Extensive testing has shown that the Targeting Laser (Uncle Albert's 2036 Catalog Update, p. 5) is slightly less accurate than originally advertised. On the other hand, recent improvements in electronics targeting systems have increased the accuracy of our tremendously popular Twin Laser! Uncle Al's crack Research and Development team never sleeps!

Targeting Lasers and Twin Lasers now both hit on a 6.

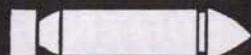

X-Ray Laser

Expensive, but well worth every penny! These top-of-the-line X-ray lasers provide the maximum targeting ability available in today's technology. This is an absolute must for the discriminating autoduellist who demands nothing but the best for his or her fine piece of machinery.

X-Ray Laser (XL) — To hit 6, 4 dice damage, \$15,000, 750 lbs., 3 spaces, 3 DP. Area effect. Drains 4 power units per shot from a laser battery or power plant.

Heavy X-Ray Laser (HXL) — To hit 6, 5 dice damage, \$20,000, 1,500 lbs., 5 spaces, 3 DP. Area effect. Drains 5 power units per shot.

The beam of an X-ray laser is invisible. The target can tell the general direction an attack is coming from, but nothing more specific.

X-ray lasers are not blocked by smoke, though the standard -2 penalty for targeting still applies. They do full damage to laser-reflective or polished armor, but cannot be used to guide rockets.

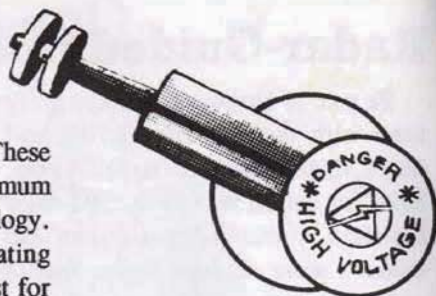

Medium Laser

For the high-tech combatant with the low-tech pocketbook — Hibeam and Resnick

Labs are proud to introduce the Medium Laser, especially made to bridge the gap between light and heavy lasers. Why settle for ordinary guns, when you can have the punch and accuracy of a laser? Don't you owe it to yourself to get the very best?

Medium Laser — To hit 6, 2 dice damage, \$5,500, 350 lbs., 2 spaces, 2 DP. Area effect. Drains 2 power units per shot. Blocked by smoke and paint like other lasers.



IMPROVED!

Laser-Guidance Link

The folks at Resnick Labs never sleep! Not when they have as hot an idea as this one — improving their already immensely popular Laser Guidance Link! You'll be amazed at the speed and accuracy of this Link, and pleased at the low, low price. How can you afford not to have one?

Laser Guidance — \$500 for the electronics and laser tuning, plus \$200 per guided rocket; no weight or space. May be used with any rocket weapon except SAMs, RGMs and WGMs. If used with multiple-shot rocket weapons (MFRs, RLs, MMLs, VFRPs) the \$200 must be paid per rocket. The guiding laser and the rocket must be linked (for \$50) in order for both to fire; this is legal, since only the laser is assumed to be aimed.

When a tuned laser and a modified rocket are linked and fired at the same target, roll to hit with the laser first. If it hits, roll two dice without modifiers for each rocket. On a 4 or better, the rocket automatically hits, but on a 2 or 3 it misses — for whatever reason, the homing sensor lost track of the laser beam. If the laser itself misses, never reaches the target or was not fired, the rockets themselves have no chance of hitting — the guidance modifications make the rockets too inaccurate for unguided fire to be effective.

Light Flamethrower

Those folks at Pioneer Products have done it again! Responding to popular request, they have developed the only light flamethrower with a guaranteed 75-foot range. Don't be caught cold-footed when the heats up; go with the quality and dependability you've come to expect from Pioneer Products. Forging the frontiers of autoduelling!



Light Flamethrower (LFT) — To hit 6, 1d-2 damage, \$350, 250 lbs., 1 space, 1 DP, 10 shots, CPS 15, WPS 3. Area effect. Fire modifier 2, burn duration 3. Loaded cost \$500, loaded weight 280 lbs. Loaded magazine costs \$200 and weighs 45 lbs. Maximum range 5." When fired, this weapon creates a standard smoke cloud just as FTs and HDFTs do.

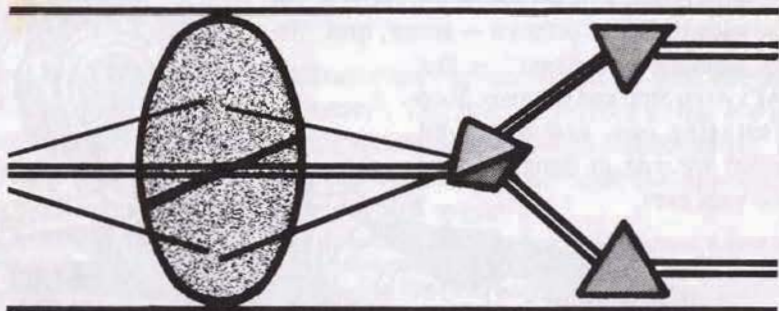

High-Intensity Optics

For the duellist who is short on space but long on needs, this handy little device will amplify the power of your laser, thus enabling you to turn up the juice without adding unwanted weight. A perfect Christmas gift for that hard-to-shop-for laser enthusiast in your household!

High-Intensity Optics — Multiplies the basic cost of any laser except X-ray by 50% but leaves weight unaffected. Adds +1 damage per die — thus, a high-intensity laser does 3d+3 and a high-intensity twin laser does 2d+8.

A high-intensity infrared laser costs 250% of its base price; the damage is halved after rolling and is rounded up.

Tell A Friend! Are your fellow duellists receiving our catalog? Clue them in! We'll thank you — and so will they!



DEFENSE

Blast off for action and savings! But if you find yourself being blasted on all sides, then it's time to fly to Uncle Al for some out-of-this-world armor at a down-to-earth price! Yes, no one in the universe can claim the wide variety of defenses — armor, tires, dischargers, insulators and more!!! — that Uncle Al's Auto Stop and Gunnery Shop can! Featuring new and improved models that are sure to bring the stars back into your eyes.

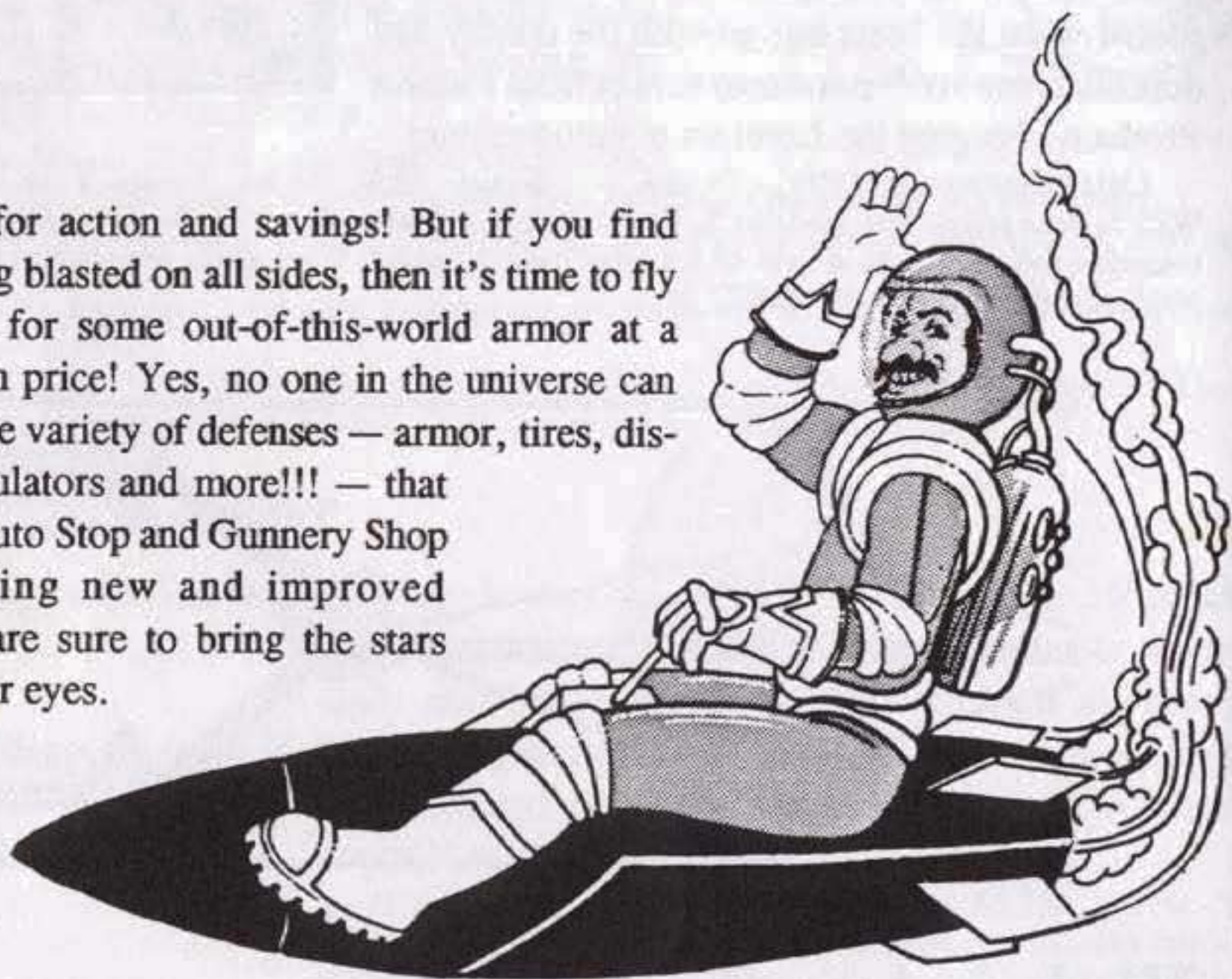

Junk Dropper

IMPROVED!

On a tight budget? Need an effective weapon with easy-to-get charges? Buy Uncle Al's 'Sow's Ear' Junk Dropper — you'll be amazed with the results you can get with just a few well placed piles of debris. And so economical — you can always restock around any arena! These droppers are going fast, so act now to avoid disappointment!

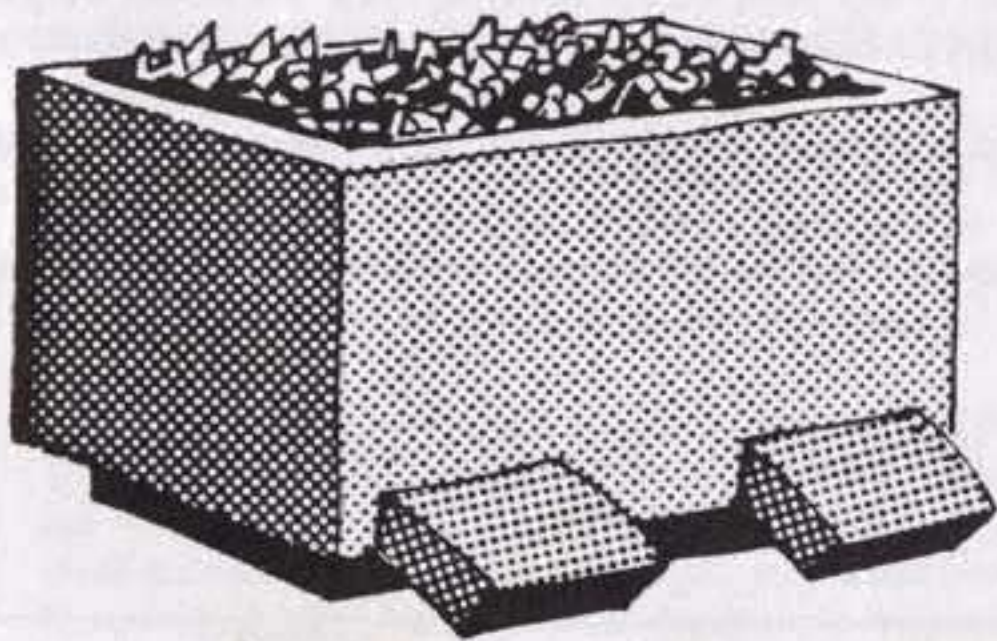

Junk Dropper (JD) — Dropped weapon. \$50, 25 lbs., 1 space, 4 DP, 10 shots, CPS 0, WPS 10. Loaded cost \$50, loaded weight 125 lbs. Loaded magazine cost \$50, loaded weight 115 lbs. When this weapon is fired, it drops two randomly selected debris counters in one ½" x ½" square, located as for a spike- or minedropper.



Trailer Hitch Armor

Tired of some joker's lucky potshot separating you from your trailer? Well, suffer no more! Uncle Al insures you'll keep intact with his new SafeTeePro Trailer Hitch Armor. Completely protect your property — the SafeTeePro way!

Trailer Hitch Armor — \$15 and 4 lbs. per point, 10 points (40 lbs.) max. This armor completely protects both the hitch and the attached trailer's tongue. However, the towing vehicle may not perform any maneuver more difficult than D3. Furthermore, anytime the trailer jackknifes, the armor is automatically and completely destroyed, regardless of whether the hitch actually breaks. This armor counts against the load of the towing vehicle and must match its, not the trailer's, armor type.

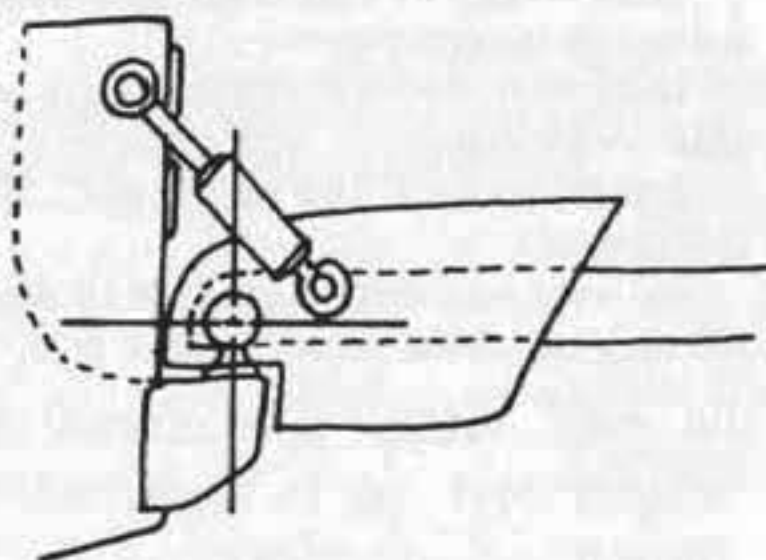

Sloped Armor

It's time to get rid of that old-fashioned clunky armor, and get the sleek new look for cars — Uncle Albert's own Sloped Armor! Yes, you *can* be both stylish and secure. This sturdy protection comes in a wide variety of colors — passionate purple, blood-red, midnight black, paralyzing pink and our ever-popular royal-bashing-blue. (Specialized colors available upon request; add 10% to cost.)

Sloped Armor — This modification can be made to any vehicle with any type of armor. It must be made to the entire vehicle — you cannot have sloped armor in one location and non-sloped armor in another. Sloping armor does not add weight, but increases the cost by 10%. This cost is based on all armor (including ram plates), but not on accessories such as wheelguards, spoilers and the like.

Sloping a vehicle's armor reduces the space available for internal components. A vehicle with sloped armor loses 10% of its total spaces, rounded up; treat cargo spaces separately and deduct 10% from there, too. For example, a sedan (16 spaces) would lose 2 spaces; a van (24+6 spaces) would lose 3 regular spaces and 1 cargo space; a 40' van trailer (80 spaces) would lose 8 spaces.

A vehicle with sloped armor is -1 to be hit, in addition to all other targeting modifiers. If a side with breached (or nonexistent) armor is targeted, the penalty does not apply. Sloping protects turrets but does not protect tires, EWPs, rocket platforms and other exposed components; shots targeting these areas do not suffer the -1 penalty.





IMPROVED!

Rotor Armor

A copter is a valuable machine; don't let it crash due to *your* negligence! Get it the best — Realyrite Rotor Armor from Aerodrome Industries. Guaranteed the best chopper armor in the industry! *Now available in fireproof and reflective versions!!!* That's why they say, Fly Safe With Aerodrome!

Rotor Armor — This armor effectively increases rotor DP. The cost and weight are different for main and stabilizing rotors:

Main rotor: Twice the cost, half the weight of a single point of the helicopter's regular armor. Triple the usual cost to repair.

Stabilizing rotor: One and a half (1.5) times the cost, half the weight of regular armor. Double the usual cost to repair.

No rotor may carry more than 10 points of armor. This armor is available in all varieties except metal, and must match the copter's armor type.

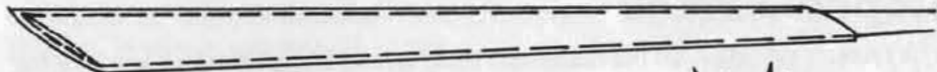

Laser-Reactive Web

Searching for the best in a Laser Reactive Web? Your most knowledgeable and reliable source is your own Uncle Al, whose already good Web has been made even better! Now get the drop on any snipers — let your return fire teach them a lesson they'll never forget! Lifetime limited warranty — for the life of you or your car! Speedy service, too — drive in this morning; drive out this afternoon!

Laser-Reactive Web — \$100 each, no space or weight. Each web is affixed to a single armor location (front, back, etc.) or other external item (wheelguard, EWP, etc.). The web senses any laser fire which scores a direct hit on that side; when fire is detected, the web sends a firing action to any items linked to it, including computer gunners. Any direct-fire weapons activated cannot be aimed. The return fire is resolved before any laser-guided rockets arrive, but after damage from the laser itself is applied. Each web location is destroyed along with the armor it covers.

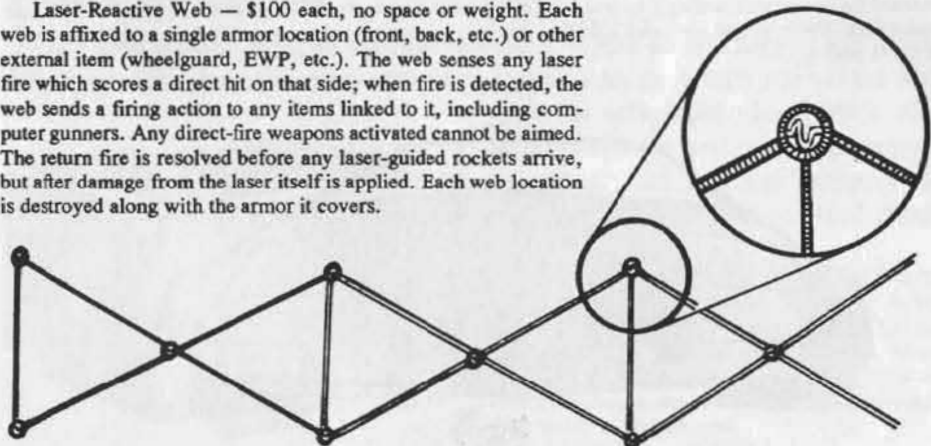

Dischargers

Now you can have the low, low price of a discharger, while enjoying the wide variety of options never seen before! *You* choose the weapon, be it grenades, gas, oil, ice or whatever, drop it in and let it rip! What convenience! What style! And, best of all, it's backed by the famous Uncle Al's guarantee!

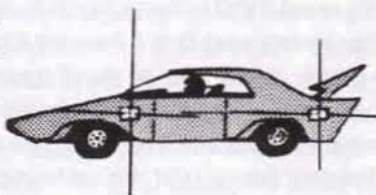

Dischargers are one-shot weapons attached to the outside of a vehicle. They all weigh 5 lbs. each but take up no space. Only one discharger of any type may be mounted for every 7½ feet of vehicle facing. For example, a car may mount one discharger in front, one in back, two right, two left, two top and two underbody. These dischargers may be mixed in any way. Each dropped-weapon discharger creates a standard cloud (or slick) exactly as if it were a regular dropped weapon. Dropped-weapon dischargers may affect the firing vehicle unless they are side- or back-mounted.

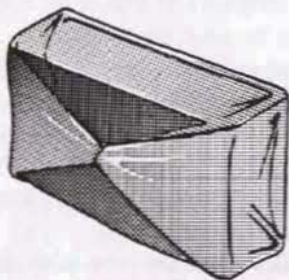

Whenever an armor location carrying a discharger is hit, roll one die. On a 1, one discharger on that side is destroyed. If an armor location takes ram damage for any reason (collisions or rolls, for instance), all dischargers in that location are automatically destroyed.

Flechette Grenade (FD) — \$50. Does 1 die of damage to pedestrians and exposed cyclists within 2". No damage to tires or vehicular components.

Point Defense Grenade (PDG) — \$100. Does 1 die of damage in a 1" burst radius, doing half damage to tires and vehicular components. The firing vehicle's armor is included in the burst, though its tires are not (unless the grenade was mounted on the underbody).

Smoke Discharger (SkD) — \$50.

Tear Gas (TGD) — \$75.

Paint Discharger (PD) — \$40. Available in glow-in-the-dark version (\$160).

Oil (OD) — \$50.

Flaming Oil (FOD) — \$100.

Flame Cloud (FCD) — \$150. See the rules for flame clouds on p. 13.

Ice (IcD) — \$75.

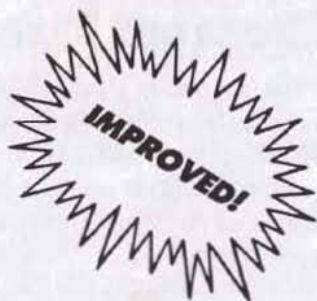



IMPROVED!

Metal Tires

The tire legends tread on! Announcing the new and improved SafeTeePro metal tires. No longer need you fear having your tires blown out from underneath you — these babies can go the distance, and more! The rubber exterior cleverly disguises their true nature, while insuring that it performs just the way you like it. Tougher than solids! An exclusive, only from Uncle Al!

Metal Tires — \$1,000, 150 lbs., 25 DP. No effect initially on vehicle's HC. After 4 points of damage are taken to any one tire, however, the vehicle's HC drops permanently by 1. Metal tires are fireproof. Their DP is exactly like normal DP; the rules for metal armor are totally separate and do not apply to this item. These are not available in Off-Road or steelbelted versions.

Metal Cycle Tires — \$1,000, 75 lbs., 25 DP. Usable only on trikes, dragsters and mini van trailers.

Metal Truck Tires — \$3,000, 300 lbs., 35 DP.

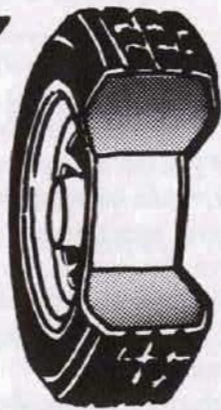

Steelbelted Tires

You can't afford to be out on the road with just plain rubber! Buy Uncle Al's special steelbelted tires and keep on rollin' with style and safety! Please specify size when ordering.

CATALOG SPECIAL: Mention you saw this item in the catalogue, and receive *whitewalls* at no additional cost!

Steelbelted Tires — Increases the cost and weight of any tire (except metal tires) by 50%, but adds 33% (round down) to the tire's DP.



Fireproof Tires

The next time you face down a flamethrower you'll be glad you had the foresight to buy Uncle Al's famous Fireproof tires, the ones tested in the heart of a volcano!!! (Test results available upon request.) Guaranteed not to melt or burn! Please specify size when ordering.

Fireproof Tires — Twice the cost of any tire, no extra weight. If a *non*-fireproof tire takes a hit from an incendiary weapon, the entire vehicle takes the standard burn modifier (or, under the basic fire rules, has a chance to catch on fire), regardless of whether the vehicle itself has fireproof armor.

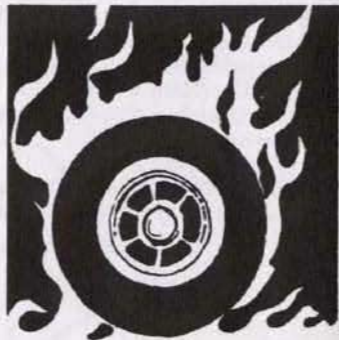

Flame Clouds

One of the sizzling red-hot deals of this year is Uncle Al's flame cloud ejectors and streamers. So useful in so many ways, a mere flick of a switch will clear your path of unwanted ice, snow, water, underbrush, small animals and pedestrians. Flame clouds will brighten up any rainy-day duelling, and are sure to be a hit with nighttime driving!

Flame clouds look like regular paint clouds and block fire in the same way. However, they will not stick (no lasting penalty for driving through the cloud). A cloud ignites after 2 phases; they burn for 2 turns, leaving behind a standard smoke cloud.

All flame clouds, no matter what their size or source, do (1-1) damage to every exposed vehicular component and armor location. Wheelguards take damage before wheel hubs, which take damage before tires; fifth-wheel guards take damage before fifth wheels; trailer hitch armor takes damage before trailer hitches and tongues. Components behind a breached armor location are not exposed (apply a single 1-1 damage as if it were a weapon hit), but components behind a nonexistent armor location (side of a cycle, top of a roofless car) are exposed.

Driving from open air into a flame cloud is a D2 hazard. Flame clouds do not set fires under the basic fire rules; they have a fire modifier of 3 and a burn duration of 1 under the variant fire rules (this modifier is only applied once, no matter how many items took damage).

Note that these rules represent an official change from the original rules for the flame cloud ejector (*Uncle Albert's 2036 Catalog Update*, p. 9).

Heavy-Duty Flame Cloud Ejector (HDFCE) — \$1,000, 100 lbs., 3 spaces, 2 DP, 10 shots, CPS 240, WPS 20. Loaded weapon costs \$3,400 and weighs 300 lbs. Loaded magazine costs \$2,450 and weighs 215 lbs. Creates a 2" x 1" flame cloud when fired.

Flame Cloud Gas Streamer (FCGS) — \$200, 100 lbs., 2 spaces, 1 DP, 2 shots, CPS 300, WPS 25. Loaded cost \$800, loaded weight 150 lbs. Loaded magazine costs \$650 and weighs 65 lbs. Creates a ½" x 5" flame cloud straight out from the firing vehicle.

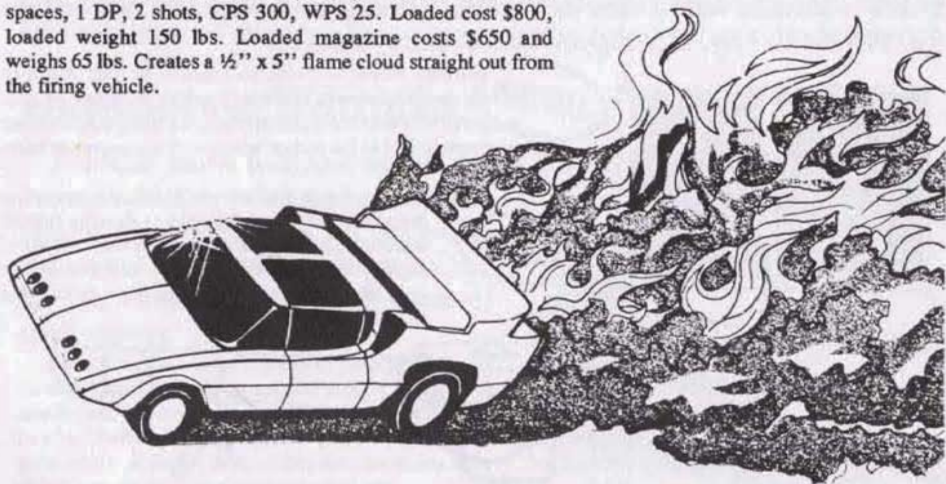



IMPROVED!

Fire-Retardant Insulators

Improved — and priced to move! These Fire Retardant Insulators are made to protect a single component from fire damage during all those annoying little vehicular fires you find yourself in. Don't have that valuable weapon blow up in your face; protect it the Uncle Al way!

Fire-Retardant Insulators — \$150 and 25 lbs. per space of component protected, takes up one space. Only internal vehicular components may be protected with this item. Crew members may not be protected, as they would suffocate. Likewise, internal combustion engines cannot be insulated, though gas tanks may be.

Components with fire-retardant insulators take no damage from vehicular fires, and only half damage from flame weapons. Volatile weapons so protected cannot cause a vehicle to catch on fire or explode. The insulators provide no DP protection and cannot be combined with component armor.

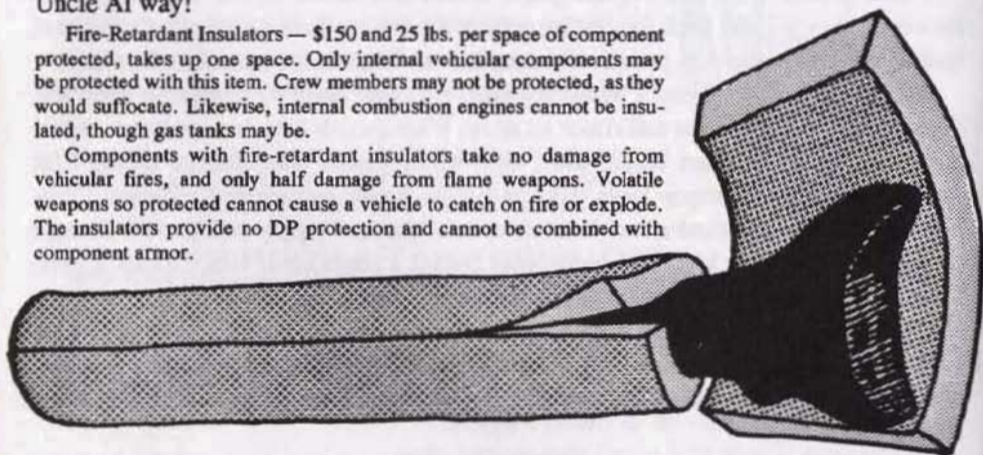

Deadman Switch and Damage Sensor

New from Resnick Labs: the Final Strike Series! The Little Nikita Damage Sensor automatically fires when its component takes damage. The Danyankee Deadman Switch is activated when a crew member dies, sending swift vengeance back to your foe. You can die easy, knowing you will be suitably avenged!

Damage Sensor — \$100, no space or weight. Attached to any one component (except for crew members or passengers), this item automatically sends a firing action to any weapons linked to the sensor whenever its component takes damage.

Deadman Switch — \$100, no space or weight. Essentially identical to a damage sensor, but this item is attached to a single crew member. Sends a firing action when the crewman dies or goes unconscious (not when he takes damage but remains active).

NEW!

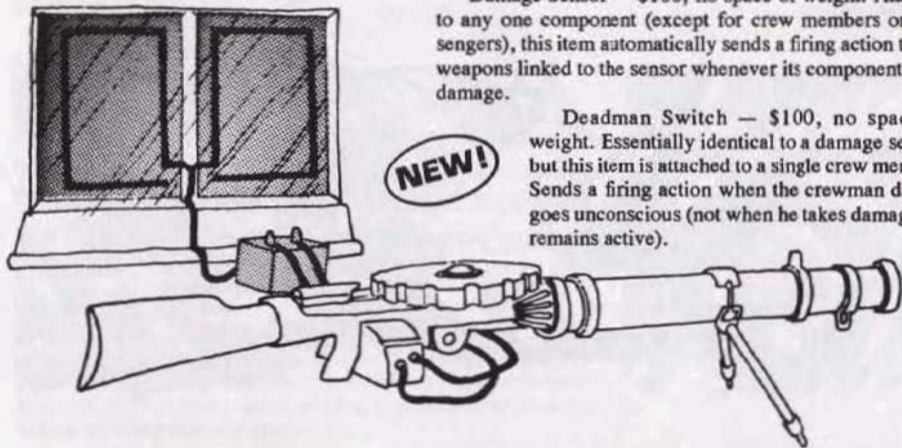

MUNITIONS



King of the Road, that's what it's all about, and Uncle Al helps you keep the magic of days gone by with the technology of today, with these up-to-the-minute munitions, both old favorites as well as new and improved models. Mystical heroes of old — King Arthur, Alexander the Great, Attila the Hun — went into battle confident of their support. And you too will be supported by these top-of-the-line munitions. Go forth with head held high and mind free from worry — you've put your trust in Uncle Albert.

Explosive Rounds **NEW!**

Just what you've been looking for! Ammo that can go for several targets at once! Poppun brand explosive ammunition will provide you with hours of fun and excitement as you pepper your way through a battle. Not recommended in tight spaces or small arenas.

Explosive Rounds — Loaded in MGs and VMGs: Double CPS and WPS of regular ammo. Damage is unaffected, but the weapon gains a half-die burst effect in a ½" radius. If the weapon is fired at multiple targets, apply a single burst effect for the entire area rather than several overlapping explosions.

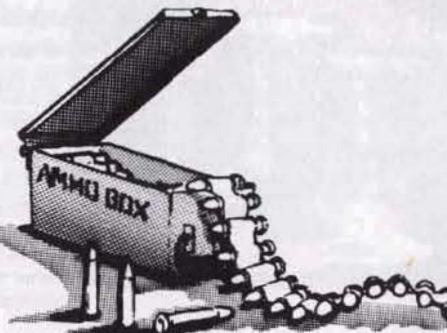



APFSDS Warheads

When you're ready to get serious, you're ready for the Atlas Armor-Piercing Fin-Stabilized Discarding Sabot Warhead. These babies will smash anything short of a tank that gets in your way. Go out, not with a whimper, but with a bang — the Atlas bang!

Armor-Piercing Fin-Stabilized Discarding Sabot (APFSDS) Warheads — Loaded in RRs and ATGs: CPS 2x, WPS 1.5x normal. Does +2 damage per die — thus, 2d+4 for the RR or 3d+6 for the AT gun. No burst effect. May be mixed with normal ammo.

HESH Warheads

The Titan High-Explosive Squash Head Warhead does just what it says — you can squash your foes like you squash a fly! Thrill to the power and force of the Titan, as you show the world you are a duellist who means business!

High-Explosive Squash-Head (HESH) Warheads — Loaded in RRs, ATGs, BCs and TGs: CPS 1.5x normal, weight same. Damage is the same. However, HESH removes a point of metal armor for every 4, 5 or 6 rolled, rather than just on a 5 or 6.

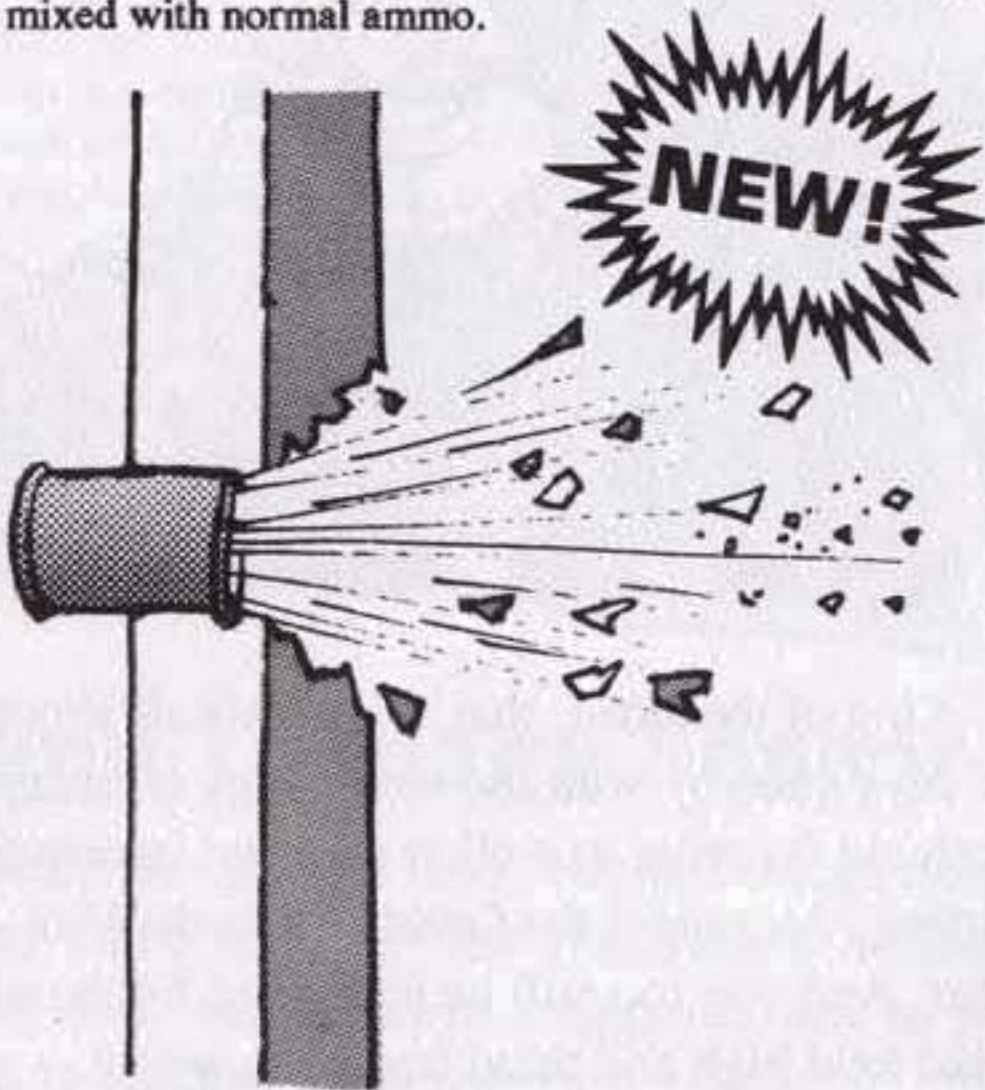

Glow-in-the-Dark Paint

Keep on duellin' all night long, with Uncle Al's special Glowworm Glow-In-The-Dark paint! Provides hours of fighting pleasure after the lights go out. Available in pulsating purple, bordello red, extra-terrestrial green, and introducing outrageously orange and agonizing yellow!

Glow-in-the-Dark Paint — Loaded in any paint-using weapon: CPS 4x normal, WPS same. When targeting a vehicle that has been covered in glow-in-the-dark paint, nighttime penalties are reduced to only -1; if combined with LIGs or any other nighttime vision enhancers, the darkness penalty is fully eliminated. May not be mixed with normal ammo.



High-Temperature Ammo

To get that little extra “oomph!” out of your flamethrower or flaming oil jet, Uncle Albert wholeheartedly recommends Pioneer Products “DragonBreath,” the choice ammo of duelling champions! Burning 58% hotter than regular flamethrower ammo, DragonBreath will slice through your opponent’s armor like fire through ice! Pioneer Products — defining the frontier of autoduelling!

High-Temperature Ammo — Loaded in any flamethrower or flaming oil jet: CPS 4x normal, WPS 1.5x normal. Does +2 points of damage per die — thus, a FOJ with HT ammo does a full die and an FT does 1d6+2. The fire modifier is increased by 1, while the burn duration is reduced to 1. May not be mixed with regular ammo.



RL Flare Rounds

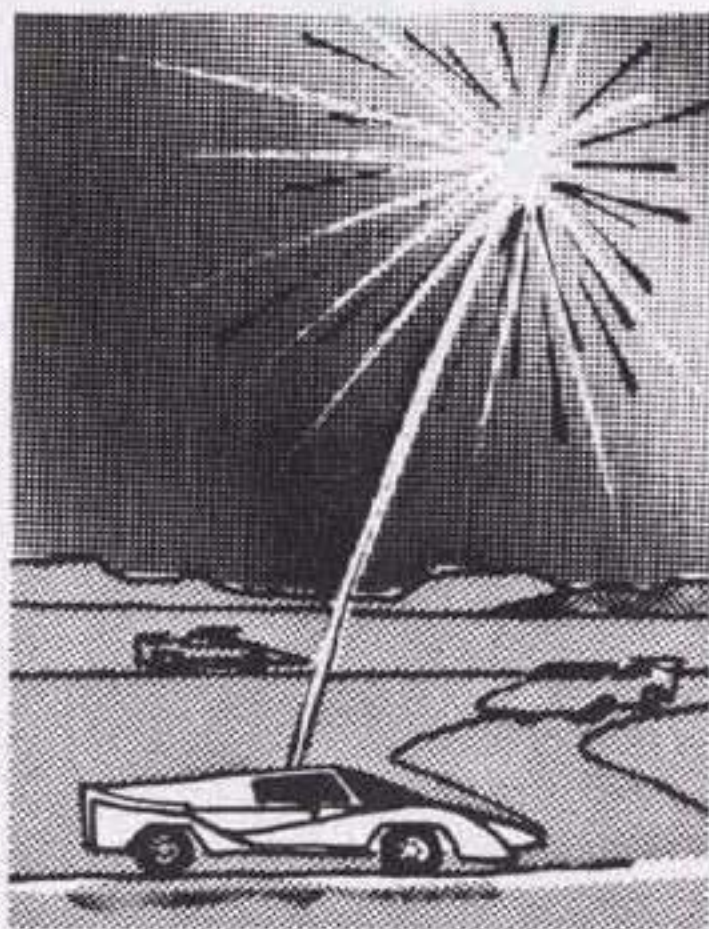

Genesis Armaments is lighting up the world with their wide selection of RL Flare rounds. Safe, dependable, effective, these versatile flares can be used both for illumination and as a weapon! You’ll be amazed at how handy they are; you’ll wonder how you managed without them! Available in a wide variety of decorator colors — specify color, or let us send you the Variety Pack! *Special: order ten, get one free!*

RL Flare Round — Loaded in a regular RL: CPS 20, WPS 5. May be fired directly at a target: To hit 10, 1d-2 damage, fire modifier 2, burn duration 0. If used for illumination, the round lights a 20” radius area for 5 seconds, reducing the nighttime targeting penalty to -1. The round does not have to be fired straight up; the center of illumination can be placed anywhere within 15” of the firer. May be mixed with regular ammo.



Spider Mines

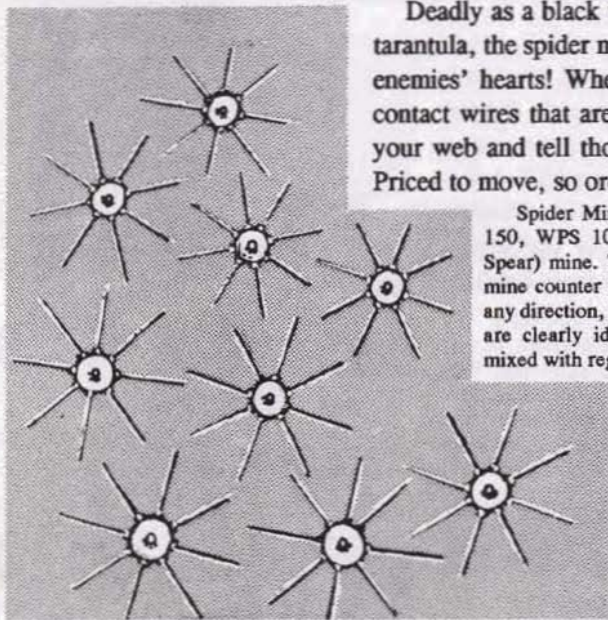

Deadly as a black widow, more menacing than a tarantula, the spider mine will strike terror into your enemies' hearts! When dropped, the mine extends contact wires that are impossible to avoid, so spin your web and tell those pesky tailgaters good-bye! Priced to move, so order today!

Spider Mines — Loaded in a Spear MD: CPS 150, WPS 10. Does damage like a regular (not Spear) mine. The range of detonation for a spider mine counter is enlarged to $\frac{1}{2}$ " — two squares in any direction, instead of the usual one. Spider mines are clearly identifiable from a distance. May be mixed with regular ammo.

Napalm Mines

They may laugh when they run over these harmless looking mines, but they'll be exchanging their guns for angel wings in no time! Our Napalm Mines are low-cost, yet highly effective! *Warning: Uncle Albert takes no responsibility for this highly volatile item. Use at your own risk.*

Napalm Mines — Loaded in a normal MD: CPS 60, WPS 5, 1 die damage to underbody and tires. Loaded in a Spear MD: CPS 150, WPS 10, 1 die damage to tires, 2 dice to underbody. Unless a vehicle has both fireproof armor and tires, it will take a fire modifier of 4 with a burn duration of 3. Napalm mines are volatile like rockets and flamethrowers, and a vehicle carrying them may explode. Furthermore, if napalm mines ever end a phase underneath an ignited flaming oil slick or flame cloud, the mines immediately detonate.



Flaming Oil Ammo

It looks just like an ordinary oil slick, so imagine the look of surprise on your target's face when it bursts into flame! How did you do it? With Uncle Al's own Houdini Flame Oil Ammo! Mystify your friends and foes! Great for practical jokes, too!

Flaming Oil Ammo — Loaded in a regular oil gun: CPS 90, WPS 5. Lays a 1" x 1" oil slick just like the regular oil gun round, but two phases after the slick is produced, it ignites! The flaming slick is treated just like that from an FOJ. If this ammunition is fired directly at a car, it is treated just like a regular oil gun round — the oil is too dispersed to ignite. May be mixed with normal ammo.



Ice Ammo

NEW!

When your foe is in hot pursuit, cool him off with Frosti brand Ice Ammo, available only at Uncle Albert's! A low-cost way to bring in your own little area of winter, even on the warmest of days. So chill out with Frosti!

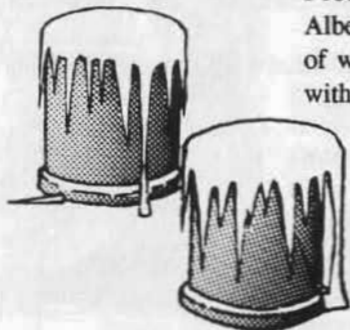

Ice Ammo — Loaded in a regular oil gun: CPS 40, WPS 5. Lays a 1" x 1" patch of ice that acts just like that from an ice dropper. If this ammunition hits a vehicle directly, a ½" x 1" ice patch forms under the vehicle, but there is no additional effect — the water is too thinly spread to form ice on the car itself. May be mixed with normal ammo.



ACCESSORIES



You'll say Uncle Al is plum crazy! You'll say he's gone bananas! You'll say he's one apple short of a bushel! That's because you'll find it hard to believe the peach of a deal you'll find at Uncle Al's when you go shopping for those all-too-important accessories! No lemons here; all items have been exhaustively tested and retested by Uncle Al's crack R&D team! So whether it's computers, radar, superconductors, shock absorbers, or whatever it is you need, go to Uncle Al — it's the only raisinable thing to do!

Streamlining

You've seen the new, sleek, streamlined look on your favorite TV show, *McDade!* You've read about its many advantages in all the popular magazines! Now, just for you, Uncle Albert brings a special, this-catalog-only, on streamlining! So

order NOW, and improve the looks and efficiency of your fine automobile. Please, no oversized vehicles.

Streamlining — Costs 50% of the vehicle's body cost, weighs nothing, reduces interior space by 10% (rounded up) and increases top speed by 10 mph. It also reduces power consumption by 10% (or, for gas-burners, increases MPG by 10%). When reducing the vehicle's spaces, treat cargo and regular spaces separately and deduct 10% from each, rounding up.

Oversized vehicles may not be streamlined. Streamlining has no effect on HC. Cycles may be streamlined, as may cycle windshells.

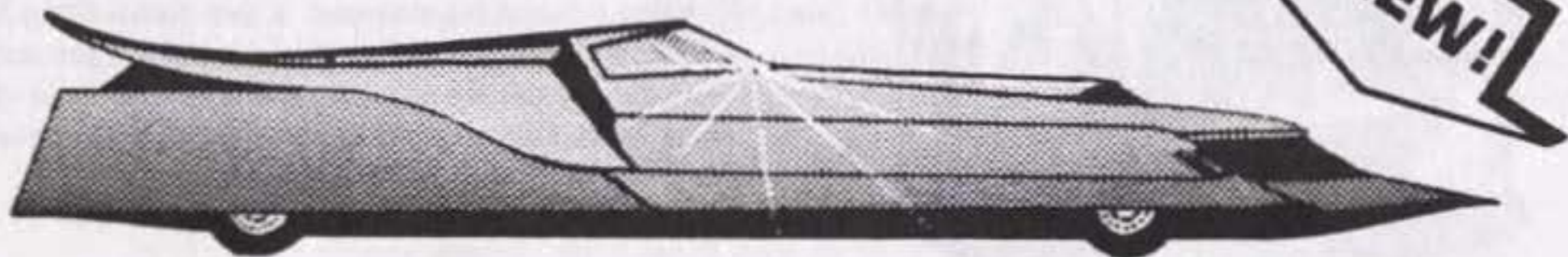

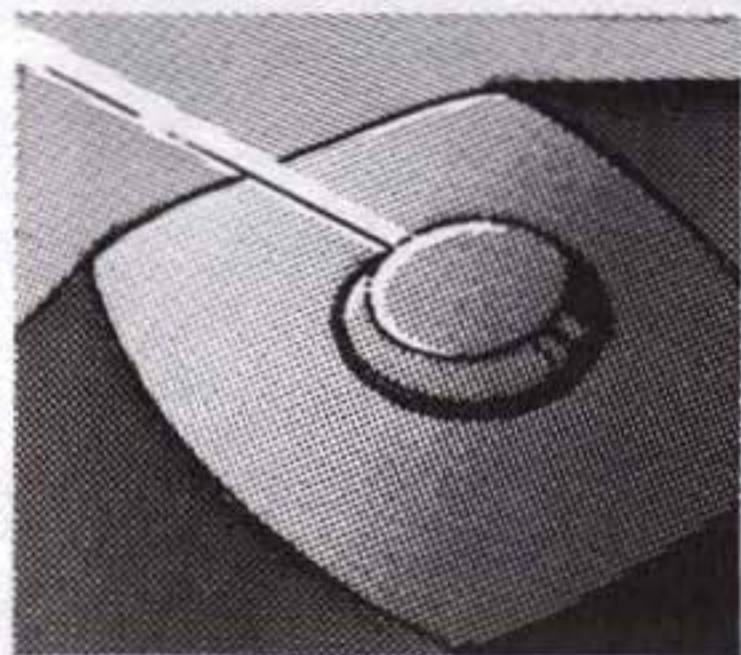

Zero-Space Turret

Just what you laser buffs have demanded! A zero-space turret, exactly perfect for your targeting laser. Convenient, too — can be fitted to any car — including your subcompact! For just a small amount more, you can even have the zero-space, pop-up turret! Just one more way in which Uncle Albert keeps way ahead of the competition!

Zero-Space Turret — \$750, 75 lbs., 1 space. Can hold one targeting laser. May be mounted on any car or sidecar which does not already have a turret.

Zero-Space, Pop-Up Turret — \$1,750, 150 lbs., 1 space.

Mini Rocket Platform

Got the blues because your car can't carry our top-selling rocket platform? Do the kids in the neighborhood snicker as you drive by? Has your girlfriend left you for someone with a little more firepower? Weep no more, my friend! Uncle Al will rocket you to victory with the Mini Platform, a "micro" version of the Regular and Small Platforms. Now you can stand tall in a crowd again!

Mini Rocket Platform — \$75, 50 lbs., no space. Can be mounted on subcompact cars and light trikes, as well as larger vehicles. The mini platform holds one space of rockets on top of a vehicle, but can only carry 1/2 or 1/3 space rockets due to structural limitations.

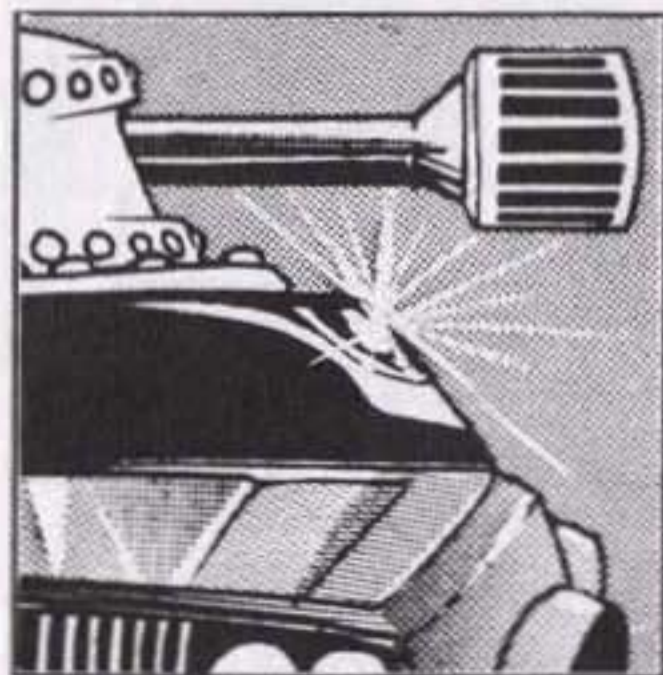
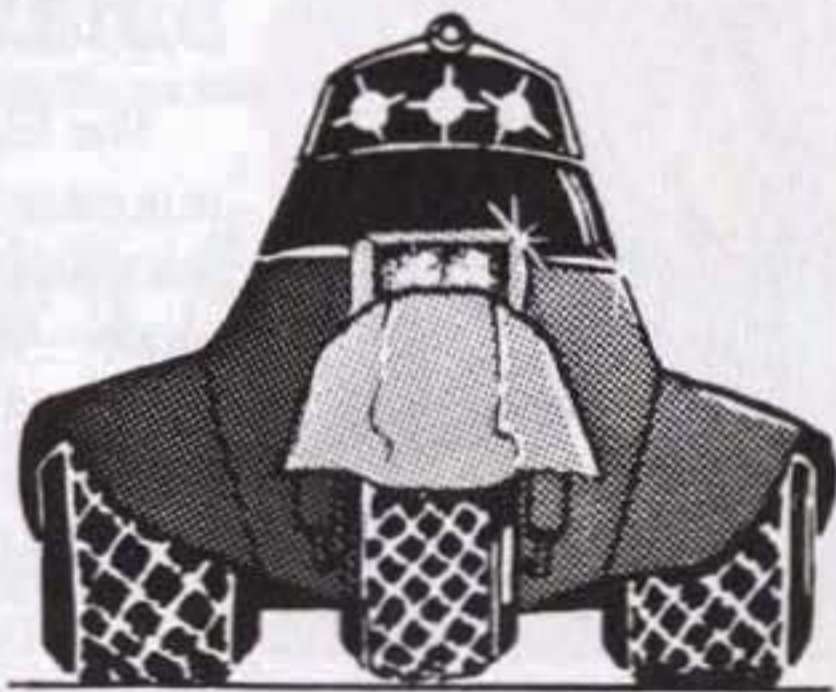

A fake turret may be mounted as camouflage for a real turret or rocket platform, blowing away via explosive bolts when the real weapon fires.

Fake Turret

NEW!

So real looking, even Uncle Al can't tell the difference! Yes, our Fake Turrets are *guaranteed* to fool even the most experienced of autoduellists — it even rotates! So get a sense of safety at a fraction of the cost! Order now, and we'll throw in a free poster featuring those shoot-'em-up babes you love to watch on TV, Al's Gals! Exclusive; you can't buy it anywhere else!

Fake Turret — \$250, 50 lbs., no space. Looks just like a regular (but empty) turret — it even rotates. The "turret" can carry any number of fake weapons, at \$100 and 20 lbs. each. The turret is instantly destroyed when hit (and the top armor takes no damage).



Hi-Res Single Weapon Computer

It's no surprise that the top three finishers in the 2038 Monaco Grand Prix all used Electrofabrique Suisse's Hi-Res Single Weapon Computer. The power of a full hi-resolution targeting system is cleverly packed into a single low-cost chip. Attaches to any existing system quickly and easily. An exclusive, available only at Uncle Al's, just for you!

Hi-Res Single Weapon Computer (HRSWC) — \$2,500, no space or weight. Like a single weapon computer, the HRSWC aids a single type of weapon in a single location from a single crew position; all this must be specified upon installation. Gives a +2 to hit.

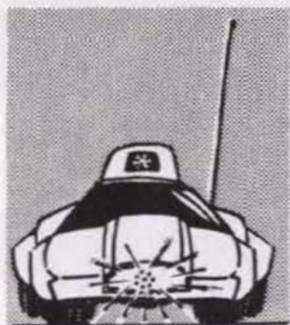

Smart Link

The Electrofabrique Suisse Smart Link uses a Masaki processor to calculate firing angles in microseconds, compensating for mismatched weapons placements. Point and shoot — the Smart Link does the rest! *Note: This device is unable to connect weapons with dissimilar ballistic properties.*

Smart Link — \$500, no weight or space. Acts as a regular link between two or more weapons. In addition, it allows weapons in one location to be aimed and fired together with identical weapons in a different location (say, in a turret). All weapons must be aimed at the same target

— and naturally all must be able to aim at that target. Dissimilar weapons may still not be aimed together. The smart link itself may be linked.

Vehicular Computer

Straight from the lab to your driveway — the newest, most efficient, most advanced auto computer ever assembled! The Holographic Autoduelling Vehicular Computer (HAVOC) can do everything, from targeting to bookkeeping to playing wargames — just plug in the right holographic data storage cube, and go to it! Thousands of different and exciting uses! Order yours today!

Vehicular Computer — \$4,000, no weight or space. Installed in any one crew position, just like a targeting computer. Gives a +1 to hit with all weapons fired from that position. In addition, a wide array of non-combat programs are available, stored on holographic data storage cubes. The details of these are left to the referee, but examples include bookkeeping, data communications, navigation (with computerized maps and atlas information), entertainment and so forth.



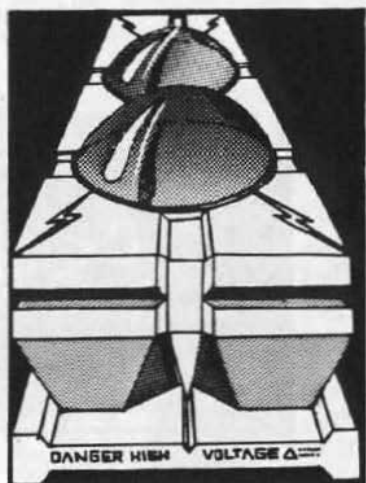

Platinum Catalysts

Pep up that tired old power plant — give it the Platinum Charge! Platinum Catalysts, from Electrofabrique Suisse, are guaranteed to boost the output of any, yes, any hydrogen-oxygen power plant! So go for the power! Go Platinum!

Platinum Catalysts (PlatCats) — Increases cost of any electric power plant by 20%. Increases power factors by 5%. PlatCats must be purchased along with the power plant and cannot be retrofitted. When used on truck power plants, they increase the max load by 5%.

Gift Certificates Available
in all denominations

Superconductors

When you really need the power, think quality, think Electrofabrique Suisse! Their supercons will improve the performance of your car's axle motors in a way that's sure to astound you! Supercons — when you're serious about performance!

Superconductors (Supercons) — Increases cost by 50% and power factors (or max load) by 10%. Supercons cannot be retrofitted. When combined with PlatCats, the set costs 70% of the plant's cost and increases power by 15%.

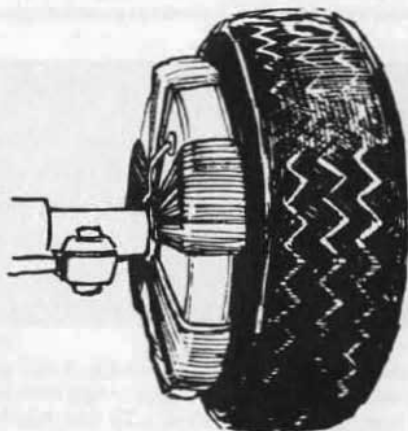



Long-Range Radar

Get the drop on adverse weather and weathering adversaries, with Long-Range Radar. Detects vehicle-sized objects at ranges up to 15 miles! This is the only system certified for use by the Texas Rangers, so accept no substitutes!

Long-Range Radar — \$10,000, 100 lbs., 1 space. Works like regular radar, but with a range of 15 miles. Note that, as with regular radar, hills and other large terrain features block radar line-of-sight, limiting the usefulness of this item on ground vehicles.

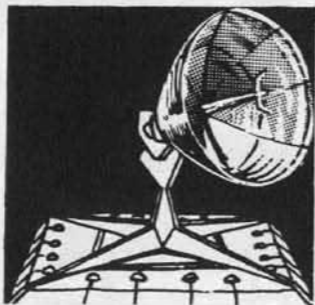

Semi-Trailer Emergency Plate

At last, the perfect solution for those times when you have to drop that trailer in a hurry. Now, when you release, the new semi-trailer Emergency Plate springs down instantly to keep your trailer on an even keel! Hitching back up is the work of a moment. More proof that Uncle Al is the Trucker's Pal. *Warning: Severe accidents may occur when using this item at high speed, and Uncle Al feels anyone foolish enough to do it deserves what he gets!*

Semi-Trailer Emergency Plate — \$1,500, 800 lbs., 2 spaces, 8 DP. May be mounted on any type of semi-trailer. When a trailer equipped with this device is detached from its tractor (for whatever reason), a large skid plate springs down instantly, holding the trailer off the ground. The plate retracts automatically when the tractor's fifth wheel reengages the kingpin (a process which takes one minute).

A detached trailer using this device is automatically at HC -6 while moving, using Crash Table 2 when necessary; it may not maneuver, and decelerates (without hazard) by 30 mph each turn. The plate takes no damage from the skid, but takes damage from obstacles like a truck's solid tire. It may be targeted at -5 when in use; when retracted, it counts as an underbody-mounted weapon.

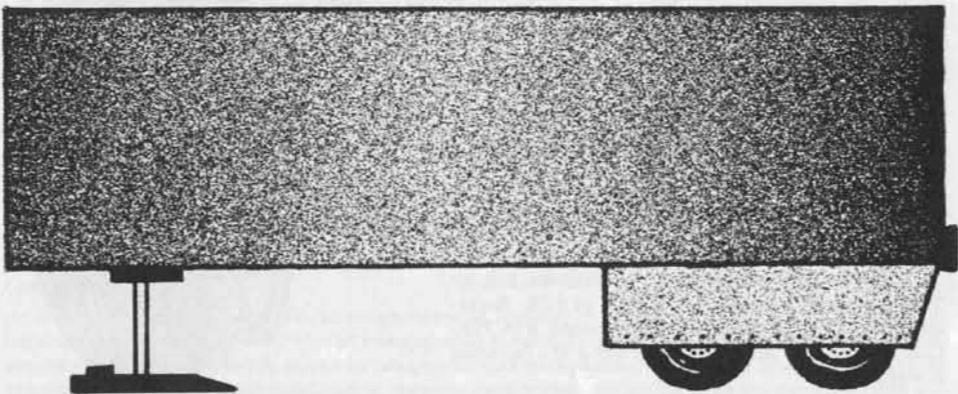

Heavy-Duty Shock Absorbers

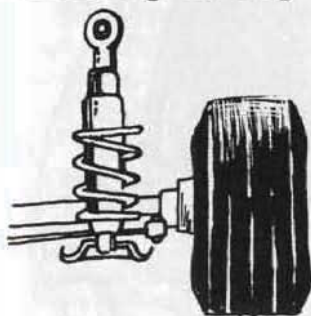

Sail effortlessly through those road hazards, laugh at hilly terrain and debris, scoff at gunfire! You can take it, and more, with Heavy-Duty Shock Absorbers. Made for rough action, at a price that's easy on your wallet! Heavy-Duty Shock Absorbers — for those times when you're doing a man's work!

Heavy-Duty Shock Absorbers — \$400, 5 lbs. per tire, no space. HD shocks must be mounted on all tires of a vehicle to be effective. Reduces all road hazards (obstacles, debris, weapon fire and so forth) by D1; no roll necessary for D0 hazards.

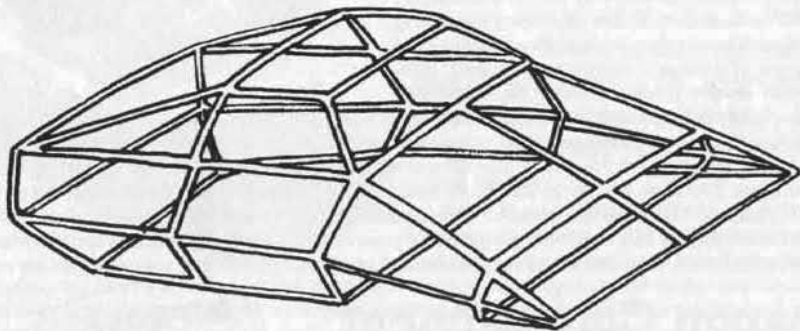

Carbon-Aluminum Frames

NorAm Chemical uses the latest in zero-G manufacturing techniques to produce super-strong, super-light carbon fibers embedded in feather-light but steel-tough foamed aluminum spars. The result — all the load capacity of regular frames with only half the weight! You'll be amazed and your enemies will be dismayed at the armor these bodies can carry! Available in all major vehicle styles. *Warning: Carbon-aluminum frames are unusually vulnerable to collisions. Uncle Albert does not take responsibility for any inconveniences this drawback may cause.*

Carbon-Aluminum Frames — Quadruples the cost of any body type before chassis, suspension and other modifications; halves body weight but does not affect maximum load. The CA frame must be purchased when the vehicle is designed and cannot be retrofitted. A vehicle with a CA frame takes double damage in all rams, rolls and collisions. Racing body styles may not use this item, as they are considered to already have it.

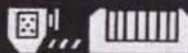

Cycle Windshell

Uncle Al's motto has always been "Safety First." (Well, one of his mottos.) That's why he encourages all cyclists to buy their own Cycle Windshell. Beat that highway turbulence, increase your top speed, and keep bugs out of your teeth, all at the same time! Highway tests have indicated a significant increase in both overall speed and high-speed stability, so you just can't afford not to have Uncle Al's new Cycle Windshell!

Cycle Windshell — \$500, 50 lbs., 1 space, 2 DP. Can be mounted on any motorcycle, but cannot be combined with a sidecar. The Windshell increases top speed by 10 mph, and reduces the difficulty of all maneuvers at 60 mph or above by D1. In addition, the shell's DP acts as two points of armor, protecting against shots from the top, underbody and sides. The second point of damage destroys the windshell, leaving a debris counter behind. If the cycle is traveling faster than its normal top speed, it must slow down next turn. A windshell may not be made of metal.

A cycle may carry a passenger while using this item; all riders have their hand-weapon arcs of fire restricted to the right and left firing arcs. To get on or off, the shell must be unlatched and swung up; it takes 2 turns to open, 3 to close and latch. The entire shell may be jettisoned in one turn; this destroys the shell and is a D3 hazard. This is also achieved by opening the shell while the cycle is traveling above 20 mph.

Windshell Armor — \$10 and 5 lbs. per point, 10 points max. Effectively increases the windshell's DP. Neither windshells nor windshell armor may be made of metal, though all other armor options are available.

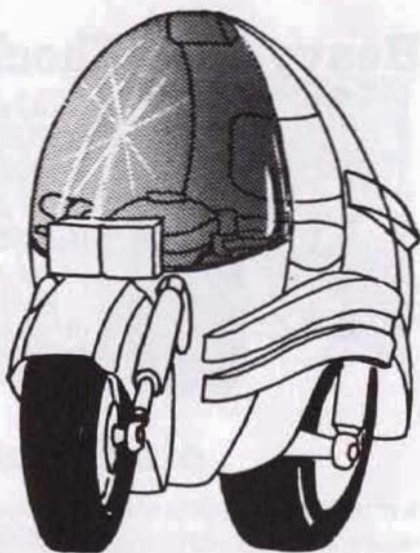

Weapon Concealment

IMPROVED!

Every good poker player knows you don't show your cards all at once. And every good autoduellist knows it pays to keep an ace up the sleeve, just in case. That's why so many of the nation's leading duellists have ordered Cammo Panels, by Napalm Novelties. Paint them to match your armor, and snoopy passersby or opponents will never be the wiser. Please specify weapon, facing and vehicle model when ordering.

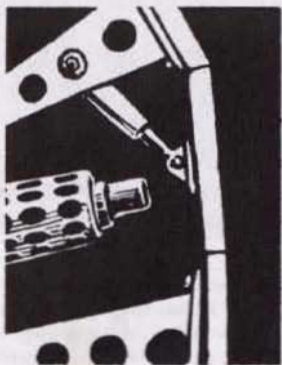

Weapon Concealment — \$250 and 50 lbs. per space of weapon concealed. Takes up no space for a 1- or 2-space weapon, 1 space for larger ones. Component armor, extra magazines and fire-retardant insulators count as part of the weapon; the space taken up by concealment counts towards the 1/3-spaces-per-facing rule.

Concealment hides a weapon's presence until a crew member unconceals it. Activating or deactivating concealment count as firing actions for the weapon — it may not be fired until the next turn. Safety interlocks prevent firing the weapon while it is concealed.

Blow-Through Concealment

When you want to keep it under wraps, but feel you may need it in a hurry, you need a Corker, from Napalm Novelties. These little babies hide your weapon, but pop right off when you need it, with no wasted time and energy! Supplies are limited, so order today!

Blow-Through Concealment — \$100, 10 lbs., no space. This special armor patch covers one weapon's firing port, concealing it from view. When the weapon is first fired, the patch is instantly blown away with a small explosive charge. The patch must be replaced to conceal the weapon again. Blow-through concealment patches must match the vehicle's armor type.

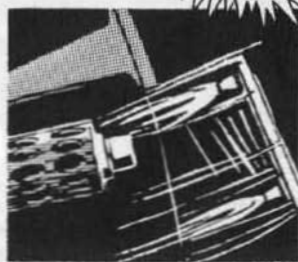

NEW!

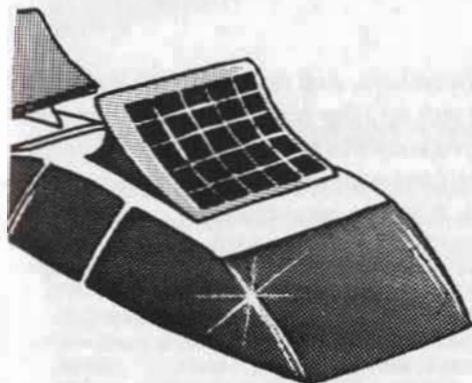

Solar Panel

Tap into the power of the sun! Now the limitless energy of the sun is available to you, with these specially designed solar panels. Reactivate your equipment when your power plant has been drained! Don't be caught in the dark — harness the might of solar energy!

Solar Panel — \$1000, 100 lbs., 2 spaces, 1 DP. Protected by top armor (but only when not deployed), and cannot be mounted on a vehicle that has a turret

rocket platform, car top carrier, portable earth station or any other top-mounted component (including top-mounted weapons). When deployed, each panel automatically positions itself for top efficiency, recharging 20 power units per panel per hour in daytime under clear skies (half that under partly cloudy skies). Takes 1 turn to deploy or retract and can be targeted at -2.

Windjammer **IMPROVED!**

Now is the time to save, and save big! Save on the high cost of running a big rig! Save on powerplant charges! And save with Uncle Al's low, low prices! All you have to do is equip your truck with Uncle Al's own Windjammer, and watch the savings pile up!

Windjammer — \$750, 150 lbs., no space. This item is an airfoil that fits on the front part of the roof of the cab, directing airflow up and over the trailer. This improves the mileage of the tractor-trailer combination by 10%. The windjammer can be targeted from the front at a -2 and has 10 DP; it must match the tractor's armor type. Windjammers cannot be combined with a turret or other top-mounted item.

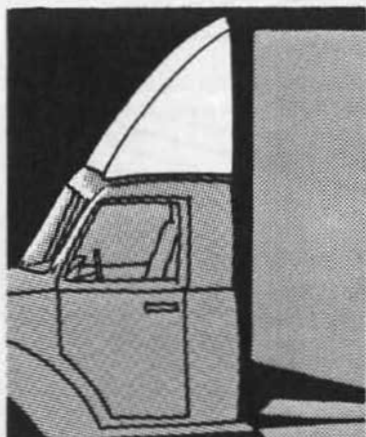

NEW!

Retractable Landing Gear

Not only are those landing skids on your chopper unsightly, but did you know they could be actually slowing you down? But no more! Presenting, brand new, never seen before anywhere else, the latest in helicopter accessories — retractable landing gear! These wheels fold neatly up into your body, eliminating wind drag. Best of all, your copter's *own armor* now protects them — no more fear of kids taking potshots at your skids! Incredible!

Retractable Landing Gear — \$1,500, 150 lbs., 2 spaces. This item, usable only on helicopters, replaces the copter's regular skids with a set of three retractable wheels. Each wheel has 6 DP and is targeted at a -6 when extended. When retracted, the wheels are protected by the helicopter's underbody armor and cannot be independently targeted; furthermore, the helicopter's top speed increases by 10 mph when the wheels are up. Extending or retracting the landing gear takes a firing action and one full turn.

Extra Rotor Blades

No one can ever be too safe, as Uncle Al always says. And that's why you should fly right out to your nearest Uncle Al's outlet and pick up a few extra rotor blades. Remember — all that's between you and the ground are a couple of blades — do you really want to take the chance? Don't you owe it to yourself and your loved ones to take advantage of this special offer? Buy some peace of mind; buy extra rotor blades.

Extra Rotor Blades — Each extra main rotor blade costs \$1,000 and weighs 200 lbs.; each extra stabilizing rotor blade costs \$250 and weighs 50 lbs. Unmodified helicopters are assumed to have two blades; up to three more may be added, for a total of five.

Each extra rotor adds 1 DP to the DP of the rotors. In addition, any helicopter with 4 or more main and stabilizing rotor blades has its HC increased by 1, up to a maximum of 3. If this item is combined with CACR, the number of blades on each main rotor must match, and there is no HC benefit.

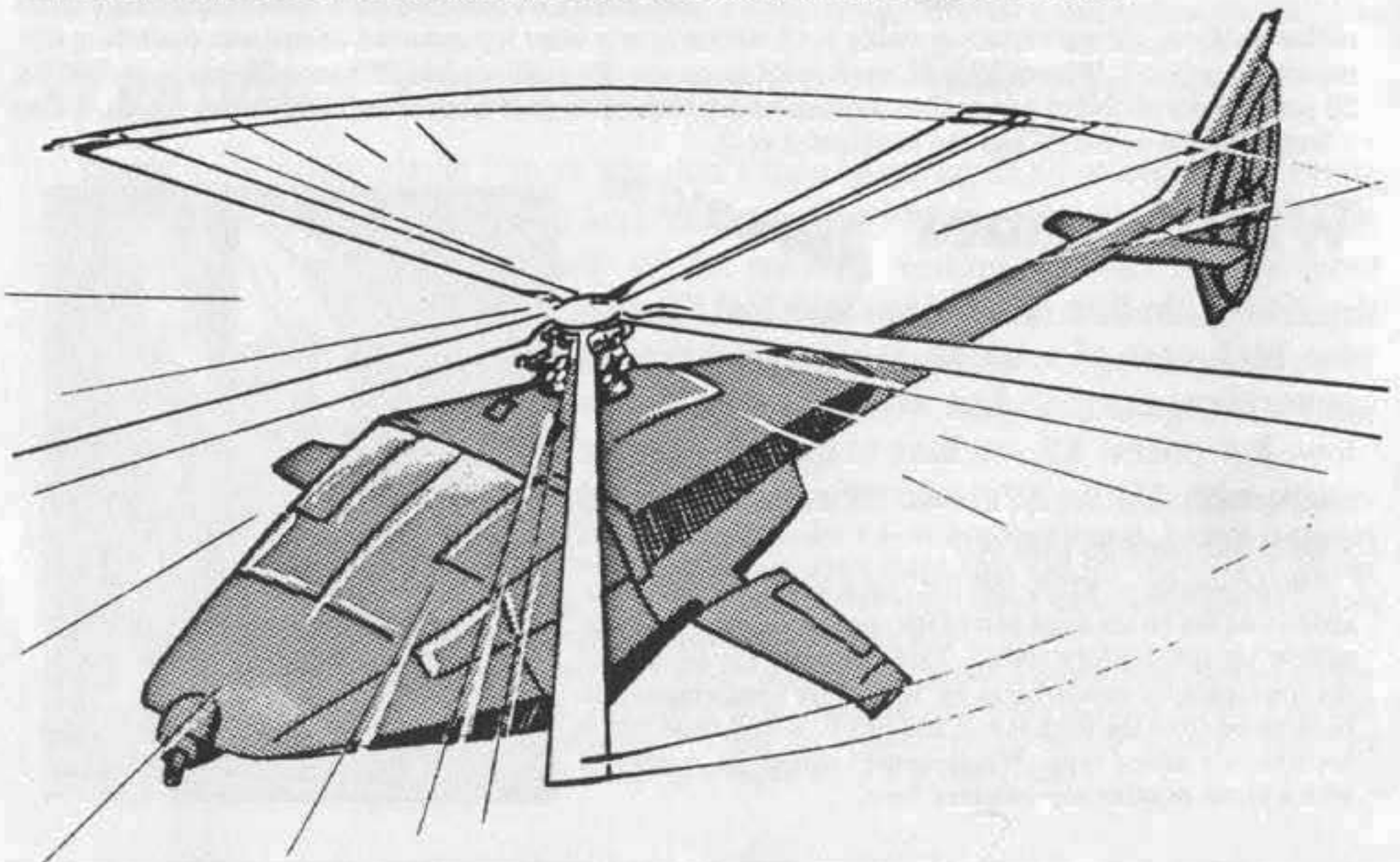

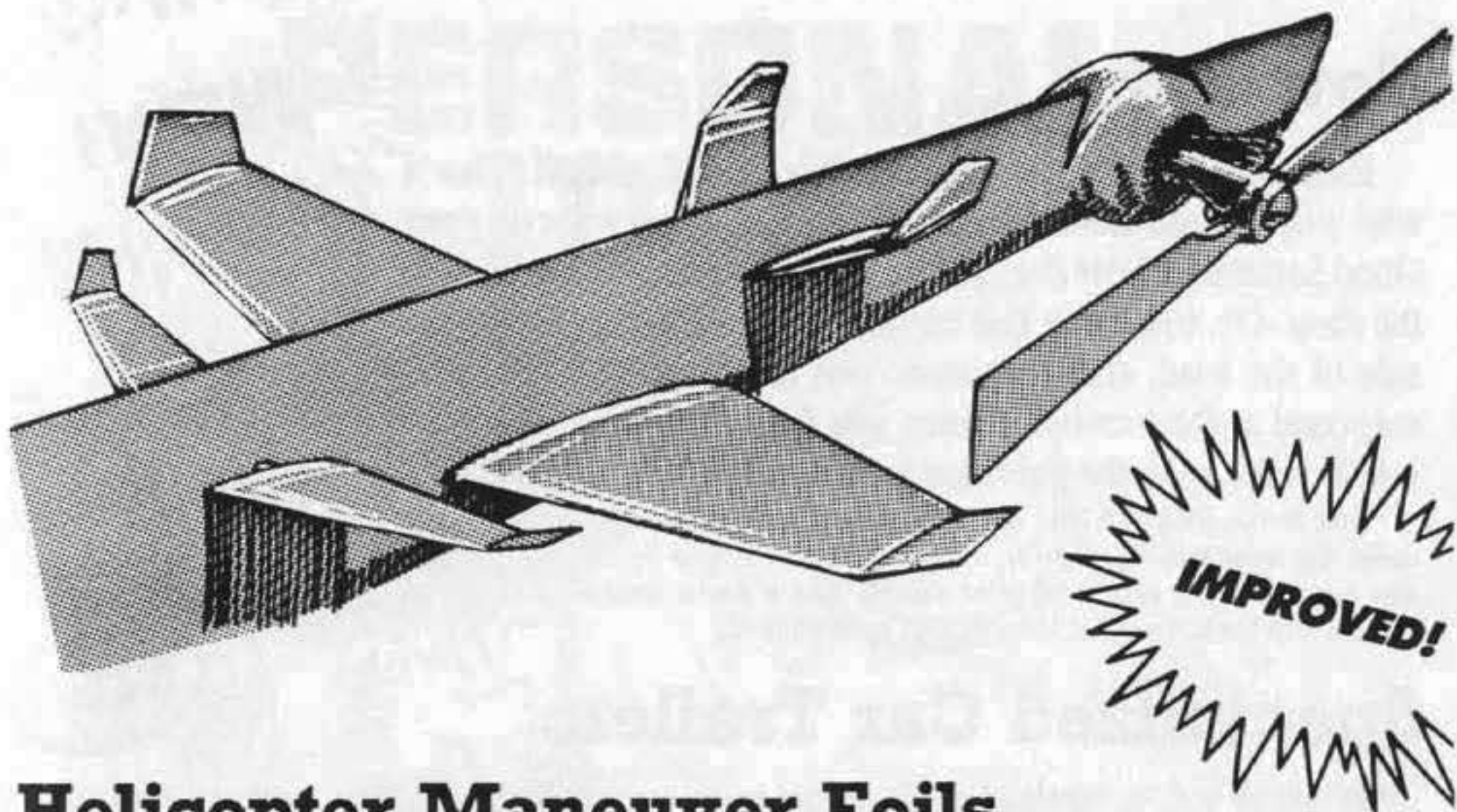

Helicopter Maneuver Foils

A good thing just got a lot better! Hook one of these babies on your chopper, and let her rip through any high-speed maneuver. You'll be amazed at how stable the ride is! It features an automatic computerized self-adjustment of up to an unbelievable 40 times a second! Once you install it, you'll wonder how you ever got along without it.

Helicopter Maneuver Foils — \$3,000 and 300 lbs. per pair, no space. Each foil of the pair has 3 DP. Grasshoppers, one-man and small helicopters may mount one pair; standard and transport copters may mount two.

Maneuver foils reduce the difficulty of any maneuver by D1 when the helicopter is moving 60 mph or faster. (Naturally, this is cumulative — having two pairs reduces difficulties by D2.) D0 maneuvers do not require control rolls.

Foils are mounted in pairs on opposite sides of the body. They are targeted at a -2. If one foil of a pair is destroyed, the copter's HC drops by 2 until the other foil is jettisoned (see below) or destroyed. If the helicopter mounts two pairs, the HC penalties are cumulative.

Foils can be armored. This armor is \$5 and 2 lbs. per point (max 10) per foil, and each foil of a pair must have the same amount of armor. Foil armor must match the copter's armor type.

Foils may be equipped with a jettison/self-destruct option. This costs \$600 per pair. When triggered, both foils in the pair are jettisoned and destroyed (1/2" burst radius), falling as harmless debris to the ground below. Ditching the foils is a D2 hazard, but acceleration and HC may improve.

Improved Tail Assemblies

Fly through the air with the greatest of ease with an Improved Tail Assembly from Aerodrome Industries. Increase your stability at flight speeds, and get that extra edge of security in combat or high winds. Don't say, "I can't afford it." You can't afford *not* to have it!

Improved Tail Assemblies — 20% of body cost and weight. May only be mounted on helicopters and cannot be retrofitted. Reduces the HC penalty of any hazard by 1 when the copter is traveling 60 mph or more. Benefits are lost when the helicopter slows to below 60 or when its back armor is destroyed.

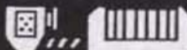

Tow Bar

Every now and then everyone needs a helping hand. That's why you should never be caught on the road without your Good Samaritan Tow Bar. Help that fellow auto-duellist back to the shop. Or, tow away that obviously-abandoned car from the side of the road. (Make sure no one is in it first.) You'll be surprised at the number of uses you find for it. We guarantee you'll make back the purchase money off of salvage alone!

Tow Bar — \$500, 25 lbs., takes up one space as cargo. The tow bar hooks under the front wheels of a car, allowing it to be towed by another vehicle. The bar has 2 DP and is targeted exactly like a trailer tongue. The towed vehicle will break free if it loses one of its front tires.



Specialized Car Trailers

Whether you're hauling cargo across town or across the country, you can't go wrong when you haul it in one of the SafTeePro Specialized Car Trailers. These trailers are so roomy you can fit anything in — no need to hire expensive and unreliable movers anymore! You'll find them easy to drive, too. Order now — there's one that's just right for you!

Specialized Car Trailers — These are special-use versions of regular van car trailers, identical in function to the special versions of ten-wheeler carriers and semi-trailers. The following cost and weight increases are applied to the basic body stats and must be specified during vehicle construction.

For example, a 6' reefer van trailer costs \$750, weighs 1,167 lbs. and has ten spaces; a 30' tanker trailer costs \$5,067, weighs 5,833 lbs. and has 45 spaces; and a mini-van dump trailer costs \$350, weighs 800 lbs. and cannot devote any spaces towards weaponry.

Reefer Van — Increases van trailer cost by two-thirds (66%) and weight by one-sixth (16%), rounded up. Reduces interior space by one-sixth, rounded up.

Tanker — Increases van trailer cost by five-thirds (166%) and weight by two-thirds (66%), rounded up. Reduces interior space by one-sixth, rounded up. Tanker trailers must have at least 20 points of armor, or four points of metal armor, in each location.

Dumper — Increases van trailer cost by three-fourths (75%) and doubles weight. Interior space is unaffected, but a dump trailer may devote no more than one-sixth (rounded down) of its spaces to weaponry. It may not mount a turret and has no top armor. A dump trailer is raised and lowered the same as a dumper carrier.

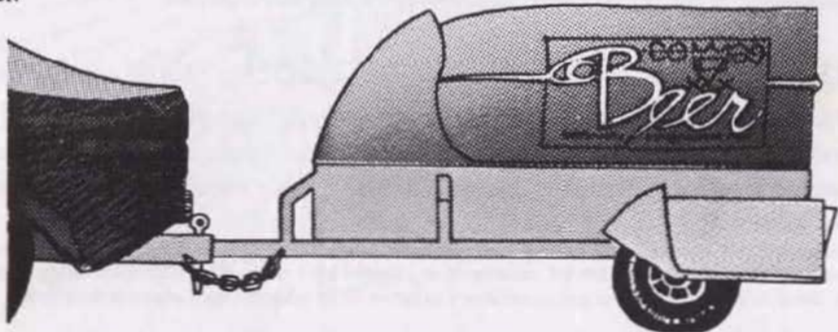

PERSONAL ITEMS



Ah, nothing is so lovely as a warm spring day! Uncle Al wants to encourage all autoduellists everywhere to get out and enjoy the healthful fresh air and sunshine. He's making it easier for all of us with a breathtaking array of personal equipment that is both convenient, economical, and deadly! So get out for that stroll! Lie down on that beach! Go jogging, hiking, running! Uncle Al, the Pedestrian's Pal, has provided the way for you to have fun *and* safety at the same time. (And don't forget your suntan lotion!)

Flak Jacket

NEW!

Now the styles of yesteryear come back again. Yes, you too can wear a flak jacket, so popular in the innocent and fun-filled days of the 1980s. This jacket has a modern twist, however, that's sure to please — extra protection against attack! So be safe and fashionable at the same time. Available in a wide variety of colors. Specify size when ordering.

Flak Jacket — \$150, 3 grenade-equivalents. Gives its wearer 3 extra DP, but only works on a 1-4 on one die. May be worn outside regular (but not improved) body armor. May be worn in addition to a battle vest.

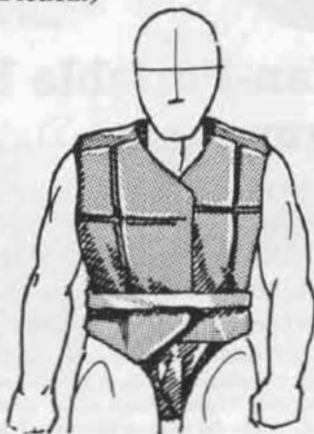



MediKit

Even the best of duellists take a little flak now and then. To patch up those wounds, be sure to always carry Uncle Al's own Medikit; it contains all you'll need to fix anything from a mosquito bite to an amputation. Or, when space and money don't permit, try our Portable Medikit, suitable for just about any emergency. Don't be caught short with cheap imitations; remember, the life you save may be your clone.

MediKit — \$1,000. Counts as a pedestrian's full load when carried. When stored as cargo, takes up 2 spaces and 50 lbs. and has 3 DP. Gives a +2 bonus to all Paramedic rolls.

Portable MediKit — \$750, 3 grenade-equivalents. Worn like a backpack (5 grenade-equivalents if carried by hand), takes 2 seconds to put on or take off. Gives a +1 bonus to Paramedic rolls; this bonus cannot be combined with the bonus for the MediKit. If the wearer is hit, roll one die: On a 1, the MediKit is hit first, taking damage to its 2 DP.



Mini-Mechanic

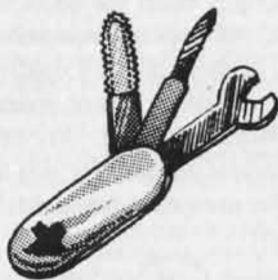

Not everyone can plan a breakdown near an authorized auto shop. So, during those minor mechanical emergencies that occur on the open road, reach for Uncle Al's Mini-Mechanic, the little tool that's a big help with any sort of repair job. Don't end up thumbing a ride back to town; get a Mini-Mechanic, and ride in style!

Mini-Mechanic — \$50, 1 grenade-equivalent. When using this item for any sort of repair job, the penalty for using improvised tools is -1 instead of -2. Will fit like a grenade in a battle vest.

Man-Portable Rocket Launcher

It may be small, but it packs a big punch! When you're forced out on foot, don't go without your very own portable rocket launcher. You'll be able to down cars, trucks, even helicopters with ease! Just like the ones you've seen on TV! So economical, no home should be without one.

Man-Portable Rocket Launcher — To hit 9, 2 dice damage (full damage to vehicles), \$800, 6 grenade-equivalents, 4 shots, CPS 50. Loaded cost \$1,000. Burst effect. These rockets cannot be laser-guided, though the weapon may use a laser targeting scope.



Gyroslugger

What scares autoduellists the most? The thought of being out from behind the wheel — on foot, like any ordinary pedestrian! But you'll be far from ordinary with your very own personalized gyroslugger, specially made to insure that you'll be left alone! You choose, single- or double-barrel variety. You can even use armor-piercing ammo! Special: Just mention this catalogue, and Uncle Albert will engrave your name free on the stock! *Please specify up to 50 letters when ordering.*

Gyroslugger — To hit 8, 2 dice damage (full damage to vehicles). Single-barrel variety is \$1,200, 2 grenade-equivalents, 1 shot; double-barreled version is \$1,500, 3 grenade-equivalents, 2 shots. CPS 100. Burst effect. Reload shells are ½ grenade-equivalent each. The gyroslugger must be reloaded like a shotgun by breaking it open and inserting the shells; this takes one second per shell. This weapon may use armor-piercing ammo, laser targeting scopes and a folding stock, but cannot be laser-guided. Both barrels of the two-barreled version may be fired at once as if they were two linked weapons.

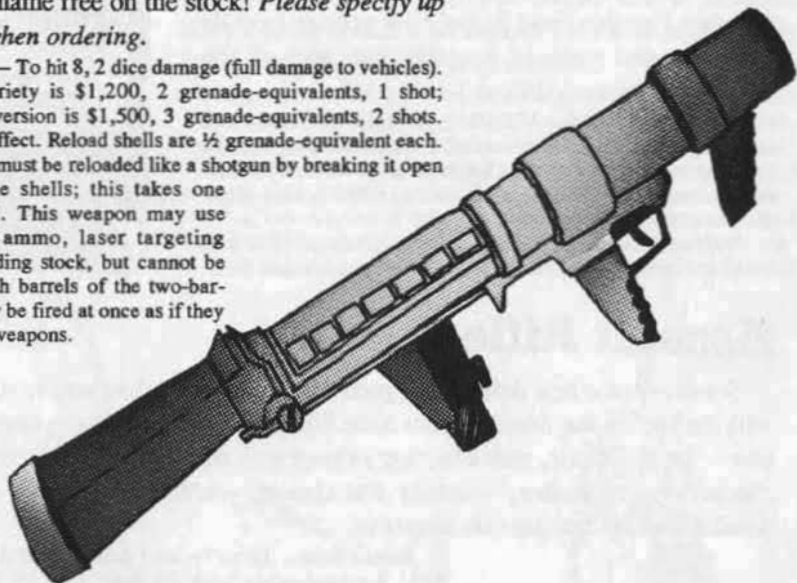

Hand-Held Flare Launcher

Light up those dark corners with the Hand-Held Flare Launcher, from Genesis Armaments. Useful for illumination, for signaling, or even in an emergency as a weapon! Versatile, economical, easy-to-use — why not order yours today?

Hand-Held Flare Launcher — \$300, 1 grenade-equivalent, 5 shots, CPS 10. Loaded cost \$350. Can be used as an improvised weapon: To hit 10, 1d-2 damage (full damage to vehicles), fire modifier 2, burn duration 0. It can also be used like an RL flare round (see p. 17) to illuminate any 20' radius area within 15" of the firer.

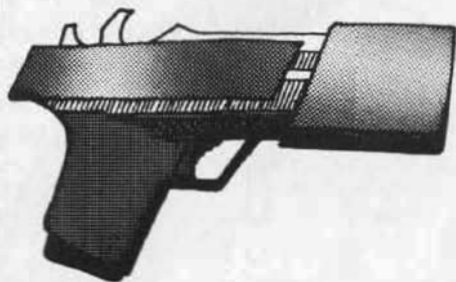



Portable Field Radio

Is there a way that you can stay in constant contact with your companions, even when on foot? And keep track of weather and bandit advisories? And stay only a radio call away from emergency help? All for an affordable price? Impossible, you say? Not with Uncle Al's own Portable Field Radio! Now you can have all the power and range of your car unit, with all the mobility you crave! Only at Uncle Al's!

Portable Field Radio — \$500, 3 grenade-equivalents. This radio duplicates all the functions of the standard long-distance vehicular radio, including the 25-mile range. It can be worn as a backpack and has 1 DP. If a person wearing a PFR is hit, roll one die: On a 1, the radio takes damage first.

Walkie-Talkie — \$250, 1 grenade-equivalent. This item works the same as a vehicular CB and has a 3-mile range.



Assault Rifle

Sometimes the best defense is a good offense. And the best way to start offending is with the Herlitz and Sons' Assault Rifle Weapons System. You can have it anyway you like — the rifle alone, with a bayonet or even with an under-rifle grenade launcher! You choose! But remember, whatever you choose, you'll know you've chosen quality! Available in his and her matching sets.

Assault Rifle — To hit 7, 1d+1 damage (half damage to vehicles), \$400, 3 grenade-equivalents, 10 shots, CPS 15. Loaded cost \$550. May use a folding stock.

Bayonet — To hit 8, 1d-2 damage, \$50, 1 grenade-equivalent. When attached to the end of a rifle or assault rifle, it adds no grenade-equivalents.

Under-Rifle Grenade Launcher — To hit 7, damage by grenade type, \$200, 1 grenade-equivalent, 1 shot, CPS by grenade type. This launcher specifically mounts underneath the barrel of the assault rifle and has a separate trigger. Either the rifle or the launcher (but not both) may be fired in one turn. One does not benefit from sustained fire by the other, but a single laser-targeting scope suffices for the pair. The URGL may fire only one grenade, after which it must be reloaded, requiring a full turn. The encumbrance of the URGL is added to that of the rifle, making the combination 4 grenade-equivalents. Both a bayonet and an URGL may be mounted on an assault rifle at the same time.



Impact Armor

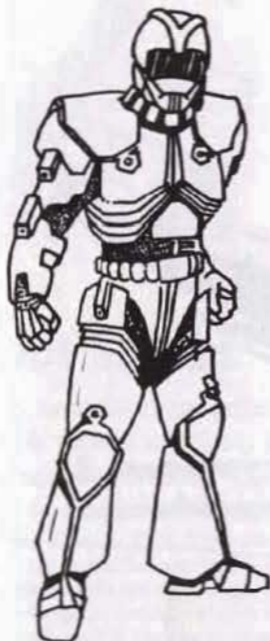

We've all had it happen to us — we take a bad spin on our cycle, hit a bump, and go flying off to land on the pavement, with armor and body parts flying in all directions. Now you can get some protection against pounding the asphalt with Uncle Al's own Impact Armor. Great for bikers, hang-gliders and anyone else who occasionally hits the deck a little harder than usual.

Impact Armor — \$2,000. Impact armor gives the wearer 6 additional DP and is fully effective against falls and collisions. Furthermore, any fall or collision damage is halved before applying it to the armor's DP. Naturally, once the armor is destroyed (by collision or weapons damage), these benefits are lost. Impact armor has the same effects on carrying capacity, reflex rolls and running speed as improved body armor, but it does not give protection from fire or gas. This item cannot be combined with any other form of body armor except for a fireproof suit.

Blended Body Armor

No more clunky body armor! Get rid of those tacky, ugly duds, and get the latest from Uncle Albert — Blended Body Armor. Designed by Monique's of Paris, with help from Atlas Bodyworks, these fashionable outfits look just like streetclothes, but are tough enough to last through any battle! Available in a wide variety of styles and colors — phone and ask Gigi, Muffy or Spike for assistance.

Blended Body Armor — \$750 and up. Gives the wearer 3 extra DP, just like regular body armor, but is indistinguishable from street clothes. Custom tailoring, or specialized formal wear such as a tuxedo, may cost more (GM's discretion). Regular body armor of any type cannot be worn with this item, and a fireproof suit will be obvious if worn. Improved Body Armor is also available in a blended version for \$5,000 and up, but it does not offer protection from fire or gas (though its penalties still apply). Impact armor is not available in a blended version.





Stinger

Nothing is as much fun as lying on a grassy hillside on a warm spring day watching the helicopters fly by — unless it's shooting them suckers down! Now you can improve your marksmanship while out breathing the healthful spring air, with Uncle Albert's own Stinger surface-to-air missile. *Warning: Tests have shown the Stinger to be significantly less accurate when fired against ground-based targets.*

Stinger — To hit 7 vs. aerial targets or 11 vs. grounded ones, 4 dice damage (full damage to vehicles), \$1,000, 5 grenade-equivalents. Burst effect (2" radius).

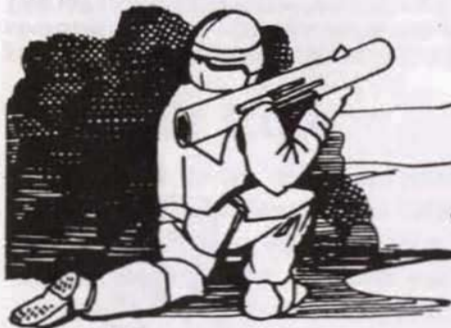

Bazooka

Some ideas are so good they just never go out of style. That is why Uncle Albert is so proud to stock bazookas, one of our best sellers in personal equipment. Available in a wide variety of decorator colors, our bazookas are lightweight, easy to load and oh-so-economical! Buy yours today — due to the overwhelming demand, supplies are limited!

Bazooka — To hit 9, 3 dice damage (full damage to vehicles), \$1,500, 4 grenade-equivalents, 1 shot, CPS \$50. Burst effect. Extra shells are 1 grenade-equivalent each. Takes 2 seconds to reload alone, one second for two people.

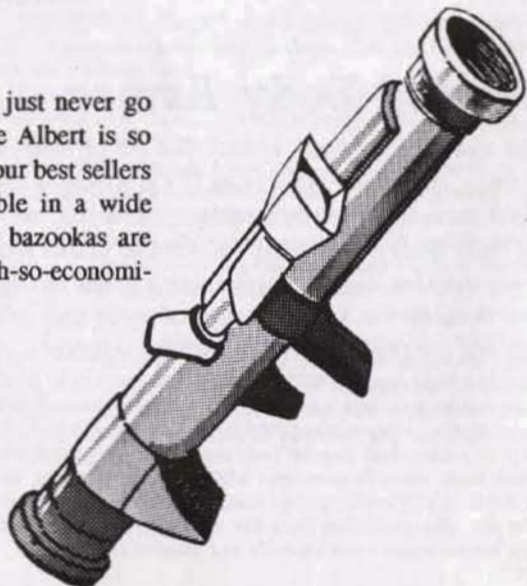

NEW!

Tripod Wire-Guided Missile



Uncle Albert's famous R&D team is constantly finding new ways to increase your duelling pleasure. Knowing how much duellists everywhere cherish their wire-guided missiles, they've figured out a way to mount one on a tripod! Useful for picnics, outings in the park, and backyard barbecues!

Tripod Wire-Guided Missile — To hit 7, 3 dice damage, \$500, .5 grenade-equivalents. One shot, CPS \$2,000, reloads are 3 grenade-equivalents each. The TWGM is aimed and fired just like a vehicular WGM (see p. 4).

Riot Shield

A must for every police force! Now you can have the protection of a full-sized shield, without sacrificing line-of-sight. Keep those pesky rioters and troublemakers in plain sight at all times, with the Riot Shield. *Police Associations:* Discount for mass orders from authorized agents of any police force. Uncle Al is the policeman's pal, too!

Riot Shield — \$750, 3 grenade-equivalents. This transparent shield has 7 DP and acts like a wheelguard. When the pedestrian carrying it is hit from the front, roll one die; on a 1-4, the shield takes damage first (with any leftover still hitting the target), and on a 5-6, the pedestrian takes full damage. The shield is made from vehicular-grade armor, and thus will take half or no damage from many hand weapons. Only pedestrians (not passengers in vehicles or on motorcycles) may use this item, and firing hand weapons while encumbered by the shield is at a -1.

Tripod Gunshield

Everyone just loves the convenience, excitement, and just-plain-fun of launching an attack from tripod-mounted weapons. But no one likes the sitting-duck feeling you get when they return fire! Well, PedTech West has come up with the perfect solution to that

little problem — a Tripod Gunshield! Now you can have up to 40 pounds of vehicular-grade armor plastic, tough enough to stop a .50-cal burst cold, and in an easy-to-mount, easy-to-move shield that looks sharp. No wonder everyone says, Stay Safe With PedTech!

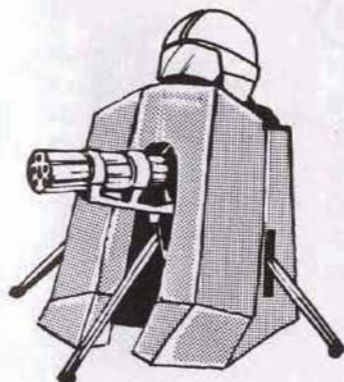

Tripod Gunshield — \$10 and 4 lbs. per point of armor, up to a maximum of 10 points (or 40 lbs.). A gunshield may only be mounted on a tripod weapon, adding 1 grenade-equivalent to that weapon's encumbrance. The shield acts like a wheelguard: On a 1-4, the gunshield takes damage before the target. Gunshield armor is considered to be a vehicular component, and thus takes half or no damage from most hand weapons.

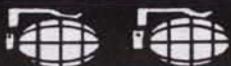

Tinted Goggles

Just in time for the new fashion season, Uncle Al presents a whole new line of Ray-Bane tinted goggles. Available in a wide variety of chic colors and striking styles, these goggles will help protect your eyes from the glare of anything from sunlight to searchlights. And so reasonably priced, you can be sure everyone who's anyone will be wearing them. Don't be caught out of the crowd — buy your pair today!

Tinted Goggles — \$20, no grenade-equivalents. Protect the wearer against searchlights exactly like a tinted windshield. Cannot be combined with a gas mask or light-intensifying goggles.



Flechette Grenade

One major problem with shopping anywhere is how crowded the shopping centers get! Now you can eliminate that annoyance with PedTech's own Flechette Grenade! Just toss it into the crowd, and watch the people scatter! Great for clearing unruly gatherings at school, insuring first place in line at church picnics, or removing troublesome teenagers at the malt shop. A must for Christmas shopping! Order several today!

Flechette Grenade — \$20, 1 grenade-equivalent. Does 1 die damage to all pedestrians and exposed cyclists in a 2" burst radius. No damage to tires or vehicular components.



NEW!

Fake Grenade

Great for practical jokes! It looks just like the real thing, but it's really plastic. Throw one out in a crowd, then enjoy the fun! (Be sure to wear running shoes or body armor; not everyone has your fine sense of humor.) Hours of entertainment for a low, low price! An excellent gift for the little autoduellist in your family — sure to please every boy and girl!

Fake Grenade — \$5, 1 grenade-equivalent. Looks just like a regular grenade, but will not detonate — it's just plastic.



INDEX

This handy index will help our customers in ordering:

A

Accessories (section), 20
Assault Rifle, 34

B

Bazooka, 36
Blast Cannon, 3
Blended Body Armor, 35
Blow-Through Concealment, 27

C

Carbon-Aluminum Frames, 25
Cycle Windshell, 26

D

Deadman Switch and Damage
Sensor, 14
Defense (section), 8
Dischargers, 11
Dual Weapon Magazine, 2

E

Explosive Rounds, 15
Extra Rotor Blades, 28

F

Fake Grenade, 38
Fake Turret, 21
Fire-Retardant Insulators, 14
Flak Jacket, 31
Flame Clouds, 13
Flaming Oil Ammo, 19
Flechette Grenade, 38

G

Glow-in-the-Dark Paint, 16
Gyroslugger, 33

H

Hand-Held Flare Launcher, 33
Heavy-Duty Shock Absorbers, 25
Helicopter Maneuver Foils, 29
Hi-Res Single Weapon Computer,
22
High-Intensity Optics, 7
High-Temperature Ammo, 17

I

Ice Ammo, 19
Impact Armor, 35
Improved Tail Assemblies, 29

J

Junk Dropper, 8

L

Laser-Guidance Link, 6
Laser-Reactive Web, 10
Light Flamethrower, 7
Long-Range Radar, 24

M

Man-Portable Rocket Launcher,
32
MediKit, 32
Medium Laser, 6
Mini-Mechanic, 32
Mini-Rocket Platform, 21
Munitions (section), 15

N

Napalm Mines, 18

O

Offense (section), 2

Uncle Albert's 2035 Catalog rocked the autoduelling world. For the first time, Uncle Al's amazing array of autoduelling accessories was available by mail-order to the general public!

But Al didn't stop there! Time marched on, and so did technology. *Uncle Albert's 2036 Catalog Update* kept the duelling public in touch with all the latest advances.

And now, two years later, Al's done it again! The Duellist's Pal has collected more than 70 new weapons, gadgets and accessories into his brand-new *Uncle Albert's 2038 Catalog Update*.

Duellists across North America already know the value of Uncle Al's fine products. But if you're new to the autoduelling world, just listen to these —

CELEBRITY ENDORSEMENTS

OFFENSE

pp. 2-7

DEFENSE

pp. 8-14

MUNITIONS

pp. 15-19

ACCESSORIES

pp. 20-30

PERSONAL ITEMS

pp. 31-38

"I've been autoduelling since before it was legal, and I ain't never seen no place as good as that youngster's — what's his name, Al? Since those first days of strapping a machine gun to the top of the car, to now with all these fancy radar gadgets and what-not, Uncle Al has always had exactly what this gun-toting granny has needed. I wouldn't dream of going anyplace else!"

— Eula May Gooch, Ladies' Home Sewing Circle and Terrorist Society

"I grew up around my local Uncle Al's outlet. Many a summer I spent packing boxes, sweeping floors, disposing of outdated ammo, that sort of thing. Spent a lot of time bugging the mechanics with questions. Well, I wouldn't be where I am today without the friendly folks at Uncle Alberts!"

— Bobby Hendryx, World Champion (Division Five), 2037

"Keeping a show like *McDade* in step with the latest trends can be a headache. You've got to realize our audience is both knowledgeable and discriminating — they know what's hot and what's not. We can't afford to let them down by showing outdated weaponry. Fortunately, our job is made much easier by Uncle Al — we just open his latest catalog, and there are our stories for the next season! Uncle Al is a lifesaver!"

— Skippy McLennon, producer of the hit TV show *McDade*

SJG00595 7130



ISBN 1-55634-144-X