

CAR WARS®

DELUXE EDITION

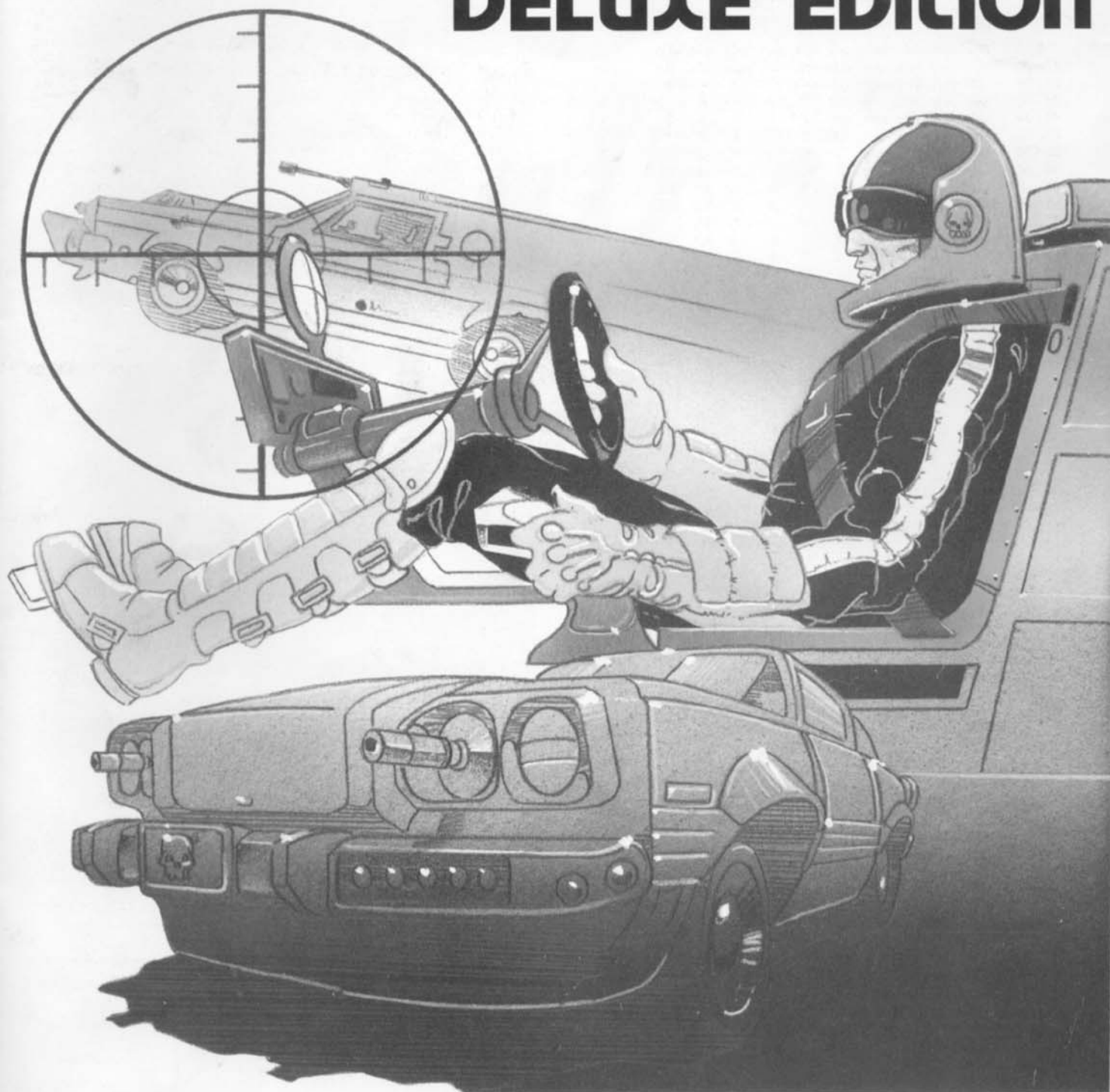

STEVE JACKSON GAMES

Control Table

Cross-index the handling status of your vehicle (from the Handling Track) with its speed, and roll one die. If you roll the number shown or higher you keep control of the car. If you roll lower, you lose control.

If you lose control, go to the appropriate Crash Table (No. 1 for maneuvers, No. 2 for hazards). "Safe" means you cannot crash. "XX" means you lose control automatically — go to the Crash Table. When you go to the Crash Table for any reason, add or subtract the number in the "modifier" column from your speed — i.e., at 20 mph, you would subtract 2 from your roll on either Crash Table.

Speed	Handling Track Status										modifier	
	3	2	1	0	-1	-2	-3	-4	-5	-6		
5-10	safe	safe	safe	safe	safe	safe	safe	safe	safe	safe	safe	—
15-20	safe	safe	safe	safe	safe	safe	safe	safe	safe	2	2	—
25-30	safe	safe	safe	safe	safe	safe	2	3	4	4	4	-2
35-40	safe	safe	safe	safe	safe	2	2	3	4	5	5	0
45-50	safe	safe	safe	safe	safe	2	2	3	4	6	6	1
55-60	safe	safe	safe	safe	safe	2	3	4	5	6	6	1
65-70	safe	safe	safe	safe	2	2	3	4	5	XX	XX	2
75-80	safe	safe	safe	safe	2	3	4	5	6	XX	XX	2
85-90	safe	safe	safe	safe	2	3	4	5	XX	XX	XX	3
95-100	safe	safe	safe	safe	3	4	5	6	XX	XX	XX	3
105-110	safe	safe	safe	2	3	4	5	6	XX	XX	XX	4
115-120	safe	safe	safe	2	3	4	5	XX	XX	XX	XX	4
125-130	safe	safe	safe	3	4	5	6	XX	XX	XX	XX	5
135-140	safe	safe	2	3	4	5	XX	XX	XX	XX	XX	5
145-150	safe	safe	3	4	5	6	XX	XX	XX	XX	XX	6
155-160	safe	safe	3	4	5	XX	XX	XX	XX	XX	XX	6
165-170	safe	2	3	4	5	XX	XX	XX	XX	XX	XX	7
175-180	safe	2	3	4	XX	XX	XX	XX	XX	XX	XX	7
185-190	safe	2	3	4	XX	XX	XX	XX	XX	XX	XX	8
195-200	2	3	4	XX	XX	XX	XX	XX	XX	XX	XX	8

Crash Table 1 — Skids & Rolls

Use this table if you lose control during a maneuver. Roll one die — then add or subtract the modifier for your speed, given on the Control Table. This tells you what happens to your vehicle on its next move.

- 1, 0, 1 — Trivial skid. The vehicle keeps its same orientation, but moves ¼" in the direction it was going at the beginning of the phase in which it lost control. Therefore, it may skid in a direction other than the one it is pointing — see the illustration under "Maneuvers."*
- 2 — Minor skid. As above, but the vehicle skids ½".**
- 3 — Moderate skid. As above, but the vehicle skids ¾".**
- 4 — Severe skid. As above, but car skids 1" and each tire takes 2 points damage.***
- 5 — Car turns sideways (see "Maneuvers" above) and rolls. The driver is no longer in control. It decelerates at 20 mph per turn. Each phase it moves, it goes 1" in the direction it was traveling and rolls ¼ of a complete roll — i.e., the first phase it moves 1", turns sideways, and rolls on its side; the next phase it moves, it goes 1" and rolls onto its top, etc. It takes 1 die damage to the side (top, etc.) rolled onto each phase. When the bottom hits, each tire takes 1 die of damage. After all tires are gone, the bottom takes damage when it hits. Occupants may jump out at any time, or stay inside and hope that no damage reaches the interior. It may be driven after it stops rolling if it is right-side-up and has tires on at least 3 corners. A cycle won't be drivable after a roll.***
- 6-9 — As above, but vehicle is burning on a roll of 4, 5, or 6 on one die. (For more information on burning vehicles, see "Fire and Explosion" in Section V, *Combat*.)
- 10 or more — As above on this table, but the vehicle vaults into the air by the side (or front) tires, the tires doing the vaulting taking 3 dice of damage. The vehicle will then fly through the air for 1-6 inches (roll one die) in the direction the vehicle was traveling before the crash result, revolving two sides for every inch traveled. When it lands, the side that hits takes collision damage at the vehicle's initial speed. If the attempted maneuver was a tight bend or a hard swerve, the vehicle will flip end over end. Upon landing, the vehicle will continue to roll as per result 6-9 on this table. All occupants take one point of damage automatically. Body armor does not protect against this damage.

The Helicopter Crash Table is on page 51.

Crash Table 2 — Fishtails

Use this table if you lose control due to hazard. Roll 1 die, as above.

- 1, 0, 1, 2 — Minor fishtail. Roll randomly to see if fishtail will be left or right. If, for instance, it is left, keep vehicle's right front corner in the same square, and move the left rear corner 1 square left. Reverse for a right fishtail.*
- 3, 4 — Major fishtail. As above, but rear corner moves two squares.**
- 5 — Execute a minor fishtail and roll again on Crash Table 1.***
- 6-9 — Execute a major fishtail and roll again on Crash Table 1.***
- 10 or more — Execute a major and a minor fishtail (for a total of three squares movement in one direction) and roll again on Crash Table 1.

Crash Table 3 — Car Trailers/Tractor-Trailer Rigs

- 1 — Trivial skid. The tractor moves ¼" in a "trivial skid" as per Crash Table 1. The trailer follows as per a normal maneuver.*
- 0 — Minor fishtail. The tractor does not move; the trailer fishtails ¼". Treat as a regular fishtail; roll randomly for right or left and move the rear of the trailer ¼" in that direction, keeping the kingpin over the fifth wheel.*
- 1 — Minor skid. The tractor skids ½"; the trailer follows normally.**
- 2 — Major fishtail. The tractor does not move; the trailer fishtails as for result 0, above, but moving ½" (two squares).**
- 3 — Minor skid and fishtail. As for result 1, above, followed by result 2.**
- 4 — Major skid and fishtail. As for result 3, above, except that the tractor skids ¾" and then the trailer fishtails ¾".***
- 5 — Extreme fishtail. The tractor stays still, the trailer fishtails 1".***
- 6 — Extreme skid and fishtail. Tractor skids 1"; trailer follows and fishtails 1".***
- 7 — Kingpin breaks. The trailer comes loose. The tractor's fifth wheel takes (1d-2) damage. A further D2 hazard! See "Loose Trailers," below.***
- 8 — As above, but the trailer goes into a roll.
- 9 — As result 7, but the tractor rolls. There is a 50% chance that it catches fire.***
- 10 — As result 9 above, but the trailer rolls, too.
- 11 — As result 9 above, but the tractor or towing vehicle flips as in result 10-12 on Crash Table 1.
- 12 or more — As result 11 above, but the trailer rolls too.

* Any further aimed weapon fire from these vehicles on this turn will be at a -3 to hit.

** Any further aimed weapon fire from these vehicles on this turn will be at a -6 to hit.

*** No further automatic weapon fire permitted from these vehicles this turn.

The result of a Crash Table roll is applied at the beginning of the next phase in which a vehicle moves. A vehicle that fishtails may move normally after it fishtails. A vehicle that skids must move straight ahead for the rest of that phase — i.e., if it skids ¼", it must move ¾" forward (the direction its nose is pointing) after the skid. If a vehicle is on its half-move, it cannot skid more than ½".

A vehicle that encounters a hazard while skidding or fishtailing must make another control roll, and may lose control again, affecting it on the next phase it moves. No vehicle may skid more than once per phase.

Maneuvers

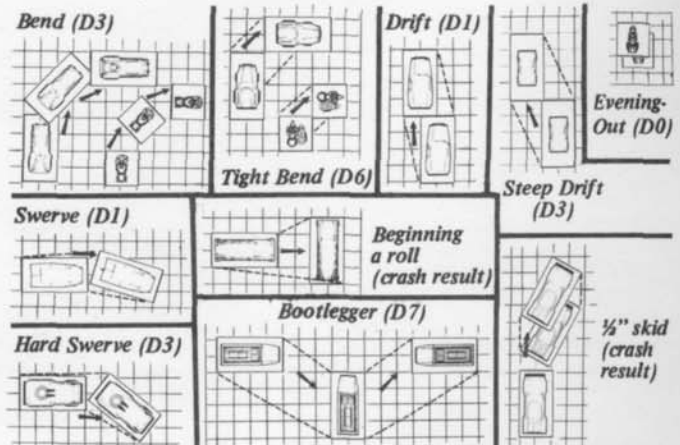

All maneuvers are described in Section IV, *Movement* (page 8). Note: If no picture is shown for a cycle, the cycle's movement is the same as for the front half of a car performing that maneuver.

CAR WARS®

Deluxe Edition

*Game design by Chad Irby and Steve Jackson
Revised edition development by Scott Haring*

Box cover art by Denis Loubet — Rulebook cover art by David R. Deitrick

Interior art by Daniel E. Carroll, Bill Casserly, Graham Chaffee, Simon Coleby, Jeff George, Denis Loubet, Kyle Miller, Josh Seaver, Kim Strombo, George (Speed) Webber, Dan Willems, and Porter R. Wood.

*Playtesters: Norman Banduch, Caroline Chase, Heath Culp, Jim Gould, David Ladyman, David Noel, Tim Ray, and Allen Varney.
Thanks to the many intrepid duellists who playtested earlier editions of Car Wars and its supplements.*

Copyright © 1981, 1982, 1983, 1984, 1985 by Steve Jackson Games Incorporated

Car Wars is a registered trademark of Steve Jackson Games Incorporated.

Autoduel is a registered trademark and Crash City and Truck Stop are trademarks of Steve Jackson Games Incorporated.

I. Introduction	2
Chronology, 2.	
II. Jump-Start Rules	3
Introduction, 3; Beginning the Game, 3; Vehicle Selection, 3; Movement and Scale, 3; Acceleration and Deceleration, 3; Maneuvers and Control, 3; Crashes and Collisions, 4; Combat, 4; Scenarios, 5; Charts, 5; Stock Car List, 6; Accessories, 6.	
III. Getting Started	7
Beginning the Game, 7; Vehicle Selection, 7.	
IV. Movement	8
Scale, 8; Acceleration and Deceleration, 8; Straight-Line Movement, 8; Maneuvers, 8; Handling Class, 10; Hazards and Road Conditions, 10; Crashes and Collisions, 10; Debris and Obstacles, 13; Pedestrians, 13.	
V. Combat	14
General Combat Procedure, 14; Determining Hits, 14; Damage, 17; Combat Results, 18; Odds and Ends, 19; Hand Weapons, 20; Buildings, 21.	
VI. Pedestrians	23
Movement, 23; Combat, 23; Pedestrians and Vehicles, 23.	
VII. Continuing Characters	26
Skills, 26; Prestige, 27; Wealth, 28; Keeping Your Character Alive, 28.	
VIII. Car Design	29
Body Types, 29; Chassis, 29; Suspension, 29; Power Plants, 29; Tires, 30; Weapons, 30; Armor, 31; Accessories, 31; The Human Element, 33; Cargo, 33; Computing Acceleration, 34; Placing Weapons and Armor, 34; Repair and Salvage, 34.	
IX. Cycle and Trike Design	35
Cycles, 35; Trikes, 35; Trike Combat, 36.	
X. Ten-Wheelers	37
Cabs, 37; Carriers, 37; Mini-buses, 38; Combat, 38; Movement, 38.	
XI. Car Trailers	40
Body Types, 40; Tongues and Hitches, 40; Movement, 41; Combat, 43.	
XII. Trucks and Buses	44
Tractors, 44; Trailers, 45; Buses and RVs, 46; Combat, 46; Movement, 46; Crashes and Collisions, 47.	
XIII. Helicopters	48
Construction, 48; Movement, 49; Combat, 51; Peculiar Equipment, 52.	
XIV. Scenarios	53
Road Scenarios, 53; Arena Combat, 53; At the Truck Stop, 54; City Fights, 54; Off-Road Duelling, 57.	
XV. Sample Vehicles	59
Cars, 59; Cycles, 60; Trikes, 60; Ten-Wheelers, 60; Car Trailers, 60; Trucks, 60; Buses, 60; Helicopters, 60; Special Vehicles, 61.	
XVI. Index	62

I. Introduction



Car Wars is one of the adventure gaming industry's most interesting phenomena. Since its first appearance in 1981, the game has grown to support a dozen other products, a line of miniatures, and a magazine. Over 100,000 copies have been sold in three years — and the end is nowhere in sight. Players across the country have joined a real-life American Autoduel Association, with its own events and tournaments.

Why is *Car Wars* so popular? I think the main reason is that it's an "accessible" fantasy. Everyone who's been behind the wheel of a car or motorcycle has encountered an idiot in traffic, and the universal response seems to be, "If I only had some guns mounted on this baby, I'd show that bozo what's what!" Well, this game gives you those guns! Of course, the bozos have guns, too . . .

The game was a hit when it sold for \$3.00 in a ziplock bag, and it was a hit in a Pocket Box — so why put out this new edition? There are some reasons that are purely economic — expanding our markets and other boring business stuff like that. But the main reason is that as the game has expanded, it's gotten more complicated. As new supplements, ideas, and questions came up, we would "patch" on an answer — and pretty soon these "patches" started getting in each other's way. We've always been proud that *Car Wars* was a simple, easy-to-learn, fun game . . . but it was getting less simple with each new release.

So here is *Deluxe Car Wars*. It begins with a slimmed-down, easy-to-learn version of the game for those of you new to autoduellling, and we follow with the definitive set of *Car Wars* rules. We've gone back to our supplements and long out-of-print issues of *Autoduel Quarterly* and put all the information in one place. Helicopters from *Autoduel Champions*, eighteen-wheelers from *Truck Stop*, ten-wheelers and trailers from *Autoduel Quarterly* — they're all here.

But the hardest part was tightening up the rules. After nearly two years as editor of *Autoduel Quarterly*, I think I've heard every picky rules question that could possibly be asked. I'm proud to say (at least I think I'm proud to say) that *Car Wars* players are the pickiest, most demanding, rules lawyers I've run into in a decade of gaming. And Fangio bless every single one of them, because without them, many of the improvements in this edition would not have come about.

There are a few other folks who deserve special thanks for their input on this project. Many of their contributions to previous *Car Wars* products have been used in this edition — to that extent, they are co-authors. Thanks to Steve Jackson, Aaron Allston, Stefan Jones, David Ladyman, Jim Gould, Keith Carter, Jeffrey Field, Kevin Stein, Chip Martin, Philip and Paul Schwartzberg, David R. Jackson, and the scores of *Autoduel Quarterly* readers who contributed to Uncle Albert's Auto Stop and Gunnery Shop.

One last thank you, to Warren Spector, Allen Varney, and Norman Banduch for their suggestions, support, and help. It is no exaggeration to say I couldn't have done it without them.

— Scott D. Haring

Chronology

- 2000: Federal government moves to nationalize dwindling supplies of oil and natural gas production. Legislatures in Texas, Oklahoma, and Louisiana react by seceding, and move to nationalize these resources themselves. Pitched battles with federal forces follow, resulting in the destruction of several oil field sites on both sides of the newly-established border.
- 2003: U.S. forces stopped in hills of central Texas, ending bloody "Gulf or Bust" campaign. Rebel forces begin to retake lost territory.
- 2004: Texarkana Accords are signed, ending Second Civil War. Oklahoma, Texas, and Louisiana become three separate sovereign nations, referred to as the Free Oil States.
- 2012: Grain blight breaks out in Nebraska, spreading rapidly to neighboring areas. A simultaneous blight takes root in the Ukraine. Accusations fly, charging deliberate biological warmongering, followed by nuclear warheads. To everyone's surprise, satellite defenses soak up virtually everything that can be dished out, dissipating most of the fallout above the atmosphere and causing little resulting disturbance on the planet below. Meanwhile, the world's stock of grains, excluding barley and sesame, has been utterly devastated. Severe food shortages spring up across the globe. The U.S. is in better short-term shape than most, since the blight apparently has no effect on foods with preservatives in them.
- 2016: The Food Riots. "Fortress" towns develop. National government fails to keep order throughout much of the U.S.
- 2018: Gangs rule most of the U.S. outside fortress towns. Country real estate becomes worthless; algae farms make up lost food production.
- 2020: Many large cities totally abandoned. National government regains authority but enforcement decentralized. Economy weak but stable, with food rationed and unemployment at 37%.
- 2022: Supreme Court decision decriminalizes manslaughter in arena games. "Death sports" become popular. Television becomes nation's number-two industry, just after food production.
- 2023: "Crazy Joe" Harshman wins Fresno destruction derby by mounting a surplus .50-caliber machine gun in his Chevy. Term "autoduellling" first used by sportswriters.
- 2024: Armadillo Autoduel Arena opens on site of former shopping mall in Austin, Texas.
- 2025: Autoduellling becomes most popular TV sport, edging out combat football and private wars. Eight more autoduel arenas open in North America. The American Autoduel Association is formed.
- 2026: Utah autoduellists form vigilante group to counter Badlands cycle gangs. AADA holds first sanctioned "National Championship" in Austin, Texas. AADA also begins issuing area advisories and helping duellists organize against cycle gangs and other hazards, upsetting local police forces.
- 2027: Police admit inability to deal with duellist-armed vehicles in highway use. Informal duels increase in number.
- 2028: Many localities legalize vehicular weaponry of a "defensive nature" — very loosely defined. Duelling outside city limits now legal in 14 states and tolerated in most others.
- 2029: A variety of weaponry becomes available as "factory options" on all U.S. makes of cars and several imports.
- 2030: Statistics show "smash-and-grab" cycle and car gangs much reduced. Rural real estate begins to rise in value. Law-enforcement officials credit vehicular weaponry of private citizens, but point out that "The gangs that are left are now better armed than we are . . ." Autoduellling now legal in 39 states, as well as the Free Oil States.
- 2031: *Car Wars* is released to the general public.
- 2033: *Autoduel Quarterly*, "The Journal of the American Autoduel Association," is first published. Autoduellling now legal in all 47 states in the U.S., as well as Texas, Oklahoma, Louisiana, most Canadian provinces, the Republic of Quebec, Australia, and Mexico.
- 2035: *Car Wars — Deluxe Edition*.

II. Jump-Start Rules

1. Introduction

If you're already familiar with *Car Wars*, skip this section and start reading the new rules on page 7. If, on the other hand, you're new to the world of autoduellings, here's a simple set of rules to get you started. When you're done here, you'll know the basics of *Car Wars* movement and combat, and you'll be ready to take on the more complex Deluxe game.

2. Beginning the Game

To start the game, turn to Section 9 of the Jump-Start Rules (p. 5) and pick a scenario. Then:

- (a) Read through the rules once.
- (b) Lay out your road sections.
- (c) Select your vehicles from the Stock Vehicle List. Make a record sheet (blank vehicle record sheets are on p. 6) for each car and pick a counter to represent it. Put speed markers on each record sheet.
- (d) Place all vehicles in starting positions at starting speeds — and go! Highway scenarios are played by placing two or three road sections end to end. When cars leave one end of the map, take a section from the other end and put it in front of them. Road sections and maps are provided in this Deluxe set. Also, various supplements and expansion sets are available at your local hobby store, with more road sections and ready-to-use arenas.

3. Vehicle Selection

The "Stock Car List" (p. 6) gives specifications and prices for a number of standard cars and cycles. Several "options" are listed for some vehicles. All vehicles have been worked out according to the design rules in *Deluxe Car Wars*, so that the cars shown here will be usable with those rules (with a few additions). Sample specifications:

Courier: Luxury size; 12 DP power plant; Armor: F30, R20, L20, B25, T0; Driver and gunner; Mounts one RL front, one MG right, one MG left, one MG back. Costs \$13,000.

Options: (a) Replace rear MG with one HR and a Smokescreen; Saves \$950. (b) Remove the RL, all three MGs, and the gunner. Add two linked lasers firing forward. Costs \$10,200 extra.

The name of the vehicle is given first, followed by car size and the size (number of DP, or Damage Points) of the power plant. Armor is listed next, with the number of points of armor on each of the car's five targetable sides: (F)ront, (R)ight, (L)eft, (B)ack, and (T)op. "Driver and gunner" indicates that the car has a two-man crew. A weapons list follows, with the positions they occupy (one RL, or Rocket Launcher and three MGs, or Machine Guns). Weapons are followed by the cost of the vehicle. "Options" are changes the player may make to a car, at the cost or savings indicated.

After a car is selected, make up a record sheet for it as shown below. The record sheet will show all modifications, options, and damage.

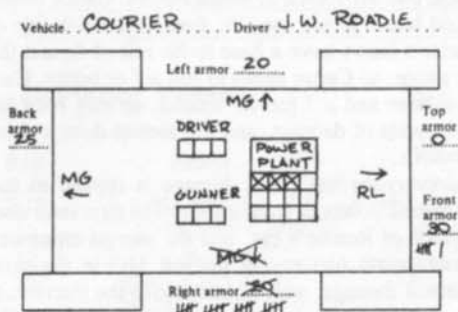

This record sheet shows a Courier (stock, no options) after a brief combat. All the armor on the right side has been destroyed, eliminating the right side machine gun. The front armor has taken six hits. The power plant has also taken three hits. The driver and gunner have no

body armor (see "Accessories," p. 6) so they can take only three hits — therefore they are shown with only three damage boxes apiece.

4. Movement and Scale

The road sections are marked with a grid to control movement. The heavy lines are 1" (15 feet) apart. The light lines are 1/4" (3.75 feet) apart. Each turn is divided into ten "phases" of 1/10 second each.

A vehicle's speed determines how many times it will move in a turn. A vehicle must move 1" for every 10 mph of its speed, moving once per phase until it has moved its full movement. For example, a car moving 30 mph would move in phases 1, 2, and 3, and would be immobile for the rest of that turn. Cars move in order, with the car going fastest moving first. Vehicles moving at the same speed roll randomly to see who moves first.

5. Acceleration and Deceleration

At the beginning of each turn, the owner of each vehicle chooses its speed for the turn. All players determine new speeds, move the "speed" marker on the Speed track of their record sheets, and reveal the new speeds simultaneously. A vehicle can (a) accelerate by 10 mph, (b) decelerate by 10 or 20 mph, or (c) stay at the same speed. The top speed for all vehicles is 100 mph.



6. Maneuvers and Control

Straight-line movement is easily calculated, because each car counter is 1" long (the distance normally moved in one phase), while each cycle counter is 1/2" long. By setting one counter in front of another, you can figure easily where each vehicle will go on a straight course.

To change direction, a vehicle must execute a "maneuver." Maneuvers may only be made in a phase in which the vehicle moves, and only one maneuver can be made per phase. Maneuvers are executed in place of the normal 1" straight-line move. The first maneuver of a turn is without risk, but for the second and each subsequent maneuver, the driver must roll two dice and check the Control Table (p. 5) to see if he loses control of the vehicle.

If a vehicle rolls anything other than a "no effect" on the Control Table, the vehicle has gone out of control. Results range from fishtailing to crashing and burning. Full instructions for loss of control results will be found with the Control Table.

The maneuvers are:

Drift: The vehicle moves forward 1" and up to 1/2" to either side, while keeping the same orientation.

Swerve: The vehicle moves 1" ahead, and is then positioned by its owner so that (a) one rear corner of the counter stays in the same square, and (b) the corner diagonally opposite moves one or two squares in any direction. Diagonally adjacent squares are legal.

Pivot: This can only be made by a vehicle moving 10 mph. The vehicle moves 1/2" ahead, and may then be turned any amount, in any direction, while holding one rear corner in place.

Cars (not cycles) can back up at 10 or 20 mph. A car must stop completely for one turn to change from forward to reverse or back again.

Example

J.W. Roadie, in the damaged Courier in "Vehicle Selection" (above), has decided to turn and run. His speed is 40, and he has moved twice this turn, straight once and maneuvering once. In Phase 3, Roadie wants to swerve left, to hide his vulnerable right side. He moves the Courier forward 1", holds the left rear corner down, and moves the right front corner two squares to the left. Roadie has already used up his "free" maneuver for the turn, so he must roll on the Control Table. He rolls a 10 (on two six-sided dice) and adds 2 to this for his 40 mph speed, resulting in a 12. Twelve on the Control Table indicates a "skid." The Courier moves 1" in the direction it was pointing at the beginning of the phase. Normally, the Courier would move once more in this turn, but the skid eliminates the next move (Roadie spent it skidding), so it does not move in the next phase (Phase 4). If Roadie's car were going 50 mph, it would move in Phase 5.

7. Crashes and Collisions

When a vehicle counter touches a fixed object or another vehicle counter, a collision has occurred. To determine how much damage is done in a collision, you must figure out the "collision speed." Collision speed is the difference in speed between the colliding objects. If the cars are going the same direction (or almost the same), subtract the lower speed from the higher speed. If they hit head-on, add the two speeds. If they strike at right angles, use the speed of the car that moved most recently. For every 10 mph of the collision speed, each participant in the collision takes one die of damage to the side struck. Cycles do only 1/3 of this damage to whatever they hit.

8. Combat

Combat takes place whenever one vehicle fires at another. It may occur in any phase, after all movement is completed. The player simply announces that he is firing and names the weapon and target. All fire is resolved simultaneously after everyone has had a chance to declare a firing action.

A given weapon may never fire more than once in the same turn. A given character (driver or gunner) may never fire more than once per turn, unless he does so by triggering two linked weapons on the same turn. Linked weapons must be fired at the same target. If every person in a vehicle is unconscious or dead, it cannot fire.

Targeting

To fire at a given target, there must be a "line of fire" from the firing counter's center (for a turret weapon) or the middle of the side where the weapon is (for other weapons) to any part of the target counter. Line of fire may not cross any part of any counter (except smoke) on its path from the weapon to the target. Exception: Turret weapons may fire across the car counter they're mounted on, in any direction.

A vehicle has front, back, right, and left sides. When you fire at a vehicle, you may hit only a side facing you. Usually you will be able to choose between two sides. You must choose one specific target. If a car has a turret, the top may be targeted instead of the side of the car. The "to-hit" roll for this is at -2 (see "Calculating Hits" below), due to the low profile of the turret.

Calculating Hits

When a weapon is fired, the attacking player rolls two dice to see whether he has hit his target. He must make the to-hit roll or higher for that weapon, as shown on the Weapons Chart (page 5). Accuracy is affected by several factors; these are listed on the Weapons Chart. Regardless of bonuses, a roll of 2 always misses! Smokescreens do not need to roll to hit — they just produce a cloud when fired.

Calculating Damage

When a weapon hits, calculate the amount of damage by rolling the number of dice shown on the Weapon List. The result is the number of hits taken by the target.

Each component of a vehicle can take a certain amount of damage. Armor is lost a point at a time, and when the last point of armor on a

side is destroyed, the weapons on that side of the vehicle are destroyed, too. Top armor protects weapons in the turret (if any) in the same way. The vehicle description in the Stock Car List includes damage boxes for the power plant (DP); power plants work at full efficiency until all of their DPs are gone. Humans are wounded by the first point of damage, knocked unconscious (incapacitated) by the second, and killed by the third. Wounding a driver forces him to make a roll on the Control Table.

Location of Damage

Damage is taken first by the armor on the side hit. When this is gone (destroying the weapons on that side), remaining damage has an equal chance of hitting the driver (on a roll of 1 or 2 on one die), the gunner (3 or 4), or the power plant (5 or 6). If there is further damage, or if you roll a component that is missing or destroyed, the weapons on the opposite side of the car are destroyed; then the armor on that side takes all the remaining damage. Exception: When all top armor is destroyed, turret weapons are eliminated, but any further damage passes over the car without effect.

If the power plant is destroyed, the driver may still steer and maneuver, but the car must decelerate by at least 10 mph each turn. If a vehicle's driver is incapacitated, it will continue in a straight line, decelerating at 10 mph per turn. If there is a gunner, he may continue to fire weapons, but he may not control the vehicle in any way.

Smokescreens

A smokescreen is fired like any other weapon, but produces a cloud of dense smoke that obscures vision, lasting 60 seconds. Any vehicle tracing a line of fire through a smoke cloud subtracts 2 from the to-hit roll for each cloud in the way. Lasers cannot fire through smoke. When smoke is fired, lay a smoke counter behind the vehicle, as shown:

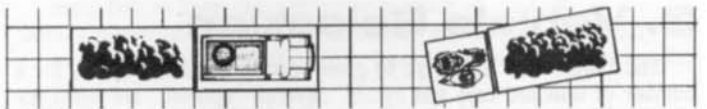

The smoke counter does not move.

Example of Combat

Our friend Roadie (from the previous example) has managed to turn his left side to his opponent, but he's not out of the woods yet. His opponent, "Killer" Carter, in a Courier with option (b), going 60 mph, has charged up to within 6" of Roadie, facing him head-on. At this point, both players decide to fire. Roadie fires his left-side machine-gun at the front of Carter's Courier, hoping to take out Carter's weapons. The base chance for an MG to hit is to roll 7 or more on two dice. Modified for range (4" to 7.99": -1 from the roll) and for firing at the front (another -1 from the roll), Roadie needs to roll a 9 or better. He rolls an 11, and hits easily. Machine-guns do 1 die of damage, and Roadie rolls a 2. This is written down on a piece of scratch paper, to be applied to the front armor of Carter's car after everyone has fired. Unfortunately, Carter has a lot of front armor left, so 2 hits won't penetrate.

Roadie's gunner fires the rear MG (the left MG can't be fired again this turn) at the same target. He also needs a 9 or better, for the same reasons Roadie did. He rolls a 7, which misses. Carter returns fire with the two linked lasers in his car. He fires at the left side of Roadie's Courier. Carter's lasers have a base to-hit roll of 6, and there's a -1 modifier for range, so Carter needs to roll a 7 or better. Carter rolls an 8 for the first laser and a 7 for the second, so they both hit. The first laser does 11 points of damage, and the second does a phenomenal 17 points (on 3 dice).

Now that everyone has fired, damage is applied to the sides hit. Carter's car loses 2 points of front armor. The first laser does 11 points to the left armor of Roadie's car, and the second eliminates the 9 remaining armor points (destroying the left MG in the process). This leaves 8 points of damage, which penetrate to the interior. Carter rolls one die to see which internal component is hit. He rolls a 2, indicating the driver. Bye, bye, Roadie! Roadie takes 3 hits and dies. The remaining 5 points of damage continue through, flying out the unarmored right side of the car. At this point, Roadie's Courier is uncontrolled, and his gunner is having second thoughts about the whole affair.

9. Scenarios

The *Car Wars* Jump-Start Rules offer a great variety of possible games. Before any game, you must make certain decisions about the "scenario" to be played:

- Which vehicles will be used? For example, you might give each player a large budget (say \$40,000) and allow him to outfit as many or as few vehicles as he likes.
- Where will the vehicles start, and at what speeds?
- Will the players get to see each other's record sheets before play, or will they find out "the hard way" what their opponents have?

Some sample scenarios

Road Duel: Two-player road combat — one car each. Each player gets a fixed budget (\$10,000 and \$15,000 are both good) to pick a car with whatever options and accessories the budget allows. Players roll randomly to see which car starts in front. Roll again (2 dice) to determine starting distance: 2 to 12 inches. Both cars start out going the same direction at 60 mph. The survivor wins.

Pack Attack: Multi-player road combat. One player gets \$17,000 for one car from the Stock Car List. The other players share \$25,000 and must pick at least 5 cycles from the Stock List. The lone vehicle starts with a 12" lead with all vehicles going 80 mph. The cycles win if they destroy the lone vehicle. The car wins if all the cycles are destroyed, or if he increases his lead to more than 30".

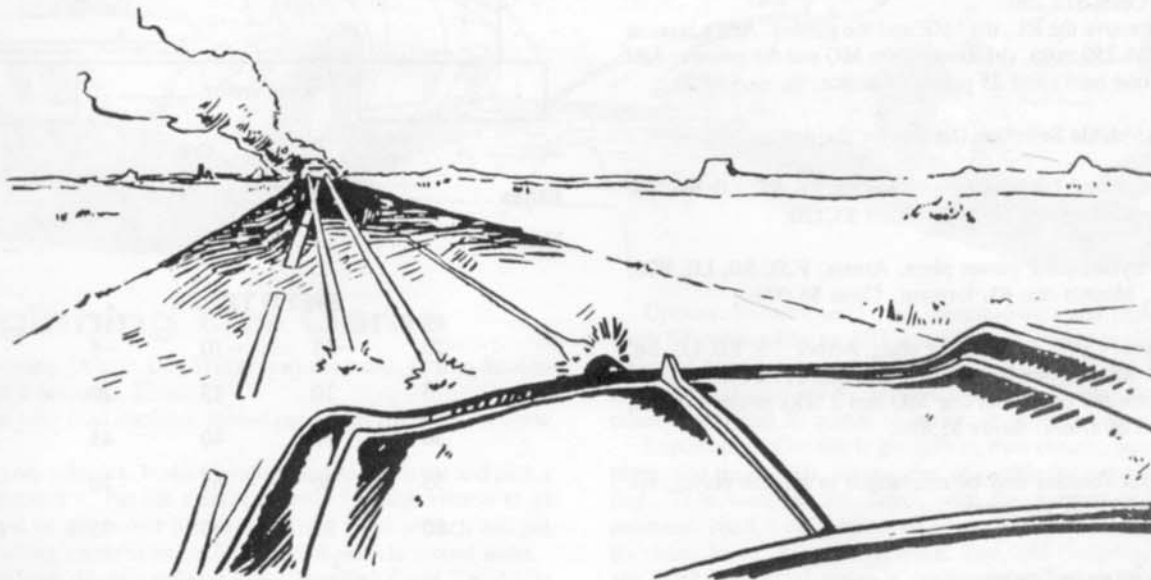

Charts

Weapons Chart

Weapon	To hit	Damage
Machine Gun (MG)	7	1 die
Rocket Launcher (RL)	8	2 dice
Laser	6	3 dice
Smokescreen	—	smoke
Heavy Rocket (HR)	9	3 dice

Notes: The laser cannot be fired through smoke; the heavy rocket can only be fired once.

To-Hit Modifications

Point-Blank Range: If range (measured from the edge of the firing vehicle to the edge of the target counter) is less than 1", the player adds 4 to his to-hit roll.

Long Range: Subtract 1 from the roll for every full 4" of range. Below 4" is no subtraction; 4" to 7.99" is -1; 8" to 11.99" is a -2, and so on.

Target: Subtract 1 if firing at the body of a compact or a sub-compact. Subtract 1 if firing at a vehicle's front or rear (as opposed to the left or right sides). Subtract 2 if firing at a cycle or a car's turret.

Stationary Vehicles: Add 1 if the firing vehicle is not moving, 1 if the target is not moving, or 2 if neither are moving.

Smoke: Subtract 2 for each smoke cloud your line of fire passes through.

Computer: This can add 1 or 2 to your roll — see "Accessories," above.

All modifications are cumulative. For example, firing at the front (-1) of a moving compact (-1), at a range of 7" (-1), with a machine gun (7 to hit), while your vehicle is stationary (+1), works out to a roll of 9 or more needed to hit. A roll of 2 always misses.

Control Table

Roll	Effect
2-10	No Effect
11	Fishtail
12	Skid
13	Fishtail and Skid
14 or more	Crash and Burn

Roll 2 dice and add 1 for every full 20 mph of the vehicle's speed. If the vehicle is a motorcycle, add 2 to the roll. Results are as follows:

No effect: Nothing happens, continue normally.

Skid: The car counter is moved 1" in the direction it was going at the beginning of the phase. The skidding vehicle skips the next phase of movement.

Fishtail: While holding one front corner down, move the corner diagonally opposite two squares to the side. Roll randomly to see whether to move the vehicle's rear left or right.

Fishtail and Skid: Execute a fishtail and a skid, as described above.

Crash and Burn: The vehicle stops where it is and is replaced by a wreck counter. All occupants are killed. You lose.

Stock Car List

Killer Kart: Subcompact, 8 DP power plant, Armor: F6, R4, L4, B4, T0. Driver only. Mounts one MG firing forward. Costs \$3,848.

Mini Sherman: Compact, 10 DP power plant, Armor: F35, R25, L25, B33, T0. Driver only. Mounts 2 linked MGs firing forward, and a smokescreen in back. Costs \$7,334.

Options: (a) Replace both MGs with one RL (front) and 25 points of armor anywhere. Saves \$1,325. (b) Replace one MG with one HR (front) and 16 points of armor. Saves \$1,092.

Rocket Special: Mid-size, 12 DP power plant, Armor: F40, L35, R35, B35, T30. Driver and gunner. Mounts one RL forward and one MG in a turret. Costs \$12,250.

Options: (a) remove the RL, the MG, and the gunner. Add a laser in the turret. Costs \$4,250 extra. (b) Remove the MG and the gunner. Add 3 HRs (2 front, one back) and 25 points of armor. Saves \$1,500.

Courier: See Vehicle Selection (above) for the description.

Shogun 100: Cycle, 2 DP power plant, Armor: F6, R0, L0, B6, T0. Driver only. Mounts one MG forward. Costs \$3,120.

Shogun 220: Cycle, 3 DP power plant, Armor: F20, R0, L0, B20, T0. Driver only. Mounts one RL forward. Costs \$4,090.

Firelight Deluxe: Cycle, 5 DP power plant, Armor: F6, R0, L0, B6, T0. Driver only. Mounts one laser forward. Costs \$11,244.

Option: Replace the laser with one MG and 2 HRs firing forward, and add 17 points of armor. Saves \$5,896.

Armor on stock vehicles may be rearranged to suit the player, but cycles never have side or top armor.

Accessories

These items may be added to any stock vehicle — at extra cost.

Targeting Computer: A computer works for one person in a car or cycle and adds 1 to all to hit rolls when that person fires the vehicle's weapons. These cost \$1,000 each.

Hi-res Targeting Computer: Just as above, except that it costs \$4,000 and adds 2 to hit rolls.

Body armor: Woven plastic-cord body armor costs \$250. It takes 3 hits of damage before it becomes useless — thus, it effectively doubles a person's DP from 3 to 6.

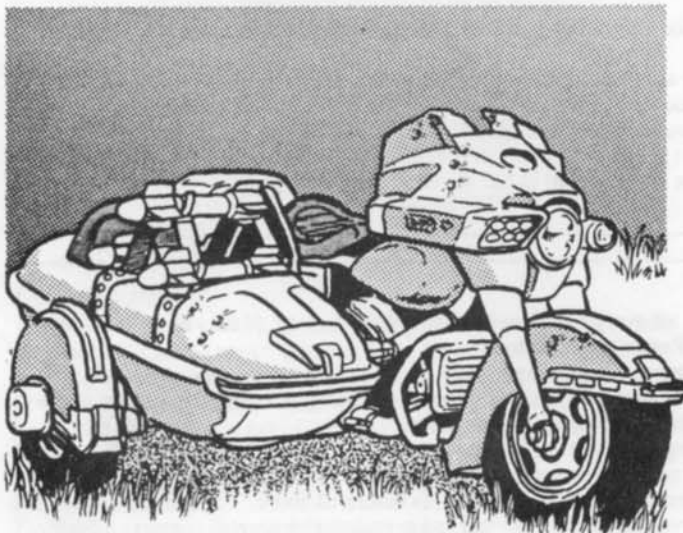

VEHICLE RECORD SHEET

Vehicle Driver

	Left armor	
Back armor		Top armor
		Front armor
	Right armor	

Size Cost

Extras

Notes

SPEED TRACK

-20	-15	-10	-5	0
5	10	15	20	25
30	35	40	45	50
55	60	65	70	75
80	85	90	95	100

VEHICLE RECORD SHEET

Vehicle Driver

	Left armor	
Back armor		Top armor
		Front armor
	Right armor	

Size Cost

Extras

Notes

SPEED TRACK

-20	-15	-10	-5	0
5	10	15	20	25
30	35	40	45	50
55	60	65	70	75
80	85	90	95	100

III. Getting Started

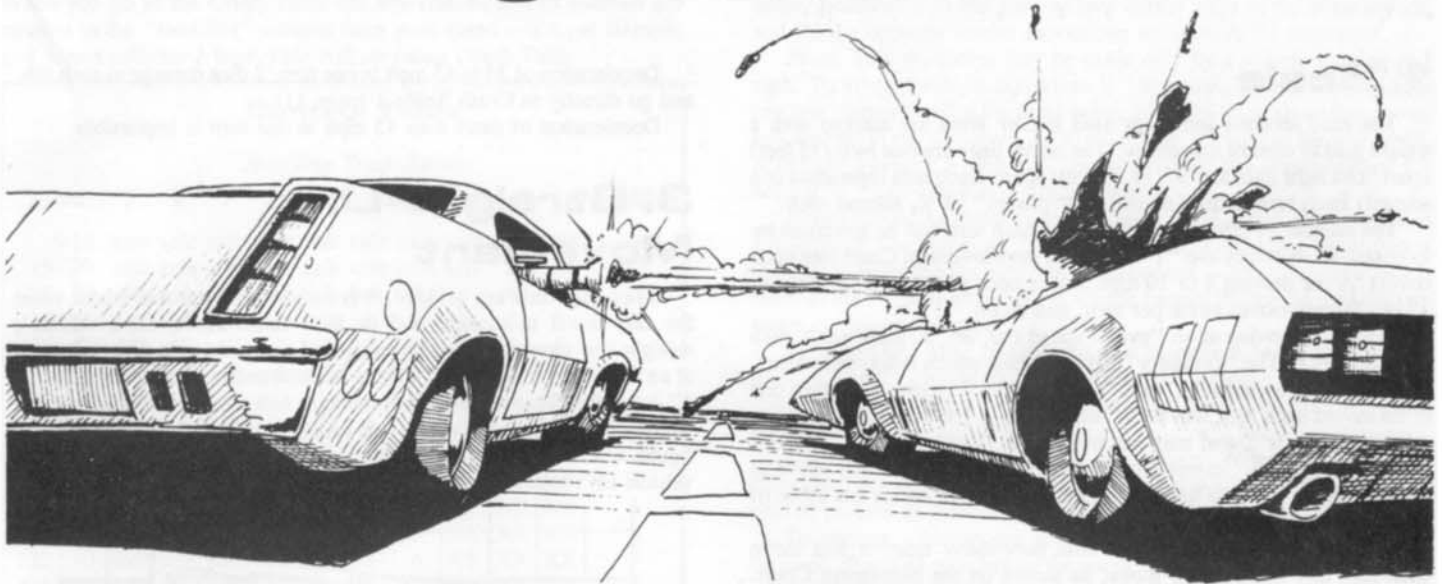

1. Beginning the Game

To start playing *Deluxe Car Wars*, read the rules, turn to Section XIV, and pick a scenario. Then:

- Lay out your road sections, spread out one of the maps, or draw up your own.
- Select your vehicles. Make a record sheet for each car and pick a counter to represent it. Put the marker counter for each vehicle at its beginning speed on the master Movement Chart (back cover), and put speed and handling markers on each individual vehicle record sheet.
- Roll for each driver's reflexes (see "Handling Class," p. 10, in Section IV, *Movement*). Reflexes of characters other than drivers do not count in this game.
- Place all vehicles in starting position — and go.

Laying Out the Game Board

For highway scenarios, place two or three road sections end to end. When the cars leave one end of the map, pick up the section on the other end and put it in front of them so they don't run out of road.

For city battles, just tape down the two halves of the Midville, Ohio map provided with this set. Likewise, the map of a "typical" truck stop in 2035 can be used.

For other fixed-area scenarios (like arenas, parking lots or obstacle courses), draw the whole layout on 1/4" graph paper and tape it to the table. Such a layout should show roads, curbs, debris, etc., and the nature of off-road terrain (sidewalks, buildings, etc.). This will be important when cars leave the road (see Section IV, *Movement*). Any graph paper ruled in 1/4" squares will work. *Car Wars* Map Sheets, blank 22" x 32" sheets marked off in 1/4" squares, are also available, as are a number of other supplements and expansion sets for *Car Wars*.

2. Vehicle Selection

The "stock car shopping list" (see Section XV, *Sample Vehicles*) gives specifications and prices for a number of standard vehicles. Several "options" (tradeoffs, with or without differences in cost) are listed for each vehicle. All vehicles have been worked out according to the vehicle construction rules (see Section VIII, *Car Design*). Vehicle design is complex. You will want to use "stock" cars the first few times you play.

Sample Specifications

Hotshot: Luxury size, x-hvy. chassis, hvy. suspension, super power plant, 4 puncture-resistant tires, driver only. 2 MGs linked front, 2 FTs linked back, one FT right, one FT left. Armor: F20, R10, L10, B20, T10, U10. Fire ext. Accel. 5, HC 3, \$14,600, 6,600 lbs.

Options: Remove any or all flamethrowers and replace with MGs. Each FT replaced by an MG saves enough weight to allow an extra 30 points of armor. For each FT replaced by an MG and 30 points of armor, the cost goes up by \$1,350. One rear FT may be replaced by a minedropper and 30 points of armor, at an extra cost of \$850.

Explanation: *Car size* is given first; then chassis, suspension, power plant, and tires. Next, the number of people the car can hold is specified. Then *weapons* are listed, with the position in which each is mounted. Next is the number of *armor points* on each of the vehicle's six sides: Front, Right, Left, Back, Top, and Underbody. Accessories are listed last. *Acceleration* is explained in Section IV; *handling class* affects maneuverability, and is also explained in Section IV. The *price* is the vehicle's "sticker cost," and includes a full load of ammunition. *Weight* is a vehicle's total weight with all seats filled and a full load of ammunition. *Options* are changes a player can make in a car without special reference to the Car Design section; they've already been checked. If no price differential is given, an option does not change a car's cost. Note that some changes (e.g., targeting computers, different suspensions) affect only a car's price — not its weight or available space — and may be added to any vehicle by paying the cost shown on the Accessories sheet, without other calculations.

After a car is selected, make up a record sheet for it as shown below. The record sheet will show any modifications, options, ammunition remaining, damage taken, etc., in a pictorial fashion.

The sample record sheet below shows a Hotshot (stock, no options) after a brief combat. All the armor on the right side has been destroyed, and the right FT has taken one hit of damage. The right front tire has taken 3 hits, and the front armor has taken 4 hits. There is no other damage. The front MGs have fired three times each, and the right FT has fired twice (shown by tally marks). The driver has no body armor, so he can take only 3 hits — therefore he is shown with only 3 damage boxes.

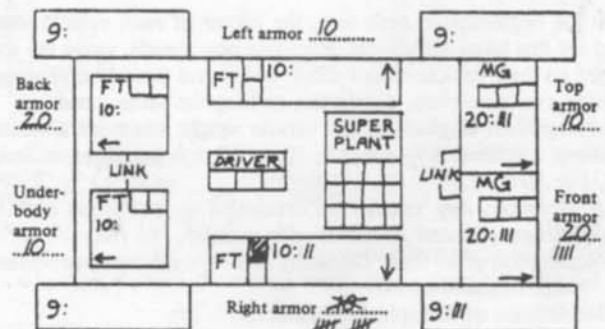

IV. Movement

1. Scale

The road sections and maps used in *Car Wars* are marked with a square grid to control movement. The heavy lines are one inch (15 feet) apart. The light lines are $\frac{1}{4}$ " (3.75 feet) apart. Each turn represents one second. Each turn is divided into ten "phases" of $\frac{1}{10}$ second each.

The number of times a vehicle moves each turn will be governed by its speed, as shown by the "1" marks on the Movement Chart (see back cover). A car moving 5 or 10 mph moves once per turn, a car moving 15 or 20 mph moves twice per turn, and so on.

If a car is moving at an "even" speed (10, 20, 30 mph, etc.), then all its moves will be "ordinary" moves during which it may maneuver. If a vehicle is moving at an "odd" speed (5, 15, 25 mph, etc.), then one of its moves each turn will be a "half-move." The vehicle must move straight ahead $\frac{1}{2}$ ", and may not maneuver. (Exception: See "Pivot" under "Maneuvers" in this section.) The player may take any move as his half-move, but if he has not made his half-move by his last move of the turn, he *must* take it then.

A vehicle's speed determines both how many times it will move each turn and when it will move, as shown on the Movement Chart. There are ten "phases" during each turn. During each phase, vehicles of certain speeds may move. For instance, vehicles going 30 mph will move during phases 3, 6, and 9, as shown by the "1"s on the chart.

Vehicles traveling in excess of 100 mph will move more than one inch in some phases. In the phases marked by a "2" on the Movement Chart, a vehicle going faster than 100 mph must move 2 full inches. A vehicle traveling at an "odd" speed greater than 100 (105, 115, 125 mph, etc.) must make a "one-and-a-half" move sometime during the turn. The one-and-a-half move can be made in any phase marked by a "2" on the Movement Chart, but if the player has not made the one-and-a-half move by his last "2" phase of the turn, he must make it then.

A vehicle may only make one maneuver per phase.

At the beginning of each turn, after vehicles set their speeds, the control marker for each vehicle is moved to its new speed on the master Movement Chart. A marker is then placed at the top of the chart at Phase 1 and moved along. When a mark appears in the row for a vehicle's speed, that vehicle moves in that phase. One player may keep track of this, calling out the moves; i.e., "Phase 3. Car 12 moves, then 6, then 10."

Often, vehicles of different speeds will move during the same phase. For instance, all cars moving 45 mph or faster will move in Phase 1. When vehicles move during the same phase, the faster one moves first. For vehicles traveling the same speed, the one whose driver has the faster reflexes (see Section VII, *Continuing Characters*) may choose when he wants to move.

A vehicle must move when the movement chart tells it to, and may never move at any other time.

2. Acceleration and Deceleration

At the beginning of each turn, the owner of each vehicle sets its speed for that turn. All players determine new speeds, move the speed counter on their vehicle record sheet, and reveal them simultaneously. Vehicles may accelerate, decelerate, or keep the same speed.

Acceleration: Engine size and vehicle weight determine a vehicle's maximum acceleration — either 5, 10, or 15 mph per turn (see Section VIII, *Car Design*).

Deceleration: Any vehicle can decelerate up to 15 mph each turn without danger. Greater deceleration is possible, but risky:

Deceleration of 20 mph: Difficulty 3 (D3) maneuver (see "Maneuvers," later this section).

Deceleration of 25 mph: D5 maneuver.

Deceleration of 30 mph: D7 maneuver, and each tire takes 1 die of damage (see instructions for recording damage in Section V, *Combat*).

Deceleration of 35 to 45 mph in one turn: 2 dice damage to each tire, and go directly to Crash Table 1 (page 11).

Deceleration of more than 45 mph in one turn is impossible.

3. Straight-Line Movement

Since the roads are gridded, it is easiest to figure movement when the cars travel in straight N-S or E-W lines. However, a vehicle's straight-line movement can be calculated precisely even if it is moving at an angle to the grid lines. This is because each car counter is exactly 1" long (the distance normally moved in one phase), while each cycle counter is $\frac{1}{2}$ " long. By setting one counter in front of another, you can figure where each vehicle will go on a straight course — even if the vehicle isn't following N-S or E-W lines.

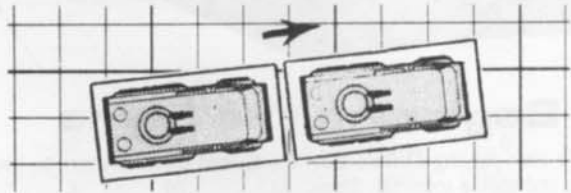

4. Maneuvers

Any change of vehicle direction is called a *maneuver*. Each maneuver has a difficulty class. The more difficult a maneuver, the more likely the vehicle will skid, flip, etc. Maneuvers at low speed are easy. As speed goes up, danger increases.

When maneuvers are made in rapid succession, the danger increases. The increasing danger is indicated by the Handling Track on a vehicle record sheet. At the beginning of the game, each "handling" counter starts at that vehicle's handling class, as modified by the driver's reflexes (see Section VII, *Continuing Characters*). Each maneuver or hazard causes the marker to move down. And each time the marker moves, the player must roll on the Control Table to see if he loses control. If he loses control, he will have to roll on one of the Crash Tables.

Control Table

Cross-index the handling status of your vehicle (from the Handling Track) with its speed, and roll one die. If you roll the *number shown or higher* you keep control of the car. If you roll lower, you lose control.

If you lose control, go to the appropriate Crash Table (No. 1 for maneuvers, No. 2 for hazards). "Safe" means you cannot crash.

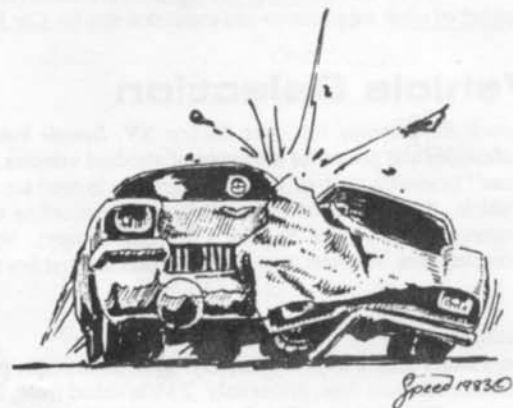

"XX" means you lose control automatically — go to the Crash Table. When you go to the Crash Table for any reason, add or subtract the number in the "modifier" column from your speed — i.e., at 20 mph, you would subtract 2 from your roll on either Crash Table.

Control Table											
Handling Track Status											
Speed	3	2	1	0	-1	-2	-3	-4	-5	-6	modifier
5-10	safe	safe	safe	safe	safe	safe	safe	safe	safe	safe	—
15- 20	safe	safe	safe	safe	safe	safe	safe	safe	2	2	—
25- 30	safe	safe	safe	safe	safe	safe	2	3	4	4	-2
35- 40	safe	safe	safe	safe	safe	2	2	3	4	5	0
45- 50	safe	safe	safe	safe	safe	2	2	3	4	6	1
55- 60	safe	safe	safe	safe	safe	2	3	4	5	6	1
65- 70	safe	safe	safe	safe	2	2	3	4	5	XX	2
75- 80	safe	safe	safe	safe	2	3	4	5	6	XX	2
85- 90	safe	safe	safe	safe	2	3	4	5	XX	XX	3
95-100	safe	safe	safe	safe	3	4	5	6	XX	XX	3
105-110	safe	safe	safe	2	3	4	5	6	XX	XX	4
115-120	safe	safe	safe	2	3	4	5	XX	XX	XX	4
125-130	safe	safe	safe	3	4	5	6	XX	XX	XX	5
135-140	safe	safe	2	3	4	5	XX	XX	XX	XX	5
145-150	safe	safe	3	4	5	6	XX	XX	XX	XX	6
155-160	safe	safe	3	4	5	XX	XX	XX	XX	XX	6
165-170	safe	2	3	4	5	XX	XX	XX	XX	XX	7
175-180	safe	2	3	4	XX	XX	XX	XX	XX	XX	7
185-190	safe	2	3	4	XX	XX	XX	XX	XX	XX	8
195-200	2	3	4	XX	XX	XX	XX	XX	XX	XX	8

The row used on the Control Table depends on the vehicle's speed. The column depends on its current handling status. A handling status of 4 or better is always safe. Handling status cannot get worse than -6, but a vehicle at -6 must still roll on the Control Table for each new maneuver.

Example: During one turn, a car traveling 60 mph attempts three maneuvers. Its handling class is 2, so the marker starts at 2. The first maneuver is a "drift" (Difficulty 1). Subtract 1 from handling status, moving the marker to 1. No roll is required for control. The second maneuver is a "steep drift," which is D3. Subtracting 3 from handling status moves it to -2, requiring a control roll on the -2 column. The third maneuver is another drift — D1 again. Subtract one more from handling status and roll again, this time on the -3 column of the Control Table. At the end of the turn, each vehicle will regain some points on its handling track.

The Handling Track is adjusted upward at the end of each turn — that is, once per second. This simulates the driver's ability to regain control of a vehicle over time. The amount the track is adjusted upward is the basic Handling Class of the vehicle plus the driver's skill bonus (if any). The Driver skill is explained in Section VII, *Continuing Characters*. The amount the track is adjusted can never be lower than 1 — you will always recover at least one point on the handling track at the beginning of each turn. A vehicle's Handling Track can never be adjusted above its starting handling class.

The maneuvers (shown pictorially at right) are:

Bend: The vehicle goes from Position A directly to position B in one phase. This 45-degree turn is a Difficulty 3 (D3) maneuver. If the driver executes a second "bend" in the next movement phase, it will take the vehicle to C, completing a 90-degree turn.

Tight Bend: The vehicle goes from Position D to Position E in one phase. This 90-degree turn is a D6 maneuver.

Drift: The vehicle moves 1" forward and ¼" (or less) to either side, while facing the same direction. This is a D1 maneuver.

Steep Drift: The vehicle moves 1" forward and between ¼" and ½" to one side. This is a D3 maneuver.

Swerve: The vehicle moves one car-length ahead, and is then positioned so that (a) one rear corner of the counter stays in the same square, and (b) the corner diagonally opposite moves into an adjacent square (including diagonally adjacent squares). Subject to these restrictions, the counter may be placed as the player wishes. A D1 maneuver.

Hard Swerve: As above, but after the vehicle moves ahead 1", its own positions it so that (a) one rear corner stays in the same square, and (b) the opposite corner moves two squares. A D3 maneuver.

Pivot: This maneuver may be made only by a vehicle moving at 5 mph. To pivot, a vehicle (a) moves ¼" in a straight line, and (b) keeps one rear corner fixed at the same point, while pivoting about that corner any amount in any direction. A D0 maneuver, because of the low speed. A vehicle traveling 5 mph may choose between this maneuver and the normal ½" half-move in a straight line.

Deceleration: As mentioned previously, rapid deceleration counts as a maneuver. The Handling Track marker is adjusted at the beginning of the turn — when the deceleration is announced — and the control roll is made at the original speed. All this must happen before the vehicle may move or fire on that turn.

Evening-Out: After coming out of a maneuver parallel to the grid lines, a counter may be moved a fraction of a square in any direction (owner's choice) to get it exactly on the grid lines. This does not affect speed or handling, and is a D0 maneuver.

The Bootlegger Reverse: The bootlegger reverse is a special maneuver: the old moonshiner's trick whereby a car uses a controlled skid to reverse its direction. It works, but it's dangerous.

To attempt a bootlegger reverse, a vehicle must start the turn at between 20 and 35 mph before the acceleration/deceleration phase. You can't slow to 35 and then try a reverse, all in one turn.

On the phase that a vehicle starts a bootlegger reverse, it skids from N to O on the diagram. This is a D7 maneuver, and puts 1 point of damage on each tire. If the vehicle goes out of control at this point and/or loses a tire, it will roll or skid in the direction shown by the heavy arrow. Its speed will be 0 at the beginning of the next turn. If the vehicle does not go out of control, it will automatically go to P on its next movement phase, and stop (speed goes to 0), facing the way it came.

Once a vehicle begins a bootlegger reverse, it may fire no weapons until it stops moving (the occupants are too busy). Weapons on automatic (see Section V, *Combat*) will still fire. Cycles may not try this maneuver.

Maneuvers

Fig. 1: BEND (D3)

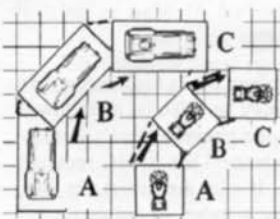

Fig. 2: TIGHT BEND (D6)

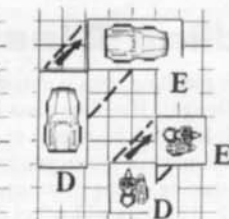

Fig. 3: DRIFT (D1)

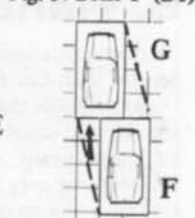

Fig. 4: STEEP DRIFT (D3)

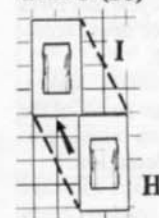

Fig. 5: SWERVE (D1)



Fig. 6: HARD SWERVE (D3)



Bootlegger: The vehicle goes from Position N to Position O in one phase. This 90-degree turn is a D7 maneuver.

Fig. 7: BOOTLEGGER (D7)

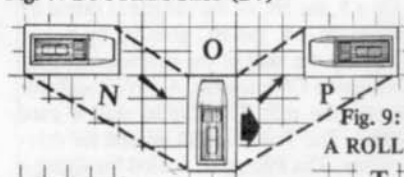

Fig. 8: SKIDDING ½" (crash result)

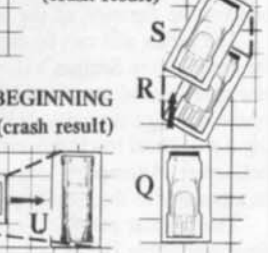

Fig. 9: BEGINNING A ROLL (crash result)

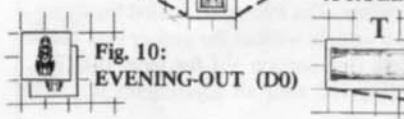

Fig. 10: EVENING-OUT (D0)



Movement in Reverse

Any vehicle except a cycle may move in reverse at up to 20 mph. A vehicle may not go from forward to backward speed (or vice versa) without stopping for one turn. Acceleration rules are the same as for forward movement. Any maneuver can be made in reverse; the difficulty class is one higher.

Using the Turning Key

Included in *Deluxe Car Wars* is an extremely handy turning key, which can be used to make any maneuver except the bootlegger reverse and the pivot. To make the maneuver you want, place the key next to the counter at the point that corresponds to the maneuver you wish to make. Then move the vehicle along the edge of the turning key, and presto! Instant maneuver. Here are some pictorial examples:

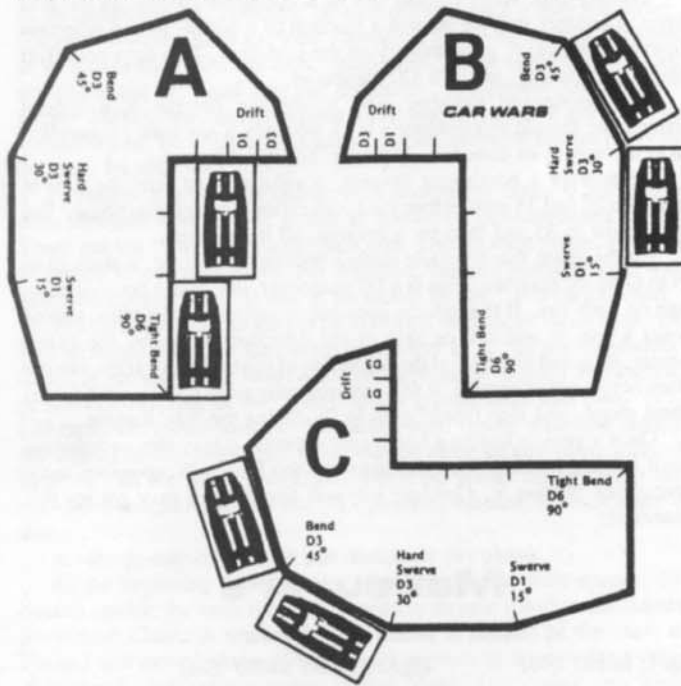

5. Handling Class

A vehicle's basic handling class is determined by its suspension (see Section VIII, *Car Design*). Handling class may be affected as follows:

Any vehicle that loses all its wheels in one position (that's usually just one, but could be more in some circumstances) has its HC reduced by 3 permanently, starting on the next turn. If only the tire(s) are lost, HC drops by only 2. This loss will affect the number of points recovered each turn on the Handling Track. When all the wheels or tires on a corner are lost, the vehicle's handling status drops to -6 immediately.

Any vehicle that loses wheels on two corners (or any cycle that loses a wheel) goes to Crash Table 1 (p. 11). It may no longer steer, accelerate, or brake. It must decelerate by 30 mph each turn.

All damage done to tires by maneuvers, debris, obstacles, spikes, mines, enemy gunfire, etc., is assessed against the damage points of the tire. If the final damage that destroys the tire comes from mines, grenades or enemy gunfire, then the entire wheel is considered lost.

Any vehicle driven by a character with very good reflexes will have an improved handling class. At the beginning of each combat, every driver of a vehicle rolls one die. This is called a reflex roll: A 5 or a 6 indicates exceptional reflexes. On a 5, the HC of the vehicle is raised by one for the duration of the combat; on a 6, the HC goes up by 2.

The reflex roll can be modified by the skill of the character driving the vehicle (see Section VII, *Continuing Characters*). A Driver +2, for example, would get to add 2 to the die roll. The Cyclist skill is used when driving a motorcycle or trike. The Trucker skill is used for driving a ten-wheel truck, big rig, or bus. The Pilot skill is used for flying a helicopter. Attempting to drive a vehicle without the proper skill results in a penalty to the handling class (see Section VII for more details).

The highest possible beginning HC after all adjustments is 5. The lowest possible HC is -3.

6. Hazards and Road Conditions

Hazards are outside events (enemy fire, for instance) that can affect vehicles. They are treated like maneuvers — each one has a difficulty rating. Road Conditions (like oil, ice, or rain) present no danger in themselves but add to the difficulty of any hazard or maneuver the vehicle undergoes. For example:

Hazards

- Colliding with (or sideswiping) any vehicle: D4.
- Hitting curb, obstacle, or pedestrian: D3.
- Hitting loose debris: D1.
- Enemy fire does 1-5 hits of damage: D1.
- Enemy fire does 6-9 hits of damage: D2.
- Enemy fire does 10+ hits of damage: D3.
- Driver injured or killed: D2.

Each enemy attack produces a separate hazard. If a vehicle is struck by three weapons in one turn, each attack would move the handling-status marker down and require a separate die roll on the Control Table. Mines are "enemy fire." Spikes, debris, obstacles, etc., are not.

Road Conditions

- Light rain: adds D1 to any hazard or maneuver.
- Heavy rain: adds D2.
- Gravel on road: adds D1.
- Oil on road: adds D2.
- Light snow: adds D2.
- Heavy snow: adds D3.
- Ice or packed snow: adds D4.

7. Crashes and Collisions

If a vehicle rolls on the Control Table and misses its roll, it has gone out of control. If it lost control during a maneuver, it must roll on Crash Table 1. If it lost control because of a hazard, it must roll on Crash Table 2. Results may range from mild (a light skid) to disastrous (vehicle rolls and burns).





The result of a Crash Table roll is applied at the beginning of the next phase in which a vehicle moves. A vehicle that fishtails may move normally after it fishtails. A vehicle that skids must move straight ahead for the rest of that phase — i.e., if it skids $\frac{1}{4}$ "', it must move $\frac{3}{4}$ "' forward (the direction its nose is pointing) after the skid. If a vehicle is on its half-move, it cannot skid more than $\frac{1}{2}$ "'.

A vehicle that encounters a hazard while skidding or fishtailing must make another control roll, and may lose control again, affecting it on the next phase it moves. No vehicle may skid more than once per phase.

When a vehicle counter touches a fixed object or another counter, a collision has occurred. Even though all *Car Wars* counters are $\frac{1}{2}$ "' wide ($7\frac{1}{2}$ feet in game scale), the referee should use common sense when determining whether a collision has occurred. A motorcycle can squeeze into tighter spots than a truck, even though the counters are the same width. If a player wants to take his motorcycle down a four-foot-wide alley, let him. The driver of a bus won't be able to pull off the same trick.

Collision damage is based on the type of collision, the weight of the vehicles involved, and their relative speeds. To figure out the result of a collision, determine the type of collision (T-Bone, Head-On, Rear-End, or Sideswipe) using the diagrams on p. 12. Every collision can be classified as one of these four types. When a vehicle is driving in reverse, rolling over, etc., designations of "front," "side," etc., are sometimes inappropriate. A rolling car can have a "head-on" collision in which a side strikes first, for example. If a car is doing a bootlegger, figure the leading side as its "front," moving at 15 mph. In general, use common sense in determining the type of collision. Then follow the instructions for that type, and the steps below, to find damage, final speed, and final position for both vehicles.

1) From the Damage Table, find the *Damage Modifier* (DM) corresponding to your vehicle's weight. A Shogun 100 (800 lbs.) has a DM of $\frac{1}{5}$. A Killer Kart (2300 lbs.) has a DM of $\frac{3}{5}$. A Piranha (5995 lbs.) has a DM of 1. A loaded Houston Metal trailer with tractor (weight about 62,000 lbs.) has a DM of 15. (Figure weight at the beginning of a trip; don't bother recalculating every time you expend a shell.) A pedestrian has a DM of $\frac{1}{5}$.

2) When a collision occurs, determine the collision speed according to the formula given under each type of collision. The number of dice of damage a collision of that speed will cause can be found in the far right column of the Movement Chart (see back cover and separate sheet in this set), under the heading, "Ram." Multiply the "ram" damage rolled on the dice by your vehicle's DM. That is the damage you cause to your opponent. The damage you sustain is the product of his DM multiplied by the same base damage rolled.

Example: A Killer Kart (DM $\frac{3}{5}$) collides with a Piranha (DM 1) at a net speed of 40 mph. A 40-mph collision results in 3 dice of damage, and a 14 is rolled. The Kart gives the Piranha ($14 \times \frac{3}{5}$) = 9 points of damage (rounding down). The Piranha gives the Kart (14×1) = 14 points of damage.

Example: A Shogun 100 (DM $\frac{1}{5}$) collides with the Houston Metal rig we mentioned above (DM 15), at a net speed of 10 mph. One die is rolled, and 2 points are subtracted, so that the result will be a 0, 1, 2, 3, or 4. In this case, the result is 3 points of damage. The Shogun gives the rig ($3 \times \frac{1}{5}$) = 1 point of damage. On the other hand, the rig impacts the cycle for (3×15) = 45 points of damage. Even at 10 mph, a big rig can smash a cycle.

Crash Table 1 — Skids & Rolls

- 1, 0, 1 — Trivial skid. The vehicle keeps its same orientation, but moves $\frac{1}{4}$ "' in the direction it was going at the *beginning* of the phase in which it lost control. Therefore, it may skid in a direction other than the one it is pointing — see the illustration under "Maneuvers."**
- 2 — Minor skid. As above, but the vehicle skids $\frac{1}{2}$ "'.**
- 3 — Moderate skid. As above, but the vehicle skids $\frac{3}{4}$ "'.**
- 4 — Severe skid. As above, but car skids 1"' and each tire takes 2 points damage.***
- 5 — Car turns sideways (see "Maneuvers" above) and rolls. The driver is no longer in control. It decelerates at 20 mph per turn. Each phase it moves, it goes 1"' in the direction it was traveling and rolls $\frac{1}{4}$ of a complete roll — i.e., the first phase it moves 1"', turns sideways, and rolls on its side; the next phase it moves, it goes 1"' and rolls onto its top, etc. It takes 1 die damage to the side (top, etc.) rolled onto each phase. When the bottom hits, each tire takes 1 die of damage. After all tires are gone, the bottom takes damage when it hits. Occupants may jump out at any time, or stay inside and hope that no damage reaches the interior. It may be driven after it stops rolling if it is right-side-up and has tires on at least 3 corners. A cycle won't be drivable after a roll.***
- 6-9 — As above, but vehicle is burning on a roll of 4, 5, or 6 on one die. (For more information on burning vehicles, see "Fire and Explosion" in Section V, *Combat*.)
- 10 or more — As above on this table, but the vehicle vaults into the air by the side (or front) tires, the tires doing the vaulting taking 3 dice of damage. The vehicle will then fly through the air for 1-6 inches (roll one die) in the direction the vehicle was traveling before the crash result, revolving two sides for every inch traveled. When it lands, the side that hits takes collision damage at the vehicle's initial speed. If the attempted maneuver was a tight bend or a hard swerve, the vehicle will flip end over end. Upon landing, the vehicle will continue to roll as per result 6-9 on this table. All occupants take one point of damage automatically. Body armor does not protect against this damage.

Crash Table 2 — Fishtails

- 1, 0, 1, 2 — Minor fishtail. Roll randomly to see if fishtail will be left or right. If, for instance, it is left, keep vehicle's *right front* corner in the same square, and move the *left rear* corner 1 square left. Reverse for a right fishtail.*
- 3, 4 — Major fishtail. As above, but rear corner moves *two* squares.**
- 5 — Execute a minor fishtail *and* roll again on Crash Table 1.***
- 6-9 — Execute a major fishtail *and* roll again on Crash Table 1.***
- 10 or more — Execute a major *and* a minor fishtail (a total of three squares movement in one direction); roll again on Crash Table 1.

* Any further aimed weapon fire from these vehicles on this turn will be at a -3 to hit.

** Any further aimed weapon fire from these vehicles on this turn will be at a -6 to hit.

*** No further automatic weapon fire permitted from these vehicles this turn.

Damage Table

Vehicle Weight	Damage Modifier (DM)	Vehicle Weight	Damage Modifier (DM)
0- 2,000	$\frac{1}{5}$	40,001-44,000	10
2,001- 4,000	$\frac{3}{5}$	44,001-48,000	11
4,001- 8,000	1	48,001-52,000	12
8,001-12,000	2	52,001-56,000	13
12,001-16,000	3	56,001-60,000	14
16,001-20,000	4	60,001-64,000	15
20,001-24,000	5	64,001-68,000	16
24,001-28,000	6	68,001-72,000	17
28,001-32,000	7	72,001-76,000	18
32,001-36,000	8	76,001-80,000	19
36,001-40,000	9	80,001-84,000	20

Fixed Objects

A fixed object will cause exactly as much damage as it takes, up to the point at which the fixed object breaks. All fixed objects will have a DP rating, which is the number of Damage Points they can take before they are destroyed.

Example: A 20-point tree gets in the way of a luxury car going 40 mph. The "ram" damage at 40 mph is 3 dice, and a luxury car's DM is usually 1. A 12 is rolled on the 3 dice, and multiplied by 1 for a result of 12. That's how much damage the car does to the tree, and it's also how much damage the tree does to the car.

Now, let's send the same car into the same tree at 80 mph. The "ram" damage at that speed is 11 dice, and this time the total is 41. The tree only has 20 DP, so it is destroyed. But the car only takes 20 points of damage, too.

For each collision, determine the collision type — Head-On or Sideswipe — and apply damage, speed change, and hazards accordingly. Of course, in a Head-On, if the obstacle is not destroyed or breached, the vehicle stops. If the obstacle is destroyed, the vehicle's "Temporary Speed" becomes its new speed. If a Sideswipe does not destroy the obstacle, the vehicle finishes the phase by sliding along the obstacle.

Note: A building breach is generally 1/4" wide (see "Buildings," under Section V, *Combat*). A vehicle ramming a building or wall must, in effect, create two such breaches in order to break through. Thus, when ramming a 6DP building, a vehicle must do 12 points of collision damage to create a double breach and continue through. In addition, each 1/4" section of wall will return damage, up to its full DP value.

Collision Types

A *Head-On* collision occurs any time one vehicle collides with another from within the 90-degree shaded arc of Figure a.

A *Rear End* collision (Figure b) is similar to a Head-On, except that the two vehicles are heading in roughly the same direction.

A *T-Bone* collision occurs when one vehicle collides with another from within the 90-degree shaded arc of Figure c.

There are two types of *Sideswipe*. In one case, the vehicles are travelling in the same direction, nearly parallel to each other (i.e., within the 45-degree shaded arc of Figure d). The second type is similar to the first, except that the vehicles are traveling in *opposite* directions, but still nearly parallel to one another (see Figure e). Fishtails are a major cause of both types of Sideswipe.

FIGURE a:
HEAD-ON



FIGURE b:
REAR-END

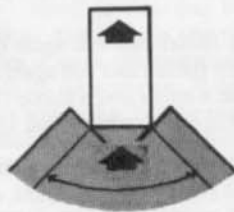

FIGURE c: T-BONE

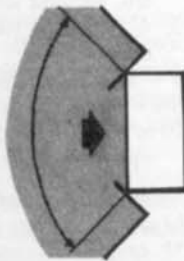

FIGURE d: SIDESWIPE
(same direction)

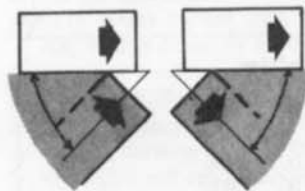
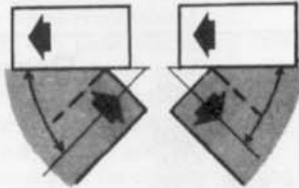

FIGURE e: SIDESWIPE
(opposite direction)



"Conforming" Movement

When one vehicle pushes another one out of the way, the second vehicle is "conforming" to the first. A vehicle conforms to another by pivoting on one corner until, through regular movement, the two vehicles are no longer in contact. The driver of the conforming vehicle selects an appropriate pivot corner from the choices shown below. In each case, V2 is "conforming" to V1. During its own movement

phase, V2 does not pivot; it moves normally as its driver maneuvers it (or as required by the Crash Table, if it is out of control).

Note that subsequent phases in which the vehicles are still in contact are not new collisions. Do not assess additional damage or adjust speed again unless a vehicle hits something else. For example, a car might sideswipe a trailer, slide along its side (accumulating no new damage) and then collide with the tractor, which had turned into the car's path (a new collision). Or a car might sideswipe a building and then have a new collision with a projecting wing of that same building.

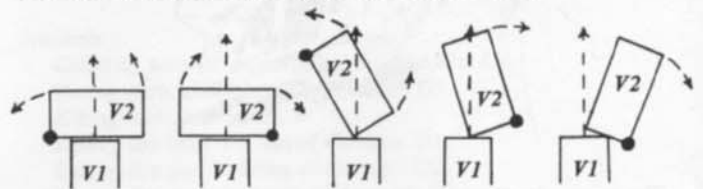

Collision Procedure

Head-On Collisions (Figure a)

- 1) A Head-On collision affects the front armor of both vehicles.
- 2) Collision speed is that of V1 plus V2; apply RAM damage at this speed, as modified by each vehicle's DM.
- 3) (a) Figure out the "Temporary Speed" for V1 and V2 from the Temporary Speed Table (below).
(b) Subtract the speed of the slower vehicle from the speed of the faster vehicle. The faster vehicle is now moving at this new speed; the slower has speed 0.
(c) Adjust the markers on the Movement Chart.
(d) If the phasing vehicle is still moving, complete this movement phase.
(e) The slower vehicle (now at 0 mph) "conforms" itself to the faster one.
- 4) Reduce the Handling Status of each vehicle by 1 for every 10-mph change in speed (rounding up) and make a Control Table roll for each one at its original speed. Apply at least a D1 hazard to each one, even if it lost no speed.

Rear-End Collisions (Figure b)

- 1) A Rear-End collision affects V1's front armor and V2's back armor.
- 2) Collision speed is that of V1 minus V2; apply RAM damage at this speed, as modified by each vehicle's DM.
- 3) (a) Figure the "Temporary Speed" of V1 and V2 from the TST.
(b) Add these two speeds together. Both V1 and V2 are now moving at this speed.
(c) Adjust the markers on the Movement Chart.
(d) If V1's DM is higher than V2's DM, complete its movement for this phase. Otherwise, do not complete its movement.
- 4) Reduce the Handling Status of each vehicle and make a Control Table roll for each as described for Head-On collisions.

T-Bone Collisions (Figure c)

- 1) A T-Bone collision affects V1's front armor and V2's side armor.
- 2) Collision speed is that of V1; apply RAM damage at this speed, as modified by each vehicle's DM.
- 3) (a) Figure V1's "Temporary Speed" from the TST. This becomes its actual speed after the collision; adjust its marker on the Movement Chart.
(b) If V1's new speed is above 0, and it was making its move when the collision took place, it completes this phase's movement, and V2 "conforms" to V1's movement. If V2 was making its move when the collision took place, and if V2's DM is higher than V1's DM, complete V2's movement for this phase. Otherwise do not complete V2's movement.
- 4) (a) Reduce V1's Handling Status and make a Control Roll as described for a Head-On collision.
(b) Find V2's corresponding hazard, as follows:
If V1's hazard was: D1 D2 D3 D4+
Then V2's hazard is: D4 D3 D2 D1.
(c) V2 makes a Control Table roll but does not change speed, even though its direction may be shifted by V1's subsequent movement.

Sideswipes (Figure d and e)

- 1) A sideswipe affects the side armor of both vehicles.
- 2) (a) Figure the net speed of the collision. If both vehicles are going in the same direction (Fig. d) subtract the lower speed from the higher. If they are going in opposite directions (Fig. e), add the two speeds.
(b) Divide net speed by 4, rounding up to the nearest 5 mph. This is the collision's "Swipe-Speed."
- 3) Apply RAM damage at the "Swipe-Speed," as modified by each vehicle's DM.
- 4) If the phasing vehicle's DM is higher than the other vehicle's DM, it finishes its movement by sliding along the other vehicle.
- 5) Reduce the Handling Status of each vehicle by 1 for each 10 mph of "Swipe-Speed," and make a Control Table roll for each.
- 6) If either vehicle fishtails as a result of this control roll, the fishtail will be in the direction away from the collision which just occurred.
- 7) A Sideswipe does not affect the actual speed of either vehicle.

Temporary Speed Table

Find your vehicle's *Damage Modifier (DM)* on the left and cross-index it with the opposing vehicle's (or obstacle's) DM across the top. The result (1, 3/4, 1/2, 1/4, 0) is a *preliminary* indication of how your speed was affected. Multiply your original speed by this number, rounding up to the nearest 5 mph. This is your "Temporary Speed."

Your DM	Opposing DM																					
	1/2	3/4	1	2	3	4	5	6	7	8	9	10	11	12	13	14	15	16	17	18	19	20
1/2	1/2	1/4	1/4	0	0	0	0	0	0	0	0	0	0	0	0	0	0	0	0	0	0	0
3/4	3/4	1/2	1/2	1/4	1/4	0	0	0	0	0	0	0	0	0	0	0	0	0	0	0	0	0
1	3/4	1/2	1/2	1/4	1/4	1/4	1/4	0	0	0	0	0	0	0	0	0	0	0	0	0	0	0
2	3/4	3/4	1/2	1/2	1/4	1/4	1/4	1/4	1/4	1/4	1/4	1/4	1/4	1/4	0	0	0	0	0	0	0	0
3	1	3/4	3/4	1/2	1/2	1/2	1/4	1/4	1/4	1/4	1/4	1/4	1/4	1/4	1/4	1/4	1/4	1/4	1/4	1/4	1/4	1/4
4	1	3/4	3/4	1/2	1/2	1/2	1/2	1/2	1/4	1/4	1/4	1/4	1/4	1/4	1/4	1/4	1/4	1/4	1/4	1/4	1/4	1/4
5	1	1	3/4	3/4	1/2	1/2	1/2	1/2	1/2	1/2	1/4	1/4	1/4	1/4	1/4	1/4	1/4	1/4	1/4	1/4	1/4	1/4
6	1	1	3/4	3/4	1/2	1/2	1/2	1/2	1/2	1/2	1/2	1/2	1/2	1/4	1/4	1/4	1/4	1/4	1/4	1/4	1/4	1/4
7	1	1	3/4	3/4	1/2	1/2	1/2	1/2	1/2	1/2	1/2	1/2	1/2	1/2	1/4	1/4	1/4	1/4	1/4	1/4	1/4	1/4
8	1	1	1	3/4	3/4	1/2	1/2	1/2	1/2	1/2	1/2	1/2	1/2	1/2	1/2	1/4	1/4	1/4	1/4	1/4	1/4	1/4
9	1	1	1	3/4	3/4	1/2	1/2	1/2	1/2	1/2	1/2	1/2	1/2	1/2	1/2	1/4	1/4	1/4	1/4	1/4	1/4	1/4
10	1	1	1	3/4	3/4	1/2	1/2	1/2	1/2	1/2	1/2	1/2	1/2	1/2	1/2	1/2	1/4	1/4	1/4	1/4	1/4	1/4
11	1	1	1	3/4	3/4	1/2	1/2	1/2	1/2	1/2	1/2	1/2	1/2	1/2	1/2	1/2	1/2	1/4	1/4	1/4	1/4	1/4
12	1	1	1	3/4	3/4	1/2	1/2	1/2	1/2	1/2	1/2	1/2	1/2	1/2	1/2	1/2	1/2	1/2	1/2	1/4	1/4	1/4
13	1	1	1	3/4	3/4	1/2	1/2	1/2	1/2	1/2	1/2	1/2	1/2	1/2	1/2	1/2	1/2	1/2	1/2	1/2	1/2	1/2
14	1	1	1	1	3/4	3/4	1/2	1/2	1/2	1/2	1/2	1/2	1/2	1/2	1/2	1/2	1/2	1/2	1/2	1/2	1/2	1/2
15	1	1	1	1	3/4	3/4	1/2	1/2	1/2	1/2	1/2	1/2	1/2	1/2	1/2	1/2	1/2	1/2	1/2	1/2	1/2	1/2
16	1	1	1	1	3/4	3/4	1/2	1/2	1/2	1/2	1/2	1/2	1/2	1/2	1/2	1/2	1/2	1/2	1/2	1/2	1/2	1/2
17	1	1	1	1	3/4	3/4	1/2	1/2	1/2	1/2	1/2	1/2	1/2	1/2	1/2	1/2	1/2	1/2	1/2	1/2	1/2	1/2
18	1	1	1	1	3/4	3/4	1/2	1/2	1/2	1/2	1/2	1/2	1/2	1/2	1/2	1/2	1/2	1/2	1/2	1/2	1/2	1/2
19	1	1	1	1	3/4	3/4	1/2	1/2	1/2	1/2	1/2	1/2	1/2	1/2	1/2	1/2	1/2	1/2	1/2	1/2	1/2	1/2
20	1	1	1	1	3/4	3/4	1/2	1/2	1/2	1/2	1/2	1/2	1/2	1/2	1/2	1/2	1/2	1/2	1/2	1/2	1/2	1/2

Simplified Collision System

If all the above strikes you as being too complicated, there is a less realistic — but easier — alternative.

In the Simplified Collision System, you still use the "Ram" column on the Movement Chart to determine the number of dice of damage. To determine the collision speed, just look at the situation with common sense. If the vehicles are going the same direction (or almost the same), subtract the lower speed from the higher one. If they hit head-on (or nearly head-on), add the two speeds. If they strike at right angles, use the speed of the car which moved last.

If a pedestrian is involved, he or she takes full damage from the collision, but the vehicle only takes 1/2 damage. (In the regular collision system, pedestrians have a DM of 1/2, too.) A cycle does full damage to another cycle or a pedestrian, but only 1/2 damage to a car or truck.

Any collision is a D4 hazard. Collisions may also have other effects, which take place before the hazard is assessed, as follows: A sideswipe has no special effect on either speed or facing. A rear-end collision equalizes the vehicles' speeds at the average of their two speeds (round up).

T-bone and head-on collisions cause bounces and spins which are simulated randomly. Pick up both counters and drop them on the board from a height of 3" over the collision point. If a vehicle lands on top of another vehicle, try again. Turn both counters right side up — these are their new positions! A head-on reduces the speed of each vehicle to 0 mph, while a t-bone reduces the speed of each vehicle by 50 mph.

8. Debris and Obstacles

A "road debris" counter may represent any sort of junk on the road. Debris can be part of a scenario (appearing already drawn onto the road) or it can appear as a result of combat.

A debris counter is 1/2" x 1/4". It may show debris in two squares or in only one. Place it on the board so its squares align with those on the road, showing exactly which map squares contain debris.

Hitting Debris

A vehicle hits debris the first time any part of the vehicle counter touches a debris square. Debris can be hit only once per phase, regardless of how many debris squares are entered. If a vehicle starts the phase on top of debris, that debris does not affect it; it has already been hit.

Debris affects all of a vehicle's tires. Roll one die for each tire, and subtract 3 from the result, to find the damage to that tire. Thus, on a roll of 1 to 3, the tire is undamaged. Hitting debris is a D1 hazard.

Producing Debris

When a car takes 10 or more points of damage during one phase, pick one debris counter randomly. Place it next to the car, at the point hit. (A car is not affected by its own debris unless it drives back through it.) Debris for top/bottom damage goes behind the vehicle. If a car explodes, choose five random debris counters, and drop them onto the board from a height of one foot over the explosion site. (If one misses the board, or hits any other counter, drop it again.) Align counters with the road grid as closely as possible at the point where they fall. Debris and other obstacles (below) remain until the game ends.

Hitting Obstacles

An obstacle counter represents a pothole, loose wheel, or other larger road hazard. Striking an obstacle is a D3 hazard. Determining whether or not an obstacle is struck is done in the same way as for debris. An obstacle does the same damage to each tire as debris does. A vehicle may hit more than one obstacle in a phase, and must roll for each.

Producing Obstacles

If a car loses a wheel (not just a tire) or takes 20 or more hits during one phase, an obstacle is placed as described above for debris. In some scenarios, debris or obstacles may be thrown from buildings, vehicles, etc. Note that an obstacle is bulky, equivalent to one space in size, and no vehicle will be able to carry many. A pedestrian may move any obstacle that can be moved; potholes, for example, can't be moved. It takes one turn to pick an obstacle up and a pedestrian may move one square per turn while carrying it. A pedestrian cannot use a weapon while carrying an obstacle. It takes no time to drop an obstacle.

9. Pedestrians

Most pedestrians move at 12.5 mph; that is, they move 1/4" on every odd-numbered phase. Pedestrians with the Running skill (see Section VII, *Continuing Characters*) can move faster.

Pedestrians may move into any adjacent square, including those which are diagonally adjacent, in their move. They can change direction any time without having to bother with control rolls or handling class (though things like oil and tire spikes could hamper movement). For the full rundown on pedestrians, see Section VI.

V. Combat

Combat may occur during any phase, before or after movement. To attack, a player simply announces that he is firing, and names the weapon being fired and its target. If a vehicle is being moved at the moment he announces his attack, the vehicle completes its movement for that phase; then the attack is resolved.

Results of an attack are applied immediately, before any other vehicle can return fire or move. If an attack is being calculated and another attack is announced, the results of the first attack are all applied; then the second attack is resolved.

A given weapon may never fire more than once per turn. A given character may never fire more than once per turn, unless he does so by triggering linked weapons. If every person in a vehicle is unconscious or dead, it cannot fire (unless a weapon was set on "automatic fire" — see "Odds and Ends," below).

Rate of Fire

Usually, the above restrictions mean that each vehicle will only fire once per turn. Exceptions occur when (a) a weapon is on "automatic," (b) a vehicle has additional occupants, such as gunners, who may also fire, or (c) linked weapons are used.

1. General Combat Procedure

Briefly, the procedure for resolving a normal weapon attack is (a) make sure that there is a line-of-fire from the weapon to the target; (b) roll two dice to see if the weapon hits (see "Determining Hits," below); (c) if the weapon hits, determine damage location and amount (see "Damage," below); (d) alter the vehicle's handling status and/or place debris or obstacle counters if required. Dropped weapons are an exception to the above and are discussed later in this section.

Line of Fire

To fire at a given target, there must be a *line of fire* (LOF) from the firing counter's center (for a turret weapon) or middle of the side where the weapon is located (for other weapons) to some part of the counter representing the target. Buildings, vehicles, pedestrians, etc., block LOF (debris and obstacles do not). Smoke and paint reduce chances of hitting but do not block LOF except for lasers.

Furthermore, the LOF must be traced within the *arc of fire* for that weapon position. Arcs of fire for vehicle weapons are shown in the diagram below. Pedestrians and turret weapons have a 360-degree arc of fire. Hand weapons fired from a car, truck or sidecar have a right or left arc of fire, depending on which side they're fired from; hand weapons fired by a cycle driver have a 360-degree arc of fire.



Car Targeting

Targeting is choosing what you're going to shoot at — whether it's the side of a vehicle or a specific part, like a tire.

A car has front, back, right, left, top, and underbody "sides." When you fire at a vehicle, you may only hit a side that is facing you. Unless the target car is lined up exactly perpendicular to you, you will be able to choose between two sides. However, only if you are in a particular side's arc of fire may you attack that side with no penalty. If the firing vehicle is on the dividing line between two of a target vehicle's arcs of fire, it may target either side without penalty. If you target a side on which you have line of fire without being in the target side's arc of fire, you suffer a penalty of 2 to your to-hit roll. You may choose which

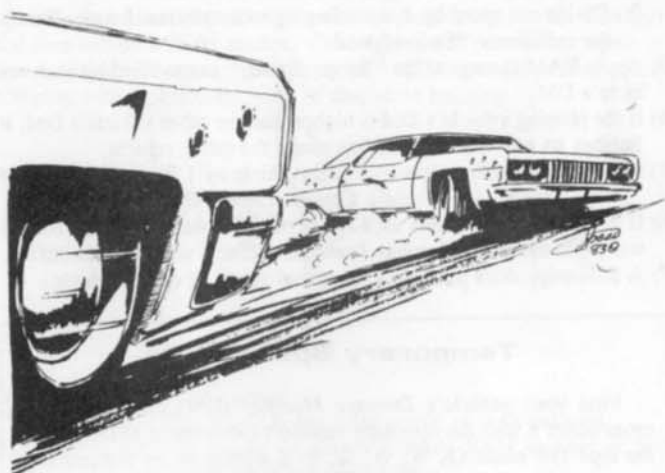

side you wish to target. If you score a hit, any damage you do will be taken by that part of the vehicle (see *Damage Location* under "Damage" below).

You may never target a vehicle's underbody with normal weapons. However, the underbody is automatically the target of a mine.

A vehicle's tires may be targeted. Each tire is a separate target; subtract 3 from the to-hit roll when shooting at tires.

A vehicle's turret may be targeted. All top armor protects weapons in the turret. If a vehicle has no turret, the top can only be hit if something is dropped (or fired) from a building or if the vehicle rolls. Targeting a turret is at a -2.

Cycle Targeting

Compared to a car, a cycle is a small target, but every part is exposed. Therefore, after firing on and hitting a cycle, roll on the table below. Only one component of a cycle can be hit in each attack — the rest of the damage passes through the cycle and has no effect.

Attacking from front or rear — Roll 2 dice. On 2-10, you hit armor (if the armor is gone, roll again on the "side" table below for remaining damage). On an 11 or 12, you hit the exposed wheel.

Attacking from the side — Roll 2 dice. 2-5, you hit the driver. 6-7, the power plant. 8-10, a weapon; roll randomly if the cycle has more than one weapon; roll again if there are none. 11-12, a tire — roll randomly to see which one.

Sidecar targeting — A sidecar can only be hit from the side on which it is mounted. Imagine a line running lengthwise down the center of the cycle counter — if you're on the same side of the line the sidecar is on (or on the line), you can shoot at it. If you're not, you can't. Targeting a sidecar carries a -2 penalty to your to-hit roll. If you're just shooting at the cycle as a whole and you are on the sidecar side, roll one die. On a 1-4, the cycle was hit, and you can use the tables above. On a 5 or 6, the sidecar was hit. Treat a sidecar as a tiny automobile, with armor in front, back, underbody, and both sides. It has one wheel (plus some small coaster-type wheels for stability if it ever rolls free), maybe one or two weapons, and possibly a rider. Once armor on part of the sidecar is lost, any fire hitting the exposed area has an equal chance of hitting each of the interior components.

2. Determining Hits

When a normal weapon (anything but a dropped or smoke/paint weapon) is fired, the attacking player rolls two dice to see whether he hit his target. He must make the to-hit roll or higher for that weapon — see the Weapon List (below). Thus, to hit with a machine gun, a player would need to roll a 7 or higher on two dice.

Weapon List

Weapon	Abbrev.	Effect/Weap. Type	To Hit	Dam.	DP	Cost	Wt.	Spc.	Shots	CPS	WPS	L. cst.	L. wt.	Notes
Machine Gun	MG	area	7	1	3	1000	150	1	20	25	2.5	1500	200	
Vulcan MG	VMG	area	6	2	3	2000	350	2	20	35	5	2700	450	
Autocannon	AC	burst 2'' radius	6	3	4	6500	500	3	10	75	10	7250	600	
Flamethrower	FT	area	6	1	2	500	450	2	10	25	5	750	500	a
HD Flamethrower	HDFT	area	6	2	3	1250	650	3	10	50	10	1750	750	b
Rocket Launcher	RL	burst 2'' radius	8	2	2	1000	200	2	10	35	5	1350	250	
Micro Missile Launcher	MML	burst 1'' radius	8	1	2	750	100	1	10	20	2.5	950	125	
Radar-guided Missile	RGM	burst 2'' radius	7	3	1	5000	200	2	2	1000	100	7000	400	c
Wire-guided Missile	WGM	burst 2'' radius	6	3	2	2500	200	2	2	400	15	3300	230	d
Recoilless Rifle	RR	burst 2'' radius	7	2	4	1500	300	2	10	35	5	1850	350	
Anti-tank Gun	AT	burst 2'' radius	8	3	5	2000	600	3	10	50	10	2500	700	e
Light Laser	LL	area	6	1	2	3000	200	1	—	—	—	3000	200	f
Laser	L	area	6	3	2	8000	500	2	—	—	—	8000	500	g
Heavy Laser	HL	area	6	4	2	12000	1000	3	—	—	—	12000	1000	h
Tank Gun	TG	burst 2'' radius	7	6	10	10000	1200	10	10	100	20	11000	1400	i
Minedropper	MD	dropped	—	—	2	500	150	2	10	50	5	1000	200	j
Spear 1000 MD	SMD	dropped	—	—	2	750	150	2	5	100	10	1250	200	k
Spikedropper	SD	dropped	—	—	4	100	25	1	10	20	5	300	75	
Smokescreen	SS	paint/smoke	—	—	4	250	25	1	10	10	5	350	75	
HD Smokescreen	HDSS	paint/smoke	—	—	4	500	50	2	10	40	20	900	250	l
Paint Spray	PS	paint/smoke	—	—	2	400	25	1	25	10	2	650	75	
HD Paint Spray	HDPS	paint/smoke	—	—	3	800	50	2	10	40	8	1200	130	m
Oil Jet	OJ	dropped	—	—	3	250	25	2	25	10	2	500	75	
Heavy Duty Oil Jet	HDOJ	dropped	—	—	4	500	50	3	10	40	8	900	130	n
Oil Gun	OG	—	5	—	3	1000	250	3	10	25	5	1250	300	o
Flaming Oil Jet	FOJ	dropped	—	1d-2	3	300	30	2	25	35	2	1175	80	p
HD Flaming Oil Jet	HDFOJ	dropped	—	1d-2	4	550	60	3	10	140	8	1950	140	q
Grenade Launcher	GL	—	7	—	2	1000	200	2	10	—	4	—	—	r
Starshell Launcher	SL	—	—	—	2	500	100	1	5	50	5	750	125	s
Heavy Rocket	HR	burst 2'' radius	9	3	2	200	100	1	1	—	—	200	100	t
Medium Rocket	MR	burst 1'' radius	9	2	2	140	50	1	1	—	—	140	50	u
Light Rocket	LR	burst 1'' radius	9	1	1	75	25	.5	1	—	—	75	25	v
Mini Rocket	MNR	burst ½'' radius	9	1d-1	1	50	20	.33	1	—	—	50	20	w
Six Shooter	MFR	burst 2'' radius	9	1	3	450	150	2	1	—	—	450	150	x
Bomb	B	burst 2'' radius	9	4	2	100	100	1	1	—	—	100	100	y
Cluster Bomb	CB	burst 3'' radius	9	2	2	200	150	1	1	—	—	200	150	z

Abbreviations: *Dam.* — number of dice of damage; *DP* — damage points; *Wt.* — weight; *Spc.* — space; *CPS* — cost per shot; *WPS* — weight per shot; *L. cst.* — loaded cost; *L. wt.* — loaded weight.

Notes

a. *Flamethrower* — Has a maximum range of 10'', and produces a smoke cloud when fired. May not be fired forward while a vehicle is moving forward (or backward while a vehicle is moving backward, for that matter) — the vehicle will run into its own flame cloud, taking full damage!

b. *Heavy Duty Flamethrower* — Maximum range 15''. Also produces a smoke cloud when fired. Cannot be fired in the same direction the vehicle is moving (see above).

c. *Radar-guided Missile* — Standard range penalties do not apply; instead subtract 1 for every full 4'' closer than 24'' the target is from the firer. There are no range penalties or bonuses beyond 24'' and the weapon's maximum range is 72''. The missile suffers no penalties for night, fog, rain, paint, or smoke. The firer must have a line-of-sight on the target at the time of firing; the missile will track the target thereafter as long as the missile (not necessarily the firer) maintains line-of-sight. The missile moves at 200 mph (2'' per phase) and should be represented on the map by a pedestrian-sized marker. If the missile loses line-of-sight due to a solid obstruction (building, wall, tunnel) at any time, control is lost and cannot be regained. The missile will move in a straight line thereafter, until it hits something, leaves the map, or travels its full range of 72'', at which point it hits the ground and explodes. The missile may be targeted in flight, at a -6 for the target vehicle, and a -10 for everybody else.

d. *Wire-guided Missile* — Must be fired from a stationary vehicle, and the vehicle must remain stationary while the missile flies toward its target. Moves at 200 mph (2'' per phase), and should be represented by a pedestrian-sized counter. The missile must travel at least 12'' (six phases) to arm itself. The firer can do nothing while the missile is in flight but guide the missile toward its target. If the firer is killed, wounded, abandons the missile, has line-of-sight to the missile broken, or if the vehicle he is in moves, the missile will stop tracking and will revert to straight-line movement. It will travel until it hits something, leaves the map, or travels its full range (72''). After 72'' of travel, the missile will hit the ground and explode. There are no range penalties for firing the WGM, no matter how far away the target is. The missile can be targeted in flight, at a -6 for the target vehicle, and a -10 for all others.

e. *Anti-tank Gun* — May only be mounted to front or back on anything smaller than oversized vehicles because of recoil.

f. *Light Laser* — Runs off power plant. Cannot fire through smoke or paint.

g. *Laser* — Runs off power plant. Cannot fire through smoke or paint.

h. *Heavy laser* — Runs off power plant. Cannot fire through smoke or paint.

i. *Tank Gun* — Can only be mounted on oversized vehicles, and then only to the front or back. Cannot be mounted in a turret. Still a D2 hazard for the firing vehicle every time it goes off.

j. *Minedropper* — Does one die damage to tires, 2 dice damage to underbody armor.

k. *Spear 1000 Minedropper* — Does 1d-3 to tires, 2d+3 to underbody armor.

l. *Heavy Duty Smokescreen* — Makes smoke cloud four times as large as standard SS.

m. *Heavy Duty Paint Spray* — Makes paint cloud four times as large as standard PS.

n. *Heavy Duty Oil Jet* — Makes oil slick four times as large as standard OJ.

o. *Oil Gun* — Shoots a plastic bag filled with oil; if to-hit roll is made, a twice-normal size oil slick is centered on the target square. A miss means the bag shredded before impact and the oil is too dispersed to be effective. Vehicles can be targeted at a -2; a successful hit on a vehicle means a standard slick appears underneath the target vehicle, and the vehicle is treated as though it had just run through a paint cloud.

p. *Flaming Oil Jet* — Sometimes called the "Artful Dodger." Oil dropped from the FOJ looks and acts like a normal slick until the second phase after it is dropped — then it ignites! It burns (+D3 hazard) and acts as a Smokescreen until the tenth phase of the fifth complete turn after it is dropped, and then disappears. Tires and underbody of vehicles passing through take 1d-2 damage.

q. *Heavy Duty Flaming Oil Jet* — Acts as FOJ except slick is four times as big.

r. *Grenade Launcher* — Damage and final loaded cost are dependent upon the types of grenades loaded (complete list available in Hand

Weapon List, p. 25). Grenades of different types can be mixed, but once loaded, the order and the various time delays cannot be changed. Players should keep track of exotic combinations.

s. *Starshell Launcher* — Fires an illumination flare which, if fired into the air, will fully illuminate the entire play area, negating any penalties for night targeting. When mounted in a vehicle, it must be mounted on top, and is protected by the top armor. It need not be in a turret, and it does not preclude a turret from being mounted in addition.

t. *Heavy Rocket* — One-shot weapon.

u. *Medium Rocket* — One-shot weapon.

v. *Light Rocket* — One-shot weapon.

w. *Mini Rocket* — One-shot weapon. Does ½-die of burst effect damage.

x. *Six Shooter* — Also called the "Multi-Fire Rocket Pod," and abbreviated MFR. Two-inch burst effect radius for each of six rockets, all of which are fired simultaneously. Make separate to-hit rolls for each rocket. Treat each rocket as a separate attack when determining building breaches, but treat them as one big attack when determining effect on handling status, debris, and obstacles.

y. *Bomb* — Can only be dropped from a helicopter. Has a 2" burst effect radius and does 2 dice damage. If the to-hit roll is not made, use the same procedure as for grenades (see pg. 21) to determine actual point of impact. When a bomb hits the ground directly, place an obstacle counter at the point of impact and scatter debris counters in the area — this represents the crater the bomb creates.

z. *Cluster Bomb* — Can only be dropped from a helicopter. In addition to the regular 2 dice of damage to the target, it does an additional 2 dice of burst effect damage to everything (including vehicles and buildings) in a 3" radius, and 1 die of damage to pedestrians 3" to 5" away. Treat misses as above; the cluster bomb also creates a crater as above.

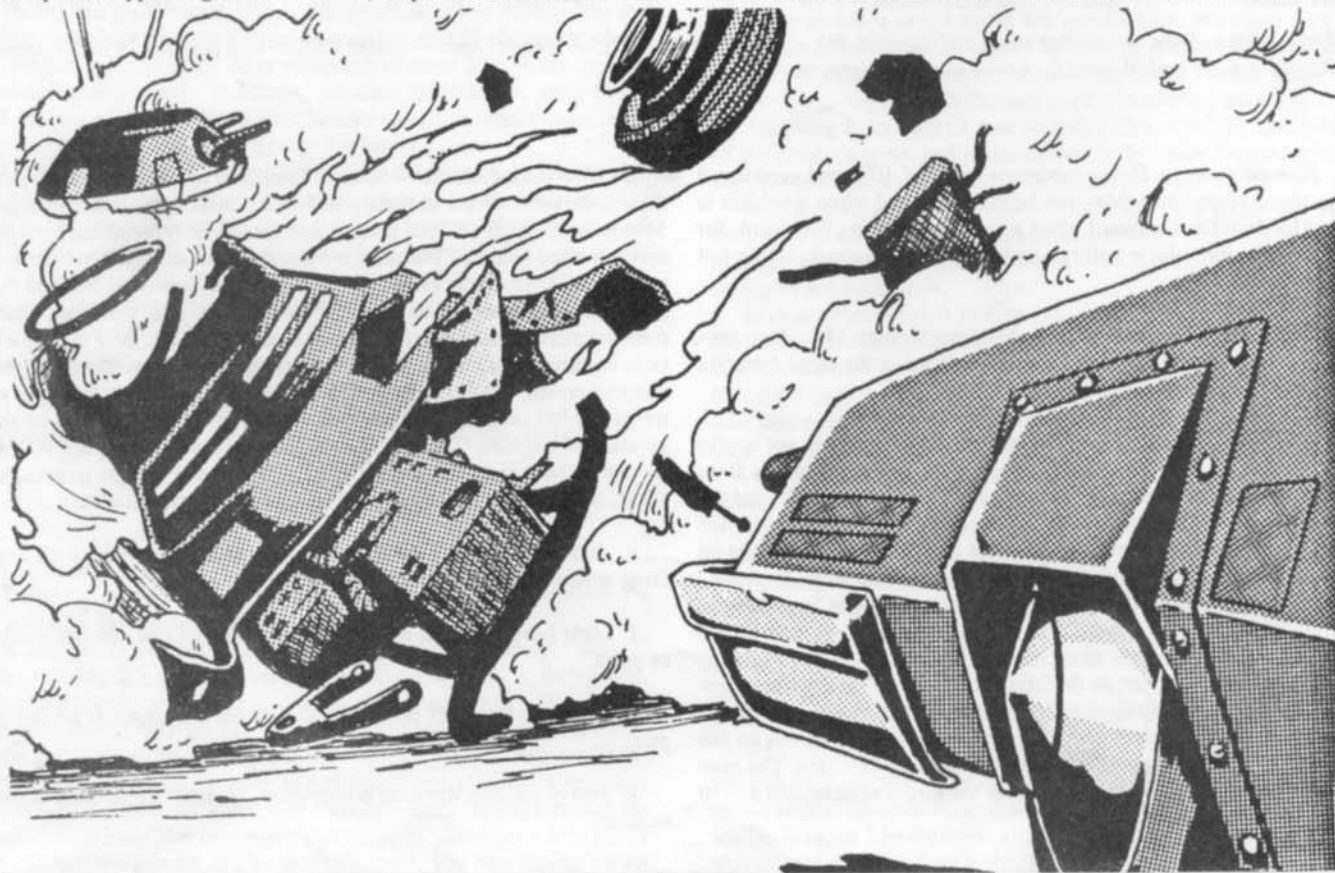

Targeting Modifiers

Accuracy is affected by a number of factors, including the skill of the firer, range, weather, and size and speed of the target. Consult the following list, and add all the factors that apply to the to-hit roll. All factors are cumulative. For example, a machine-gun has a base to-hit roll of 7. If the firer was using a targeting computer (+1) at point-blank range (+4) and was trying to hit the tire (-3) of a cycle (-2) at night (-3), there would be a total modifier of -3; the firer now has to roll a 10 or more. No matter what the roll needed, a roll of 2 on the dice is an automatic miss. A roll of 12 is not an automatic hit. If, after all modifiers, a player needs a 13 or higher to hit, he cannot hit the target; don't bother rolling.

Targeting Modifiers

Range

- Point Blank (less than 1'' away): +4
- Long Range: -1 for every full 4''; that is, 4'' to 7.99'' is -1, 8'' to 11.99'' is -2, 12'' to 15.99'' is -3, etc.

Movement

- Target is not moving: +1
- Firer is not moving: +1
- Firing pedestrian is braced against solid object: +1
- Target is moving between 30 and 37.5 mph: -1
- Target is moving between 40 and 47.5 mph: -2
- Target is moving between 50 and 57.5 mph: -3
- Target is moving between 60 and 67.5 mph: -4
- Target is moving between 70 and 77.5 mph: -5
- Target is moving 80 mph or faster: -6

Vehicle Targets

- Compact or Subcompact: -1
- Front or Rear of a Motorcycle or Car: -1
- Motorcycle: -2
- Sidecar: -2
- Light Trike: -3 from front/back, -2 from side
- Medium Trike: -2 from front/back, -1 from side
- Heavy Trike: -1 from front/back, -1 from side
- X-Heavy Trike: -1 from front/back, no penalty from side
- Front of a Ten-Wheeler Carrier: -2
- Side of a Ten-Wheeler Cab: +1
- Side of a Ten-Wheeler Carrier: +1
- Side of a Mini-Bus: +1
- Side of a Tractor: +1
- Side of a Trailer or Bus: +2
- One-Man Helicopter: -1 from front/back, +1 everywhere else
- Small Helicopter: -1 from front/back, +1 everywhere else
- Standard Helicopter: +2 from top, bottom, or side
- Transport Helicopter: +2 from top, bottom, or side

Specific Target

- Pedestrian: -3
- Vehicle tire: -3
- Turret: -2
- Motorcycle Rider (from side only): -3
- Tractor's Fifth Wheel: -6
- Legs of a Semi-Trailer: -5
- Lamppost: -6
- Building: +10
- Helicopter Skid: -8
- Helicopter Winch Cable: -8
- Helicopter Pontoon: -3
- Helicopter Rotor: -6
- Searchlight: -3
- Tongue on Unattached Car Trailer: -5
- Tongue on Attached Car Trailer: -7
- Unattached Hitch to Pull Car Trailer: -5
- Attached Hitch to Pull Car Trailer: -7
- Radar- or Wire-Guided Missile in Flight: -6 for target vehicle, -10 for everyone else
- Ejection Seat During Launch: -6
- Ejection Seat Landing via Parachute: -2

Visibility

- Firing through smoke or paint: -2 per counter
- Rain: -2
- Heavy Rain: -3
- Fog: -3
- Night: -3
- Target Under Cover of Rubble: -4
- Firer Blinded by Searchlight: -10

Miscellaneous

- Targeting Computer Used: +1
- Hi-Res Computer Used: +2
- Cyberlink Used: +3
- Gunner Skill: apply whatever plus the skill is at for that player
- Handgunner Skill: same as Gunner skill, but for hand weapons
- Laser Scope: +1 when mounted on a hand weapon
- Firing While on Oil, Gravel, or Bad Road: -1
- Sustained Fire: second consecutive shot in as many turns at same target with same weapon: +1; third and subsequent shots: +2
- Attacking Vehicle is Remote-Controlled: -3
- Attacking Vehicle Does a Trivial Skid or Minor Fishtail: -3 for the remainder of the turn
- Attacking Vehicle Does a Minor or Moderate Skid or Major Fishtail: -6 for the remainder of the turn
- Attacker Not in Arc of Fire of Target Side: -2

Use common sense when assessing speed modifiers; if two vehicles are screaming down the road at 100 mph, side by side, they should *not* be at a -6 to hit each other. The referee should be the final judge in situations like these, but unless it's clear-cut and obvious, use the full modifier.

All modifiers are cumulative. For example, firing at the wheel (-3) of a motorcycle (-2) from the front (-1) in the rain (-2) from 10'' away (-2) would be at a -10; firing at the side of a trailer (+2) at point-blank range (+4) using a hi-res computer (+2) would be at a +8.

3. Damage

When a weapon hits, calculate the amount of damage by rolling the number of dice shown on the Weapon List. The result is the number of hits taken by the target.

Burst Effect

Weapons that do additional *burst effect* damage are identified on the Weapon List. In addition to the listed damage to whatever was hit, burst effect weapons do one die of damage to any pedestrian in the weapon's burst effect radius. Pedestrians under cover (behind an intact wall or vehicle) are not affected.

A grenade does full damage to any pedestrian within its 2'' burst effect radius, and half-damage to vehicle components (armor, tires, etc.) in the same radius. No other burst-effect weapon will affect walls or vehicles (including tires) with its burst effect. Reason: The other burst-effect weapons are shaped charges, exploding upwards (in the case of a mine) or into the target (in the case of other weapons), and the burst effect is merely a bonus, not strong enough to harm armored vehicles or vehicular components.

Area Effect

Weapons which may be used against pedestrians in an *area effect* are identified on the Weapon List. These are weapons that can sweep an area. When using such a weapon against several pedestrians within 1'' of one another, the firer may attempt to hit several at once. He must roll to hit each intended victim. Those he hits take *half* the damage rolled for the weapon (round up). Exception: The flamethrower and heavy duty FT do full damage against all targets! When some people are missed and others are hit, the pedestrians that take the damage are chosen by the player being attacked. He must choose pedestrians that are standing next to each other. Example: Four pedestrians are standing in a line 1'' long; as people this dim should be removed from the gene pool, an intrepid duellist decides to deep-fry them with his laser. He fires, and

rolls two hits and two misses. The player controlling the pedestrians designates the two on the right. The duellist rolls a 13 on 3 dice, so each victim receives 7 points of damage (6½ rounded up) and is vaporized.

Recording Damage

Each vehicle component can take a certain amount of damage, shown as "DP" (damage points) on the Weapon List, Accessories List, and Vehicle Design List. Armor is lost a point at a time; if you start with 12 points of armor on the front of your car, and it takes 7 hits, you have 5 points left. Other components work at full efficiency until they take their full amount of DP — then they're gone. A machine-gun (3DP) can take 2 hits and still work, but the hits are recorded in the boxes on the Vehicle Record. When that gun takes a third hit, it is destroyed. You can repair damage yourself, using the Mechanic Skill (see Section VII, *Continuing Characters*), or you can pay for repairs (see "Repair and Salvage," Section VIII, *Car Design*).

Damage Location

The location of weapon damage is controlled by the part of the vehicle that was hit. Damage is taken by the components in that part of the target, outermost first. Armor is destroyed first. When all armor is gone, the next component inward is hit, and so on. Components in each area of a car or truck, in the order they are hit by an attack from that side, are:

Front: Front armor; (front-firing weapons); front motor; (driver or gunner); cargo; back motor; (back-firing weapons); back armor.

Back: As above, but in reverse order: Back armor first, etc.

Right: Right armor; (right-firing weapons); (gunner, driver, cargo, or motor); (left-firing weapons); left armor.

Left: As above, but in reverse order: Left armor, etc.

Underbody: Underbody armor; (motor, driver, gunner, or cargo); turret weapons; top armor. Tires may also take damage.

Top: As above, but in reverse order.

Turret: Top armor, then turret weapons. If the turret was targeted from the side, "leftover" damage will pass above the car, hitting nothing else.

Tires: Targeted tire/wheel only. "Leftover" hits have no effect.

Many vehicles will not have every component listed. If a component is not present, just skip it! Few cars will have front and rear power plants (motor); many will have no gunner, turret, or cargo. Passengers count as cargo. For a more complete guide, refer to the Vehicle Record Sheet example in Section III, which has components in most of the possible locations. In case of a dispute, the referee's decision is final.

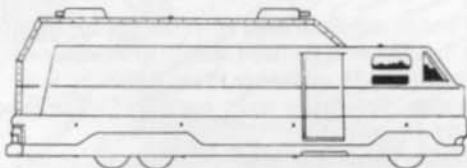

Note that some weapons cannot be hit by certain attacks. There is no way, for example, to damage a front-firing weapon by an attack from the right — though you can hit it from *behind* by shooting *through* the car.

Where two or three components are listed in parentheses, only one will be hit by each attack. Roll randomly for each separate attack to see which one is hit. Example: A mine explosion that penetrated the underbody armor would affect either the motor, driver, gunner, or cargo — but only one. If that component took enough hits to destroy it completely, further damage from that explosion would go directly to the turret weapon or, if there was no turret, the top armor. A subsequent mine explosion might get a previously-unhit target, or hit in the same place, bypassing the other internal targets, and hit the turret or top again.

Similarly, if a vehicle takes "front weapon" damage and has two or more front weapons, roll randomly for each attack to see which of the weapons is hit. If there are two or more front weapons, each attack will hit only one. Leftover damage from that attack goes "inward," not "sideways" to other front weapons.

Critical Hits — A Variant

Note: As a variant, this is an optional rule that adds realism to the

game while increasing the complexity. If you like the rule, go ahead and use it. If you don't, feel free to ignore it.

Critical hits represent lucky shots at or through weak points of a defense. Perhaps a shot penetrates a spot that had been chewed away by previous gunfire, destroys the belt feeding mechanism of a machine gun, or hits a vulnerable body armor joint.

Defensive weapons, such as oil, and those that hit automatically, like grenades and mines, do not get critical hits. Only those weapons that must roll a to-hit number may have criticals. If, after all modifiers have been calculated, a weapon needs a 12 or more to hit, a critical hit is not possible. If the number needed to hit is between 3 and 11, then a critical is achieved on the roll of a 12. If there are so many modifiers in the firer's favor that a 2 or less is all that's needed to hit, a critical hit happens on an 11 or 12.

The type of damage a critical hit does depends upon the target. If the target has armor (including body armor), then a critical hit simply ignores the armor. All damage done by the weapon is applied to internal components. An armor critical hit will not, however, skip both a vehicle's armor and the body armor of the driver. People in vehicles are considered components unless specifically targeted, such as a cycle rider.

If a target lacks armor (vehicle with shot-away sides, lampposts, buildings) then the weapon does twice the damage it normally would. If a recoilless rifle scores a critical hit, roll two dice, then double that number for the damage done. A shotgun would do 4 hits of damage if it got a critical hit on an unarmored pedestrian.

Hand weapons that usually do not affect vehicle components have the chance to do so when achieving a critical hit, but still only do half normal damage. When firing at an unarmored vehicle component, such as an exposed power plant, with a hand weapon, a critical hit will do full damage.

Collision Damage

Damage from a collision is handled differently. It is divided evenly among all exposed (i.e., "outside") components on the affected side. For instance, if a car with two front MGs had no front armor left, and took 3 points of damage from enemy fire, you would roll randomly to see which MG took the 3 hits. However, if that same car took 3 points of collision damage to the front, it would be divided evenly between the exposed systems (the weapons) — 2 hits on one and 1 on the other. Thus, collision damage cannot penetrate to the interior of a vehicle until all armor on that side, and all components "outside" the one to be affected, have been completely destroyed.

4. Combat Results

Injury to Drivers

Most humans have 3 DP; they are wounded by the first hit, knocked unconscious by the second, and killed by the third. Standard body armor, when worn, also has three damage points. Body armor takes damage first, effectively doubling a character's hit points. Hits taken by a driver's body armor are no hazard, but if a vehicle's driver is wounded or killed, it is a D2 hazard.

Uncontrolled Vehicles

If a motorcycle's driver is killed or knocked unconscious, the cycle goes to Crash Table 1 immediately, adding 4 to its roll. Any passengers must jump or suffer the consequences of the roll. Any other ground vehicle (including a cycle with a sidecar) will continue in a straight line if the driver is incapacitated. It decelerates 5 mph each turn, moving in a straight line until it stops or hits something.

Substitute Drivers

If a cycle's driver is incapacitated, a sidecar passenger can steer the cycle, but cannot use the brakes or accelerator. He can fire any weapon, but not on any turn that he steers the cycle.

If a larger vehicle's driver is incapacitated, a front-seat gunner or passenger may attempt to take control. (Note: No vehicle may have more than two seats in front.) He may operate all vehicle controls, or the weapons, but not both. Each maneuver he makes has an extra D2 of difficulty.

If a driverless vehicle can be stopped, it will take 5 turns (5 seconds) to push the late driver out or off and move any other occupant of the vehicle in as a new driver. On the 6th turn, the new driver may start to accelerate and/or fire.

Fire and Explosion

A vehicle which crashes may catch fire (see Crash Tables, p. 11). A vehicle hit in combat may also catch fire, as follows: 2 in 6 chance of catching fire on any turn that 10-24 hits are taken from flamethrowers, flaming oil, and/or lasers; 3 in 6 chance on any turn that 25 or more hits are taken from those weapons mentioned above; 2 in 6 chance on any turn that the vehicle's power plant, flamethrowers, or flaming oil jets are hit by enemy fire; 4 in 6 chance if those items take damage from laser, flamethrower, or flaming oil jet fire.

If a vehicle has a fire extinguisher, there is a 3 in 6 chance the fire will go out at the end of each turn (4 in 6 if the vehicle has the improved fire extinguisher). If the extinguisher does not put the fire out at the end of the turn, the fire does one hit of damage to each occupant (body armor will take damage first), each vehicle component (including tires), and the armor on each part of the car.

A burning vehicle may explode if it contains any type of flamethrower, flaming oil jet, any type of rocket or missile weapon, AT gun, or tank gun. If the fire is not extinguished, roll one die at the end of each turn. On a roll of 1, the vehicle explodes, scattering debris (see Section IV). All occupants are killed immediately. Pedestrians or vehicles within 2" take 1 die of damage to the exposed side (if there are two exposed sides, the owner picks which side takes the damage).

Here's the sequence of rolls: If the vehicle has taken damage that could cause a fire, roll at the end of the turn to see if fire breaks out. If fire breaks out, and the vehicle has a fire extinguisher, then roll to see if the fire extinguisher puts out the fire. If the fire extinguisher succeeds at this point, no damage is taken from fire. If the fire extinguisher fails (or the target didn't have one), each vehicle component takes one hit of damage as outlined above. If the fire is still burning after the fire extinguisher roll, then make one more roll for possible explosion as outlined above.

Fire and Explosion — A Variant

Again, this is an optional rule. If you like it, please use it. If you don't, feel free to ignore it.

Every weapon that has a chance to set a vehicle on fire is rated on the table below for two factors: "Fire Modifier" and "Burn Duration." Fire Modifier is the number the attacker must roll (or roll under) to set the target vehicle on fire. Burn Duration is the number of turns after the initial hit the fire modifier is in effect. All fire modifiers are cumulative.

Vehicular Fire Table

Weapon Type	Fire Modifier	Burn Duration
Flamethrower	4	3
Heavy Duty Flamethrower	5	3
Light Laser	0	0
Laser	1	0
Heavy Laser	2	0
Flaming Oil Jet	3	2
Heavy Duty Flaming Oil Jet	3	2
Hand-Held Flamethrower	3	2

Example: On turn one, our intrepid duellist gets hit by a single flamethrower shot. The FT (we see on the table) has a fire modifier of 4, so the attacker must roll a 4 or less on 2 dice to set the target vehicle on fire. He rolls an 11, which isn't even close. The next turn, the flamethrower misses, but our hero does get hit by a laser. The laser has a fire modifier of 1, but this is also the first turn of the flamethrower's three-turn burn duration — that's 4 more for a total of 5. The attacker, needing a 5 or less to start a fire, rolls a 6 — tough luck.

On the third turn, the flamethrower misses again, but the laser hits for the second time, and our hero drives through some flaming oil. The fire modifiers are 1 (for the laser) plus 3 (for the flaming oil) plus 4 (for the second turn of the FT's burn duration), for a total of 8. The attacker,

needing only to roll an 8 or less, comes up with a 7. Our hero's on fire — let's hope he has a fire extinguisher.

Fireproof armor (see Section VIII, *Car Design*) remains just that — fireproof — under these rules. If an exposed power plant, flaming oil jet, or flamethrower takes damage, use the rules in the main section to determine whether or not there's a fire.

This system could also be used as an option for determining whether or not a building has been set on fire. Some building materials, like steel and concrete, would have a negative modifier on the fire modifier of all weapons that hit it (-2, perhaps). Wood, on the other hand, would burn fairly easily — maybe a +4 or so.



5. Odds and Ends

Automatic Fire

If a weapon is on "automatic," it will fire each turn until it runs out of ammo or is taken off automatic. Putting a weapon on automatic is a firing action, as is taking it off automatic. Letting it fire during the intervening turns is not a firing action. If you have a weapon on automatic, you may fire an additional weapon that turn.

This advantage, however, is offset by the inaccuracy of automatic fire. A weapon on automatic is not being aimed by the driver or anything else. It fires straight ahead (or behind, or to the side, depending on what side the weapon is mounted on). A turreted weapon cannot be put on automatic. A weapon on automatic cannot target an opposing vehicle's tire or turret or any other specific target. A weapon on automatic does not benefit from targeting computers. Putting a weapon on automatic breaks sustained fire, and subsequent shots do not get a sustained fire bonus.

When a vehicle lays down automatic fire, calculate the attack from that weapon at the end of all movement for that turn. Draw an imaginary line straight out from the middle of the side the automatic weapon is on — if a target (vehicle, pedestrian, building) crosses that line, figure all the standard modifiers, and roll the dice. Putting a weapon on automatic is very effective for doing property damage and dealing with large groups of opponents; if you're duelling with just one or two other vehicles, automatic fire is probably a waste of ammo. Dropped weapons and paint/smoke weapons can benefit greatly from automatic fire (see below).

Dropped Weapons

Minedroppers, Spikedroppers, Oil Jets, and Flaming Oil Jets are *dropped weapons*. Dropped weapons do not require to-hit rolls. The appropriate counter is simply placed behind the firing vehicle (for a rear-mounted weapon) or to the side (for a side-mounted weapon). See diagram below.

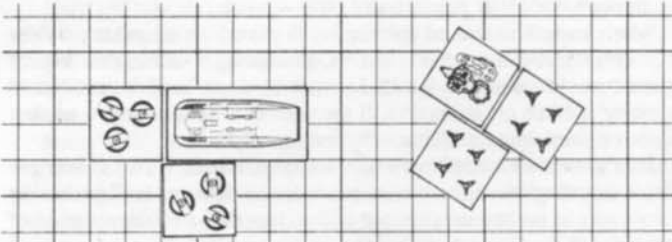

If a dropped weapon is put on automatic, a counter of the appropriate type is placed behind the vehicle *every phase* the vehicle moves. It will continue to do this until it runs out of ammo or is taken off automatic. If a vehicle is not moving, a dropped weapon on automatic will fire once a turn.

The counters for mines and spikes show *approximately* where they are. If a vehicle crosses a tire-spike counter, roll once for each tire on that vehicle. On a roll of 1-4, the tire takes 1 die of damage. If a vehicle crosses any square adjacent to the counter (see diagram below), roll once for each of its tires; on a 1 or 2, the tire takes 1 die of damage. Spikes will stay on the road indefinitely. Solid tires are immune to spike damage.

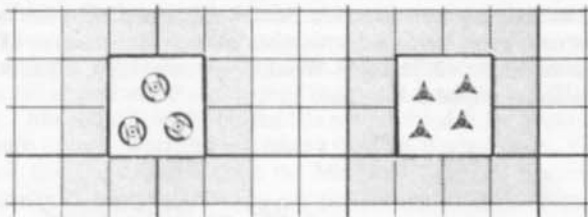

Mine counters work the same way, except that if any wheel of a vehicle crosses the counter, the mines will go off on a roll of 1-4. If the vehicle only crosses an adjacent square, the mines explode on a 1 or 2. Each tire within 1" of any edge of the mine counter takes 1 die of damage, and the underbody of the vehicle that set the mines off takes 2 dice of damage. The Spear 1000 mine works the same way, except that tires only take 1d-3 points of damage, while the underbody takes 2d+3! After a particular set of mines has been set off, the counter is removed.

Mines may also be remote-controlled, either by radio or by cable. Setting off mines in this way counts as a firing action, but the mines go off when you want them to. If you want mines that will go off either by remote control *or* when they're run over, double the cost.

An oil slick is defined by the edge of the counter. When any part of a vehicle crosses an oil slick counter, it adds D2 to the difficulty of any maneuver attempted; it also adds D2 to the severity of any hazard encountered (such as enemy fire); it is not a hazard in itself. Flaming oil slicks add D3 to any maneuver or hazard, and also cause damage to underbody and tires, as described in the notes following the Weapon List. Oil slicks last indefinitely, but flaming oil disappears after five turns (see description in weapon notes above).

Each vehicle checks only once for each counter — on the phase it first runs over the counter, or (if it's just going to touch the adjacent square area) the first phase it enters an adjacent square. Of course, if the vehicle returns to the counter's location, it will have to roll again.

Paint and Smoke

Paint (purple clouds) and smoke (black clouds) may be produced by rear-mounted or side-mounted weapons (see diagrams below). Do not try to line up a cloud with the grid lines. Orient it according to the vehicle's position. Smokescreens and paint clouds remain stationary. The life of a smoke cloud is one minute (longer than most battles will take). The life of a paint spray is one second. Remove it at the end of the turn after the one in which it is fired.

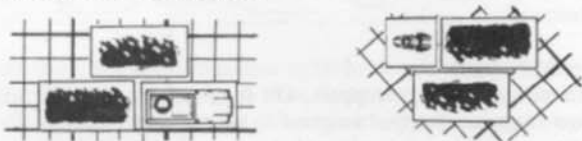

Any vehicle trying to trace line of fire through paint or smoke must subtract 2 from its to-hit roll for each cloud in the way. Lasers cannot fire through smoke or paint at all.

When a smokescreen or paint spray is placed on automatic, it fires once every phase the vehicle moves, producing a continuous line of paint or smoke counters. It will continue to do so until it runs out of ammo or is taken off automatic. If the vehicle is not moving, a smokescreen or paint spray on automatic fires once per turn.

Tear gas can be loaded in a smokescreen (CPS 50, WPS 1). Tear gas affects targeting the same way regular smoke does, as well as having serious effects on any unprotected pedestrians (for a full description of tear gas, see the Grenade rules later in this section).

Any vehicle which comes into contact with a paint cloud gets paint on its windows. The vehicle will make all to hit rolls at a -2 for the rest of that turn and the next three turns; after that, the windshield washers will have cleaned it off. Both paint and smoke are available in just about any color.

Linked Weapons

Another way to get more firepower per turn out of your vehicle is to link weapons. A weapons link costs \$50, and has no space or weight requirements. Two or more identical weapons firing from the same side (or in a turret) may be linked, aimed, and fired together. It is not necessary for linked weapons to be fired together — a link is essentially a third button, in addition to the first two, that fires both weapons simultaneously. You can still press one of the first two buttons to fire a single weapon, if you want.

When linked weapons are fired, make a separate to-hit roll for each linked weapon. All modifiers — negative or positive — that affect one linked weapon affect them all, including targeting computers, gunner skill, and range.

Links can themselves be linked, provided all the weapons are identical. Four heavy rockets, linked in pairs that are also linked, gives the firer a number of options — fire any one, fire either of two pairs, or fire them all — at any time. Only identical weapons may be linked *and* aimed together. Weapons of the same family (a machine gun and a Vulcan MG, or a heavy rocket and a medium rocket) cannot be linked for one effect.

Weapons that are not identical *can* be linked, but only *one* can be aimed. The other weapon(s) are treated as if they are on automatic (except they fire when the button is pushed, and not at the end of the turn). The firer can pick which weapon he wishes to aim, and which one will be treated as automatic (see above for rules on automatic fire). If two identical weapons are linked with a third, different, weapon, then the two identical weapons may be aimed together and the third is treated as if it were on automatic.

Turreted weapons cannot be linked with weapons in the main body of the vehicle, or in another turret. Any type of dropped weapon or paint/smoke weapon can be linked with anything with no penalty, since they do not require to-hit rolls. A common tactic is to link a number of minedroppers and smokescreens together and fire them simultaneously to discourage pursuit.



6. Hand Weapons

Any character (driver, gunner, passenger, or pedestrian) may use a hand weapon any turn he or she does not fire a vehicle weapon. For game purposes, hand weapons take up no weight or space. However, no character may carry more than 6 grenades or grenade-equivalents of equipment. A pistol counts as a grenade-equivalent; a rifle, shotgun, or SMG counts as two. As cargo, a box of 12 grenades weighs 50 pounds and takes up one space. For a complete rundown on hand weapons, see the Hand Weapon List in Section VI, *Pedestrians*.

Hand weapons do not get bonuses for computer aiming, but all other modifications listed for vehicular weapons apply. Handgunner skill is used with hand weapons, instead of the Gunner skill.

Hand weapons have little effect on vehicles — vehicle components are too heavily built. Submachine guns and grenades do their full 1 die of damage only on tires and humans; on other targets, they do half damage (rounded down). Other hand weapons affect only tires and people.

Range

A grenade may be thrown up to 5" (see below for more on grenades). Other hand weapons have a maximum range of 20" for game purposes.

Firing Penalties and Bonuses

The driver of a moving vehicle must subtract 3 from his to-hit roll with any hand weapon. Gunners or passengers subtract 1. Pedestrians or stationary characters fire at the listed values. In certain situations, pedestrians may get bonuses for firing from a braced position. Firing

from inside a moving vehicle is not considered "braced," but firing from a stationary vehicle is.

Grenades

Grenades come in a number of types, but all share some similarities. They have a simple time-delay switch (0 to 5 seconds), and an activation switch. Setting the time-delay takes one second, but they can be set ahead of time. Changing the time delay also takes one second.

To throw a grenade, simply start the timer by pressing the activation switch, and throw it. The grenade will go off at the end of the turn in which the timer stops. If you set the timer at 0, it will go off at the end of the turn in which you press the switch. Grenades fired from vehicular or hand-held launchers are automatically activated upon firing.

The to-hit roll for a thrown grenade is 9 or better on two dice. But that's misleading, because even a successful roll will not put the grenade in the exact square you were aiming for, unless you roll a natural 12. On a 12, the grenade lands in the exact $\frac{1}{4}$ " square you were aiming for. Any other die roll is a miss of one degree or another.

Any grenade toss that is less than the best possible (a 12) will deviate from the intended target. This deviation has two components — Direction and Distance. Or, to put it another way, which way did it go, and how badly did you miss?

Direction — Roll one die, and consult the following:

- 1 — Off to the right.
- 2 — Off to the left.
- 3 — On line, but short.
- 4 — On line, but long.
- 5 — Off to the right, and either long or short (roll randomly).
- 6 — Off to the left, and either long or short (roll randomly).

Distance — How far the grenade lands from the intended spot depends on how badly you missed your to-hit roll:

Made your roll or higher but rolled less than 12 — 1-3 $\frac{1}{4}$ " squares in each direction called for by the direction roll.

Missed by 1 — 1d-1 (treat a 0 result as 1) squares in each direction called for.

Missed by 2 — 1d+1 squares in each direction called for.

Missed by 3 — 2d-2 (treat a 0 result as 1) squares in each direction called for.

Missed by 4 or 5 — 2d+3 squares in each direction called for.

Missed by 6 or more — 3d squares (8 squares minimum) in each direction called for.

If the line of flight for the grenade is diagonal to the grid lines, just remember that each square is $\frac{1}{4}$ ", and use a ruler to determine the final location of the grenade.

Example: George thinks an enemy vehicle is about to slip out a side alley, so he wants to toss a grenade into the open area where the alley

intersects the street. George picks a target square and rolls the dice. He needs a 9 or better to hit, but rolls an 8. Not bad, but a miss. Next George rolls on the Direction table, and rolls a 5 — off to the right, and either short or long. George assigns "evens" to long, and rolls another 5 — indicating the grenade came up short, too.

Next, George consults the Distance table — "missed by 1" means the grenade is off by 1d-1 squares in each direction called for by the first set of rolls, rolled separately. George's grenade is both to the right and short of his intended spot. George rolls a 2, then a 3 — so the grenade ends up one square (2-1) to the right, and two squares (3-1) short of the intended target. Not bad at all!

If a grenade hits a large solid object — like a building or a car — while in flight, it will bounce 1d-1 squares and stop. The direction it bounces is determined by the angle at which the grenade hits the solid object. If the grenade hits the object squarely, it bounces straight back toward the thrower. If it strikes at an angle, it will bounce off at the same angle, away from the thrower.

The maximum range for a thrown grenade is 5", and standard range penalties apply — that is, if your intended spot is 4" to 5" away, there is a -1 penalty to hit, and if your intended spot is less than 1" away, there is a +4 bonus. If your intended spot is less than 1" away, you cannot miss by more than two squares in any direction. In no case can a grenade end up behind the thrower — if the distance "short" is greater than the distance attempted in the first place, place the grenade at the thrower's feet. Also, a grenade thrower may place a grenade in his own or any adjacent square without having to roll to hit at all.

A grenade may be thrown from a moving vehicle at -2. There is no "automatic hit" for adjacent squares, but the +4 point-blank bonus would apply. A grenade dropped from a vehicle could go in any direction. A roll of 2 or 3 indicates disaster — the grenade is dropped inside the vehicle and rolls under the seat — or something equally nasty.

Grenade counters are provided to help you keep track of where they all end up.

7. Buildings

Breaches and Collapsing Buildings

A building is at +10 to hit. It's big and doesn't move (so the +10 takes the "stationary" bonus into account). Each building has a DP value indicating the strength of its walls. Any weapon doing at least this much damage will produce a "breach." Lesser damage has no effect. Example: A building has 10 DP. A weapon result of 10 points damage or more will produce a breach at the affected spot. However, any number of smaller hits may accumulate without causing harm — there is no need to keep track of building damage that does not create a breach. A breach, once created, is identical to a door or window for game purposes.

When a building accumulates breaches equal to its DP value, it will collapse. (A DP 4 building falls after 4 breaches. The DP 10 building mentioned above will take 10 breaches before it collapses.) It does not matter where the breaches are. When a building falls, it creates rubble (see below). The fall of a building does not affect nearby buildings — even those with which it shares a wall. However, a breach in a common wall will affect both buildings.

Everyone and everything inside a falling building suffers as many dice of damage as the building has DP. For example, a 6 DP building will do 6 dice of damage to anyone and anything inside.

Cars will take this damage to their top armor. If any top armor is left after the collapse, people inside the car will be safe — trapped, but safe. They won't be able to get out for as many turns as the building had DP. They'll still have to deal with the rubble as pedestrians after they escape the car.

Some buildings will have two different DP numbers, with the second one in parentheses. The first number will be the number of damage points required to create a breach, and the second will be the number of breaches needed to collapse the building. For many buildings, this will be the same number — and only one number will be used. But for some buildings, it's not logical. An example is a barn — only a few damage points will create a single breach, but it will take lots of breaches to collapse it. A barn like this will be described as having 4(15) DP — it only takes 4 damage points to create a breach, but the barn won't collapse



until 15 breaches are made. When a building with two DP numbers collapses, use the first to determine the amount of damage it does, etc. (see above).

When a building collapses, it becomes rubble. No vehicles may enter rubble. Pedestrians may move through rubble at one square per second — moving only on Phase 1 of a turn. Rubble takes up the same squares that the building did.

Rubble continues to block line-of-sight between roads, just as if the building was still there. If the firer or the target is in an elevated position, rubble can be sighted over, however. A pedestrian in rubble can fire as though the rubble was not there; he is considered "braced" and gets the +1 bonus to hit. A pedestrian in rubble may be fired on, but the attack is at -4.

Collapse of a building will also scatter debris. When something collapses, take a dozen debris counters and drop them over the disaster site from a height of one foot, redropping any that fail to land on the street.

Cover

A line of sight may be traced through any door, window, or breach. Therefore, a pedestrian may stand inside a building and fire outside. He must, however, be adjacent to the door or window for this line of sight to be traced.

A pedestrian leaning around an edge of a door or window presents a very small target. Therefore, although he may be fired at, he has the protection of the wall. He is not hit unless the wall is breached. Example: A pedestrian is leaning out a window, looking for a good shot, when a duellist with a laser tries to take him out. The duellist needs an 8 to hit, and gets it. The wall has 6 DP. The duellist rolls 10 points of damage with his laser. Six go to the wall (breaching it); the other 4 go to the pedestrian. If the wall had not been breached (if it had 12 DP, for example), the pedestrian would have been unharmed.

However, a very good shot can go right through a door or window. If the roll to hit is at least 2 better than needed (in the above example, if the duellist had rolled a 10), then both the pedestrian and the wall take full damage.

Height Modifications

Situations may arise where duellists in cars want to shoot at pedes-

trians on rooftops; or a pedestrian gun battle may involve exchanging shots across a street into buildings. Firing at any target that is on a higher level than you is at a -1 for every 10 feet of height difference. Firing downward is at no penalty, but throwing things (like grenades) is: -1 for every 10 feet of height difference. Each level of a multi-story building is assumed to be 10 feet high. Some heights — a third-story rooftop, and fourth floor or higher — cannot be hit by regular vehicular weapons on street level, unless the firing vehicle is further away from the target than the target is high. Universal turrets (used to fight helicopters — see Section VIII, *Car Design*) and hand weapons are the only way to fire on them.

Missing

In most cases, a missed shot rockets off into the stratosphere, never to be seen again. In a scenario involving buildings, this is clearly inappropriate. A missed shot fired horizontally goes in a straight line until it leaves the map or hits an obstacle, like a building. If another vehicle or pedestrian is in the exact line of fire, you can roll to hit, taking into account any additional range penalties and another -2 because you weren't aiming at him. When a "miss" does hit something, it does standard damage.

For shots fired upward, roll one die. On a 1 or 2, the shot hits one story higher than intended; on a 3 or 4, it hits two stories higher; on a 5 or 6, it misses everything and is gone.

For shots fired downward, a miss will overshoot the intended target by 1 to 6 inches.

If you try to put a grenade through a window and miss, the grenade lands at the base of the building below the window in question.

Burning Buildings

If a building is set on fire (a 50% chance every time it is hit by a laser, a flamethrower, or flaming oil), place an "on fire" marker on it. Since most *Car Wars* battles last less than a minute, the effects on the players will be minimal — but for long-term campaigns, it can be significant. The variant fire rules mentioned above can be used for this as well.



VI. Pedestrians

Not everyone has a car. Vehicles may face challenges from enemies on foot — or a driver may leave a wrecked vehicle and sprint for safety, tossing a grenade as he goes. A pedestrian is represented by a counter that is $\frac{1}{2}$ " x $\frac{1}{4}$ ". The pedestrian is considered to be in just the front half of the counter — a single $\frac{1}{4}$ " square. The larger counter is provided for ease of handling. Anyone firing on a pedestrian must trace a line of fire to the particular square the pedestrian is in, not just any part of the entire counter. Pedestrian counters should always be lined up with the map grid.

1. Movement

The base movement rate for pedestrians is 12.5 mph, or five $\frac{1}{4}$ " squares per turn. You can elect to go slower, and there are ways of going faster (see below). The best way to determine the phases in which you move is to multiply your pedestrian's speed by 4 and consult the appropriate line on the vehicle Movement Chart. Move $\frac{1}{4}$ " in each phase the chart indicates. For example, someone moving 17.5 mph would move $\frac{1}{4}$ " in each phase indicated on the Movement Chart for 70 mph.

Going Faster

Spending points to increase your Running ability (see Section VII, *Continuing Characters*) will increase your base speed. For short periods of time, you may also opt to Sprint. A Sprinting character increases his speed 5 mph for up to 10 seconds. After the 10 seconds, the character can continue to run, but only at his base speed, and only for a maximum of 10 more seconds. Then he must stop and rest. After Sprinting, a character must stop and rest for 1 second for every 2 seconds spent Sprinting; if he Sprinted for 6 seconds, he must rest for 3, for example. A character who is resting can do nothing except catch his breath. You cannot Sprint up a flight of stairs, and you cannot fire a weapon while Sprinting — but if you need to get under cover fast, the extra speed could save your life.

There is no limit to the number of direction changes a pedestrian can make — no need to bother with Handling Classes, Control Rolls, or crashing.

Stairs

Stairways are marked on *Car Wars* maps as a series of squares, with every other square marked with a floor number. When a pedestrian reaches the numbered square corresponding to the floor he is on, he must stop. On phase 1 of the next turn, he may move one square up or down. On phase 1 of the turn after that, he may move again. This continues until he reaches the floor he wants. On the turn after reaching the correctly numbered square, the pedestrian may move on that floor normally. The uppermost box of many staircases is marked "R," and represents a hatch to the roof of the building. It takes one turn to move from the "R" square to any adjacent square — then movement continues normally.

2. Combat

Pedestrians may use hand weapons only. A complete list is provided on p. 25. A pedestrian may only fire once a turn. Once a pedestrian fires, he may not move for the rest of the turn. A Sprinting pedestrian may not fire at all. Pedestrians have 3 Damage Points — the first hit wounds, the second knocks unconscious, and the third kills. They can wear body armor. Pedestrians may carry up to 6 grenades or grenade-equivalents worth of equipment.

If a vehicle collides with a pedestrian, use the collision system in Section 5. Remember, pedestrians have a damage modifier of $\frac{1}{2}$. The collision system can also be used if pedestrians run into each other.

Hand-to-Hand Combat

For one pedestrian to strike another, he must be in a square adjacent to his intended victim. He must roll a 2 or higher to hit, but all targeting

modifiers (except for the point-blank range bonus) are in effect, including the -3 for targeting a pedestrian, so the net effect is that — most of the time — he will need a 5 or better on two dice. A human fist does 1d-5 damage. If the attacker has something heavy in his hand — a pistol, an unused grenade, or a rock (any debris marker will yield something appropriate), the damage roll is 1d-4. The Martial Arts skill (see Section VII, *Continuing Characters*) can also affect the results of hand-to-hand combat.

If a pedestrian has moved more than half his movement allowance in a given turn, he cannot attack hand-to-hand this turn.

A pedestrian may also make a "hand-to-hand" attack against an adjacent vehicle. He must have something to hit it with — a bare-handed attack against vehicle armor is pointless. A pedestrian with a rock or other object may strike a vehicle once per turn (no to-hit roll is needed). He does 1d-5 damage. A hand weapon used in this fashion will no longer be useful as anything but a club.

A hand weapon may also do damage to a vehicle in a more conventional way. Any hand weapon fired from point blank range at a stationary vehicle hits automatically, doing one point of damage. Any hand weapon that would ordinarily do more than one point of damage against a vehicle (such as the SMG), gets the higher damage.

Spikes, Oil, and Mines

It's possible for pedestrians to run afoul of the nasty surprises dropped on city streets and intended for vehicles. When a pedestrian enters a square covered by a spike counter (not the adjacent area, but the counter itself), he must roll two dice. On a 2 or 3, the pedestrian takes 1d-4 points of damage.

A pedestrian on oil is more likely to resemble a Keystone Kop than Clint Eastwood. When a pedestrian enters a square with oil on it, he rolls two dice. He must roll a 5 or better to stay on his feet. If he moves immediately to another square with oil, he must roll a 7; then a 9, and then an 11 for each subsequent square. If a pedestrian falls, he can either spend an entire second to stand up — which still requires a roll of 7 or better on two dice to accomplish — or crawl, moving only during Phases 4 and 7.

Flaming oil has the same traveling difficulties as regular oil — except pedestrians also take one point of damage at the end of every turn they're in it. Body armor does protect against damage from flaming oil.

The weight of a pedestrian will not set off mines.



3. Pedestrians and Vehicles

A pedestrian must stand beside a cycle for one full turn (1 second) to get on. The next turn, he is astride it. He must remain motionless for 3 seconds, this being about the time necessary to get a cycle running. After the 3 seconds, he can move normally. A driver getting off a cycle (or out of a vehicle) must spend one full turn beside it after coming to a complete stop (time to dismount) and then may run normally.

A driver or passenger may jump from a moving vehicle. Roll for damage as if the jumper were hit by a vehicle (with a damage modifier of 1) going 10 mph slower than the vehicle was going. The jumper lands in any adjacent square, and may move and/or fire beginning the next turn.

It would take about 30 seconds to pick up and restart a fallen cycle of any size. Most combats won't last that long.

To enter a larger vehicle, a pedestrian must stand beside it for one turn (opening the door). On the next turn, he may enter. If the vehicle is not running, it will take 3 seconds to start it. If that's the case, it cannot move until the 4th turn — but it may begin firing weapons immediately.

Boarding Vehicles

To climb onto the outside of a vehicle, a pedestrian must make a roll, as follows:

Vehicle speed 10 mph or less: automatic success
15 mph: roll 4 or more on 2 dice
20 mph: roll 5 or more on 2 dice
25 mph: roll 7 or more on 2 dice
30 mph: roll 9 or more on 2 dice
35 mph: roll 10 or more on 2 dice
40 mph: roll 11 or more on 2 dice
45 mph or greater: impossible

A pedestrian trying to board a tractor reads the table at 5 mph higher than the vehicle's actual speed. In other words, a pedestrian trying to board a tractor moving 15 mph reads the table at 20 mph. A pedestrian trying to board any vehicle from the side reads the table at 15 mph higher than the vehicle's speed. These penalties are not cumulative (i.e., you don't add 20 mph when trying to board a tractor from the side). Use the worst applicable modifier. A pedestrian may attempt to



board a vehicle any time the vehicle is in an adjacent square.

Being noticed: A pedestrian boarding an occupied bus or trailer will be noticed 5 out of 6 times. A pedestrian boarding an unoccupied trailer hitched to an occupied tractor will be noticed 3 out of 6 times. You cannot board any other occupied vehicle without being noticed. These chances can be modified at the referee's discretion for weather, poor visibility, well-planned distraction, etc.

Dropping On: A pedestrian may also drop onto the top of any vehicle if it passes directly beneath him. Roll two dice:

4 or better to land on a bus or any trailer except a tanker.
5 or better to land on a tractor (double damage for failure)
6 or better to land on a tanker (the top is curved!)
6 or better to land on a pickup or van
7 or better to land on a luxury or mid-sized
8 or better to land on a compact or subcompact.

Subtract 1 from the roll if the weather is bad. Subtract 1 if the vehicle is going 20 to 30 mph, 3 if it's going 35 or 40 mph, and an additional 2 for every 10 mph faster. A character who drops onto a vehicle has the same chance to be noticed as one who climbs aboard.

Vehicle-to-Vehicle: A person on one vehicle may try to jump or climb to another while both are moving. If the vehicles are within $\frac{1}{4}$ " of each other, use the climbing-aboard rules — determine the relative speeds of the two vehicles, and read the appropriate line. Because of the difficulty, subtract two from your roll. If the vehicles are more than $\frac{1}{4}$ " apart, but less than $\frac{3}{4}$ ", use the dropping-on rules — again, subtract two from your roll. The being-noticed rules are the same.

Failure: If you miss your roll, you hit the ground. Use the rules for jumping from moving vehicles to determine how much damage is taken.

Movement on top of a vehicle: A pedestrian can only move around atop an oversized vehicle or in a pickup bed. There is no place to go on a smaller vehicle! It takes one second to reach the top of a vehicle from the ground, or to stand up after dropping onto it. A pedestrian can safely move one square per turn (in Phase 10) while on top of a moving vehicle. Moving faster involves risks: Moving twice a turn (in Phases 5 and 10) requires a roll of 4 or better on 2 dice to stay on; moving three times (in Phases 3, 6, and 9) requires a roll of 6 or better to stay on. Moving any faster is not practical (or wise). A pedestrian who fails that roll is automatically noticed, and takes damage as above for jumping off a vehicle.

A pedestrian atop a vehicle can fire his weapon, throw grenades, etc., normally. He can also plant a limpet mine; no die roll is needed to succeed at this.

A pedestrian on a vehicle will be subject to fire from a turret on that vehicle, if he is at that turret's level. Use common sense to determine this. Examples: A pedestrian atop a bus can be hit by a turret on the bus, or on another bus the same size. A man in the bed of a pickup cannot be hit by a turret on the pickup's cab, unless he stands up. A pedestrian on a trailer cannot be hit by a turret on the tractor, since the trailer top is higher than the tractor. A pedestrian cannot hide behind or on top of a turret; it moves quickly enough that he would be thrown off.

A pedestrian on a vehicle can also attack its front, side, top, and back-mounted weapons, using his own hand weapon, if he can move adjacent to the appropriate side/end of the vehicle. He automatically hits, doing one point of damage; there is a 50% chance each time that the damage will bypass the armor and hit the weapon directly.

Getting off: If a vehicle crashes with a person on top, it is assumed the pedestrian jumped clear, taking normal damage as described above. A person could also attempt to "swing down" from a moving vehicle. The chance of making it without injury, and of not getting noticed, is the same as for climbing aboard at the same speed.

Any hazardous event or maneuver may throw riders off the top of a vehicle. When a vehicle undergoes any D2 or greater hazard, or any D3 or greater maneuver, anyone on board must roll to stay on. The roll is 3 or better on 2 dice, plus 1 for every 10 mph the vehicle is moving — 8 or better at 50 mph, for example.

A trailer has clearance of better than 2 feet above the ground. Thus, no normal vehicle can pass under a trailer. However, a pedestrian could move (or hide) under a stationary trailer, provided he crawled (moving in Phases 4 and 7 only).

Hand Weapon List

Weapon	Abbrev.	Grenade-equiv.	Damage	To Hit	Cost	Shots	CPS	L. cst.	Notes
Submachine Gun	SMG	2	1 die	6	250	10	12	370	a
Rifle	—	2	3 hits	7	120	20	1	140	
Shotgun	—	2	2 hits	6	120	10	1	130	
Heavy Pistol	HP	1	2 hits	7	100	8	1	108	
Light Pistol	LP	1	1 hit	8	75	8	1	83	
Grenade	—	1	1 die	9	25	1	—	25	b
Tear Gas Grenade	TG	1	—	9	30	1	—	30	c
Smoke Grenade	SG	1	—	9	20	1	—	20	d
Concussion Grenade	CG	1	1 hit	9	40	1	—	40	e
Paint Grenade	PG	1	—	9	20	1	—	20	f
Limpet Mine	LM	1	1 die	—	60	1	—	60	g
Grenade Launcher	GL	2	—	7	300	5	—	—	h
Light Anti-Tank Weapon	LAW	2	2 dice	8	500	1	—	500	i
Very Light Anti-Tank Weapon	VLAW	1	1 die	8	200	1	—	200	j
Tripod Recoilless Rifle	TRR	5	2 dice	7	1500	3	35	1605	k
Recoilless Rifle clip	—	2	—	—	50	3	35	155	
Tripod Machine Gun	TMG	5	1 die	7	1000	20	25	1500	l
Machine Gun clip	—	2	—	—	50	20	25	550	
Portable Flamethrower	PF	5	1 die	6	750	5	25	875	m

Abbreviations: *Grenade-equiv.* — Grenade-equivalent, a measure of bulk and weight that determines a pedestrian's carrying capacity. Pedestrians can normally carry 6 grenade-equivalents of equipment; *CPS* — cost per shot; *L. cst.* — loaded cost.

Notes

a. *Submachine Gun* — Does half damage to vehicles.

b. *Grenade* — Does one die damage in a 2'' burst effect radius to tires and non-vehicular items, half damage to vehicles.

c. *Tear Gas Grenade* — Creates a 1'' x 1'' cloud that lasts one minute. Effects on weapon and laser fire the same as for smoke. Unprotected pedestrians and cyclists must roll once per turn any turn they are in a cloud. Multiple rolls don't produce cumulative results — just apply the worst result rolled so far:

1 — Character unconscious for five minutes.

2-4 — For one minute, character is -6 to hit with any weapon, and can only crawl at 3 squares per turn.

5-6 — Character is -2 to hit with any weapon for this turn and 3 more turns.

d. *Smoke Grenade* — Creates a 1'' x 1'' smoke cloud that is standard in every other way. Available in a variety of colors.

e. *Concussion Grenade* — Does 1 point of damage to pedestrians or exposed cyclists in a 1'' burst effect radius, but has an additional effect on all people within a 2'' radius. Roll one die:

1-2 — Character unconscious for 10 minutes.

3 — Character unconscious for 1 minute and stunned (-3 to hit with any weapon, movement reduced by 2 squares per turn, reflexes dropped to 0 if a driver) for 2 more minutes.

4 — Character unconscious for 10 seconds and stunned for 2 more minutes.

5 — Character stunned for 30 seconds.

6 — Character stunned for 10 seconds.

7+ — No effect.

Characters inside a vehicle with intact armor between them and the blast add 3 to their roll. Characters with a building, wall, or other solid cover between them and the blast add 5.

f. *Paint Grenade* — Creates a 1'' x 1'' paint cloud that is standard in every other way. Also available in a variety of colors.

g. *Limpet Mine* — Looks like a grenade, but can be delayed up to 15 minutes when set; will stick to any fairly smooth surface, using a super-

glue in plastic beads that breaks and adheres when the mine is placed; if placed on a vehicle, will do 1 die of damage in a 2'' burst effect radius (just like a grenade), but also does 1d+1 damage to the armor below the mine! If placed directly over a weapon port, the damage will go directly to the weapon! Will not stick if thrown — it must be placed by hand.

h. *Grenade Launcher* — Maximum range is 20''. Treat misses the same as for thrown grenades. Any type of grenade set on any delay may be mixed into the five-shot clip — but the grenades are fired in order, so keep track.

i. *Light Anti-Tank Weapon* — Does full damage to vehicles; does an additional 1 die of damage to pedestrians in a 2'' burst effect radius.

j. *Very Light Anti-Tank Weapon* — Does full damage to vehicles; does an additional half die of damage to pedestrians in a 2'' burst effect radius.

k. *Tripod Recoilless Rifle* — Does full damage to vehicles; loading a new belt takes 2 seconds. If firer is hit by a weapon capable of damaging vehicle, there is a 50% chance the weapon will take damage first; it has 2 DP.

l. *Tripod Machine Gun* — Does full damage to vehicles; loading a new belt takes 2 seconds. If firer is hit by a weapon capable of damaging a vehicle, there is a 50% chance the weapon will take damage first; it has 2 DP.

m. *Portable Flamethrower* — Does full damage to vehicles; can be used as an area effect weapon against pedestrians. Maximum range is 5''. It creates a standard smoke cloud in the direction of fire every time it is used. The firer's maximum movement cannot exceed 5 squares per turn, regardless of bonuses. If the firer takes any sort of damage, there is a 2 in 6 chance that the PFT is hit first; it has 2 DP. If the PFT is hit, there is a 1 in 6 chance that it will explode, killing the firer instantly and creating one standard smoke cloud, aligned randomly.

Ammo clips for other hand weapons cost \$50 plus the cost of the ammo, carry as many shots as the weapon originally, and weigh ½ grenade-equivalent (1 grenade-equiv. for the SMG).

VII. Continuing Characters



Car Wars characters are identical in many ways: They all weigh 150 pounds, they all take up 2 spaces as vehicle crew members, and they all have 3 damage points. There are enough differences to keep things interesting, however. Differences come in three categories: Skills, Prestige, and Wealth.

1. Skills

A number of skills are available to characters — these are listed below. A character who has a skill at the *base level* can perform that skill with no penalties or bonuses. Higher skill levels are designated by plusses: With training and experience, a character with the base skill "Driver" can improve it to "Driver +1," and with even more improvement, move to "Driver +2," "Driver +3," and so on. In the course of adventures, you will gain "skill points." Some skill points can only be spent on particular skills, while others can be spent on any skill.

When you first create a character, you get the base skill "Running" automatically (everybody knows how to run), plus a total of 30 skill points to spend as you wish. Each base level skill acquired during character creation costs 10 skill points. Each additional skill level costs 10 points.

You can spend the 30 beginning skill points to acquire 3 base level skills; or you can get one skill at base level and a second at +1. You could even sink all 30 points into buying one skill at +2, but your character would be pretty one-dimensional. You can use some of your initial allotment of skill points to improve your Running skill, and you can spend less than 10 skill points in a category — although why anyone would want to do this is not clear.

In the course of a campaign, getting additional plusses in a skill you already have is pretty easy. Gaining a totally new skill isn't. In addition to spending the 10 skill points to acquire a new skill at base level, a character must also spend \$1,000 and take 3 months off (in game time) for training. The only exception is the Mechanic skill (see below).

Skill Descriptions

Driver: This is the ability to drive a standard car, pickup, van, etc. — anything with 4 or 6 wheels — in a combat situation. A character without this skill may attempt to drive such a vehicle, but always subtracts 2 from his handling class. At the base level, the character is an average driver. Each additional plus adds to that character's reflex roll. At the beginning of each combat, every driver of a vehicle makes a reflex roll: On a 5, the HC of the vehicle is raised by one for the duration of the combat; on a 6, the HC goes up by 2. A Driver +2, for example, would get to add 2 to the die roll. Each additional plus is also added to the base HC of a vehicle to determine how many points are recovered on the Handling Track at the beginning of each turn.

Every time a character drives a vehicle into combat and survives, one skill point is earned toward increasing Driver ability. (Combat is defined as an incident in which a vehicle is fired on by enemies and fires back.) The driver of a vehicle that scores a "kill" in combat gets an ad-

ditional point toward increasing Driver ability.

A "kill" is scored when an enemy vehicle can no longer move or fire, either because of a direct attack, a crash during combat, surrender of the occupants, or other circumstance. The occupants do not have to die. Killing a pedestrian does not count as a kill. (A bully hiding behind armor should get no credit for zapping a relatively harmless pedestrian with a laser!) If a vehicle can no longer move, but still has operable weapons, it is not a kill. If those weapons have a restricted arc of fire, however, and you move out of that arc and then threaten to blast them into hamburger unless they surrender, it is probable that they will give up. If the crew abandons a vehicle, surrenders, or sprints for safety on foot, that counts as a kill. If a wounded vehicle escapes to safety, that does not.

Cyclist: This is the ability to drive any size motorcycle or trike. Anyone without this skill will be -3 on the handling class of any cycle he tries to ride. Each plus is worth one on the cyclist's reflex roll. Participating in a combat is worth one skill point toward improving Cyclist skill only. Driving a cycle that scores a kill is also worth one skill point toward improving Cyclist skill.

Trucker: This is the ability to drive any oversized vehicle: A bus, RV, ten-wheeled truck, or tractor-trailer rig. A non-Trucker subtracts 2 from HC when trying to drive an oversized vehicle — -4 if he doesn't have the Driver skill either! Each plus adds one to the Trucker's reflex roll at the beginning of combat. As with the first two skills, skill points can be gained by entering a combat or driving a truck that scores a kill — but those points count only toward the Trucker skill.

Pilot: This is the ability to fly a helicopter. Characters without this skill can barely start a helicopter, much less get it off the ground. Each plus adds to the pilot's reflex roll in determining the chopper's HC for a given battle. Entering a battle and scoring a kill are worth one skill point each — but those points can only be used toward the Pilot skill.

Gunner: This is the ability to manipulate the targeting system common to all vehicles, and to fire any vehicular weapon. A character without this skill is a -3 to hit with any vehicular weapon. Each plus adds one to the gunner's to-hit roll: A character with Gunner +3 adds three to any to-hit rolls he makes. Entering a combat or scoring a kill is worth a skill point toward improvement in Gunner. Note that if the driver of a vehicle also pulls the trigger of the weapon that scores a kill, that character gets a skill point in both Gunner and Driver for the kill.

Handgunner: The ability to fire hand weapons and throw grenades. Characters without this ability are -2 to hit with all aimed hand weapons. There is no penalty for throwing grenades if you don't have this skill. Each plus gives a +1 to hit with all hand weapons — including thrown grenades. If you are firing hand weapons from a vehicle, no skill points are awarded. If you are a pedestrian, entering combat is worth one skill point; killing another pedestrian is worth one point; scoring a kill against a vehicle is worth five skill points. As always, these points can be used only to improve the skill used to earn them.

Running: Everyone gets this skill at its base level. Each plus adds 2.5 mph to a character's speed — with Running +3, you move at 20 mph and Sprint at 25 mph! No character may move faster than 25 mph (even while Sprinting), no matter how many plusses he has. There is no way to earn points specifically in Running, but *general* skill points (see below) may be spent to improve the skill.

Martial Arts: This is the ability to fight more effectively hand-to-hand. Characters with the base skill may attack twice per turn hand-to-hand. At +1, they get +1 to their to-hit roll; at +2, they get an additional point of damage. The cycle repeats beyond that: At +3, the character gets an additional attack per turn; at +4, he gets an additional +1 on the to-hit roll; at +5, he gets an additional damage point; and so on. Using Martial Arts in combat is worth a skill point; killing or subduing another person via Martial Arts is worth another skill point. These points are good only towards Martial Arts improvement.

Paramedic: This skill helps save characters' lives when they've been injured. If a character has 1 DP left (that is, he's unconscious), a successful roll (7 or better on 2 dice) will bring the character back to consciousness. However, the character will remain conscious only for a few minutes (long enough to get some important information, for exam-

ple). If a character is at 0 DP but not below, and the medic can get to him within 20 turns of the fatal injury, a successful roll will save the character's life. He will remain at 0 DP, but will be alive. DP are healed at the rate of one every week of game time. If a character is below 0 DP, or the medic doesn't get there in time, or fails his roll (only one chance), the character is dead. Each plus adds one to the die roll — a Paramedic +1 succeeds on a 6 or better, a +2 on a 5 or better, etc. Every successful use of the Paramedic skill is worth 2 skill points toward improvement of that skill.

Mechanic: The ability to repair vehicles and components. The time it takes to repair something (if it can be repaired at all) is a function of the character's Mechanic skill, as well as the difficulty of the job and the tools that are available.

Repair Chart

Level	Triv.	Easy	Med.	Hard	Very Hard
No skill	2	11	x	x	x
Mechanic	1	9	11	12	x
Mechanic +1	1	7	9	11	14
Mechanic +2	1	5	7	9	11
Mechanic +3	1	3	5	7	11

To perform a given repair job, a Mechanic must roll two dice, and get the number shown on the chart (or higher). He may try once per hour (30 minutes for a Mechanic +3). An "x" means the job is impossible at that skill level. These numbers assume the mechanic has basic tools. If he is working with improvised tools (pocket knife, chewing gum, baling wire), subtract 2 from all rolls. If he has a portable shop (an accessory that will be described later), add 1. If he is working in a regular garage, add 2. A successful roll repairs one point of damage on the item in question (3 points if armor is being repaired), or successfully installs/dismounts/salvages the item in question.

Any number of mechanics can work on the same vehicle, but no more than three can work on the same item at once. Each one rolls separately for success.

Some repair jobs are more difficult than others. Consult the following list:

Impossible (cannot be attempted): repair damaged tires, repair computer.

Very Hard: Jury-rig rocket, missile, or laser; repair helicopter rotor.

Hard: Jury-rig other components; repair laser, rocket, missile, radio, or power plant.

Medium: Repair any weapon other than laser, rocket, or missile; re-weld or patch armor; remount kingpin on tractor-trailer rig; repair fifth wheel on tractor; salvage radio, power plant, or computer from a wreck.

Easy: Replace weapon link; salvage other items from a wreck.

Trivial (even someone with no Mechanic skill can do this): Reload ammunition; replace or salvage tire; salvage spare magazines and unused ammunition from a wreck.

Repair is the process of fixing a damaged part. Each time a successful roll is made, one DP is restored to the item (or three points in the case of armor). If a component is totally destroyed, it cannot be repaired — only jury-rigged.

Jury-Rigging is a temporary repair job. If the proper roll is made, the jury-rigged component gets one DP back, putting it back in service. A jury-rigged component can never be properly repaired, and if it is damaged again, it cannot be jury-rigged a second time. Some items will be destroyed so totally that they cannot even be jury-rigged — like what's left of a cycle after a head-on collision with an 18-wheeler.

Salvage is the removal of a part from a wreck. A mechanic needs to make the appropriate repair roll once to salvage any given part.

Installation is the opposite of salvage — putting a new part in to replace a destroyed one. The old part must first be "salvaged" (that is, removed), even if it was totally destroyed. The roll to install any part is the same as the roll to repair it — see the chart above. When the roll is successfully made, the part is installed.

If a character wants to learn this skill (or improve it if he started with it), the only way is to spend game time as a full-time mechanic at a duel arena, truck stop, or garage. Since this is not especially thrilling, most high-level mechanics will be the referee's characters, or player-characters that started by taking Mechanic +1 or +2. If a character decides to drop out of duelling to become a mechanic, it takes one year (during which he also earns \$6,000 above living expenses) to get the basic skill. It takes 2 more years (clearing \$8,000 a year) to get to +1, 3 more years (clearing \$10,000 a year) to get to +2, and 5 more years (clearing \$15,000 a year) to get to +3. A Mechanic +3 has a fairly safe life and earns \$20,000 a year above living expenses. Mechanics may rise no higher than +3.

General Skill Points

In addition to earning specific skill points for specific actions, the referee should award general skill points at the end of an adventure. These points are just like the other skill points, except the player may apply them anywhere he wants, including saving them up to acquire a new skill at base level. Some suggestions for general skill point awards:

- Winning an arena event: +3
- Surviving an arena event: +1
- Conspicuous bravery: +2
- Risking your life to save a teammate or friend: +2
- Using an unusual tactic: +1
- Escaping an ambush alive: +1
- Successfully knocking out a vehicle so that it can be salvaged: +1
- Winning a highway duel: +1
- Winning a highway duel when you're outnumbered: +2
- Completing a mission or adventure: Depends on the length and complexity of the task, but anywhere from +5 to +15 would be appropriate.

This list is far from complete. Spectacular escapes against overwhelming odds, brilliant tactics, or just plain lucky breaks could be situations worth extra skill points. While the players and even spectators are welcome to provide input on how many points should be awarded, the referee's decision is final.

2. Prestige

This is a character's status among other autoduellists and the millions of TV autoduel fans. Prestige increases a character's possible arena winnings and decreases his expenditures for new cars, parts, repairs, etc.

Each character starts with 0 prestige. Arena combat always counts for prestige; road combat may affect prestige. There is a 2 in 6 chance that any road combat will have been witnessed or filmed by helicopter TV crews, in which case it scores normal prestige. Otherwise, you're an unsung hero for that fight — no prestige. In some situations (inside a city, in an area with competing TV stations that devote more time to autoduelling, etc.), the chance of a witnessing TV crew may be higher. That decision is up to the referee.

An ace is a character who has participated in 5 confirmed kills — that is, arena kills or road kills that were witnessed. A double ace is a character with 10 confirmed kills.

Prestige is scored as follows:

- For entering combat: +1
- For each kill your vehicle scores: +2
- Your vehicle "killed" but you survive unhurt: -1
- Your vehicle "killed" but you survive with injury: -2
- You leave your vehicle while it can both move and fire: -1
- You leave the arena in a vehicle that can both move and fire: -1
- You attack with hand weapons while outside a vehicle: +1
- You kill a vehicle occupied by a character with prestige over 15: +1
- You kill a vehicle occupied by a character with prestige over 20: +2
- You become an ace: +5
- You become a double ace: +10

A character may earn up to 3 extra prestige points per game for excellent play, lucky shots, or survival against bad odds. These points are awarded by majority vote of the players and onlookers during that game. The referee breaks ties.

Being killed lowers prestige: -1 for a heroic death, -2 for an ordinary combat death, -3 for a mundane death, -5 for a cowardly death.

Advantages of Prestige

In any arena combat where cash prizes are offered, a character with prestige of 10 or better earns a percentage bonus equal to his prestige; that is, a prestige of 17 earns a 17% bonus. In addition, a character with prestige of 15 or better gets a 25% discount on all new car purchases and repairs (for his own use only); prestige of 25 or better earns a 50% discount. This is in return for the champion's sponsorship of various brands of ammunition, autos, weapons, etc.

3. Wealth

Each character begins with zero wealth. He can get started in a number of ways — he could enter an arena scenario in which the network supplies vehicles for aspiring drivers (see Section XIV, *Scenarios*). Or he could be hired as a gunner for a highway convoy. However a character gets started, there are several ways he can earn money.

Selling cars: A car may be sold for salvage after it has been used (then the driver can enter another Amateur Night scenario . . .). Most arena contests give a survivor the right to salvage his kills, too.

Arena prizes: This is the big money. The referee for a continuing arena campaign may set cash prizes. A typical purse would be from 1/2 to 1 1/2 times the total value of the vehicles competing.

Road salvage: You can earn money the way the cycle gangs do: pick a fight on the road, and strip your kill for salvage.

Perform missions: Many refereed adventures involve doing something hazardous (deliver an item or person to another city, protect a certain person, steal a certain item) for pay. These can be very profitable, but the risk is high and the characters should be well-equipped and experienced. Not for beginners.

Transactions with other players: Car sales, used (but still working) equipment, side bets, and whatever else you think of.

Other than car repairs and ammo purchases, the only expense a continuing character has is \$150 per week for food, a place to stay, and power plant recharges. A character with no money must sell something or starve. A character with no money and no car is obviously afraid to enter the arena, so his prestige drops to zero and he's out of the game.



4. Keeping Your Character Alive

An adventurous character can have a very short life. This can be frustrating if you spend an hour working up a character, and he dies in fifteen minutes. There are three ways around this. The first, of course, is to run for home when the bullets start flying. This is safe enough, but not too interesting. Two good alternatives:

Organizations

Instead of playing an individual, you can play a whole group. You can run a trucking company, bus line, cycle gang, local police department, autoduelling club, vigilante group, hijacking ring, or a truck stop. When an individual character dies, you can replace him — and the rest of the organization goes on. This lets you standardize cars and equipment . . . and if a character gets killed, his savings go to the organization. A good campaign can have several such groups, sometimes coop-

erating and sometimes fighting, with plenty of room left for people who want to play individual characters.

Gold Cross

This is a real *life*-insurance plan, made possible by the miracles of medicine available to the wealthy in the year 2035. If referees wish to ignore this section and make their campaign a little (or a *lot*) more deadly, feel free.

Basically, Gold Cross is a clone bank. A few cells from your body are quickly grown into a mature clone. The clone will be in perfect health, and will seem about 25 years old. Should anything happen to you, your clone can be activated — and you live again! Your new body will be legally recognized as "you," and will have access to your bank account, ownership of your material goods, etc.

Naturally, there are a few catches. The process is expensive (see fee schedule, below). When something happens to you, your body must be transported to the Gold Cross center where your clone is kept, and it must get there within 24 hours of your death — or within a week if the body is frozen within 24 hours of death. A totally burned body, or a body that took more than 10 hits damage, cannot be "read." If your body gets there in time, though, the clone can be programmed with all your memories, up to the moment of death, and all your skills.

As an alternative to rushing your body to Gold Cross after something happens, you can transfer your memories to your clone before anything happens to you — just to play it safe. This way, no matter what happens, your clone can be activated. A new memory transfer has to be made every month, or the clone mind will go blank. In the past, memories could only be stored in the human brain. The year 2035 saw the development of a mechanical memory storage device (or MMSD).

The MMSD is a permanent repository for your memories, unlike the unactivated clone, which must be reprogrammed monthly. In the event you are no longer around, the MMSD can be used to program a clone. It's very expensive, and not very portable. In general, MMSDs must be moved on wheeled dollies — they weigh 800 pounds and take up six spaces as cargo.

If you let more than one month go by without re-programming your clone (and you have no MMSD), and something happens to you, your own body is the only source of your memories — so if something permanent happens to you, you're really dead. Note also that if your clone is activated from an old memory transfer or an MMSD, the clone will have only the memories and skills you had when you programmed it. Furthermore, it takes a month to grow a new clone. Unless you can afford to keep two clone bodies in storage or have an MMSD, don't get killed more than once a month.

In all cases, the donor (alive or dead), or his MMSD must be present to transfer memories. This process takes less than an hour.

When something happens to you, Gold Cross will act as soon as they hear about it — preparing your clone for activation if your body is on the way, awakening a previously-programmed clone if that is necessary, or transferring the memories from your MMSD to a clone body. In most cases, notification must come from the friends of the temporarily deceased character.

Gold Cross has offices in all major cities. Its services are available to everyone, though wanted criminals often have to pay a substantial bribe to a doctor or administrator. It's a mercenary operation, as might be expected of anyone selling new lives. Keep Gold Cross paid, and they are very reliable. Miss a payment, and your clone will get chopped up for organ transplants.

The Gold Cross fee schedule:

- To grow a clone body: \$10,000
- First programming, a month after starting clone: \$1,000
- Each monthly reprogramming thereafter: \$3,000
- To program (or update) an MMSD: \$25,000
- Keeping clone alive if it is not reprogrammed monthly: \$1,000/month
- To read a dead body (or MMSD) into an unprogrammed clone: \$5,000
- To send refrigerated vehicle or helicopter for a body (on request): Variable, but always high! At least \$5,000 for simple missions, lots more for long distances or hazardous travel.

VIII. Car Design

Building a new car is complicated — just ask Detroit. When you first design a new vehicle, don't be surprised if it takes a little while. You must work within several constraints: Space available in the body size you pick, weight that chassis can carry, and money available. You have to make sure the car has enough power for decent acceleration. Within all these limits, you want enough armor and weapons to give you a chance to survive. And remember to allow money and weight for ammunition! When you come up with a good vehicle design, save it for later reference — or add it to the stock car list for your local arena.

On the back cover of this rulebook is a Vehicle Planning Sheet — photocopy it and use it! It's extremely handy in keeping track of total weight, spaces, and cost of your vehicle as you build it — and it won't let you forget something obvious, like the tires.

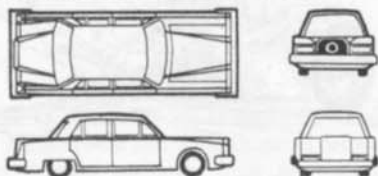

1. Body Types

There are seven types of cars available to duellists, ranging from the tiny subcompacts to the rolling armories that are vans.

Type	Price	Weight	Max. load	Spaces
Subcompact	\$300	1000	2300	7
Compact	\$400	1300	3700	10
Mid-sized	\$600	1600	4800	13
Luxury	\$800	1800	5500	19
Station wagon	\$800	1800	5500	14(+7)
Pickup	\$900	2100	6500	13(+11)
Van	\$1000	2000	6000	24(+6)

Price is the dollar cost of the body without armor, but with headlights, trim, seats, doors, instruments, basic targeting system, heads-up windshield visual display, etc. *Weight* is the weight of the body and frame — it counts toward the *total weight* of the vehicle. *Maximum load* is the total weight (including the body and frame) the vehicle is allowed. Maximum load *can* be altered — see "Chassis," below). *Spaces* is the number of spaces available in the vehicle for equipment, weapons, and people. Those vehicles with additional spaces listed in parentheses have cargo areas that can carry the number of spaces listed. Cargo areas cannot be used for vehicle components (with an occasional exception that will be detailed later), but must be used for cargo.

2. Chassis

The chassis can be strengthened (or weakened) to allow a vehicle to carry more (or less) weight.

Strength	Weight Modifier	Price
Light	-10%	-20%
Standard	none	none
Heavy	+10%	+50%
Extra Heavy	+20%	+100%

The price modifier is a percentage of the original body price. For example, putting a Heavy chassis on a mid-sized car would increase the maximum load 10% — from 4,800 to 5,280 (that's 4,800 + 480) — but would cost 50% of the original body price — another \$300. Chassis strength is not a factor in vehicle weight or interior space.

Any van or pickup may have a six-wheeled chassis. It costs an extra \$100, plus the cost of the extra tires. Pickups and vans with extra-heavy chassis *must* have six wheels.

3. Suspension

Suspension determines a vehicle's beginning Handling Class (see Section IV, *Movement*).

Suspension	Price	HC	Van HC
Light	no extra	1	0
Improved	100% of body cost	2	1
Heavy	150% of body cost	3	2
Off-road	500% of body cost	2	1

Light suspension is standard. Better suspensions cost in relation to the original body cost of the vehicle — a Heavy suspension for a Luxury car would cost \$1200 (150% of \$800). Suspension adds no weight and takes no interior space. The HC of a van (or of a pickup over 5500 lbs.) is one less than that of a lighter vehicle with the same suspension. Off-road suspensions negate the handling class penalty for driving off-road (see "Off-Road Duelling," Section XIV, *Scenarios*).

4. Power Plants

The power plants in vehicles of 2035 are not the internal combustion engines of 50 years earlier. Instead, they are a multiple-fuel-cell system which supplies electrical power to separate motors in each wheel of a vehicle. Power plants take up space and weight inside a vehicle.

Plant	Cost	Weight	Spaces	DP	Power	Max. spd.
Small	\$500	500	3	5	800	80
Medium	\$1000	700	4	8	1400	90
Large	\$2000	900	5	10	2000	100
Super	\$3000	1100	6	12	2600	100
T-cat	\$12000	2000	8	15	6700	120

DP is "damage points," the number of hits required to destroy the power plant. When the power plant is lost, a vehicle can no longer fire lasers or accelerate, but all other systems still work. The vehicle decelerates 5 mph per turn (more if you put on the brakes). Power Factors are used to compute acceleration, which is more fully detailed later in this section. Weight, Spaces, and Maximum Speed should be self-explanatory.

The Thundercat power plant is a special high-performance plant designed for towing large loads. It can also be used for tremendous acceleration. A referee may decide that a plant this powerful will not be available in a particular campaign — though the high cost should keep it out of cars with any sort of price limit.

Going Faster

Vehicles may accelerate beyond their power plant's listed maximum speed, but the power plant will probably take damage.

Each turn a vehicle travels faster than its rated speed, roll one die for every 10 mph (or fraction) faster the vehicle is going. For each die that comes up 3 or higher, the power plant takes one point of damage.

Example: A car with an acceleration of 5 and a maximum speed of 100 is travelling at 100 mph and needs to catch a foe. So the car accelerates to 105, and the driver rolls one die. He rolls a 1, so no damage is taken — so far. The next turn, the car continues to accelerate to 110, and again one die is rolled — this time a 5. The plant takes one point of damage. The next turn, the driver punches it to 115, and rolls two dice — a 4 and a 5. The plant takes two more points of damage. One turn later, our foolhardy driver pushes it to 120, and rolls two dice again — this time a 2 and a 6. The plant takes one more point of damage. The driver holds the vehicle at 120 and continues to roll two dice for possible plant damage for as many turns as he feels he can get away with it. Once he decides to slow down, he can decelerate 5 mph per turn just by taking his foot off the accelerator — and he no longer has to roll for plant damage, even if he's still over 100, because the plant is no longer under strain.

A power plant reduced to 0 DP by overwork will explode on the first phase of the next turn. All adjacent components (usually front weapons and the driver and gunner) take 1d-2 points of damage; there is a 50% chance the vehicle will catch fire.

Vehicle Range

The subject of vehicle range has very little importance in the city or in the arena. But on the long stretches of highway between oases of civilization, running out of power is like signing your own death warrant.

Any fully-charged power plant has 200 miles worth of power, assuming travel at normal highway speeds — 55 mph. These 200 “power units” will last longer at lower speeds, and get eaten up quickly at higher ones. For example:

- 40 mph: 9 power units per 10 miles travelled
- 55 mph: 10 power units/10 miles
- 60 mph: 11 power units/10 miles
- 70 mph: 13 power units/10 miles
- 80 mph: 15 power units/10 miles
- 90 mph: 17 power units/10 miles
- 100 mph: 20 power units/10 miles

Speeds beyond the listed maximum for a given plant drain power even faster. Every turn spent over the maximum costs one power unit per full 10 mph over the limit. If a plant has a maximum speed of 90 mph, there is no additional penalty at 95, but it costs one power unit for each turn at 100 or 105, two power units for each turn at 110 or 115, and so on.

Laser fire also drains power plants. Every time you fire a light laser, it costs you 1 power unit. A shot from a regular laser costs 2 power units, and a shot from a heavy laser costs 3 power units.

Power plant recharges are readily available in towns, but on the highways they are usually available only at truck stops. A power plant recharge takes 10 minutes (most facilities can take two vehicles at a time) and costs \$20 for a cycle or trike, \$50 for a car, \$100 for an oversized vehicle, and \$250 for a helicopter.

Duplicate Power Plants

You may put a second power plant in a vehicle, either to run auxiliary systems (like lasers), or to provide a backup in case the first plant runs out of juice or is knocked out of action. It is a simple matter to rig a switch between the two plants — when one runs out of power, simply switch over to the other one. The two plants do not have to be the same type, but if different types are used, recalculation of acceleration may be necessary when the switch is made. You can *not* combine power factors by running both plants at once.

A second power plant may be put in the cargo area of a vehicle, but there are some additional costs to cover the need for vibration protection, cooling, and extra regulation equipment. Any power plant put in cargo costs \$500 more, weighs 200 more pounds, and takes up 4 more spaces than the plant normally would. Referees who feel that the second plant idea unbalances campaigns are more than welcome to ignore it altogether.

5. Tires

To keep the bookkeeping as simple as possible, the weight of tires *does* count against the maximum load of the vehicle. A car's front tires must both be the same type, and the rear tires must be the same type (but tires needn't match front to rear) — handling class drops by one if this rule is broken.

Tire	Price	Weight	DP
Standard	\$50	30	4
Heavy-Duty	\$100	40	6
Puncture-Resistant	\$200	50	9
PR Radials	\$500	60	8
Solid	\$500	75	12
Off-road solid	\$600	80	12

Spare tires carried as cargo take up one space. Even though they all

have the same cost and weight, a luxury standard spare tire (for example) will not fit on a subcompact car. In most cases, you cannot mix tires from different size vehicles. There are two exceptions: Luxury cars and station wagons use the same size tire, as do vans and pickups.

The Puncture-Resistant Radial has a special advantage — any car with PRRs on all wheels has its handling class raised by 1. The maximum handling class for a vehicle is still 3, but if a vehicle has a lower HC than 3 to start with, the PR Radial can be a useful item.



6. Weapons

Weapons are usually mounted on the front, back, right, or left. Technically, they can also be mounted on the top or bottom, but they're not nearly as useful in those positions. Weapons may also be mounted in turrets.

For complete information on the following weapons, see Section V, *Combat*.

Weapon Statistics List

Weapon	Loaded Cost	Loaded Wt.	Spaces	DP
Machine Gun	1500	200	1	3
Vulcan MG	2700	450	2	3
Autocannon	7250	600	3	4
Flamethrower	750	500	2	2
HD Flamethrower	1750	750	3	3
Rocket Launcher	1350	250	2	2
MM Launcher	950	125	1	2
Radar-guided Missile	7000	400	2	1
Wire-guided Missile	3300	230	2	2
Recoilless Rifle	1850	350	2	4
Anti-tank Gun	2500	700	3	5
Light Laser	3000	200	1	2
Laser	8000	500	2	2
Heavy Laser	12000	1000	3	2
Tank Gun	11000	1400	10	10
Minedropper	1000	200	2	2
Spear 1000 MD	1250	200	2	2
Spikedropper	300	75	1	4
Smokescreen	350	75	1	4
HD Smokescreen	900	250	2	4
Paint Sprayer	650	75	1	2
HD Paint Sprayer	1200	130	2	3
Oil Jet	500	75	2	3
Heavy Duty Oil Jet	900	130	2	4
Oil Gun	1250	300	3	3
Flaming Oil Jet	1175	80	2	3
HD Flaming Oil Jet	1950	140	3	4
Grenade Launcher	1000	200	2	2
Starshell Launcher	750	125	1	2
Heavy Rocket	200	100	1	2
Medium Rocket	140	50	1	2
Light Rocket	75	25	½	1
Mini Rocket	50	20	¼	1
Multi-fire Rocket Pod	450	150	2	3
Bomb	100	100	1	2
Cluster Bomb	200	150	1	2

7. Armor

Cars carry armor in six positions: Front, back, left, right, top, and bottom. You can put different amounts of armor in different locations, but the cost per point is the same, no matter the location. The cost and weight (\$/wt) per point of armor do vary according to the size of the vehicle, however. There are also a few special types of armor available to duellists — that can affect the cost and weight of armor, as well. Consult the following table for details:

Car type	Normal (\$/wt)	FP (\$/wt)	LR (\$/wt)	LRFP (\$/wt)
Subcompact	11/5	22/5	12.1/5.5	27.5/5.5
Compact	13/6	26/6	14.3/6.6	31.5/6.6
Mid-sized	16/8	32/8	17.6/8.8	40/8.8
Luxury	20/10	40/10	22/11	50/11
Station Wagon	20/10	40/10	22/11	50/11
Pickup	22/11	44/11	24.2/12.1	55/12.1
Van	30/14	60/14	33/15.4	75/15.4

Fireproof Armor (FP) costs twice as much as normal armor, but weighs the same. As the name indicates, fireproof armor cannot be set on fire. It takes damage normally from all weapons, including flamethrowers and lasers, but if the armor is all that is damaged, you do not roll for the possibility of fire — it can't happen. If the armor is breached and internal components are damaged, regular fire rules apply to the inside. Fireproof armor cannot be mixed with regular armor — the vehicle must be all fireproof or all regular. Repairing FP armor is at triple normal cost (see "Repair and Salvage," later in this section).

Reflective Armor (LR) takes damage normally from all weapons except lasers. All types of lasers do half damage (round down) to reflective armor. Furthermore, lasers cannot set fire to reflective armor (though flamethrowers can). Once the armor has been breached, internal components are liable to normal chances of fire. Reflective armor costs and weighs 10% more than regular armor, and costs twice as much to repair as regular armor. Reflective armor cannot be mixed with regular armor.

Reflective Fireproof Armor (LRFP) combines the features of both types: It takes half damage from lasers (rounded down), and cannot be set on fire. It costs 2½ times normal armor, weighs 10% more than normal armor, and costs four times as much to repair. It, too, cannot be mixed with other types of armor.

If any cost or weight calculations using the above table result in fractions of dollars or pounds, round to the nearest whole number.

8. Accessories

Many accessories are available to duellists. Some are defensive in nature; some are decidedly offensive; others are just plain convenient. Restrictions may apply to the use of many of these accessories, so read each description carefully.

Offense

Extra Magazine: One space, 15 lbs., \$50, plus the cost and weight of ammunition. Doubles the number of shots of any vehicular weapon that uses ammunition. A machine gun with an extra magazine would have 40 shots; a recoilless rifle with an extra magazine would have 20 shots; lasers and rockets don't have "ammunition," per se, so extra magazines don't apply. Each extra magazine also adds 1 DP to the weapon. An extra magazine does not count against the weapon space limit of a turret — it is considered to be below the turret.

Targeting Computer: No space or weight, \$1,000. Adds +1 to all to hit rolls for any single vehicular position (driver or gunner, but not both). It is destroyed when the power plant is destroyed.

Hi-Res Targeting Computer: No space or weight, \$4,000. As above, but adds +2 to the roll. Computers cannot be combined for extra accuracy.

Cyberlink: 1 space, 100 lbs., \$16,000, 1 DP. This computerized

helmet links the wearer to one particular weapon (or linked set of weapons), and gives the wearer +3 to hit, with that weapon only. The Cyberlink cannot be combined with other targeting computers.

Turrets: Turrets take up space in a vehicle, but in turn can hold a number of spaces' worth of weapons that does not count against the vehicle's space limit. A pop-up turret hides inside the vehicle, possibly lulling an opponent into thinking you're not as well-armed as you really are. Raising or lowering a pop-up turret is a firing action and takes one turn.

One-space Turret: 1 space, 150 lbs., \$1,000.

One-space Pop-up Turret: 3 spaces, 300 lbs., \$2,000.

Two-space Turret: 2 spaces, 200 lbs., \$1,500.

Two-space Pop-up Turret: 4 spaces, 350 lbs., \$2,500.

Three-space Turret: 2 spaces, 300 lbs., \$2,500.

Three-space Pop-up Turret: 5 spaces, 450 lbs., \$3,500.

Four-space Turret: 2 spaces, 400 lbs., \$3,500.

Four-space Pop-up Turret: 6 spaces, 600 lbs., \$4,500.

Three-space turrets will fit only on vans, oversized vehicles, and standard (or larger) helicopters. Four-space turrets will fit only on oversized vehicles or transport helicopters.

Cupolas: A cupola is a turret that carries a gunner inside it with the weapon. A three-space cupola can hold a gunner and a one-space weapon (a machine gun, for example). The cupola gunner has a +1 to hit, but he can fire only the cupola weapon, and if the top armor is penetrated, the gunner takes damage before the weapon does. A cupola can be designed to be entered from outside or inside the vehicle, but not both. Pop-up cupolas work like pop-up turrets, above.

Three-space Cupola: 2 spaces, 400 lbs., \$3,500.

Three-space Pop-up Cupola: 5 spaces, 600 lbs., \$4,500.

Four-space Cupola: 2 spaces, 500 lbs., \$5,500.

Four-space Pop-up Cupola: 6 spaces, 750 lbs., \$6,500.

Three-space cupolas can only be mounted in vans, oversized vehicles or standard (or larger) helicopters. Four-space cupolas may only be mounted in oversized vehicles or transport helicopters.

Universal Turrets and Cupolas: Normally, turret and cupola weapons may not fire higher than a 45-degree angle. A universal turret or cupola can fire straight up (or straight down if mounted on the underside of a helicopter). It costs \$1,000 more than a normal turret or cupola of the same size, and does not add to the weight or space.

Weapons Linkage: No space or weight, \$50. Links any two weapons of the same type firing in the same direction, or more than two if in a turret. For a more complete discussion, see the section on weapon links in Section V, *Combat*.

Rocket Platform: No space, 200 lbs., \$150, plus the cost and weight of the rockets, 2 DP. The rocket platform is mounted outside a vehicle, and can carry up to 3 spaces' worth of any type of rocket — from heavy to mini. It can only be mounted on vans or oversized vehicles, and is exposed — if the top armor is hit, the rockets and the platform take damage first. The rocket platform may be targeted like a turret: -2. If a vehicle can mount only one turret, it can only have one rocket platform — not a rocket platform *and* a turret.

Anti-personnel Flechette Grenade: No space or weight, \$50. These grenades are mounted on the outside of a vehicle, and detonated from within. The explosion throws a cloud of plastic splinters at high velocity, doing 1 die of damage to any exposed pedestrians and cyclists in a 2" radius. Anyone inside or behind a vehicle is shielded from the blast. Every time the side of a vehicle with an AP grenade is hit by enemy fire, there is a 1 in 6 chance that the AP grenade will be destroyed. If all the armor is destroyed, or the vehicle rolls onto a side mounting AP grenades, all the grenades on that side are destroyed automatically. No more than one grenade may be placed for every 7.5 feet of vehicle length — a 30-foot bus, for example, could have one in front, one in back, and four along all four long sides (left, right, top, and bottom) — 18 in all. After an AP grenade has been fired, it only costs \$25 to replace.

Cycle Blades: No space, 20 lbs., \$50. These jagged blades add 2 points of damage to any damage a pedestrian takes when hit by a cycle. If the cycle just passes adjacent to a pedestrian, there is a 50% chance the blades will hit, doing 1 hit if the cycle is going 20 mph or less, 2 hits at 25 or 30, 3 hits at 35 or 40, and so on. Doing this successfully is a D2 hazard for the cycle. Blades mounted to armor are destroyed when all the armor in that position is destroyed. If there is no armor in that position, the blades are welded directly to the frame and are not destroyed unless the vehicle rolls.

Car Blades: As above, but the cost and weight is the same as 3 points of armor for that vehicle.

Fake Blades: Instead of the real thing, fake blades can be mounted on a car or a cycle. They cost \$20, and take up no weight or space. They're great for scaring pedestrians, but not much else.

Ram Plate: Can be installed on the front of any car, oversized vehicle, or reversed trike. When a vehicle with a ram plate is involved in a collision to the front (where the ram plate is), the collision damage the vehicle takes is halved, while the collision damage inflicted to the other object is doubled! A ram plate is bought in addition to the front armor: Its cost is 1.5 times the cost of the front armor, and the weight is .5 times the weight of the front armor. These costs and weights are figured separately, and then added to the total cost and weight of the vehicle.

For example, 50 pts. of front armor on a luxury car costs \$1,000 and weighs 500 lbs. A ram plate on that car would cost an additional \$1,500, and weigh an additional 250 lbs. If the vehicle has fireproof or reflective armor, the ram plate must also be fireproof and reflective — the cost and weight calculations are made from the final cost and weight of the front armor. A ram plate is destroyed when all the front armor is destroyed.

Defense

Fire Extinguisher: 1 space, 150 lbs., \$300. Roll one die at the end of each turn a vehicle equipped with this item is on fire. On a 1-3, the fire is put out. The fire extinguisher is destroyed when the power plant is destroyed.

Improved Fire Extinguisher: 1 space, 200 lbs., \$500. Will put out a fire on a 1-4 on one die. Otherwise, identical to the regular fire extinguisher.

Wheelguards: No space, 4 lbs. and \$10 per point of armor. Wheelguards must be bought separately for each tire location, and have a maximum of 10 points. When a tire is targeted and hit, roll one die. On a 1-4, the wheelguard is hit instead. Wheelguards mounted on the front wheels of a car or a reversed trike reduce the handling class of the vehicle by 1. Can be made fireproof or laser reflective at the standard increases in cost and weight. Wheelguard armor type does not have to match the rest of the vehicle.

Retractable Wheelguards: As above, but an additional 1 space, 50 lbs., and \$250 per guard. Does not affect handling class when raised. Lowering or raising is a firing action, and takes one second.

Cycle Wheelguards: No space, weight and cost 2 lbs. and \$10 per point of armor. Each wheel requires only one wheelguard, and 10 points of armor is the maximum. When a cycle wheel is targeted and hit, roll one die. On a 1-5, the wheelguard takes the damage first. Side-car wheelguards are identical in all respects. Cycle wheelguards do not lower handling class.

Personal Items

Body Armor: No space or weight, \$250. Gives the wearer three extra damage points, but does not protect from falling or collision damage.

Improved Body Armor: No space or weight, \$1,500. Works like regular body armor, except it has 6 DP instead of 3. If the wearer is in a burning vehicle, roll one die each turn. On a 1-3, the wearer takes no damage. On a 4-6, the wearer takes the normal point of damage. Anyone wearing improved body armor must subtract one from his reflex roll because of the bulk, and pedestrians wearing IBA have their speed reduced by 5 mph (2 squares/turn). The IBA also includes a built-in gas mask, and reduces the amount a person can carry to five grenade-equivalents.

Laser Targeting Scope: No space or weight, \$500. When attached to any hand weapon, adds +1 to hit.



Miscellaneous

Tool Kit: 1 space, 40 lbs., \$600. Counts as a pedestrian's full load if carried by hand, 2 DP. Includes enough tools and spare parts to allow a mechanic to work in the field at no penalty. If the tool kit is hit, the first point of damage hurts the case, and the second one breaks the case, ruins most of the contents, and scatters the rest, making it unusable.

Portable Shop: Comes in 4 cases — each case is 1 space, 75 lbs., \$1,000, and 2 DP. As above, the first point of damage mars a case, and the second point ruins the contents. A mechanic working in the field with a portable shop adds one to all his success rolls. If some of the shop cases are destroyed or missing, the chance of the mechanic finding the part he needs is equal to the percentage of cases left. For example, if 3 of the 4 cases are still intact, there is a 75% chance that the part the mechanic needs is still available — otherwise, the shop is useless for the particular repair attempted.

Spoilers and Airdams: No space, 100 lbs., \$500 each. Either of these items reduce by one the difficulty of any maneuver performed at 60 mph or faster — the two combined will reduce the difficulty of such a maneuver by two. No vehicle may have more than one of each, and they do not work on oversized vehicles. Trikes may use a spoiler only, and cycles may not use either one. Airdams may not be mounted on vehicles with Off-Road Suspensions (see "Off-Road," Section XIV, Scenarios). If a maneuver is reduced to D0 or less due to the spoiler and/or airdam, no control roll is required. Spoilers are destroyed when the rear armor is destroyed, and airdams are destroyed when the front armor is destroyed. If the vehicle has fireproof or reflective armor, the spoiler and airdams must match, at the regular penalties in cost and weight.

Tire Chains: No space or weight, \$20 each. When placed on every tire on a vehicle, Tire Chains reduce the penalty for maneuvering on ice from +D4 to +D1, and eliminate the penalty for maneuvering on snow.

Stealth Mode: 2 spaces, 200 lbs., \$16,000, 2 DP. Stealth Mode is a baffling system for a helicopter's engine and rotors; it enables a helicopter to fly at one-half its maximum speed and acceleration, but very quietly, so that characters more than 2" away or in closed buildings or cars cannot hear the helicopter. Cars, cycles, and trikes can also use this item (at the same penalty); oversized vehicles cannot.

Infrared Targeting and Driving Aid: 1 space, 100 lbs., \$4,000. When using an Infrared Targeting Device (or, simply, "infrared"), a vehicle does not need to rely on its own or other vehicles' lights to navigate or take part in combat; it operates as though it were in daylight, taking no nighttime modifiers for targeting, and not revealing its position (unless it fires a weapon). Infrared is available for all vehicles, and is destroyed when the power plant is destroyed.

Sound Enhancement: 1 space, 150 lbs., \$6,000, 2 DP. Sound Enhancement is another aid to sneakiness: The crew of a vehicle using Stealth Mode may listen through the walls of a car or through one building wall and hear what is being discussed beyond. The crew can only "hear" through one building wall; the crew cannot hear through the wall beyond that.

Sound System: 1 space, 100 lbs., \$1,000, 2 DP. Sound Systems really have no combat usage. They can be used as a public address system or to broadcast recordings or transmissions to folks within a distance of many blocks. Appropriate music blasted toward targets can enliven any attack; Wagner or heavy metal is most popular, but suit yourself.

Side Door: No space, 500 lbs., \$1,000. Side Doors are standard equipment on helicopters; standard and transport choppers come with one free side cargo door on the right. However, if you want a helicopter to have a left-side door as well (or you want a smaller helicopter to have any door at all), pay the \$1,000 listed. Opening or closing a side door is a firing action for whoever does it, and the door will be open (or closed) at the end of the next turn. An open side door means that the vehicle has no functioning armor on that side. Vans, oversized vehicles, and helicopters may use this item.

Radar: No space or weight, \$2,500. Radar is used for navigation, combat, and surveillance in poor-visibility conditions (night, light rain, fog, etc.). A vehicle with radar can function normally under these conditions; it reduces visibility penalties to hit by 1. However, unlike infrared (see above), radar does not identify objects shown on the screen — they appear only as blips. It works as long as the vehicle's power plant works. (This device is of most use in roleplaying scenarios.)

Searchlight: 1 space, 50 lbs., \$200, 1 DP. Searchlights are used to spot items on the ground (and in the air) during nighttime maneuvers. A searchlight used on a moving object may track that object with a to-hit roll of 3 or more (plus normal modifiers for range, target size, etc., but not darkness modifiers); the light must be operated by a crewman. A searchlight may also be used to blind the driver and crew of another vehicle. With a to-hit roll of 6 (plus normal modifiers), the searchlight operator may blind his target, and the target's player must turn away from the board and describe subsequent actions based on what he remembers for as long as he is "blind." He is blinded only as long as the searchlight "hits" him. A blinded character may still fire, but at a -10 modifier; all maneuvers are +D3. Searchlights may be targeted at a -3.

Remote Control: No weight or space, \$2,000. Remote Control gear can be used to drive any vehicle from the outside. The RC gear's range is limited to the range of the radio in the vehicle being piloted. A remotely-controlled vehicle can do anything a manned one can do, but its handling class is 3 less than normal, and it suffers a -3 modification on all to-hit rolls. RC sending and receiving sets take up no weight or space, but each set costs \$2,000 — thus, it takes \$4,000 to pilot any vehicle remotely. (Control signals are encrypted; therefore, under normal circumstances, there is little chance of deliberate or accidental signal interference.)

A single RC set will control all functions of a vehicle — steering, acceleration, all weapons, etc. However, a character piloting a vehicle by remote control cannot do anything else, and cannot do anything by remote control that he could not do in person (i.e., only one firing action per character per turn). A single sending set can be modified so that two or more people can use it at once, each for different weapons, to crew a multi-station vehicle remotely. Vehicle-mounted RC equipment is linked to the computer (if any) and is destroyed only if the computer (or the power plant) is lost.

9. The Human Element

For game purposes, all humans are assumed to weigh 150 pounds. A human takes up one space. However, vehicle and weapon controls (and the freedom of movement to use them) also take one space. Therefore, two spaces must be allotted for each driver or gunner. For more on people, see Section VI, *Pedestrians*, and Section VII, *Continuing Characters*.

Each vehicle may have only one driver, who sits on either the right or left side (the player specifies at the time the car is built). The driver may fire any of the vehicle's weapons; he may also use hand weapons. A gunner may also fire any of the vehicle's weapons, or hand weapons. There may be more than one gunner. The driver and gunner cannot share a targeting computer; each must have his own if both are to get an aiming bonus.

A vehicle may carry passengers either in cargo space or regular space. A passenger seat (with or without passenger) takes no space and adds no weight — the passenger, of course, weighs 150 lbs. and takes up 1 space. Passengers can use hand weapons but cannot fire vehicle weapons. A single passenger can ride behind a cycle's driver; he takes up no extra space but adds weight, and can use hand weapons only.

10. Cargo

Likely cargo includes spare tires and ammunition (for yourself, or salvaged from a kill). In a campaign game, consult your referee about other "cargo" you want to pick up. Note that any vehicle may carry cargo if it has unused space, but pickups, vans, and station wagons have a specific "cargo area" that may be used for nothing else.

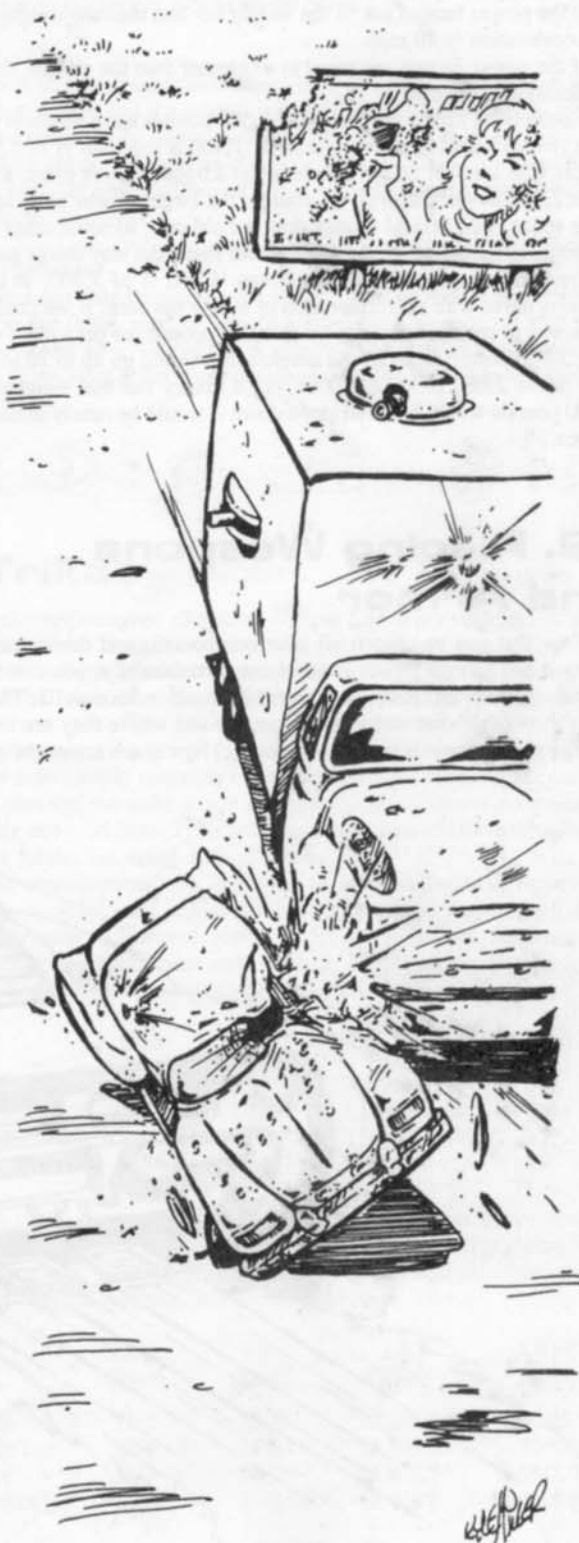

11. Computing Acceleration

Once you have determined what will go into your vehicle, you must compute its acceleration. This will be 5, 10, or 15 mph.

If the number of power factors in a vehicle's power plant is less than $\frac{1}{5}$ the vehicle's weight, it is underpowered. Throw something out, or get a bigger power plant.

If the power factors are $\frac{1}{5}$ the weight but less than $\frac{1}{2}$, the acceleration is 5 mph.

If the power factors are $\frac{1}{2}$ the weight but less than the weight itself, the acceleration is 10 mph.

If the power factors are equal to or greater than the weight, then the acceleration is 15 mph.

Example: A luxury car weighing 5,500 pounds has a Medium power plant (which has 1,400 power factors). 1,400 is less than $\frac{1}{5}$ of 5,500 — the car won't move! So we decide to get a bigger power plant, a Large (with 2,000 power factors). Of course, the larger power plant took up more space, weight, and money than the old one, so some other things had to go to keep the cost the same — but that's the way things go when you're building a car. 2,000 is between $\frac{1}{5}$ and $\frac{1}{2}$ of 5,500, so the car can now move with an acceleration of 5 mph per turn. If we could find some way to cut the weight down to 4,000 pounds (or get a plant with at least 2,750 power factors), the acceleration would go up to 10 mph per turn (since 2,000 is $\frac{1}{2}$ of 4,000), but a luxury car that weighed only 4,000 pounds would be so stripped down it would be nearly useless. So it goes . . .

12. Placing Weapons and Armor

Now that you've chosen all your components and determined that your car has enough power to accelerate satisfactorily, you can fill out the vehicle diagram. Refer back to the example in Section III. This diagram shows (a) what weapons the car has and where they are located; (b) how much ammo is in each weapon; (c) how much armor the car has

in each location; and (d) what other components the car has, and where they are. Note that the power plant may be either in front or in back.

Weapons location restriction: No more than $\frac{1}{5}$ of the total spaces in a vehicle may be devoted to weapons that fire from any one side. Motorcycles and sidecars are exempt from this restriction.

The vehicle diagram is used to keep track of ammunition expenditure and damage. Also located on the vehicle diagram are the Speed Track and the Handling Track (see Section IV, *Movement*).

Blank Vehicle Record Sheets have been provided for every type of vehicle in *Car Wars*. They are for you to photocopy and use.

13. Repair and Salvage

In a continuing campaign, damaged vehicles will need repair. Damage to armor can be repaired at \$50 per hit — or the vehicle's entire armor can be replaced for its original cost (as per the vehicle building rules above) plus 10%. A component that has taken only 1 hit can be repaired for 10% of its original price; two hits: 30%; three hits: 50%; and so on. It's cheaper to replace a badly damaged power plant (for instance) than to fix it. Body armor cannot be repaired. Medical care for injured characters is free. (You're insured.)

The prices above are for parts and labor. If you do the work yourself, cut $\frac{1}{2}$ off the repair costs. Many repair shops will let you do your own work in their bays — for \$50 an hour.

A vehicle or component may be sold for salvage. Salvage value is the original cost minus the cost to repair. Damaged parts may be bought for this value, or sold for half this value. If you stop on the road to strip a wreck, you can easily get tires, extra magazines, unfired ammunition, hand weapons, and cargo. Other components can be salvaged, but it takes time and requires the Mechanic skill (see Section VII, *Continuing Characters*). A wreck that has burned is worthless.

Modifying Vehicles

New weapons and accessories may be added to an existing vehicle between duels, as long as weight and space limits are observed. Old components may be saved or sold. 10% is added to the cost of any parts that vary from a car's original design — retrofitting is expensive.

Exceptions: New tires may be added at their regular cost, and chassis and suspension may not be changed from their original design.

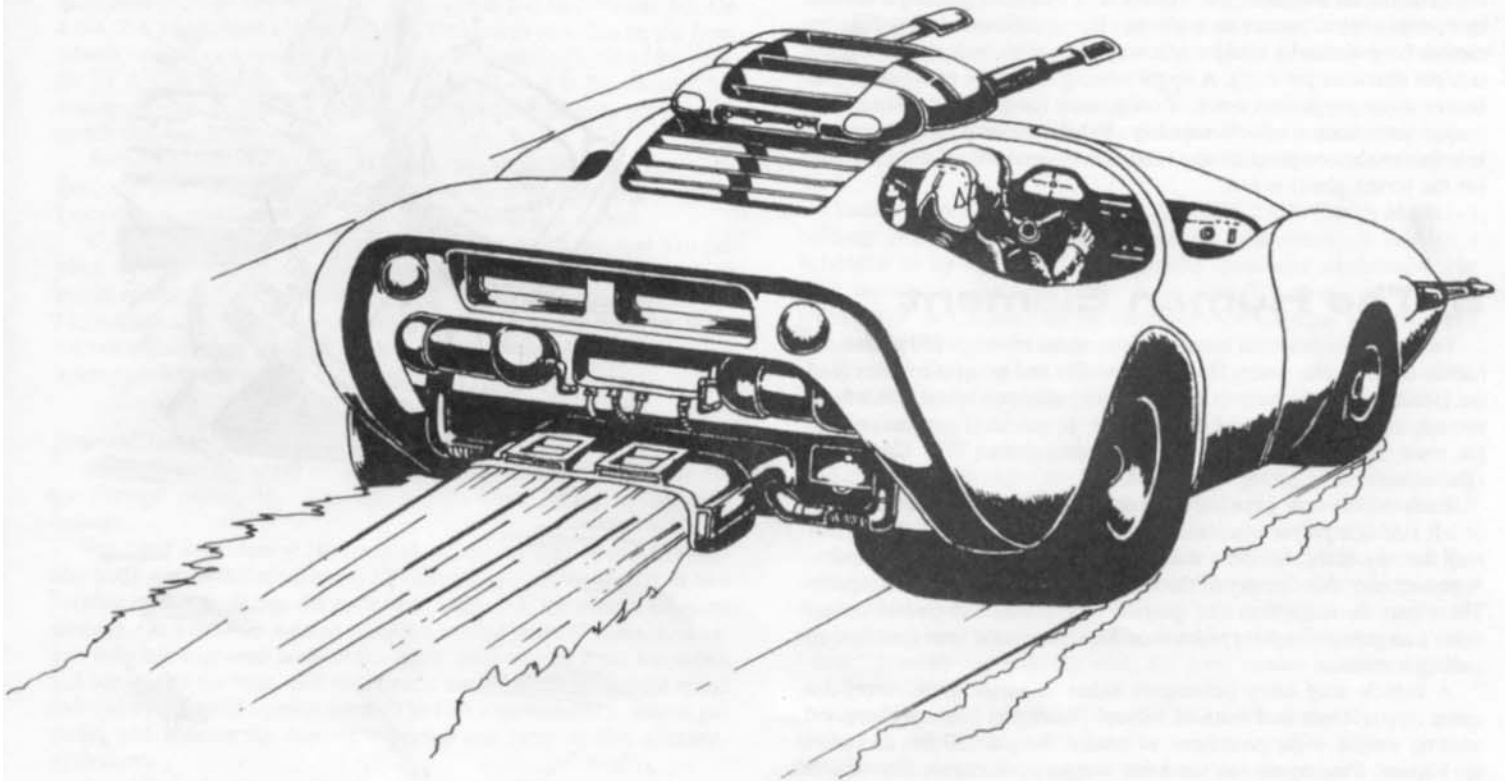

IX. Cycle and Trike Design

1. Cycles

Building a motorcycle is very similar to building a car. A cycle can use almost any weapon or accessory a car does. A medium or heavy cycle can also pull a sidecar — for one passenger, for cargo-hauling, or just to get some extra firepower.

Frame	Price	Weight	Max. load	Spaces
Light cycle	\$200	250	800	4
Med. cycle	\$300	300	1100	5
Hvy. cycle	\$400	350	1300	7
Lt. sidecar	\$300	200	400	2
Hvy. sidecar	\$450	350	750	3

Weight of the sidecar and contents does not count against the load on the cycle frame. Instead, both the sidecar and the cycle must meet their maximum weight requirements separately. The weight is added together, however, when computing acceleration (which is done the same way as for cars). A cycle may only pull one sidecar. Cycle and sidecar chassis cannot be modified to increase weight capacity.

Armor

Cycle armor may be placed front and rear only. A sidecar is treated like a little car with no top. Sidecars can carry armor in five locations: Front, back, right, left, and underbody. Cycle and sidecar armor can be made fireproof, reflective, or both. All the armor on a sidecar or a cycle must be of the same type, but an attached sidecar can carry a different type of armor from a cycle.

Vehicle	Norm. (\$/wt)	FP (\$/wt)	LR (\$/wt)	LRFP (\$/wt)
Light cycle	10/4	20/4	11.0/4.4	25.0/4.4
Med. cycle	11/5	22/5	12.1/5.5	27.5/5.5
Hvy. cycle	12/6	24/6	13.2/6.6	30.0/6.6
Lt. sidecar	5/5	10/5	5.5/6.6	12.5/6.6
Hvy. sidecar	5/6	10/6	5.5/6.6	12.5/6.6

Suspension

Suspension can be upgraded to improve the handling class of the cycle or a sidecar. To determine the HC of a cycle/sidecar combination, add the handling classes of the two separate items together. The best possible HC is still 3. Example: A cycle with HC 1 hitched to a sidecar with HC 1 would have a final HC of 2. If the cycle and sidecar both were HC 2 separately, the combination would be HC 3 (the maximum allowed).

Suspension	Cost	HC
Light	no extra	0
Improved	100% of frame cost	1
Heavy	200% of frame cost	2

Power Plants

Like car power plants, cycles use fuel-cell systems. Like today's cycle engines, they are more powerful for their size and weight than auto engines, but cannot be used in larger vehicles — they would burn up.

Plant	Cost	Weight	Spaces	DP	Power	Speed
Small cycle	\$500	100	1	2	400	90
Med. cycle	\$1000	150	1	3	600	100
Large cycle	\$1500	175	2	4	800	100
Super cycle	\$2000	200	2	5	1000	100
Super trike	\$3000	250	3	6	1200	100

The super trike power plant is a new development, built especially for three-wheeled vehicles (see below). The super trike power plant can be used by cycles, however.

Cycle acceleration is determined in exactly the same way as car acceleration — by comparing the total weight of the cycle or cycle/sidecar combination to the power factors of the plant.

Tires

Cycles need two tires; sidecars need one. The front and rear tires on a cycle must match, and if a sidecar is attached, its tire must match, too. Cycle tires come in the same varieties available for cars, except for solids, which are not allowed on cycles or sidecars. Cycle tires cost the same and have the same number of DP as car tires, but they weigh only half as much.

Weapon Placement

Weapons can only be placed on a cycle's front or rear. They can be mounted to the front, rear, or side of a sidecar. A weapon on a cycle cannot be linked to a weapon on a sidecar, unless both are dropped weapons. If the sidecar becomes detached, the link is broken and must be replaced.



2. Trikes

Tricycles are designed like other *Deluxe Car Wars* vehicles. A tri-cycle counter is 1" long, like that of a car. A tricycle's arcs of fire are different from those of other vehicles (see "Trike Combat," below); this should be taken into account when placing weapons and armor.

Construction

Trikes most closely resemble motorcycles in construction. They use the same tires and the same power plants as cycles, with one exception: Trikes may use solid tires. Trike solids cost the same and have the same DP as car solids, but weigh half as much.

A trike chassis cannot be improved to increase the load capacity (again like a cycle), and suspension works the same way as well — Light Suspension is free and results in HC 0; Improved Suspension costs 100% of the frame cost and results in HC 1; Heavy Suspension costs 200% of frame cost and gives a trike HC 2.

Body	Cost	Weight	Max. load	Spaces
Light trike	\$250	300	1600	8
Medium trike	\$300	500	2100	10
Heavy trike	\$400	700	2800	12
X-Heavy trike	\$550	950	3500	14

Trikes carry armor like cars — that is, they have six armor positions: Front, back, left, right, top, and underbody. Trike armor may be normal, fireproof, reflective, or reflective-fireproof (like all other vehicles). Armor types may not be mixed on the same trike.

Vehicle	Norm. (\$/wt)	FP (\$/wt)	LR (\$/wt)	LRFP (\$/wt)
Light trike	11/5	22/5	12.1/5.5	27.5/5.5
Med. trike	12/6	24/6	13.2/6.6	30/6.6
Hvy. trike	14/7	28/7	15.4/7.7	35/7.7
X-Hvy. trike	16/8	32/8	17.6/8.8	40/8.8

Trikes can use any weapon or accessory a car or cycle can, with a few exceptions. Trikes cannot have ramplates, and they cannot pull sidecars. Light trikes cannot carry turrets; medium trikes can only use one-space turrets. Larger trikes can carry up to two-space turrets.

Trikes may use wheelguards — car wheelguards on the back two wheels, and a cycle wheelguard on the front. Wheelguards do not reduce handling class on a trike, but will reduce HC by 1 on a reversed trike. Retractable wheelguards are not available for trikes.

Reversed Trikes

First seen in Europe, and now being tested in North America, the "reversed" trike design puts two wheels in front and one in the center of the back. This configuration provides greater stability than the traditional trike, but is not readily available and is not as efficient from a space standpoint. Reversed trikes come in the same body styles as regular trikes, but have one less space, and cost an extra 50% for the chassis. Handling class for a reversed trike is one higher than for a regular trike (maximum HC is still 3). Reversed trikes can carry a ram plate, but in all other respects they are the same as regular trikes.

3. Trike Combat

A tricycle is not just a fat motorcycle or a three-wheeled car. The successful tricycle duellist (or designer) must keep the differences in mind if he intends to survive. Trikes have some significant advantages, but they have disadvantages as well.

Arcs of Fire

Trike weapons may be located front, back, or to either side; they may also be turreted. Front and back weapons have the same arc of fire a car's weapons do (see diagram below); turreted weapons, of course, have a 360-degree arc of fire.

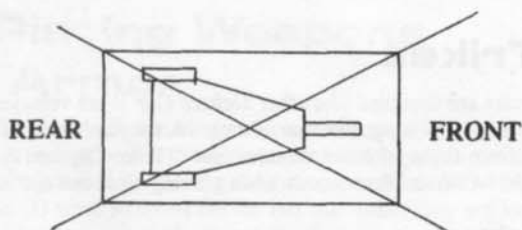

Side-mounted weapons trike weapons have a greater arc of fire than a car's side weapons do, because of the wedge shape of the trike body. A trike's side weapons can fire into the "normal" side arc of fire, plus the front arc of fire of a standard vehicle (see diagram below).

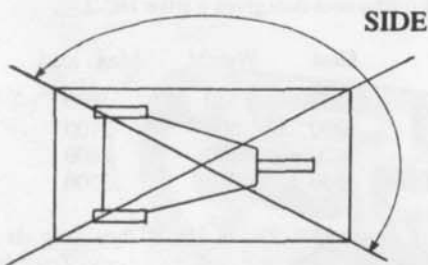

Any target in the front arc of fire can be hit by weapons mounted on both sides as well as the front! Right-side and left-side weapons may be linked together, or linked with front weapons, and aimed together for fire at targets in this front arc. The linked weapons must be of the same type, or only one can be aimed, and the rest are treated as if they were on automatic. (Linked weapons are discussed more fully in Section V, *Combat*.)

Weapon Location

A tricycle may mount any weapon to the front or in a turret. Heavy weapons mounted on a trike's side cause recoil problems, however. The only offensive weapons a trike can mount to the side are MGs,



FTs, lasers, an RR, and rockets (and rocket launchers) of all kinds.

A tricycle may not mount dropped weapons anywhere but to the rear; side-mounted dropped weapons would endanger the vehicle. Side-mounted paint sprays and smokescreens are legal but impractical. Exception: A reversed trike may mount dropped weapons to the sides.

Targeting

Because of their small size and low profile, trikes are harder to hit, as follows:

- Light trike: -3 from front/back, -2 from side
- Medium trike: -2 from front/back, -1 from side
- Heavy trike: -1 from front/back, -1 from side
- X-Heavy trike: -1 from front/back, no penalty from side

Because trikes are low to the ground, their tops can be fired upon. Any attacker may choose to fire at the top of a trike if he has a line-of-sight on the front or either side (You can't hit a trike's top from behind, but you can target the turret). Because the top is steeply sloped, any attack on the top is at an additional -2 to hit. Thus, for example, a shot at the top of a light trike from the front would be at a -5, plus or minus whatever other modifiers were in effect. However, if a trike has a turret, any successful hit on the top armor strikes the turret automatically with no further penalty.

Enemy fire is normally allowed to target any side that has an arc of fire to return fire. That rule must be modified for trikes. An enemy vehicle in a trike's front arc of fire can only target the trike's front, even though the trike can bring side weapons to bear on him. This is because the steep angle of a trike's sides would make an attack — even a laser beam — likely to bounce off. An enemy vehicle on the dividing line between the front and side arc of fire may, as usual, pick which side it wants to shoot at.

When a trike is struck in the front by weapon fire, roll two dice. On a 11 or 12, the front wheel is hit. Any remaining damage is lost. On a 2 through 10, the front armor is hit. Any remaining damage after the armor is destroyed will affect internal components in the same way cars are affected. Use the damage allocation method used for cars (see "Damage Location," in Section V, *Combat*) for any attacks from the side or rear, too.

For reversed trikes, all the above holds true — just reverse "front" and "back." Exception: You still cannot hit the top of a reversed trike from behind, because the back is still the highest part of the tricycle.

Hazards and control rolls resulting when a trike loses a wheel depends on which wheel is lost. Treat the loss of a single wheel as if a cycle lost a wheel, and treat the loss of one of the pair of wheels as if a car wheel was lost. Exception: A trike that has lost even one of its wheels can no longer move at all.

X. Ten-Wheelers

For an intercity move or a cross-country haul with a small load, a ten-wheeled truck or mini-bus might be the perfect vehicle.

The mini-bus and the ten-wheeled trucks are both represented by counters 1½" long. In most ways, they are treated like big cars, but the ten-wheeled truck has an important difference: The ten-wheeler has two parts — the cab and the carrier. The two parts are constructed separately, but move together. The carrier rides on the frame of the cab.

1. Cabs

Cabs have more spaces and a heavier chassis than most cars, but fewer spaces and a lighter chassis than big rigs (see Section XII, *Trucks and Buses*). There are two types of cabs — the basic cabover and the bigger, heavier, more expensive, longnose.

Cab type	Cost	Weight	Load	Spaces
10-wheel cabover	\$10,500	3,000	15,000	17
10-wheel longnose	\$12,500	3,200	16,500	20

The body price includes lights, standard CB, horns, and other basics. Improved chassis strength can be bought for cabs as for regular tractors — a Heavy chassis adds 10% to the cab's maximum load and costs an extra 50% of the cab's body cost, and an Extra-Heavy chassis adds 20% to maximum load for an additional 100% of the body cost.

Improved suspension is not available for 10-wheeled trucks — they all have a handling class of 1.

Tires

A ten-wheeler must have the same type of tire in all ten locations. PR Radials are not available for ten-wheelers, but the other four types are. Wheelguards do not affect handling class on oversized vehicles.

Tires	Cost/tire	Wt./tire	DP
Standard	\$150	60	6
Heavy Duty	\$300	80	9
Puncture Resistant	\$600	100	14
Solid	\$1500	150	18

Solid truck tires are totally immune to both spike and debris damage, but are still affected by obstacles.

Power Plants

Power plants for ten-wheelers and other oversized vehicles do not have power factors like other plants in *Deluxe Car Wars*.

Instead, each plant is rated for the maximum amount of weight it can pull. All oversized power plants have the same top speed — 100 mph — and the same acceleration — 2.5 mph/turn up to 25 mph, 5 mph/turn thereafter (see "Movement," later in this section). Oversized power plants can push beyond the 100 mph maximum for short periods of time, with the same limitations and penalties as for car power plants. The power plant is always assumed to be in front of the driver, even in a cab-over.

Plant	Cost	Weight	Spaces	DP	Max.wt.
Small Truck	\$8,000	2,500	8	16	15,000
Medium Truck	\$10,000	2,800	9	18	20,000
Reg. truck	\$15,000	3,000	10	20	40,000
Large truck	\$20,000	3,500	13	26	60,000
Super truck	\$25,000	4,000	16	32	80,000

Armor

Armor for cabs is bought in the standard six positions — front, back, right, left, top, and underbody. If a cab has any carrier but a flatbed, however, back armor is unnecessary. Cab underbody armor protects the cab only. Separate underbody armor is necessary to protect the carrier.

Cab armor is available in all four types, and as with all other vehicles, mixing of armor types is not allowed.

Cab type	Norm. (\$/wt)	FP (\$/wt)	LR (\$/wt)	LRFP (\$/wt)
10-wl. cabover	30/14	60/14	33/15.4	75/15.4
10-wl. longnose	32/15	64/15	35.2/16.5	80/16.5

Weapons

Weapons for cabs can be mounted on three sides — front, left, and right. Because the carrier is usually taller than the cab, rear-firing weapons are not permitted, and turreted weapons may not fire to the rear. The only exception is when a flatbed carrier is used, or no carrier at all. 10-wheeled trucks may use wheelguards with no penalty. They can also use ramplates, and any weapon available to other oversized vehicles.

Extras

Doors may be installed on the back of a cab, allowing passage into a carrier from the cab. Obviously, if the carrier is a tanker, this isn't such a good idea. Back doors cost \$200, and take up no weight or space.

2. Carriers

Carriers are cargo areas for 10-wheelers. They are mounted and attached to the cab of the 10-wheeler.

Carrier Type	Cost	Weight	Spaces
15' Flatbed	\$1,100	750	20*
15' Van	\$2,300	1150	30
15' Reefer	\$3,800	1350	25
15' Tanker	\$6,150	1900	25
15' Dumper	\$4,000	2300	30

There is no maximum load listing for carriers, because that is determined by the chassis of the cab. Carriers are mounted directly on the cab, and do not use tires. They also do not have any suspension.

*Note that the "space" on a flatbed is an approximation. The higher cargo is stacked, the more a flatbed can carry. Twenty spaces of cargo is the maximum for safe hauling, but much more can be attempted. If more than 20 spaces' worth of cargo is loaded on a flatbed, roll one die every time the truck performs a D3 (or more difficult) maneuver or encounters a D3 or worse hazard: There is a 1 in 6 chance for every 5 full spaces over 20 that the load will fall off the trailer (2 dice spaces' worth of cargo will remain).

For example, 28 spaces of cargo are loaded on a flatbed, making the chance of a cargo disaster 1 in 6. After the mess happens, 2 dice are rolled, and come up, say, an 8 — that's how many spaces' worth of cargo is still on the trailer. It is up to the referee to determine what happens to cargo that hits the highway (20 spaces' worth in this case). This should be based on how fragile the cargo was, how it was packed, and how fast the truck was going when the cargo hit.

A dump carrier can only devote 5 of its 30 spaces to weaponry — the rest must be used for cargo. A dump carrier has no top, and cannot mount turrets. The carrier may be raised to dump the contents. Controls are located on either side of the carrier; a duplicate set of controls in the cab allows the carrier to be raised from inside. It takes 7 turns to raise the bed fully, and only 5 turns to lower it. Loose materials in the carrier will start to spill out after two seconds of elevation. The carrier will be completely empty after 10 seconds.

A tank carrier is required to have at least 20 points of armor in each location (see below). A lighter tank would be in danger of leaking or exploding, even under non-combat conditions.

A "reefer" is a refrigerated carrier — similar to a van, except it carries perishable items.

Armor and Weapons

Armor is placed on a carrier in six locations — front, back, left, right, top, and underbody. Carrier armor costs \$30 and weighs 14 lbs. per point, no matter what type of carrier. Fireproof armor costs \$60 and weighs 14 lbs. per point, Reflective armor costs \$33 and weighs 15.4 lbs. per point, and Reflective/Fireproof armor costs \$75 and weighs 15.4 lbs. per point. A flatbed carrier, of course, only needs to buy underbody armor. A flatbed carrier can mount a small armored box on the back for carrying and protecting defensive weapons. The box can carry up to six spaces of weaponry, and is armored in six locations. Armor for this box costs \$11 and weighs 5 lbs. per point, and can be made fireproof, reflective, or both, at the standard penalties to cost and weight.

Weapons may be mounted on a carrier to the left, right, or back (not to the front). Carriers can mount a turret of any size (which can fire to the front), but can only mount one. Carriers can also use the rocket platform, but it would take the place of the turret. A flatbed, of course, may not mount a turret.

3. Mini-buses

Mini-buses are set up to carry lots of people, instead of cargo. They are the same size as ten-wheeled trucks, but instead of a cab and carrier, they have a single, large, internal compartment. The mini-bus' basic body costs \$4,000, weighs 3,000 lbs., has a maximum load of 12,000 pounds, and can carry 35 spaces' worth of crew, equipment and passengers. Chassis strength modification works the same way as for the other 10-wheelers. A mini-bus cannot have its suspension improved; its handling class is 1. A mini-bus uses the same tires as the ten-wheeled trucks.

Bus Personnel

These vehicles are designed for passengers. Since space for luggage and aisles must also be allowed, leave 2 spaces for each passenger to be carried (not 1 as in an automobile). For a luxurious mini-bus, allow 3 spaces and an extra \$500 for each passenger. Any bus must allow 200 lbs. per passenger — the extra 50 pounds covers luggage, etc.

A bus will have one driver and usually at least one gunner. A gunner may be located in the very back of a bus; if so, he takes damage after the rear-mounted weapons do, and before any of the vehicle's contents. Allow 2 spaces and 150 lbs. for the driver and each gunner.

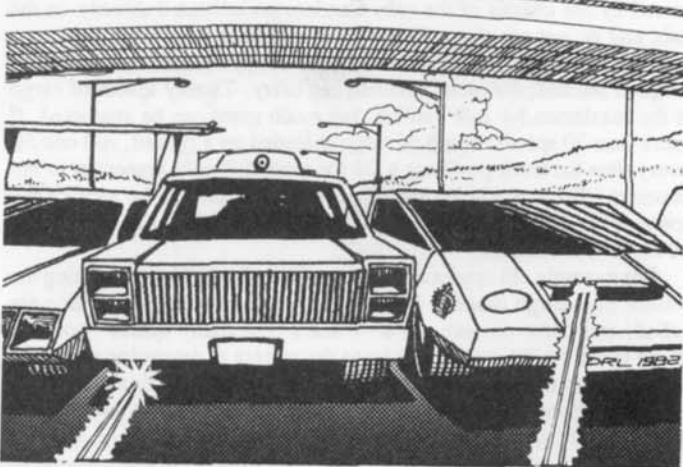

Armor and Weapons

Armor on mini-buses is placed in six positions — front, back, left, right, top, and underbody. Normal armor for a mini-bus costs \$32 and weighs 14 lbs. per point. Fireproof armor is \$64 and 14 lbs. per point; Reflective armor is \$35.2 and 15.4 lbs. per point; and Reflective-Fireproof armor is \$80 and 15.4 lbs. per point.

Mini-buses can use any weapon — including a rocket platform. Weapons can be mounted in any normal position, including a single turret of any size.

4. Combat

Because an oversized vehicle is so tall, a turret mounted on its roof cannot fire on any target (except another oversized vehicle) within 1 1/2'' of the center of the turret. If a smaller vehicle is between 1 1/2'' and 6'' away from the center of the turret, the turret may fire at the smaller vehicle's top (as well as any sides that present a line of fire). This can be devastating if the smaller vehicle has little or no roof armor.

A turret on a cab cannot fire over its own carrier unless that carrier is a flatbed. It can fire over any smaller vehicle within 6'', if necessary. A turret on a mini-bus or carrier can also fire over a small vehicle within 6''.

A mini-bus can mount a single turret of any size. A ten-wheeler can mount two turrets — one on the cab and one on the carrier. The turret on the carrier is always considered to be "higher" than the other — it has a full 360-degree arc of fire. The turret on the cab cannot fire to the rear (unless the carrier is a flatbed as noted above).

The arcs of fire for a mini-bus are determined in the same way as regular cars: Draw two diagonal lines through the opposite corners of the counter, and the four arcs of fire are marked. 10-wheeled trucks have more complicated arcs of fire, using the black dots in the middle of each long edge (if the dots aren't on the counter, draw them in). The arcs of fire are as follows:

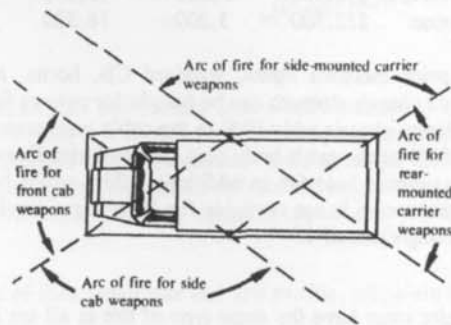

Note that the side arcs of fire for the carrier and the cab overlap. Anyone attacking a ten-wheeler from the side may have a choice of targets without penalty, and must specify what he's shooting at. Firing at a part of a 10-wheeler when the firer is not in that part's arc of fire is a -2 to hit.

5. Movement

10-wheeled trucks and mini-buses are represented by counters measuring 1/2'' x 1 1/2''. Some counters are provided on the road section sheets. Both types of vehicles maneuver the same way cars do. The Trucker skill is required to operate a ten-wheeler. Driving a ten-wheeler without the Trucker skill results in a -3 to handling class.

Weight and Acceleration

Trucks and buses are never geared for anything but gradual acceleration and heavy loads. All ten-wheelers have an acceleration of 2.5 mph until they reach 25 mph. After they reach 25 mph they will have 5 mph acceleration. The gearing of these vehicles makes greater acceleration impossible.

Since acceleration does not have to be computed, "power factors" are not given for the various truck power plant sizes. To figure out if a truck power plant can get a ten-wheel truck moving, add the weight of the cab, the weight of the carrier, and the weight of the load being carried. For a mini-bus, add the weights of the vehicle, passengers, and cargo (if any). If a ten-wheeler exceeds the overall weight allowed for its power plant, you'll have to redesign it with less weight or install a bigger power plant.

When a vehicle is accelerating at only 2.5 mph per turn, a player will have to put the marker counter between the speed lines on the Movement Chart (i.e., between 5 mph and 10 mph to show a 7.5 mph speed). A vehicle at one of these intermediate speeds moves during the same phases as the next highest speed (i.e., 12.5 mph moves when 15 mph does). A vehicle at an intermediate speed takes a 1/4'' or 3/4'' move, exactly like the regular 1/2'' "half-move," at some point during the turn.

Deceleration, Crashes, and Collisions

Deceleration is the same for oversized vehicles as for all other vehicles, with one exception. Any ten-wheeler decelerating at more than 30 mph in one turn goes directly to Crash Table 1 and takes 2 dice of damage to each tire. Note that when any vehicle checks a Crash Table after decelerating, the modifier used on the table is the modifier for the speed *before* deceleration. Ten-wheelers used the car crash tables if they lose control.

Debris and Obstacles

Because of their weight, oversized vehicles are much less vulnerable to road hazards — which is a good thing, since their handling class is so low.

Oversized vehicles (unless they have solid tires) can still take tire damage from road debris, but debris does not cause a hazard. Striking an obstacle counts as a D1 hazard for any oversized vehicle. It does normal damage (1d-3) to each wheel. When an oversized vehicle hits debris or an obstacle, the hazard (if any) occurs immediately, and damage (if any) is assessed against each wheel. The vehicle is not considered to have hit the same debris/obstacle again on the next turn, even if the vehicle counter is still over it. The same holds true for mines and spikes; if an oversized vehicle does not “hit” them the first time it rolls, it does not roll again on the next or later turns.

At the moment a mine explodes, it damages the underbody and each tire within 1” of the edge of the counter. The hazard is figured as though the total damage (underbody plus tires) was from enemy fire.

Hazards to Oversized Vehicles

- Striking an obstacle counter: D1
- Enemy fire does 13-21 hits: D2
- Enemy fire does 22+ hits: D3
- Trailer released while tractor is in motion: D2
- AT gun fired to side: D1
- Tank gun fired: D2
- Cycle steamrollered: D1

Tire blowouts

First tire of a pair on ten-wheeler: D2

Second tire of a pair on ten-wheeler or unpaired (front) tire: D3

Note: When all tires on one corner of a ten-wheeler are lost, go to Crash Table 2. Handling class goes to -3 until the damage is repaired.

Collisions

Use the collision system detailed for cars in Section 5, *Movement*. Note how dangerous a fully loaded ten-wheeler can be in a collision, even at low speeds, due to its high damage modifier. If you’re using the Simplified Collision System, remember that a ten-wheeler and a cycle are not going to “bounce” equally in a collision — let common sense dictate the ending positions of vehicles involved in a collision. In the simple collision system, a vehicle between 10,000 and 19,999 pounds will do double damage.

Steamrolling

When a ten-wheeler hits a motorcycle in any way but a sideswipe, it may “steamroller” it — that is, run right over it — due to the difference in heights. Roll one die when such a collision takes place. On a 1 or 2, a normal collision occurred; on a 3-6, the cycle was steamrollered.

When this takes place, the speed of the cycle is reduced to zero. The ten-wheeler simply runs over the smaller vehicle’s counter. This is an extra D1 hazard for the ten-wheeler (in addition to the collision hazard). The vehicle being steamrollered takes regular damage from the collision and the same amount of damage from being run over. When a cycle is steamrollered, this damage is spread evenly among all parts of the cycle (including its driver and/or passenger). A cyclist who is about to be steamrollered had better jump — any chance is better than none!

When a ten-wheeler steamrollers a cycle, all its tires take damage as though an obstacle had been struck: 1d-3 points per wheel.

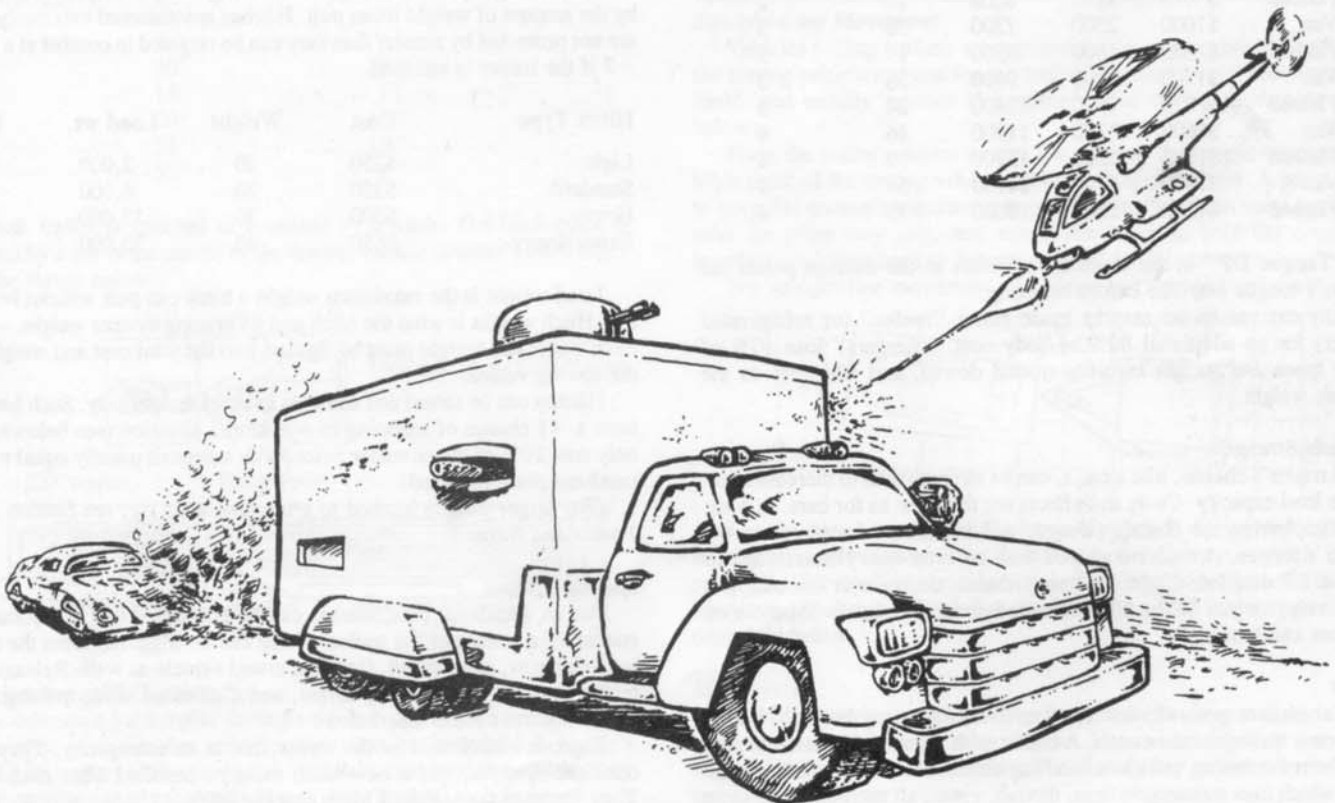

XI. Car Trailers

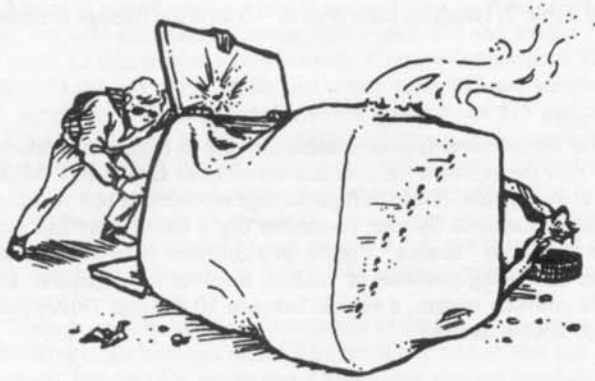

Small trailers can be useful when you want to carry additional cargo or additional firepower. To differentiate them from the larger trailers pulled by tractors (see Section XII, *Trucks and Buses*), they will be called "car trailers."

1. Body Types

Car trailers are little more than boxes with wheels — and, of course, armor and weapons. There are two basic types of car trailer — the van and the flatbed. The van trailer has four sides, a top, and an underbody. Flatbeds are exposed — only underbody armor and wheelguards are allowed. A small armored box of up to 4 spaces is allowed on the back of a flatbed, with its own armor — the armor is \$9 and 5 lbs. per point.

Trailer Type	Cost	Wt.	Load	Spaces	Tongue DP
Mini Van	\$ 200	400	900	3	1
6' Van	\$ 450	1000	2800	12	2
6' Flatbed	\$ 300	700	3700	8	2
10' Van	\$ 700	1600	4700	20	2
10' Flatbed	\$ 475	1100	6200	13	2
15' Van	\$1000	2300	7200	30	3
15' Flatbed	\$ 675	1500	9500	19	3
20' Van	\$1300	2800	9400	38	3
20' Flatbed	\$ 875	1900	12400	24	3
25' Van	\$1600	3300	11900	46	4
25' Flatbed	\$1075	2200	15700	29	4
30' Van	\$1900	3500	14100	54	4
30' Flatbed	\$1250	2300	18600	35	4

"Tongue DP" in the chart above refers to the damage points the trailer's tongue can take before breaking.

Any car van trailer may be made into a "reefer" (or refrigerated trailer) for an additional 80% of body cost. "Reefers" lose 10% of their space and weight capacity (round down), and add 15% to the chassis weight.

Chassis Strength

A trailer's chassis, like a car's, can be strengthened to increase maximum load capacity. Costs and effects are the same as for cars. In addition, improving the chassis strength will increase the strength of the trailer's tongue. A trailer equipped with an extra-heavy chassis has its tongue DP doubled. Light and heavy chassis decrease or increase (respectively) tongue DP by 50%, rounded down. See below for more on tongues and hitches.

Tires

Car trailers generally use car tires. Any type may be used, but all tires on a trailer should match. A trailer with unmatched tires subtracts one from the towing vehicle's handling class. An exception is the mini-van, which uses motorcycle tires, though, again, all must be of the same type.

The size of a trailer also dictates the minimum number of tires re-

quired. Minis, 6-foot, and 10-foot trailers need one pair of wheels; 15-and 20-foot trailers use 2 pairs; all longer trailers must have four pairs of tires.

Armor

Trailers that are 20 feet long (or longer) have ten armor locations, not six like smaller vehicles. This is because each "long side" of the trailer is split into a front and back half. The ten positions are: Front, back, front right, back right, front left, back left, front top, back top, front underbody, and back underbody. Flatbed trailers longer than twenty feet are armored in two positions — front underbody and back underbody. Trailers smaller than 20 feet long are armored in the usual six positions. The usual range of armor types is available — mixing is not allowed. Van and flatbed trailer armor costs the same for various sizes.

Trailer Type	Norm. (\$/wt)	FP (\$/wt)	LR (\$/wt)	LRFP (\$/wt)
Mini van	9/5	18/5	9.9/5.5	22.5/5.5
6-footer	15/7	30/7	16.5/7.7	37.5/7.7
10-footer	19/10	38/10	20.9/11	47.5/11
15-footer	25/13	50/13	27.5/14.3	62.5/14.3
20-footer	30/16	60/16	33/17.6	75/17.6
25-footer	35/17	70/17	38.5/18.7	87.5/18.7
30-footer	40/18	80/18	44/19.8	100/19.8

2. Tongues and Hitches

Car trailers are attached to their towing vehicles by a tongue and hitch system. Every trailer has a tongue. The number of damage points a tongue can take is listed on the first chart in this section. Targeting a tongue is at -5, -7 if the trailer is attached to a vehicle.

The towing vehicle's hitch must be bought separately, and is rated by the amount of weight it can pull. Hitches are mounted externally and are not protected by armor; thus they can be targeted in combat at a -5, -7 if the trailer is attached.

Hitch Type	Cost	Weight	Load wt.	DP
Light	\$250	10	2,000	1
Standard	\$350	20	6,000	1
Heavy	\$500	30	12,000	2
Extra-Heavy	\$650	40	20,000	3

Load weight is the maximum weight a hitch can pull without breaking. Hitch weight is what the hitch and its bracing system weighs — the hitch's cost and weight must be figured into the total cost and weight of the towing vehicle.

Hitches can be rented and added to vehicles temporarily. Such hitches have a +1 chance of snapping in a jackknife situation (see below), but only cost 10% of the purchase price, with a deposit usually equal to the purchase price required.

(For larger trailers hitched to a tractor-trailer rig, see Section XII, *Trucks and Buses*.)

Special Hitches

For an additional cost, hitches can be purchased that allow the instantaneous release of the trailer. These can be triggered from the towing vehicle or, if specified, from the towed vehicle as well. Releasing a trailer in this way is a firing action, and if released while moving, the trailer becomes loose (see below).

Explosive hitches blow the trailer free in an emergency. They are one-time systems, and a new hitch must be installed after each use. They increase the standard hitch cost by \$400.

Quick-release hitches are like explosive ones, except they can be reused. Quick-release hitches cost an additional \$900.

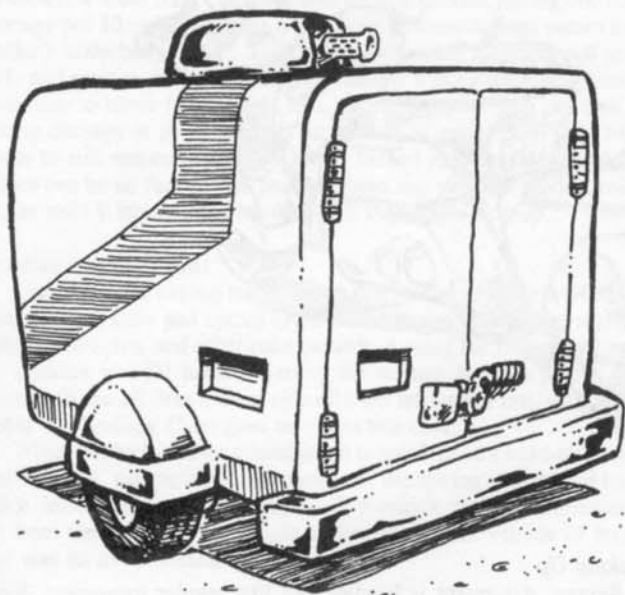

3. Movement

Trailers are represented, like any vehicle, by rectangular counters. The counters vary in length, depending upon the trailer length, and have an additional triangular area simulating the trailer tongue. All counters are 1/2" wide. The tongue triangle has a base and height of 1/2".

Trailer Type	Counter Length
Mini	1/4"
6'	1/2"
10'	3/4"
15'	1"
20'	1 1/2"
25'	1 3/4"
30'	2"

Each trailer is attached to a vehicle by a hitch. The hitch point is marked by a dot in the center of the towing vehicle counter's back edge. See the figure below.

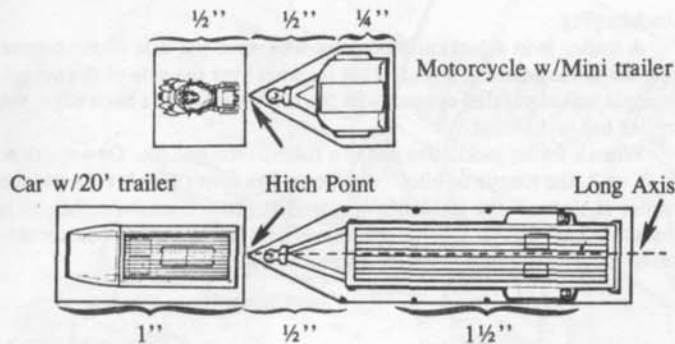

Acceleration and Deceleration

Acceleration for a trailer-towing vehicle is determined normally, but the weight of the trailer being pulled must be included. A trailer's weight does not count against the vehicle's chassis weight limit. Any trailer-towing vehicle that decelerates more than 30 mph in a turn goes immediately to Crash Table 3, and all the tires (including the trailer's) take 2 dice of damage.

Crash Table 3 Car Trailers/Tractor-Trailer Rigs

Whenever a trailer or rig jackknifes (bends at tighter than a 90-degree angle) roll one die. On a 1, 2, or 3, the hitch breaks and the trailer comes loose.

- 1 — Trivial skid. The tractor moves 1/4" in a "trivial skid" as per Crash Table 1. The trailer follows as per a normal maneuver.*
- 0 — Minor fishtail. The tractor does not move; the trailer fishtails 1/4". Treat as a regular fishtail; roll randomly for right or left and move the rear of the trailer 1/4" in that direction, keeping the kingpin over the fifth wheel.*
- 1 — Minor skid. The tractor skids 1/2"; the trailer follows normally.**
- 2 — Major fishtail. The tractor does not move; the trailer fishtails as for result 0, above, but moving 1/2" (two squares).**
- 3 — Minor skid and fishtail. As for result 1, above, followed by result 2.**
- 4 — Major skid and fishtail. As for result 3, above, except that the tractor skids 3/4" and then the trailer fishtails 3/4".***
- 5 — Extreme fishtail. The tractor stays still, the trailer fishtails 1".***
- 6 — Extreme skid and fishtail. Tractor skids 1"; trailer follows and fishtails 1".***
- 7 — Kingpin breaks. The trailer comes loose. The tractor's fifth wheel takes (1d-2) damage. A further D2 hazard! See "Loose Trailers," below.***
- 8 — As above, but the trailer goes into a roll.
- 9 — As result 7, but the tractor rolls. There is a 50% chance that it catches fire.***
- 10 — As result 9 above, but the trailer rolls, too.
- 11 — As result 9 above, but the tractor or towing vehicle flips as in result 10-12 on Crash Table 1.
- 12 or more — As result 11 above, but the trailer rolls too.

* Any further aimed weapon fire from these vehicles on this turn will be at a -3 to hit.

** Any further aimed weapon fire from these vehicles on this turn will be at a -6 to hit.

*** No further automatic weapon fire permitted from these vehicles this turn.

Straight-Line Movement

Vehicles pulling trailers are represented by two counters — one for the towing vehicle and one for the trailer. A trailer cannot accelerate by itself, and usually crashes if it comes loose during movement (see below).

Place the trailer counter so that the point of the tongue touches the hitch point of the towing vehicle, as in the diagram above. A good way to keep the counters together is to punch a small hole in each counter, near the point they join, and use a thumbtack to hold the counters together until they need to be repositioned for a maneuver.

For straight-line movement, the counters are positioned thus:

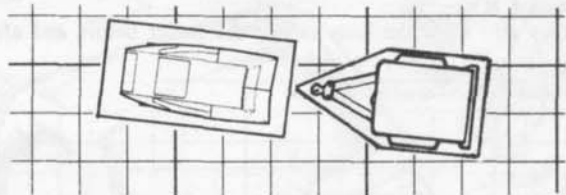

The combined counter moves forward one inch during every phase in which the Movement Chart indicates it should move, based on its speed (1/2" for a half-move, of course), just like a passenger car. This is the normal hauling configuration. Angling the trailer is a maneuver, as described below.

Maneuvers

A vehicle towing a trailer maneuvers the same way a car does, except that it cannot attempt a bootlegger. Use the descriptions and pictures from Section IV, Movement. The turning key included in this set can also be used very effectively.

The trailer follows the towing vehicle in a very interesting way, because it is a separate part joined at the hitch. During a maneuver, the

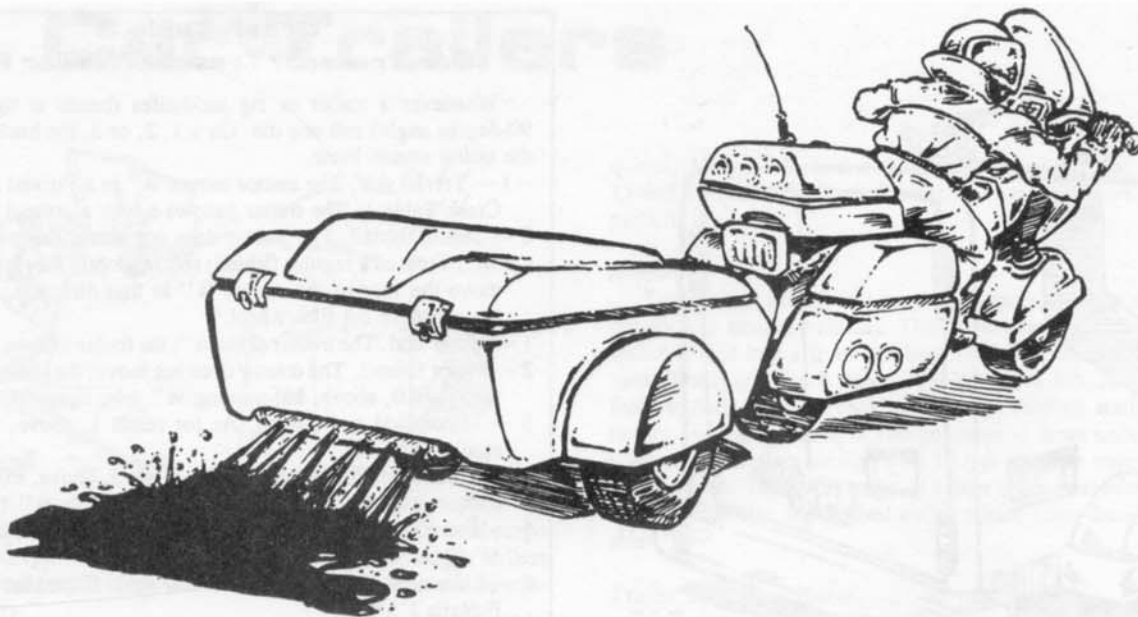

two counters are moved one after the other, and will be separated briefly. At the end of each maneuver, the end point of the trailer's tongue must be directly over the hitch-point of the towing vehicle. The towing vehicle may never make less than a 90-degree angle with the trailer; if it does, the rig has jackknifed (see below).

The key to handling a trailer: Avoid unnecessary speed or maneuvers.

To maneuver with a trailer, first move the *towing vehicle*, as per the maneuver chart or the turning key. Next, move the *trailer counter* as follows:

First, move it in a straight line along its long axis (see illustration) the same distance the towing vehicle moved — if the towing vehicle moved an inch, the trailer moves forward an inch.

Second, hold one rear corner of the trailer counter in place, and pivot the trailer until its tongue is as close as possible to the hitch point of the towing vehicle.

Third, move the trailer (usually forward $\frac{1}{8}$ " to $\frac{1}{4}$ ") until the tongue is exactly over the hitch point, once again.

If the trailer is now touching a wall or another counter, a collision has occurred. However, if the trailer happened to overlap something during the first two steps of its movement, no collision took place.

In the illustration below, the shaded positions are the original ones; the outlined positions are the final ones after execution of a steep drift. The double-ended arrow shows where the trailer was located at its intermediate position; it moved forward one inch, exactly covering the old position of the tractor. The tractor went from A to B. The trailer went from X to an "imaginary" position at Y, and then pivoted to reach its final position at Z.

Arrows also show the long axis of the trailer before and after it moved.

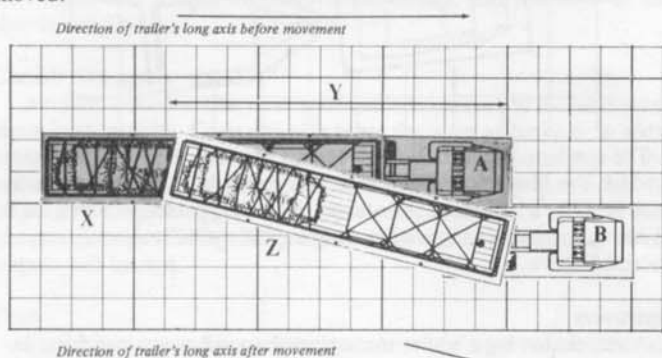

If a rig is towing a *second* trailer, move the towing vehicle first, then resolve movement for the first trailer, then do the same for the second trailer as if the first trailer was the towing vehicle (see Section XII, *Trucks and Buses*).

Backing Up

Reverse movement is handled just like regular movement. First, move the towing vehicle to its new position. Then move the trailer counter backwards in a straight line along its long axis. When the tongue is as close as possible to the hitch point, hold one corner of the trailer down and pivot it until the tongue is once again over the hitch point. As with forward movement, a collision takes place only if the trailer ends its movement in contact with another object.

A vehicle towing a trailer may attempt to back up at any reverse speed up to 20 mph, but backing up can cause a trailer to jackknife. It is not wise to back up at more than 5 mph; 2.5 mph is safer yet.

The jackknife effect is quite realistic. This is the way a trailer actually behaves. Practice maneuvering trailers on your own; if you ever have to back your way out of a tight spot in a game, you don't want to run into a wall.

Regardless of the *player's* skill manipulating counters, the *character* must have the proper skill to back up safely with a trailer. The skill needed depends upon the towing vehicle — Driver for cars, Cyclist for motorcycles and trikes, Trucker for oversized vehicles. If a non-skilled character tries to back up a vehicle/trailer combination in a straight line, he must roll 1 die on every phase of movement. On a 1, the rear of the trailer swerves 1 square ($\frac{1}{4}$ ") out of line. (Roll randomly for direction.) If the vehicle/trailer is being backed in any way except a straight line, the trailer will swerve on a roll of 1, 2, or 3. The swerve will always be in the direction that tends to jackknife the trailer, rather than to straighten it out.

Jackknifing

A trailer is in a jackknife position whenever the side of the tongue hits the towing vehicle's rear. That is, whenever the side of the tongue triangle makes parallel contact with the towing counter's back edge, the trailer has jackknifed.

When a trailer jackknifes due to a fishtail, roll one die. On a result of 1, 2, or 3, the tongue or hitch (whichever has fewer DP) breaks and the trailer is loose. If the jackknife occurred due to a maneuver, the roll is not made until this jackknifed position is held for more than one consecutive movement phase. See the figure below.

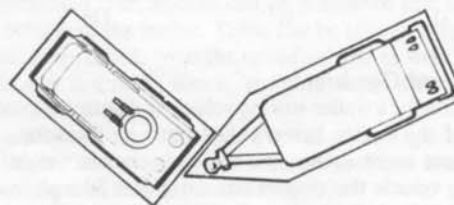

Loose Trailers

When a tongue or hitch is shot off, or breaks, or a trailer is deliberately released, there will be a loose trailer on the road. There is no way to control a loose trailer. The tongue hits the ground, taking one die of damage per 10 mph the trailer is traveling. Excess damage passes to the trailer's underbody armor. The trailer then makes a control roll at HC -1, and goes to Crash Table 2 if it fails. If it does not lose control, it continues to move in a straight line, decelerating 15 mph per turn and taking damage at its new speed at the end of every turn. The trailer starts to roll automatically if it hits a hazard or obstacle while loose. There can be no further fire possible from any gunners inside a rolling trailer until it stops, and then only if it stops right-side-up.

Crashes and Collisions

Cars or cycles towing trailers must roll on Crash Table 3 when they lose control. Cars and cycles towing trailers are affected normally by debris, obstacles, and other road hazards. Losing the first tire of a pair on a trailer is a D1 hazard. Losing the second tire of a pair is a D2 hazard. When all tires on one side of a car trailer are lost, go to Crash Table 3. Handling Class goes to -3 in this case.

When a vehicle/trailer combination is involved in a head-on or rear-end collision, use the combined weight of the towing vehicle and trailer when determining collision damage. If a vehicle/trailer combination is hit from the side, use the weight of the part (either vehicle or trailer) that was hit to determine collision damage.

4. Combat

Trailers that are 20 feet long or longer can mount weapons in "front" or "back" positions on each long side. They can also mount two turrets, one on the front top and one on the back top. They have the same arc of fire limitations as turrets on ten-wheeled trucks. If a trailer has two turrets, one must be designated as "higher" than the other. The higher turret has a full 360-degree arc of fire. The lower turret can not fire in the direction of the higher turret.

For trailers 20 feet or longer, weapons must be placed in the same

way as armor. That is, not "right," but either "front right" or "back right." Each trailer of this size has dots to show aiming points for these weapons; the arcs of fire are shown in the diagram below. Note that the arcs of fire overlap a great deal.

Oversized Arcs of Fire

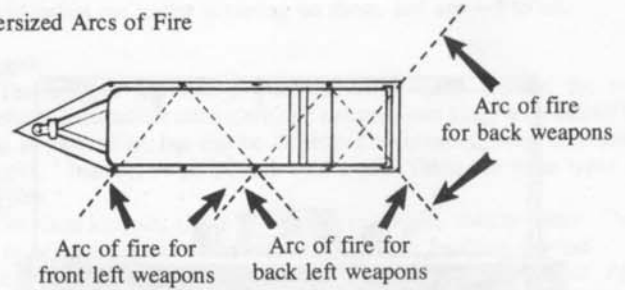

When an opponent fires at the top, underbody, or side of a trailer of this size, he must specify whether he is firing at the front or back half. He can only target a portion of the trailer at no penalty if he is in the arc of fire of that section of the target. Firing at a target within line of sight when the firer is not in that target's arc of fire is at -2. Because of the overlap of a trailer's arcs of fire, an attacker can often choose between targets with no penalty.

If the right front armor is penetrated (for example), any weapon firing from the front right will be first to take damage, followed by the vehicle's contents, the front left weapons, and finally, the front left armor. Damage to the front right does not affect the back-right-firing weapons, and so on. In general, fire must penetrate the front, top front, side front, or underbody front armor to affect anything in front, and the back, top back, side back, or underbody back armor to affect anything in the back of the trailer.

Smaller trailers (15 feet and less) mount weapons the same way cars do, and can only mount one turret. There are also limits to the turret's size — no more than 3 spaces for the 15-foot trailer, 2 spaces for the 10-footer, 1 space for the 6-footer, and the mini-van cannot mount a turret at all.



XII. Trucks and Buses

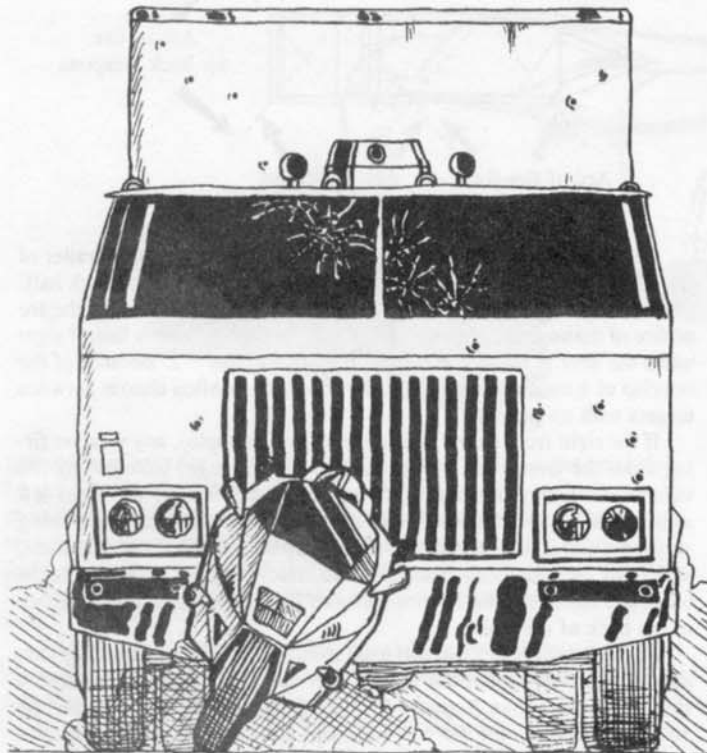

The roads are rough. Cycle gangs, highwaymen, barricade operators, random duellists . . . all take their toll. Most of the interstates haven't seen a repair crew in years. But somebody still has to take the big loads from city to city. And the big rigs are still rolling.

The truckers have quite a reputation. They're professionals. They're as skilled with their weapons as they are with their rigs . . . or they don't last long. A trucker, they say, never takes the first shot — but he always gets the last one. (Not always true, but it makes for a good story.) The men who make their living on the dangerous inter-city runs aren't interested in starting fights . . . only in finishing them. It's not a good idea to mess with the 18-wheelers. And their cousins, the armored buses, are every bit as formidable.

Truckers belong to a loosely organized but very serious society known as the "Brotherhood," which exists to deal with road problems that threaten the lives and incomes of its members. Unfair law enforcement, highwaymen, price-gouging, and trigger-happy road duellists are typical problems; the Brotherhood's response may range from a service slowdown in the affected area to — occasionally — a full-scale attack. More often, they simply circulate descriptions and license numbers of offenders. If every truck, bus, or armed courier is your enemy, you'd better stay off the road!

However, truckers are usually very courteous drivers, if you don't make trouble for them. A truck or bus will often stop to help a driver in trouble, or even intervene to break up an unfair road duel. Warning: anyone who attempts to ambush a driver by taking advantage of his good nature will certainly be marked by the Brotherhood if they find out who he is. Sending a brother to Highway One in a fair fight is one thing; double-crossing a Good Samaritan is *evil*.

The big rigs are formidable in battle for a number of reasons. They pack a lot of firepower, and they're just plain big — big enough to make a collision with one a losing proposition. There are many other differences between a big rig and a smaller duelling car, and understanding these differences is crucial to dealing with them effectively.

1. Tractors

The "tractor" — the unit that pulls a trailer — is the single most powerful vehicle on the road. A complete tractor will have a body (including fifth wheel), armor, ten wheels, and a power plant. At the purchaser's option, it may have a reinforced chassis, wheelguards, and various other items of equipment . . . plus, of course, weapons.

Body Types

Tractor bodies come in four styles. The body price includes lights, standard CB, loud horns, and fairly luxurious upholstery. It also includes the "fifth wheel."

Body type	Cost	Weight	Load	Spaces
Std. cabover	\$12,000	3,500	10,000	19
Std. longnose	\$14,000	3,700	11,000	22
Sleeper cabover	\$17,000	3,900	12,000	24
Sleeper longnose	\$20,000	4,100	13,500	27

"Load," on the chart above, refers only to the total weight of the tractor itself, not the amount of weight it can pull when the trailer is included. That is determined by the power plant used (see below).

The fifth wheel is the yoke on the back of a tractor — the hitch that allows a trailer to be attached. It is included in the tractor body price. A fifth wheel has 8 damage points and can be hit in combat. If this happens, it can be rebuilt or replaced for \$150 per point of damage. It will work until it is totally destroyed, but if it is destroyed while in use, the trailer will come loose. The fifth wheel must be located outside the armor, and can be attacked at a sizable minus to hit. If a tractor is rammed from the rear, the fifth wheel takes damage after the rear armor and before any rear-firing weapons.

Suspension only comes in one type for the oversized vehicle: Heavy. Therefore, suspension cost is included in the body cost. Any tractor, by itself, has a handling class of zero. Any bus, RV, or tractor-trailer rig has a handling class of 1.

Chassis

The strength of a tractor, bus, or RV chassis can be increased to allow more weight to be carried. The Standard chassis is regular equipment — it gives no bonus and costs nothing extra. A Heavy chassis costs 50% of the body price and gives a 10% bonus to the weight allowed. The Extra-Heavy chassis gives a 20% bonus to weight allowed, and costs 100% of the body price.

Armor

Tractor armor is mounted in the same way as regular car armor — front, back, right, left, top, and underbody. Fireproof, reflective, and reflective-fireproof armor are allowed on tractors, but the different types cannot be mixed.

Body type	Norm. (\$/wt)	FP (\$/wt)	Refl. (\$/wt)	LRFP (\$/wt)
Std. cabover	30/14	60/14	33/15.4	75/15.4
Std. longnose	32/15	64/15	35.2/16.5	80/16.5
Sl. cabover	32/15	64/15	35.2/16.5	80/16.5
Sl. longnose	34/16	68/16	37.4/17.6	85/17.6

Power Plants

Tractors use the same power plants as ten-wheelers, with two exceptions: The Small and Medium Truck power plants are not powerful enough to pull a big rig. The Regular, Heavy, and Super plants all have the same top speed (100 mph) and the same acceleration (2.5 mph/turn up to 25 mph, 5 mph/turn thereafter) as they do in ten-wheelers. The plants can push beyond the 100 mph maximum for short periods of time

under the same rules as ten-wheelers. The power plant is always assumed to be in front of the driver and crew, even in a cabover.

Tires

A tractor must have the same type of tire in all ten locations. Tractors use the same tires as ten-wheeled trucks.

Personnel

Almost all tractors are designed for two people — one driver and one alternate driver or gunner. Some have space for three people. Two spaces and 150 lbs. must be allowed for each person riding in the tractor's cab. A "sleeper style" cab has more space than a normal cab (see "Body types" chart above). If this space is actually used for sleeping room (rather than weaponry), allow 3 spaces per sleeping area. This lets one person sleep while the rig is on the road, allowing very long hauls.

Weapons and Armor

Weapons and armor for a tractor are located as for regular vehicles. A tractor may have a turret of any size.

2. Trailers

A semi-trailer has 8 wheels in back; a "full" trailer has 8 in back and 2 or 4 in front. The front wheels on a trailer are tied into the steering system of the tractor to make maneuvering possible. When the tractor is disconnected (on purpose or by accident), the trailer's front tires automatically lock in a straight-ahead position. This allows the trailer to roll free, if necessary.

Each trailer must have a body and a kingpin. Armor is not required, but could be useful. Trailers may also have wheelguards, weapons, and other accessories.

Trailer type	Cost	Weight	Spaces
40' flatbed	\$3,000	2,000	50*
40' van	\$6,000	3,000	80
40' reefer	\$10,000	3,500	75
40' tanker	\$16,000	5,000	60
40' dumper	\$11,000	6,000	70

No maximum weight is given for trailer capacity, because a rig's maximum weight is determined by the tractor's power plant.

*As with the flatbed carrier, the "space" rating of a flatbed trailer is an approximation. Use the rules given for flatbed carriers (see Section X, *Ten-Wheelers*), with these differences: There is a 1 in 6 chance for every ten full spaces over 50 that the load will fall off the trailer, and three dice spaces' worth of cargo will remain.

A flatbed trailer has no top or sides. It may carry a small armored box, no bigger than six spaces, to house defensive weapons. The box is armored in the standard six locations and the armor costs \$11 and weighs 5 pounds per point. It may be made reflective, fireproof, or both, at the usual penalties to cost and weight.

A dump trailer acts just like the dumper carrier, except it can devote up to ten spaces to weaponry.

A tank trailer is required to have at least 20 points of armor in each location, just like the tank carrier on ten-wheeled trucks.

Armor

Armor on the big trailers is located in ten positions, not six. The ten locations are front, back, front left, back left, front right, back right, front top, back top, front underbody, and back underbody. Essentially, the four "long" sides are divided into two target areas each (see "Combat" later in this section for a fuller explanation). Armor for all types of trailers costs \$40 and weighs 18 lbs. per point. Fireproof armor is \$80/18 lbs. per point; Reflective armor is \$44/19.8 lbs. per point; and Reflective-Fireproof armor is \$100/19.8 lbs. per point.

Tires

Trailers use the same tires as ten-wheeled trucks. A semi-trailer must have 8 tires (all of the same type), all on the back half of the trailer; they are paired two and two. (When shot at from the side, the

outer tire always takes damage before the inner one.) A trailer adds two more (one on each side) or four more (a pair on each side) at its front end. Semi-trailers have legs that swing down and support the front when not attached to a tractor. These legs have 5 DP each, but cannot be attacked unless the trailer is resting on them, and are -5 to hit.

Kingpin

The kingpin fits into a tractor's fifth wheel, holding the two together. Each trailer must have one and only one kingpin. It cannot be fired at in combat, but can be destroyed voluntarily (see "Explosive kingpin," below), or as a result of a crash. There are three types of kingpin:

Standard kingpin: Costs \$100, adds no weight, uses no space. Cannot be released except from outside — about a 5-minute process.

Explosive kingpin: Costs \$500, adds no weight, uses no space. Performs like a standard kingpin, but, in an emergency, it can be blown loose from inside the cab (this counts as a firing action). This releases the trailer instantly (see "Loose Trailers," below). The kingpin must be replaced before the trailer can be attached to any tractor (assuming the trailer survives at all).

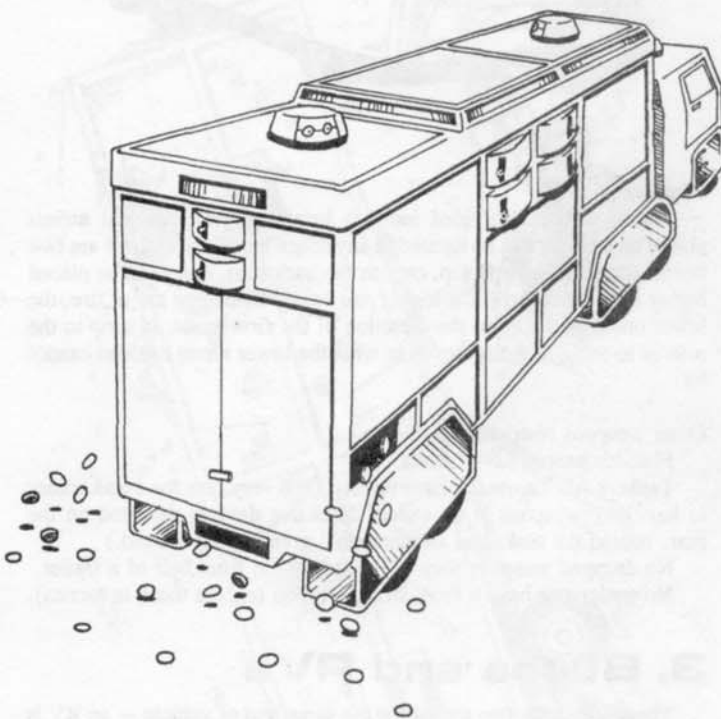

Quick-release kingpin: Costs \$1,000, adds no weight, uses no space. Performs like an explosive kingpin except that it doesn't destroy itself when activated. Thus, the trailer can be reattached (if it doesn't crash after being released). It takes about 30 minutes to reconnect a quick-release kingpin.

Ramps

Wheel ramps can be installed on flatbed trailers (or, occasionally, van trailers) so small vehicles can be driven on board. Cost, for a set of 2 ramps, is \$300. Weight is 200 lbs.; no extra space is required. The ramps are only destroyed if the trailer is wrecked.

An assault ramp may be installed on a van trailer (or bus or RV) to allow men, cycles, trikes, or subcompact cars to get in and out quickly. It is essentially an extra door in the back, a full 7½-foot wide. It may be dropped in any phase, but takes a full second (10 phases) to close. Since the assault ramp is essentially the rear armor, the vehicle's contents are exposed while the ramp is open. The ramp is only destroyed if all the rear armor is destroyed. Cost: \$1,000. Weight: 100 lbs. Requires one extra space for the opening/closing mechanism.

To determine how much cargo space a vehicle takes up, take the number of internal spaces (including cargo) the vehicle has. Then add 10 for cars, 4 for cycles, and 2 for sidecars. A luxury car, with 19 spaces, takes up 29 spaces as cargo. A heavy cycle, with 7 spaces, takes up 11 spaces as cargo.

Personnel

Trailers don't have drivers. Space for gunners or passengers may be allowed in a trailer. Each gunner takes two spaces; each passenger also takes up two spaces (rather than 1 as in a passenger vehicle).

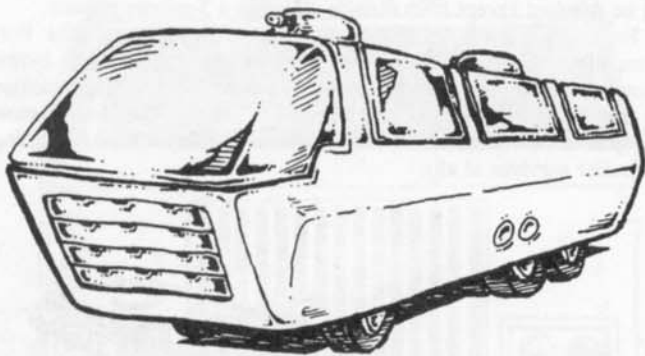

Weapons

Just as armor is divided into ten locations, weapons and turrets placed on a trailer can be located in any of ten locations. If there are two turrets (one on the front top, one on the back top), one must be placed higher than the other — the higher one has a 360-degree arc of fire, the lower one cannot fire in the direction of the first turret. It is up to the referee to settle any disputes over what the lower turret can and cannot hit.

Other weapons restrictions:

Flatbeds cannot have turrets.

Tankers don't normally have turrets. (It is very rare for a tank trailer to have any weapons at all except defensive devices mounted on the rear, behind the tank, and antipersonnel grenades all around.)

No dropped weapons may be placed on the front half of a trailer.

No trailer can have a front-firing weapon (except those in turrets).

3. Buses and RVs

These are really two names for the same sort of vehicle — an RV is just a luxurious privately-owned bus. When the term "bus" is used in these rules, RVs are also included. Some buses are designed mostly for defense and are escorted by heavily-armed cycles or cars. Others mount more than enough weaponry to take care of themselves.

Body

A complete bus will have a body, a power plant, ten tires, armor, and (probably) weapons. It may have a strengthened chassis, wheelguards, and other accessories. Almost all such vehicles have large passenger compartments — they are built for carrying and protecting customers, not for duelling.

Bus size	Cost	Weight	Load	Spaces
30-foot body	\$5,000	4,000	16,000	45
40-foot body	\$7,000	5,500	21,000	60

Chassis strength, power plant, and suspension are all chosen the same way as for a tractor. The handling class of a bus is 1. Buses must have ten tires — two in front and two pairs of two on each side in back. Any truck tire may be used, but all must match. Wheelguards (up to three per side) may be added with no loss of handling class.

Armor

Buses, like trailers, are very long, and have ten positions which must be armored. Buses can carry any type of available armor, but all armor must match.

Bus type	Norm. (\$/wt)	FP (\$/wt)	Refl. (\$/wt)	LRFP (\$/wt)
30-foot bus	35/17	70/17	38.5/18.7	87.5/18.7
40-foot bus	40/18	80/18	44/19.8	100/19.8

Personnel

These vehicles are designed for passengers. Like mini-buses, space for luggage and aisles must be allotted — two spaces and 200 pounds per passenger. Luxury options and crew positions are the same as for mini-buses.

Weapons

Weapons can be mounted on the front or back half of a bus counter's "long" sides. A bus can mount two turrets, but one must be designated as being "higher" so that it can fire over the other. Dropped weapons may not be mounted on the front half of a bus.

4. Combat

Turrets on a tractor, trailer, or bus follow the same restrictions as turrets on ten-wheeled trucks.

Note that the fifth wheel on a tractor is exposed — not protected by armor — and can be targeted at -6 by any opponent that can get a line of sight on the black dot on the counter, whether or not a trailer is attached. The fifth wheel will never be hit by gunfire unless it is being targeted.

The arcs of fire for a tractor are determined in the same way as regular cars: Draw two diagonal lines through the opposite corners of the counter, and the four arcs of fire are marked. Trailers and buses have more complicated arcs of fire, using the black dots on the long edges of each counter. The arcs of fire are as follows:

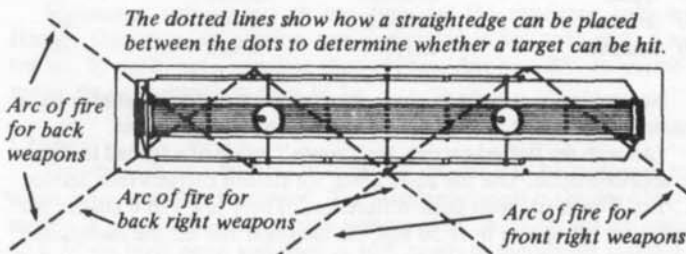

Note that the side arcs of fire overlap quite a bit. Anyone attacking a tractor-trailer rig or bus from the side may have a choice of targets without penalty, and must specify what he's shooting at.

A tractor takes damage the same way a car does. A trailer or bus takes damage the same way a large car trailer does (see Section XI, *Car Trailers*).

5. Movement

Movement for oversized vehicles follows the principles of the basic vehicular movement rules, with certain changes.

Handling Class

Oversized vehicles don't handle easily. The handling class of a tractor without a trailer is 0. Addition of a trailer makes the whole rig HC 1. Buses and RVs are also HC 1. Further increases in handling class can come only from good reflexes, aided by the Trucker skill (see Section VII, *Continuing Characters*).

Acceleration and Deceleration

Big rigs and buses use the same acceleration rules as ten-wheeled trucks. Any big rig decelerating at more than 30 mph in one turn goes

directly to Crash Table 3 (p. 41) and takes two dice of damage to each tire. Buses decelerating more than 30 mph in one turn take the same amount of tire damage and go to Crash Table 2 (p. 11).

Straight-Line Movement

Buses are represented by single long counters. Counters for tractor-trailer rigs, though, have two components — the tractor and the trailer. These are combined to form a “rig.” A trailer cannot accelerate by itself, and usually crashes if it comes loose during movement (see below). A tractor can move by itself; its acceleration is better but its handling class is worse.

To use the tractor and trailer counters, place the trailer so it overlaps the back of the tractor. The black dot on the front of the trailer represents its “kingpin.” The black dot on the back of the tractor represents the “fifth wheel.” The kingpin on a trailer fits into the fifth wheel; therefore, the black dot on the trailer must be directly over the black dot on the tractor at the end of each maneuver.

Buses and tractor-trailer rigs move forward one inch during every phase in which the Movement Chart indicates they should move based on their speed, just like a passenger car.

Maneuvers

Buses and tractors maneuver in the same way cars do, except that a tractor-trailer rig cannot attempt a bootlegger. Use the descriptions and pictures from Section IV, *Movement*. The car pictures should be assumed to represent the front inch of the oversized vehicle. The turning key included in this set can also be used.

Tractor-trailer rigs maneuver and back up in the same way as vehicles towing car trailers. See the rules in Section XI, *Car Trailers*, substituting the big rigs’ “kingpin” for tongue, and “fifth wheel” for hitch. At the end of each maneuver, the black dot on the trailer (the kingpin) must be directly over the black dot on the tractor (the fifth wheel). The tractor may never make less than a 90-degree angle with the trailer; if it does, the rig has jackknifed. Roll one die: On a 1, 2, or 3, the kingpin breaks and the trailer comes loose.

Ultra-Slow Movement

A truck making a complicated maneuver in a tight space (e.g., parking or entering a fortified area) will move very slowly. In real life, it might move at only 1 mph. For game purposes, 2.5 mph is the slowest practical speed. This translates to one ¼” square per turn, moving in Phase 5.

A rig moving at this speed should place its speed marker on the line between 0 and 5 mph on the record sheet. On each turn, the tractor may move as follows:

- (a) ¼” straight forward, or
- (b) ¼” straight forward and pivot, as per the regular vehicle pivot, or
- (c) pivot without any forward movement at all.

The trailer will follow the tractor as per normal movement.

Loose Trailers

When a fifth wheel is shot off, a kingpin breaks, or a trailer is deliberately released, the trailer will come loose.

If the loose trailer is a true trailer, with wheels on the front end, treat it like any other uncontrolled vehicle. It moves forward in a straight line, decelerating at 5 mph each turn. It cannot maneuver. Treat it as having a handling class of 1. If it encounters a hazard, a roll must be made as for any other vehicle, and a “loss of control” result will send it to Crash Table 2. As long as it does not lose control, any gunners in the trailer may fire the trailer’s weapons (except lasers, which require the tractor’s power plant).

Semi-trailers, with no front wheels, crash immediately if released by a moving tractor. The front of the trailer hits the ground, the underbody front armor takes one die of damage for every 10 mph it is going when it hits, and the semi goes to Crash Table 2. If by chance it does not “lose control” at that point, it moves in a straight line, decelerating by 15 mph at the beginning of every turn and doing more damage, as above, at the beginning of every turn until it stops. It has a handling class of -1. If there are gunners in the semi, they will not be able to fire their weapons until it stops, and then only if it is right-side-up.

When a semi hits the ground, the kingpin breaks; thus, it cannot be

reattached to a tractor until the kingpin has been replaced.

6. Crashes and Collisions

Buses and tractors without trailers use the same Crash Tables as cars if they lose control. When a tractor-trailer rig loses control for any reason, it goes directly to Crash Table 3.

Debris and Obstacles

Buses and tractor-trailer rigs treat debris and obstacles the same way as ten-wheeled trucks. The road and combat hazards that affect buses and tractor-trailer rigs (such as losing tires, taking damage from enemy fire, etc.), are also the same as those that affect ten-wheeled trucks (see list, p. 39).

Collisions

Use the collision system detailed for cars in Section IV, *Movement*. Note how dangerous a fully loaded tractor-trailer rig can be, even at low speeds, due to its high damage modifier.

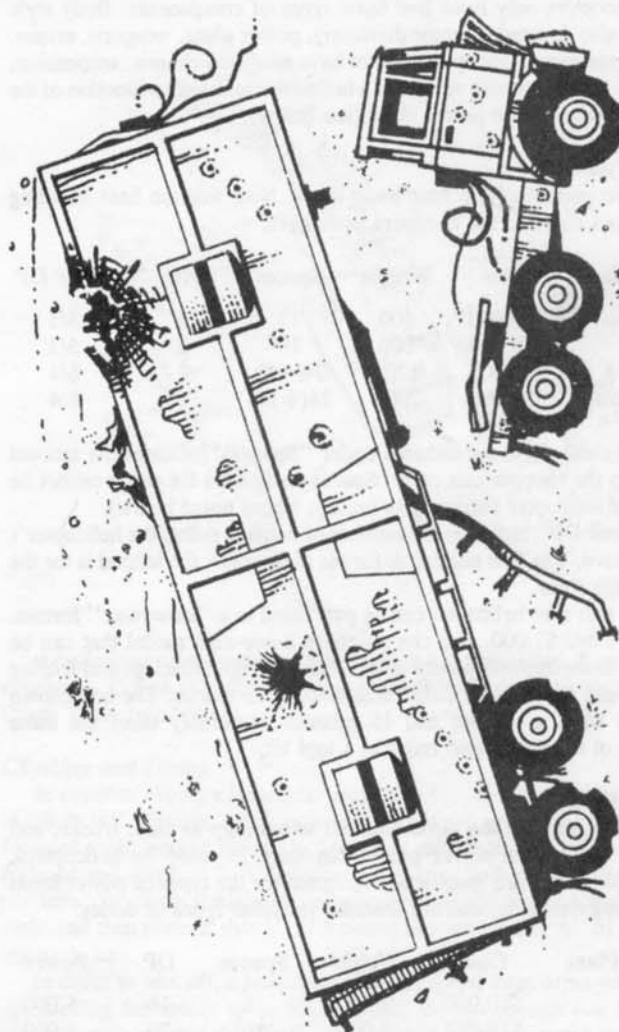

If you’re using the Simplified Collision System, remember that vehicles of vastly different weights are not going to bounce equally in a collision. Use your judgement. A vehicle between 10,000 and 19,999 pounds will do double damage in a collision. Triple the damage if the vehicle weighs from 20,000 to 39,999 pounds, and quadruple the damage for rigs that weigh 40,000 to 80,000 pounds!

Steamrolling

Tractor-trailer rigs and buses can steamroller smaller vehicles, just like ten-wheelers. But where the ten-wheelers can only steamroller cycles, the big rigs and buses can also steamroller compacts, subcompacts, and light and medium trikes. Steamrolling a car or trike is a D3 hazard. All other rules are the same as for ten-wheelers.

XIII. Helicopters

Sleek, fast, and powerful, helicopters cruise the skies of 2035. They're not practical for long-distance travel, but they're the premier attack and rescue vehicles of the age. Like their 20th-century counterparts, they're fast, versatile, maneuverable, and have the potential for heavy firepower and armor. They're also less safe and more cantankerous than ground vehicles. They're also fairly expensive. But if you need to get somewhere fast, or need to go where no ground vehicle can cut it, a chopper is the way to go.

1. Construction

Helicopters follow construction rules similar to those for cars. The important factors are still cost, weight, and space. To build an effective helicopter, these must be juggled with care.

Helicopters only have five basic types of components: Body style (which also determines rotor diameter), power plant, weapons, armor, and accessories. Helicopters do not have modified chassis, suspension, or tires. The maximum weight of a helicopter is strictly a function of the power factors of the power plant (see below).

Body Types

Helicopters come in four basic types. Note that the base handling class goes down as the choppers get bigger.

Body size	Price	Weight	Spaces	HC	Rotor DP
One-man	\$10,000	500	13	3	3/3
Small	\$20,000	800	19	2	5/3
Standard	\$40,000	1200	24(+6)	2	6/4
Transport	\$80,000	2000	24(+17)	1	8/4

The numbers in parentheses under "Spaces" indicates the amount of cargo the chopper can carry. Spaces designated for cargo cannot be used for helicopter components (except where noted below).

"Rotor DP" indicates the number of damage points the helicopter's rotors have. The first number is for the main rotor; the second is for the stabilizing rotor.

The one-man helicopter can be purchased in a "stowaway" format. For an extra \$1,000, you can purchase a one-man model that can be broken down into component parts. It has a hinged fuselage and folding rotors, and fits into any cargo area holding 13 spaces. The breakdown process takes a tool kit and 15 minutes. Assembly takes the same amount of time (and also requires a tool kit).

Power Plants

Helicopters use the same fuel-cell technology as cars, trucks, and cycles. Helicopter power plants can only be used in helicopters, however — they are specifically designed for the types of power loads that flying demands, and are unsuited for other types of duties.

Power Plant	Cost	Weight	Spaces	DP	Power
Mini	\$10,000	2,500	8	16	5,000
Small	\$15,000	3,000	10	20	8,000
Standard	\$20,000	3,500	13	26	14,000
Super	\$25,000	4,000	16	32	20,000

Acceleration for helicopters is computed differently than for cars, as a significant part of their power goes toward merely staying off the ground. If a helicopter power plant's factors are less than the helicopter's weight, it is underpowered and won't lift off; if the factors are at least equal to its weight but less than one and a half times its weight, its acceleration is 5 mph on the straightaway; if the factors are one and a half times its weight or more, acceleration is 10 mph on the straightaway.

The maximum speed of a helicopter with a Mini power plant is 180 mph; the other three plants have a maximum speed of 200 mph. These maximum speeds *can* be exceeded for short bursts, by pushing its

engine, in which case the same rules used for car power plants apply, or by diving (see below).

The range of a helicopter with a full charge is 200 miles. This assumes a cruising speed of 100 mph. These 200 "power units" will get you further at slower speeds; they will be used up more rapidly at higher ones. The rules for how speed affects vehicle range are given in the power plant section of Section VIII, *Car Design*. Just use 100 mph as the base speed (using 10 power units for 10 miles traveled), and extend the table from there. Firing a laser also drains power units — see the same section. A power plant charge takes 10 minutes at any power station or truck stop that can accommodate a chopper, and costs \$250.

Armor

Helicopters need armor in six locations: Front, back, left, right, top, and bottom. The main rotor and the stabilizing rotor are not protected by armor. All the usual types of armor are available for helicopters, and mixing types is not allowed.

Body Type	Norm. (\$/wt)	FP (\$/wt)	LR (\$/wt)	LRFP (\$/wt)
One-man	16/8	32/8	17.6/8.8	40/8.8
Small	20/10	40/10	22/11	50/11
Standard	30/14	60/14	33/15.4	75/15.4
Transport	35/17	70/17	38.5/18.7	87.5/18.7

Weapons

Weapons work for helicopters pretty much the same way they do for land vehicles. There are certain differences in mountings, methods of aiming, and so on, but all of the weapons available to ground vehicles are usable for helicopters. (Two weapons — the bomb and the cluster bomb — are usable only by helicopters. Full stats appear with the rest of the weapons.) Note that dropped weapons won't be as useful. Paint sprays and smokescreens operate normally, but a helicopter has to be within 7½ feet — ½" in game scale — of the ground for oil sprays, spikedroppers, and minedroppers to work; above that altitude, the oil, spikes, and mines spread out too much to be effective.

Vehicle weapons may be mounted on a helicopter's front, back, sides, and bottom. Turrets can only be bottom-mounted. A turret may fire as a left-, right-, front-, or back-mounted weapon, and is protected by bottom armor. Side- and bottom-mounted weapons may be mounted in cargo space. Back-mounted weapons must be taken from cargo space, if the chopper has cargo space to begin with.

Arcs of fire must be considered three-dimensionally — see "Combat," below, for a full explanation.

Accessories

A wide variety of special equipment is available for helicopters. Nearly every accessory listed in Section VIII, *Car Design* can also be mounted on a helicopter — with some obvious exceptions, like wheelguards. What follows is a list of accessories that can *only* be used in helicopters.

Winch: 1 space, 100 lbs., \$500, 1 DP. Winches are mechanisms which haul up cargo and personnel on stout cables. They must be mounted on a side with a door (or in the bottom, in the case of a helicopter with a bomb bay), and may only be used when that door is open. The machine consists of a revolving drum mechanism and a 90-foot (6" game scale) cord. The mechanism is capable of supporting 4,000 pounds. The mechanism safely reels out the cord at 1"/second; it will reel it in at 1"/second if the weight attached is less than 1,000 lbs., ½"/second if the weight is 1,000-1,999 lbs., and ¼"/second if the weight exceeds 2,000 lbs. The cable takes 1 person and 3 seconds (6 seconds in the case of a vehicle or similar-sized object) to attach to the object in question. Example: A hovering helicopter can lower one crewman 90 feet in six seconds. That crewman takes another three seconds to attach the cable to another character being rescued, and then the winch mechanism takes another 6 seconds to reel the two of them up. If he'd attached it to a heavy motorcycle, it would take longer.

The winch cable can only be hit by weapons that can make "area effect" attacks (that is, machine guns, flamethrowers, and lasers). Under those circumstances, it has 10 DP, and is -8 to hit.

Personal Parachute: 2 grenade equivalent, 20 lbs. as cargo, \$200, 4 DP. Personal parachutes are used when people bail out of aircraft. (A person bails out by moving his counter to a square which is not considered flooded — i.e., he steps out of the door, or through the bomb bay.) Falling rates are described later, but a parachute will not activate in time to save a character unless he bailed out at an altitude of 20" or higher. The parachute opens once the character has fallen for 16", brakes the character's descent for the next 4", and then acts as a hang-glider (see "Peculiar Equipment," below). An open parachute may only be damaged by a flamethrower; however, it is +3 to be hit due to its large size.

Vehicular Parachutes: 3 spaces, 150 lbs., \$1,500, 4 DP. Vehicular parachutes operate in much the same way as personal parachutes, but are used when dropping large crates of supplies or actual vehicles. Vehicles up to 2,000 lbs. can be dropped by vehicular parachute. They can only be operated successfully from a height of 30" or more, opening after 20" of free fall, and acting like hang gliders after another 10". They are +4 to be hit with flamethrowers.

Skids: No weight, space, or cost. Skids are standard equipment on helicopters; all helicopters have a pair of skids to land on. Targeting a skid is at -8, and their DP varies — 8 DP each for a one-man or small chopper, and 12 DP each for a standard or transport helicopter.

Skid Stretchers: No spaces, 25 lbs., \$300, 2 DP. Skid stretchers are man-sized cylinders mounted to a helicopter's skids for the purpose of carrying extra people. Each one adds one space of room to a helicopter, but that space cannot be used to house weapons. Skid stretchers are unarmored and thus defenseless, and are targeted as though they were pedestrians (-3 to hit).

Pontoons: No spaces, 50 lbs., \$500, 7 DP. Pontoons are skid mounts which enable a helicopter to land on water. If one or both pontoons are destroyed, a helicopter that has landed on water has only three turns to take off again — after that the chopper will have sunk too far to pull itself out; it will be completely underwater in another 10 turns. Pontoons are targeted at a -3.

Bomb Bay: 1 space, 100 lbs., \$1,000. Bomb bays are bottom-mounted doors through which large equipment can be dropped. (Note that a helicopter does not have to have a bomb bay to use bombs. Bombs can be installed outside the chopper, or have their own little doors — used only for that bomb.) The bomb bay doors are actually the helicopter's bottom armor; when they are open, the helicopter effectively has no bottom armor. To open the bomb bay doors, one crewman of the helicopter must activate them (which counts as a firing action); at the end of the next turn, they are open. The same sequence is used to close them.

2. Movement

Helicopter movement is more varied than ground movement — there are three dimensions to keep track of instead of two. For each helicopter, you must keep a scratch-pad record of the chopper's altitude, measured in quarters of an inch in game scale. This height designates where the bottom of the helicopter is at any given time (0" being on the ground).

Acceleration and Deceleration

A hovering helicopter (that is, one that is not attempting to change its altitude up or down) moves forward in 1" increments on the phases shown for its speed — just like cars. Helicopters accelerate on the straightaway like cars: At the beginning of each turn, helicopters reset their speeds, move their record counters to the appropriate speed blanks on the Movement Chart, and then move during the phases indicated on the chart. Two rates of acceleration are available to helicopters — 5 mph or 10 mph. A helicopter can accelerate more quickly by diving (see below).

If a helicopter exceeds 200 mph — by pushing its power plant or by diving — find its current speed minus 100 mph on the speed chart. Move the vehicle in the phases indicated for that speed, but add 1" of movement to each phase. Thus, a vehicle at 240 mph would move 2" in phase 1, 3" in phase 2, 2" in phase 3, 3" in phase 4, and so on.)



A helicopter may decelerate 5 or 10 mph per turn safely. It may also decelerate 15 mph in a turn, but must immediately roll on the Helicopter Crash Table (see below).

Climbing and Diving

In order to climb, a helicopter sacrifices $\frac{1}{2}$ " of forward movement to climb $\frac{1}{4}$ ". That is, a helicopter which has the option of moving 2" forward could instead move $1\frac{1}{2}$ " forward and climb $\frac{1}{4}$ ", or move 1" forward and climb $\frac{1}{2}$ ". A helicopter may not climb at more than $\frac{1}{2}$ " per turn. To climb straight up, a helicopter should set its speed at 10 mph, and then convert that 1" of forward movement into $\frac{1}{2}$ " of climbing each turn.

In order to take off, a helicopter must (a) spend three turns warming up, kicking the rotors up to flight speed; (b) go through one turn at speed 0 while starting the liftoff; and (c) go to whatever speed its acceleration indicates to start the liftoff. If the acceleration is 5, the vehicle may only climb $\frac{1}{4}$ " the first turn. If the acceleration is 10, the vehicle may either climb $\frac{1}{2}$ " or move forward $\frac{1}{2}$ " and climb $\frac{1}{4}$ ". A helicopter on the ground — but not switched off — may stay in its warm-up mode, and thus only take one second at speed 0 before taking off.

A helicopter may accelerate more quickly by diving. A too-steep dive can have disastrous effects, but a shallow dive can safely increase a vehicle's speed. A helicopter must spend a full second diving, moving as many inches as its current speed indicates. The player specifies how much altitude will be lost during a turn, within certain limitations (described below). For every $\frac{1}{2}$ " of altitude lost, the helicopter picks up 5 mph of forward speed during the acceleration phase of the next turn.

A helicopter must accelerate into a dive — the pilot can't simply go from level flight to a 60-foot dive and pick up 40 mph of speed, all in one second. A helicopter can pick up 10 mph/turn of acceleration while diving, above and beyond the helicopter's normal acceleration. Keep track of how much speed is picked up through diving, as this will have to be offset when the chopper pulls out of the dive.

A helicopter pulls out of a dive by applying some of its forward movement speed toward increasing altitude — with ½" movement lifting the vehicle ¼". However, a helicopter which has been diving for speed must offset the dive rate before beginning to climb. The dive rate is reduced by 5 mph for every ½" of "climb." Note: Forward speed slows when the chopper pulls out of a dive.

For example, a diving chopper has gained 35 mph of speed because of the dive, losing 3½" of altitude per second. Now, its pilot wants to pull out of the dive. But he can't just "stop diving" — he has to "gain altitude" to offset the dive. Pulling out of the dive all in one turn would put too much stress on the copter and tear it apart. A player with a diving helicopter can only put 1" of movement per turn toward climbing — thus, the character goes to a 30 mph dive at the end of the first second, 25 mph at the end of the second, 20 at the end of the third, and so on until it is at level flight at the end of the seventh turn.

A helicopter can lose altitude without diving, at the rate of ½" per turn. Such a descent does not affect the chopper's speed at all.

Maneuvers

In terms of game mechanics, maneuvering helicopters is just like maneuvering cars. During each of its movement phases, a helicopter player may specify a maneuver for the craft. Each maneuver has its own difficulty class, which reduces the helicopter's handling status for the turn.

A helicopter's initial handling class is determined by the size of the helicopter, and is modified by the pilot's reflex roll, which is in turn modified by the Pilot skill. Pilot +1 adds 1 to the reflex roll, +2 adds 2, etc. Without the Pilot skill, a character can barely start a helicopter, much less fly one. The base HC of a helicopter, plus any bonuses the

pilot has in the Pilot skill, determines the amount the chopper's handling status is advanced on the handling track at the beginning of each turn. This is the same system used for cars. For a more complete discussion, see Section V, *Movement*.

A helicopter can make the following maneuvers:

Move straight ahead. This can be done while climbing or dropping; HC is not adjusted.

Dive. This is a D1 maneuver in any phase during which the chopper moves forward 2" or more.

Coordinated Turn. This is exactly like a "swerve" for cars, and is a D1 maneuver.

Veer. This is exactly like a "bend" for cars (see diagram below), and is a D3 maneuver. If a chopper moves 2" in a phase, the veer takes place during the second inch.

Shift. This is like a "drift" for cars, and is a D1 maneuver.

Drift. This is also a D3 maneuver (see diagram below), and is similar to the car's "steep drift."

Rotate. This is a D2 maneuver (see diagram), and is a fast means of turning around. It can only be done if the chopper is moving 20 mph or less. On each movement phase, move the helicopter in the direction it had previously been heading, but rotate it up to 90 degrees. At the end of two phases, it is facing in the opposite direction to its original movement (see *Fly Backwards*, below). Helicopters moving 0 and 5 mph may rotate as well, turning 90 degrees each phase.

Fly Backwards. This has few tactical advantages except for aerial maneuvering and takeoffs in uncomfortable circumstances. A helicopter may fly backwards up to 20 mph; a helicopter flying backwards may perform the same maneuvers described above, at +D1 at 5 or 10 mph, and +D2 at 15 or 20 mph.

These are the only maneuvers helicopters are allowed to attempt. Tighter maneuvers would subject a helicopter to too much stress and tear it apart.

Helicopters check for control in the same way as other vehicles. Cross-index the handling status of the chopper with its speed on the

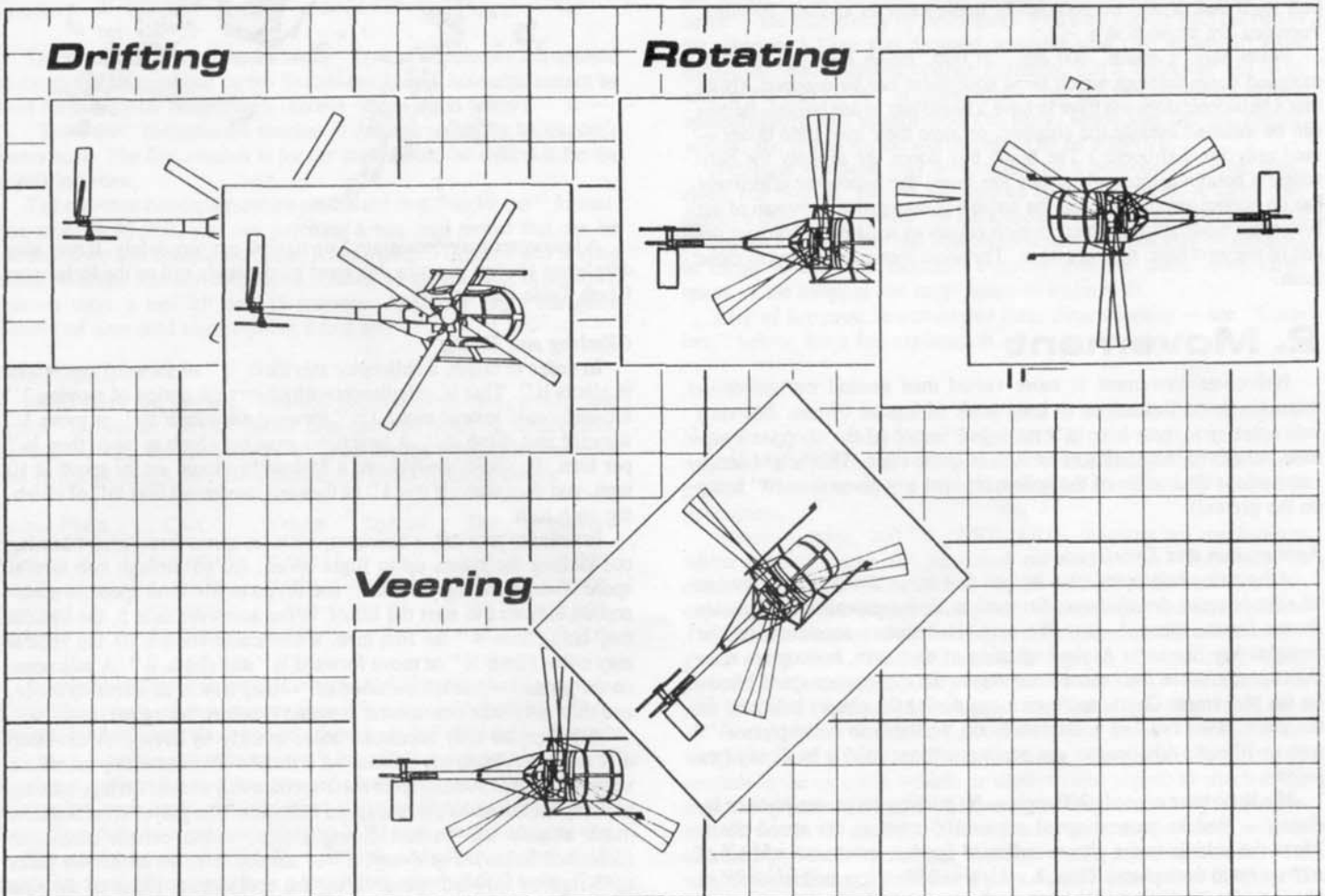

Control Table. If a control roll is called for, roll the die. If you lose control, add the appropriate modifier from the Control Table and roll on the Helicopter Crash Table.

Hazards

Hazards affect helicopters immediately, as they occur, decreasing the chopper's handling status.

Some sample hazards:

- Colliding with another aircraft or vehicle: D4.
- Enemy fire, doing 1-5 points of damage: D1.
- Enemy fire, doing 6-9 points of damage: D2.
- Enemy fire, doing 10 or more points of damage: D3.
- Stabilizing rotor destroyed or failed: D4.
- Pilot injured or killed: D2.

Crashing

Helicopters crash in two ways: One is simply to lose control; the other is to run into something (whether flying horizontally or falling vertically). The Helicopter Crash Table refers to the first. (Of course, you will eventually run into some solid object if you don't regain control.)

Helicopter Crash Table

- 1, 0, 1 — *Involuntary drift*. The helicopter performs a drift maneuver in the direction it was maneuvering toward, and loses ¼" altitude. (If it was flying straight, roll randomly for the direction off the drift — 1-3 left, 4-6 right).
- 2, 3 — *Involuntary veer*. The helicopter executes a veer maneuver in the direction of its last maneuver (if flying straight, roll randomly as above) and loses ½" altitude.
- 4, 5 — *Severe veer*. The helicopter executes a veer maneuver in the direction of its last maneuver. It loses 1" of altitude. Weapons fire is at a -3 this turn.
- 6, 7 — *Diving veer*. The helicopter executes a veer in the direction of its last maneuver. It loses 1½" of altitude and is considered diving at 10 mph. In addition, on the following movement phase of the helicopter, it *must* perform a drift in the direction of the veer or it will automatically continue the veer. The handling difficulty due to that drift will not count against handling. Weapons fire is forbidden during the diving veer. Check for rotor failure, as described below.
- 8, 9 — *Spinout*. The vehicle turns 90° to its flight-path at the end of the phase, in the direction of its last maneuver. Check for rotor failure. On its next phase, the helicopter will automatically go into a diving veer. Weapons fire is prohibited.
- 10 and above — Rotors fail automatically.

When a helicopter strikes another object (including the ground), calculate the speed of collision and assess damage in the usual manner. When an object is in free-fall (which is what happens when the rotors fail), the speed of the chopper when it hits the ground is a function of how far it's fallen. The force of gravity is 32 feet/second/second, which, in game scale, translates into something between 2" and 2¼" per second per second. Use the following table to determine free-fall damage:

Free-Fall Damage Table

Time Elapsed	Distance	Total Distance	Speed
1st second	2¼"	2¼"	20 mph
2nd second	4¼"	6½"	45 mph
3rd second	6½"	13"	65 mph
4th second	8½"	21½"	85 mph
5th second	10¾"	32¼"	110 mph
6th second	12¾"	45"	125 mph
7th second	15"	60"	150 mph
8th second	17"	77"	170 mph
9th second	19¼"	96¼"	190 mph
10th second	21¼"	117½"	215 mph

It is highly unlikely that a helicopter will be higher than 117", but if it happens, extrapolate from the chart. Note that unless a helicopter is flying level or climbing when it enters free-fall, there will be additional downward speed in the collision. If a chopper was already dropping 3½" a turn (that's 35 mph), when the rotors fail, add that 35 mph to the final free-fall collision speed. Always round to the lower speed if the distance fallen is between two of the "Total Distance" numbers.

Example: Trying to pull out of a too-steep dive, a helicopter loses its control roll really badly and loses its rotors. At the moment the rotors were lost, it was traveling downward at a speed of 30 mph and was 14" off the ground. On the table above, 14" is between 21½" and 13", so we use the 13" line — when the chopper hits the ground, it will have a freefall speed of 65 mph. Then add in the chopper's downward speed of 30 mph, and we get a collision with the ground at 95 mph. This is likely to hurt. A lot.

Most collisions (flying into buildings, diving into the ground, even hitting another helicopter) will destroy the rotors automatically. An exception might be a situation where the bottom half of a chopper clips the roof of a building. The referee is the final arbiter of such situations.

Rotor Failure

Any time a helicopter crashes or performs a stressful maneuver as indicated on the Helicopter Crash Table, a Rotor Check must be made. There is the possibility that the rotors will fail — breaking, in the case of a maneuver, snapping off, in the case of a collision. Note: A spinning rotor blade will do 4d6 damage to whatever it hits.

Rotor Check

Roll two dice:

2-7 — No effect. Rotors are still in working order.

8-10 — Rotors damaged. Roll on this table every turn during the speed-setting phase, and consider any result of "rotors damaged" to mean "rotors fail."

11-12 — Rotors fail. Helicopter drops like a stone. Bon voyage.

Modifiers

Helicopter is moving 80 mph — 120 mph: +1

Helicopter is moving 121 mph — 160 mph: +2

Helicopter is moving 161 mph — 200 mph: +3

Helicopter is moving over 200 mph: +4

Engine damaged: +1

Rotor damaged by weapons fire: +4

If a helicopter's engine fails but its rotors are still intact, it has a chance of descending safely. Forward momentum slows by 5 mph/turn, and the copter drops ½"/turn. The helicopter player must roll on the Helicopter Crash Table at the beginning of every turn.

3. Combat

Helicopter combat is the same as ordinary vehicular combat — with the added complication of a third dimension, of course.

Location of Damage

As with cars, helicopters can take damage in a variety of locations. If front armor is hit, the front armor takes damage, then whatever was behind it, then whatever was behind that, and so on. To determine what is behind helicopter armor in the various locations, check the following lists:

Front: Front armor; front-firing weapons; pilot or co-pilot/gunner; electronics bay; motor; cargo; back weapons; back armor.

Back: As above, but in reverse order.

Right: Right armor (door); right-firing weapons; roll between pilot, co-pilot/gunner, electronics, bay, motor, and cargo; left-firing weapons; left armor (door).

Left: As above, but in reverse order.

Bottom: Bottom armor; bottom weapons; roll between cargo, motor, electronics bay, pilot, or co-pilot/gunner; top armor.

Top: As above, but in reverse order.

Skids, pontoons, main rotors, and stabilizing rotors must be targeted individually. They will never be hit as part of another attack.

Skids are a -8 to hit; pontoons are a -3. If one or both skids or pontoons are destroyed, the helicopter will tip gracelessly on one side (one die damage to that side) when it lands, and the main rotor will break.

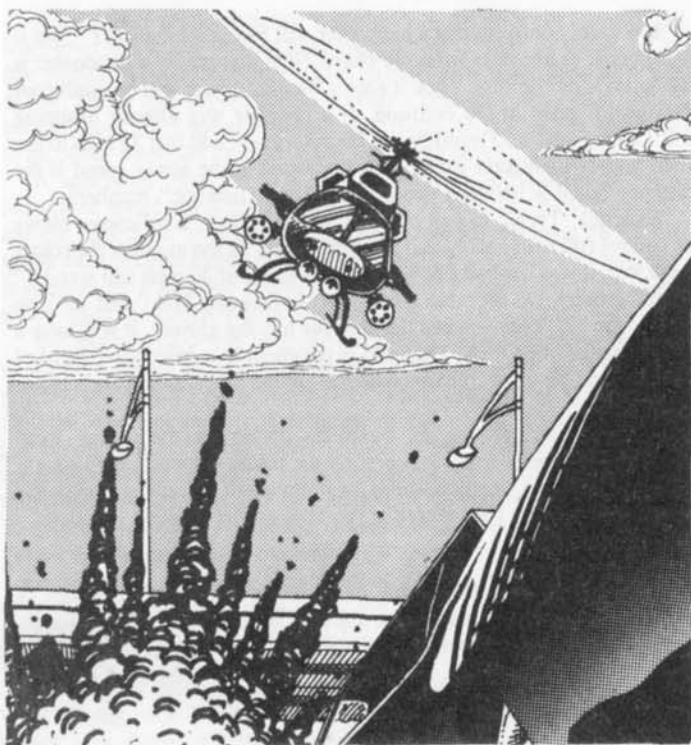

The stabilizing rotors and main rotors are a -6 to hit. If they are hit, roll one die. On a 6, the rotor takes 2 hits of damage. Otherwise, it takes 1 — no matter what weapon was used. This is because most of the effect of any weapon attack upon a rotor will go into empty air. If the main rotor is destroyed, the helicopter drops. If the stabilizing rotor is destroyed, the helicopter goes into an involuntary and unending series of counter-clockwise Rotate maneuvers, which will only cease when the helicopter lands. The pilot must make a control roll during the first movement phase of every turn, and the helicopter's rotating maneuvers *do* count against its handling class.

Arcs of Fire

In combat, a helicopter may target anything within its arc of fire. It may be targeted by an attacker who is within the theoretical line of fire of one of its sides, and on that side only. In other words, if a helicopter can target a vehicle with its right side, the target vehicle can fire upon the helicopter's right side in return. If the helicopter can target with both its underside and left side, the target may return fire upon both underside and left side, as it chooses.

Ground vehicles suffer some arc-of-fire problems when attacking helicopters. For example, a front-mounted weapon cannot target something directly overhead. Vehicular weapons can target any object that is farther away than the difference in their altitudes. That is, if Helicopter A is in Car B's normal arc of fire, and is 5'' away and 4'' up, Car B can hit it. If, however, it is 4'' away and 5'' up, Car B cannot hit it.

If two vehicles are at different altitudes, add their two range modifiers together to get the correct range modifier for the shot. The point blank range modifier is only used if both ranges are point blank.

Examples: The target is 7'' away (-1 range modifier to hit) and 6'' up (also -1). The total range modifier is -2. The target is 10'' away (-2) and 6'' up (-1). The total range modifier is -3. The target is 4'' away (no mod.) and ½'' up (point blank). Because *both* ranges are not point blank, ignore the one point blank result and change it to "no modifier." The total range modifier is 0. The target is 1'' away (point blank) and ¼'' up (also point blank). Because both ranges are point blank, the point blank modifier is in effect: +4.

Hand-held and tripod-mounted weapons effectively have no arc-of-fire problems — they may be pointed at any target, no matter the angle of fire.

If the vertical distance between a ground vehicle and a helicopter is greater than the horizontal distance — 7'' up and only 2'' away, for example — the car could only hit the bottom of the chopper, and then only with a top-mounted weapon or a weapon in a universal turret. The helicopter could only target the car's top, and could only use bottom-

mounted weapons or weapons in a bottom-mounted universal turret.

Bombs

Dropping a bomb is essentially a random attack. If the to-hit roll is not made, the bomb could land just about anywhere. First, imagine a crosshairs over the intended target and roll one die to see which way the bomb went:

- 1 — On-line vertically, but to the left.
- 2 — On-line vertically, but to the right.
- 3 — On-line horizontally, but above the spot.
- 4 — On-line horizontally, but below the spot.
- 5 — To the left or right (roll randomly), and above the spot.
- 6 — To the left or right (roll randomly), and below the spot.

In order to determine how far off target the bomb was, another die roll is required: If the bomb was dropped from a height of 1'' to 10'', roll one die, and that's how many inches the bomb missed by in each direction. (Make separate rolls if it's off in more than one direction). If the bomb was dropped from a height of 10.1'' to 15'', the distance is $1d+3$ inches. From a height of 15.1'' to 20'', the distance is $2d+3$. From a height of 20.1'' or higher, the distance is 4 dice. A bomb cannot miss in any direction by a distance greater than the height from which it was dropped.

Dusting

Another handy thing a helicopter can do during combat is "dust" a ground vehicle. If a helicopter drops to within 1'' of a ground target over any terrain but the most scrupulously clean arena asphalt, the area is "dusted" — the rotors kick up a nasty cloud of dust, gravel, trash, and other materials, with the basic effect of a very large smokescreen. Put a smokescreen counter directly under the helicopter over a ½'' by 1'' area. This cloud stays under the helicopter as long as it's within 1'' of the ground, moving wherever it moves, and is otherwise like a smokescreen in all respects. The "dusting" extends upward ½'' from the ground.

4. Peculiar Equipment

Hang Gliders

Hang gliders are unpowered gliders which can hold one flyer. A pilot must take off from a height and dive in order to achieve the speed necessary to keep the glider moving. The glider pilot runs at full speed for the edge of a 50-foot (about 3½'', game scale) or higher cliff or building side and launches himself into the air. Along the straightaway, gliders fly at an average of 20 mph. They have a handling class of 2. They observe the same diving and climbing rules as helicopters, but stall at 15 mph; a stalled glider must immediately dive again to achieve a safe speed. Gliders depend on updrafts to climb and to stay in the air — it is up to the referee to determine where such updrafts will be (if they're there at all) and how strong they'll be. Hang gliders may perform *Veer and Drift maneuvers*, but not the *Rotate maneuver*. If a chopper flies over a hang glider within 3'' the turbulence thus caused is a D6 hazard.

Grasshoppers

The Grasshopper is an uncommon combination of helicopter and automobile. A Grasshopper consists of a mid-sized or luxury car body which is modified (for \$15,000 extra) to accommodate special helicopter equipment. This equipment consists of a sliding roof panel (no turrets may be mounted on a Grasshopper) from which emerges a folding rotor attachment. The rotor attachment takes one full turn to activate, during which time the roof panel slides back, and the rotors emerge and snap out to their full length. The rotors must spin for three turns, and on the fourth turn the Grasshopper takes off at the rate of acceleration determined by the helicopter motor vs. weight rules above. A Grasshopper has an acceleration of 5 on the ground. Grasshoppers may use only mini- or small-helicopter power plants. The plant takes the normal number of spaces, plus 1 space for the extra rotor equipment. Driver skill is necessary in order to drive a Grasshopper on land; Pilot skill is necessary for use in the air. Once in the air, the Grasshopper behaves exactly like a helicopter; the rotor and the stabilizing rotor (which pops out of the trunk) are each -6 to be hit. The main rotor has 5 DP, the stabilizing rotor has 3 DP. The Grasshopper has a handling class of 2 in the air.

XIV. Scenarios

Many different kinds of *Car Wars* scenarios are possible. Before a game, then, you must decide what sort of scenario you want to play:

(a) What types of vehicles will be used? You may limit players to a given budget for each car, a given size, weight, etc., or there may be no limits at all. You may also want to give each player a large budget (\$40,000 is a good number) and allow as many or as few vehicles as the player chooses to create within that budget.

(b) Will this be a road combat, city fight, or arena battle? Or will it be something even more bizarre, like an off-road duel or a fight in a parking garage? If it's not a road combat, you'll have to get a map — either draw your own, use one of the maps provided, or use one from a published *Car Wars* supplement. You'll also need to determine each vehicle's starting position and starting speed.

(c) Will there be a referee? A referee is never necessary, but the more players there are, the more useful one becomes. A big scenario is faster-moving and more fun with a referee to provide a scenario background, sportscaster commentary, and arbitration.

The referee serves three functions: He is the final judge of the rules, making sure the players are using legal designs and settling any rules disputes that come up; he keeps the movement chart, telling each vehicle when to move, and moves vehicles that are out of control; and he serves as the arena master in arena scenarios, drawing the map, setting the ground rules, and awarding the prizes. Refereeing can be as much fun as playing.

(d) Will there be any road hazards (e.g., will the debris-littered road sections be used) or will weather conditions be bad (e.g., rain)?

(e) Will players get to see each others' record sheets before play, or will they find out exactly what weapons are carried, and where, "the hard way" — as their characters see them used?

Once the ground rules are set, go to it! Here are some ideas:

1. Road Scenarios

To play any of the road scenarios, you'll need the road sections provided in this set. To begin, set up just as many road sections as you need to get started; then, as the action moves off one road section, pick it up and place it in front of the oncoming traffic. A highway could go on forever using this method! You can also overlap the sections to simulate intersections, entrance ramps, tighter curves, or anything else you can come up with.

Road Duel

A two-player road combat — one car each. Each player gets a fixed budget (\$10,000 and \$15,000 are both good) to pick one car from the sample vehicle list (see Section XV) — or, for advanced players, to customize a car. Players roll randomly to see which car starts in front. Roll again (two dice) to determine starting distance: 2 to 12 inches. Both cars start out going the same direction at 60 mph. Winner is the survivor.

Variant: Each time a new road section is placed, roll one die. On a 6, a debris-littered road section is used, adding a little spice to the combat.

Pack Attack

A two-player road combat. One player gets \$25,000 to pick (or customize) a single vehicle. The other player gets \$30,000 and must pick (or customize) at least 5 cycles. The lone vehicle starts out with a 12" lead, with all vehicles doing 80 mph. The cycles win if they destroy the lone vehicle, and win decisively if they kill the driver but leave his vehicle drivable. The lone vehicle wins if (a) the cycles are destroyed, (b) he can increase his lead to 30" and no cycle has acceleration greater than his; or (c) he manages to travel five scale miles (that's 1,760", or 146'8") to town and safety.

Variant: Two cycle players get \$15,000 each for 3 or more cycles each. Only one cycle player can win, but to do so he must cooperate with the other cycle player until the car is destroyed or crippled.

Variant: The lone player gets a bus or tractor/trailer rig worth \$80,000, and the pack player gets \$120,000 worth of cars and cycles.



This is a daring hijack attempt — most gangs don't mess with the big rigs. Same victory conditions apply as in the basic scenario.

2. Arena Combat

Perhaps the most popular form of autoduelling is the highly organized American Autoduel Association duelling circuit. Arena battles pit drivers in as fair a situation as can be devised, so that victory is based on skill, not the unfair advantage of numbers or better equipment.

The AADA System

The American Autoduel Association grades duelling vehicles by their total cost. Hand weapons carried by a vehicle's crew do not count toward this cost, but body armor does. Vehicles costing up to \$5,000 compete in Division 5; those costing from \$5,000 to \$9,999 are in Division 10; \$10,000 to \$14,999 vehicles are in Division 15. The AADA also sponsors competition in Div. 20, Div. 25, Div. 30, and Unlimited Class (for vehicles costing \$30,000 or more).

No matter the division, some rules are always enforced. There will be at least one (and usually several) "safe lines." A safe line is usually across each opening back to the pits, and is occasionally found elsewhere. A vehicle or pedestrian that crosses a safe line is removed from combat — firing at a target across a safe line is a foul that usually results in disqualification. Anyone foul enough to fire on combatants who have crossed the safe line is usually suspended from appearing in AADA events — permanently for repeat offenders.

You do not have to accept an opponent's surrender. As long as he is on the arena floor, you can legally blast him to hamburger. But duellists who do not accept surrenders acquire a reputation among their fellows, and don't live very long.

There are arenas all over North America, and every one is different. Some are simply flat, open spaces; others feature odd buildings and obstacles; still others resemble racetracks more than arenas. Many facilities were converted from existing structures, and that affects what the arena looks like. Arenas have been built on the site of shopping malls, airports, racetracks, and entire abandoned towns. Any of the maps supplied with this game can be treated as a deserted area and used as an arena.

Setting up an arena event is simple. Establish a money limit, and any other limits you wish to impose (e.g., cycles only, no targeting computers, no lasers, only one person per vehicle), make sure each combatant's design follows the ground rules, and turn them loose! The survivor is the winner. Winners of arena events usually get the salvage value of any vehicles they knock out, plus a purse of between 50% and 150% of the total value of the vehicles involved.

Amateur Night

This is the very best way to get started in autoduelling. Amateur Nights are sponsored by TV networks, which give duelling vehicles to the combatants in exchange for their participation. The cars are rarely worth over \$6,000 or \$7,000, but for a character who's broke, it's the only way into the high-glamour world of autoduelling. Each combatant gets an identical vehicle (usually a stock vehicle — the driver can make minor modifications, like changing weapon and armor placement). Vehicles enter the arena simultaneously, from different entrances, at 20 mph. Vehicles may leave any time after 30 seconds have passed, but may not re-enter. The winner is the survivor with the highest prestige (see Section VII, *Continuing Characters*). A driver keeps his car if he gets out with it, plus he gets the salvage value of his kills.

3. At the Truck Stop

Also included in the *Deluxe Car Wars* set is a map of a typical fortified truck stop. It offers a variety of services, from food and power all the way up to major repair. An establishment like this is often the strongest bastion of law and order on the longer stretches of highway. It's the equivalent of a medieval tavern: A safe place to spend the night sharing drinks and stories.

The map can be used as a combat arena without further preparation. However, it's much more fun when you "stock" it with characters, weaponry, loot, and situations. Some basic data to get you started:

Map Key

Building interior wall

Building exterior wall

Outer wall; the white dot is a floodlight.

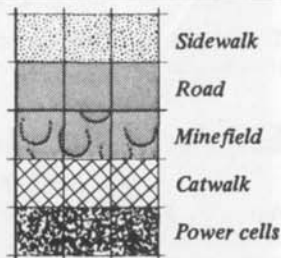

Entryways. The main gate is deliberately hard to enter; vehicles must move slowly. For a test of maneuvering skill, try to bring a rig through the main gate without scraping the walls. The other gate is a "crash gate," designed to be opened only if someone must enter at high speed. In that case, the electric minefield is turned off. The switch is in the security office. Counters are supplied for both gates; they slide out from inside the wall, and are remote-controlled from the gatehouse and the security office (which can override the gatehouse). They open and close at one square per second, and will not close if a vehicle over 2,000 lbs. is blocking them. Lighter vehicles will be crushed.

Walls. The outer walls are two stories high and have a strength of 50 DP, but will never collapse entirely. The gates have strength 20; the buildings and corner turrets have strength 10.

Defenses. The main defenses are the four turrets at the corners, each of which is located just above wall level. All are armed with heavy lasers, and can be operated from the roof behind the turrets, from inside the small turret buildings (overriding the roof controls) or from the security building (overriding everything). They cannot be turned to fire on anything within the walls.



Within the courtyard is an old artillery piece to provide counter-battery fire if anyone attempts to shell the truck stop from a distance. It requires a crew of two. It can fire once every 10 turns; it does 8 dice damage on a direct hit and 3 dice damage in a 3" burst radius. Each shot weighs 30 lbs. and costs \$150. Its range is approximately 12 miles! Its base to-hit number is 13. However, there is no modification for range, up to maximum, and if a "spotter" has the target in view, it can get a sustained fire bonus of +1 per shot, down to a minimum of 6 for a stable target, or 9 for one moving no more than 30 mph. (Even with a spotter, faster targets would be hit only by blind luck.) A counter is supplied for players who want a second artillery piece.

Gatehouse. A small building designed to control the gates and examine anyone wanting entry — though, except in times of trouble, the truck stop is open to everyone except obvious riffraff.

Power building. Contains the giant storage batteries used to

recharge vehicles. There is a huge windmill on its roof, a land line to the local power plant, and a bank of solar cells on top of each building; it's not impossible to cut off the truck stop's power, but it's very hard. To recharge, a vehicle pulls up to within 2" of the side of the building where there is no sidewalk. Two vehicles can be charged at once.

Security building. Contains living quarters for the security chief and his assistant; the wardroom; the security office, which contains a holding cell for unruly customers, and video monitors covering a number of locations; and the armory. Weapons and ammo can be purchased there, and vehicle weapons are often taken there for a repair.

Main building. Two stories tall; includes a bar, restaurant, showers for truckers; motel-type bedrooms (B); rest rooms (RR), offices, etc. On the second story, the floor plan is the same. Over the bedrooms are more bedrooms; over the main offices and radio room are living quarters for the truck stop's owner; over the restaurant and bar is a storage area; over the TV room and lounge are a convenience store and laundry room, respectively. Access to the main building is possible only at the front door or through the garage (under the catwalk). Everyone except an employee will be "asked" to check all firearms at the entrance. The management insists on a high level of peace on the premises, though pistol duels are permitted behind the garage.

Tunnel. An escape tunnel, known only to key employees, begins at the "X" in the radio room and leads off the map to a hidden hatch. It will be used only in dire need; it is normally locked, with a desk on top.

Garage. Also two stories high, but without a second floor inside. Connected to the main building. Includes nine service bays and a well-locked ammo storage room. The cross-hatching shows a catwalk, at the level where the second floor would be, to allow security observation. Mechanic service is available here, at going rates, for any vehicle.

Scenario Ideas

There are a number of uses for a truck stop other than just as a recharge station. A good scenario could be constructed around a full-scale attack on the truck stop, but the attackers would have to be very well-armed to pull it off.

The truck stop is often considered "neutral territory" where normally antagonistic groups can get together and do business. A number of scenarios can be built around this fact. The players could be contacted by a person wanting to sell (or buy) illicit merchandise. When the players meet the contact at the truck stop, they find themselves double-crossed. Is the truck stop management in on the scam? Maybe, maybe not. It depends on how you, as the referee, want to set it up.

For the most part, not many shots will get fired at a truck stop. But it's a great place to pick up information, enlist the aid of third parties, and get the latest equipment.

4. City Fights

Included in the *Deluxe Car Wars* set is a two-piece map of the downtown section of Midville, Ohio. There are two scenarios that go specifically with this map — but you can also use the map as a generic city for any other type of scenario.

Wheels vs. Walkers

Cycle gangs tearing into Midville usually got shot to pieces. If it wasn't the cops doing the shooting, it was the armed civilians' protection group, the Midville Organization for Neighborhood Defensive Ordnance (MONDO). And if it was neither cops or MONDOs, it was the town's die-hard pro autoduellists. Sometimes it was all three.

Once it was none of the three, and that's when the trouble started.

On July 23, Black Jesse's Crusaders ripped through the city and out again before any guns could be brought to bear on them. In passing, they shot down an overhead crosswalk and the six pedestrians on it. The citizens blamed the duellists and cops for the lack of protection.

On July 25, a casual remark by an autoduellist ignited tempers, resulting in the bloody Beer Brawl. Joe's Oil Pump, a tavern that catered to duellists and their fans, was burned to the ground.

On the morning of the 29th, a pitched battle in the Midville Duel Arena parking lot resulted in several deaths and the total destruction of one vehicle. There were now three camps: Wheels vs. Walkers, with police trying to ignore the whole thing and concentrate on "real problems."

The next day was Sunday. The churches stayed mostly empty. Sporting goods stores did pretty good business that morning . . .

The duellists and the MONDOs have spent all night working up their courage, and have congregated for the purpose of destroying each other. The MONDOs start in the parking lot at 3rd and Elm; the duellists behind in the lot behind Bill's Garage. The duellist player gets two to five characters, and \$35,000 with which to build either two or three cars. The MONDO player gets twenty characters and \$15,000. He may buy any hand weapon, mines, spikes, and body armor. Each side wants to wipe out the other. However, both sides are natives of the town; the victory conditions reflect a slight reluctance to destroy their home.

Victory points are awarded to each side, added up, and compared as follows:

For each autoduellist killed: +20 to the MONDOs if there were 5, +25 if there were 4, and so on (always equalling 100 points for the total).

For each MONDO killed: +5 to the duellists.

For each breach opened in a building: -1 to the side that opened it.

For each building destroyed or on fire: -5 to the side that caused the fire or opened the breach that knocked it down.

For each bar-goer on the other side killed: +1.

For each mechanic killed: +3 to the MONDOs.

For each vehicle or combatant that leaves the map: -3 to the fleeing side. (Note that this means a car with two occupants is worth -9!)

For each neutral bar-goer, civil servant, or hospital worker killed: -2 to the killer's side.

For each cop killed: -5 to the killer's side.

If one side has 50 points more than the other: Total Victory. If one side has 25 points more: Decisive Victory. If one side has 10 points more: Pyrrhic Victory. If one side has less than 10 points more: Draw.

If either side has a negative point total, all survivors from that group will be lynched.

Crusaders

When Black Jesse heard about the big fight in town, he thought it was the perfect time for another raid. But he talked a little too much about his plans . . .

For this scenario, all damaged buildings, chains, vehicles, and weapons are fully repaired; all vehicles and weapons are fully supplied with ammunition.

The townspeople have 16'' (240 feet) of heavy chain — the type used at the mall. Chains attach to posts which may be set anywhere. There are no separate post counters; each chain counter shows location of the posts. All chains must be in place before play begins. The Crusaders will be able to see any chain in line of sight.

The town gets the autoduellist and MONDO forces from "Wheels vs. Walkers," plus the three police cruisers. (The Ambunaught performs as before, firing only if the hospital is breached.) City Hall's internal forces are doubled; the police station's internal forces are tripled. These men will not leave their buildings. The six patrolmen begin play in their cruisers. The bars are empty, and the mechanics at Bill's have (for today) become part of the 20 ground fighters.

One player can play each of the four forces (this is simplest), or one player can take the three town forces and the other player can play the Crusaders (this can be pretty slow). The Crusader forces may also be split between two or three different players.

Black Jesse's Crusaders, the meanest gang in the state, get 30 characters for the raid. They have \$100,000 worth of gear: Cycles, hand weapons, body armor, and — if they like — one van. No Crusader may leave the board until he has fired at least one potentially-effective shot (that is, one which has a chance to hit and to do damage when it hits) at a townsman or building.

The townspeople want to trap and obliterate the Crusaders. The Crusaders want to wipe out the town's fighting force and escape, so they can return later to pillage. In this scenario, the Crusaders will receive victory points for the capture of townspeople. To capture a townsman (or woman), a Crusader first must render him or her unconscious. Loading an unconscious person onto a cycle takes one full second.

The townspeople can set wherever they please (in the likely event of

dissension among players, each player sets up his own forces). However, nobody can set up in or on the hospital. The Crusaders ride in from North Kazango at any speed, and will immediately spread out to accomplish their objective of destruction. From there on it's a free-for-all. If the Crusaders stay too long, they're probably going to be wiped out; they want to use their superior mobility to destroy and kill as much as possible and then turn tail.

The victory points:

For each autoduellist killed: +20 to the Crusaders (+25 if there are only four duellists to start with, and so on).

For each MONDO, hospital worker, municipal guard, or non-patrolling police officer killed: +5 to the Crusaders.

For each of the 6 patrolling policemen killed: +10 to the Crusaders.

For each Crusader killed: +10 to the townspeople.

For each breach opened: +1 to the Crusaders (no matter who opened it!).

For each building demolished: 3 times the building's DP to the Crusaders. The referee may choose to award extra points to the cyclists for especially risky or destructive behavior.

For each building on fire but not demolished: +5 to the Crusaders.

For each townspeople captured: +10 to the Crusaders.

Consider the townspeople's scores one combined score for the purpose of victory conditions. If one side has 50 points more than the other, it's a Total Victory. If the margin is 20 points, it's a Marginal Victory. If it's less than 20, it's a Draw. If the townspeople win, compare the individual victory point totals of the three groups (cops, duellists, MONDOs) to see which group came out the best in the eyes of the town.

About the Midville Map

The various terrain features of the Midville map (streets, sidewalks, buildings, parks, trees, lamp posts, crosswalks, debris, interior partitions, and chains) are shown on the City Terrain Chart, below. Following are the terrain effects peculiar to urban autoduelling:

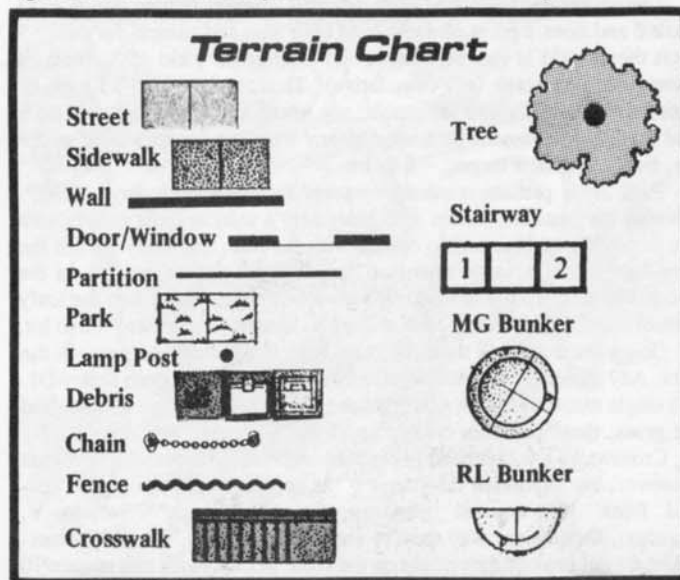

Sidewalks are considered debris-littered road; the debris markers (representing random urban trash, vehicular leftovers, wine bottles, etc.) are shown in place. Also shown are mailboxes and news racks. Hitting one of these does no damage to a vehicle but is a D2 hazard. For game purposes, assume the dented mailbox or news rack remains in place.

Any maneuver involving crossing from road to sidewalk or vice versa is at a +D1; driving half-on and half-off is also +D1.

Chains stretch across the city's mall entrances and may be placed elsewhere. Hitting a chain is a D3 hazard and does 1 point of damage to both chain and car for every 5 mph the car is moving. Seven points of damage in a single crash or 14 points of cumulative damage will shatter the chain. If a vehicle hits the chain and does not break it, the vehicle stops where it is. Chains can only be broken by ramming. Pedestrians can cross the chains without slowing down.

Chain is put up between metal posts. If chain is stretched from Post



A to Post B, and from B to C, and from C to D, and a car rams it between B and C, only the chain between B and C is out of play. It is possible to ram a post; if a car rams Post B, then the chain from A to C is out of play. Ramming a chain post is as hazardous as ramming chain and a lamppost (see below) at the same time, and would require the normal 7 points of instantaneous damage or 14 points cumulative to destroy the chain. A hit doing more than 2 points of damage, but less than 7, would break the post off but leave the chain intact. However, chain lying on the ground (because an end post is gone) has no effect.

Lampposts are located at each sidewalk corner. Hitting one is a D3 hazard and does 1 point of damage to both post and vehicle for every 5 mph the vehicle is moving. However, a post will yield to 3 points of damage in one crash (not cumulative). Thus, a car going 15 mph or more will knock down a lamp post; one going at 5 or 10 mph will hit it and stop. A post may be destroyed by any weapons except a hand weapon, but it is a hard target: -6 to hit.

Park areas present no danger except for trees; they have 20 DP. Though the trees are shown with branches, a vehicle must collide with the trunk (the central dot) to collide with the tree. The leafy part of the tree does not affect movement or line of sight, unless you are on the ground looking up into a building, or vice versa. In that case, the leafy part of a tree will interfere, and should be treated like smoke: -2 to hit.

Going for a drive in the park: Any vehicle can drive on grass in the park. Any maneuver performed partially or entirely on the grass is at +D1. If a single maneuver takes you from the road over the sidewalk and onto the grass, these penalties do add up — the maneuver becomes +D2.

Crosswalks are overhead pedestrian walkways. Crosswalks provide no cover, but anyone in the center 1" is considered to be on the "second floor" for combat purposes (See "Buildings," Section V, *Combat*). Despite the way they're shown on the map, overhead crosswalks do not impede movement on the road. A crosswalk can sustain 10 points of damage before collapsing. Anyone in the center inch of the crosswalk when it collapses will take 1 die of damage; anyone anywhere else on the walk will take 1d-4 points. Anyone under a falling crosswalk takes 1 die of damage. Body armor does not protect from this damage. A fallen crosswalk creates rubble.

Buildings and their effects on combat are described in Section V, *Combat*. The interior partitions of buildings have 3 DP and are automatically breached by grenades. Breaches in interior partitions do not contribute to the possible collapse of a building. For simplicity, assume that partitions are in the same place on each floor.

Each block on the Midville map is marked with a number, as follows:

(1) *The town mall*. Two floors, 5 DP, no internal defenses. Any vehicle up to van-size can drive the length of the interior concourse with no mobility restriction. This is on the first floor only; the second floor is warehouse, accessible only to pedestrians.

(2) *The hospital*. Three floors, 6 DP. Although the staff hates to drum up business for itself, it is also charged to protect those in its care. Three guards with body armor and rifles are on duty at each door, and the Ambunaught, the hospital's armored ambulance, is manned and active at the spot marked "X." (The Ambunaught is described in Section XV, *Sample Vehicles*).

Any breach opened in the hospital will be manned by one of the guards (leaving no less than one guard at each door, as long as the supply lasts). Anyone firing on the hospital (in "Wheels vs. Walkers") or any Crusader within 1" of it (in "Crusaders") will be fired on by the guards. The doors are locked; combatants must create a breach to enter. If a breach is opened in a wall, the Ambunaught will cruise to that point and attempt to guard the wall (by remaining stationary in front of it and blasting anything within range firing at the building). If more than one breach is opened, the Ambunaught will begin to circle the hospital, engaging only those who fire upon the building or its defenders.

The forces of the hospital and police (see below) will cooperate, though the Ambunaught will never leave the hospital area. The hospital doors are wide enough to admit vehicles, though the ceiling is too low for vans. There are six unarmed staffers in the hospital, plus three bedridden patients.

(3) *Office block*. Two stories, 5 DP, no internal defenses.

(4) *Block of stores*. Two stories, 5 DP. The three buildings on the west side of the block have no internal defenses. Bill's Garage is a violently pro-duellist establishment; within are three mechanics (controlled by the autoduellist player) who will not venture forth but who will snipe with unscoped rifles at any enemy (that's MONDOs in the first scenario, Crusaders in the second). The Wrecked Edsel Bar is a pro-duellist place, too, containing 3-18 (roll 3 dice) people getting merrily smashed. In the first scenario, a MONDO firing on the Wrecked Edsel will get the same treatment a duellist would at the Bar None (see Block 8). One in three drinkers has a heavy pistol. In the Crusaders scenario, the bar is closed.

(5) *City park*. The little building at the south is the museum. One story, 4 DP, no internal defense.

(6) *City government*. Three stories, 7 DP (except where noted), no internal defenses (except where noted). The City Hall is special: It has 8 DP and an internal force of 12 guardsmen with body armor and heavy pistols. In addition, the bunkers in front are two rocket launcher turrets, controlled from inside the building, with 20 shots each. They can fire on any spot on Elm Street from First to Third, or from Second Street east of City Hall, or any building within the semi-circular area thus suggested. The turrets have 15 points of armor each. The large domes on top of the Hall are machine-gun bunkers. They have 15 points of armor and 20 shots each. Each is manned by one policeman with body armor and a heavy pistol as sidearm. The MG bunkers cannot quite hit the sidewalk in front of the hall; they can hit Elm directly in front of the hall and East Second to the edge of the map. Their main purpose is to keep unauthorized people off the roofs of City Hall and the police station; they will fire without warning at anyone on either roof. They may fire on pedestrians on other Block 6 roofs — but will warn anyone (except a Crusader) before opening fire.

The police station, on the same block, has 10 DP and has 10 regular staffers with light pistols (who stay inside), two permanent guards with body armor and rifles (who stay inside), six patrolmen with body armor, shotguns, and heavy pistol (who don't stay inside all the time), and three patrol cruisers parked in the little lot (at the "X"'s). The cruisers cannot be unlocked by anyone but a police officer, but can be driven by a non-policeman if the armor is blown off one side to permit entry. (The cruisers are described in Section XV, *Sample Vehicles*.)

In the "Wheels vs. Walkers" scenario, the police cruisers and City Hall guns begin as a neutral force. They act only if City Hall or the police station is endangered. They will attack immediately if either building is breached. In addition, each time any weapon strikes either building and does damage, the referee rolls two dice. If he rolls a number less than or equal to the damage done by that shot, the mayor will order action. (The referee may play the city forces himself or give them to another player.) The patrolmen will immediately leave the police station for the cruisers, and the City Hall weapons will open fire on any armed men or vehicles within range, starting (if possible) with those that did the damage. The officers in the cruisers will circle Block 6. Any armed men or vehicles

they find in any street adjacent to Block 6 will be warned once. If they do not surrender, they will be attacked next turn. If fired on by foes outside this "beat," the cruisers may pursue, but probably will not. If the hospital is attacked, it is also possible that one or more cruisers will be sent to aid the Ambunought.

Note that any player loses points when his characters are killed by the police, but only the Crusaders get points for killing police!

(7-8) *Office blocks.* Three stories, 6 DP, no internal defenses. The building in the NW corner of block 8 is the Bar None, a bar which caters to MONDOs. Within are 3-18 (roll three dice) party-goers anticipating a victory bash. One-third of these people have heavy pistols and will use them upon an autoduellist entering or firing upon the bar. They will only leave the bar if it is likely to collapse. If they leave, they disperse, running at top speed for the edge of the map by whatever route seems safest. They will not return fire while fleeing unless they are cornered.

(9) *A varied block.* Two stories, 5 DP, no internal defenses (with exceptions listed below). There is a neutral bar on the block; it contains 4-24 (roll four dice) hard-drinking bozos. One in four drinkers has a light pistol; the barkeep has a shotgun. These folks want nothing to do with the conflict, feel pretty safe this near to City Hall's defenses and will all run from the bar if it is fired upon by anything heavier than heavy pistol (except the barkeep, who will defend his establishment).

(10-12) *Office and Retail block.* Three-story office and retail store blocks, 5 DP, no internal defenses.

Some other special rules:

Pedestrians may jump from roofs and windows. First-story window: No damage. First-story roof: 1d-4. Second-story window or roof: 1 die. Third-story window or roof: 1d+1. Body armor does not protect from this kind of damage.

Only pedestrians can get to a roof. The roof hatches of most buildings are unlocked; The roof hatches of City Hall and the police station are locked from the inside, and have 7 DP if someone tries to break in.

Rooftop movement is unimpeded by the walls between buildings. Gaps of up to 1/2" can be jumped between buildings — the pedestrian's speed is unaffected. Bigger gaps cannot be jumped.

Vehicles and pedestrians that leave the map are considered to have exited the scenario and may not return. No combat occurs off the map. West of Kazango is a chain-link fence (treat as chain). Beyond the fence is an open field.

5. Off-Road Duelling

Many of the most demanding combat situations take place away from roads and arenas. A beach battle, with cycles and buggies flying over the dunes . . . a cat-and-mouse hunt in a Louisiana swamp . . . a Badlands raid, with pickups swooping down from the hills to intercept a convoy . . . all these, and more, are possible in the world of off-road duelling, a world that is growing more popular all the time.

But converting a regular combat car to off-road use is no easy task. A simple hillside can be murder on a car or cycle designed for the open road or the smooth asphalt of an arena. For the duellist interested in off-road action, the following section will describe some of the problems to be faced, and the equipment available to deal with them.

Off-Road Penalties

Any vehicle can go off-road without modifications — but the handling class of an unmodified vehicle is reduced greatly, as follows:

Motorcycle (with or without sidecar): Subtract 2 from handling class.

Trike: Subtract 1 from HC.

Car (with 4 or 6 wheels): Subtract 3 from HC.

Oversized vehicle: Subtract 2 from HC.

The handling bonus for PR Radials does not apply to off-road travel. However, special off-road tires are available (see below).

In addition, most vehicles are subject to damage when going off-road. Every turn a standard car, van, or over-sized vehicle is off-road and traveling faster than 10 mph, roll two dice. On a 2 or 3, the underbody takes 1 point of damage. On a 4 or 5, one tire (roll randomly to see which one) takes 1 point of damage. If the vehicle is going over 50 mph, roll twice per turn. Once the underbody armor is gone, the internal components do not take further damage.

Exceptions to the above: Vehicles with solid tires (regular or off-road) do not take tire damage. Cycles, trikes (and, of course, vehicles with Off-Road suspensions) are built higher off the ground, and don't take underbody damage.

Off-Road Advantages

The only significant advantage to driving off-road is that the ground is softer than cement. Thus, in a "bail-out" situation or a roll, cars and drivers are more likely to survive.

Jumping Out of Vehicles

Anyone jumping out of a vehicle, or off a cycle, when off-road will take reduced damage. Figure damage as though the driver had been hit by a car going 30 mph slower than the speed at which he actually hit the ground.

Rolling

When a vehicle rolls in an off-road situation, each side that hits the ground takes 1d-2 damage, instead of one die of damage. Tires, likewise, take 1d-2 damage in an off-road roll. Thus, the most damage you can take is 4 points per phase. It is quite possible to roll a vehicle on soft ground and drive it away afterwards — if you can get it upright.

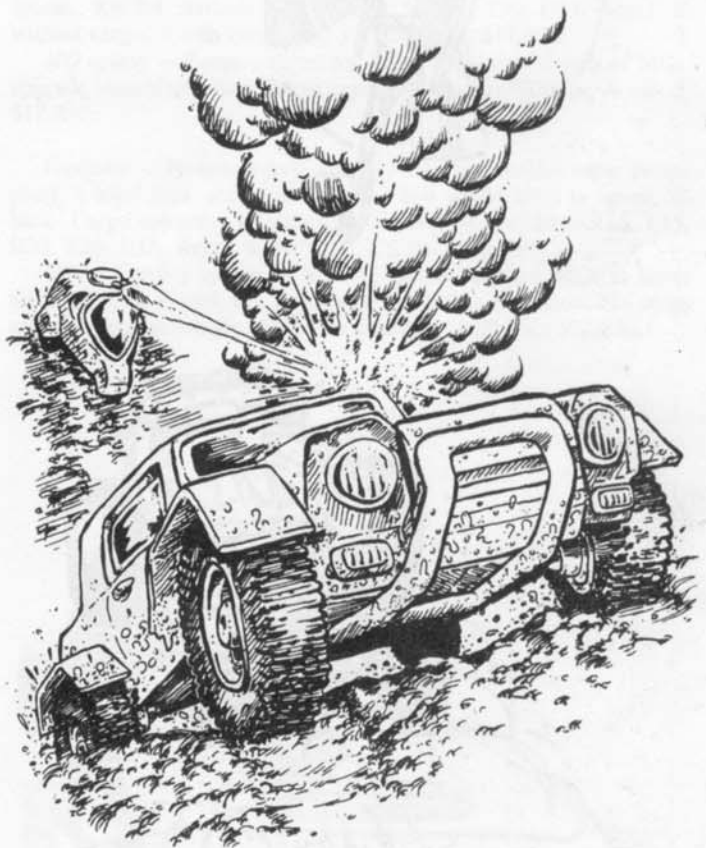

Off-Road Equipment

Although a well-built car can tough it out for a brief trip away from the concrete, the serious off-road combatant will have a specially-equipped "boondock battleship" that can handle any terrain it meets. The following equipment is available:

Off-road solid tires: OR solids improve off-road handling by one; they have no effect on handling class on the road. They cost \$600, weigh 80 lbs. each, and have 12 DP. Off-road solids are not available for oversized vehicles, but they are available for cycles — \$600, 40 lbs. apiece, and 12 DP.

Off-road suspension: The heavily-sprung, high-off-the-ground look is a hallmark of the true off-road vehicle. OR suspension is only available as original equipment; once built, a car's suspension cannot be changed. OR suspension for a cycle or trike costs 300% of the body cost; OR suspension for a car (with four or six wheels) costs 500% of the body cost. Off-road suspension is not available for oversized vehicles.

Off-road suspension gives a vehicle a handling class of 2, either on or off the road. A vehicle with OR suspension does not take automatic underbody damage when off the road.

Brushcutter: A front-mounted blade which may be mounted on regular armor or a ram plate. No spaces, 20 lbs., \$100. It is destroyed if the front armor is destroyed, but must be replaced after every off-road excursion anyway. A brushcutter adds 2 hits of damage done to any pedestrian hit by the front of the car. Allows the vehicle to mow down small trees and other brush (normally a D2 or D3 hazard) with no ill effects. It has no effect on rocks, other vehicles, or other solid objects.

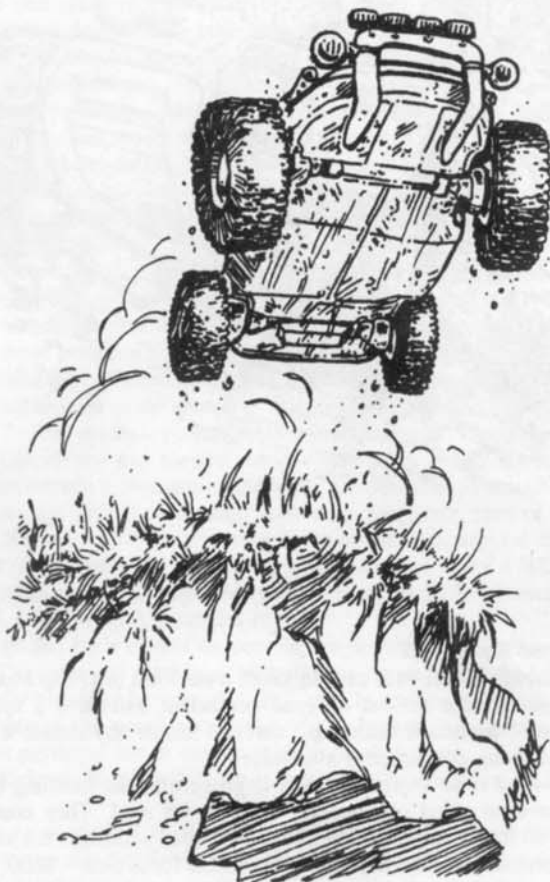
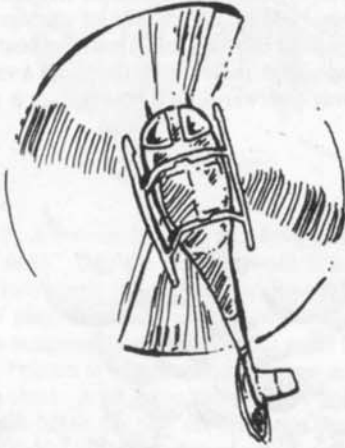

Off-Road Terrain

Off-road should not be construed to mean the dirt on the edge of the road; the shoulder of the road is (usually, at least) no great hazard. "Off-road" means open country . . . whether it's country fields, Arizona desert, or just your local city park. All maneuvers performed off-road are made at an additional D1 difficulty. This applies to all vehicles.

For any off-road scenario, the referee should prepare a map in advance, showing location of hazards and the general "lay of the land" — especially sloped locations that would allow a vehicle to jump. Off-road duellists may encounter almost any terrain. Some possibilities include:

Grass and open fields: This is the basic off-road terrain. No extra penalties apply — just the standard +D1 difficulty for off-road travel.

Trees: Small ones might be D2 or D3 hazards (unless the vehicle has a brushcutter, in which case the trees will simply be knocked out of the way). Larger ones would be fixed barriers — they could have anywhere from 8 DP to 20 DP or more.

Boulders: Small ones (a foot or so across) should be treated as obstacles. Those 1 to 2 feet in diameter are fixed barriers with 25 DP. Boulders are knocked out of the way (rather than destroyed) if they take more than their DP value in a collision. Larger boulders have greater DP values — a 4-foot boulder would be worth at least 50 DP.

Ditches and gullies: Small ditches (less than 2 feet across) are a D3 hazard at 20 mph or less, but only a D1 hazard at greater speeds — vehicles fly right over them. Ditches between 2 and 4 feet across are impassable at less than 20 mph — if a vehicle tries to cross one, it will fall in, and effectively collide with the far wall at full speed. Since the Earth has an "infinite DP," the vehicle will take full collision damage for its speed. At 25-40 mph, such a ditch is a D3 hazard. At 45 mph or greater, it is a D1 hazard — again, you fly right over. Wider ditches should not be jumped without a ramp (see "Flying," below). Very wide gullies, unless they are full of water, can be crossed by driving down one side and up the other.

Water: Vehicles without OR suspension cannot cross standing water deeper than 1½ feet. Vehicles with OR suspension can take on water up to 3 feet deep. Vehicles in deeper water short out and stop working — the effect is the same as if the power plant had been destroyed. The plant takes no actual damage, though — once the vehicle is out of the water (how you get it out is your problem), it will dry out and be usable again in 1-6 hours. Hitting standing water deeper than ½ foot is a D2 hazard. Traveling in water automatically decelerates a vehicle by 5 mph per turn — you must accelerate by that much just to stay at the same speed.

Radical maneuvers are impossible in water — no maneuver with an original, unmodified difficulty over D3 can be performed. There is no additional penalty for those maneuvers which *can* be performed.

Dropped weapons may be used in water, to mixed effect: Oil will not be effective; flaming oil will ignite, but it will also disperse and be ineffective; but spikes and mines will be hidden under the water. Every time a dropped weapon is used in water, roll one die. On a 1 or a 2, water backs up into the system while the port is open, and the weapon takes 1d-3 points of damage.

Tires cannot be targeted in water.

Flying

What's the use of going off-road if you can't get off the ground once in a while? Given the right terrain, you can gun your vehicle to the top of a hill and take off, or even jump right over a surprised foe!

With a good takeoff angle (20 to 40 degrees), a vehicle will fly 15 feet for every 10 mph of takeoff speed over 20 (30 mph yields 15 feet of flight, 40 mph results in a 30-foot flight, etc.). A flatter or steeper angle (15 or 45 degrees) will cut the distance traveled in half. Inclines flatter than 15 degrees, or steeper than 45 degrees, cannot be used to launch a jump.

Landing is a D1 hazard +D1 for every full 30 feet of flight. Thus, a 15-foot jump is a D1 hazard, a 30- or 45-foot jump is a D2 hazard, a 60- or 75-foot jump is a D3 hazard, and so on. Subtract 1 from the hazard if you land on a downward slope (because all your wheels will hit at about the same time). Add 1 to the hazard if you land on an upward slope. On landing from a jump, roll one die for each tire except solids or off-road solids. On a 1, 2, or 3, that tire takes 1 point of damage.

XV. Sample Vehicles

If you're just starting out, use one or more of these pre-designed vehicles. None of these designs are carved in stone, however; there are simple changes that even a novice autoduellist can make:

Rearrange armor. As long as the total number of *points* of armor remains the same, you can change the *distribution* any way you want without changing the cost or weight of the vehicle.

Move weapons. Take those rear-mounted weapons and put them to the front — it won't affect cost or weight at all. Just remember that you cannot devote more than 1/5 of a vehicle's total spaces to weapons firing in one direction.

Add computers. Since computers have no space or weight, you can add one at any time for just \$1,000 (\$4,000 for the +2 hi-res). You can also remove a computer to save money. Weight and space are not affected at all.

Change weapons. Some weapons have identical weight and space requirements, so the only changes you'll need to make are to the cost. For example, you can trade a flamethrower in for a laser — it'll cost you \$7,250. Or you can save that \$7,250 by trading in a laser for a FT. Other trades include replacing two heavy rockets with a minedropper (costs \$600 more), replacing a spikedropper with a smokescreen (\$50 more), replacing a spikedropper with a paint spray (\$350 more), and replacing a smokescreen with a paint spray (\$300 more).

Upgrade. Armor can be upgraded to fireproof by doubling the cost — weight is not affected. And a turret can be upgraded to universal for \$1,000 — again, weight and spaces are not affected.

A note about nomenclature: The descriptions below use quite a few abbreviations. The abbreviations for weapons can all be found in the weapon descriptions. The armor descriptions list the armor position and how many points of armor are at that position — F5 means "five points of armor in the front position," B20 means "twenty points of armor in the back position," etc. Options will only list the changes in a vehicle. If a weight is not listed, that means it did not change from the original. Ditto for cost.

1. Cars

Killer Kart — Subcompact, std. chassis, hvy. suspension, medium power plant, HD tires, driver only, MG front. Armor: F5, R3, L3, B3, T2, U2. Accel. 10, HC 3, 2,300 lbs., \$3,848.

Stinger — Subcompact, hvy. chassis, hvy. suspension, small power plant, HD tires, driver only, two linked MGs front. Armor: F10, R5, L5, B8, T5, U5. Accel. 5, HC 3, 2,400 lbs., \$5,268.

Option I — Replace MGs with one RR, add 10 points of armor. \$4,178.

Option II — Replace one MG and the link with one HR, add 20 points of armor. \$4,138.

Option III — Replace MGs with one RL, add 30 points of armor. \$3,898.

Option IV — Replace one MG with smokescreen or spikedropper, add 25 points armor. \$4,293 with spikedropper, \$4,343 with smoke-screen.

Mini Sherman — Compact, std. chassis, hvy. suspension, large power plant, HD tires, driver only, two linked MGs front, SS rear. Armor: F35, R20, L20, B23, T10, U10. Accel. 10, HC 3, 3,693 lbs., \$8,334.

Option — Remove one MG and link and smokescreen, add one RL and five points of armor. \$7,849.

Joseph Special — Mid-sized, std. chassis, imp. suspension, large power plant, HD tires, driver, AT gun front, RL rear, PS right side. Armor: F30, R15, L15, B25, T15, U15. Accel. 5, HC 2, 4,795 lbs., \$10,340.

Joseph Special "T" — Replace AT, RL, and PS with two linked MGs in turret, plus 4 HRs (two front, two back), add 3 points of armor. \$11,238.

Piranha — Luxury, hvy. chassis, hvy. suspension, large power plant, PR tires, driver and gunner, RL front, 3 MGs with extra magazine each (one each left, right, and back), HR front, fire extinguisher. Armor: F30, R25, L25, B30, T20, U20. Accel. 5, HC 3, 5,995 lbs., \$16,200.

Courier version — Remove one MG and magazine, HR, fire extinguisher, and 50 points of armor, upgrade power plant to super. \$13,650 and has 3 cargo spaces. Acceleration is 10 mph/turn with up to 20 lbs. of cargo, 5 mph/turn with a heavier load.

Hotshot — Luxury, x-hvy. chassis, hvy. suspension, super power plant, PR tires, driver only, two linked MGs front, two linked FTs back, one FT right, one FT left, fire extinguisher. Armor: F20, R10, L10, B20, T10, U10. Accel. 5, HC 3, 6,600 lbs., \$14,600.

Option — Any FTs can be replaced with MGs and 30 points of armor, costing \$1,350 extra per switchout. One rear FT can be replaced with a MD and 30 points of armor for \$850 extra.

Intimidator — Station wagon, std. chassis, imp. suspension, super power plant, PR tires, driver only, laser in turret. Cargo capacity: 11 spaces, 300 lbs. Armor: F25, R15, L15, B25, T30, U15. Accel. 10 without cargo, 5 with cargo, HC 2, 5,200 lbs., \$17,400.

MG option — Remove turret and laser, add 3 linked pairs of MGs, upgrade chassis to x-hvy. Cargo capacity: 7 spaces, 900 lbs. Accel. 5, \$17,850.

Vigilante — Pickup, x-hvy. chassis, hvy. suspension, super power plant, 6 solid tires, driver and gunner, two linked MGs in turret, SS back. Cargo capacity: 11 spaces, 2,075 lbs. Armor: F15, R15, L15, B20, T20, U15. Accel. 5, HC 2, 5,725 lbs., \$16,350.

Urban Cowboy option — Remove gunner, replace MGs in turret with RR, add second RR front, add 175 points of armor. No cargo capacity because weight allowance used up. 7,800 lbs., \$20,850.

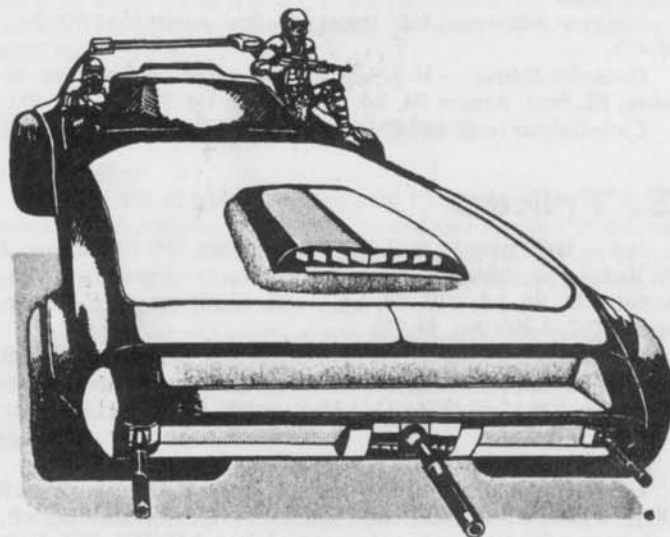

Security Six — Van, x-hvy. chassis, hvy. suspension, super power plant, 6 solid tires, driver and gunner, laser in turret, SS and OJ back, fire extinguisher, hi-res computers for both driver and gunner. Cargo capacity: 14 spaces, 600 lbs. Accel. 5, HC 2, 6,600 lbs., \$32,000.

Security Seven — Remove 20 points of armor, add second gunner position with hi-res computer, two linked RLs front, one HR rear. Cargo capacity: 7 spaces, 130 lbs. 7,070 lbs., \$38,350.

2. Cycles

Shogun 100 — Light cycle, hvy. suspension, small power plant, PR tires, driver only, one MG front. Armor: F6, B6. Accel. 10, HC 2, 798 lbs., \$3,120.

Shogun 150 — Light cycle, hvy. suspension, medium power plant, PR tires, driver only, no weapons, no armor. Accel. 15, HC 2, 600 lbs., \$2,000 (driver can still carry and use hand weapons).

Shogun 200 — Medium cycle, hvy. suspension, super power plant, PR tires, driver only, one MG front. Armor: F10, B10. Accel. 15, HC 2, 1,000 lbs., \$5,020.

Option — Replace MG with RR, downgrade power plant to medium. Accel. 10, 1,100 lbs., \$4,370.

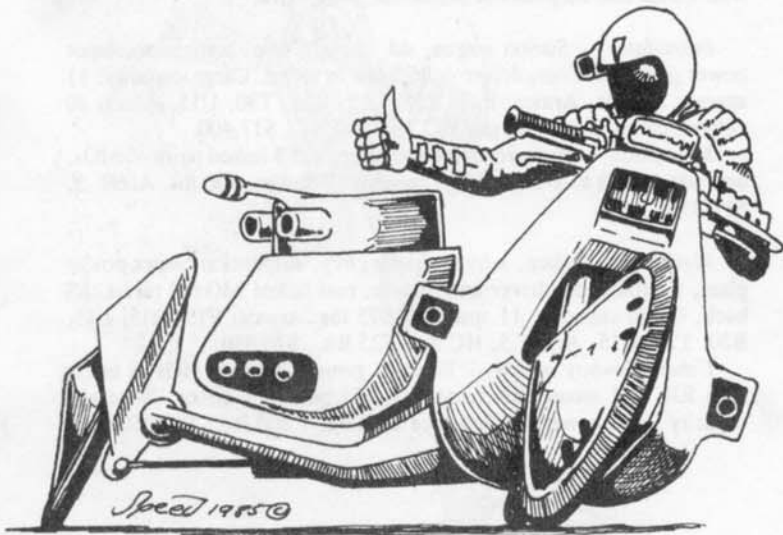

Outlander — Heavy cycle, hvy. suspension, super power plant, std. tires, driver only, one MG front. Armor: F5, B5. Accel. 15, HC 2, 990 lbs., \$4,920.

Option — Add second MG, linked with first. Accel. 10, 1,190 lbs., \$6,470.

Outlander Sidecar — Hvy. sidecar, imp. suspension, std. tire, no riders, RL front. Armor: F4, R4, L4, B4, T0, U4. 735 lbs., \$2,400.

Cycle/Sidecar combination — Accel. 10, HC 3, 1,725 lbs., \$7,320.

3. Trikes

Imp — Light tricycle, med. cycle power plant, imp. suspension, 3 PR Radial tires, driver, RL front. Cargo capacity: 3 spaces, 400 lbs. Armor: F12, R8, L8, B10, T8, U6. Accel. 10 without cargo, 5 otherwise, HC 2, 1,200 lbs., \$4,922.

Off-road Imp — Replace PR Radials and imp. suspension with OR tires and OR suspension, replace RL with RR. No cargo capacity. Armor: F20, R16, L16, B24, T14, U16. Accel. 5, HC 2, 1,600 lbs., \$6,816.

Leo — Medium tricycle, large cycle power plant, OR suspension, 3 OR solid tires, driver, MG front, 2 linked HRs right, 2 linked HRs left, body blades, fire extinguisher. Armor: F18, R12, L12, B25, T15, U15. Accel. 5, HC 2, 2,097 lbs., \$7,964.

Leo Pride — Move MG from front to turret. Armor: F10, R8, L8, B18, T18, U10. \$8,664.

Lumberjack — X-Hvy. tricycle, super trike power plant, OR suspension, 3 OR solid tires, driver, gunner, 2 passengers, turreted RR,

linked MGs R and L, brushcutter, fire extinguisher. Armor: F14, R10, L10, B10, T8, U5. Accel. 5, HC 2, 3,496 lbs., \$14,712.

Lumberjack "Lucky Pierre" — Remove passengers, add 2 computers. Armor: F20, R15, L15, B20, T15, U10. 3,500 lbs., \$17,320.

4. Ten-Wheelers

Great Northern Motors Corp. Viking — Std. 10-wheel long-nose cab, x-hvy. chassis, medium truck power plant, 10 solid tires, driver and gunner, 3 RLs (one each front, right, and left), one cargo space. Cab Armor: F35, R35, L35, B0, T25, U20. 15-foot van carrier, 2 RLs linked in a turret, HOJ back. Cargo capacity: 26 spaces, 4,580 lbs. Carrier Armor: F20, R30, L30, B30, T30, U20. HC 1, 15,220 lbs., \$73,100.

Great Northern Motors Corp. Voyager — 20-foot bus, x-hvy. chassis, small truck power plant, 10 solid truck tires, driver, gunner, 5 passengers, 4 MGs linked in a turret, HFOJ back, Cargo capacity: 10 spaces, 170 lbs. Armor: six 10-point wheelguards, F55, R55, L55, B55, T35, U35. HC 1, 13,230 lbs., \$52,380.

5. Car Trailers

Wood Hauler — 6-foot flatbed car trailer, std. chassis, 2 PR tires, OJ back. Cargo capacity: 6 spaces, 2,790 lbs. Armor: U5. 910 lbs., \$1,275.

Crusader — 10-foot van car trailer, std. chassis, 2 PR tires, MD back, 2 RLs (one left, one right). Cargo capacity: 14 spaces, 2,050 lbs. Armor: F2, R6, L6, B7, U2, T2. 2,650 lbs., \$5,275.

6. Trucks

Magnum Motors Roughrider — Standard cab-over, hvy. chassis, regular truck power plant, 10 solid truck tires, driver and gunner, two linked MGs front, RR in turret, Cargo capacity: 1 space, weight depends on total weight of rig. Armor: F30, R20, L20, B15, T25, U15. 11,000 lbs., \$58,100.

Houston Metal Fabricators Type Two Van — 40-foot van semi-trailer, 8 solid truck tires, standard kingpin, SS, OJ, and MD back. Cargo capacity: 75 spaces, weight depends on total weight of rig. Armor: F20, B20, FR20, BR20, FL20, BL20, FT20, BT20, FU20, BU20. 8,150 lbs., \$27,950.

Self Security Systems Unit Twelve — 40-foot van true trailer, 12 solid truck tires, quick-release kingpin, two OJs back, two MDs back, surplus tank gun back, two pop-up turrets with single lasers (one top front, one top back), 4 MGs (one each front right, back right, front left, back left), two gunners, two hi-res computers (one for each). Weapon links: two MDs; Two OJs; All four together; One MD and one OJ. Cargo capacity: 40 spaces. Armor: six 10-point retractable wheelguards, F60, B60, FR60, BR60, FL60, BL60, FT60, BT60, FU30, BU30. 19,810 lbs., \$97,900.

7. Buses

Model E Busnought — 40-foot bus, x-hvy. chassis, regular truck power plant, 10 solid tires, driver, 2 gunners, 7 passengers, 8 MGs (two linked front, two linked back, one each front right, back right, front left, back left), MD back, AT gun in front turret, heavy laser in back turret, three hi-res computers for crew. Cargo capacity: 9 spaces, 10 lbs. Armor: six 10-point wheelguard, plus 50 points of armor in all 10 positions. 25,190 lbs., \$112,700.

8. Helicopters

Note: The rules for construction of helicopters in Deluxe *Car Wars* are significantly different from the original rules published in *Autoduel*

Champions. The change in the rules makes the designs published in *The AADA Vehicle Guide* obsolete — so those designs have been corrected to abide by the new rules, and appear below:

Robobee — One-man helicopter, mini copter power plant, no pilot, two RRs linked front, fire extinguisher, remote control unit. Armor: T15, 25 in all other locations. Accel. 5, HC 0, 4,970 lbs., \$28,290.

Rocket Robobee — Replace RRs with MFR front and 2 linked bombs under, add 40 points of armor. 4,940 lbs., \$25,880.

MicroMedic — One-man helicopter, mini copter power plant, pilot one passenger inside, two passengers on skid stretchers, winch right, side door right, searchlight under. Armor: F10, R15, L15, B15, U20, T10. Accel. 5, HC 3, 4,980 lbs., \$23,660.

Gnat — One-man stowaway helicopter, mini copter power plant, pilot, MG front, 2 linked HRs front. Armor: F35, R35, L35, B25, U35, T15. Accel. 5, HC 3, 4,990 lbs., \$25,830.

Rocket option — Replace MG and HRs with MFR front and one bomb under. 4,840 lbs., \$24,430.

SuperGnat — Replace MG and HRs with laser front and cyberlink, add LD radio. Fireproof armor: F30, R30, L30, B25, U30, T10. Accel. 5, HC 3, 4,990 lbs., \$50,560.

Husky — Standard helicopter, std. copter power plant, pilot, gunner, passengers (see below), RR in universal turret under, winch right, pontoons w/2 stretchers, infrared, radar, searchlight under. Armor: F20, R25, L25, B20, U30, T10. Passenger configuration I: 2 paramedics, 2 patients in pontoon stretchers, 2 patients prone inside. Passenger configuration II: 8 passengers seated inside, 2 patients on pontoon stretchers. Accel. 10, HC 1, 9,220 lbs., \$76,550.

Husky Watchdog — Add second gunner, RR front, 2 MGs (one each right and left), 2 bombs under, convert armor to fireproof. No passenger capacity except for pontoon stretchers. 9,120 lbs., \$85,500.

Plunge — Standard helicopter, std. copter power plant, pilot, gunner, 2 VMGs linked front, cyberlink from gunner to front VMGs, VMG in universal turret under, 2 pairs linked bombs under, fire extinguisher, infrared, 2 hi-res computers. Armor: F25, R25, L25, B25, U35, T10. Accel. 10, HC 1, 9,330 lbs., \$103,800.

Flaming oil option — Replace 2 bombs with HFOJ. 9,170 lbs., \$105,350.

Suppressor — Standard helicopter, small copter power plant, pilot, gunner, VMG in universal turret under, 2 linked MGs front, 2 GLs (one each front and under), 2 cyberlinks (one connects pilot and front MGs, one connects gunner and VMG), stealth, infrared, sound system, sound enhancement, searchlight front. Armor: F20, L10, R10, B10, U20, T5. Accel. 5, HC 1, 7,960 lbs., \$126,700.

RR option — Replace MGs and VMG with two RRs (one front, one in universal turret under). 7,810 lbs., \$124,650.

Aerohauler — Transport helicopter, 2 std. copter power plants, pilot, gunner, 2 linked MGs in universal turret under. Cargo capacity: 9 spaces, 2,060 lbs. Armor: 20 in all locations. Accel. 5, HC 0, 11,940 lbs., \$129,750.

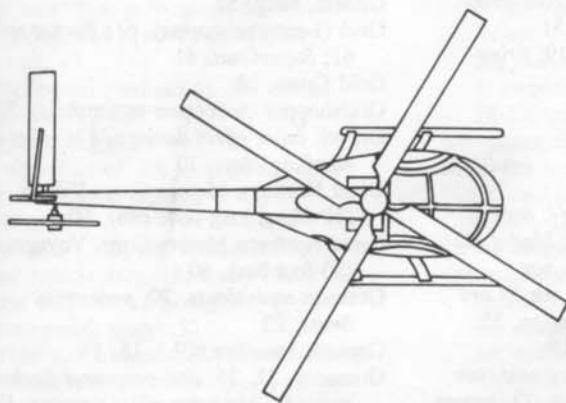

Aerohauler Supreme — Remove MGs, turret, and gunner. Add 2 lasers linked in universal turret under, 2 linked lasers back, 2 laser batteries. Cargo capacity: 7 spaces, 1,210 lbs. 13,790 lbs., \$161,800.

Leviathan — Transport helicopter, super copter power plant, pilot, gunner, 2 linked lasers front, Tank Gun back, 2 VMGs linked in universal turret under, 3 bombs under, 2 hi-res computers, fire extinguisher. Armor: T70, 100 in all other positions. Accel. 5, HC 0, 19,940 lbs., \$170,550.

9. Special Vehicles

Police Cruiser

This vehicle is typical of those used by municipal police forces around North America. This is also the one used for the "Wheels vs. Walkers" and "Crusaders" scenarios in Section XIV. Note: If two prisoners are taken in the cruiser, half the spikedropper ammo is dumped so that the cruiser stays under weight.

Police Cruiser — Luxury, x-hvy. chassis, hvy. suspension, super power plant, 4 solid tires, driver, gunner, 2 linked MGs front, RR in turret, SD back, computer for gunner, room for 2 passengers. Armor: F40, R30, L30, B30, T30, U20. Accel. 5, HC3, 6,325 lbs. (without passengers), \$19,100.

Ambunaught

This is also a fairly typical municipal vehicle. It's not really meant for running combat (it handles like a brick), but it's well armored and armed, and can stand up to trouble. The ambunaught includes 2 stretchers (\$250, 50 lbs., 1 space apiece) and a fair amount of medical equipment (\$2,000, 100 lbs., 2 spaces).

Ambunaught — Van, x-hvy. chassis, lt. suspension, super power plant, 6 PR tires, driver, gunner (who is also a paramedic), RR in turret, MG front, 2 stretchers, medical equipment. Cargo/Passenger capacity: 13 spaces, 450 lbs. Armor: F30, R20, L20, B30, T30, U20. Accel. 5, HC 0, 6,750 lbs., \$16,250.

XVI. Index

- Acceleration, 3, 8; buses, 46-47; cars, 34; car trailers, 41; cycles, see "Cars"; helicopters, 49; ten-wheelers, 38; trikes, see "Cars"; trucks, 46-47
- Accessories, 6, 31-33, 48-49
- Aerohauler (Transport helicopter), 61; Aerohauler Supreme, 61
- Airdams, 32
- Amateur Night, 53
- Ambunaught (Van), 61
- American Autoduel Association (AADA), 2, 53
- Anti-personnel flechette grenade, 31
- Anti-tank gun (AT), 15
- Arc of fire, bus, 46; car, 14; car trailer, 43; cycle, 14; helicopter, 52; ten-wheeler, 38; trike, 36; truck, 46
- Area effect damage, 17-18
- Arena combat, 7, 53; AADA, 2, 53; Amateur Night, 53
- Armor, 3, 4, 31; body, 6, 18, 32; buses, 46; cars, 31; car trailers, 40; critical hits, 18; cycles, 35; damage to, 18; fireproof, 19, 31; helicopters, 48; improved body armor, 32; placement of, 34; rearranging, 6; reflective, 31; reflective fireproof, 31; ten-wheelers, 37, 38; trikes, 35; trucks, 44, 45
- Artful Dodger, see "Flaming Oil Jet"
- Autocannon (AC), 15
- Autoduel Quarterly, 2
- Automatic fire, 14, 19; and dropped weapons, 19; effect of targeting computers, 19; effect on accuracy, 19; hit determination, 19; paint sprays, 20; smokescreens, 20; turreted weapons, 19
- Backwards movement, cars, 10; helicopters, 50; trailers, 42, 47
- Beginning the game, 3, 7
- Bend maneuver, 9; tight bend, 9
- Body armor, 6, 18, 32; improved, 32
- Bomb (B), 15, 16; cluster bomb (CB), 15, 16
- Bomb bay, 49
- Bootlegger reverse maneuver, 9
- Buildings, 21-22, 54-57; breaches, 12, 21-22; collapsing buildings, 21-22; debris, 22; DP value(s), 21; effect on line of fire, 14; burning buildings, 19, 22; missed shots and, 22; multi-story buildings, 22; people in falling buildings, 21; providing cover, 22; ramming, 12; rubble, 22; targeting, 17; vehicles under falling buildings, 21
- Burst effect damage, 17
- Buses, 44-47; acceleration, 46-47; arcs of fire, 46; armor, 46; body types, 46; chassis, 44; combat, 46; collisions, 47; crashes, 47; damage, 46; debris, 47; deceleration, 46-47; handling class, 46; maneuvers, 47; movement, 46-47; obstacles, 47; personnel, 46; power plant, 44-45; sample vehicles, 60; steamrollering, 47; suspension, 44; targeting, 46; tires, 46; turrets, 46; ultraslow movement, 47; weapons, 46
- Cargo, 33, 37
- Cars, acceleration, 34; accessories, 31-33; arcs of fire, 14; armor, 31; backwards movement, 10; blades, 32; body types, 29; chassis, 29; collisions, 10; crashes, 10; crew, 33; damage, 4, 17-18; debris, 10; deceleration, 3, 8; design, 29-33; maneuvers, 3, 8-10; movement, 8-10; power plants, 29-30; sample vehicles, 59-60; suspension, 29; targeting, 14; tires, 30; weapons, 30
- Car trailers, 40-43; acceleration, 41; arcs of fire, 43; armor, 40; backing up, 42; backwards movement, 42; chassis strength, 40; collisions, 43; combat, 43; counters, 41; crashes, 43; damage, 43; deceleration, 41; hitches, 40; jackknifing, 40, 41, 42; loose trailers, 43; maneuvers, 41-42; mounting weapons, 43; movement, 41-43; multiple trailers, 42; sample vehicles, 60; targeting, 43; tires, 40; tongues, 40; trailer types, 40; turrets, 43; weapons, 43
- Characters, see "Continuing Characters"
- Chassis, buses, 44; cars, 29; car trailers, 40
- Chronology, 2
- City scenarios, 7, 54-57; Crusaders, 55; Wheels vs. Walkers, 54-55
- Clones, see "Gold Cross"
- Cluster bombs, 15, 16
- Collisions, 4; buses, 47; cars, 10; car trailers, 43; collision damage, 4, 18; collision speed, 4; cycles, 4; effect on handling class, 10; fixed objects, 12; head-on, 11, 12; helicopters, 51; pedestrians, 13; procedure, 12; rear-end, 11, 12; sideswipe, 11, 12, 13; simplified collision system, 13; T-bone, 11, 12; ten-wheelers, 39; trikes, see "Cars"; trucks, 47
- Collision speed, 4, 11
- Combat, 4, 14-22; general procedure, 14
- Computers, and targeting, 5, 6, 17, 31
- Conforming movement, 12
- Continuing characters, 26-28; becoming an ace, 27; becoming a double ace, 27; organizations, 28; prestige, 27-28; skills, 26-27; staying alive, 28, wealth, 28
- Control table, inside front cover, 5, 9; use of, 3, 8
- Courier, 3; sample record sheet, 3
- Crashes, bus, 47; cars, 10; car trailers, 43; cycles, see "Cars"; helicopters, 51; ten-wheelers, 39; trikes, see "Cars"; trucks, 47
- Crash tables, use of, 9, 10; Crash Table 1 (Skids & Rolls), inside front cover, 11; Crash Table 2 (Fishtails), inside front cover, 11; Crash Table 3 (Car Trailers/Tractor-Trailer rigs), inside front cover, 41; Helicopter Crash Table, 51
- Crew, 3, 33; damage to, 4, 18-19; firing hand weapons, 20-21
- Critical hits, 18
- Crusader (Van car trailer), 60
- Cupolas, 31
- Cyberlink, 31
- Cycles, acceleration, see "Cars"; arcs of fire, see "Cars"; armor, 35; blades, 32; collision damage, 4; crashes, see "Cars"; damage, 4; debris, see "Cars"; deceleration, see "Cars"; design, 35; frame, 35; injury to driver, 18; maneuvers, see "Cars"; movement, see "Cars"; pedestrians boarding, 23; power plants, 35; sample vehicles, 60; sidecars, 35; suspension, 35; targeting, 14, 17; tires, 35; weapons, 35; wheelguards, 32
- Cyclist skill, 26
- Damage, 4, 17-18; buses, 46; burst effect, 17; calculating, 4, 14, 17; cars, 4, 17-18; car trailers, 43; collision damage, 18; critical hits, 18; cycles, 4; effect on handling class, 10, 14; helicopters, 51-52; location, 4, 14, 18; modifiers, 11, 13; recording, 18; repair, 18; table, 11; ten-wheelers, 39; to armor, 4; to people, 4, 18-19; to power plant, 4; to turrets, 4; trikes, 36; trucks, 46
- Damage modifiers, 11, 13
- Damage Points (DP), 3, 18
- Damage table, 11
- Debris, 13; counters, 13; effect on buses, 47; effect on cars, 10; effect on handling class, 10; effect on ten-wheelers, 39; effect on trucks, 47; from explosion, 19; from falling buildings, 22; hitting debris, 13; producing debris, 13
- Deceleration, 3, 8, 9; buses, 46-47; cars, 3, 8; car trailers, 41; cycles, see "Cars"; due to crew injury, 18; due to damage, 4; helicopters, 49; ten-wheelers, 39; trikes, see "Cars"; trucks, 46-47
- Drift maneuver, 3, 9; steep, 9
- Driver, 4; injury to, 4, 18-19; effect on handling class, 10; incapacitated, 4; reflexes, 7; skill, 9, 10, 26; substitute drivers, 18-19
- Driver skill, 9, 10, 26
- Dropped weapons, 19-20
- Evening-out maneuver, 9
- Explosion, 19; variant rules, 19
- Extra magazine, 31
- Fire, 19, as result of crash, 19; as result of damage, 19; effect of, 19; in buildings, 22; modifiers, 19; sequence of rolls, 19; variant rules, 19; vehicular fire table, 19; extinguishing, 19
- Fire extinguisher, 19, 32; improved fire extinguisher, 32
- Firelight Deluxe (Cycle), 6
- Fishtailing, 5, 11; and skid, 5
- Fixed objects, collision with, 12
- Flamethrower (FT), 15, 17; and vehicle fires, 19; heavy duty (HDFT), 15, 17; portable (PF), 25
- Flaming Oil Jet, 15, 16, 19
- Flares, see Starshell launcher
- Frames, 35
- Fog, and targeting, 17
- Getting Started, 7
- Gliders, hang, 52
- Gnat (1-man helicopter), 61; Rocket option, 61; SuperGnat, 61
- Gold Cross, 28
- Grasshopper (helicopter-automobile), 52
- Gravel, burst effect damage, 17; effect on handling class, 10
- Great Northern Motors Corp. Viking (10-wheel long-nose cab), 60
- Great Northern Motors Corp. Voyageur (20-foot bus), 60
- Grenade equivalents, 20; pedestrian limits, 23
- Grenade launcher (GL), 15, 16
- Grenades, 21, 25; anti-personnel flechette grenade, 31; burst-effect damage, 17;

- concussion grenade (CG)*, 25; *deviation from desired target*, 21; *effect on vehicles*, 20; *grenade equivalents*, 20, 23; *hitting solid objects*, 21; *grenade launcher (GL)*, 15, 16, 25; *paint grenade (PG)*, 25; *range*, 20, 21; *smoke grenade (SG)*, 25; *tear gas grenade (TGG)*, 25; *throwing*, 21; *to-hit roll*; 21
 Gunner, 4; *damage to*, 4; *vehicle control*, 4; *skill*, 20, 26
 Gunner skill, 26
 Hand weapons, 20-21, 25; *critical hits and*, 18; *effect on vehicles*, 20; *firing bonuses*, 20-21; *firing penalties*, 20-21; *range*, 20; *skill*, 20, 26
 Handgunner skill, 20, 26
 Handling, *class*, 10; *status*, 8, 9; *effect of damage on*, 14
 Handling class, 10; *factors affecting*, 10
 Hand-to-hand combat, 23; *against vehicles*, 23; *determining to-hit number*, 23; *martial arts skill and*, 23
 Hang gliders, 52
 Hazards, 10
 Heavy lasers (HL), 15
 Heavy pistol, 25
 Helicopters, 48-52; *acceleration*, 49; *accessories*, 48-49; *arcs of fire*, 52; *armor*, 48; *backwards flight*, 50; *body types*, 48; *bomb bay*, 49; *bombs*, 52; *climbing*, 49-50; *collisions*, 51; *combat*, 51-52; *construction*, 48; *crashing*, 51; *damage*, 51-52; *damage location*, 51-52; *deceleration*, 49; *diving*, 49-50; *drifting*, 50; *"dusting"*, 52; *free-fall damage*, 51; *grasshoppers*, 52; *hang gliders*, 52; *hazards*, 51; *maneuvers*, 50; *movement*, 49-51; *personal parachute*, 49; *pontoons*, 49; *power plants*, 48; *rotating*, 50; *rotor checks*, 51; *rotor failure*, 51; *sample vehicles*, 60-61; *skids*, 49; *skid stretchers*, 49; *targeting*, 51; *turrets*, 48; *vehicular parachute*, 49; *veering*, 50; *weapons*, 48; *winch*, 48-49
 Highway scenarios, 7
 Hi-res Targeting computer, 6, 31
 Hitches, 40
 Hits, *determination*, 4, 14; *critical*, 18
 Hotshot (Luxury), 7, 59
 Houston Metal Fabricators Type Two Van (Van semi-trailer), 11, 60
 Husky (Std. Helicopter), 61; *Husky Wachdog*, 61
 Ice, *effect on handling class*, 10
 Imp (Light tricycle), 60; *off-road Imp*, 60
 Infrared targeting mode, 32
 Intimidator (Station Wagon), 59
 Jackknifing, *car trailers*, 40, 41, 42; *trucks*, 47
 Joseph Special (mid-sized), 59; *Joseph Special "T"*, 59
 Jump-Start rules, 3-6
 Kill, *definition of*, 26; *prestige for*, 27
 Killer Kart (subcompact), 6, 11, 59
 Kingpin, 45
 Lasers (L), 5, 15; *and smokescreens*, 4, 20; *and vehicle fires*, 19; *heavy (HL)*, 15; *light (LL)*, 15; *targeting scope*, 32
 Laser targeting scope, 32
 Leo (Medium tricycle), 60; *Leo Pride*, 60
 Leviathan (Transport helicopter), 61
 Light anti-tank weapon (LAW), 25; *very light anti-tank weapon (VLAW)*, 25
 Light lasers (LL), 15
 Light pistol (LP), 25
 Limpet mines (LM), 25
 Line of fire, 4, 14; *effect of smokescreens on*, 4
 Linked weapons, 4, 20, 31
 Lumberjack (X-Hvy tricycle), 60; *Lumberjack "Lucky Pierre"*, 60
 Machine-Guns (MG), 5, 15; *clips for*, 25; *effect on vehicles*, 20; *tripod machine-gun (TMG)*, 25; *vulcan (VMG)*, 15
 Magnum Motors Roughrider (Standard cab-over truck), 60
 Maneuvering, *buses*, 47; *cars*, 3, 8-10; *car trailers*, 41-42; *cycles*, see "Cars"; *helicopters*, 50; *ten-wheelers*, see "Cars"; *trikes*, see "Cars"; *trucks*, 47
 Maneuver types, 3, 8; *bend*, 9; *bootlegger reverse*, 9; *drift*, 9; *evening-out*, 9; *hard swerve*, 9; *pivot*, 9; *rotate*, 50; *steep drift*, 9; *swerve*, 9; *tight bend*, 9; *turning key use*, 10
 Martial arts skill, 23, 26
 Mechanic skill, 18, 27
 Mechanical Memory Storage Device (MMSD), 28
 MicroMedic (1-man helicopter), 61
 Micro missile launcher (MML), 15
 Midville, Ohio, 7, 54-57
 Minedropper (MD), 15; *damage to tires*, 15, 16; *Spear 1000 (SMD)*, 15, 16, 20
 Mines, *effect of*, 20; *limpet mines (LM)*, 25; *placement of counters*, 20; *remote control*, 20
 Mini-bus, 37, 38-39; *acceleration*, 38; *arcs of fire*, 38; *armor*, 38; *collisions*, 39; *combat*, 38; *crashes*, 39; *damage*, 39; *debris*, 39; *deceleration*, 39; *hazards*, 39; *maneuvers*, see "Cars"; *mounting turrets*, 38; *movement*, 38; *obstacles*, 39; *personnel*, 38; *power plants*, 37; *sample vehicles*, 60; *steamrolling*, 39; *suspension*, 37; *targeting*, 38; *tire blowouts*, 39; *tires*, 37; *turrets*, 38; *weapons*, 38; *weight, effect on movement*, 38
 Mini-Sherman (compact), 6, 59
 Missiles, 15; *micro missile launcher (MML)*, 15; *radar-guided (RGM)*, 15; *targeting*, 17; *wire-guided (WGM)*, 15
 MMSD (Mechanical Memory Storage Device), 28
 Model E Busnought (Bus), 60
 Motorcycles, see *Cycles*
 Movement, 3, 8-13; *buses*, 46-47; *cars*, 8-10; *car trailers*, 41-43; *chart, back cover; conforming*, 12; *cycles*, see "Cars"; *helicopters*, 49-51; *pedestrians*, 23; *phases*, 3; *reverse*, 10; *straight-line*, 8; *targeting modifiers*, 17; *ten-wheelers*, 38-39; *trikes*, see "Cars"; *trucks*, 46-47
 Movement chart, *back cover; use of*, 8
 Multi-fire rocket pod (MFR), 15, 16
 Night, *and targeting*, 17
 Obstacles, 13; *hitting obstacles*, 13; *producing obstacles*, 13
 Off-road duelling, 57-58; *advantages*, 57; *boulders*, 58; *brushcutter*, 58; *ditches*, 58; *equipment*, 57-58; *flying*, 58; *grass*, 58; *gullies*, 58; *jumping out of vehicles*, 57; *open fields*, 58; *penalties*, 57; *rolling*, 57; *solid tires*, 57; *suspension*, 58; *ter-*

- rain*, 58; *trees*, 58; *water*, 58
 Oil, *effect of oil slicks*, 20; *effect on handling class*, 10, 20; *effect on pedestrians*, 23; *flaming oil*, 19, 20, 23
 Oil gun (OG), 15, 16
 Oil jet (OJ), 15, 19; *flaming (FOJ)*, 15, 16, 19; *heavy duty (HDOJ)*, 15, 16, 19; *heavy duty flaming (HDFOJ)*, 15, 16, 19
 Options, 3, 59
 Outlander (Heavy Cycle), 60; *Outlander sidecar (heavy sidecar)*, 60
 Paint, *and line of fire*, 20; *and targeting*, 17, 20; *counter placement*, 20; *duration*, 20; *effect on vehicles*, 20
 Paint spray (PS), 15; *heavy duty (HDPS)*, 16; *on automatic*, 20; *placement of counters*, 20; see also "Paint"
 Parachutes, *personal*, 49; *vehicular*, 49
 Paramedic skill, 26
 Passengers, 33
 Pedestrians, 13, 23-25; *area effect damage and*, 17-18; *boarding vehicles*, 23-24; *burst effect damage and*, 17; *climbing stairs*, 23; *combat*, 23; *continuing characters*, 26-28; *counters*, 23; *damage points*, 23; *dropping onto vehicles*, 24; *firing hand weapons*, 20, 23; *flaming oil and*, 23; *hand-to-hand combat*, 23; *in collisions*, 13; *and cover*, 22; *jumping from one vehicle to another*, 24; *mines and*, 23; *movement*, 13, 23, 24; *oil and*, 23; *speed of*, 13, 23; *spikes and*, 23; *sprinting*, 23; *targeting modifiers*, 17
 Personal items, 32
 Phases, 3
 Pilot skill, 26
 Piranha (Luxury), 11, 59; *courier version*, 59
 Pistol, *heavy*, 25; *light*, 25
 Pivot maneuver, 3, 9
 Plants, *power*, see "Power Plants"
 Plunge (Std. Helicopter), 61; *Flaming Oil option*, 61
 Police Cruiser (Luxury), 61
 Pontoons, *helicopter*, 49
 Pop-up turrets and cupolas, 31
 Portable flamethrower (PF), 25
 Portable shop, 27, 32
 Power factors, 29, 34
 Power plants, 29-30; *and acceleration*, 34; *and lasers*, 15, 30; *buses*, 44-45; *cars*, 29-30; *cycles*, 35; *damage to*, 4, 30; *duplicate*, 30; *helicopters*, 48; *power factors*, 29, 34; *range and*, 30; *recharging*, 30; *ten-wheelers*, 37; *trikes*, 35; *trucks*, 44; *units*, 30
 Power units, 30
 Prestige, 27-28, *advantages of*, 28; *death and*, 28; *kills and*, 27
 Radar, 33
 Radar-guided missile (RGM), 15
 Rain, *effect on handling class*, 10; *and targeting*, 17
 Ramming, 11; *buildings*, 12; see also "Collisions"
 Ram plate, 32
 Ramps, 45
 Range, *long*, 5, 17; *penalties for missiles*, 15; *point-blank*, 5, 17; *targeting modifiers*, 17; *vehicle*, 30
 Recharging, 30
 Recoiless rifle (RR), 15, 25; *clips for*, 25;

- tripod recoilless rifle (TRR), 25
- Record sheets, 3; *blank*, 6; *speed track*, 3; *use of*, 7; *vehicle*, 3, 7
- "Reefer" trailer, 45; *car trailer*, 40
- Referee, 53
- Reflexes, 7, 8; *effect on handling class*, 10
- Refrigerated trailer, 45; *car trailer*, 40
- Remote control, 33
- Repairs, 18, 27, 34; *difficulty of*, 27; *installation*, 27; *jury-rigging*, 27; *mechanic skill and*, 18; *repair chart*, 27; *salvage*, 27
- Reversed trike, 36
- Rifle, 25
- Rigs, 41; see also "Trucks"
- Road conditions, 10
- Road sections, 3, 7
- Road scenarios, 53; *Road Duel*, 5, 53; *Pack Attack*, 5, 53
- Robobee (1-man helicopter), 61; *Rocket Robobee*, 61
- Rocket, heavy (HR), 5, 15, 16; *launcher (RL)*, 5, 15; *light (LR)*, 15, 16; *medium (MR)*, 15, 16; *mini (MNR)*, 15, 16; *multi-fire rocket pod (MFR)*, 15, 16; *platform*, 31
- Rocket launcher (RL), 5, 15
- Rocket platform, 31
- Rocket Special (Mid-size), 6
- Rolling, 11; *off-road*, 57
- Rotate maneuvers, 50
- Rubble, *and line of sight*, 22; *from falling buildings*, 22; *pedestrians in rubble*, 22
- Running skill, 13, 23, 26
- RVs, see "Buses"
- Salvage, 27, 34
- Sample vehicles, 59-61; *buses*, 60; *cars*, 59-60; *cycles*, 60; *helicopters*, 60-61; *special vehicles*, 61; *ten-wheelers*, 60; *trailers*, 60; *trikes*, 60; *trucks*, 60
- Scale, 3, 8
- Scenarios, 5, 7, 53-58; *Amateur Night*, 53; *arena combat*, 7, 53; *city fights*, 7; *Crusaders*, 55; *designing*, 5, 53; *for Jump-Start rules*, 5; *Pack Attack*, 5, 53; *parking lot*, 7; *Road Duel*, 5; *truck stop combat*, 7, 54; *Wheels vs. Walkers*, 54-55
- Searchlights, *targeting*, 17, 33
- Security Six (Van), 60
- Security Seven (Van), 60
- Self Security Systems Unit Twelve (Van trailer), 60
- Shogun 100 (Light Cycle), 6, 11, 60
- Shogun 150 (Light Cycle), 60
- Shogun 200 (Medium Cycle), 60
- Shogun 220 (Cycle), 6
- Shop, *portable*, 27, 32
- Shotgun, 25
- Sidecars, *armor*, 14; *targeting*, 14
- Side door, 33
- Sideswipes, 11, 12, 13
- Six Shooter, see *Multi-fire rocket pod*
- Skids, 5, 11; *and fishailing*, 5
- Skids, *helicopter*, 49; *skid stretchers*, 49
- Skills, 10, 26-27; *cyclist*, 26; *driver*, 10, 26; *gunner*, 26; *handgunner*, 26; *improvement*, 26; *martial arts*, 26; *mechanic*, 27; *paramedic*, 26; *pilot*, 26; *running*, 26; *skill points*, 26, 27; *trucker*, 26
- Smoke, *and targeting*, 5, 17; *counters*, 4, 20
- Smokescreens (SS), 4, 5; *counter placement*, 20; *heavy duty (HDSS)*, 16; *lasers and*, 4; *tear gas*, 20; *on automatic*, 20
- Snow, *effect on handling class*, 10
- Sound enhancement, 32
- Sound system, 32
- Spear 1000 minedropper (SMD), 16, 20
- Special vehicles, 61
- Speed, 3, 7, 29; *power plants and*, 29-30; *temporary*, 12; *temporary speed table*, 13
- Spikedropper (SD), 15
- Spikes, *effect of*, 20; *placement of counters*, 20; *spikedropper*, 15
- Spoilers, 32
- Sprinting, 23; *firing weapons while sprinting*, 23
- Stairways, 23
- Starshell launcher (SL), 15, 16
- Stealth mode, 32
- Steamrolling, 39, 47
- Stinger (subcompact), 59
- Stock car list, 6; *use of*, 7
- Submachine gun (SMG), 25
- Suppressor (Std. helicopter), 61
- Suspension, 29; *buses*, 44; *cars*, 29; *cycles*, 35; *ten-wheelers*, 37; *trikes*, 35; *trucks*, 44
- Swerve maneuver, 3, 9; *hard swerve*, 9
- Tank gun (TG), 15
- Targeting, 4; *buses*, 46; *cars*, 14; *car trailers*, 43; *cycles*, 14; *helicopters*, 51; *infrared targeting mode*, 32; *modifiers table*, 17; *modifiers to to-hit roll*, 5, 17, 22; *ten-wheelers*, 38; *trikes*, 36; *trucks*, 46
- Targeting computers, 6, 31; *and hand weapons*, 20; *hi-res*, 31
- Targeting modifiers, 17; *height*, 22; *miscellaneous modifiers*, 17; *movement*, 17; *range*, 17; *specific targets*, 17; *vehicles*, 17; *visibility*, 17
- Tear gas, *grenade*, 24; *loaded in smokescreen*, 20
- Temporary speed, 12; *table*, 13
- Ten-wheeled trucks, 37-39; *acceleration*, 38; *arcs of fire*, 38; *cab armor*, 37; *cab extras*, 37; *cab types*, 37; *cab weapons*, 37; *carriers (cargo areas)*, 37-38; *carrier armor*, 38; *carrier types*, 37-38; *carrier weapons*, 38; *collisions*, 39; *combat*, 38; *crashes*, 39; *damage*, 39; *debris*, 39; *deceleration*, 39; *hazards*, 39; *maneuvers*, see "Cars"; *mounting turrets*, 38; *movement*, 38-39; *obstacles*, 39; *power plants*, 37; *sample vehicles*, 60; *steamrolling*, 39; *suspension*, 37; *targeting*, 38; *tire blowouts*, 39; *tires*, 37; *Trucker skill and*, 38; *turrets*, 46; *weapons*, 37, 38; *weight, effect on movement*, 38
- Ten-wheelers, 37-39; see "Ten-wheeled truck" or "Mini-bus"
- Tire chains, 32
- Tires, 30; *buses*, 46; *cars*, 30; *car trailers*, 40; *cycles*, 35; *effect of spikes on*, 20; *effect on handling class*, 10; *loss of*, 10; *spares*, 30; *targeting*, 14, 17; *ten-wheelers*, 37, 39; *trikes*, 35; *trucks*, 45
- Tight bend maneuver, 9
- To-hit rolls, 4; *modifications*, 5
- Tongue, 40
- Tool kit, 32
- Top speed, 3
- Tractors, 44-45; *armor*, 44, 45; *body types*, 44; *chassis*, 44; *fifth wheel*, 44; *load*, 44; *personnel*, 45; *power plants*, 44-45; *suspension*, 44; *tires*, 45; *weapons*, 45
- Trailers, 45-46; *armor*, 45; *car*, see "Car Trailers"; *kingpin*, 45; *personnel*, 6; *ramps*, 45; *sample vehicles*, 60; *tires*, 45; *trailer types*, 45; *weapons*, 46
- Tricycles, see "Trikes"
- Trikes, 35-36; *acceleration*, see "Cars"; *arcs of fire*, 36; *armor*, 35; *body styles*, 35; *collisions*, see "Cars"; *combat*, 36; *control rolls*, 36; *construction*, 35; *crashes*, see "Cars"; *damage*, 36; *debris*, see "Cars"; *deceleration*, see "Cars"; *hazards*, 36; *maneuvers*, see "Cars"; *movement*, see "Cars"; *power plants*, 35; *reversed trikes*, 36; *sample vehicles*, 60; *suspension*, 35; *targeting*, 36; *tires*, 35; *turrets*, 36; *weapon location*, 36; *weapons*, 35; *wheelguards, use of*, 36
- Tripod machine gun (TMG), 25
- Tripod recoilless rifle (TRR), 25
- Truck stop scenarios, 7, 54
- Trucker skill, 26, 46
- Trucks, 44-47; *acceleration*, 46-47; *arcs of fire*, 46; *armor*, 44, 45; *backwards movement*, 47; *collisions*, 47; *crashes*, 47; *combat*, 46; *damage*, 46; *debris*, 47; *deceleration*, 46-47; *handling class*, 46; *loose trailers*, 47; *maneuvers*, 47; *movement*, 46-47; *obstacles*, 47; *personnel*, 45, 46; *power plants*, 44; *sample vehicles*, 60; *steamrolling*, 47; *suspension*, 44; *targeting*, 46; *ten-wheeled*, 37-39; *tires*, 45; *tractors*, 44-45; *trailers*, 45-46; *turrets*, 46; *ultraslow movement*, 47; *weapons*, 45, 46
- Turning key, 10; *use of*, 10
- Turrets, 4, 31; *arc of fire*, 14; *buses*, 46; *car trailers*, 43; *damage to*, 4; *firing into buildings*, 22; *helicopters*, 48; *pop-up*, 31; *targeting*, 14; *ten-wheelers*, 38; *trikes*, 36; *trucks*, 46; *universal*, 31
- Uncontrolled vehicles; 18; *loose trailers*, 43, 47
- Universal turrets and cupolas, 31
- Veer maneuver, 50
- Vehicles, *budget for design*, 5, 6; *burst effect damage and*, 17; *design*, 7; *modifying*, 34; *options*, 3; *record sheet*, 3, 6, 7; *sample*, 59-61; *selection*, 3, 7; *sides*, 14; *specifications*, 3, 7; *targeting modifiers*, 5, 17; *uncontrolled*, 18; *weapons*, 15, 30
- Vehicular fire table, 19
- Vigilante (Pickup), 59
- Wealth, 28
- Weapons, 3; *accuracy*, 4, 17; *arc of fire*, 14; *buses*, 46; *cars*, 30; *car trailers*, 43; *chart (Jump-Start rules)*, 5; *chart use (Jump-Start rules)*, 4; *critical hits*, 18; *cycles*, 35; *dropped*, 19-20; *hand*, 24; *helicopters*, 48; *linked*, 4, 20, 31; *list (Deluxe rules)*, 15; *placement of*, 34; *rate of fire*, 14; *ten-wheelers*, 37, 38; *trikes*, 35, 36; *trucks*, 45, 46; *turreted*, 4, 30, 31
- Weapons list 4, 5, 15, 25; *notes*, 15-16, 25
- Wheelguards, 32; *cycle*, 32; *retractable*, 32
- Wheels, *loss of*, 10
- Winch, *helicopter*, 48-49
- Wire-guided missile (WGM), 15
- Wood Hauler (Flatbed car trailer), 60

Targeting Modifiers

Range

Point Blank (less than 1'' away): +4
 Long Range: -1 for every full 4''; that is, 4'' to 7.99'' is -1, 8'' to 11.99'' is -2, 12'' to 15.99'' is -3, etc.

Movement

Target is not moving: +1
 Firer is not moving: +1
 Firing pedestrian is braced against solid object: +1
 Target is moving between 30 and 37.5 mph: -1
 Target is moving between 40 and 47.5 mph: -2
 Target is moving between 50 and 57.5 mph: -3
 Target is moving between 60 and 67.5 mph: -4
 Target is moving between 70 and 77.5 mph: -5
 Target is moving 80 mph or faster: -6

Vehicle Targets

Compact or Subcompact: -1
 Front or Rear of a Motorcycle or Car: -1
 Motorcycle: -2
 Sidecar: -2
 Light Trike: -3 from front/back, -2 from side
 Medium Trike: -2 from front/back, -1 from side
 Heavy Trike: -1 from front/back, -1 from side
 X-Heavy Trike: -1 from front/back, no penalty from side
 Front of a Ten-Wheeler Carrier: -2
 Side of a Ten-Wheeler Cab: +1
 Side of a Ten-Wheeler Carrier: +1
 Side of a Mini-Bus: +1
 Side of a Tractor: +1
 Side of a Trailer or Bus: +2
 One-Man Helicopter: -1 from front/back, +1 everywhere else
 Small Helicopter: -1 from front/back, +1 everywhere else
 Standard Helicopter: +2 from top, bottom, or side
 Transport Helicopter: +2 from top, bottom, or side

Specific Target

Pedestrian: -3
 Vehicle tire: -3
 Turret: -2
 Motorcycle Rider (from side only): -3
 Tractor's Fifth Wheel: -6
 Legs of a Semi-Trailer: -5
 Lamppost: -6
 Building: +10
 Helicopter Skid: -8
 Helicopter Winch Cable: -8
 Helicopter Pontoon: -3
 Helicopter Rotor: -6
 Searchlight: -3
 Tongue on Unattached Car Trailer: -5
 Tongue on Attached Car Trailer: -7
 Unattached Hitch to Pull Car Trailer: -5
 Attached Hitch to Pull Car Trailer: -7
 Ejection Seat During Launch: -6
 Ejection Seat Landing via Parachute: -2

Visibility

Firing through smoke or paint: -2 per counter
 Night: -3
 Firer Blinded by Searchlight: -10

Miscellaneous

Targeting Computer Used: +1
 Hi-Res Computer Used: +2
 Cyberlink Used: +3
 Gunner Skill: apply whatever plus the skill is at for that player
 Handgunner Skill: same as Gunner skill, but for hand weapons
 Laser Scope: +1 when mounted on a hand weapon
 Firing While on Oil, Gravel, or Bad Road: -1
 Sustained Fire: second consecutive shot in as many turns at same target with same weapon: +1; third and subsequent shots: +2
 Attacker Not in Arc of Fire of Target Side: -2

All modifiers are cumulative. For example, firing at the wheel (-3) of a motorcycle (-2) from the front (-1) in the rain (-2) from 10'' away (-2) would be at a -10; firing at the side of a trailer (+2) at point-blank range (+4) using a hi-res computer (+2) would be at a +8.

Handling Modifiers

Hazards

Colliding with (or sideswiping) any vehicle: D4.
 Hitting curb, obstacle, or pedestrian: D3.
 Hitting loose debris: D1.
 Enemy fire does 1-5 hits of damage: D1.
 Enemy fire does 6-9 hits of damage: D2.
 Enemy fire does 10+ hits of damage: D3.
 Driver injured or killed: D2.

Each enemy attack produces a separate hazard. If a vehicle is struck by three weapons in one turn, each attack would move the handling-status marker down and require a separate die roll on the Control Table. Mines are "enemy fire." Spikes, debris, obstacles, etc., are not.

Road Conditions

Light rain: adds D1 to any hazard or maneuver.
 Heavy rain: adds D2.
 Gravel on road: adds D1.
 Oil on road: adds D2.
 Light snow: adds D2.
 Heavy snow: adds D3.
 Ice or packed snow: adds D4.

Weapon List

Weapon	To Hit	Dam.	DP	Spc.	Shots	L. cst.	L. wt.
Machine Gun	7	1	3	1	20	1500	200
Vulcan MG	6	2	3	2	20	2700	450
Autocannon	6	3	4	3	10	7250	600
Flamethrower	6	1	2	2	10	750	500
HD Flamethrower	6	2	3	3	10	1750	750
Rocket Launcher	8	2	2	2	10	1350	250
Micro Missile Launcher	8	1	2	1	10	950	125
Radar-guided Missile	7	3	1	2	2	7000	400
Wire-guided Missile	6	3	2	2	2	3300	230
Recoilless Rifle	7	2	4	2	10	1850	350
Anti-tank Gun	8	3	5	3	10	2500	700
Light Laser	6	1	2	1	—	3000	200
Laser	6	3	2	2	—	800	500
Heavy Laser	6	4	2	3	—	12000	1000
Tank Gun	7	6	10	10	10	11000	1400
Minedropper	—	—	2	2	10	1000	200
Spear 1000 MD	—	—	2	2	5	1250	200
Spikedropper	—	—	4	1	10	300	75
Smokescreen	—	—	4	1	10	350	75
HD Smokescreen	—	—	4	2	10	900	250
Paint Spray	—	—	2	1	25	650	75
HD Paint Spray	—	—	3	2	10	1200	130
Oil Jet	—	—	3	2	25	500	75
Heavy Duty Oil Jet	—	—	4	3	10	900	130
Oil Gun	5	—	3	3	10	1250	300
Flaming Oil Jet	—	1d-2	3	2	25	1175	80
HD Flaming Oil Jet	—	1d-2	4	3	10	1950	140
Grenade Launcher	7	—	2	2	10	—	—
Starshell Launcher	—	—	2	1	5	750	125
Heavy Rocket	9	3	2	1	1	200	100
Medium Rocket	9	2	2	1	1	140	50
Light Rocket	9	1	1	.5	1	75	25
Mini Rocket	9	1d-1	1	.33	1	50	20
Six Shooter	9	1	3	2	1	450	150
Bomb	9	4	2	1	1	100	100
Cluster Bomb	9	2	2	1	1	200	150

Hand Weapon List

Weapon	Gren.-equ.	Dam.	To Hit	Shots	L. cst.
Submachine Gun	2	1 die	6	10	370
Rifle	2	3 hits	7	20	140
Shotgun	2	2 hits	6	10	130
Heavy Pistol	1	2 hits	7	8	108
Light Pistol	1	1 hit	8	8	83
Grenade	1	1 die	9	1	25
Tear Gas Gren.	1	—	9	1	30
Smoke Grenade	1	—	9	1	20
Concussion Gren.	1	1 hit	9	1	40
Paint Grenade	1	—	9	1	20
Limpet Mine	1	1 die	—	1	60
Gren. Launcher	2	—	7	5	—
LAW	2	2 dice	8	1	500
VLAW	1	1 die	8	1	200
Tripod RR	5	2 dice	7	3	1605
RR clip	2	—	—	3	155
Tripod MG	5	1 die	7	20	1500
Machine-Gun clip	2	—	—	20	550
Portable FT	5	1 die	6	5	875

Movement Chart

On the chart below, the numbers show how far the vehicle moves in that phase. "1" means it moves 1 inch and "2" means it moves 2 inches. Thus, a vehicle moving at 170 mph will move 2" on phases 1 and 2, 1" on 3, 2" each on 4 and 5, 1" on 6, 2" on 7, 8, and 9, and 1" on 10, for a total of 17" in 1 turn. The "Ram" column is used to determine the amount of damage suffered in a collision. See "Crashes and Collision" in Section 5, *Movement*.

Speed	1	2	3	4	5	6	7	8	9	10	Ram
0											0
5					½						1d-4
10					1						1d-2
15				1			①				1d-1
20				1			1				1
25			1				1		①		1
30			1			1			1		1
35		1		1		1		①			2
40		1		1		1		1			3
45	1		1		1		1		①		4
50	1		1		1		1		1		5
55	1	1		1		1		1		①	6
60	1	1		1		1		1		1	7
65	1	1		1	1		1	1	①		8
70	1	1		1	1		1	1	1		9
75	1	1	1		1	1	1		1	①	10
80	1	1	1		1	1	1		1	1	11
85	1	1	1	1	1		1	1	1	①	12
90	1	1	1	1	1		1	1	1	1	13
95	1	1	1	1	1	1	1	1	1	①	14
100	1	1	1	1	1	1	1	1	1	1	15
105	1	1	1	1	1½	1	1	1	1	1	16
110	1	1	1	1	2	1	1	1	1	1	17
115	1	1	1	2	1	1	②	1	1	1	18
120	1	1	1	2	1	1	2	1	1	1	19
125	1	1	2	1	1	2	1	1	②	1	20
130	1	1	2	1	1	2	1	1	2	1	21
135	1	2	1	2	1	2	1	②	1	1	22
140	1	2	1	2	1	2	1	2	1	1	23
145	2	1	2	1	2	1	2	1	②	1	24
150	2	1	2	1	2	1	2	1	2	1	25
155	2	2	1	2	1	2	1	2	1	②	26
160	2	2	1	2	1	2	1	2	1	2	27
165	2	2	1	2	2	1	2	2	②	1	28
170	2	2	1	2	2	1	2	2	2	1	29
175	2	2	2	1	2	2	2	1	2	②	30
180	2	2	2	1	2	2	2	1	2	2	31
185	2	2	2	2	2	1	2	2	②	2	32
190	2	2	2	2	2	1	2	2	2	2	33
195	2	2	2	2	2	2	2	2	2	②	34
200	2	2	2	2	2	2	2	2	2	2	35

- ①: If the vehicle has not yet taken its half-move, it must do so now.
- ②: If the vehicle has not yet taken its 1½" move, it must do so now. The 1½" move must occur in a segment marked with a 2".

Vehicle Planning Sheet

The blank vehicle planning sheet below is a valuable aid to designing your own vehicles. List the various components of your vehicle in the column on the left, then fill in the appropriate spaces for cost, weight, and spaces for each item. There are also columns for keeping running totals of weight and spaces used — very handy for making sure you have a legal *Car Wars* design.

At right is an example of a filled-out vehicle planning sheet. It matches the description and diagram of the stock *Hotshot* used on page 7 in Section III, *Getting Started*. Note how all the items in the written description are accounted for on the planning sheet, and all the items involved in combat have been transferred to the vehicle diagram. Some items, like the suspension and chassis, are important to the construction of the vehicle, but have no bearing on combat — they are omitted from the diagram, but included on the planning sheet and description.

SAMPLE SHEET FOR STOCK *HOTSHOT*

Item	Cost	Wt.	Spaces	Total Wt.	Spaces Left	Notes
Vehicle Wt. Capacity	6600					Total \$ 14,600
Acceleration		5 MPH				
HC			3			
Body Size	800	1800		1800	19	LUXURY
Chassis Str.	800					X-NV
Power Plant	3000	1100	6	2400	13	SUPER
Suspension	1200					HC 3
Tires - 4	800	200		3000		DR-TM
Driver		150	2	3250	11	NO ARMOR
Gunner		—	—			
Weapon	2000	1700	8	5050	3	4 FT
Ammo	1000	200		5250		4 FULL-PT. LANS
Weapon	2000	300	2	5550	1	2 MO
Ammo	1000	100		5650		3 FULL-PT. LANS
Weapon						
Ammo						
Weapon						
Ammo						
Weapon						
Ammo						
Accessory	300	150	1	5900	0	FIRE EFT.
Accessory	100					2 LINK-LINK
Accessory						
Accessory						
Armor	80	1600	800	6600		\$20/0
Totals	\$4,600	6600		6600	0	NO CHARGE SPANER

VEHICLE PLANNING SHEET

Vehicle Wt. Capacity	Acceleration	HC	Total \$			
Item	Cost	Wt.	Spaces	Total Wt.	Spaces Left	Notes
Body Size						
Chassis Str.						
Power Plant						
Suspension						HC:
Tires						
Driver		150	2			
Gunner						
Weapon						
Ammo						
Weapon						
Ammo						
Weapon						
Ammo						
Weapon						
Ammo						
Weapon						
Ammo						
Accessory						
Accessory						
Accessory						
Accessory						
Armor						
Totals						