

BUBBLEGUM **EX**

CRISIS

THE EXTREME ANIME ROLEPLAYING EXPANSION



ADVENTURES BEYOND THE ANIME WORLD OF BERSERK BOOMERS AND HI-TECH HEROES!

BUBBLEGUM CRISIS EX – THE EXTREME EXPANSION FOR BUBBLEGUM CRISIS

BUBBLEGUM CRISIS EX



THE EXTREME ANIME ROLEPLAYING EXPANSION



BUBBLEGUM CRISIS EX

BUBBLEGUM CRISIS EX CONTENTS

CONTENTS	2	NEW BATTLEMOVERS	45
CREDITS	3	TYPE-9 BATTLEMOVER	46
INTRODUCTION	4	JAPANESE SELF-DEFENSE FORCES	48
EX TECHNOLOGY	6	MISCELLANEOUS GEAR	50
STINGRAY TECH	7	CHARACTERS REVISITED	52
HARDSUIT ADD-ONS	7	PRISS	54
MOTORSUIT	8	SYLIA	56
HYBRID HARDSUIT	9	LINNA	58
HEAVY HARDSUIT	10	NENE	60
FRIGHT KNIGHT ARMORED SUIT	11	MACKIE	62
HIGHWAY STAR MARKETING PROJECT	12	LEON	63
TORNADO MOTORSLAVE	14	OTHER CHARACTERS	64
TEMPEST MOTORSLAVE	15	BUBBLEGUM EX WORLD	66
TYPHOON II VARIATIONS	16	GLOBAL CROSSFIRE	67
MOTO-LAUNCHER	17	NEO-ANGELES	67
HEAVY MOTORSLAVE	18	SAN FRANCISCO	68
LAND CRUISER	20	NIGHT CITY	69
NEW BOOMERS	21	PORTLAND, SEATTLE, & MEGA-GOTHAM	70
BOOMER GOLEM & BU-K9	21	BALTIMORE, COLOGNE, & SYDNEY	71
BU-12 BATTLE BOOMER VARIATIONS	22	EX-PANDING FRONTIERS	72
SPACE BOOMERS	24	SPACE: THE HIGH GROUND	72
BU-15B GOBLIN BATTLE BOOMER	26	THE OCEANS: UNDER PRESSURE	74
BU-17B HELLBENDER BATTLE BOOMER	27	THE DIGITAL DOMAIN	75
SPACE DEVELOPMENT BOOMER	28	RUNNING BOOMERS	76
NEXUS & BEETLE BOOMERS	29	CAMPAIGN TYPES	79
BOOMERS AT WORK	30~32	EX-PANDED HARDSUITS	81
TERRORIST & FIGHTING BOOMERS	33	EX ADVENTURE "VIRTUAL VISION"	84
BOOMER-BOOMER FUSION	34	SILHOUETTE AWAKENS	84
AD POLICE TECH	36	INTERLUDE: TASTING THE APPLE	85
HEAVY FRONTLINE ARMOR	36	BREAKOUT ON THE MALTESE CROSS	86
K-11 TEAM	36	SULTAN'S COIN	86
K-11 HARD DETAIL	37	TIGER, TIGER	87
PAT-ROADER SLAVE-CYCLE	38	ENEMY OF MY ENEMY	88
ADP MOTOROID	39	HOW SHARPER THAN A SERPENT'S TOOTH	89
ADP VEHICLES	40	AFTER THE BATTLE	90
OTHER EX TECH	42	UNHOLY GRAIL	90
MF-405D	42	NEVER THE END	92
USSD K-12B	43	NEW CHARACTERS	93
K-11 JAGER	44		



▼ ABOUT THIS BOOK

Welcome to *Bubblegum Crisis EX*, the EXTremely EXciting EXpansion, EXploding with EXtras! (OK, OK, sorry; we'll stop now.) Anyway, you may be asking, "Why EX"? Well, roleplayers are continuously pushing the boundaries, always looking for that elusive edge, constantly seeking out that special something which will help them take their games further. That's what *BGC EX* is all about.

When the *Bubblegum Crisis Roleplaying Game* first came out, players and Referees were given everything they needed to start roleplaying in the world of *Bubblegum Crisis*. Next came *Bubblegum Crisis Before & After*, which covered *Bubblegum Crash!* and *AD Police* in detail, thereby opening new dimensions to *BGC* gamers. But beyond the videos was a whole other world of *BGC* goodies, a fascinating world of pre-production designs and "sidestory" conceptions, a world that *BGC* gamers and fans alike would thoroughly enjoy exploring. To that end, we've put together *Bubblegum Crisis EX*. Within this book, you'll find all the mecha which never appeared in the *BGC* videos, plus new world background information, more campaign guidelines, and another high-octane *Bubblegum Crossfire* adventure.

Throughout this book, it's assumed that you have the *BGC RPG* and *BGC B&A*, but even if you don't, you'll find a wealth of artwork and data from one of the coolest anime series ever done: *Bubblegum Crisis*.

▼ ABOUT BUBBLEGUM CRISIS

The *Bubblegum Crisis Roleplaying Game* is based on the Japanese anime video series *Bubblegum Crisis* (or "*BGC*," as it's sometimes called). *BGC* was produced by Artmic Design Studio and was released as an 8-part video-only series in Japan from 1987-1990. It spawned two spin-off series: The 3-part prequel series, *AD Police* (which was released in Japan in 1990), and the 3-part sequel series, *Bubblegum Crash!* (which was released in Japan in 1991).

AnimEigo, one of America's premier anime importers and distributors, has released subtitled and dubbed versions of *Bubblegum Crisis*, *Bubblegum Crash!* and *AD Police* for the U.S. market. If you haven't seen these videos yet, check them out! Bug your local video store or contact AnimEigo at: P.O. Box 989, Wilmington, NC 28402-0989. You can also email them at orders@animeigo.com. Their World Wide Web URL address is <http://www.animeigo.com>.

As some fans may know, *BGC* was originally supposed to be 13 episodes long. However, only eight were made due to legal complications. The last five episodes were eventually boiled down into the 3-part sequel series called *Bubblegum Crash!*, but many fans feel that the storyline was never fully resolved ... but fear not! *BGC*'s legal problems are now over, and AIC is working on a new *BGC* TV series, which will air in Japan in 1998. Details are still sketchy, but apparently the new series will not be in the same continuity as the OVAs—it will still follow the Knight Sabers, but the four girls will have new voice actresses and new character designers. Stay tuned for more information from all of us here at ANimechaniX.

BUBBLEGUM CRISIS EX CREDITS

WRITERS: Benjamin Wright, David Ackerman-Gray, David Pulver

TECHNICAL MATERIAL, FUZION™ ADAPTATION, & ART CLEAN-UP: Benjamin Wright

FUZION™ ROLEPLAYING RULES:

© 1997 The Fuzion Labs Group

OTHER CONTRIBUTORS: John Janek, Dana Jorgenson, Alex Okita, Robert Farquhar, Christian Conkle, Max Fauth, Taylor J. Wofford, Grebo Guru

TRANSLATORS: Ryosuke Taketomi, Koji Goto

EDITORS: Oren Schnurr, Bruce Harlick

LAYOUT DESIGN: Benjamin Wright

GRAPHICS: Benjamin Wright, David Ackerman-Gray, Bruce Harlick, Oren Schnurr

ANIMEIGO SUPPORT: Janice Hindle, Suzanne Stanley, Robert Woodhead

BELETED SPECIAL THANKS: John Nowak, who provided valuable assistance to David Pulver during the writing of *Bubblegum Crisis: Before and After*.

SPECIAL ILLO CREDITS: Illos on pg. 21 and 85 are from the *BGC* novels, Vol. 1 and 2. The Beetle Boomer on pg.29 is from the *BGC* video game manual, *Crime Wave*.

ONLINE RESEARCH THANKS: Robert Farquhar (imagines@nlc.net.au), keeper of the Sydney 2033 page (www.nlc.net.au/~imagines/bgcsydney) • Brian Edmonds, keeper of the *BGC* website (<http://www.cs.ubc.ca/spider/edmonds/anime/bgc.c.html>) • Michael Ko, keeper of the MegaTokyo Interactive Map website (<http://hops.cs.jhu.edu/~vincie/megatokyo.html>) • Jeanne Hedge, keeper of the *BGC* Synopses website (<http://www.accsyst.com/jhedge/bgcindx.htm>) • Eric Tiberius Cheng, keeper of the *AD Police Files* website (<http://www.cyberus.ca/~etc/adp.html>) • Andy Skuse, keeper of the Raven's Garage website (<http://execulink.com/~askuse/ravengar.html>)

- Julian James Kuleck, keeper of the *GURPS-BGC* website (<http://phoenix.kent.edu/~jkuleck/cgs.htm>)
- David Kelk, creator of the homegrown *BGC-Mekton* rules and keeper of his own *BGC* website (<http://aries.phys.yorku.ca/physics/kelk/txt/bubble.html>)
- Shawn Hagen, creator of the *BGC-Shadowrun* rules
- Andy McDermott, aka Payndz, compiler of the *BGC A2Z* list (<http://www.yi.com/hom/McdermottAndy/bgc.html>)
- Ping Lin, Enrique Conty, Mike Gaines, Chandra Reyer, Nick Celani, Thomas Chan, and "Celia Stingray", compilers of the *BGC DYN* lists
- Steve Pearl, editor of the *BGC* FAQ and moderator of rec.art.anime.misc
- C. J. Scott (a.k.a. "The Pig"), who figured out the connection between Mason and Largo
- Ben Cantrick (alias Macky Stingray)

ADDITIONAL THANKS: Peter Nordgren, Evan Hughes, Salomon Farin, Dan Quackenbush, Steve Gill, Nick Celani Frank, Douglas M. Akin, Andreas van Ruth, Todd Showalter, Patrick Hall, Ami Mizuno, Ken Arromdee, C. Rosetti, Stephen Douglas, Shawn Kester, Chris Holmes, Ross M. Simmerman, Phil Yff, The Nomad.

ANIMECHANIX

AM 08021 • ISBN# 0-937279-97-8

ANimechaniX is a division of R. Talsorian Games, Inc. Bubblegum Crisis EX Copyright © R. Talsorian Games, Inc., 1998, All Rights Reserved under International Copyright Conventions. Fuzion™ is the FUZION Labs Group's Trademark for its multi-genre game system. "Bubblegum Crisis"; Copyright Artmic, Inc., and Youmex, Inc. 1987-1990; "Bubblegum Crash!"; Copyright Artmic, Inc., 1991 and/or "AD Police"; Copyright Artmic, Inc. and Youmex, Inc. 1990. All Rights Reserved, English subtitled/dubbed versions Copyright, AnimEigo, Inc., 1991-1995, All Rights Reserved.

All situations, incidents and persons portrayed within are fictional and any similarity without satiric intent to individuals living or dead is strictly coincidental.

INTRODUCTION



"THE LIGHTS SHINE ON WITHOUT END. I RUSH THROUGH THEM, HAVING FAITH IN THIS TOWN..."
 "SOMEBODY GETS HURT, AND SOMEBODY LAUGHS..."
 "DO IT! IT'S A LONELY, CRAZY TOWN AGAIN TONIGHT..."
 "BURNING HIGHWAY! KLAXONS HOWLING IN THE NIGHT SKY. BURNING HIGHWAY! DREAMS BURST INTO FLAME. BURNING HIGHWAY! RUN WITH ANGER UNTIL IT SHINES..."

— CRISIS—RUN WITH ANGER

ting. This idea operates on the principle that Sylia keeps track of the activity of other Stingray-style vigilantes around the world and regularly sends them new data, keeping all the world's teams abreast of the Knight Sabers' latest technological advances (see page 20 for more on this). Still, if you'd prefer to attribute the invention of these new items to your own characters, go right ahead ... as long as your Ref says its OK.

▼ FUZION™ EVOLUTION

Thus, Fuzion™ is a work in progress. In order to bring the *BGC RPG* up to date, *BGC EX* features a few small differences from the base rulebook. From now on, all BGC books will use these changes:

New Terminology: PERSONality has been changed to PREsence because "presence" is a more accurate description of the Stat's use; a character's PD (Physical Defense) has been changed to SD (Stun Defense) because that's what it really is; and all armor's PD (Physical Defense) has been changed to KD (Killing Defense) to distinguish it from SD; additionally, the term "Campaign Points" has been changed to Option Points.

Scaling Kills: The many mecha of the BGC RPG have been sorted into various scales. Human-scale mecha (such as Hardsuits, Powered Suits, and Boomers) and small vehicles (such as cars, motorcycles, Motorslaves, Battlemovers, trucks, and helicopters) will always be listed with KD, SDP and their weapons will do damage in D6's—Kills will no longer be used for them. Therefore, all damages dished out by mecha of this scale should be multiplied by 14D6 in order to find their scale-correct damages. For example, the Mouth Laser of the BU-55C (*BGC* p.99) does 22D6, since $1.6 \times 14 = 22.4$.

Larger mecha (such as aircraft, tanks, and giant robots) will use Kills, and no fractions will be used—In the *Bubblegum Crisis RPG* book, only the Orca shuttle and the VA-61 Satellite will use Kills. Read below to see how damage works in these different scales:

SDP- and Hit-rated targets attacked by D6-rated weapons:

Damage is applied normally, by determining the total amount of damage rolled, subtracting armor, then applying any remaining damage to the SDP.

"Soft Targets" attacked by Kill-rated weapons: For any target weighing 1000kg or less (which has Hits or SDP), damage is applied by adding 13 to the number of Kills of damage; the result is the number of dice of damage that is done to the target. Determine the total amount of damage rolled, subtract armor, then apply any remaining damage to the SDP.

Large SDP-rated targets attacked by Kill-rated weapons:

Damage is applied by multiplying the Kills of the weapon by 50, subtracting armor, then applying any remaining damage to the SDP.

Kill-rated targets attacked by D6-rated weapons: Damage is applied by dividing the DC of the attack by 14 and dropping any fractions. The result is the Kills of damage done (e.g., a 33D6 attack against a Kill-rated target becomes a 2-Kill attack). Subtract the number of Kills of armor from the attack, then apply any remaining damage to the target's Kills.

Kill-rated targets attacked by Kill-rated weapons: Damage is applied normally, by subtracting the number of Kills of armor from the Kills of damage, then subtracting any remaining damage from the target's Kills.

▼ USING BGC EX IN YOUR GAME

Bubblegum Crisis EX is divided into four sections, offering players and referees new adventure material, new world information, a new way to look at the characters from the videos, and—most importantly—lots of new toys! Truth be told, though *BGC EX* has four sections, the book is mostly about toys: There are over 75 new items featured in the *EX Technology* section! The *EX Technology* section alone should keep *BGC* players and referees busy for quite a while, but we also include *Characters Revisited*, which offers revised values for the major *BGC* characters. If you've been wanting a slightly more "realistic" power level for your campaigns, this section is for you. Following the revised characters is the *Bubblegum EX World* section, which examines cities across the globe and even explores the frontiers of inner and outer space. This section also includes referee guidelines for handling those tricky Boomer issues, and introduces a new self-contained Hardsuit construction system. The last section in the book is *Virtual Vision*, a 2034-era adventure which throws the players into a complex plot and pits them against some of the new boomers and other items which appeared in the *EX Technology* section.

Some readers may be concerned that all these new items can upset the power balance of a campaign. To avoid problems, don't introduce lots of new mecha in a single adventure. Instead, each time a new vehicle, mecha, boomer, or other item appears, it should be a major event. In fact, new mecha and weapons can become the foci of entire adventures themselves! A team may have to track down parts, hack their way into secure systems to download blueprints, or capture prototypes from the enemy.

At the same time, it's important that the new toys in *BGC EX* be integrated into a game in a smooth way. Nobody's going to buy the idea that their vigilante team suddenly gets a whole crop of new mecha simply because "the latest supplement is out." For this reason, we offer the idea of Sylia Stingray Data Updates as part of the *Bubblegum Crossfire* set-

Another way of looking at Kill conversions is to check how many non-fractional Kills the attack does—each full Kill is 14D6. Add these 14D6 increments up, then refer to the right to convert any remaining fractional Kills to dice:

0.0K:	+0D6	0.5K:	+7D6
0.1K:	+1D6	0.6K:	+8D6
0.2K:	+3D6	0.7K:	+10D6
0.3K:	+4D6	0.8K:	+11D6
0.4K:	+6D6	0.9K:	+13D6



THE EX ICON SYSTEM

Because of *BGC EX*'s unique subject matter, a special system of icons is used to identify the various items in the *EX Technology* chapter (which covers pages 6 through 53). This chapter details some 79 new items—items culled from a wide variety of sources. In the spirit of keeping *BGC* fans on top of things, each item has been tagged with icons which explain the origin of the item.

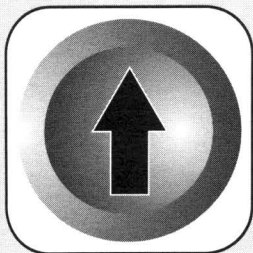

▼ ROUGH DESIGN

The “upward-pointing arrow” seen to the left means that the item was a *rough design*, a preproduction version of something which eventually turned up in the animation, albeit in a different form. Many rough designs are hardly different from what actually appeared in the animation, and were therefore skipped over as candidates for inclusion in *BGC EX*; On the other hand, some roughs are completely unrecognizable from their final forms—these were the designs which were included in this book, since they're effectively new material to most readers! We occasionally use this icon also to represent material that appeared so briefly in the anime that you probably missed it.

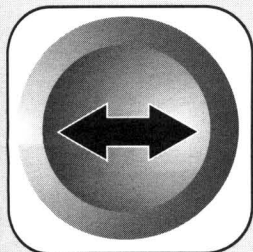

▼ SIDESTORY DESIGN

The “dual-headed arrow” seen to the left means that the item was created to serve the purposes of a *sidestory*. What is a sidestory? Well, the Japanese use the term as a catch-all for stories which take place outside of or parallel to the central plotline. The *AD Police* mangas, the two *BGC* novels, and the *Soldier Blue* story (which bridges *Crisis* and *Crash!*) are all considered *BGC* sidestories. In addition, new mecha and other items are often invented to fill gaps in continuity, effectively becoming small sidestories themselves. Sidestory designs are therefore somewhat more official and authentic than rough designs.



▼ TEXT TRANSLATED FROM JAPANESE

The Japanese character (or “kanji”) symbol to the left means that the text accompanying the item was derived from translated Japanese text. Sidestory designs usually tend to have more text accompanying them than rough designs do, thereby adding yet another level of authenticity to sidestory designs. However, sometimes rough designs will have their own text, which often makes for fascinating reading. On occasion, a rough design or sidestory design will even be adopted into the official canon (this was the case with the MSX-01; see *BGC*, p. 86).



▼ TEXT CREATED BY RTG

The “question mark” symbol to the left means that the text accompanying the item was invented by the demented minds here at the RTG offices. This was only done when there was no Japanese text to translate, and thus was used mostly for rough designs. Every effort was made to remain true to the style and character of *BGC*, so the text's details were extrapolated from careful analysis of the artwork. On occasion, we created new text to supplement translated text, but you will only see this icon when little or no text was available for translation.

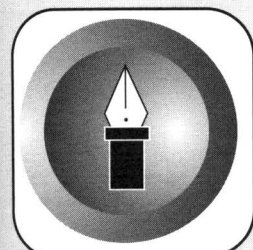

▼ ARTWORK CLEANED UP BY RTG

The “fountain pen” icon seen to the left means that the item's original Japanese artwork was too sketchy or faint to be published as-is. This problem only occurred a few times and (as might be expected) was exclusively an issue with rough designs. These “very rough roughs” were therefore “cleaned up”—that is, traced over or digitally touched-up—by the RTG staff so that you can make out what the item looks like! Very few pictures in this book needed to be cleaned up, so rest assured that you're still getting original Japanese anime artwork.

▼ EXAMPLE: THE ICON SYSTEM AT WORK

To the right we see the Heavy Hardsuit (which is fully detailed on page 10). The picture bears two icons: the “upward-pointing arrow” and the “question mark”. These icons tell us that the Heavy Hardsuit is a rough design (as opposed to a sidestory design) and that RTG made up its text writeup (since it had no accompanying Japanese text). Since the “fountain pen” icon is not present, the original Japanese artwork has not been altered.

▼ NEW DAMAGE NOTATIONS

We introduced a new damage notation system in *BGC:B&A* which uses multipliers of D6 sets (i.e. 7D6x4). These work the same as normal dice of damage (you can even roll all those dice if you want). When converting such damage ratings to Kills, calculate the total number of dice the notation represents and divide by 14, rounding down. Example: 8D6x3 represents 24D6 of damage (3x8=24). Divided by 14 equals 1.7 or 1 Kill if used against a Kill-rated structure.

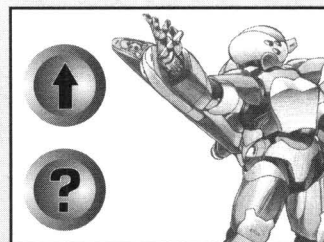

EX TECHNOLOGY

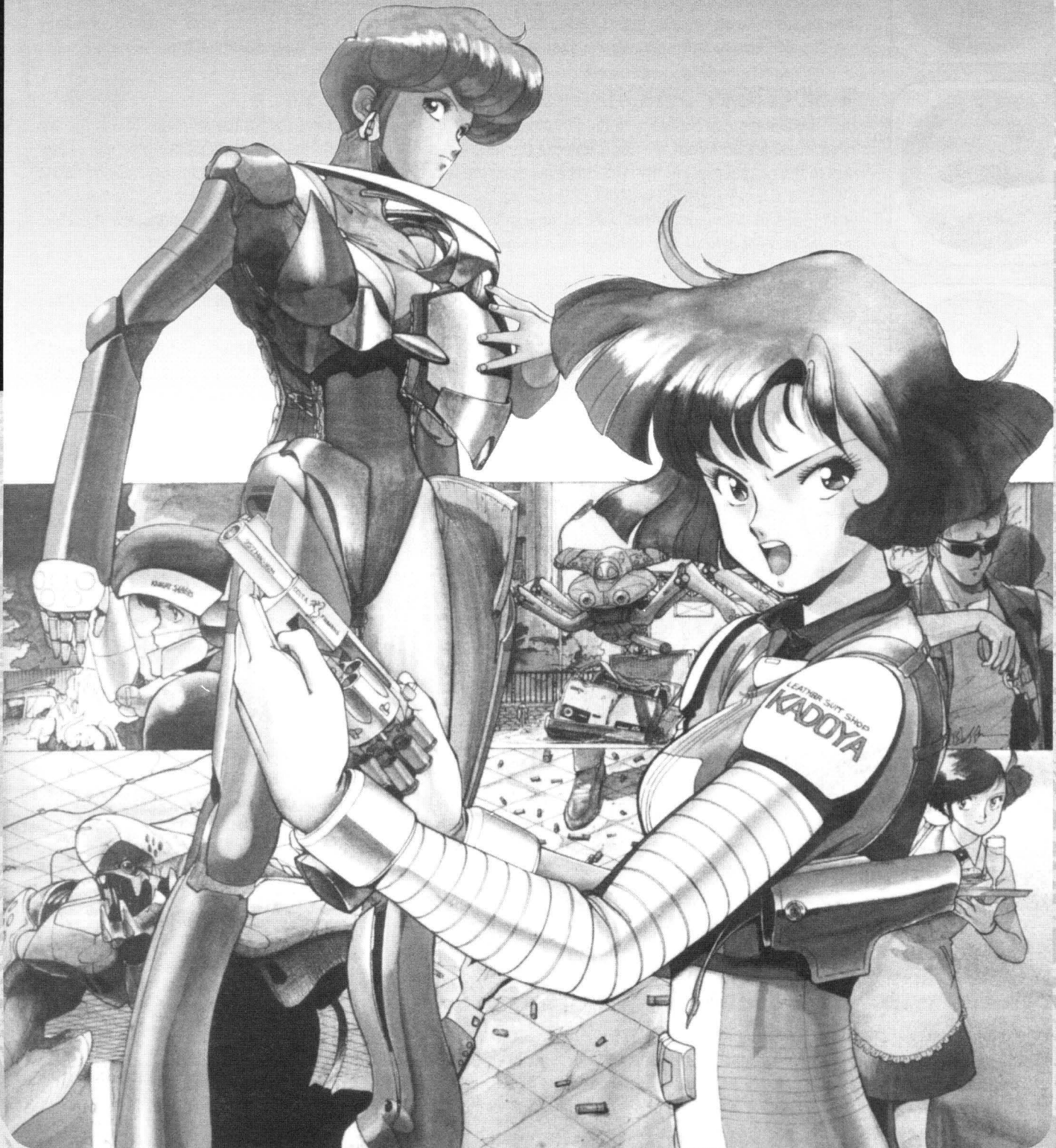

STINGRAY TECH

▼HARDSUIT ADD-ONS

Listed below (and illustrated at right) is an assortment of new weapons and systems which can be added to a hardsuit to enhance its performance.

1. GATLING CANNON +9 OP

WEAPON	WA	RNG	DMG	LOC	SPECIAL NOTES
20MM GATLING	-1	440m	12D6*	RA	*AP, ROF 100, 5 bursts.

This triple-barreled, caseless weapon attaches to a hardsuit's powerglove to greatly enhance its firepower. A linkage through the glove powers the cannon's motor, and a weight in the rear improves balance (although recoil is still very strong). It precludes use of the right hand and its weapons, and adds 49.7 kg.

2. LASER CANNON +11 OP

WEAPON	WA	RNG	DMG	LOC	SPECIAL NOTES
LASER CANNON	+1	1km	7D6x5	RA	No burstfire ability.

A powered-up version of the standard laser gun built into a hardsuit's right arm, this weapon prohibits the inclusion of a manipulator of any kind. In exchange, room is made for the high-speed capacitor which power the laser.

3. BEAM MISSILES +11 OP

WEAPON	WA	RNG	DMG	LOC	SPECIAL NOTES
BEAM MISSILES	-2	550m	7D6x3*	T	*Does dmg twice per hit.

This system packs the power of the Hand Cannon (*BGC B&A p69*) in a compact package; batteries and converter packs are attached to the outside surfaces of the hardsuit's calves and thighs, linked to the main projector array on the chest. For firing, the chest panels open to clear the dual beam lenses.

4. SLINGERS +1 OP

WEAPON	WA	RNG	DMG	LOC	SPECIAL NOTES
SLINGERS	-1	200m	(*)	A,A	*Entangling (<i>BGC p41</i>).

This pair of arm-mounted line-throwers uses compressed gas to launch multi-role grapnels. Each grapnel is a combination articulated claw, adhesive plate and electromagnet, and is attached by a weaved monofilament line to a core-less-motor winch. The 200m lines are capable of supporting 3 tons and allow the hardsuit to easily swing from building to building and/or entangle opponents.

5. WING PANNIER +18 OP

ARMOR	40 KD	STRUCTURE	30 SDP	WEIGHT	+31.5kg
FLYING	Move 101 (304kph)	MANEUVER	-2 Ref, Dex, & Move		

WEAPON	WA	RNG	DMG	LOC	SPECIAL NOTES
VULCAN GUN	±0	480m	8D6*	T	*AP, ROF 80, 7 bursts.

This device attaches to a Hardsuit's shoulders and back to grant full flight capability. Clamplike panels close over the chest to secure the unit, which consists of a turbofan engine, variable-geometry wings, and a triple-barreled Vulcan gun. The Wing Pannier allows the Hardsuit to fly for extended periods of time, although hovering isn't possible (the turbine would stall). When not in use, the wings can fold down over the back of the Hardsuit.

6. BB-2000 ELIMINATOR +16 OP

WEAPON	WA	RNG	DMG	LOC	SPECIAL NOTES
ELIMINATOR	±0	166m	7D6x4*	RA	*API, ROF5, 20 bursts.

This weapon uses magnetic fields to fire a mercury-like liquid (stored inside a tank on the back) like a railgun. It was designed to be attached to the right arm of Priss' first Hardsuit, but was never actually deployed in combat.

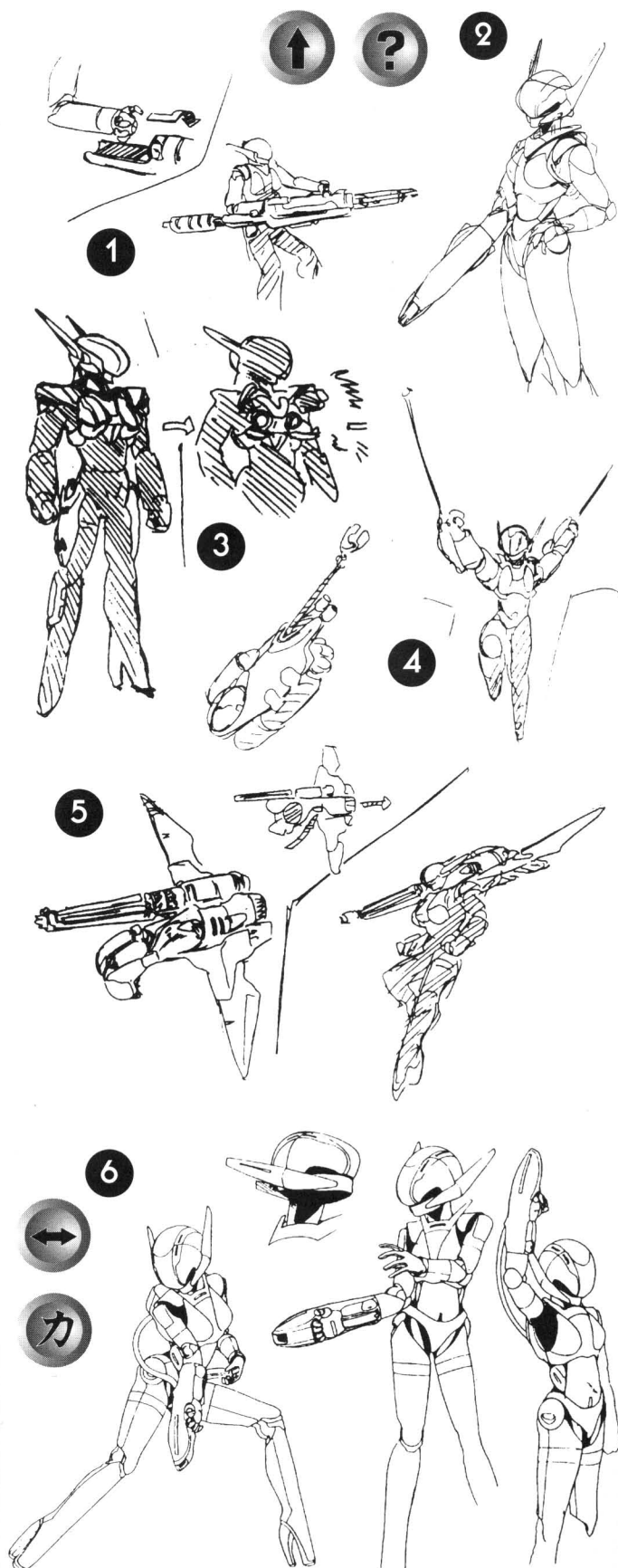

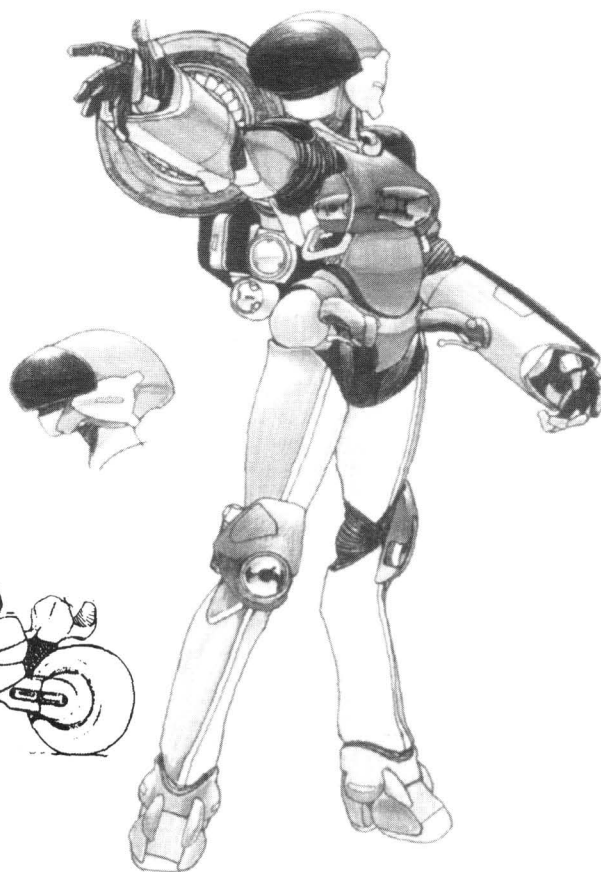
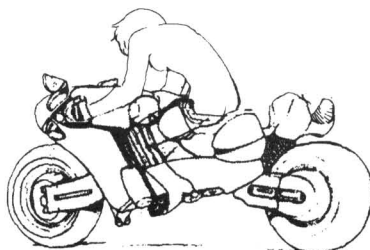
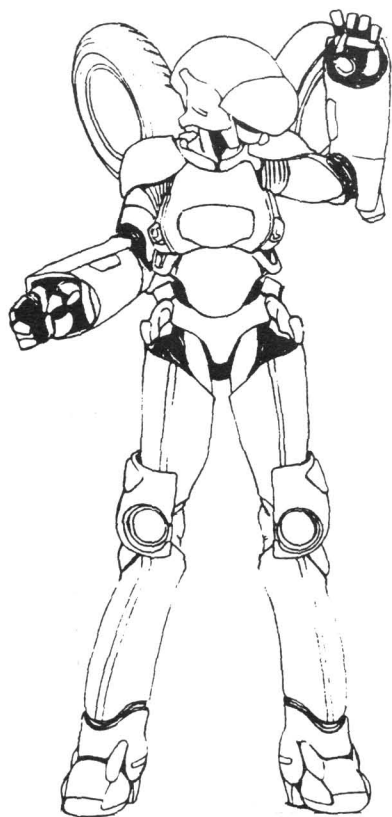

▼MOTORSUIT

During the early days of the Knight Sabers, one of Sylia and Mackie's "pet projects" was experimenting with the possibility of combining the concepts of a Motorslave and a Hardsuit. This Hardsuit-Motorslave Integration Project involved the design of a transformable hardsuit—which would also free up the basic shape of a full-size motorcycle for use as an extra-heavy weapons platform. This project led to the conception of the Motorsuit, the Hybrid Hardsuit, and the Heavy Hardsuit; a heavy-weapons motorcycle system (the Moto-Launcher, on page 17) was developed parallel to these new hardsuits.

The first prototype conceived as part of the project was designed by Sylia's brother Mackie, a confessed motorcycle nut. The Motorsuit can function as a normal Hardsuit, armed with a laser gun in the right forearm and a retractable lasersword in the left forearm, but the addition of an engine-and-wheels backpack array facilitates the suit's transformation into a motorcycle. In Motorcycle mode, the rider is not wearing the hardsuit as armor and is poorly protected; a kevlar-armed innerwear suit was proposed to solve this problem, but it was never made. The complexity of the Motorsuit design makes it difficult to transform while moving; only a highly agile and acrobatic rider could go from motorcycle mode to Hardsuit mode without stopping and dismounting from the bike (DEX + Athletics + die roll vs 25 to transform in one Phase; otherwise, three phases are needed—one to stop & dismount, one to transform, and one to re-board and get moving again). Unlike full-fledged Motorslaves, however, the Motorsuit has no onboard AI, so the bike can't drive by itself (nor can it be remote-controlled).

Overall, Sylia thought the Motorsuit was too dangerous and complicated to warrant actual combat use, a decision which relegated it to the status of a Knight Sabers technology demonstrator. Still, Sylia included its blueprints in data-updates to Stingray-inspired vigilante groups in other parts of the world, some of whom have fielded similar units... with mixed results.

MOTORSUIT

135 OP

WEIGHT	77.52/89.38 kg	POWER	50 hours
MANEUVER	-1 DEX & REF	DESIGN & STYLE	+1 PRE
STRENGTH	STR 9	RUNNING	+4 Move
LIFTING	Wearer's x9	JUMPING	100m
SENSOR RANGE	1 km	COMM RANGE	10 km
ARMOR KD	50 Hits	STRUCTURE	55 Hits

WEAPON	WA	RNG	DMG	LOC	SPECIAL NOTES
LASERSWORD	+1	-	7D6x4*	RA	*-20 KD.
LASER BEAM	±0	740m	7D6x3*	LA	*Or burstfire, below.
LASER BURST	-1	555m	11D6*	"	*ROF = 10.
HAND-TO-HAND	±0	-	10D6*	A, A	*Killing.

SUBSYSTEMS *Hardsuit Armor is Fusion-Proof*

- Life Support (full sealing vs. Nuclear, Biological & Chemical agents).
- Information Processing Helmet (optical, audio, radio, targeting, low-light vision, instrumentation and Heads-Up Display [+2 Perception]).
- ECCM System (Rank = 6) and radio scrambler.
- Maneuvering Rockets and Jumpjets (usable in 'Cycle mode).
- Flat-actuated linear motor system (innerwear necessary).
- Emergency armor-ejection function (blows armor off wearer).

TRANSFORMATION

With wheel-and-engine backpack (which can be mounted or removed in 1 Phase), Motorsuit can transform to Motorcycle mode: Maneuver does not change, but MOVE becomes 100 (300kph).

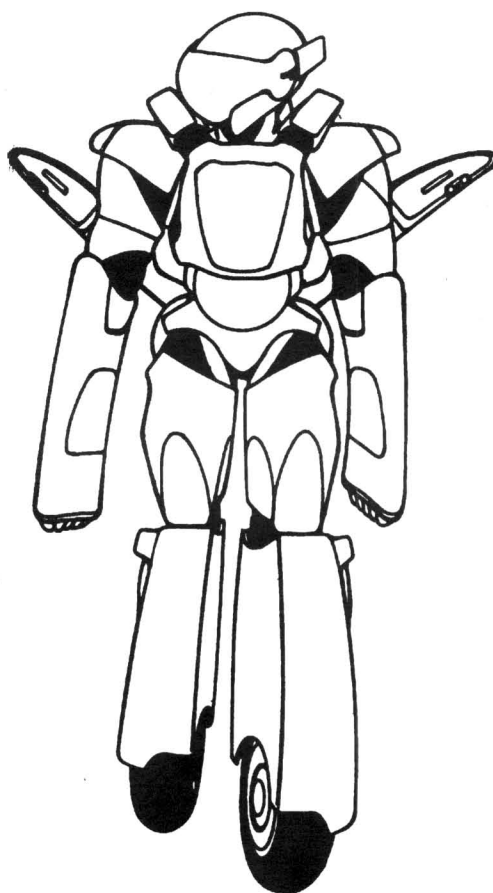

SKETCH OF HYBRID SUIT IN BIKE MODE

HYBRID HARDSUIT					210 OP
WEIGHT	102.8 kg	POWER	50 hours		
MANEUVER	-2 DEX & REF	DESIGN & STYLE	+1 PRE		
STRENGTH	STR 10	SKATING	Move = 24 (72kph)		
LIFTING	Wearer's x10	JUMPING	150m		
SENSOR RANGE	1 km	COMM RANGE	10 km		
ARMOR KD	65 Hits	STRUCTURE	60 Hits		
WEAPON	WA	RNG	DMG	LOC	SPECIAL NOTES
LASER BEAM	±0	800m	8D6x3*	LA	*Linked to other laser.
LASER BURST	-1	600m	12D6*	"	*ROF = 10.
LASER BEAM	±0	800m	8D6x3*	LA	*Linked to other laser.
LASER BURST	-1	600m	12D6*	"	*ROF = 10.
HAND-TO-HAND	-2	-	10D6*	A, A	*Killing.
SUBSYSTEMS		<i>Hardsuit Armor is Fusion-Proof</i>			
• Life Support (full sealing vs Nuclear, Biological & Chemical agents).					
• Information Processing Helmet (optical, audio, radio, targeting, low-light vision, instrumentation and Heads-Up Display [+2 Perception]).					
• ECCM System (Rank = 7) and radio scrambler.					
• Maneuvering Rockets and Jumpjets (usable in 'Cycle mode).					
• Flat-actuated linear motor system (innerwear necessary).					
• Emergency armor-ejection function (blows armor off wearer).					
TRANSFORMATION					
Hybrid Hardsuit can transform to Motorcycle mode in one Action:					
Maneuver becomes -1, and MOVE becomes 111 (333kph).					

▼HYBRID HARDSUIT

This was the second prototype hardsuit designed by as part of the Hardsuit/Motorslave Integration Project. Much like the Motorsuit, this unit was designed to supercede the Motorslave by transforming from a Hardsuit to a Motorcycle—however, based on the problems with Mackie's concept, Sylia designed this model using alternative methods to those used in the Motorsuit.

Sylia's design, the Hybrid Hardsuit, was larger and thus more structurally sound than the Motorsuit, and also did a better job of approximating the strength and armor protection of a Motorslave. Furthermore, its transformation didn't rely upon an optional backpack, instead integrating the transformation mechanics more fully into the suit's overall structure. A benefit of this structure was the fact that the Hybrid boasted a high groundspeed even in Hardsuit mode, thanks to the positioning of the wheels at the base of the legs—this suit could "skate" under power at speeds of over 50mph. It was even faster in motorcycle mode, and offered a slightly better safety margin because of its recumbent layout: The rider sat in a more reclined, "lowrider" position than the typical racing-style posture required by both the Motorslaves and the Motorsuit. This position also made it much easier to transform while moving (no skill roll required). The Hybrid's weakest spot was armament—the transformation demanded retractable manipulators, which sacrificed valuable space normally dedicated to weapons. Its only offensive systems were an array of laser guns whose lenses were built into the fingers of the retractable manipulators.

Though in some ways it was an improvement over the Motorsuit, the Hybrid was much less maneuverable in Hardsuit mode. As a result Sylia decided to mothball the design, although she did include its specs in data-updates to other vigilante groups, so similar units have actually been built in other cities.

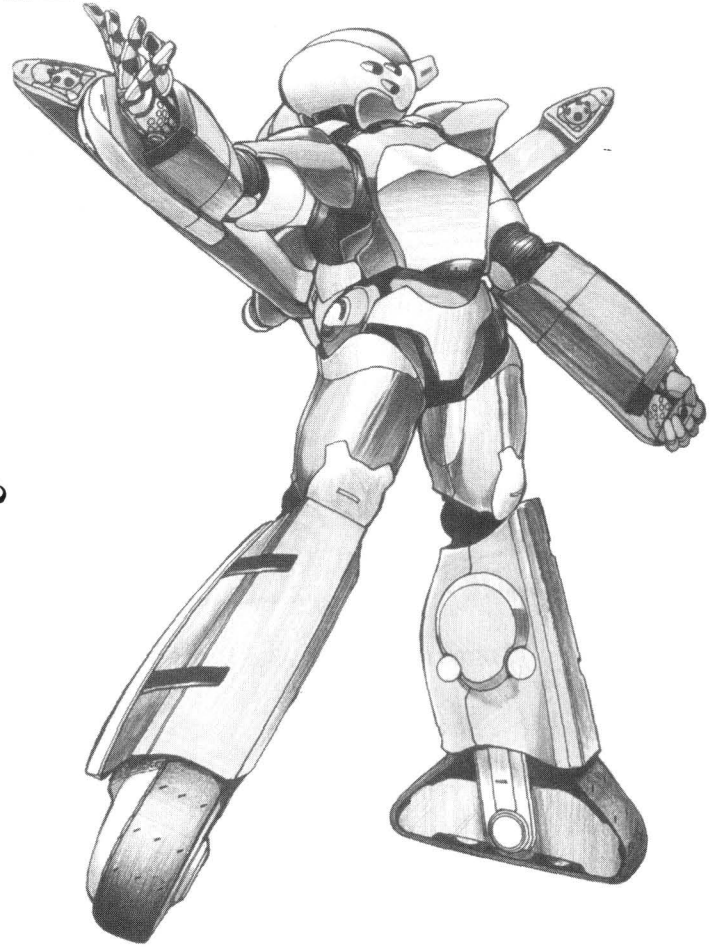
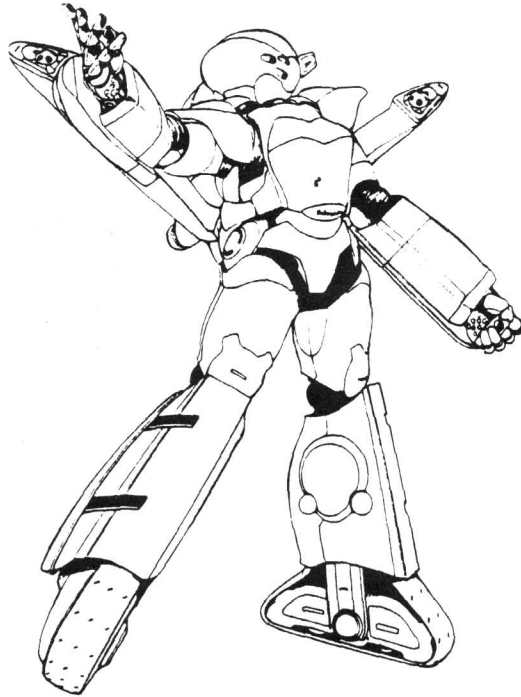

▼ HEAVY HARDSUIT

Following the development of the Motorsuit and the Hybrid Hardsuit, Syla decided to do away with the problematic transformation mechanic and instead chose to directly integrate Motorslave elements into a Hardsuit. The result was a more powerful, higher-speed hardsuit whose armor protection was significantly greater than that of the team's normal suits. However, a sacrifice of maneuverability and dexterity was unavoidable, so this prototype, like its two predecessors, faded into Knight Saber obscurity.

Still, the Heavy Hardsuit's strength, armor protection, and ground speed abilities did indeed approach those of a full Motorslave—an impressive achievement in itself. Notable features of the Heavy Hardsuit included powered manipulators on both arms in order to make use of the increased skeletal strength, and caterpillar belts (powered by a large backpack engine) were built into the feet to give the suit a high ground speed without sacrificing balance. (As a dedicated heavy unit, this Hardsuit had jumpjets and no flight capability.) The suit's extra-heavy armor was supplemented by bracer-size shields on each forearm—shields whose blunt tips functioned like the knuckle guards on Priss' second hardsuit. With the manipulators dedicated to maximum gripping power, the signature laser weaponry was placed in the helmet; by mounting twin Linna-style triple-barreled lasers, the head was effectively turned into a high-firepower laser turret. In addition, an early version of the Pulse-Striker system was added because its wide-angle attack ability helped make up for the suit's poor dexterity.

Though Syla opted not to use the Heavy Hardsuit in the field, its design specs were included in data-updates to other Stingray vigilante groups, so units like this one have been used on occasion.

HEAVY HARDSUIT						308 OP
WEIGHT		111.7 kg		POWER		50 hours
MANEUVER		-2 DEX & REF		DESIGN & STYLE		+1 PRE
STRENGTH		STR 11		DRIVING		Move 33 (99kph)
LIFTING		Wearer's x11		JUMPING		Wearer's +11m
SENSOR RANGE		1 km		COMM RANGE		10 km
ARMOR KD		90 Hits		STRUCTURE		65 SDP
WEAPON	WA	RNG	DMG	LOC	SPECIAL NOTES	
LASER TURRET	-1	680m	9D6x2	H	ROF 10; 1 pt success = 2 hits.	
PULSE-STRIKER	+3	100m	10D6x2	T	5m area, shock, warmup 1.	
SHIELD PUNCH	+0	-	7D6x4	RA	Shield DA-3, 100KD.	
SHIELD PUNCH	+0	-	7D6x4	LA	Shield DA-3, 100KD.	
HAND-TO-HAND	+0	-	11D6*	A, A	*Killing damage.	
SUBSYSTEMS						<i>Hardsuit Armor is Fusion-Proof</i>
• Life Support (full sealing vs Nuclear, Biological & Chemical agents).						
• Information Processing Helmet (optical, audio, radio, targeting, low-light vision, instrumentation and Heads-Up Display [+2 Perception]).						
• ECCM System (Rank = 8) and radio scrambler.						
• Maneuvering Vernier-Rockets.						
• Flat-actuated linear motor system (innerwear necessary).						
• Emergency armor-ejection function (blows armor off wearer).						
• High-speed caterpillar belts built into foot sections allow powered "skating" at up to 66mph over paved surfaces (half that over rough ground).						

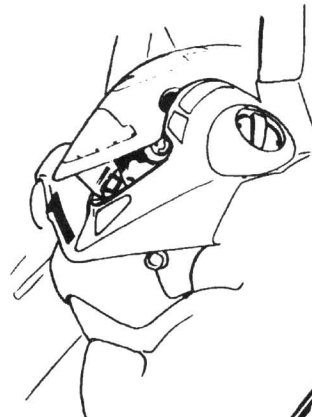

ABOVE: DETAIL OF HEAD COVER SECTION WITH SENSOR CLUSTER RETRACTED AND VISOR OPENED.

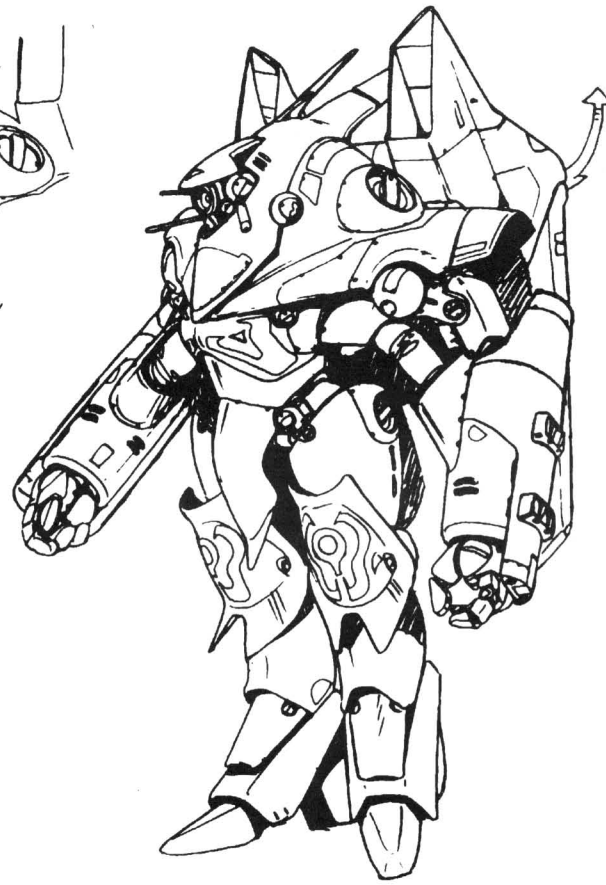

FRIGHT KNIGHT SUIT 247 OP

WEIGHT	125.25 kg	POWER	50 hours
MANEUVER	-2 DEX & REF	DESIGN & STYLE	+2 PRE
STRENGTH	STR 11	RUNNING	+2 Move
LIFTING	Wearer's x11	FLYING	Move 100 (300kph)
SENSOR RANGE	2 km	COMM RANGE	80 km
ARMOR KD	75 Hits	STRUCTURE	75 SDP

WEAPONS (2)	WA	RNG	DMG	LOC	SPECIAL NOTES
LASERSWORD	+1	-	7D6x4*	-	*-20KD.
LASER GUN	+0	800m	8D6x3	-	ROF = 3.
RAILGUN	+0	350m	14D6*	-	*AP, ROF = 2, 12 bursts.
MISSILES	+0*	2 km	3 1/2	-	*Smart (16+die), 2 shots.
HAND-TO-HAND	+0	-	10D6*	A, A	*Killing damage.

SUBSYSTEMS

- Life Support (full sealing vs Nuclear, Biological & Chemical agents).
- Dual-mode helmet housing (audiovisual, radio, targeting, low-light vision, IR & Thermograph, x32 magnification, Heads-Up Display [+2 Perception] and retractable visor cover).
- ECCM System (Rank = 6) and radio scrambler.
- Maneuvering Vernier-Rockets and Variable-geometry engine-and-wing blocks; if a called shot at -2 is made and armor is penetrated, a wing is destroyed and the suit can no longer fly.
- Emergency armor-ejection function (blows armor off wearer).
- Quick-change weapon mounts on forearms (choose 2 from list).

▼ “FRIGHT KNIGHT” ARMORED SUIT

This powered unit represents an unusual divergence from classic Stingray technology. Though based on principles similar to those used in Genom’s prototype powered suit (see the *BGC RPG*, p.135), it has been heavily modified with systems utilized by the Motorslaves. It has little in common with a Hardsuit, but that hasn’t prevented the infamous Fright Knights vigilante group from using it as their standard-issue suit of armor.

The most notable feature of this armored suit is its arms, which use a distinctive motorslave-like arrangement: The wearer’s arms are inside armored “master-arm” sleeves which connect to the larger, more powerful “slave arms”, which are equipped with powered manipulators, hardpoints for mounting interchangeable weapons, plus subsensors and targeting systems which are housed in the wrists. Another distinctive feature is the oversized backpack, which consists of two large turbine engines mounted on swiveling joints. When stowed, the engines are folded down behind the back; for flight they swing up so that the airscoop intakes point forward over the shoulders and the variable-geometry wings have room to deploy. Thanks to these large engines and the wings, the Fright Knight suit’s airspeed is much greater than that of a Hardsuit like Sylia’s. Also unlike the Hardsuits, the Fright Knight suit does not have a separate helmet. Instead, the wearer’s head is fully enclosed by the armor, with scanning performed by a cluster of sensors atop the body. In non-combat situations, the sensors can be retracted and a visor can be opened to give the operator a clearer view.

Anime Note: This is actually a very early rough design for the Hardsuits used by the Knight Sabers, who were originally going to be called the “Fright Knights.” Cool, huh?



▼THE HIGHWAY STAR MARKETING PROJECT

In 2033, Mackie proposed a marketing project for the Highway Star as a possible way to solve the Knight Sabers' constant deficit problems. The original Highway Star was an experimental vehicle designed for a hardsuited rider; in order to accommodate the shape of a Hardsuit's feet, its gearshift used an air shifter. However, with modifications, it could be sold in a variety of civilian markets....



Sports Bike (below): Mackie suggested that the bike be remodeled as follows: remove the nitro boosters, modify the bike to use standard parts, install a security system and a maintenance system, add a reverse gear, include automatic cruise control, and install a stereo. That way, it could be sold to the general public as the world's fastest, most advanced street-legal motorcycle.

Dragger (top right): The Highway Star, with its power and nitro-boosters, was a monster; originally, the bike was designed with acceleration as its top priority (which was why it was able to catch up with the Griffon), so it is best suited for drag racing.

Racer (bottom right): Mackie also envisioned a professional racing version (for his own private use, he dreamed). By leaning and using the bike's inherent high speed, balance could be completely self-supported. This variant of the Highway Star would have airbrakes atop the right and left boosters, and shifting gears would be one with a 1-up, 5-down foot pedal.

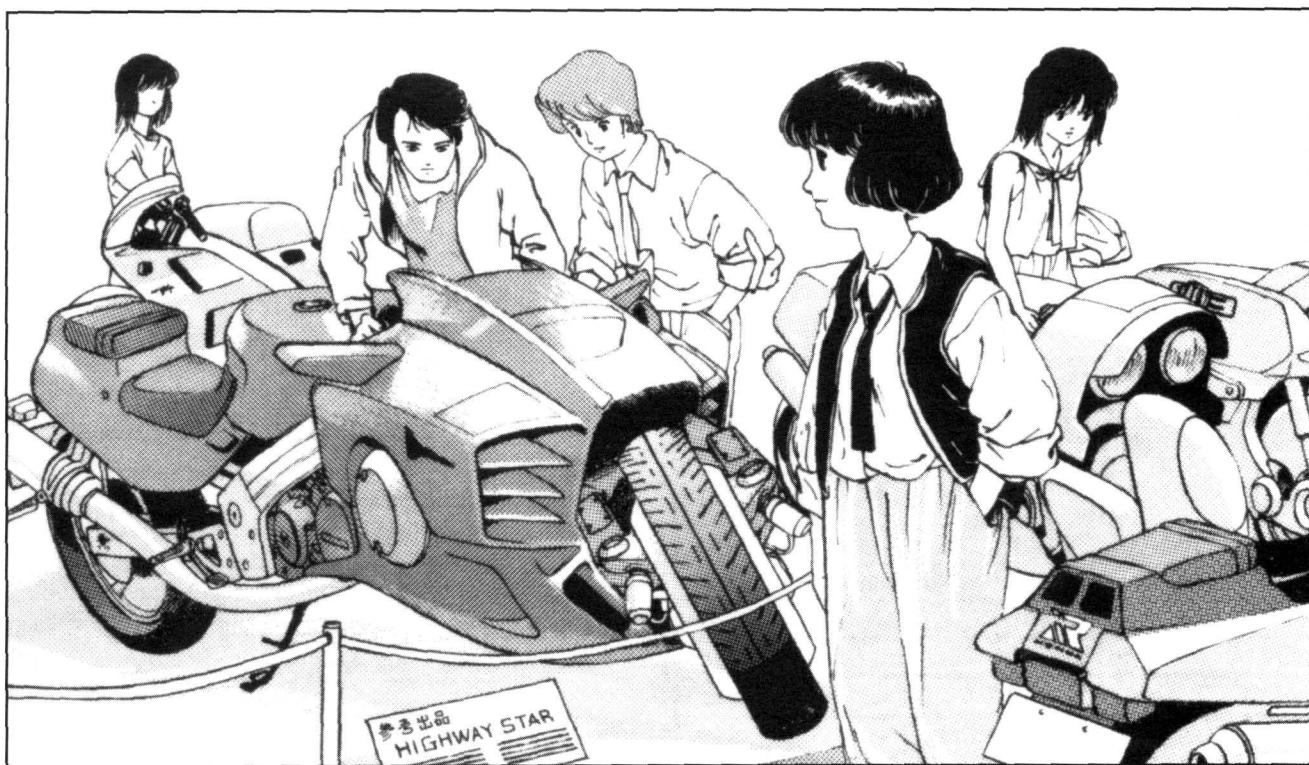

HIGHWAY STAR SPORTSBIKE		10 OP	
WEIGHT	430 kg	SPACE	1 driver
MANEUVER	-0 Ref	MOVE	141 (422kph)
1D10	LOCATION	ARMOR	STRUCTURE
1-6	Chassis	10 KD	40 SDP
7-8/9-10	Wheels (F/B)	-	20 SDP each
SUBSYSTEMS			
• Heads-up instrumentation display with stereo & cruise control.			
• High-intensity headlight.			
• Security System, Maintenance System.			
• Market value = ¥166,666.			

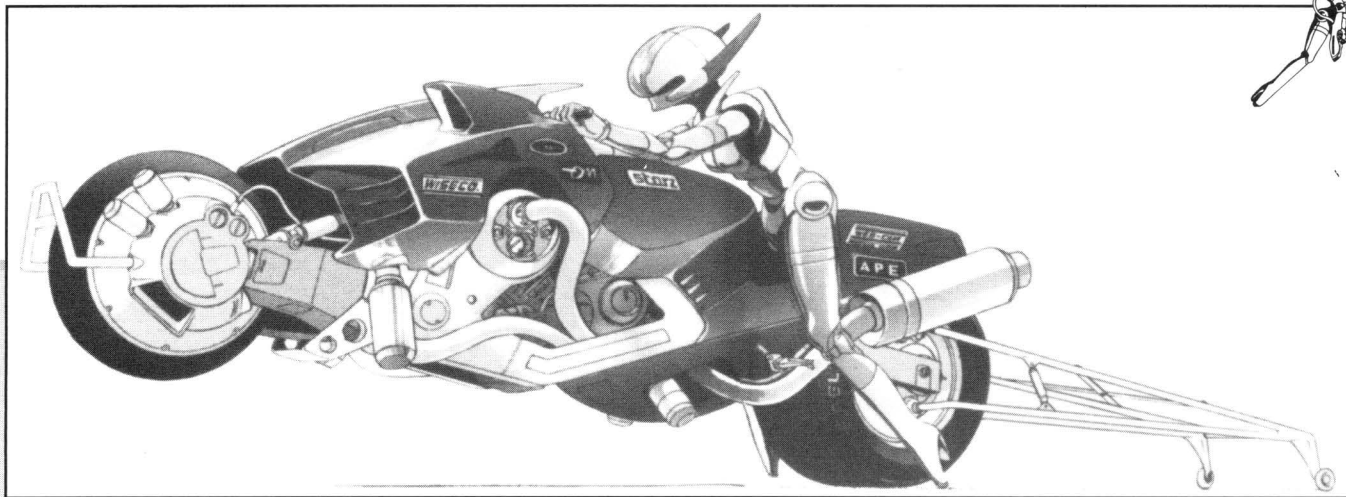

HIGHWAY STAR DRAGGER 14 OP

WEIGHT	430 kg	SPACE	1 driver
MANEUVER	-0 Ref	MOVE	144 (433kph)
1D10	LOCATION	ARMOR	STRUCTURE
1-6	Chassis	10 KD	40 SDP
7-8/9-10	Wheels (R/L)	-	20 SDP each

SUBSYSTEMS

- Heads-up instrumentation display. • High-intensity headlight. • Nitro Boosters: When activated, will boost the bike's speed for 10 phases (30 seconds) to a Move of 175 (525kph), but during that time the driver suffers -1 REF due to the machine's shuddering. • Market value = ¥233,333.

HIGHWAY STAR RACER 12 OP

WEIGHT	430 kg	SPACE	1 driver
MANEUVER	-0 Ref	MOVE	148 (444kph)
1D10	LOCATION	ARMOR	STRUCTURE
1-6	Chassis	10 KD	40 SDP
7-8/9-10	Wheels (R/L)	-	20 SDP each

SUBSYSTEMS

- Heads-up instrumentation display. • High-intensity headlight. • Nitro Boosters: When activated, will boost the bike's speed for 10 phases (30 seconds) to a Move of 166 (500kph), but during that time the driver suffers -1 REF due to the machine's shuddering. • Market value = ¥200,000.

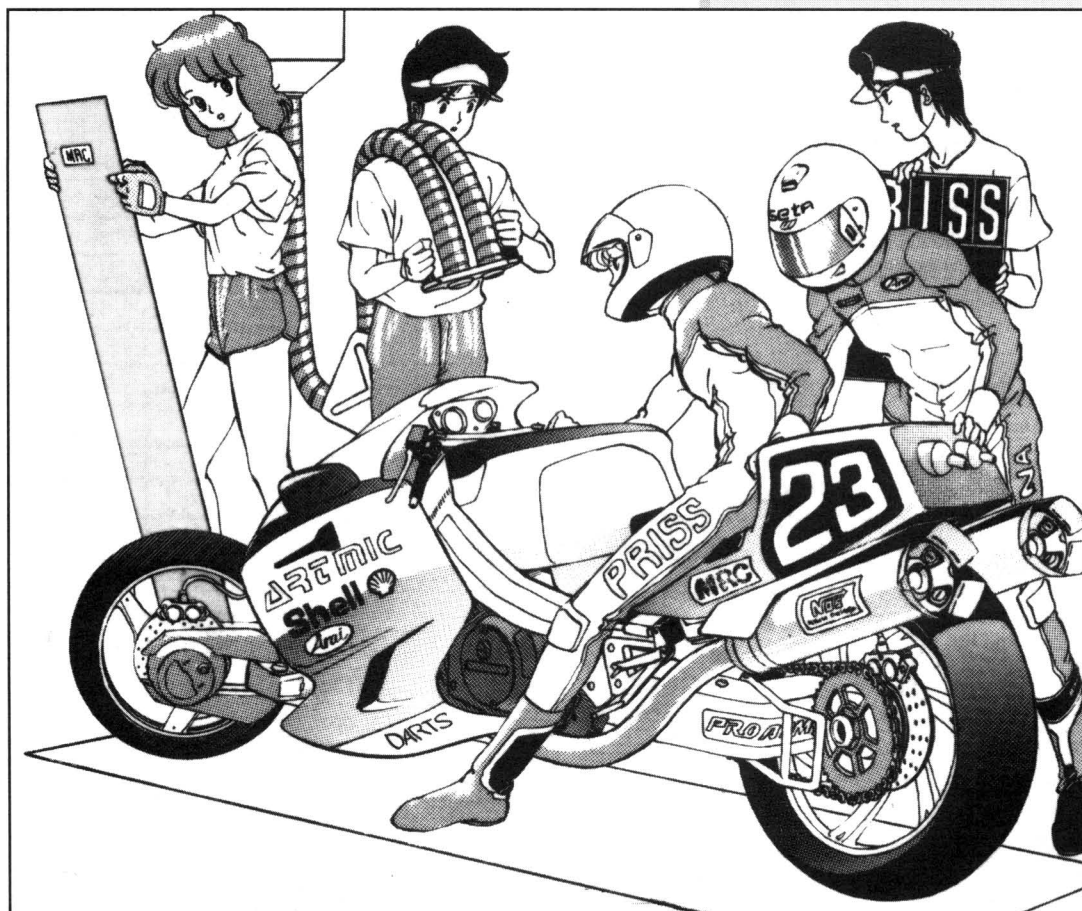



▼TORNADO MOTORSLAVE

When Sylia first incorporated the Motorslaves into the Knight Sabers' arsenal, all four members used Hurricane-Is, with each member's Motorslave color-coded for them. When the Hurricane model was upgraded to the Typhoon, each member's Motorslave was upgraded. However, once Sylia had perfected the AI used by the Motorslaves, she set to work on creating a purpose-made Motorslave for each hardsuit. The demand for these specialized machines was brought on by the selfish, pushy demands of the members, and only Mackie's and Dr. Raven's all-nighters and overall hard work made their completion possible. The first of the new Motorslaves to be constructed was the Typhoon II, which was issued to Priss (and not a moment too soon). Following the success of the Typhoon II, new Motorslaves with advanced AIs were on the way for Linna and Nene.

The Tornado is Linna's specialized Motorslave, designed for maximum speed and aerial maneuverability. While its groundspeed in motorcycle mode is no better than the others, its flight speed (using its hover-rotors) is the highest of any Motorslave. To achieve this, the Tornado is the smallest and lightest Motorslave yet constructed—but this doesn't mean that it's weak. In fact, because the Hardsuited rider's limbs fit inside the Tornado's chassis sections, it actually offers greater protection than any other Motorslave. This type of design is necessary for Linna, who specializes in hand-to-hand and melee combat; the chances of a limb injury are greatest in such close quarters.

Like all previous Motorslaves, the Tornado has no built-in weaponry. Instead, it relies on hand-held firearms. Sylia plans to design special Motorslave-size melee weapons for Linna's Tornado, but hasn't gotten around to it yet.

TORNADO MOTORSLAVE 240 OP

WEIGHT		158 kg	STRENGTH		12
MODE	MANEUVER		SURFACE	FLIGHT	
Motorcycle	-0		115 (345kph)	-	
Motorslave	-1 Ref & Dex		36 (108kph)	100 (300kph)	
Motoroid	*		36 (108kph)	100 (300kph)	

*AI has INT, REF, DEX, & combat skills of 7. When under remote control, it uses Hardsuited operator's stats & skills at 1/2 their normal values.

2D6	LOC	KD	SDP	2D6	LOC	KD	SDP
2	Head	75	45	9/10	R/L Leg	75e	55e
3/4	R/L Arm	75e	50e	11	Wheel	60e	45e
5-8	Torso	75	90		Rotor	30e	22e

12. WEAPONS	WA	RNG	DMG	LOC	SPECIAL NOTES
HAND-TO-HAND	+0	-	7D6x6*	-	*Killing damage.

SUBSYSTEMS: Sensor Turret has audiovisuals (11km), scrambled radio (130km), stereo, targeting, low-light vision & HUD instrumentation (+2 Perception) • ECCM (Rank 7) • One high-intensity headlight • Transformation: Front wheel splits into two hover-rotors for flight • Vernier rockets • Emergency-ejection system blows operator out through back • Styling (+2 PRE) • Fusion-proof armor.

Note: On a Leg or Torso hit, damage is first applied to the 'Slave's KD; if any damage penetrates, roll 1D6: even, it is applied to the Hardsuited operator; odd, damage is applied to the Motorslave's SDP and any remaining damage goes on to the Hardsuited operator.

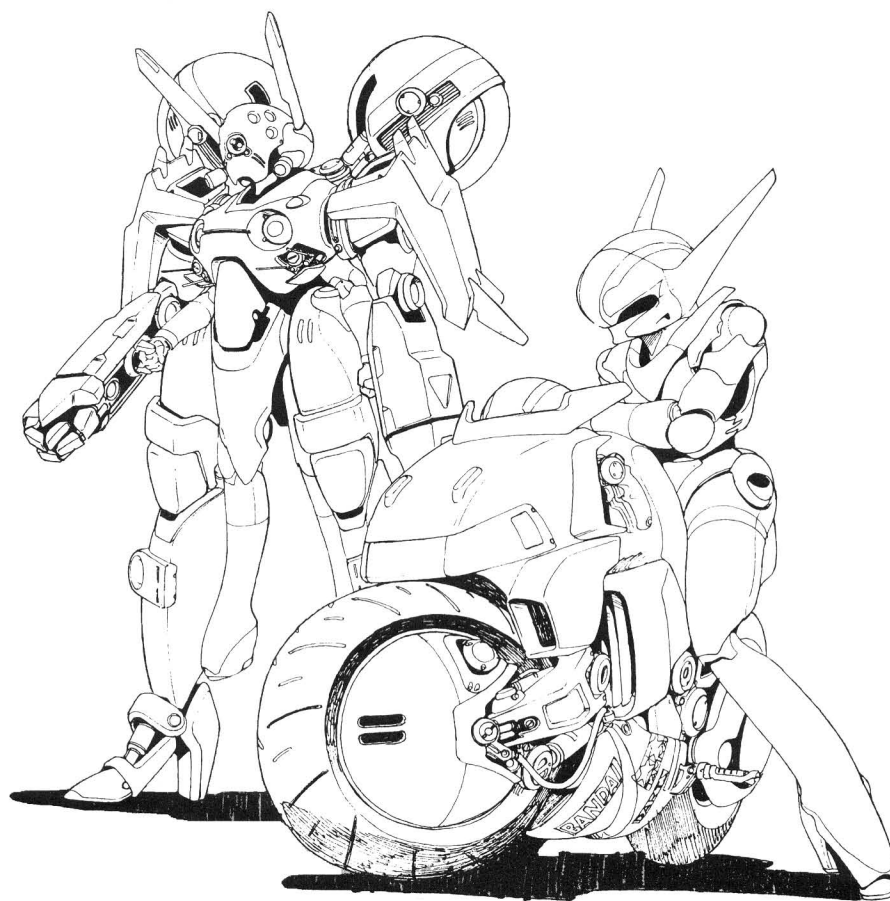

TEMPEST MOTORSLAVE

404 OP

WEIGHT	242 kg	STRENGTH	12
MODE	MANEUVER	SURFACE	FLIGHT
Motorcycle	-1	113 (340kph)	-
Motorslave	-3 Ref & Dex	30 (90kph)	93 (280kph)
Motoroid	*	30 (90kph)	93 (280kph)

*AI has INT, REF, DEX, & combat skills of 7. When under remote control, it uses Hardsuited operator's stats & skills at 1/2 their normal values.

2D6	LOC	KD	SDP	2D6	LOC	KD	SDP
3	Head	75	45	9/10	R/L Leg	75e	55e
4/5	R/L Arm	75e	50e	11	Wheel	60e	45e
6-8	Torso	75	90		Rotor	30e	22e

12. WEAPONS	WA	RNG	DMG	LOC	SPECIAL NOTES
HAND-TO-HAND	+0	-	7D6x4*	A,A	*Killing Damage
FOCUSED S.A.	+0	800m	6D6x6*	RW	*5m area, shock, warmup 1.
ALL-RANGE S.A.	+0	800m	6D6x3*	RW	*360°, shock, warmup 3.

Note that an All-Range Saber Attack will do full damage to *any* and *all* electronic devices and machines within 800m of the Tempest! (Except itself.)

SUBSYSTEMS: As per Tornado (see opposite page), plus: 50km Sensor Range, Orbital Comm Range • Rank-7 Anti-Missile, Anti-Radar, Anti-Sensor ECM (500m radius) • 1000km Radar • Hypersensors (+3 Perception) • Target Analyzer.

Note: On Hit Location Roll of 2, the Motorslave's operator is hit in an unprotected area (i.e., arm or leg). For Torso hits, damage faces 'Slave's Torso KD, then SDP, then operator's Hardsuit.

▼TEMPEST MOTORSLAVE

Much like the Typhoon II and the Tornado, the Tempest is a specialized Motorslave designed for use with the new Hardsuits. Made for Nene, the Tempest can be seen here along with Priss and her precious Typhoon II in all its motorcycle-mode glory—one has to wonder whether the stickers on the bike signify Priss' personal taste, or a requirement by the bike's sponsors. Hmm... .

The Tempest uses a more conventional layout than the Tornado; the operator's arms and legs control the Motorslave's limbs from the outside. It is also the slowest and least maneuverable of the Motorslaves, as suits Nene's standard tactics of standing back to perform sensor scans, maintain communications, and engage in electronic warfare. To this end, the Tempest has extensive communications and electronic warfare systems, primarily housed in the wheel sections which project from the back in Motoroid & Motorslave modes.

The front wheel section possesses most of the Tempest's jamming and sensing abilities. A variable unipulse/phased-array radar system and a high-powered ECM/ECCM suite are integrated into the tire's housing, supplementing the assorted sensors and communicators in the head and chest modules.

The rear wheel section houses a high power output Pulse Striker-like system. This device can unleash a "Saber Attack" which can completely incinerate any regular Boomer within an 800 meter radius! By increasing the directivity, an even more powerful Saber Attack can be released. This unique feature makes the Tempest the only Knight Saber Motorslave with any built-in weapons.

Sylia's Motorslave has yet to be completed, but it would seem that the plan is to modify the *Hurricane I* even more outrageously....



SEE THE BACK COVER OF THIS BOOK FOR A LARGER, COLOR VERSION OF THIS IMAGE.

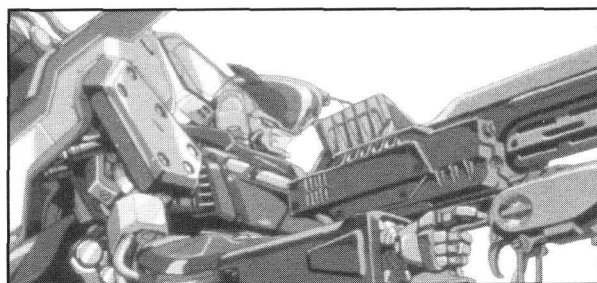
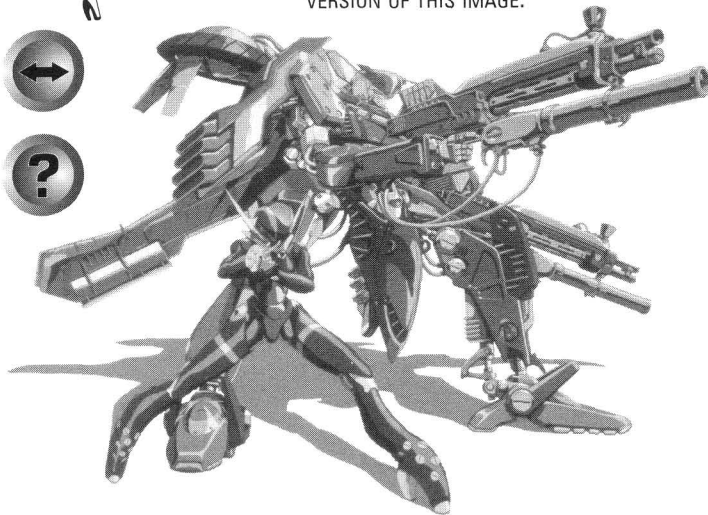
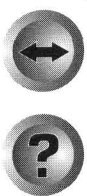

▼ SUPER TYPHOON II

Never one to settle for being part of the crowd, Priss insisted on yet another power-up for her Motorslave—she *is* supposed to be the Knight Sabers' assault specialist, after all.... After using various methods to persuade Mackie, Priss got her wish in the form of the Super Typhoon II.

This new form is actually a package of enhanced parts and weaponry which can be attached to the Typhoon II to increase its deadliness in combat (although the Super parts make it impossible to transform into Motorcycle form). The Typhoon II's Super parts begin with oversized shoulder-shields, which house improved radiators and power-boosters which support the other Super systems. Also included are a set of wings (to stabilize flight while carrying all the Super parts), an armored pod over the crotch area (which contains enhanced ECM systems and a 6-shot grenade launcher), and new handweapons. Replacing the standard 35mm handcannon are a pair (!) of camera-aimed 40mm machine cannons with underbarrel 115mm rocket launchers, giving the Super Typhoon II more firepower than any other Knight Saber weapon.

SUPER TYPHOON II						+137 OP	
WEIGHT	+90.5kg		TOTAL	368.5 kg			
MODE	MANEUVER	SURFACE		FLIGHT			
Motorslave	-3 Ref & Dex	27 (82kph)		79 (238kph)			
Motoroid	*	27 (82kph)		79 (238kph)			
WEAPONS	WA	RNG	DMG	LOC	SPECIAL NOTES		
SHIELDS (x2)	-	-	120KD	A,A	Defense Ability -3.		
40MM M.C. (x2)	+1	1.6km	8D6x3*	H,H	*AP, ROF8, 5 bursts.		
115MM ROCKET (x2)	-2	1.6km	4K	"	20m blast, 1 shot.		
GRENADES	-1	1.6km	14D6	T	10m blast, 6 shots.		
SUBSYSTEMS: Rank-7 Anti-Missile ECM • Super parts can be jettisoned instantly, returning all stats to those of normal Typhoon II.							

▼ TYPHOON X

This Motorslave variant's technology and design are based on the Typhoon II, but its physical layout is like that of the Typhoon I—that is to say, the Hardsuited rider's arms are outside the chassis, operating the mecha's arms by external controls. This frees up space in the chest for a pair of autoloading grenade launchers, supplementing the modest firepower of the Typhoon X's handheld sub-machine cannon. The Typhoon X is also slenderer, and thus lighter, than the Typhoon II. The slimmer legs have the consequence of reducing the size of the fuel tanks, but the saved mass balances out overall.

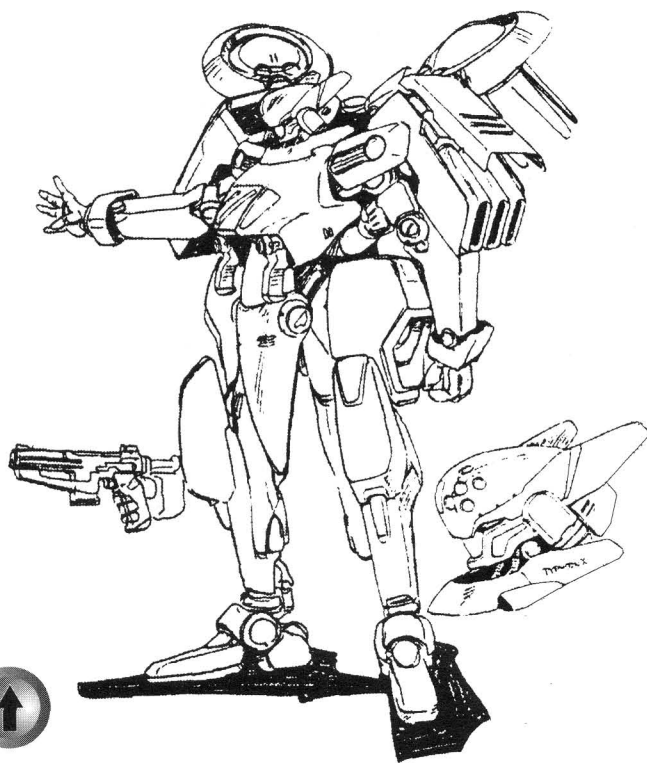

TYPHOON X						252 OP	
WEIGHT	242 kg		STRENGTH		12		
MODE	MANEUVER	SURFACE		FLIGHT			
Motorcycle	-1	125 (300kph)		-			
Motorslave	-3 Ref & Dex	30 (90kph)		92 (275kph)			
Motoroid	*	30 (90kph)		92 (275kph)			
*AI has INT, REF, DEX, & combat skills of 5. When under remote control, it uses Hardsuited operator's stats & skills at 1/2 their normal values.							
2D6	LOC	KD	SDP	2D6	LOC	KD	SDP
3	Head	75	45	9/10	R/L Leg	75e	55e
4/5	R/L Arm	75e	50e	11	Wheel	60e	45e
6-8	Torso	75	90		Rotor	30e	22e
12. WEAPONS	WA	RNG	DMG	LOC	SPECIAL NOTES		
HAND-TO-HAND	±0	-	2 K	A, A	Killing damage.		
35MM SMC	±0	400m	20D6	hand	API, ROF5, 3 bursts.		
GRENADE LNCHRS	-2	400m	14D6x2	T	20m blast, 6x2 shots.		
SUBSYSTEMS: Same as Typhoon II (see BGC RPG p85).							

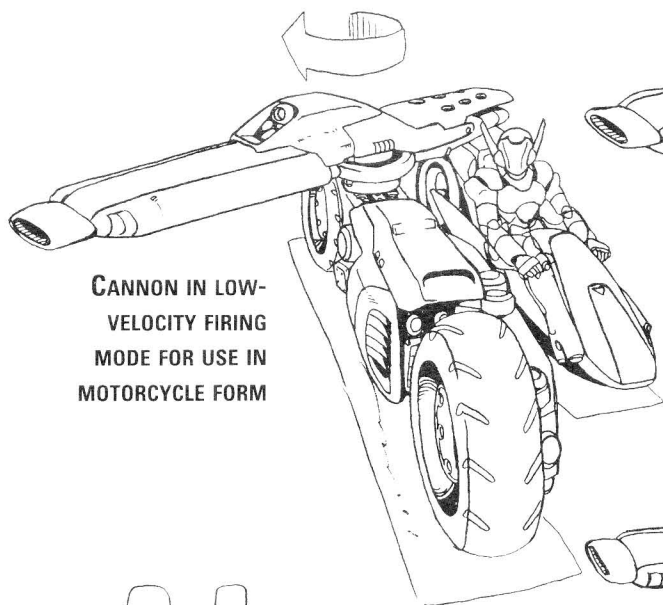

CANNON IN LOW-VELOCITY FIRING MODE FOR USE IN MOTORCYCLE FORM

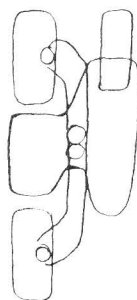
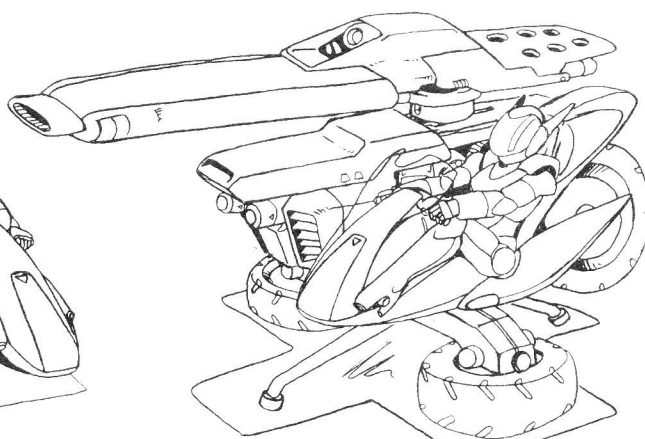

TOP VIEW OF MOTO-LAUNCHER'S CHASSIS, SHOWING DRIVE WHEELS & SUPPORT BOOM

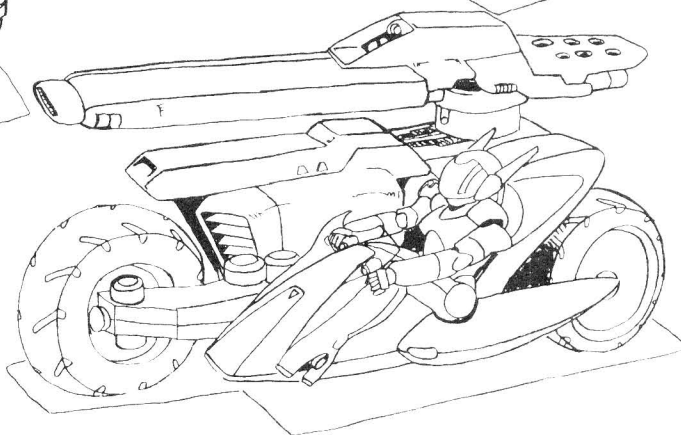

MOTO-LAUNCHER **53 OP**

WEIGHT	620 kg	SPACE	1 driver
MANEUVER	-3 REF	MOVE	100 (300kph)

ID10	LOCATION	ARMOR	STRUCTURE
1-4	Chassis	75 KD	120 SDP
5-6	Cannon	75 KD	80 SDP
7/8	Sidecar/Driver	75 KD	40 SDP
9	F/R Wheel	50 KD each	30 SDP each
10	Sidecar Wheel	50 KD	20 SDP

WEAPON	WA	RNG	DMG	LOC	SPECIAL NOTES
NORMAL MODE	+0	2.2km	7D6x4*	T	*AP, 50 shots.
ARTILLERY MODE	+2	4.5km	10K*	T	*AP, 50 shots.

SUBSYSTEMS
• High-intensity headlight.
• Sidecar driver's position.
• Onboard sensors with 5.5km target-acquisition range and 900km communications range.
• 360°-rotating gun turret.
• Transformation: The process of transforming takes 1 Action, and motorcycle must not be moving. In Artillery Mode, entire motorcycle transforms into a stationary unit which cannot move except to rotate its turret (so MV is not an issue), but the gun's damage and accuracy increase dramatically.

▼MOTO-LAUNCHER

This new design grew out of Sylia's Hardsuit/Motorslave integration project; her experiments with more powerful and higher-speed hardsuits freed up the basic shape of a full-size motorcycle, which she endeavored to use as an extra-heavy weapons platform.

Following that concept, the Moto-Launcher is a heavy-duty motorcycle with a massive gun turret mounted atop the main chassis. The gun turret is a dual-mode massdriver; in normal mode, the gun acts as a basic gauss weapon, firing explosive projectiles at a power level low enough to be employed while moving. However, if the Moto-Launcher transforms to artillery mode, the massdriver can fire its shells at over 10km/second, delivering enough impact to destroy almost any conceivable target. The fairing is packed with fuel cells and recoil compensators, and the massdriver is so large that it had to be placed on the main body of the motorcycle. Consequently, the driver actually sits in the bike's sidecar!

Fearing that this machine would be too destructive a weapon even for the Knight Sabers, Sylia decided not to build the Moto-Launcher (much to Mackie's disappointment). Still, she did include blueprints and specifications in the regular data-updates she has sent other Stingray vigilante groups around the world, so units like this one will most likely show up somewhere, sometime....

Anime Notes: Mr. Akutsu made many rough sketches of this "problematic" transforming bike, but as a former employee at a toy design company, his designs all lend themselves to being made into toys or model kits. Perhaps this is why the Moto-Launcher concept remained just a bunch of rough sketches and never appeared in the actual *Bubblegum Crash!* OVAs.

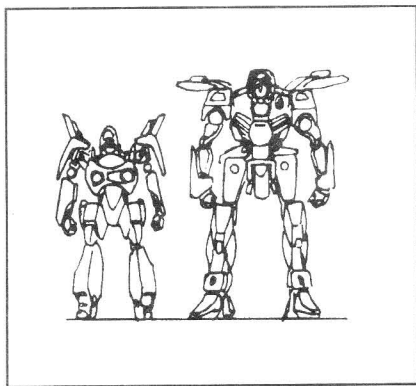

HEIGHT COMPARISON OF THE
TYPHOON I MOTORSLAVE AND
THE HEAVY MOTORSLAVE:
2.21M VS 3.5M

AUTOLOADING ASSAULT CANNON
WITH UNDERSLUNG 140MM RIFLE
ASSAULT WEAPON

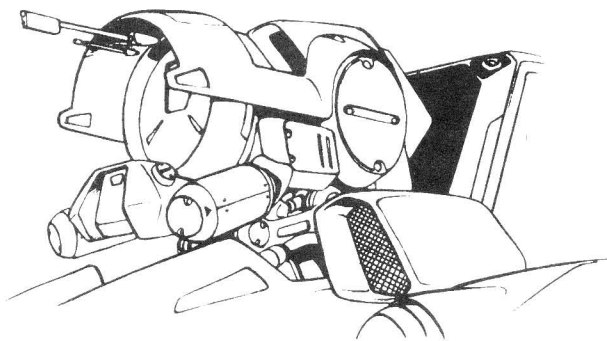
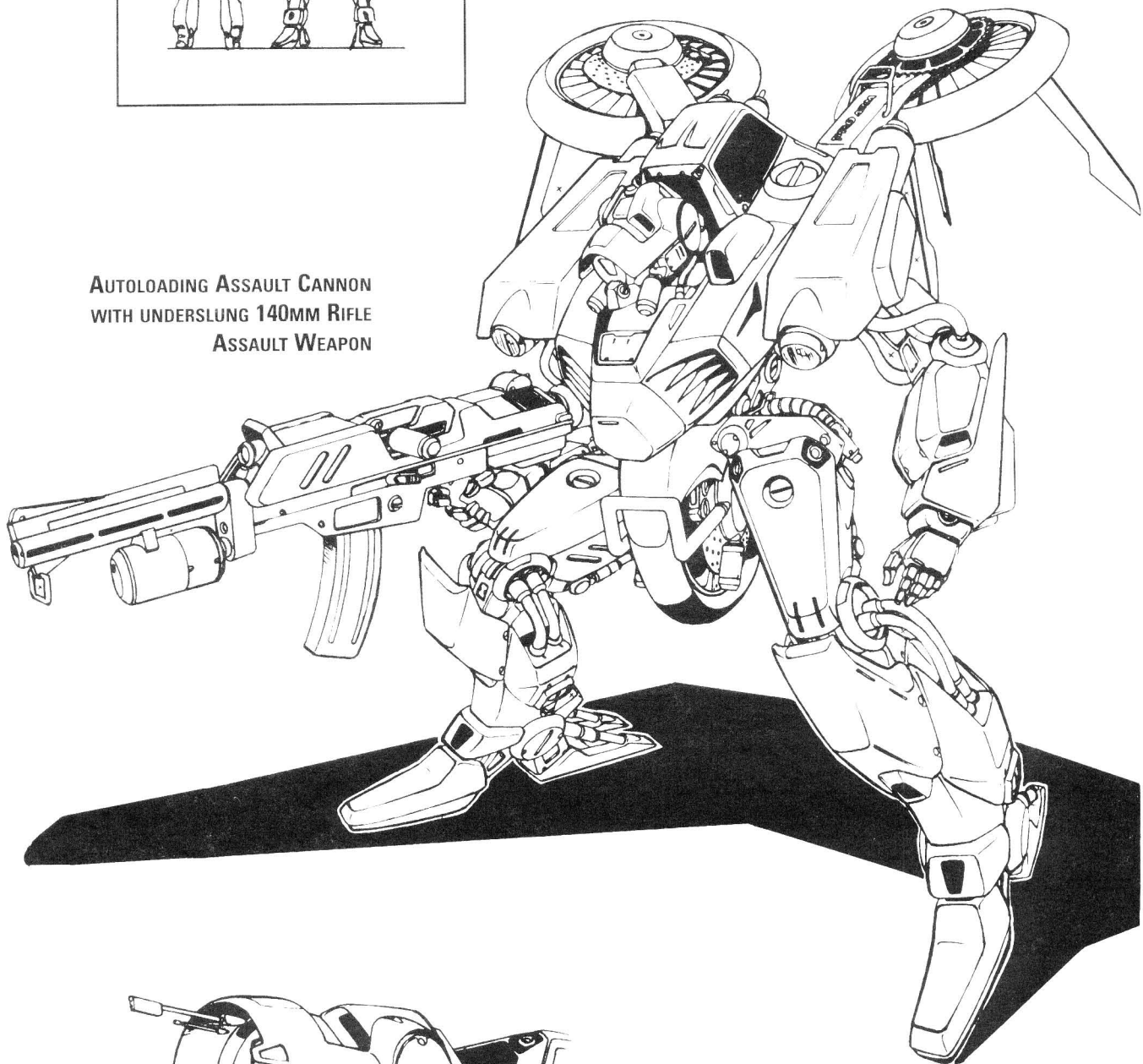

HEAVY MOTORSLAVE HEAD
ASSEMBLY: NOTE PROMINENT
AIRSPEED SENSOR PROTRUDING
FROM THE SENSOR TURRET.

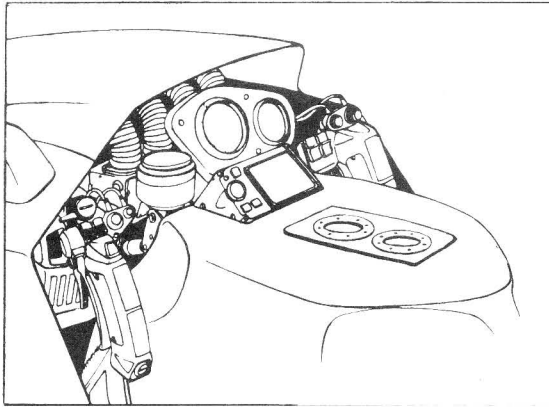

SPONGE-MOUNTED INSTRUMENTATION DISPLAY OF HEAVY MOTORSLAVE IN MOTORCYCLE MODE.

MASSIVE MOTORCYCLE MODE OF HEAVY MOTORSLAVE. PRISS IS WEARING HER HARDSUIT, BUT SUCH ARMOR IS NOT NEEDED TO RIDE THE HEAVY MOTORSLAVE.

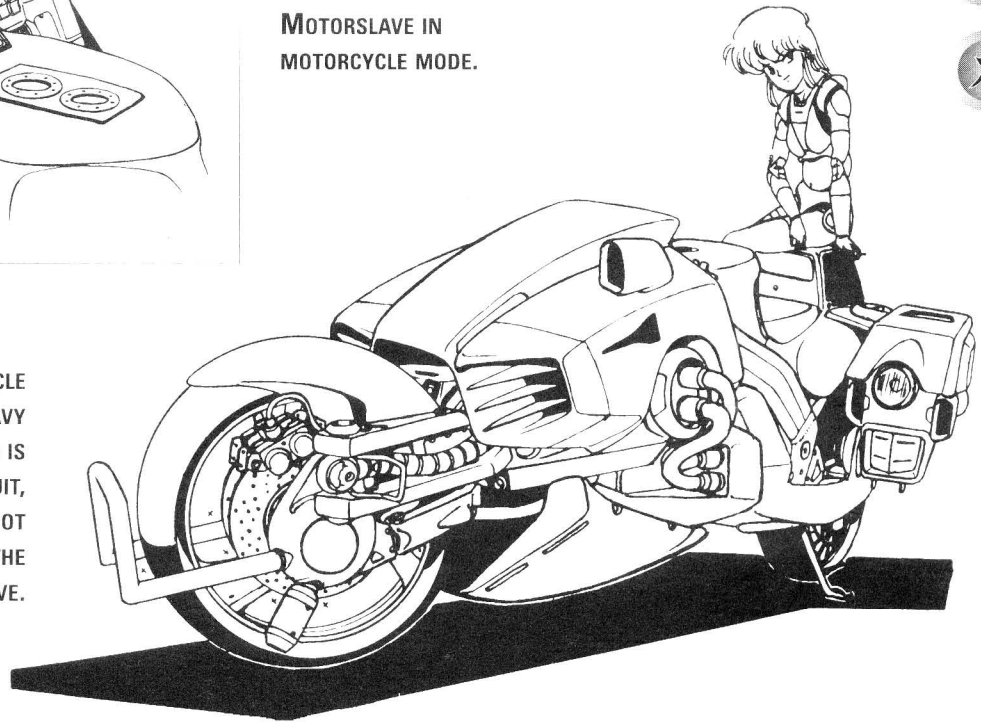

HEAVY MOTORSLAVE				303 OP			
WEIGHT	395 kg			STRENGTH	13		
MODE	MANEUVER	SURFACE		FLIGHT			
Motorcycle	-2	125 (374kph)		-			
w/ Boosters	-3	151 (454kph)		-			
Motorslave	-4 Ref & Dex	36 (108kph)		79 (238kph)			
Motoroid	*	36 (108kph)		79 (238kph)			
*AI has INT, REF, DEX, & combat skills of 5. When under remote control, it uses Hardsuited operator's stats & skills at 1/2 their normal values.							
2D6	LOC	KD	SDP	2D6	LOC	KD	SDP
2	Head	75	45	9/10	R/L Leg	75e	55e
3/4	R/L Arm	75e	50e	11	Wheel	60e	45e
5-8	Torso	75	90		Rotor	30e	22e
12. WEAPONS	WA	RNG	DMG	LOC	SPECIAL NOTES		
HAND-TO-HAND	±0	-	3 K	A, A	Killing damage.		
ASSAULT CANNON	+1	2.2km	7D6x6*	hand	*AP, 10 shots.		
w/ 140mm RAW	-2	400m	4 K*	"	*AP, 15m blast, 1 shot.		
SUBSYSTEMS: Sensor Turret (7km audiovisual, scrambled 100km radio, stereo, targeting, low-light vision & HUD (+2 Perception) • ECCM (Rank 6) • Two headlights • Transformation: Rear wheel splits into hover-rotors. • Ejection system blows operator out of top • Styling (+1 PRE) • Mount for using weapon in 'cycle mode • Nitro Boosters: Boost bike's speed & reduces Maneuverability for 10 Phases (30 seconds). • Fusion-proof armor. • Note (Torso hits): Damage which penetrates KD is applied to Torso SDP; remaining damage goes on to operator.							

▼HEAVY MOTORSLAVE

While the Knight Sabers were busy tracking down the mysterious "vampire murderer", Mackie skipped *BGC 5* to repair and remodel the Highway Star (which Priss had callously scrapped during the chase of Gibson's Griffon cybermonster). With the aid of Doctor Raven, Mackie used the rebuilt Highway Star to design a new prototype Motorslave whose unique gimmick was that it could be ridden by anyone. Dubbed the "Heavy Motorslave", this transformable Highway Star-type bike fully encloses its rider inside the motorslave's torso, so a Hardsuit isn't necessary to ride it. Even in motorcycle mode, the fairing is completely armor-plated (unlike the Highway Star).

Because of the large size of the bike, its transformation is quite different from that of a typical Motorslave; generally, the entire transformation process is reversed. To begin with, it is the rear tire—not the front one—which splits into the two hover-rotors. Also, the under-cowling becomes the knee sections and the left and right boosters form the shoulders and arms. As with previous Motorslaves, the head appears from beneath the windscreen (this sensor turret is self-explanatory, a miscellaneous but necessary device).

The bike's sponge-mounted instrumentation console, cannibalized from an HS-130, is also noteworthy. On the left of the display are a callus and a thermometer which measures the engine's water temperature; on the right is the booster meter; the speedometer display is centralized. Upon transformation, an assortment of other gauges appear.

The Heavy Motorslave's main weapon is a semi-automatic Assault Cannon with a single-shot rocket launcher slung under the barrel—this 140mm RAW (Rifle Assault Weapon) has a minimum range of 10m, but it packs the firepower equivalent of a 90mm recoilless rifle. The gun can be used when in Motorcycle mode if it is be mounted on the right or left booster.

Specifications: Slave Height 3.50m, Cycle Length 3.15m, Dry Weight 395kg, Max Power 148ps/7500rpm, Max Torque 16.5kg-m/4500rpm.



BUBBLEGUM CRISIS EX – THE EXTREME EXPANSION FOR BUBBLEGUM CRISIS

KNIGHT SABER TECH 2034

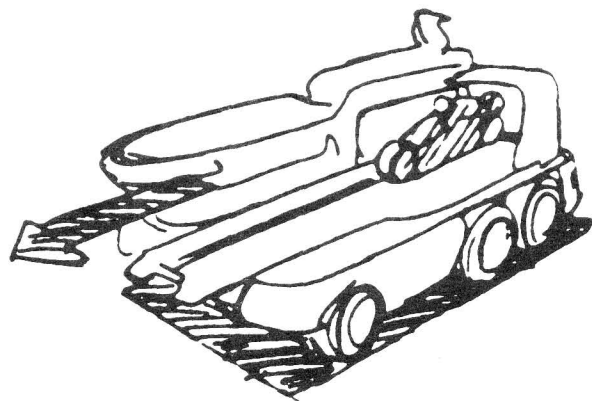
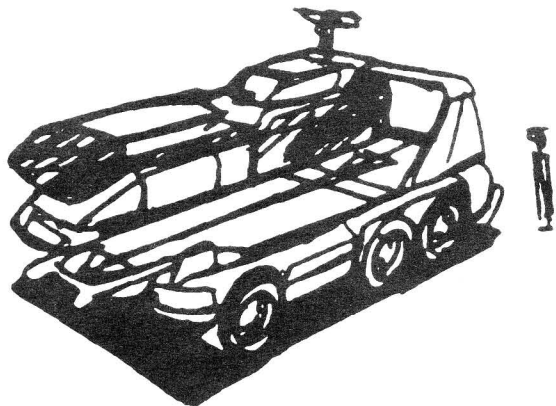

▼LAND CRUISER

This is another proposed vehicle which Sylia never built despite Mackie's begging and pleading: a six-wheeled mobile base with a motorcycle-launching deck, much like a roadfaring aircraft carrier! Capable of carrying up to six bikes, the Land Cruiser is not armed, but it is equipped with a myriad of sensor, communications, surveillance, and ECM/ECCM systems. Its armor is equivalent to that of a tank, ensuring the safety of the vigilantes' motorcycles, and its enormous engine grants it impressive speed. It is not, however, the most subtle of vehicles and would require some kind of secret, out-of-town garage facility, which is why Sylia never had it built (although she did include it in her data updates).

Anime Note: As another design drawn by Mr. Akutsu, the Land Cruiser is somewhat more toylike than many other Knight Sabers vehicles, which may explain why it never appeared in the *Bubblegum Crash!* OVAs—but that doesn't mean that *you* can't use it!

LAND CRUISER

24 OP

WEIGHT	15.5 tons	SPACE	1 driver, 7 passengers
MANEUVER	-4 Ref	MOVE	32 (95kph)
1D10	LOCATION	ARMOR	STRUCTURE
1-8	Chassis	4 Kills	4 Kills
9-10	Wheels (6)	1 K each	20 SDP each

SUBSYSTEMS: Launch Deck with pneumatic catapult • Hangar bay (room for 6 bikes) • 50km Radar • Scrambled 100km radio, multi-sensor package • Rank-7 ECCM system • Rank-3 Anti-Missile, Anti-Sensor, Anti-Radar ECM system • Combat data center with POW-6 computer.

▼DATA UNIT

This is a multiple-access media package which uses foamed-matrix holographic memory for hard storage, and was used by Dr. Stingray to transmit his precious data to Sylia. Now, in the 2030s, Sylia uses these data units to transmit *her* data to other high-tech vigilantes around the world. As she, Dr. Raven and Mackie work on new technological innovations for the Knight Sabers, the data is written to new data units which are sent by courier to cities across the globe. Numerous transfers, exchanges, and other secretive methods are used to ensure the security of the data units. They can be played on any standard higher-end desktop computer system—although the systems needed to actually construct the mecha detailed in the data unit are much more complex!

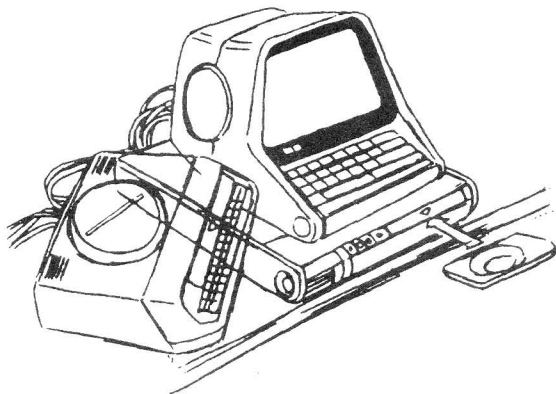
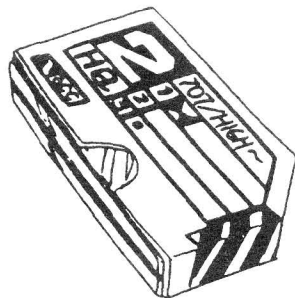

DATA UNIT & DRIVE

¥1,000,000

POWER RATING	6	USER BONUS	+2
SIZE	25cm x 33cm x 42cm	WEIGHT	11 kilograms
ITEM	KD	SDP	COST
DATA UNIT	15KD	5 SDP	¥1 million
DRIVE	5KD	15 SDP	¥10,000

SUBSYSTEMS

• Data Unit is protected against magnetism & EMP, is impact-resistant, and is sealed against water and other contaminants.



NEW BOOMERS

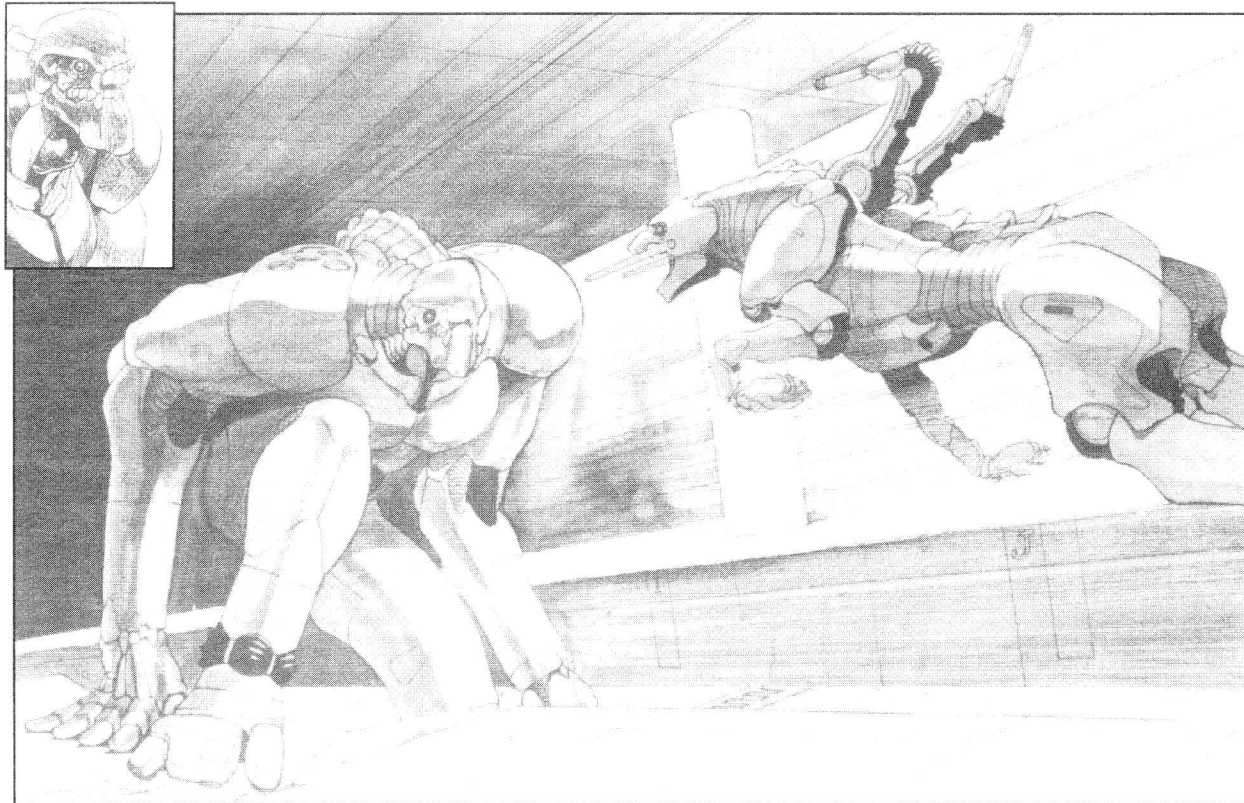

▼BOOMER GOLEM

This hulking cyberdroid is an early version of the Boomer Giant, which was co-produced by Genom and Gulf & Bradley (see *BGC* p.107). Several Boomer Golems were made, but the third prototype ("Proto-X3") escaped from its holding facility and ran loose through MegaTokyo's cavernous network of subway, maintenance, and sewer tunnels. Proto-X3 was eventually recaptured with the help of a team of BU-K9s, but the other prototypes are still in Genom's hands—although whether they were mothballed or are still active is anybody's guess....

BOOMER GOLEM					
WEIGHT	6633 kg		TYPE	Experimental	
ARMOR	90 KD		RUNNING	20 (60 kph)	
STRUCTURE	175 SDP		FLY/SKIM	-0-	
REF	7	INT	1	AI RATING	Level 4
DEX	7	PRE	3	SKILLS	+4*
STR	15	WILL	5	BODY	35
MOVE	20	TECH	1	RECOVERY	30/day
WEAPONS	WA	RNG	DMG	LOC	SPECIAL NOTES
HAND-TO-HAND	+0	-	15D6*	Arms	*i.e., 2K Killing.
SUBSYSTEMS:					
• Optics with targeting, lowlight & IR functions.					
• Scrambled radio (200km range).					
• Biological construction; no Fusion, REC limited to 30/day.					
• Note: Human-size attackers can make called shots to chinks in the armor at -4; success bypasses armor completely.					

▼BU-K9

This is a specialized cyberdroid whose structure is based on canine anatomy. As a border patrol and hunter/pursuer type, its head is equipped with high-definition olfactory sensor antennae, its back is fitted with two boom-mounted laser guns, and its quadrupedal form gives it an exceptionally high ground speed. When Proto-X3 escaped into MegaTokyo's subways, BU-K9s were instrumental in finding the rogue Golem. BU-K9s are excellent sellers, but rumor has it that Genom is experimenting with building satellite-control Black Boxes into disguised BU-K9s....

BU-K9					
WEIGHT	88.78 kg		TYPE	Combat	
ARMOR	40 KD		RUNNING	56 (168 kph)	
STRUCTURE	40 SDP		FLY/SKIM	-0-	
REF	8	INT	1	AI RATING	Level 4
DEX	9	PRE	2	SKILLS	+4*
STR	9	WILL	3	BODY	8
MOVE	56	TECH	1	RECOVERY	18/t
WEAPONS	WA	RNG	DMG	LOC	SPECIAL NOTES
HAND-TO-HAND	+0	-	9D6*	Jaws	*Killing damage.
LASER GUN	+1	325m	6D6x3*	T	*ROF=20, X-Link.
LASER GUN	+1	325m	6D6x3*	T	*ROF=20, X-Link.
SUBSYSTEMS: Optics (targeting, lowlight & IR) • Olfactory antennae (scent-tracking system; +4 Perception). • Scrambled 100km radio. • Limited Fusion ability (~22kg), canine disguise ability (Perception vs 20 to detect); must burst out to deploy weapons.					

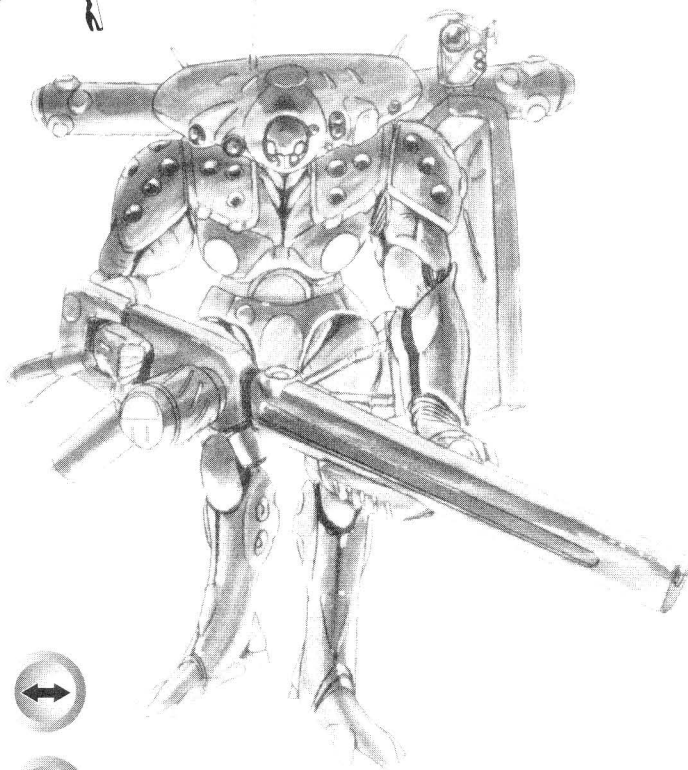

▼BU-12B COMMANDO TYPE

The 12-B is one of Genom's best sellers, and can serve a variety of functions. Seen here is a 12-B fitted with multi-role Commando-type equipment, which is designed to be used against almost any opponent, under almost any circumstances. The Commando type has a multisensor attached to its left balancer pod, a blastproof antiballistic shield mounted on its left shoulder, and hands on both arms so that the boomer can carry a variety of firearms (such as the smartgun shown here).

BU-12B COMMANDO TYPE					
WEIGHT	1879 kg	TYPE		Battle	
ARMOR	60 KD	RUNNING		12 (36 kph)	
STRUCTURE	100 SDP	FLY/SKIM		8 (126kph); 1/∞	
REF	7	INT	3	AI RATING	Level 6
DEX	6	PRE	6	SKILLS	+6
STR	12	WILL	9	BODY	20
MOVE	12	TECH	5	RECOVERY	20/t
WEAPONS	WA	RNG	DMG	LOC	SPECIAL NOTES
HAND-TO-HAND	+0	-	12D6*	Arms	*Killing damage.
SMARTGUN	+1	850m	7D6x4*	2H	*A-P, 11 shots.
SHIELD	*	-	150KD	L.Shldr	*DA = -3.
SUBSYSTEMS: Flightjets in thighs & back • Twin balancer pods (20h each) • Optics w/ targeting, lowlight & IR • Multisensor (thermograph, motion sensor, metal detector) • Rank-3 ECM & ECCM • 500km scrambled radio • 2 Smartgun reloads in hip pack • Limited Fusion (~475kg).					



▼BU-12B ANTI-TANK TYPE

Since the 12-B was originally developed to fight main battle tanks, the model which appeared in *BGC3* could actually be considered a lightly-armed version! The anti-tank 12-B's main weapon is a 125mm cannon (fitted to the right arm) which can kill any MBT on the battlefield with one shot. In addition, the 12-B is equipped with twin missile pods on its back. One pod loads 9 aerial missiles, the other 9 ground missiles, allowing it to defeat almost any opponent. The 12-B's shoulders also mount a minigun and automatic grenade launcher for anti-personnel use.

BU-12B ANTI-TANK TYPE					
WEIGHT	2865 kg		TYPE		Battle
ARMOR	60KD	SDP	100 Hits	RUN	9 FLY/SKIM -0-
INT	3	PRE	6	WILL	9 TECH 5 REF 7 DEX 6
MV	9	STR	12	BOD	20 REC 20/t AI Lvl 6 SKILL +6
WEAPONS	WA	RNG	DMG	LOC	SPECIAL NOTES
HAND-TO-HAND	+0	-	12D6*	Arms	*Killing damage
125MM GUN	+1	1.5km	5K*	R.Arm	*A-P; 4 shots.
AAMs	±0	1km	2K*	R.Pod	*9 shots, Brilliant (<i>BGC</i> p.49)
SSMs	+3	1km	2K*	L.Pod	*9 shots, blast 10m.
AUTO G.L.	±0	300m	8D6*	R.Shldr	*Blast 8m, ROF 15, 3 bursts.
MINIGUN	-1	300m	7D6*	L.Shldr	*ROF 300, 5 bursts.
SUBSYSTEMS: Shielded optics with targeting, lowlight & IR • Rank-3 ECM/ECCM Suite • 500km scrambled radio • 16km monopulse radar • 3 extra reloads for 125mm gun stored on left hip • Limited Fusion ability (up to 716kg).					



▼BU-12B RECONNAISSANCE TYPE

The R-type is designed to work with surveillance satellites to survey and evaluate bombing sites in enemy territories. By providing trajectory information, it can precisely coordinate artillery strikes. Seen here attended to by an M262.

BU-12B RECONNAISSANCE TYPE											
WEIGHT		1766 kg		TYPE			Battle				
ARMOR		60KD	SDP	100 Hits	RUN		12 (36kph)	FLY/SKIM		-0-	
INT	3	PRE	6	WILL	9	TECH	5	REF	7	DEX	6
MV	12	STR	12	BOD	20	REC	20/t	AI	Lvl 6	SKILL +6	
WEAPONS		WA	RNG	DMG	LOC	SPECIAL NOTES					
HAND-TO-HAND		+0	-	12D6*	Arms	*Killing damage					
SUBSYSTEMS: Shielded optics with Targeting, lowlight, & IR • Rank-4 ECM & Rank-7 ECCM Suite • Satellite datalink • Target Analyzer • Mast-mounted lowlight/IR optic periscope • Encrypted communications with effectively unlimited range • Limited Fusion (~442kg).											

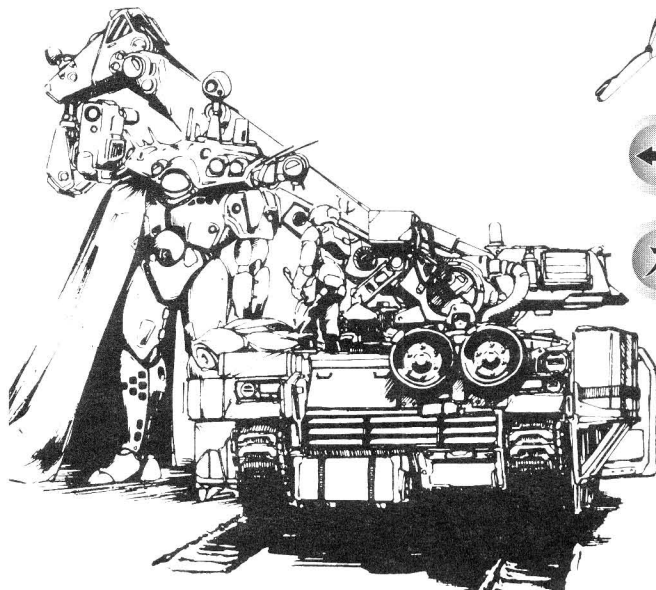

▼BU-12B INFANTRY TYPE

This version of the 12-B (seen here with an Israeli footsoldier) is equipped with a variety of light anti-bunker rockets on its left side, and a 5-shot smoke discharger on its right side, to provide cover for friendly soldiers. Both of its arms are equipped with hands so that it can carry firearms (such as the smartgun used by the Commando type) and can assist in combat engineering.

BU-12B INFANTRY TYPE											
WEIGHT		1782 kg		TYPE			Battle				
ARMOR		60KD	SDP	100 Hits	RUN		12	FLY/SKIM		42 (1/∞)	
INT	3	PRE	6	WILL	9	TECH	5	REF	7	DEX	6
MV	12	STR	12	BOD	20	REC	20/t	AI	Lvl 6	SKILL +6	
WEAPONS		WA	RNG	DMG	LOC	SPECIAL NOTES					
HAND-TO-HAND		+0	-	12D6*	Arms	*Killing damage					
SMOKE LNCHR		-2	-	*	R.Pod	*5 Perception in 20m radius; 5 shots.					
ROCKETS		-1	1km	2K	L.Side	4 shots (2 AP, 2 blast 20m).					
SUBSYSTEMS: Targeting, lowlight & IR • Flightjets & twin 20h balancers • Rank-3 ECM/ECCM • 500km scrambled radio • Limited Fusion (~446kg).											

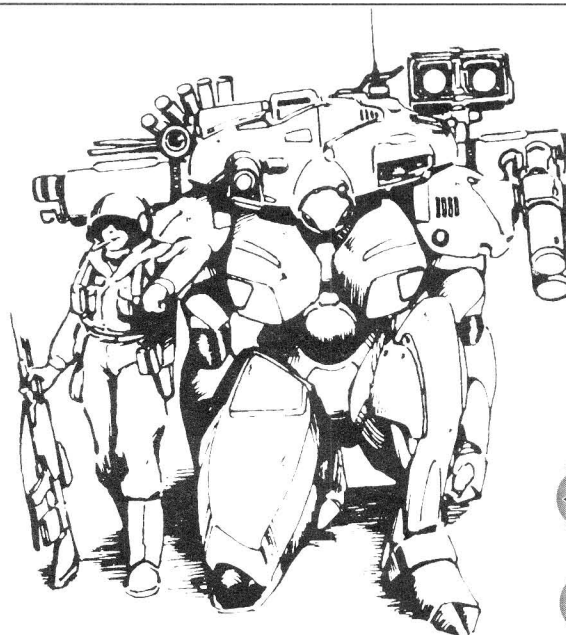

▼BU-12B AIR DEFENSE TYPE

This walking air defense battery is used against relatively low-flying aircraft. It is fitted with a backpack array (derived from the venerable German-made Gepard) which consists of a monopulse radar, a pair of belt-fed 35mm machineguns, and an ammo drum with 620 anti-aircraft rounds and 40 anti-armor rounds. The radar's range is about 16km, but its effective range is often limited by terrain to 5km.

BU-12B AIR DEFENSE TYPE											
WEIGHT		1872 kg		TYPE			Battle				
ARMOR		60KD	SDP	100 Hits	RUN		12 (36 kph)	FLY/SKIM		-0-	
INT	3	PRE	6	WILL	9	TECH	5	REF	7	DEX	6
MV	12	STR	12	BOD	20	REC	20/t	AI	Lvl 6	SKILL +6	
WEAPONS		WA	RNG	DMG	LOC	SPECIAL NOTES					
HAND-TO-HAND		+0	-	12D6*	Arms	*Killing damage					
35mm MGs		+2	-	8D6x2	Arms	ROF=27, 11 bursts.					
For X-Link, apply 8D6x2 twice. There's enough AP ammo for 1 paired MG burst.											
SUBSYSTEMS: Optics w/targeting, lowlight & IR • 16km Radar • Rank-3 ECM/ECCM • 500km scrambled radio • Limited Fusion (up to 468kg).											

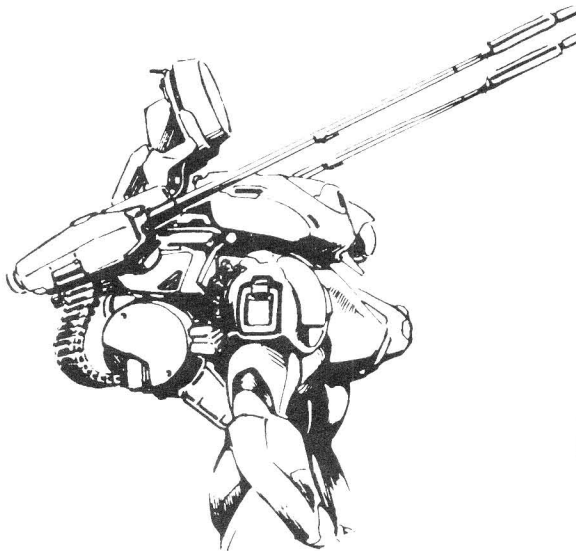

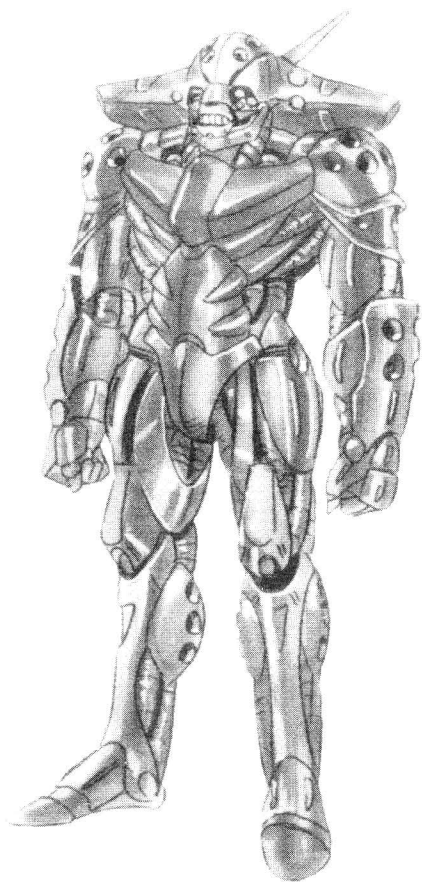

▼BU-96C RECON BOOMER

This Combat Boomer is derived from the infamous Bu-55C, but in order to better perform search-and-destroy missions, its head section has been expanded to accommodate a reinforced enemy search system. This extra-sensitive sensor array includes ground pressure measurers, motion detectors, phased-array radar, laser sensors, and a target analyzer (see *BGC* p50). Due to its unorthodox silhouette, it's impossible for the 96-C to adopt a human disguise.

BU-96C					
WEIGHT	623 kg	TYPE	Combat		
ARMOR	45 KD	RUNNING	24 (72 kph)		
STRUCTURE	70 SDP	FLY/SKIM	48 (144kph); 2/∞		
REF	6	INT	3	AI RATING	Level 5
DEX	6	PRE	6	SKILLS	+5*
STR	11	WILL	5	BODY	14
MOVE	24	TECH	4	RECOVERY	22/t
WEAPONS	WA	RNG	DMG	LOC	SPECIAL NOTES
HAND-TO-HAND	+0	-	11D6*	Arms	*Killing damage.
BLADE WEAPON	+0	-	14D6	Arm	Weapon style varies.
MOUTH LASER	+0	800m	7D6x3	Head	-
HEAT CANNON	+0	725m	9D6x2	All	2.5m area, 2t warm-up.
SUBSYSTEMS: As per Bu-55C, but with advanced sensors including ground pressure measurers, motion detectors, phased-array radar, laser sensors, and target analyzer. Also, no disguise function.					

▼BUS-OA SPACE ASSAULT BOOMER

This was the first boomer designed specifically to engage in space battles. It is armed with a powerful 180cm-long railgun and twin laser beam guns, and is protected by a magnetic-coated shield which can reflect lasers and beam weapons. Its armor protection is also unusually high due to the inclusion of antiradiation layers. Standing 2.3 meters tall, it can't assume a human disguise, and in fact has largely done away with the pretense of maintaining a human form at all.

BUS-OA					
WEIGHT	1,241 kg	TYPE	Battle		
ARMOR	55 KD	RUNNING	8 (24 kph)		
STRUCTURE	85 SDP	FLYING	100 (Cumulative)		
REF	8	INT	3	AI RATING	Level 5
DEX	7	PRE	5	SKILLS	+5
STR	10	WILL	5	BODY	17
MOVE	8	TECH	2	RECOVERY	20/t
WEAPONS	WA	RNG	DMG	LOC	SPECIAL NOTES
HAND-TO-HAND	+0	-	10D6*	Arms	*Killing damage.
SHIELD	*	-	100KD	LA	*DA = -2.
RAILGUN	+1	-	8D6x3*	RA	*Armor-Piercing.
LASER BEAM GUNS	-1	-	6D6x3*	Torso	*Cross-linked;
X-Link means that damage is applied twice; ROF for each gun is ∞!					
SUBSYSTEMS: Thrusters & verniers • IR, radar & targeting optics • 200km radio • No disguise function • Limited Fusion ability (~310kg).					

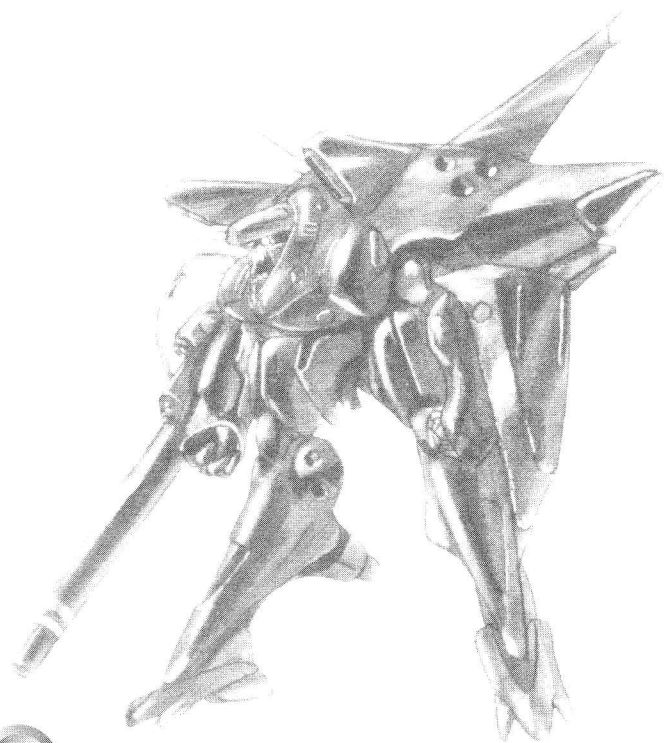



▼ DREADNOUGHT SPACE BOOMER

This huge, non-humanoid Boomer was developed for space combat, but only a few prototypes were ever constructed. Today, few even know of its existence. Mentally, the Dreadnought is a weakling, with a mind similar to that of a cat; it will savagely attack anything that doesn't emit a friendly IFF signal. Still, it's physically unstoppable; its outer armor is composed of ultra-compressed Abotex, and it is armed with two high-energy beam cannons which are mounted on wide-angle sub-limbs. To maneuver in space, the Dreadnought is equipped with a bank of thruster nozzles in its back and a cluster of zero-G balancers in its lower body. Still, its most remarkable feature is its ability to generate a spherical defensive barrier 6 meters in diameter! As it turned out, this self-defense mechanism was drastically overpowered; during a test, one boomer's barrier overloaded and caused the death of 12 people. It was this accident which ultimately relegated the Dreadnought to the status of a failed experiment.



HUMAN IN USSD K-12B
POWERED SPACE SUIT
FOR SCALE

DREADNOUGHT SPACE BOOMER					
WEIGHT	8273 kg		TYPE	Battle	
ARMOR	80 KD		RUNNING	-0-	
STRUCTURE	220 SDP		FLYING	125 (Cumulative)	
REF	6	INT	1	AI RATING	Level 4
DEX	4	PRE	3	SKILLS	+4*
STR	15	WILL	7	BODY	40
MOVE	0	TECH	2	RECOVERY	30/t
WEAPONS	WA	RNG	DMG	LOC	SPECIAL NOTES
HAND-TO-HAND	+0	-	15D6*	Arms	*i.e., 2K.
BEAM CANNON	+2	4km	7D6x6	R.SL	Linked to other.
BEAM CANNON	+2	4km	7D6x6	L.SL	Linked to other.
BARRIER SYSTEM: Provides 150KD vs energy attacks only. Once the barrier is penetrated, it is useless until repaired. Erecting it takes one action, which can be "Aborted" to (see <i>BGC</i> p.41). Every turn the barrier is used, there is a 1 in 10 chance it will overload, doing 36D6 at 6m & dropping off by 1D6 per meter beyond that.					
SUBSYSTEMS: 500km scrambled radio communications. • 500km radar. • Shieldable optics with targeting, lowlight & IR functions. • Rank-5 ECCM suite. • Zero-G balancer system. • Back-mounted thruster nozzle array. • Effectively no Fusion ability.					
*Related Skills include: <i>Perception, Zero-G Maneuver, Hand-to-Hand, Heavy Weapons, and Navigation.</i>					

▼ MINESWEEPER BOOMER

Remote-controlled, robotic, or otherwise unmanned devices are understandably perfect for clearing an area of mines, so in the 21st century, cyberdroids almost always get this unpopular job. Based on a cheap, mass-market lawnmowing type, this Boomer's large metal "rolling pin" is designed to detonate mines ahead of the minesweeper itself in the hopes that it will survive to sweep for more mines. The job is understandably unpopular, which is why simple lawnmower Boomers (with peabrained robotic AIs) are used for this purpose.

MINESWEEPER BOOMER

277kg; Labor-type; AI Level = 1

INT 1, TECH 3, WILL 0, PRE 0, REF 1, DEX 1, STR 5, BOD 5, MOVE 5.

All relevant Skills +1; KD 25, SDP 30, REC 0.

Systems & Notes: Solid alloy "rolling pin".

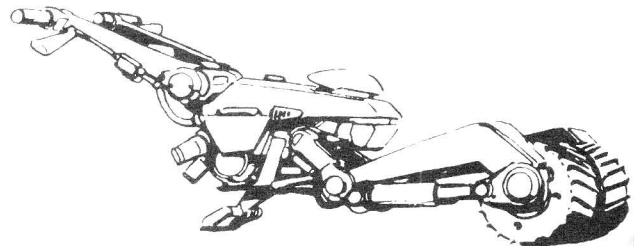

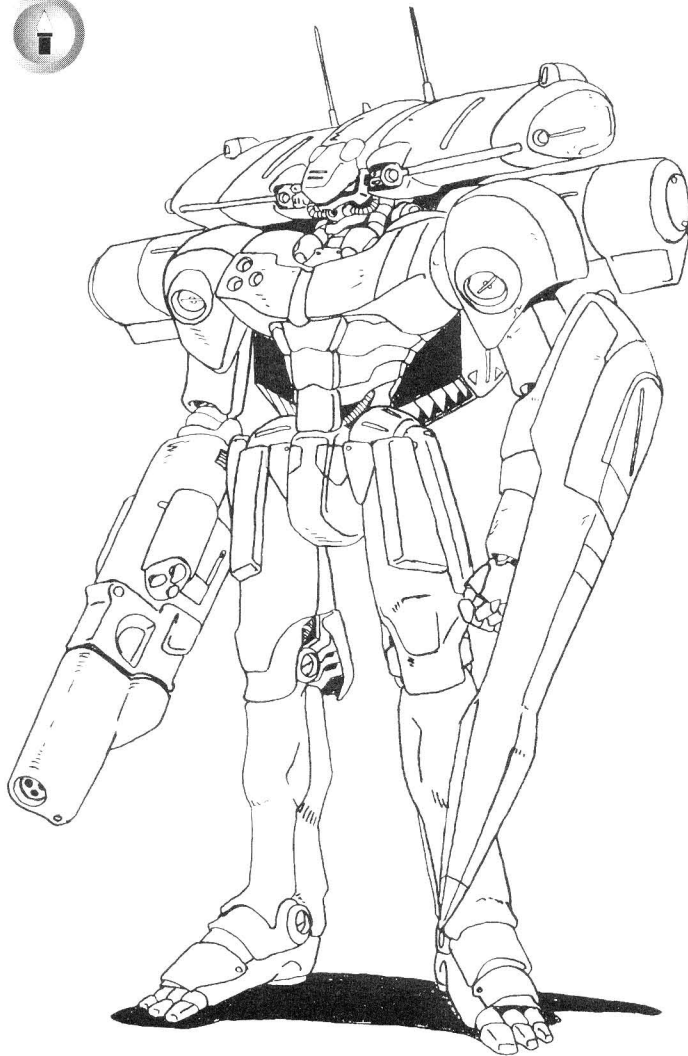

▼BU-15B GOBLIN

A military cyberdroid designed for urban combat, the 15-B is commonly seen in the war-torn streets of Eastern European cities. Since tanks and other large vehicles are ineffective in urban environments, the 15-B was not designed to fight heavily armored opponents. As a consequence, its standard armament package is relatively light—for a Battle Boomer. The right arm mounts a laser-aimed 10mm minigun and a short-barreled grenade launcher, good for use against personnel and small aircraft. The left arm serves as a close-combat system, sporting a composite-plated shield which aids in defense and whose tip is loaded with a magazine of sharpened, shaped-charge armor penetrators. This weapon is used to punch through a target's armor, leaving the explosive tip inside the target while the boomer retreats to a safe distance. Then... Boom. An oral cavity laser lens, the signature weapon of almost all boomers, is also included. For mobility, ducted flight jets are fitted into the backs of the knees, the backpack, and the twin balancer pods.

The 15-B's most impressive feature is its 3-D Magnetism Scanner. This unusual sensor system uses the metal skeletons of the buildings around it like a giant antenna, allowing the boomer to "read" the magnetic fields of the buildings and build a 3-D computer model of their interiors! Thus, the boomer effectively has "x-ray vision" into buildings (albeit in poorly-focused black and white). This system is currently unique to the 15-B, since problems have been associated with it; it renders the boomer highly vulnerable to electromagnetic attacks, and when "looking" inside a building, the 15-B goes into a sort of trance, becoming totally unaware of its own surroundings and thus highly vulnerable. For this reason, 15-Bs are almost always deployed in groups (some scan while others keep watch). Known on the battlefield as "Goblins," 15-Bs may be less powerful than most B-types, but they are nonetheless excellent for their designated purpose.

Anime Note: This was originally a rough design for the Advanced Battle Boomer which appeared in *Bubblegum Crash! 3: Meltdown*.

BU-15B GOBLIN

WEIGHT	820 kg	TYPE	Battle		
ARMOR	50 KD	RUNNING	18 (54 kph)		
STRUCTURE	90 SDP	FLY/SKIM	42 (126 kph); 2/∞		
REF	7	INT	3	AI RATING	Level 6
DEX	7	PRE	6	SKILLS	+6*
STR	12	WILL	6	BODY	18
MOVE	18	TECH	7	RECOVERY	24/t

WEAPONS	WA	RNG	DMG	LOC	SPECIAL NOTES
HAND-TO-HAND	±0	-	12D6*	A, A	*Killing damage.
SHIELD	*	-	70KD	LA	*Defense Ability -2.
BOMBER RAM	+1	-	7D6x4*	LA	*AP, 10 shots.
10MM MINIGUN	+1	300m	8D6*	RA	*AP, ROF50, 20 bursts.
GRENADES	-1	500m	14D6*	RA	*Blast 10m, 8 shots
MOUTH LASER	+0	700m	8D6x3	H	-

SUBSYSTEMS: Flightjets • Scrambled 500km radio. • Armored optics with targeting, lowlight & IR functions. • 3-D Magnetism Scanner (gives "X-Ray" vision through buildings, but puts Boomer into a trancelike state; -5 to defense). • ECM (anti-sensor, anti-missile, anti-radar) and ECCM suite (rank-4) • Limited Fusion ability; can absorb, control, and animate 205kg of mechanical material.
 *Related Skills include: *Perception, Athletics, Hand-to-Hand, Firearms, Heavy Weapons, Melee, and Demolitions.*



▼BU-17B HELLBENDER

The Hellbender is a military cyberdroid which combines aspects of Combat Boomers and Battle Boomers. Its size and shape preclude it from adopting a human disguise, but it has full amphibian capability; its dual-source propulsion systems can move it through air or water, giving it some modicum of infiltration ability. Effectively a SEAL (Sea, Air and Land) unit, it has a slightly higher intelligence than Battle Boomers so that it can act more autonomously in the field. Even so, Hellbenders lack conversational ability and have only the most minimal of personalities installed. This does not, however, reduce their viciousness in combat. In fact, 17-Bs seem to exhibit more hostility than normal battle boomers, and observation (from a safe distance) has led to the theory that they actually take pleasure in fighting and killing.

Standing 2.37 meters tall, the Hellbender is somewhat less armor-laden and firepower-heavy than an anti-tank boomer. Its forearm hard-points normally mount a gatling gunpod for anti-personnel use and a dual-barrel subroc launcher (which can be used underwater, above ground, and can even fire from underwater at above-surface targets). In addition, scythe-like blades on the feet serve to destroy obstacles like barbed wire and other mantraps, and the Boomer's mouth sports the typical oral-cavity laser lens. The head is also packed with ECM equipment and reconnaissance systems. While 17-B's are not fusion-proof, and their neural software displays some vulnerability to viruses (probably due to their higher intelligence), their own fusion abilities are significant, equivalent to that of a 55-C. The comparatively high cost of the Hellbender makes it something of a rarity, used mostly by powerful (and rich) organizations for special ops missions.

Anime Note: This was another rough design for the Advanced Battle Boomer which appeared in *Bubblegum Crash! 3: Meltdown*.

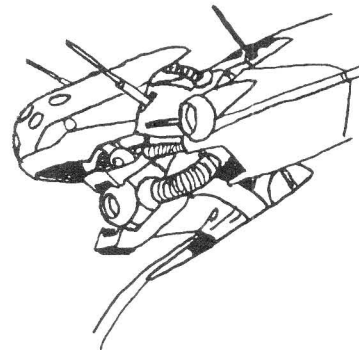
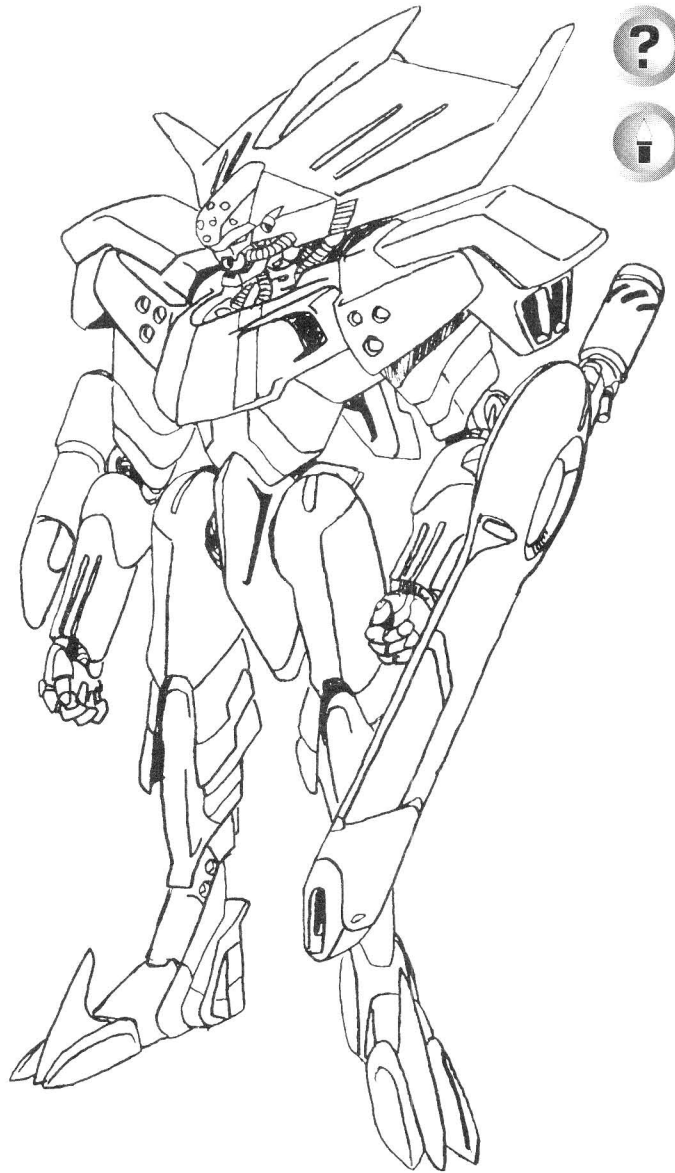

BU-17B HELLBENDER

WEIGHT		859 kg		TYPE		Battle	
ARMOR		60 KD		RUNNING		20 (60 kph)	
STRUCTURE		85 SDP		FLY/SKIM		48 (144 kph); 3/∞	
REF	9	INT	4	AI RATING	Level 6		
DEX	9	PRE	6	SKILLS	+6*		
STR	12	WILL	3	BODY	17		
MOVE	20	TECH	4	RECOVERY	20/t		
WEAPONS	WA	RNG	DMG	LOC	SPECIAL NOTES		
HAND-TO-HAND	+0	-	12D6*	A, A	*Killing damage.		
FOOT BLADES	+0	-	5D6x3*	L, L	*AP damage.		
GATLING GUN	+1	300m	8D6*	RA	*AP, ROF60, 8 bursts.		
MOUTH LASER	+0	500m	7D6x3	H	-		
SUBROCS	+0*	800m	3K	LA	*Brilliant (16+die), 10 shts		

SUBSYSTEMS:

Dual-mode jets in back grant MOVE of 16 underwater. • Scrambled radio w/ 1000km range. • Shieldable optics with targeting, lowlight & IR functions. • Enhanced Sensor system (deployed when face cover opens) with thermographics, magnetometer, seismic motion sensors, target analyzer, and 15km radar. • ECM (anti-sensor, anti-missile, anti-radar) and ECCM suite (rank-5) • Limited Fusion ability; can absorb, control, and animate 215kg of mechanical material.

*Related Skills include: *Perception, Stealth, Athletics, Hand-to-Hand, Firearms, Melee, and Demolitions.*



B

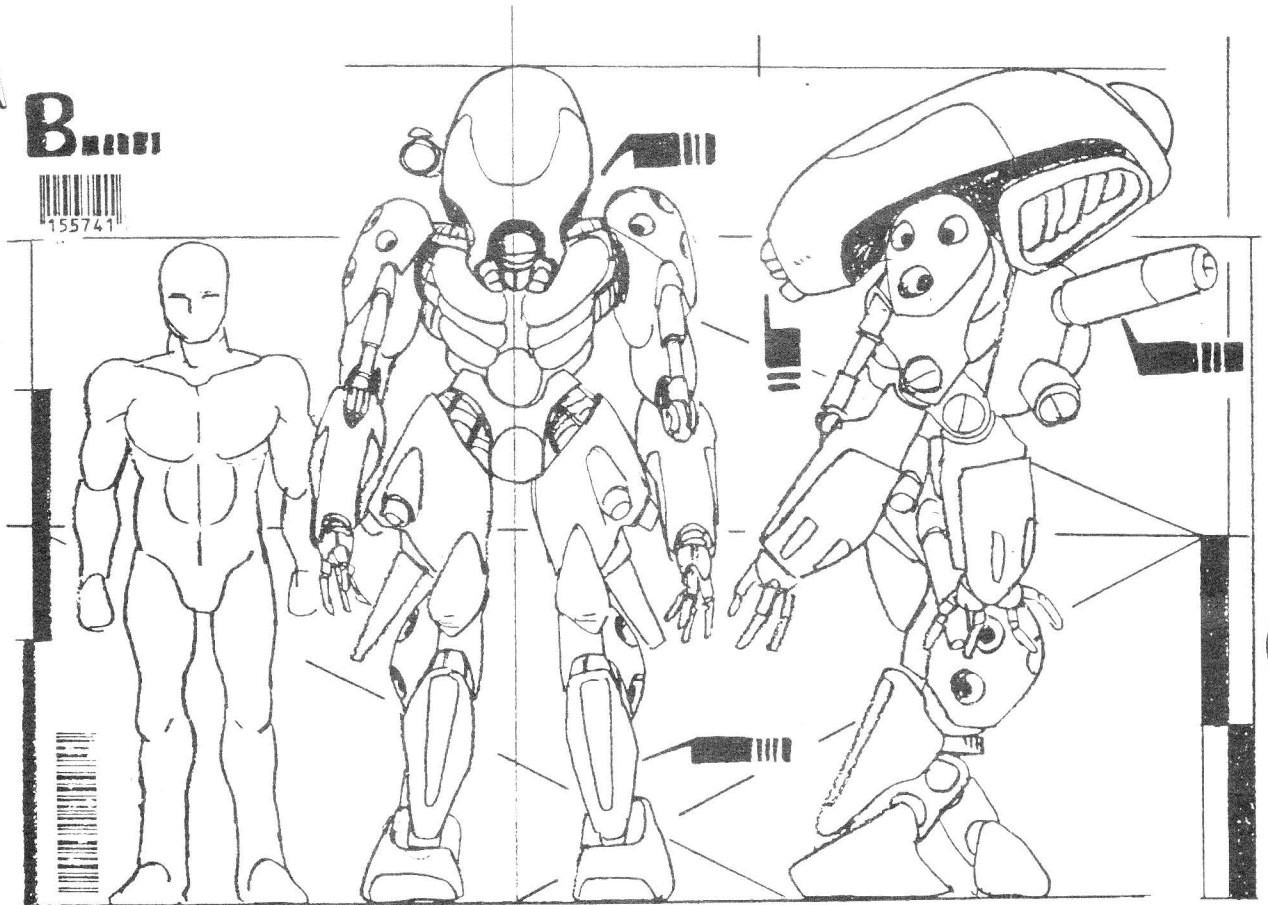

▼SPACE DEVELOPMENT BOOMER

"The majority of workers on Genaros are F- and G-series space development Boomers. There's a strong possibility that a defective unit in the lot caused some sort of screw-up during operations...."

—AD Police Chief Toodo, AD2033

The original reason for the creation of Boomerkind was to produce a laborer which could work in environments and/or conditions too hazardous for humans. Although a few experimental combat-capable Boomers were created by the researchers at Wiz Laboratories in order to gather some technical feedback, Dr. Stingray never intended Boomerkind to be used for murder and destruction. After his death, Genom went ahead and produced many warlike cyberdroids, and the exploits of the Knight Sabers have painted an ugly picture of what Boomers are like in the 2030s. However, the truth is that most Boomers really *do* work cooperatively with humanity and actively take part in society's evolution. Space development boomers are a perfect example.

The G-series model seen here is designed for heavy-duty space construction projects. It is built with a sturdy frame that stands 2.25m tall and can exercise sufficient strength to move large spacestation components. Although this powerful body is somewhat slow, it is quite dextrous and its manipulators are capable of performing intricate repairs. The inclusion of a second set of manipulators allows the Boomer to perform more operations at once, reducing the length of construction projects and thus saving its owners valuable cash. In addition, its large head houses a powerful radar which enables it to avoid collisions and other costly accidents. To operate effectively in space, the Boomer has an array of zero-G balancers on its back which complement the thrusters on its upper legs and the vernier clusters on its shoulders and lower legs. Unfortunately, as this model is constantly in demand, production is always overtaxed, which results in a relatively high percentage of defective units. Still, Space Development Boomers remain a vital element in the advancement of humanity... which is just how Genom likes it.

SPACE DEVELOPMENT BOOMER

WEIGHT	735 kg	TYPE	Labor		
ARMOR	25 KD	RUNNING	15 (45 kph)		
STRUCTURE	80 SDP	FLY/SKIM	40 (cumulative)		
REF	3	INT	4	AI RATING	Level 4
DEX	6	PRE	2	SKILLS	+4*
STR	11	WILL	2	BODY	16
MOVE	15	TECH	7	RECOVERY	20/t

WEAPONS	WA	RNG	DMG	LOC	SPECIAL NOTES
HAND-TO-HAND	+0	-	11D6*	A, A	*Killing damage.

SUBSYSTEMS:					
• Robotic brain.					
• Radio w/ 100km range.					
• Optics with lowlight, thermograph & anti-flare functions.					
• 10km range Radar array in head.					
• Two extra manipulators—adds one extra Action per Phase (but only if the Action is a hand-to-hand Action).					
• Zero-G Balancers on back.					
• Rocket thrusters on upper legs, with maneuvering rockets on lower legs and shoulders.					
• Effectively no Fusion ability and no disguise function.					
*Related Skills include: Perception, Zero-G Maneuver, Building, Basic Tech, High Tech, and Operate Heavy Machinery.					



▼NEXUS BOOMER

These new cyberdroids are designed for the management and control of all-Boomer communities. With high intelligence, fearsome charisma (among boomers), and extensive antiviral utilities, a Nexus Boomer serves as a combination foreman and “confessor” for the cyberdroids under its authority, issuing electronic orders and administering therapeutic debugging to their touchy electronic brains. Though Nexus Boomers can disguise themselves as humans, they generally go “naked” amongst their Boomer flocks, constantly preserving order and enforcing the chain of command. In case of mutiny, rebellion, or mass malfunction, Nexus Boomers are equipped with a special antennae array that can open a wireless link with any and all Boomers within line of sight, merging their “minds” into a single collective for systemwide alterations. However, since debugging isn’t always guaranteed to work, a Nexus Boomer can use its Unlimited Fusion ability to forcibly take control of any cyberdroids that go totally berserk. Obviously, a rogue Nexus Boomer would be very dangerous, so the few that have been deployed in their pilot program are watched *very* closely by human managers.

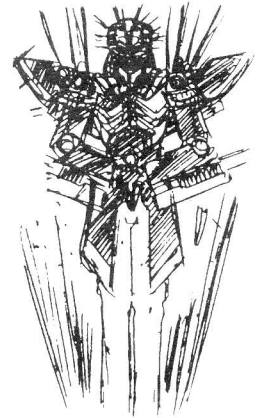
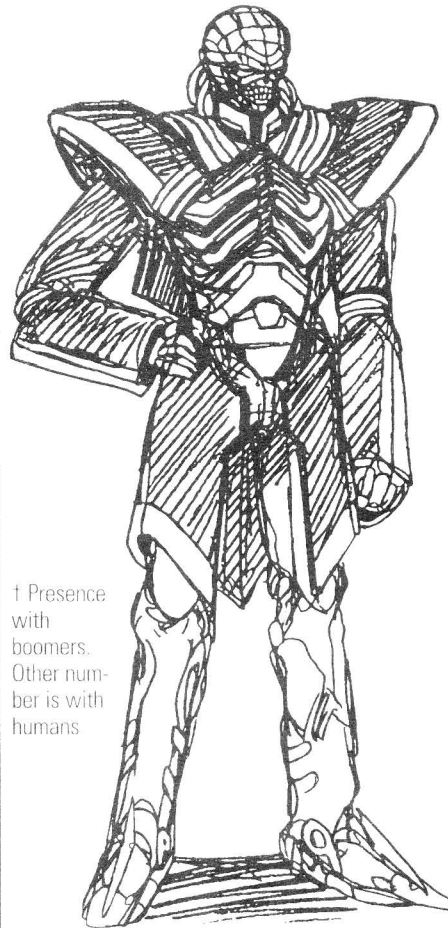

† Presence with boomers. Other number is with humans



NEXUS BOOMER

WEIGHT	420 kg	TYPE	Fusion-capable				
ARMOR	30KD	SDP	50 Hits	RUN	12 (36kph)	FLY/SKIM	-0-
INT	7	PRE	10†/7	WILL	6	TECH	3
						REF	5
						DEX	5
MV	10	STR	9	BOD	10	REC	20/t
						AI	Lvl 6
						SKILL	+6
WEAPONS	WA	RNG	DMG	LOC	SPECIAL NOTES		
HAND-TO-HAND	+0	-	9D6*	Arms	*Killing damage		
SUBSYSTEMS: Shieldable optics with Lowlight & IR functions • Radio with 100km range • Human Disguise Function: Must rip out of disguise in order to deploy equipment (Perception vs 20) • Unlimited Fusion ability (see BGC p110) • Computer package (POW 9) • “Baby OMS” Wireless Link Antennae Array: INT +Computers Skill 6 +3 (for Computer) +die roll vs. Boomer’s INTx2 +die roll; if Nexus Boomer succeeds, it has control for as many phases as its margin of success.							

▼BEETLEBOOMER

This hulking cyber-predator was designed to exploit the anatomical traits of insects—the multi-legged shape makes it fast and nimble and the monocoque (exoskeletal) construction makes it tough and strong. Furthermore, it possesses Advanced Fusion ability and is armed with deadly claws and a powerful mouth laser. This laser can be amplified when the Boomer is connected to (or fuses with) an external power source, effectively turning the whole boomer into a huge beam cannon! Still, lack of market interest precluded mass production.

Anime Note: This Boomer was featured in the BGC video game *Crime Wave*, which was made for the PC in 1989.

BEETLEBOOMER

WEIGHT	3283 kg	TYPE	Experimental		
ARMOR	75 KD	RUNNING	42 (125 kph)		
STRUCTURE	150 SDP	JUMP	88 meters		
REF	8	INT	1	AI RATING	Level 5
DEX	10	PRE	6	SKILLS	+5
STR	12	WILL	4	BODY	30
MOVE	42	TECH	1	RECOVERY	26/t
WEAPONS	WA	RNG	DMG	LOC	SPECIAL NOTES
CLAWS	+2	-	1K*AP	Limbs	*i.e., 14D6AP killing.
MOUTH LASER	-2	900m	7D6x4	Head	ROF = 5.
(MEGA-LASER)	-2	1.1km	7D6x6	Head	ROF = ∞!
SUBSYSTEMS: Shieldable Optics with IR and Thermograph functions					
• Scrambled radio with 50km range • Can power-up Mouth Laser to Mega-Laser if linked to a powerplant • Advanced Fusion ability: Can absorb up to 6957kg • No disguise function.					





1 SPACE·BOOMER

FIRE·BOOMER

3

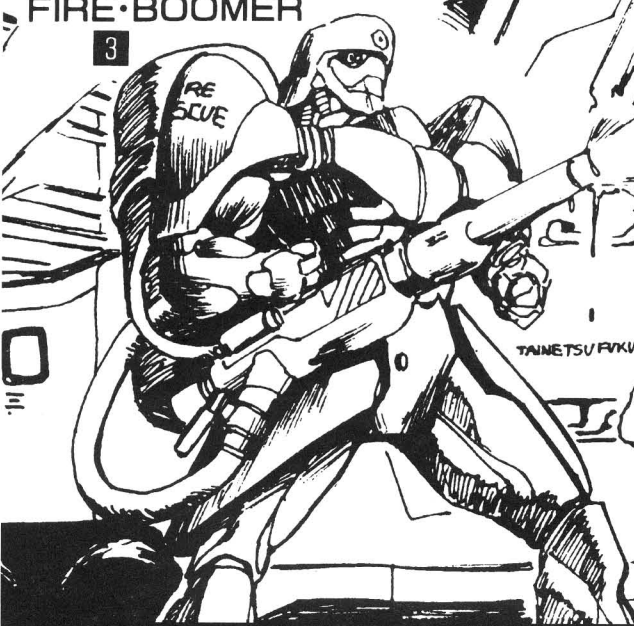

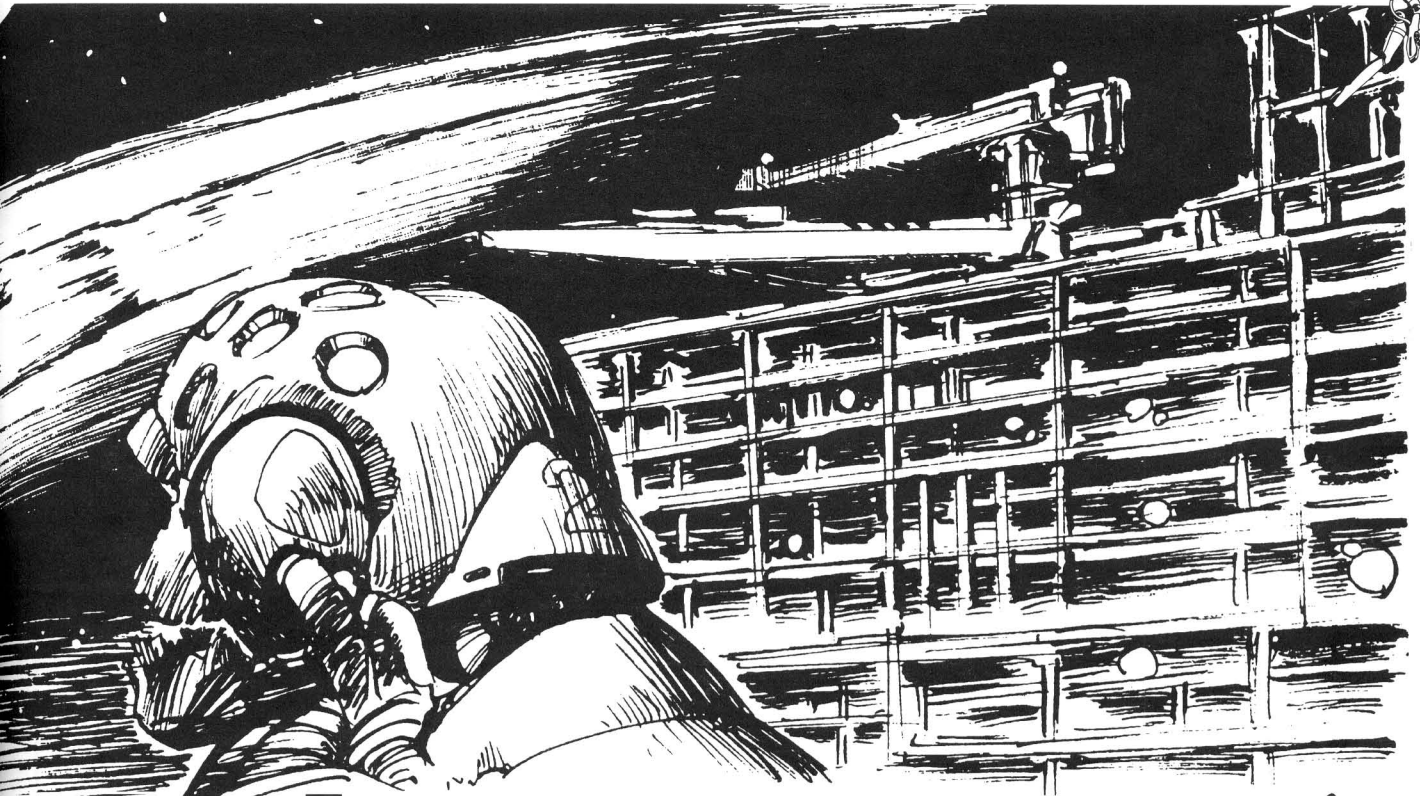

2

BUILD·BOOMER

POLICE·BOOMER

4

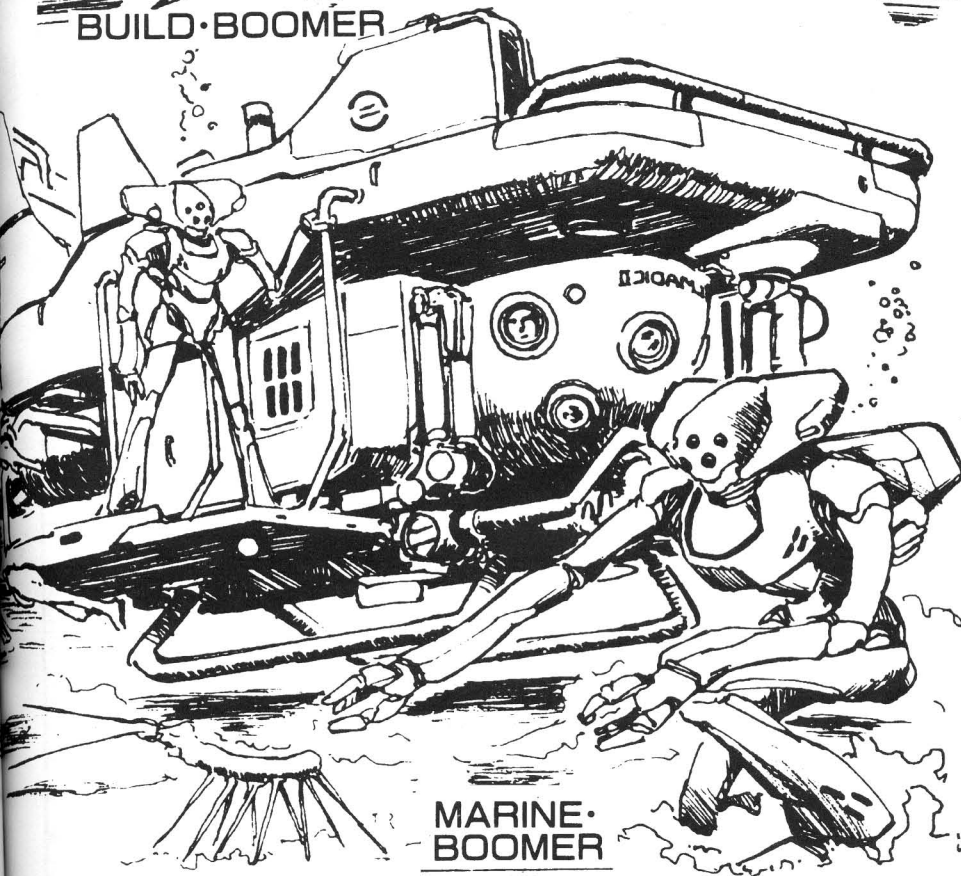

MARINE·BOOMER

5

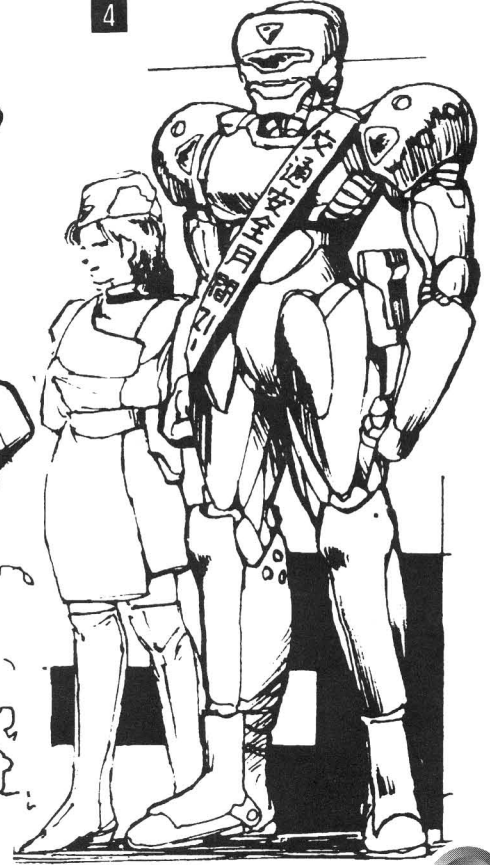



BUBBLEGUM CRISIS EX – THE EXTREME EXPANSION FOR BUBBLEGUM CRISIS

▼SPACE BOOMER (1)

Exactly what Dr. Stingray envisioned, these Boomers are the same as a Bu-55C (see BGC p99) except that they have no built-in weaponry.

▼BUILD BOOMER (2)

Designed for regular physical work, Build Boomers are often found on building sites alongside Construction Boomers (see BGC B&A p79). However, Construction Boomers are dedicated building-site units, but Build Boomers also work in assembly lines and other manufactories. Working tirelessly around the clock, what might be running through their minds when they see the evening lights . . .

BUILD BOOMER					
WEIGHT	626 kg		TYPE		Labor
ARMOR	20 KD		RUNNING		5 (15kph)
STRUCTURE	55 SDP		FLY/SKIM		-0-
REF	3	INT	2	AI RATING	Level 3
DEX	3	PRE	1	SKILLS	+3*
STR	11	WILL	2	BODY	11
MOVE	5	TECH	7	RECOVERY	22/day
WEAPONS	WA	RNG	DMG	LOC	SPECIAL NOTES
HAND-TO-HAND	+0	-	11D6*	Arms	*Killing damage.
SUBSYSTEMS:					
• Robotic brain, optics with lowlight function and 2km radio.					
• Latches for various high-steel cables and tools.					
• Effectively no Fusion ability or disguise function.					
*Related skills include: <i>Perception, Athletics, Building, Demolitions, Operate Heavy Machinery, and Basic Tech.</i>					

▼FIRE BOOMER (3)

Disaster relief is one of the areas where Boomer technology has done the most good. For example, by taking the place of human firefighters, Fire Boomers have saved countless lives, both of victims (thanks to a Boomer's superior physical capabilities) and of human firefighters (thanks to a Boomer's superior durability). There's a freezing system built into their shoulders, so they're effectively walking, double-barreled fire extinguishers—and thanks to their built-in heat resistance measures, they're able to operate in temperatures of up to 1500 degrees! This also makes them useful for rescue operations, so forest ranger units and other park-management groups often own several Fire Boomers.

FIRE BOOMER					
WEIGHT	420 kg		TYPE		Labor
ARMOR	25 KD		RUNNING		12 (36 kph)
STRUCTURE	55 SDP		FLY/SKIM		-0-
REF	6	INT	4	AI RATING	Level 4
DEX	6	PRE	1	SKILLS	+4*
STR	11	WILL	2	BODY	11
MOVE	12	TECH	5	RECOVERY	22/day
WEAPONS	WA	RNG	DMG	LOC	SPECIAL NOTES
HAND-TO-HAND	+0	-	11D6*	Arms	*Killing damage.
SUBSYSTEMS: Robotic brain, optics (lowlight, thermograph, flashproof), 10km radio. • Freezing System (CO ² fire extinguishers in each arm): Can spray three square m/yds (about the size of 2 doors) per Phase, each has 20 uses. • Effectively no Fusion ability or disguise function.					
*Related skills include: <i>Perception, Athletics, Melee, Expert: Firefighting, Demolitions, and Operate Heavy Machinery.</i>					

▼POLICE BOOMER (4)

As the Normal Police's press release says: "Enforcing the law and maintaining order, Police Boomers are the allies of common citizens, children and female officers." Being physically superior, they're excellent candidates for taking the place of human policemen in high-threat situations; as such, they have the potential to serve as of AD Police special officers. Of course, the very idea of a Police Boomer has met with massive resistance in some cities for fear of what might happen if one goes berserk; As a result, Police Boomers have no built-in weapons. Still, many politicians (and voters) want to use Police Boomers to replace their local AD Police—who strongly object to this crazy idea!

POLICE BOOMER					
WEIGHT	485 kg		TYPE		Mannequin
ARMOR	35 KD		RUNNING		20 (60 kph)
STRUCTURE	60 SDP		FLY/SKIM		-0-
REF	varies; avg 5	INT	varies; avg 5	AI RATING	Level 5
DEX	varies; avg 5	PRE	varies; avg 5	SKILLS	+5*
STR	11	WILL	varies; avg 5	BODY	12
MOVE	20	TECH	varies; avg 5	RECOVERY	22/day
WEAPONS	WA	RNG	DMG	LOC	SPECIAL NOTES
HAND-TO-HAND	+0	-	11D6*	Arms	*Killing damage.
TASER KNUCKS	+0	-	6D6*	Arms	*Stun damage.
SUBSYSTEMS: Imprinted AI brain. • Optics with lowlight, thermograph, targeting, & video transmit functions. • 25km police-band radio & datalink to HQ • Effectively no Fusion ability or disguise.					
*Related skills include: <i>Perception, Athletics, Hand-to-Hand, Firearms, Detective, Persuasion, and Driving.</i>					

▼MARINE BOOMER (5)

Used for underwater work, Marine Boomers are able to reach depths of up to 3000 meters—and since they don't need to change pressures like human divers do, ocean floor construction projects and other underwater work can carry on much more smoothly. Their internal technology is radically different from that of other Boomers: They have hydromagnetic "caterpillar" drives built into their backs to propel them through the water, their senses are modified with built-in sonar so that they can navigate through the pitch-black depths, and their limbs (especially the hands and feet) are thinly built to reduce water resistance and ease underwater work.

MARINE BOOMER					
WEIGHT	237 kg		TYPE		Labor
ARMOR	20 KD		RUNNING		6 (18 kph; 1/3 in water)
STRUCTURE	40 SDP		SWIMMING		8 (24kph) water only
REF	4	INT	3	AI RATING	Level 3
DEX	3	PRE	1	SKILLS	+3*
STR	9	WILL	2	BODY	8
MOVE	6	TECH	5	RECOVERY	18/day
WEAPONS	WA	RNG	DMG	LOC	SPECIAL NOTES
HAND-TO-HAND	+0	-	9D6*	Arms	*Killing Damage.
SUBSYSTEMS:					
• Robotic brain, optics with thermograph, 1km range sonar system.					
• Hydromagnetic "caterpillar" drive in back unit.					
• Effectively no Fusion ability or disguise function.					
*Related skills include: <i>Perception, Swimming, Building, Demolitions, Operate Heavy Machinery, and Basic Tech.</i>					



▼TERRORIST BOOMERS

Doctor Yuri wasn't the only louse who ever needed some cheap Boomer muscle, which is why countless street techs out there continue to recycle civilian cyberdroids into imitation Combat-type Boomers. Depending upon the street techs' whims, Terrorist Boomers have been made with all manner of sadistically humorous appearances, from streetpunk to salariman to geriatric geezer. The most advanced Terrorist Boomers may even have built-in weapons, which they can deploy once they shed their disguise (often a rather messy process).

TERRORIST BOOMERS

WEIGHT	300-400 kg		TYPE		Combat
ARMOR	15-25 KD		RUNNING		6-12 (18-36kph)
STRUCTURE	45-55 SDP		FLY/SKIM		-0-
REF	4-6	INT	2-4	AI RATING	Lvl 3-5
DEX	4-6	PRE	3-5	SKILLS	+3 ~ +5
STR	7-9	WILL	3-5	BODY	9-11
MOVE	6-12	TECH	2-4	REC	14-18/t
WEAPONS	WA	RNG	DMG	LOC	SPECIAL NOTES
HAND-TO-HAND	+0	-	7-9D6*	Arms	*Killing damage.
(MOUTH LASER)	+0	555m	7D6x2	Head	Optional.
SUBSYSTEMS: Robotic brain • Targeting, lowlight & IR optics • Scrambled 50km radio • Custom appearance (depends on circumstances) • Effectively no Fusion ability • Expensive models may have a mouth laser • Skills include: <i>Perception, Athletics, Hand-to-Hand, Firearms, Melee, and Driving.</i>					



▼FIGHTING BOOMER

This male-styled cyberdroid is similar to the Boomer Women (see *BGC* p.102) and is also designed to perform infiltration, espionage, and bodyguard duties. Being an endoskeletal model, it can't change into a "full-boomer" form, instead it has a bulletproof, laser refractive weave integrated in its "skin". During combat, the Fighting Boomer deploys optic shields from its brow, sensor antennae from its clavicles, taser-points from its knuckles, and duct-like membranes from its pectorals and shoulderblades which allow the boomer to skim like a hovercraft and make boosted jumps.

FIGHTING BOOMER

WEIGHT	222 kg		TYPE		Android
ARMOR	30 KD		RUNNING		10 (30 kph)
STRUCTURE	60 SDP		SKIM		25 (75kph); 3 phases
REF	7	INT	6	AI RATING	Level 7
DEX	8	PRE	8	SKILLS	+7
STR	9	WILL	8	BODY	12
MOVE	10	TECH	5	RECOVERY	18/day
WEAPONS	WA	RNG	DMG	LOC	SPECIAL NOTES
HAND-TO-HAND	+0	-	9D6*	Arms	*Killing or Stun.
TASER KNUCKS	+0	-	12D6*	Arms	*A-P, +Shock.
SUBSYSTEMS: Shieldable optics w/ targeting, IR & lowlight vision					
• Deployable 100km scrambled radio & motion detector antennae					
• Deployable fan-membranes allow 10-second (3-phase) hovercraft dashes or 21m jumps • Organic structure; can't rip out of disguise; no Fusion ability; REC limited to 18/day (not turn).					



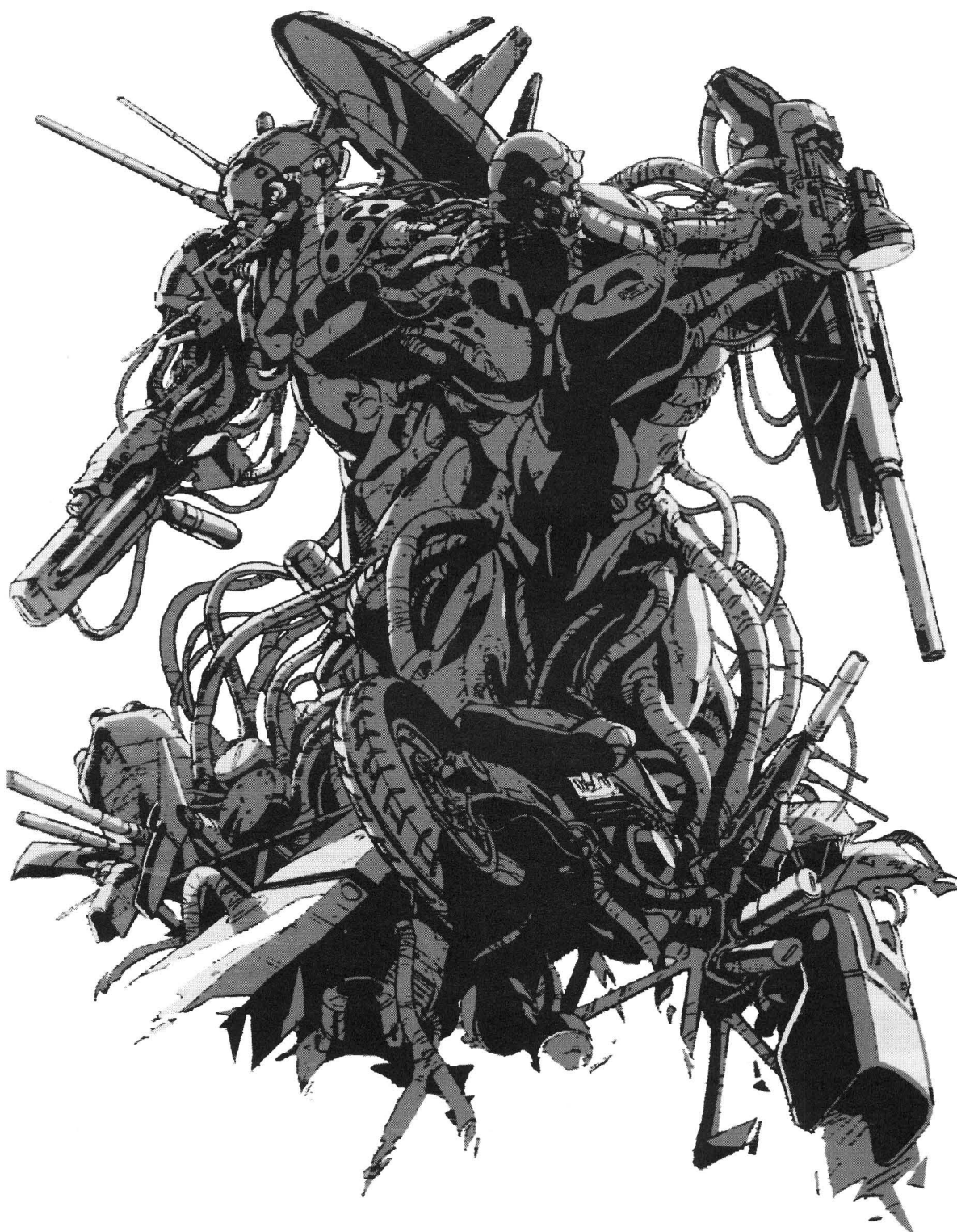

▼BOOMER-BOOMER FUSION

As is discussed in the *BGC RPG* (see page 97), Boomers have the ability to fuse with each other, a last-ditch strategy usually taken when one or more of the boomers has been damaged. Even Boomers with Fusion-proof armor (like the Bu-12B) can fuse with other Boomers through open wounds, provided one of them has at least Limited Fusion capability. The results of boomer fusion are high-tech Frankenstein's monsters, the thalidomide babies of the 21st century. They are extremely dangerous thanks to their chaotic shapes, which give them unpredictable behavior and abilities. Sometimes, many cyberdroids may be absorbed by a dominant Fusion Boomer, transforming like bacteria into some kind of huge organism.

This has become a particular problem on battlefields where boomers are utilized. Damaged boomers which are abandoned at battle sites have been known to combine with other battlefield debris, forming conglomerations with truly terrifying abilities. For instance, one damaged BU-55c in the Philippines fused with the control functions of an abandoned, old-model TU-80 tank. While it could not fuse with the entire tank,



BOOMER-BOOMER FUSION

WEIGHT =	Add weights of all Boomers together.
ARMOR =	KD of most heavily armored Boomer.
STRUCTURE =	Add all smaller Boomers' SDPs together, divide by 2, add to largest Boomer's SDP.
RUNNING =	Average of all Boomers' values.
FLY/SKIM =	Average of all Boomers' values.
STATS & SKILLS =	Use highest values of any Boomer in group.

WEAPONRY:

- Any weapons which were part of the Boomers before they were fused together become usable by the fused Boomer mass.
- Any weapons which were not part of the Boomers are treated like handheld weapons, except that there is no limit to the number of such "held" weapons which the fused boomer can "hold", and they cannot be grabbed away.

SUBSYSTEMS:

- Any systems which were a part of the Boomers before they were fused together become usable by the fused Boomer mass.
- Any systems or other items which were not part of the Boomers are treated like handheld items, except that there is no limit to the number of such "held" items which the fused boomer can "hold", and they cannot be grabbed away.
- Fused boomers cannot disguise themselves as humans.

it managed to gain control of the gun sighting and autoloading systems, which were disabled during the battle. It repaired them using its fusion ability and preceded to open fire on anything that entered its line of sight—no matter what side they were on. It took an air strike to finally destroy this "boomer bunker."

As a result of such incidents, armed forces utilizing boomers try to maintain a "clean site" policy, which mandates the total removal or destruction of any damaged enemy (or even friendly) boomers left at a battle scene. This has led to many firefights as damaged boomers have struggled for their (artificial) lives against military "salvage or destroy" teams.

Left page: These two boomers seem to have been terminated at the scrap yard... but they've fused through their open wounds and have arisen as a steel scrap monster! If you look hard, you can even see parts of a Motorslave and the SuperBoomer within this abomination. Weight: 2354kg. Armor: 90KD. Structure: 145KD. Move: Zero. INT 3, REF 6, DEX 6, PRE 9, WILL 7, TECH 4, STR 14, REC 28/t, AI Level 5. Weapons: Heat Cannon (+3, 725m, 6D6x3, 2.5m area, 2 turn warmup), Mouth Laser (+0, 1000m, 11D6x3, ROF=9), Machinecannon (+1, 1600m, 5D6x4, AP, ROF=9, 5 bursts), Grenade Launcher (-2, 3km, 7D6x4, Blast radius 1m). Subsystems: Recon sensors, vectored fan (STR 12 10m exhaust blast).

Above: What if Doctor Yuri's death squad of terrorist boomers had fused with their combat boomer leader? The result might have been something like this multi-headed giant. Weight: 1865kg. Armor: 30KD. Structure: 160KD. Move: 8. INT 4, REF 6, DEX 6, PRE 6, WILL 5, TECH 3, STR 10, REC 20/t, AI Level 5. Weapons: Mouth Laser (+0, 720m, 6D6x3), Claws (+0, 7D6x2). Subsystems: Four arms, four extra sets of sensors.

AD POLICE TECH

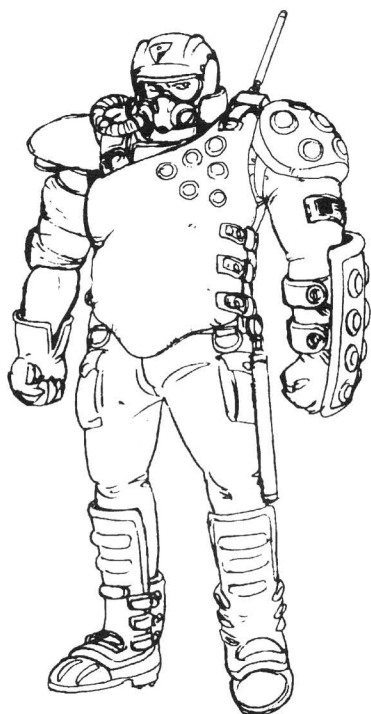

▼ADP HEAVY ARMOR

This is a heavily armored combat uniform for Advanced Police frontline officers. It is currently being evaluated by several departments around the world, and is even seeing field tests in a few major cities. The softshell flak armor is more resistant to penetration by small arms fire and shrapnel, but some officers have complained about the added bulk restricting their movements.

ADP FRONTLINE HEAVY ARMOR

ARMOR WEIGHT	14.6 kg	OVERALL KD	25
ENCUMBRANCE	-3 Dex*,	TORSO & HELMET KD	25
	-3 Ref, -2 Move	LIMB KD	25
*DEX penalty is reduced by 1 if not wearing the helmet. Armor is effective against all types of damage, including bullets, blades, blunt trauma, and fire.			
SIDARM	.454 Magnum Auto (BGC p141)		
LONGARM	Anti-Boomer Heavy Rifle (BGC B&A p32)		
MELEE WEAPON	Police Baton (as Tonfa; BGC p. 141)		
OPTICS	IR Thermograph, lowlight, and +2 Targeting.		
EQUIPMENT	Radio w/ satellite uplink, gasmask w/ 30 minutes of air, shoulder ID plate, mineproof boots, belt with clips for 6 reloads total for both firearms, Boomer Deactivator (handheld remote device; switches off parasympathetic system of any civilian boomer; does not work on berserkers).		

▼K-11 TEAM

As these Boomer-busters drop into a battlezone, their retro-rockets boom and flare, creating fireballs which render the ground beneath them useless for years!

The suit on the left is armed with 8 visual-homing missiles (+0, 1.5km, 2K, Smart) and two 30mm railcannons (+1, 1km, 6D6x3AP, 12 shots—these weapons fire anti-armor penetrators and require a hefty set of support equipment).

The suit in the middle is equipped with a command pack of sensor equipment, (+2 Perception) communications devices, and a 12.7mm short gatling gun (-1, 600m, 10D6AP, ROF75, 600 rounds).

The suit on the right is armed with a gatling claw (-1, 300m, 9D6AP, ROF100, 500 rounds) and a 45mm multipurpose launcher claw (-2, 700m, 7D6x3, Blast radius 10m, 5 rounds) implanted in the arms, an 80mm rocket pack (-1, 1.2km, 7D6x5, blast radius 3m, 6 shots) on the left shoulder, and two "Ears of Corn"—these close-range demolition missiles are unleashed during an assault approach, firing row after row as they rotate (-2, 375m, 5D6x3, smart, blast radius 1m; each launcher can fire 9 salvos of 7 missiles).

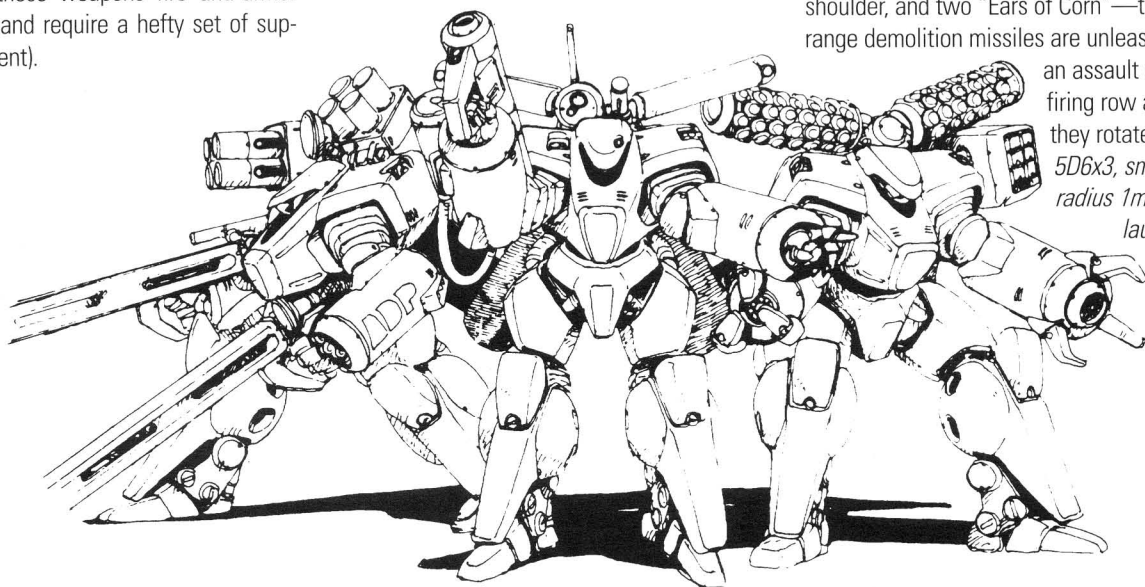

▼ HARD DETAILS OF THE AD POLICE K-11

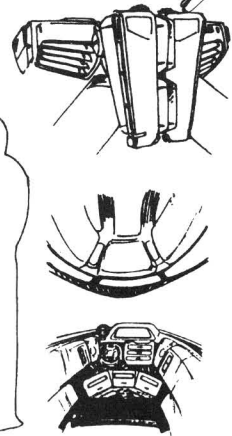
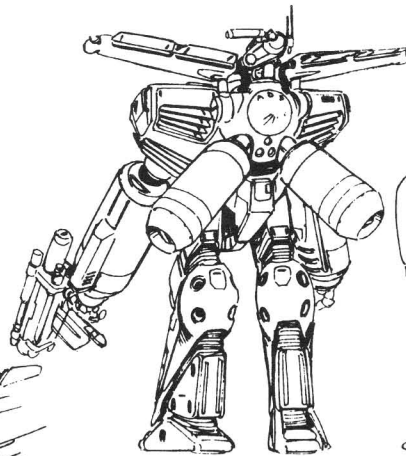
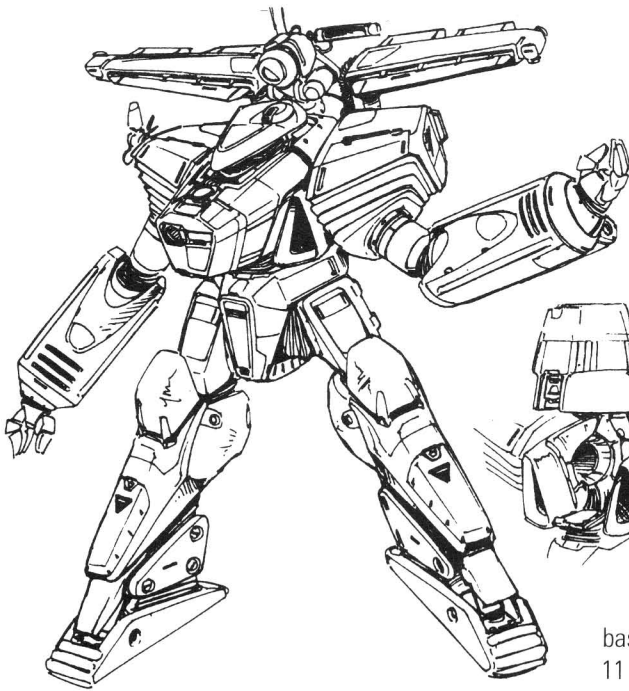

In the early 1990's, the Slave Trooper Madox was put into use. Though the machine had a simple physical body, its systems were highly advanced for the time so its design theory was employed for the current K series. Thus, the old Madox Slave Trooper represents the basic structural form of modern battlesuits, as embodied by the AD Police's K-11 shown here.

To the right we see a K-11 undergoing maintenance in its hangar. With its armor plating removed, the arm's actuators are visible. A very detailed check-up is necessary before each use, since the battlesuit has so many moving parts. In fact, the check-up on a K-11 is much more complex than that of a fighter plane!

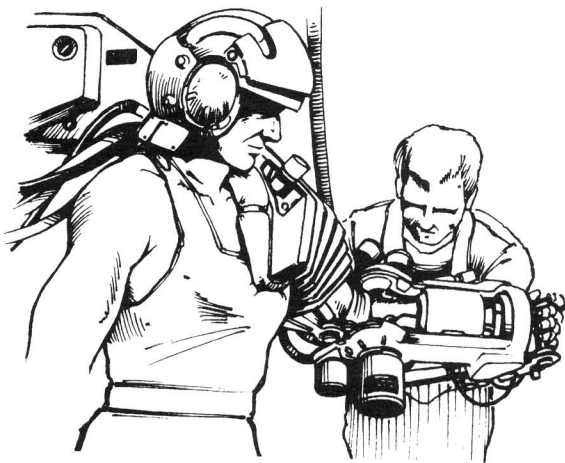
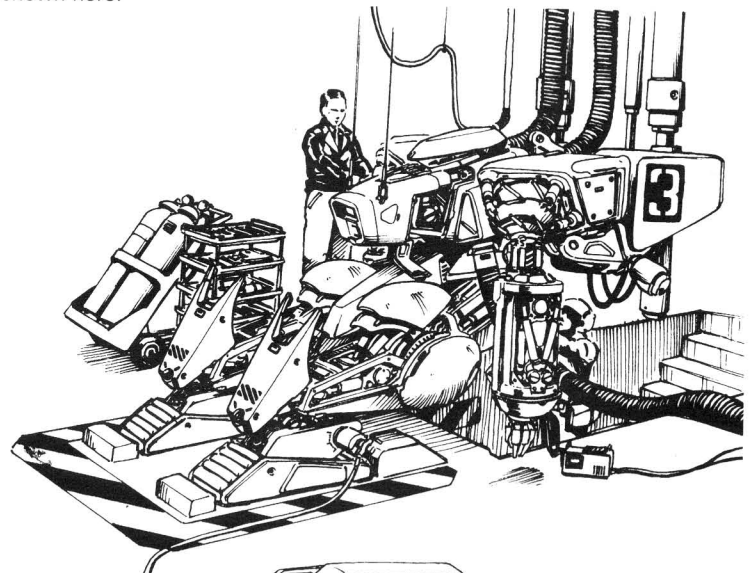

Every battlesuit must be adjusted for its human controller's body size and athletic ability. The adjustments aren't as meticulous as those for the Knight Sabers' custom-made Hardsuits, but they are precise enough to allow only those fitted with the machine to control it. Should another person board the battlesuit, he would only be able to stumble awkwardly and would probably wind up spraining something. Above we see a K-11 operator undergoing the fitting process. The stroke of his elbow is being observed, and the data from the torque meter on the machine's joint will be adjusted accordingly.

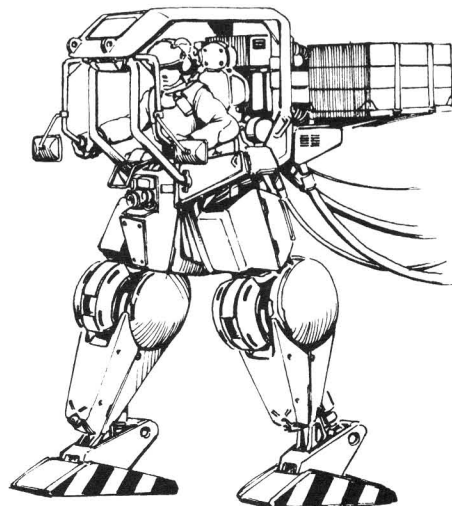

Above is a K-11 trainer machine used for practice walking. This training device is available for use at the ADP Training Center.



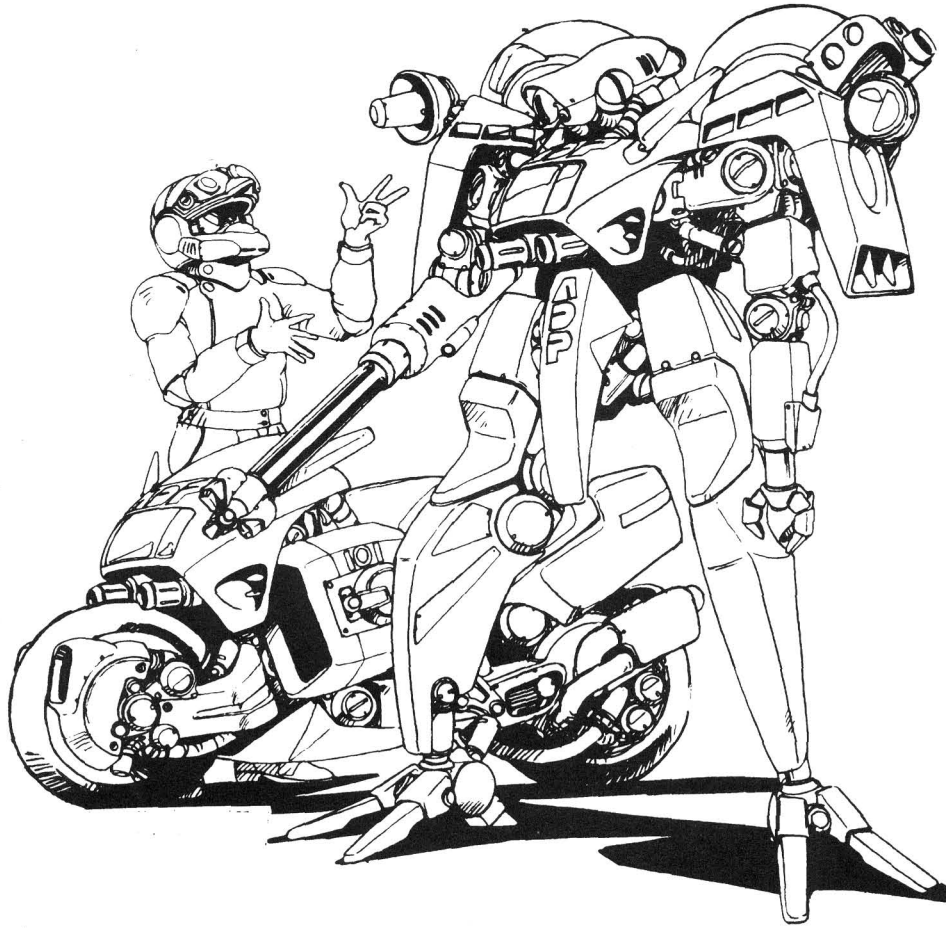

▼ADP “PAT-ROADER” SLAVE-CYCLE

In 2033, the ADP finally took initiative over the police forces of the world by experimenting with a transformable motorcycle mecha—one whose AI gave it partial self-reliance. Dubbed the Pat-Roader, this transformable assistant robot can take can partially act on its own, even in motorcycle mode (it can operate without a driver thanks to its built-in inertial guidance system). Unlike much of the ADP’s equipment, which was originally designed for use by the army, this unit is unique to the ADP... although it is clearly a copy of the Knight Sabers’ motorslaves. In fact, rumor has it that Sylia secretly designed it for for the ADP in order to help alleviate the Knight Sabers’ never-ending financial problems.

The purpose of this motoroid is to infiltrate and investigate dangerous areas for its partner, an ADP rider. To this end, the Pat-Roader can transmit audiovisual information about its surroundings to its partner; his helmet’s screens can receive and interpret the data in real-time, allowing him to survey a radial range of 200m in urban areas. In general, the motoroid follows its partner’s instructions, but under certain situations it makes its own decisions, such as engaging in pursuit, taking defensive maneuvers, or making attacks... without a weapon.

Weapons are, in fact, the largest problem posed by this motoroid. Though it’s well armed, the legal controversy over giving a robotic unit the potential to use firearms against its targets quickly resulted in the placement a programming block in the Pat-Roader’s AI: It simply cannot make the individual decision to fire a weapon. Instead, it uses a synchronized targeting system linked to the rider’s helmet, whose synchronighting control system ensures that only the motoroid’s human partner can trigger and fire any of the Pat-Roader’s weaponry. This complicated arrangement has given rise to concern that the ADP can’t put this powerful new machine to full use.

Though it’s not capable of hovering or linking with its rider in motoroid form like the Knight Sabers’ Motorslaves can, the Pat-Roader is indeed powerful. It is armed with two 40mm multipurpose launchers which can fire grenades, gas packets, shotshells, rubber bullets, etc., and its right arm mounts a 25mm S.D. railgun similar to the Stomach (see BGC p128) and is tipped with a submanipulator. It also mounts a white search light on its left shoulder, and a loudspeaker on the right. Length: 225 cm Weight: 198 kg Power unit: Ceramic gas turbine with 3 axles. Maximum output: 110PS Maximum speed: 240 km/h.

ADP PAT-ROADER 141 OP

WEIGHT				198 kg	STRENGTH				10
D10	LOC	KD	SDP	D10	LOC	KD	SDP		
1	Head	40	30	7-9	Leg	40e	50e		
2-4	Torso	40	60	10	F. Wheel	20	25		
5-6	Arm	40e	40e		R. Wheel	20	25		

MODE	MANEUVER	SURFACE	FLIGHT
Motorcycle	-1	80 (240kph)	-
Motoroid	*	18 (54kph)	-

*AI has INT, REF, DEX, & combat skills of 3. When under remote control, it uses operator’s stats & skills at 1/2 their normal values.

WEAPONS	WA	RNG	DMG	LOC	SPECIAL NOTES
HAND-TO-HAND	±0	-	10D6	A,A	*Killing Damage
25MM RAILGUN	+1	520m	8D6x2*	RA	*AP, 20 shots.
40MM LAUNCHER	-1	200m	*	T	*8 shots, load varies: Grenade = 6D6x3, 5m area; Gas = 7D6x2 Stun (ignores SD), 10m area; Shotshell = 6D6 (applied twice) to 3m area; rubber bullet = 6D6x3 Stun.

- SUBSYSTEMS:
- Motoroid cannot fire its own weapons; driver must use Synchro-targeting system (built into helmet; no penalties for doing so).
 - Sensor Turret has audiovisuals (4km), scrambled radio (80km), targeting and lowlight vision.
 - Right shoulder mounts white searchlight.
 - Left shoulder mounts loudspeaker.

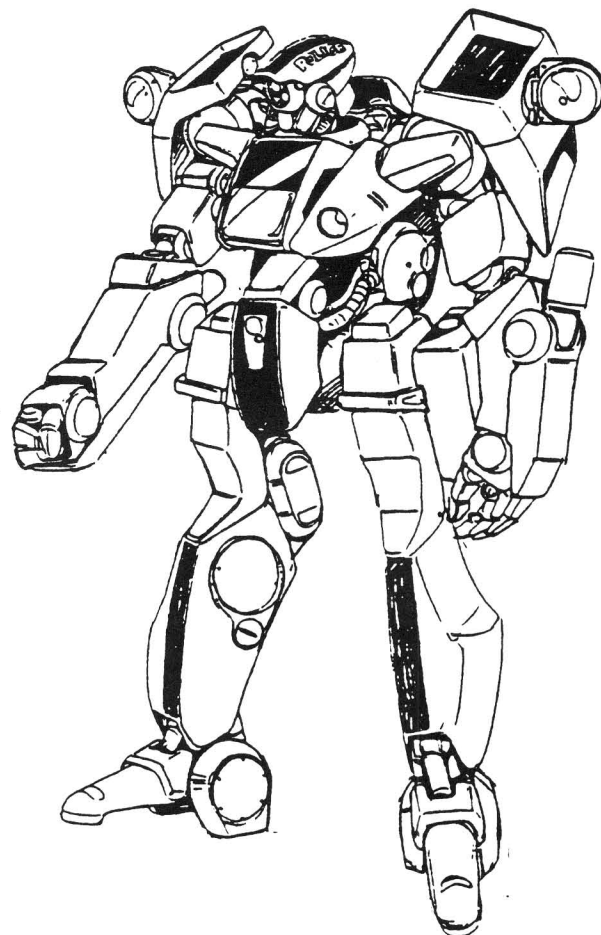
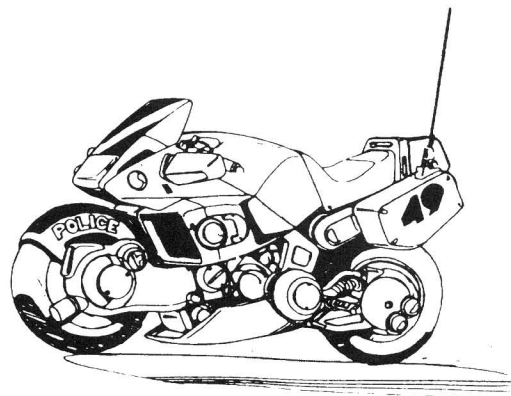

EARLY DESIGN FOR ADP MOTOROID. SHARP ANGLES WERE REMOVED IN FINAL MODEL.

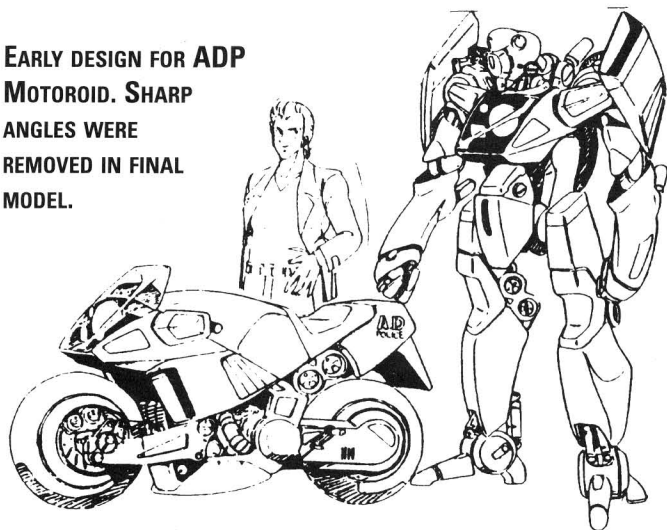

ADP MOTOROID 148 OP

WEIGHT				182.5 kg	STRENGTH				11
D10	LOC	KD	SDP	D10	LOC	KD	SDP		
1	Head	45	35	7-9	Leg	45e	55e		
2-4	Torso	45	70	10	F. Wheel	25	25		
5-6	Arm	45e	45e		R. Wheel	25	25		
MODE		MANEUVER		SURFACE		FLIGHT			
Motorcycle		-1		98 (295kph)		-			
Motoroid		*		18 (54kph)		-			

*AI has INT, REF, DEX, & combat skills of 5. When under remote control, it uses operator's stats & skills at 1/2 their normal values.

WEAPONS	WA	RNG	DMG	LOC	SPECIAL NOTES
HAND-TO-HAND	±0	-	11D6*	A,A	*Killing Damage
K-11 CASELESS MG	±0	450m	6D6x2*	2H	*AP, ROF15, 7 bursts.

SUBSYSTEMS:

- Sensor Turret has audiovisuals (4km), scrambled radio (80km), targeting and IR vision.
- Right shoulder mounts IR spotlight.
- Left shoulder mounts white spotlight.
- Right hip (sidesaddle box in Motorcycle form) can store an extra magazine for handheld weapon.

You've spent the last five miles in high-speed pursuit, your motorcycle screaming down the highways after the perps' escape vehicle. You've finally managed to corral them in a refinery area. This place has been abandoned since the quake. You can see the perps' Genom-made van stopped just ahead, engine still running—they ditched it in a hurry. Dismounting your bike and popping the 'stand, you quickly case the site: this looks like the only way in, but your backup won't be here for at least six minutes. Until then, it's up to you to keep these lousy boomer thieves from sneaking back out of the complex. There are at least four of 'em, which spells bad odds for you.... So you press the red button on your watch, and your motorcycle noisily transforms. As the motoroid stomps up to cover your back, you cock your automag.

"Keep your sensors peeled, Max. They're probably gonna rush us," you warn it. "All systems ready, Sam," your motoroid partner declares. The odds just got better.

▼ADP MOTOROID

Even as the Pat-Roader was entering service, development had already begun on an improved model... but the new ADP Motoroid wasn't put to practical use until later because its AI was so greatly improved. This new Motoroid can operate entirely on its own and has conversational ability, but no weaponry is built in because such intelligence allows it to comprehend life-and-death decisions. Since this does away with the troublesome synchro-targeting system, the ADP only arms these new Motoroids when serious trouble is expected. In such cases, they use the same weapons as do the by K-series powered suits. Although its AI is significantly more advanced, the ADP's new Motoroid still cannot hover, nor can it link with its rider to become a Motorslave. Furthermore, because of this unit's ability to use weapons on its own, few AD Police departments have been issued any of the new Motoroids—nervous politicians don't want to lose votes over such a political "hot potato".

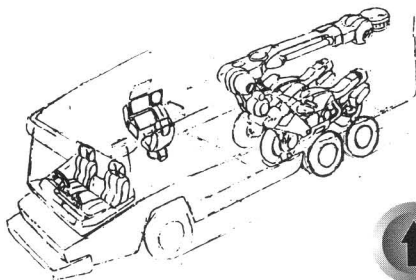
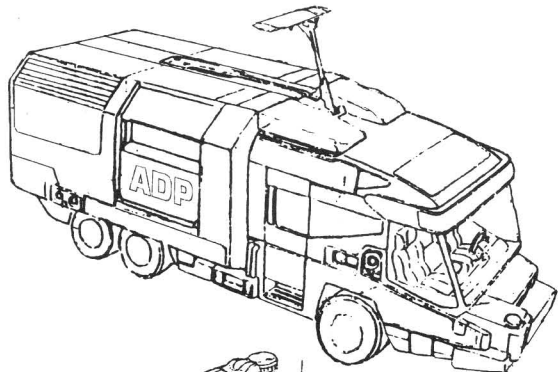

▼ADP TASKWAGON

With the introduction of the Pat-Roader and other Motoroids, the ADP developed a mobile police station designed to work in conjunction with a team of Motoroid drivers. These "Taskwagons" are crewed by three to six officers, and offer them support in the form of advanced electronics (such as computers, communications gear, and surveillance equipment) and two hydraulic booms. Deploying from either side of the vehicle, the booms can both launch cycle-form Motoroids at the same time, even while the Taskwagon is moving. A Taskwagon's interior can accommodate up to four bikes and their riders.

ADP TASKWAGON 14 OP

MANEUVER	-4 Ref	ARMOR	40 KD	WEIGHT	5190kg
MOVE	45 (135kph)	STRUCTURE	115 SDP	CREW	1 + (2-5)

SUBSYSTEMS: Crew space with 2 to 5 extra passengers. • Combat data center with POW-5 computer, 100km range scrambled radio communications, +3 Perception surveillance systems (20km aerial radar, shotgun microphone, lowlight, thermographics, recorders & image enhancement).
• Hangar for 2 to 4 Motoroids, dual launch booms.



▼ADP RUNABOUT

Designed for long missions in the field, a Runabout is effectively a smaller version of a Taskwagon without the Motoroid support ability. It is designed to allow investigations to be carried out on-the-go, so while it can accommodate six officers, it also gives them plenty of room to work together. All six seats are rotating bucket-type, and a central desk can fold down from the ceiling. This desk integrates terminals for various electronics (computers, surveillance gear, and communications equipment). For chase purposes, the Runabout also boasts a high-performance engine and a retractable machinegun turret.

ADP RUNABOUT 12 OP

MANEUVER	-3 Ref	ARMOR	35 KD	WEIGHT	2612kg
MOVE	63 (188kph)	STRUCTURE	80 SDP	CREW	1 +5

WEAPONS	WA	RNG	DMG	LOC	SPECIAL NOTES
TURRET MG	+0	300m	8D6*	T	*ROF30, 200 rnds.

SUBSYSTEMS: Data center with POW-4 computer, 50km range scrambled radio communications, +2 Perception surveillance systems (shotgun microphone, lowlight, thermographics, recorders & image enhancement).

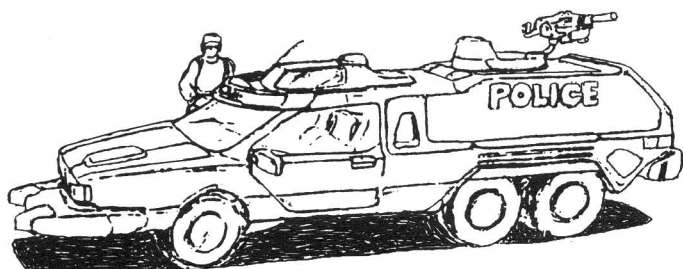

▼ADP BUGGY

Based on a military general-purpose car, the ADP buggy is armored much more heavily than standard cruisers. It was chosen because AD Police departments found that large numbers of Interceptors and other cars are lost every year in engagements with wild boomers—a sturdier, better protected car could help prevent that. It is also built low to the ground for increased steadiness, and its six tires are arranged in a broad wheelbase to better grip the streets.

ADP BUGGY 9 OP

MANEUVER	-4 Ref	ARMOR	35 KD	WEIGHT	1210kg
MOVE	70 (210kph)	STRUCTURE	55 SDP	CREW	1 +1

SUBSYSTEMS:
• Loudspeaker
• Siren
• Emergency Lights
• Police-band radio, data link to ADP headquarters.

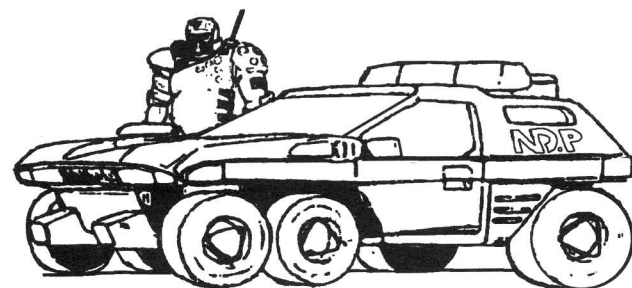



▼ADP RIOTCAR

This is a rugged APC capable of traversing terrain as rough as shattered streets and roadblocks thanks to its four-wheel-drive independent-suspension. Its cabin can hold as many as four frontline officers in full combat gear or one officer and one Motoroid. Originally a military vehicle, the ADP's version is designed to be used in riot situations, so it's been modified with a high-visibility cab and solid rubber tires. Its armament consists solely of a water cannon housed in a top turret.

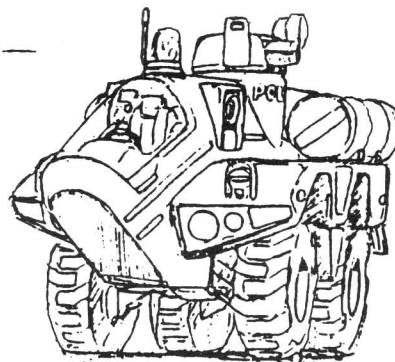
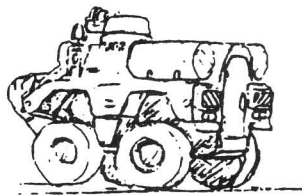

ADP RIOTCAR					18 OP
MANEUVER	-4 Ref	ARMOR	45 KD	WEIGHT	3240kg
MOVE	50 (150kph)	STRUCTURE	90 SDP	CREW	1 (+4)
WEAPONS	WA	RNG	DMG	LOC	SPECIAL NOTES
WATERCANNON	+0	50m	10D6*	T	*Stun; ROF∞, 30 uses.
SUBSYSTEMS:					
Solid tires (cannot be punctured or slashed). • Loudspeaker, siren and emergency lights • Police-band radio, data link to ADP headquarters.					

▼AD POLICE UFV

A modified military minitank, this "Urban Fighting Vehicle" is used by AD Police units to counterattack cybernetically-enhanced streetpunks, heavily-armed criminals, and of course rampaging boomers. It has been modified with a high-visibility cockpit and its wheelbase has been reduced, affording it speed and maneuverability disproportionate to its design concept. It is well armed, sporting a 25mm chin turret and two 50mm wide-angle cannons, but this unfortunately classes it as Mobile Heavy Force equipment, and thus Diet approval is needed to authorize its deployment.



ADP URBAN FIGHTING VEHICLE					23 OP
MANEUVER	-3 Ref	ARMOR	50 KD	WEIGHT	4651kg
MOVE	44 (133kph)	STRUCTURE	105 SDP	CREW	2
WEAPONS	WA	RNG	DMG	LOC	SPECIAL NOTES
25MM MG	+1	400m	13D6	F	ROF20, 12 bursts.
50MM GUNS	-1	600m	2K	R, L	15 shots each.
SUBSYSTEMS: Solid tires (can't puncture or slash). • Loudspeaker, siren and emergency lights • Police-band radio, data link to ADP HQ.					

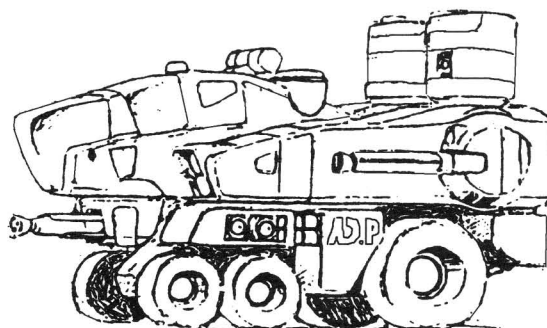

▼ADP AEROCHASER

This is a larger, better protected alternative to the Fire-Bee used by some AD Police departments. It is still an open-cockpit design, but its undercarriage is fully armored so that attacks from the ground are less of a danger to the pilot. The Aerochaser is deployable from a transporter like a Fire-Bee, but because it is so much larger a transporter can only carry one at a time. Nonetheless, this greater size affords the Aerochaser heavier firepower: Its chin turret contains a 20mm chaingun and a grenade launcher, and its wing pylons can mount a total of four missiles (although this requires Diet emergency approval).

ADP AEROCHASER					28 OP
MANEUVER	-2 Ref	ARMOR	35 KD	WEIGHT	889kg
MOVE	56 (168kph)	STRUCTURE	45 SDP	CREW	One
WEAPONS	WA	RNG	DMG	LOC	SPECIAL NOTES
20MM MG	+1	900m	12D6*	T	*ROF30, 15 bursts.
GRENADE LNCHR	-1	300m	10D6*	T	*10m Area, 15 shots.
SUBSYSTEMS: Spotlights, ejection seat, police-band radio & datalink, lowlight, telescopic & targeting sensors.					

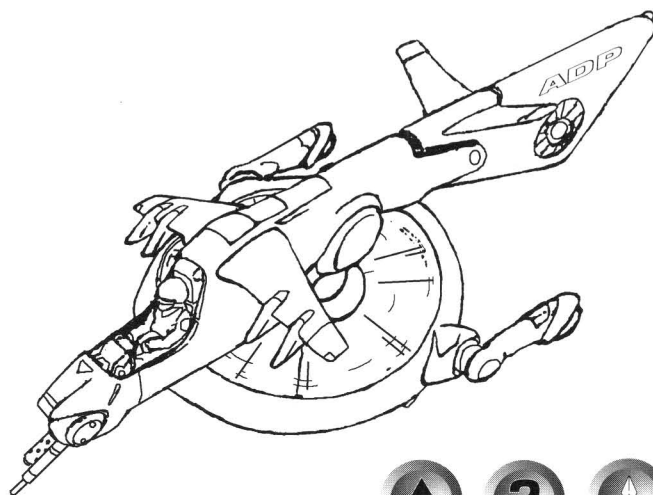

OTHER EX TECH

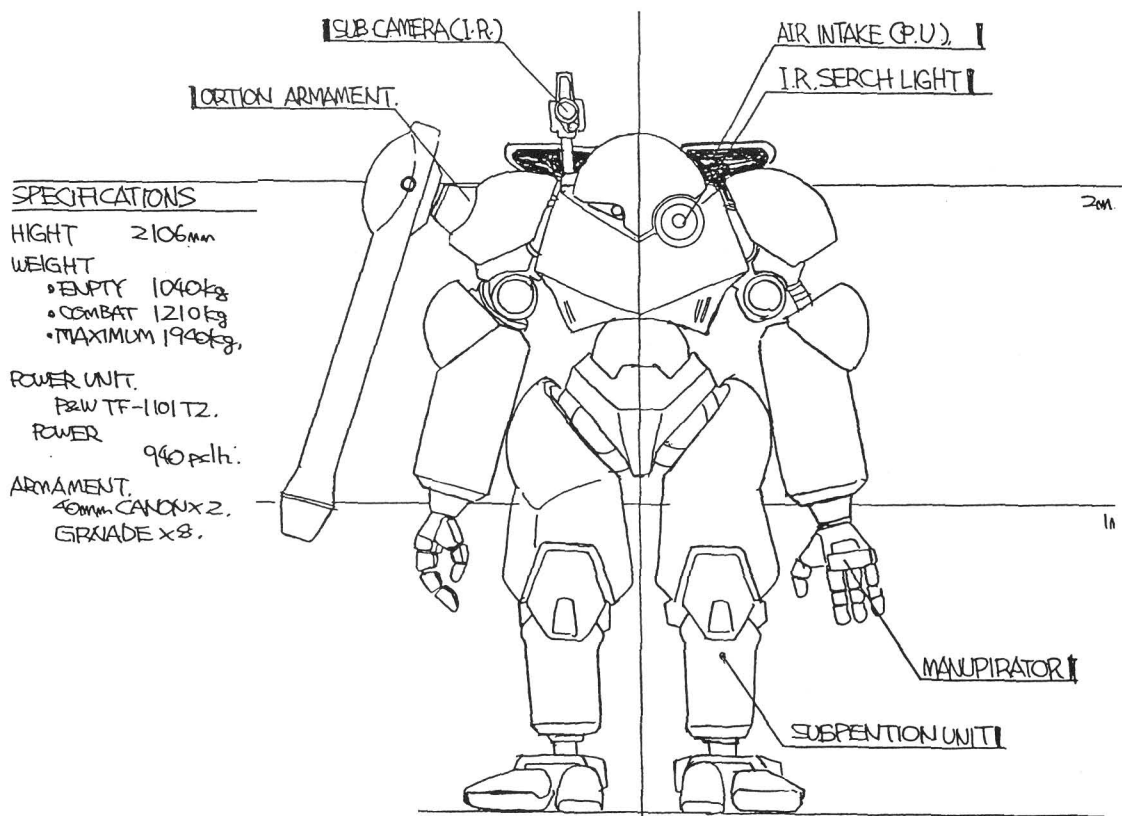

SPECIFICATIONS

HEIGHT 2106mm

WEIGHT

- EMPTY 1040kg
- COMBAT 1210kg
- MAXIMUM 1940kg

POWER UNIT
P&W TF-1101T2.

POWER 940ps/h.

ARMAMENT
40mm CANNON x 2.
GRENADE x 8.

▼MF-405D POWERED SUIT

This European powered suit was designed in 2024 by the German corporation Dimlar GmbH, and was put into development with the hope that it would become the EC's standard production powered suit. Unfortunately, defects cropped up in the testing stages, and the 405 never saw much use. As it turns out, these supposed flaws were largely fabrications inserted into test data by saboteurs working for Genom which was, at the time, pushing its own powered suit (see *BGC* p135) as the EC's ideal armored trooper. As fate would have it, flaws in Genom's own design dropped it from the running as well. Still, the duplicitous Brian J. Mason (never one to throw away any potential asset) secreted away the plans for the 405 and passed them on to his pawns, the Illegal Army, for use as a basis for their own highly modified combat suits.

Despite its checkered history, Dimlar recently reopened Powered Suit File 10042, reviving the 405 project and allowing production to resume. While the design is now 10 years old, the 405 is still an excellent powered suit; the STMLAK-MI-4060 chassis is strong and resilient, the Complex armor plating is quite tough, and the back-mounted power unit uses an IR-defeating exhaust system for its hover jets. The 405 can carry hand weapons in its four-fingered manipulators, and its standard built-in armament is impressive; each shoulder mounts a 40mm cannon (which can fire a variety of rounds) on its own, and the suit normally carries 8 hand grenades. The 405's sensors are rather conventional, relying primarily on a mast-mounted IR subcamera which can perform passive or active scanning (the latter with the aid of a collar-mounted IR searchlight).

Specifications: Height 2.106 m, Empty Weight: 1040kg, Combat Weight: 1210kg, Max Weight: 1940kg, Power Unit: P&W TF-1101T2, Power Output: 940ps/h, Armament: 40mm Cannon x2, Grenade x8.

MF-405D					80 OP
WEIGHT	1210 kg	BATTERY TIME	7.5 hours		
MANEUVER	-3 DEX & REF	RUNNING	Max Move = 6		
STRENGTH	STR 11	JUMP/HOVER	30m/33 (100kph)		
SENSOR RANGE	2 km	COMM RANGE	40 km		
ARMOR KD	45 Hits	STRUCTURE	55 SDP		
WEAPON	WA	RNG	DMG	LOC	SPECIAL NOTES
HAND-TO-HAND	+0	-	11D6*	A, A	*Killing damage.
40MM CANNON	+1	550m	6D6x3	RA	ROF5, 20 bursts, X-Linked.
40MM CANNON	+1	550m	6D6x3	LA	ROF5, 20 bursts, X-Linked.
GRENADES	+0	(150m)	7D6x4	1h	Thrown; Area = 12m.
SUBSYSTEMS					
<ul style="list-style-type: none"> • Life Support (sealed vs Nuclear, Biological & Chemical agents). • Sensor suite: Audiovisual, radio, targeting HUD grants +2 Perception. IR searchlight works in tandem with mast-mounted normal & IR sub-camera (which telescopes, periscope-style, up to 3m). • ECCM System (Rank = 3) and radio scrambler. • Backpack jet system allows suit to "skim" along the surface and perform boosted jumps. Jets are IR-baffled, so exhaust cannot be detected by (and suit cannot be followed with) IR. A called shot at -3, penetrating armor, destroys this system). • Emergency ejection system (blows operator out back of suit). • Quick-change mounts on shoulders. • Desert environment adaptation. 					



K-12B

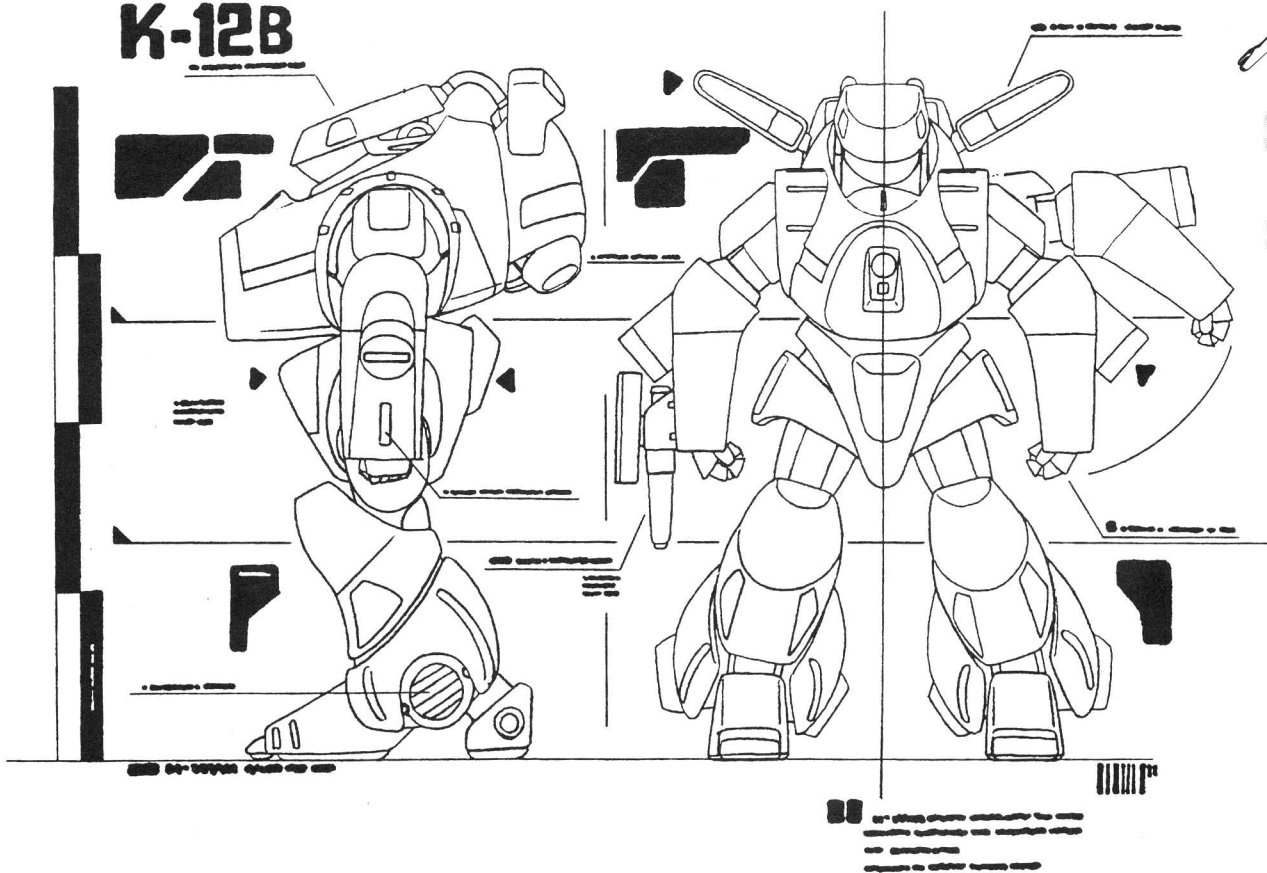

USSD K-12B

77 OP

WEIGHT	1293 kg	BATTERY TIME	6 hours		
MANEUVER	-4 DEX & REF	RUNNING	Max Move = 8		
STRENGTH	STR 12	HOVERING	36 (108kph)		
SENSOR RANGE	5 km	COMM RANGE	150 km		
ARMOR KD	50 Hits	STRUCTURE	55 SDP		
WEAPON	WA	RNG	DMG	LOC	SPECIAL NOTES
HAND-TO-HAND	+0	-	12D6*	A, A	*Killing damage.
LASER GUN	+1	775m	7D6x3	RA	-
(MISSILES)	+0*	2km	3K	LA	*Brilliant (16+die), 2 shots.

SUBSYSTEMS

- Life Support (full sealing vs Nuclear, Biological & Chemical agents, plus 6 hours air/pressure for Vacuum environments).
- Sensor suite: Audiovisual, radio, lowlight, IR, and targeting HUD (+2 Perception). Radar (built into bars which project out over shoulders) increases detection range (not engagement range) by 10x, to 50km.
- ECCM System (Rank = 4) and radio scrambler.
- Backpack rockets allow suit to "skim" along the surface and grant 1.5 G's (cumulative 75 Move) of acceleration for space thrust. Ankle-mounted apogee motors facilitate space maneuvering.
- Emergency ejection system (blows operator out back of suit).
- Quick-change mounts on forearms.
- Zero-G & Vacuum environment adaptation.

▼K-12B POWERED SPACE SUIT

The K-12B is a military powered suit used by USSD armored troops. It is derived from the K-11, using a similar servomusculature, armor, and electronics, but its physical structure is significantly different so as to allow for the inclusion of space maneuvering verniers, rocket boosters, and pressurization systems. These modifications allow the K-12B to function effectively in zero-gravity and vacuum environments as well as on the ground, so the USSD has need for only one type of armored trooper for all its peacekeeping operations, be they terrestrial or extraterrestrial. In fact, the USSD has done its best to make the K-12B (rather than killer satellites) its symbol. In theory, this should reassure any nation who might become subject to USSD intervention that they will face crack armored troops—rather than a series of apocalyptic particle beam strikes.

The K-12B's rocket motors allow it to maneuver and to accelerate at a rate of 1.5 Gs in space, while in atmosphere it can dash across clear ground like a hovercraft in the same way as the K-11. Since recoilless weapons are *de rigueur* for space combat, the K-12B has a laser gun built into its right forearm (instead of a machinegun, whose recoil would be catastrophic in zero-gravity). The left arm's hardpoint can mount a variety of missiles systems for supplemental firepower.

Rumor has it that the K-12B can also use a unique re-entry system: A suit can be loaded inside a three-meter, teardrop-shaped capsule and then dropped from orbit down through the atmosphere toward a target landing site. Once the armored trooper has penetrated the upper atmosphere, the capsule is jettisoned, breaking into dozens of fragments designed to emit the same radar signature as the suit itself. The K-12B can then freefall to the ground, firing retro-rockets just above ground zero (see *BGC Before & After*, page 94, for more on such drops). This re-entry capsule system has never been publicly announced and has never been used in an actual operation—no nation on Earth has ever called upon USSD space troops to seize an area, and nobody really expects such a thing to happen. Thus, it is generally assumed that this system was designed for use on *other* worlds, wherever they may turn out to be... although USSD officials aren't talking.

Note: This is *not* related to the K-12S, which was developed separately.



K-11 JAGER WITH OVER AND UNDER 20MM MACHINEGUN/CANNON SYSTEM.

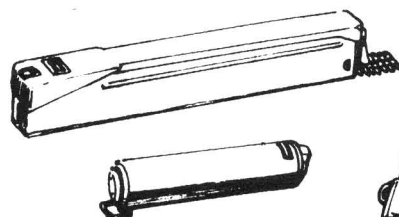
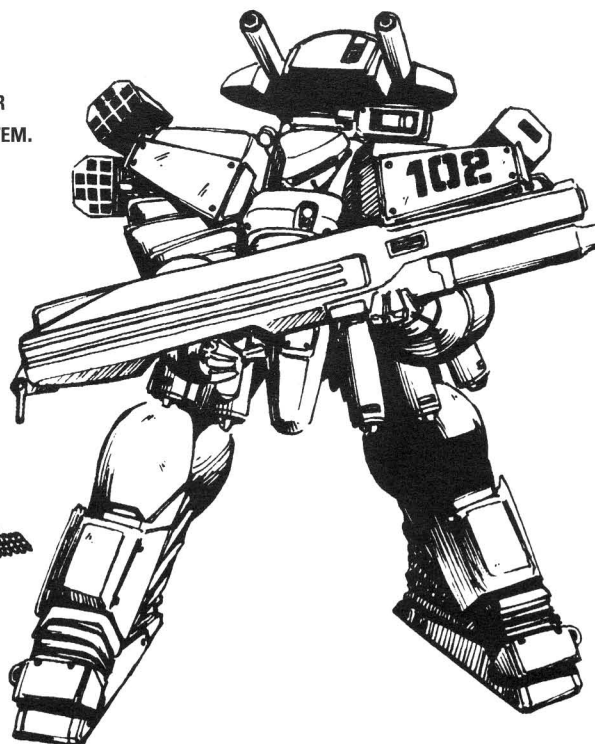

AMMO POD DETAILS FOR 20MM SYSTEM

▼K-11 JAGER

While the K-11 is well-known in MegaTokyo as one of the most powerful weapons in the AD Police's arsenal, the truth is that the K-11 is a military machine which the ADP adapted. Being a military machine, the K-11 has many variations, with different models serving such purposes as reconnaissance, anti-aircraft, anti-tank, engineering, and special operations duties. The K-11 Jager (German for "hunter") is a hunter-killer type, designed to enter contested territories and clear the area of any hostiles encountered, particularly enemy boomers. Therefore, it is equipped with features which are supposed to prepare it for almost any contingency.

The K-11 Jager's chest-mounted seeker bank is optimized for search-and-destroy missions, with silhouette-scanning identification systems and powerful infrathermal detectors. Since the Jager must often enter unknown areas, attacks can come from any direction; to compensate for this, every joint section which has comparatively lesser protection is equipped with *appliqué* armor skirts (based on the French idea of adding a second layer of armor plates over the vulnerable parts of a tank). Still, the best defense is a good offense, so the K-11 Jager is heavily armed. It can mount four rocket pods or missile launchers, and carries a "Gun Launcher" (a handheld, over-under caseless 20mm machine gun and large-bore cannon) and a rotating gun turret is mounted on its back. This turret is effective against airborne targets, ground infantry forces, and even those missiles and rockets capable of destroying battlesuits. The round objects attached to the hip area are clips of extra cannonballs for reloading the Gun Launcher in the field.

Needless to say, the ADP would love to get their hands on a few K-11 Jagers, but no politician would ever allow such a powerful suit of armor to be deployed in the peaceful streets of his city....

K-11 JAGER 116 OP

WEIGHT	1337 kg	BATTERY TIME	6 hours		
MANEUVER	-4 DEX & REF	RUNNING	Max Move = 8		
STRENGTH	STR 10	JUMPJETS	40m Jumps		
SENSOR RANGE	3.5 km	COMM RANGE	100 km		
ARMOR KD	55 Hits	STRUCTURE	50 Hits		
WEAPON	WA	RNG	DMG	LOC	SPECIAL NOTES
HAND-TO-HAND	+0	-	10D6*	A, A	*Killing damage.
G.L. 20MM MG	+1	440m	12D6*	2h	*AP, ROF20, 10 bursts.
G.L. CANNON	+1	670m	7D6x4	"	8 shots, 8m area.
TURRET	+0	300m	8D6*	T	*2 X-Linked, ROF40, 25 bursts.
(MISSILE POD)	+0*	1.5km	2K	?	*Brilliant (16+die), 2 shots.
(ROCKET POD)	-1	555m	14D6	?	ROF10, 3m Area, 10 shots.

SUBSYSTEMS: Life Support (full sealing vs Nuclear, Biological & Chemical agents). • Sensor suite: Audiovisual, radio, lowlight, targeting HUD grants +2 Perception. Modified seeker-bank includes IR & thermographics, and adds special edge-scanning silhouette ID system (instantly IDs any targets, as long as they are already in suit's database). • ECCM System (Rank = 3) and radio scrambler. • Backpack jumpjets replace typical hovercraft engines. • Emergency ejection system (blows operator out back of suit). • Jager has 4 shoulder hardpoints which can mount any mix of Rocket Pods and Missile Pods (as listed above). • Top turret can attack targets above, can attack man-sized targets at no penalty, and can attack incoming missiles at no penalty as a defensive Action (which can be "aborted" to—see *BGC* p.41).



▼ D-ZERO BATTLEMOVER

This was one of the six entries into the US D.O.D.'s December 2032 competition to select a new Battlemover. Made by Dimlar GmbH, the D-Zero is armed with a 68mm pulse cannon (with a high-efficiency muzzle brake) and a wide-angle 35mm vulcan gun (fed from a large drum magazine). It is equipped with tires on its feet for high-speed travel, two telescoping flexible manipulators for human-hand-sized work and a nose-mounted sensor cluster which can extend forward on a mast to look around corners. In addition, it is one of the few mecha which can transform, switching between high-mobility land mode and close-combat humanoid mode. Note that the fingerlike extensions which deploy from the mecha's "toes" for transformation can also be used for improved off-road capability.

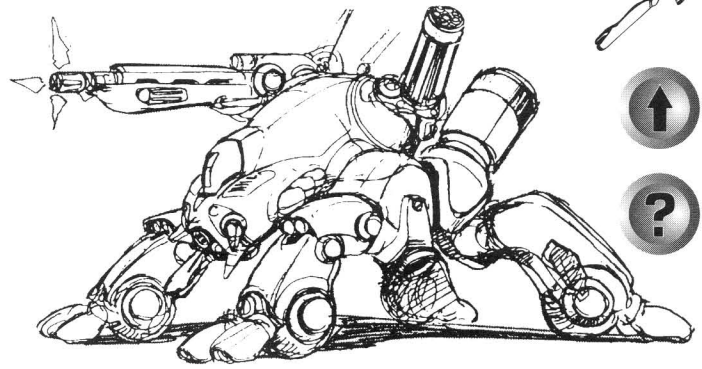

D-ZERO 166 OP

WEIGHT	3321 kg	STRENGTH		13	
CONFIGURATION	MANEUVER	SURFACE		JUMP	
Humanoid Mode	-3	17 (50kph)		?	
High-Mobility Mode	-4	37 (112kph)		?	
ARMOR	1-3. TORSO	4-5. LEGS	6-7. ARMS	8. HEAD	
60KD	120 SDPe	75 SDPe	60 SDP	40 SDP	
9. WEAPONS	WA	RNG	DMG	LOC	SPECIAL NOTES
HAND-TO-HAND	+0	-	13D6*	A,A	*Killing Damage
PULSE CANNON	+2	676m	8D6x4	T	ROF 3.
VULCAN GUN	+1	360m	8D6x2	T	ROF50, 20 bursts
10. SUBSYSTEMS: Desert & arctic environment adaptation • 11km Sensors with audiovisuals, targeting, lowlight, HUD (+1 Perception), IR, Thermograph. • ECCM suite (Rank 5), 100km radio w/ scrambler, POW-1 computer system. • Back-mounted braking rockets / jumpjets. • Life support for 6hrs and NBC sealing. • Emergency ejection system.					



FINGER-EXTENSIONS

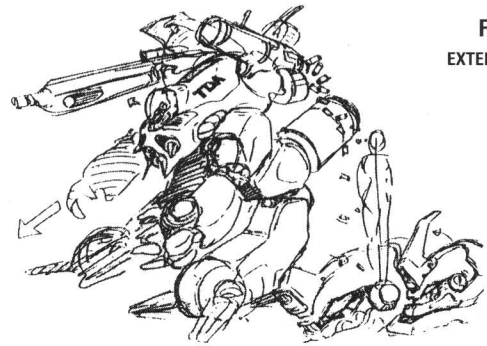

▼ D.D. MASS-PRODUCTION TYPE

If Flint had kept up with his plan, the mass-produced model of the D.D. may have wound up looking like this. The Mass-production version would forego the expensive transformation ability and would also lack the troublesome J-1 system (and that micro-neutron bomb!), but it would still be one of the most advanced and deadly mecha on the battlefield.

D.D. MASS-PRODUCTION TYPE 237 OP

WEIGHT	4664 kg	STRENGTH		14			
CONFIGURATION	MANEUVER	SURFACE		JUMP			
Humanoid	-2	36 (110kph)		75m			
D10	LOC	KD	SDP	D10	LOC	KD	SDP
1	Head	100	50	6	L. Arm	100	90
2-4	Torso	100	160	7	R. Leg	100	100
5	R. Arm	100	90	8	L. Leg	100	100
9. WEAPONS	WA	RNG	DMG	LOC	SPECIAL NOTES		
HAND-TO-HAND	+2	-	14D6*	A,A	*Killing Damage		
GATLING GUN	-1	1.6km	7D6x3*	T	*AP, ROF40, 25 bursts.		
GRENADES	-2	3km	2K	T	Blast radius 10m		
10. SUBSYSTEMS: Desert & arctic environment adaptation • Sensors (7km range) with audiovisuals, targeting, lowlight, HUD (+1 Perception), IR "eye" spotlights. • ECCM suite (Rank 6), 100km radio w/ scrambler, POW-1 computer system. • Back-mounted braking rockets / jumpjets. • Silent Running (Perception vs 18). • Life support for 6hrs and NBC sealing. • Emergency ejection system. • Twin micromanipulators (mounted in chest) can do work of human-sized hands.							



BUBBLEGUM CRISIS EX – THE EXTREME EXPANSION FOR BUBBLEGUM CRISIS



MISSILE: BI-BAND (MULTIPLE SENSOR-CAPABLE LOCK) GENIUS MISSILE. THE SUIT CAN MOUNT FOUR OF THESE. THE CASING POPS OPEN WHEN THE MISSILE IS LAUNCHED.

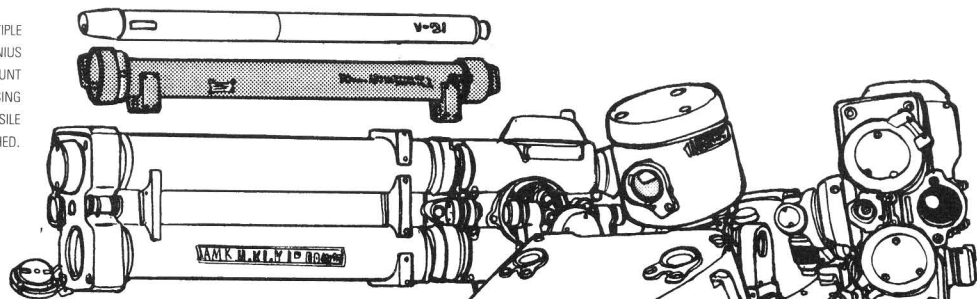

THREE-WHEELER MODE (SHOWN WITH OPTIONAL VULCAN GUN): USED FOR HIGH-SPEED MOVEMENT. IN THREE-WHEELER MODE, THE BIG TIRE IS LOWERED AND THE "SKI" LEGS ARE RETRACTED INTO THE THIGHS. THE DOME ON TOP IS A CAMERA.

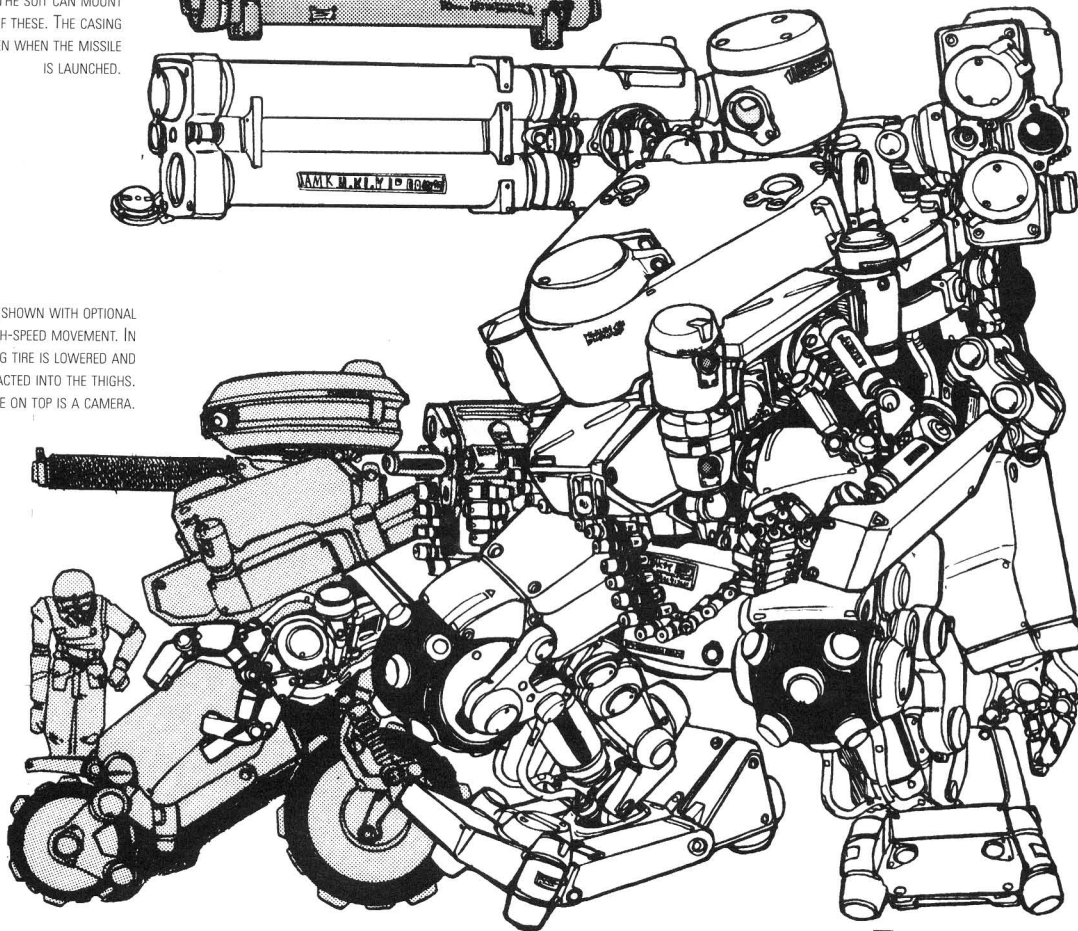

IN PROPORTION TO A HUMAN.

ID CARD: CAN'T GET A PAYCHECK WITHOUT ONE OF THESE!

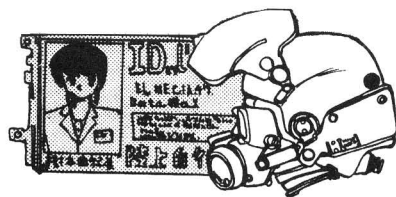

HELMET AND MASK SYSTEMS ARE INTEGRATED.

FEMALE PILOT: IN WORLD WAR TWO, THE GERMAN AIRFORCE ACKNOWLEDGED THE CAPABILITIES OF WOMEN AS PILOTS. IN MODERN TIMES, THIS CONCEPT IS TAKEN SERIOUSLY.



THERE IS A SMOKE DISCHARGER SYSTEM HIDDEN IN THE CHEST.

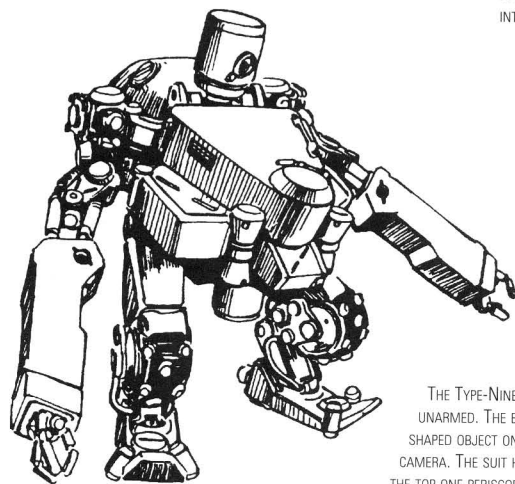
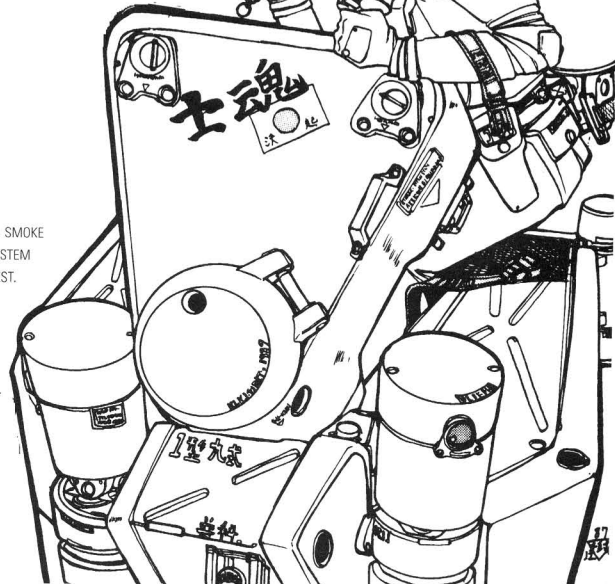

THE TYPE-NINE IS SEEN HERE UNARMED. THE BARREL-SHAPED OBJECT ON TOP IS A CAMERA. THE SUIT HAS TWO; THE TOP ONE PERISCOPES TO ABOUT 3 METERS.

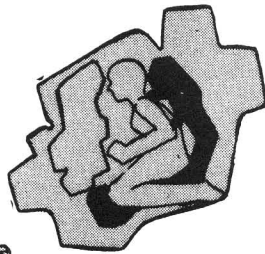

THIS IS HOW THE SUIT IS RID-DEN; THE BLACK AREA IS THE SEAT, WHILE THE OUTLINED AREA DENOTES WHERE THE PANEL IS IN RELATION TO THE PILOT.

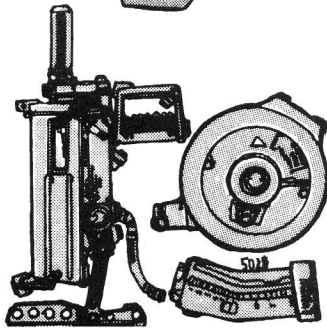

MACHINEGUN: 17.5MM. CAPABLE OF BEING BELT FED IN PREFERENCE OF THE 50-ROUND CLIP OR 200-ROUND DRUM SYSTEM. USES CASELESS AMMO, AND A LASERSIGHT AUGMENTS AIMING.

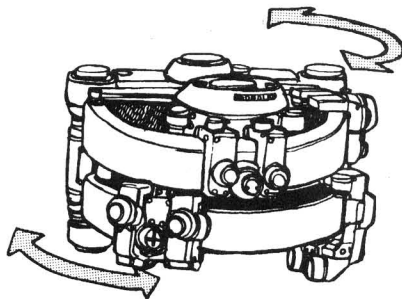

RING RAIL: TOP AND BOTTOM SECTIONS CAN MOVE INDEPENDENTLY OF EACH OTHER. THERE ARE FOUR COUPLING UNITS ATTACHED TO THE RING; THE TOP RING IS FOR WEAPONS SYSTEMS, PRIMARILY MISSILES AND VULCAN CANNON, WHILE THE BOTTOM RING IS FOR THE LARGE MANIPULATORS.

THE LARGE MANIPULATOR CAN BE FOLDED OR REACH TO FULL EXTENSION—THIS UNIT LOCKS ONTO THE BODY RING. IN THE EVENT THAT THE TYPE NINE IS ARMED WITH THE VULCAN GUN, THE LARGE MANIPULATOR IS REPLACED WITH THE VULCAN GUN'S MAGAZINE.

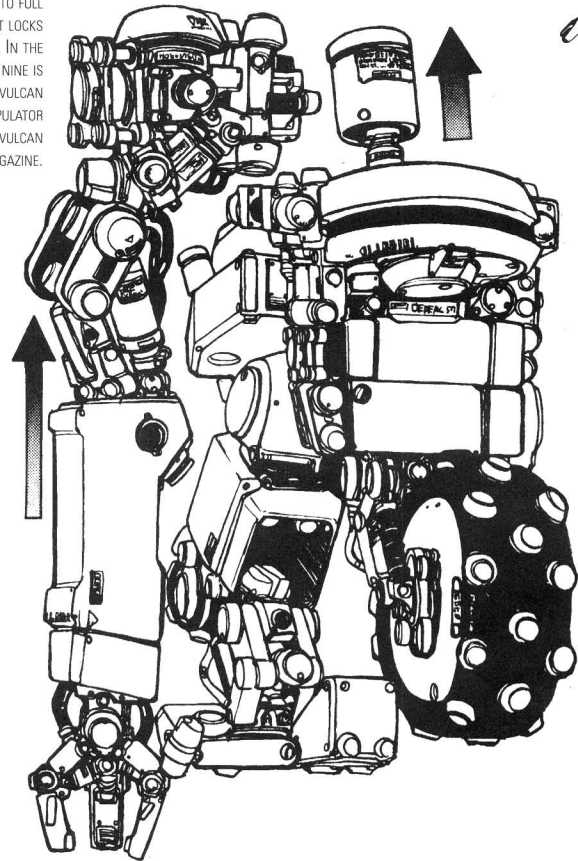

TYPE-9 BATTLEMOVER

174 OP

WEIGHT		1053 kg		STRENGTH		12	
CONFIGURATION				MANEUVER		SURFACE	
Anthropomorphic Mode				-3		7 (20kph)	
Three-Wheeler Mode				-5		27 (80kph)	
3D6	LOC	KD	SDP	D10	LOC	KD	SDP
3	Camera	60	33	9-12	Torso	60	110
4-5	SubArms	60e	33e	13-15	Legs	60e	77e
6-8	Arms	60e	55e	16	Wheel	40	22
17. WEAPONS		WA	RNG	DMG	LOC	SPECIAL NOTES	
HTH (SUBARMS)		+0	-	12D6*	a,a	*Killing Damage	
HTH (MAIN ARMS)		-1	-	7D6x4*	A,A	*Killing Damage	
SMOKE LNCHRS		-2	100m	*	T	*6 Perc., 10m radius, 4 shots.	
17.5mm MG		+0	210m	11D6*	1H	*AP, ROF25, 50/200/+ shts.	
MISSILES		+0*	2km	4K	T	*Genius (20+1D10)	
(VULCAN GUN)		+0	712m	14D6*	(T)	*AP, ROF60, 1000 shts	

18. SUBSYSTEMS: Sensor systems include audiovisuals (7km), Thermograph, Lowlight, x64 Magnification, Targeting systems. • ECCM suite (Rank 5), 100km radio w/ scrambler, POW-1 computer system. • Life support for 6hrs and NBC sealing. • Top camera can be extended 3 meters up, periscope style. • Subarms can fold into body when not in use. • Ring Rail system can mount four items (usually two 2-shot missile pods and either two heavy arms or a vulcan gun and ammo drum). • Transformable to three-wheeled high-speed mode (takes one action). • Emergency ejection system.

▼TYPE-9 BATTLEMOVER

In 2030, the Japanese Ground Self Defense Force, armed with a substantial surplus in its budget, set out to create a mobile weapon system which had tanklike firepower but could operate in areas normally inaccessible to tanks.

That mobile weapon was the Type-9 Armored Infantry Suit, which amends the defects in the NBC defenses of K-series suits, offers more protection for the operator, and makes up for its dead angles with heavier armor plating. The Type-9 and the K-series do have similar technical aspects in their leg sections and manipulators, but the Type-9's primary design features incorporate artificial limb research done by civilian universities and hospitals, allowing a substantial increase in the combat potential of the standard infantryman.

The Type-9's configuration requires that its controls be significantly different from those of the K-series powered suits. While a Powered Suit synchronistically mimics the movements of its pilot, a Type-9's pilot sits in a cockpit and uses pedals and joysticks. This arrangement allows the pilot of a Type-9 to be protected on all sides by thick armor plating, giving him better shielding than a K-suit. Hence, Type-9s are more appropriate for use in extreme situations.

During the Type-9's initial evaluation period in 2030, its high cost and lack of an official Go-Ahead for mass production meant that only a few pre-production test units were built. However, the rash of Tinsel City guerrilla incidents in 2032-34 showed how effective the combination of a compact frame and heavy firepower could be, so an immediate Go-Ahead has been given for mass production in late 2034.

Specifications for the Type-9 Small Frame Armored Infantry Suit: Total Height: 208cm; Weight (fully loaded): 1053kg; Crew: 1; Top Speed: 20kph (anthropomorphic mode), 80kph (three-wheeler mode); Armament: Hand Machinegun x1, Missile Pod x2, Optional Vulcan Gun x1.

Anime Notes: The Kanji painted upon the top of the Type-9 is *shikon*, which means "spirit of the warrior", while the rising sun sticker directly beneath it says *kekki*, which means "going into action".



▼ JAPAN'S SELF-DEFENSE FORCE

The Japanese Self Defense Force (JSDF) is not an army. That's the letter of the law, but it's really all semantics. While the JSDF's annual budget is restricted to 3% of Japan's GNP, that's still nearly 14 trillion yen. That's the third highest military budget in the world! However, this doesn't mean that they're the world's third most powerful army. Most of the JSDF's budget goes into equipment. . . equipment sold primarily by Genom. Each soldier carries a small fortune in equipment, and their K-15 battlesuits cost even more.

This is one of the JSDF's main problems: their equipment is so advanced that their own technicians can't perform effective maintenance and repair. They frequently have to rely on corporate (you guessed it, Genom) specialists. By pressuring the military into buying their equipment, then making sure that the JSDF can't use that equipment without their help, Genom has taken almost complete control of Japan's military strength.

The JSDF's other big problem is that it's limited to only 230,000 full-time personnel (a mere one-sixth the size of the Korean Army) due to the anti-war sentiment of the populace. These active members are called "Self-Defense Officials" (remember, Japan has no "soldiers"). Those who resign are transferred into the reserves and have once-a-month training duty, but there's no penalty for skipping out on this training, so most do. As for Japanese officers, many of them freely admit that the JSDF is next to useless, underscoring the fact that they're the "Paper Tiger" of Asia. Some think that this idea is actually disinformation to placate nervous neighbors, but if it came down to it, it's unlikely that the JSDF could adequately defend Japan without the help of Genom.



▼ JSDF INFANTRY GEAR

The JSDF's equipment is typical of the high-tech military kits worn and carried by most soldiers on the battlefields of the 21st century.

JSDF INFANTRY GEAR

KIT WEIGHT	20.3 kg	OVERALL KD	22
ENCUMBRANCE	-3 Dex*, -2 Ref, -3 Move	HELMET KD	25
		TORSO & LIMB KD	20
*DEX penalty is reduced by 1 if not wearing the helmet. Armor is effective against all types of damage, including bullets, blades, blunt trauma, and fire.			
LONGARM	Assault Module (<i>BGC B&A p97</i>) equipped with underbarrel Grenade Launcher (<i>BGC p141</i>)		
SIDEARM	Combat Handgun (<i>BGC p141</i>)		
MELEE WEAPON	Knife (<i>BGC p141</i>)		
OPTICS	Lowlight, x32 Magnification, +2 Targeting.		
EQUIPMENT	Radio w/ satellite uplink, gasmask (30 mins air), dog-tags, mineproof boots, 6 reloads for each weapon, POW-2 mini-computer, canteen, backpack (stores 1 week food, 50m rope, camp kit, medical kit, socks & undies), plus optional mission-specific equipment.		

▼ TYPE-07 AIRDROPPABLE AUTOTANK

This unmanned armored unit was designed to be parachuted into the battlefield to hunt enemy tanks, but the advent of Battle Boomers soon rendered the Type-07 and its ilk obsolete. Today, not many Type-07's are left; the few that remain are generally used as perimeter patrol/defense units. The Type-07 is armed with a pair of two-shot anti-tank missile launchers, which complement its main weapon: a 105mm cannon which fires belted shells (HEAT, APFSDS, HE, and APPS are all available). This is the same weapon that the MSX-01 uses (see *BGC p86*).

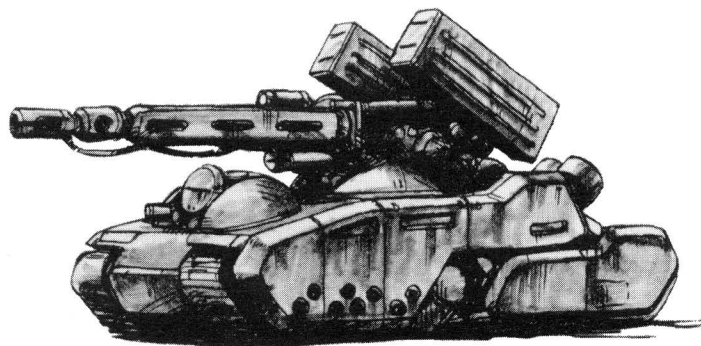

TYPE-07 AUTOTANK						76 OP
MANEUVER	n/a	ARMOR	2 Kills	WEIGHT	11.3 tons	
MOVE	33 (100kph)	STRUCTURE	4 Kills	CREW	-0-	
WEAPONS	WA	RNG	DMG	LOC	SPECIAL NOTES	
105MM GUN	+1	4km	4K*	T	*AP, 35 shots.	
MISSILES x4	+0*	8km	7K	T	*4, Smart (18 +die).	
SUBSYSTEMS:						
• Onboard AI autopilot (Level 4; Total combat value = 8+1D10).						
• Caterpillar treads ignore most terrain restrictions.						
• Type-07 is airdroppable with addition of parachute system.						
• Basic sensor suite includes thermograph & lowlight optics.						



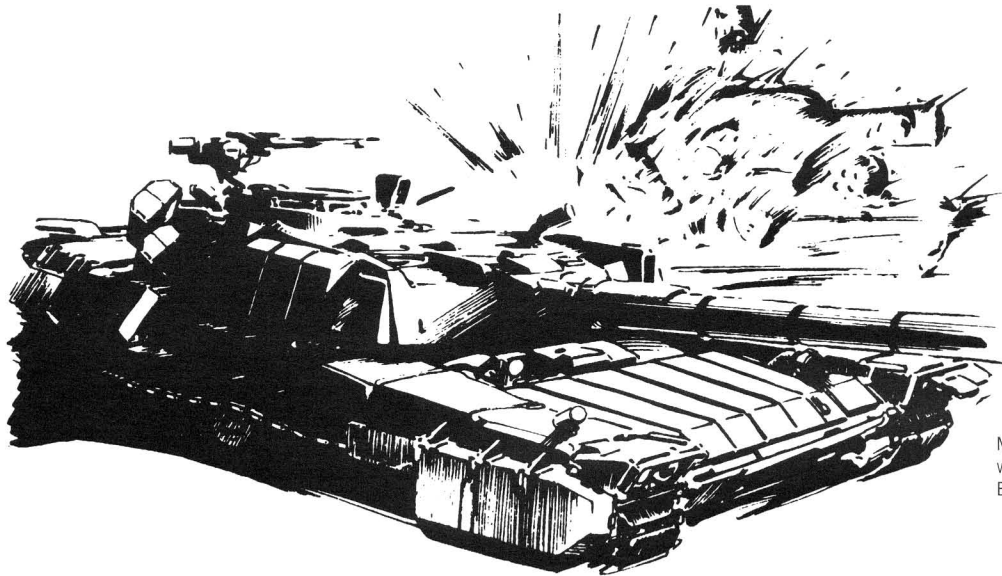

M-262 MBT IN COMBAT WITH A BU12 ANTI-TANK BOOMER



M262 MAIN BATTLE TANK 10 OP

WEIGHT 51 tons		SPACE 2 crew			
MANEUVER -6 Ref		MOVE 36 (108kph)			
1D10	LOCATION	ARMOR	STRUCTURE		
1-2	Turret & Cannon	4 Kills	4 Kills		
3-6	Main Hull	4 Kills	7 Kills		
7-8	Right Tread	4 Kills	3 Kills		
9-10	Light Tread	4 Kills	3 Kills		
WEAPONS	WA	RNG	DMG	LOC	SPECIAL NOTES
120MM GUN	+2	4.5km	4K*	T	*AP, 90 rounds.
CUPOLA MG	+0	300m	7D6	T	ROF 20, 200 rounds.
SMOKE LNCHRS	-2	100m	-5 Per*	T	*Blast 20m, 8 shots.
SUBSYSTEMS					
<ul style="list-style-type: none"> Automated Loader. Semi-stealth characteristics (-4 Perception for Radar). Emergency damage control system. Microwave rangefinder system. 					

▼M262 MAIN BATTLE TANK

Representative of the 21st century breed of main battle tanks, the M262 is powered by a gas turbine engine, has a high power-to-weight ratio, and is armed with a 120mm rifled gun. This weapon is insulated with a memory-metal thermal shroud, and its computer-stabilized fire control system utilizes a microwave rangefinder for precision engagements of mobile and stationary targets whether the tank is stopped or moving. APFSDS-DU-T rounds are most often used for tank-killing, but the tank carries an assortment of ammunition in its armored, 90-round ammo compartment. The gun is fed by an automated loader, which eliminates the need for a human loader; Indeed, thanks to onboard automation, the tank only needs a two-man crew. In case the tank is disabled, they have access to three emergency exit hatches (front, rear, and top), and if necessary the MBT can operate on autopilot. The entire MBT is armored with Chobham-2 and sports additional reactive plating. Its low-to-the-ground design results in a small overall profile, but the M262 still employs semi-stealth characteristics in case of attack by radar-guided missiles. The whole tank is NBC-sealed, and a computerized Explosion/Fire Detection and Suppression system detects and extinguishes fires in the crew compartment in the blink of an eye. Still, despite all these advanced systems, the M262 is outclassed by Genom's Battle Boomers. There are many variants of the M262, including a recovery vehicle type (see p.23).

▼STRIKE HORNET

This is the military version of the Hornet high-speed combat chopper, used by the JSDF and other military forces. Its cockpit is fully armored and enclosed with a "Linear Seat" style VR control system, and it is armed to hunt and destroy tanks. Its chin-mounted 30mm chaingun fires depleted uranium bullets, backing up its four missiles.

STRIKE HORNET 57 OP

MANEUVER -2 Ref		ARMOR 40 KD		WEIGHT 4454kg	
MOVE 23 (375kph)		STRUCTURE 60 SDP		CREW Pilot, Gunner	
WEAPONS	WA	RNG	DMG	LOC	SPECIAL NOTES
30MM MG	+2	1200m	14D6*	Fus	*AP, ROF = 20.
MISSILES x4	+0*	4km	8K	Ws	*Smart (18 +die).
SUBSYSTEMS: Armored cockpit with HUD & ejection seats, scrambled radio & satellite uplink, sensors (IR, lowlight, thermograph & targeting).					

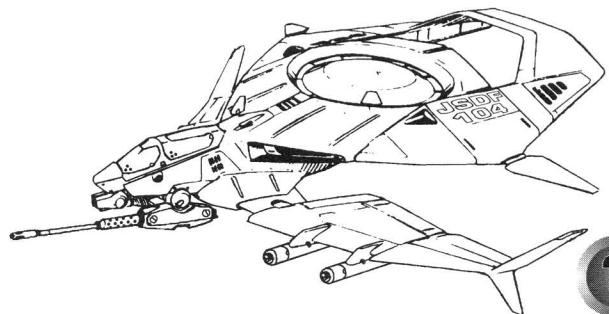



▼ MISCELLANEOUS GEAR

Listed here are assorted bits of personal gear and equipment which appeared in the videos at one point or another. Your characters may have a use for some of these items, especially if they're going into combat or some other dangerous mission... but we all know players never do *that*, right?

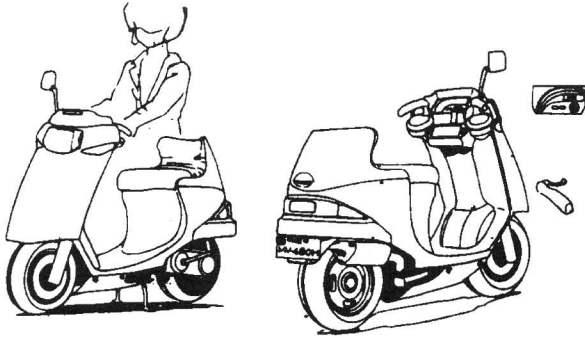
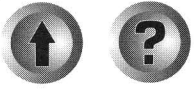

▼ NENE'S SCOOTER

Since Priss', Linna's, and Sylia's rides each got their own writeups. For the sake of fairness, Nene's "precious limousine" deserves its own writeup as well... or so they say. Made by Honda, it uses a trigger-type accelerator rather than the old roller-type.

NENE'S SCOOTER				3 OP
VEHICLE	SDP	MANEUVER	MOVE	COST
SCOOTER	15	-3	30 (90kph)	¥50,000K
Not very cool, but very VERY cute... and not a bad choice for a city as crowded as MegaTokyo. Its easy to find parking, and who'd want to steal it?				

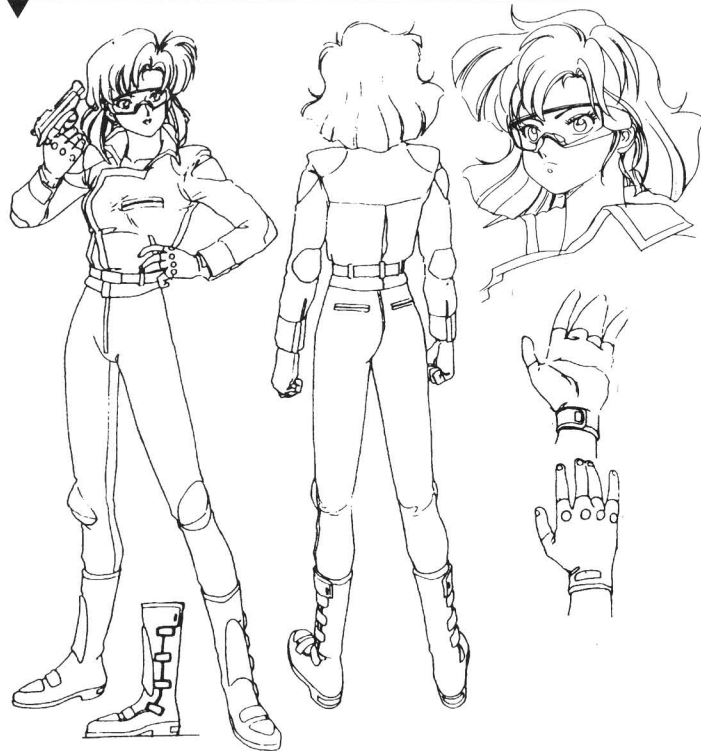

▼ FIGHTING GEAR

Although this set of gear was only seen in the *BGC* anime series when it was used by Vision (during her music video for "Say Yes"), gear like this would be handy for just about any player-character who's expecting trouble... or looking for it. This set includes a pair of bullet-resistant shades (able to stop a .22 or so), a Kevlar motorcycle suit (capable of stopping a 9mm or .40-caliber bullet), shooting gloves, biker boots, and a Beretta M85 .380-caliber semiauto pistol (with an 8 shot clip).

FIGHTING GEAR			2 OP
ARMOR WEIGHT	1.9 kg	OVERALL KD	13
ENCUMBRANCE	-1 Dex, -0 Ref, -0 Move	TORSO & LIMB KD	13
		SHADES KD	8
*DEX penalty represents restricted mobility without affecting response time. Armor is good for stopping bullets and road rash, but is not effective against blades, blunt trauma, and fire.			
WEAPON	.380 Beretta M-85		
OPTICS	Bulletproof shades.		
EQUIPMENT	2 reloads for weapon, gloves, boots.		

▼ BERETTA M85

Used by Vision in her "Say Yes" video, the Beretta M85 is one of the most capable weapons in its class, packing a respectable punch while still retaining a small size for the sake of concealability. A good choice as a backup weapon.

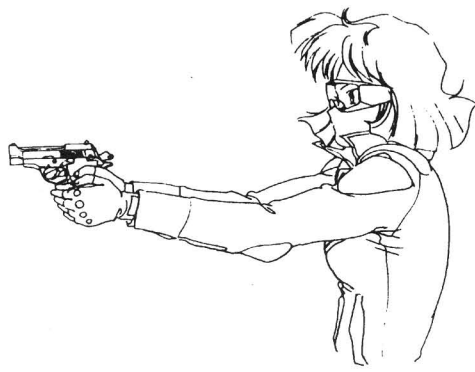

BERETTA M85							3.5 OP
WEAPON	RNG	WA	DC	SHOTS	ROF	COST	
BERETTA M85	30m	+0	4D6+1	8	2	¥35,000	
Blowback operated .380-caliber semiautomatic pistol manufactured in Italy. Features fixed front blade sight, drift-adjustable rear sight, gloss black plastic grips, quick takedown and easy-access safety. Weight is 0.786kg, length is 17.2cm overall.							



▼POLYCERAMIC SWITCHBLADE

This type of pocket knife was a favorite weapon of Priss' back in the dark days before she joined the Knight Sabers, back when she ran with a motorcycle gang. She actually tried to attack Sylia with one during their first meeting (see *Hurricane Live 2032*).

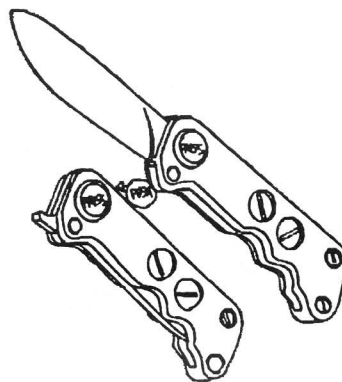

POLYCERAMIC SWITCHBLADE 0.25 OP

WEAPON	RNG	WA	DC	SHOTS	ROF	COST
SWITCHBLADE	2m	+0	2	-	-	¥2,500

Spring-loaded pop-out blade activated by thumb-pushbutton on handle. Blade is made of a polyceramic material which is tougher and lighter than steel, and can be considered AP vs any soft armor (i.e., Kevlar, heavy leather, etc.).

▼POCKET MAGNUM

A solid, reliable wheelgun which Priss favored back in her motorcycle-gang days (before she had to worry about shooting it out with Boomers). Its power is equivalent to a .41 Magnum, and Priss has always preferred basic iron sights for aiming purposes (see *Hurricane Live 2032*).

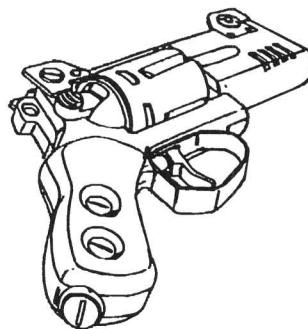

POCKET MAGNUM 4 OP

WEAPON	RNG	WA	DC	SHOTS	ROF	COST
POCKET MAG	30m	+0	5D6+2	6	2	¥40,000

Double-action revolver built from weatherproof carbon-fiber composites sporting a counter-balanced heavy barrel with assorted lengths available (each inch of barrel grants 10m of range—Priss' was a 3-inch model).

▼MULTI-DECRYPTOR

This handheld decoder was scratch-built by Nene a few years ago to get through various sorts of electronic locks. A decryptor like this one can bypass most common types of electronic locks, including alphanumeric codes, card-readers, and voiceprint scans. It works on a successful use of the character's High-Tech, Espionage, or Hacking (+INT) skill (see *Hurricane Live 2032*).

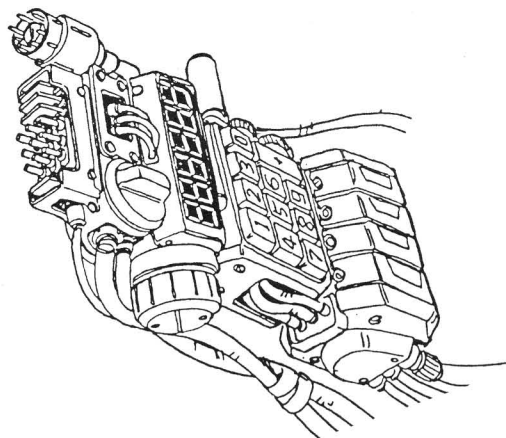

MULTI-DECRYPTOR 5 OP

Dedicated POW-1 microcomputer loaded with algorithmic codebreaking software. Connecting the device to the lock requires a TECH + (High-Tech, Espionage, or Hacking skill) roll vs half the lock's Target Number rating. Once this is done, the character can actually roll to open the lock, taking (10 minus success margin) Phases. Cost = ¥60,000.

▼CUSTOM SPORTSBIKE

This is the crotch-rocket that Priss drove back when she was 17. Like many 21st century motorbikes, it is a forkless design with an all-ceramic engine, and Priss souped it up with loads of customized parts. Dig that cool "Priss" kanji on the side of the fairing! (See *Hurricane Live 2032*).

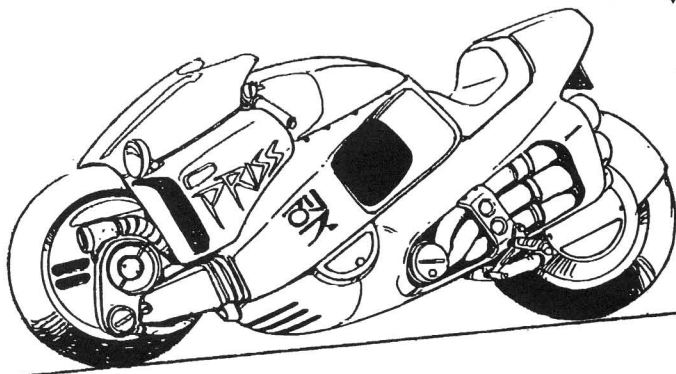

CUSTOM SPORTSBIKE 7.5 OP

VEHICLE	SDP	MANEUVER	MOVE	COST
CUSTOM SPORT	23	-2	90 (270kph)	¥800K

All-ceramic, friction-resistant engine, forkless suspension, electronic HUD instrumentation, souped-up parts for increased performance. Is it street-legal? Welllllll...

100% CHARACTERS

100% CHARACTERS

52



CHARACTERS REVISITED

Bubblegum Crisis spans many genres, from cyberpunk to super-heroes. Even between *BGC* and *AD Police*, the tone and focus change from super-heroic to gritty street-level action. When creating the non-player characters for these shows, we stayed within each show's respective style, which meant that characters in *Crisis* and *Crash!* (which were built for a super-heroic level setting) tended to be higher-powered than those in *AD Police* (which were designed at the Incredible level of an action movie). For those of you who prefer a more low-powered, cyberpunk style in your *BGC* game, we present Incredible (action movie) level stats for the *Crisis* and *Crash!* characters, designed to fit more comfortably within the *AD Police* campaign type.

Use of these stats is purely optional, based on the power level desired by the Referee in a given campaign. They DO NOT supercede the stats from the *BGC RPG*, but simply provide another choice of play style. We designed Fuzion™ and the *BGC: RPG* to run the gamut of genres and styles, and these stats are simply designed to offer the referee more flexibility. Referees should be careful about flipping back and forth between the styles, however—if you start your campaign at the Incredible level, we recommend sticking with those stats throughout your game to avoid confusion. Due to fan requests, we've also included some character gallery art for some of the main characters. You guys just can't seem to get enough of Nene

In addition, we have refined the Fuzion™ Strength Feat mechanic and present the new system below. This task-based system premiered in the *Armored Trooper VOTOMS RPG* and will be adopted as the standard Strength mechanic in future versions of Fuzion™. *BGC* Refs may use either the original Strength Chart in the *BGC RPG* or this new method at their discretion.

▼ LIFTING THINGS, AND OTHER FEATS OF STRENGTH

One action that doesn't fall into the realm of the everyday in Fuzion™ are feats of strength. This is when reality must compromise with fiction, as many settings deal with super-heroes and giant robots as well as more realistic types, and we have a special mechanism for just that situation.

We deal with the problem of super-heroic abilities in Fuzion™ by making feats of Strength and Lifting another type of Action and ignoring the real physics. However, the resolution of this action is a little different than most; in a Strength Feat action, you'll roll only 1D6 and add your STR Characteristic against a difficulty listed below.

Example 1: Regular Man has a STR of 4. He can easily pick up his son (a roll of 1 out of 6) or his wife (3 out of 6) but can barely lift his buddy (5 out of 6). On the other hand, Titanic Man has a STR of 28. He doesn't even think about lifting anything smaller than a small ship (1 out of 6), regularly lifts battleships (3 out of 6), breaks a sweat lifting an aircraft carrier (5 out of 6), but still can't get a mountain up!

Example 2: Regular Man has a STR of 4. He can easily bend plastic (a roll of 1 out of 6), but he's going to be working to break a board (3 out of 6) and could barely bend aluminum (5 out of 6). On the other hand, Titanic Man has a STR of 28. He easily bends anything below Unobtainium (our patented name for any super-heroic supermetal), but still can't bend anything he wants.

STRENGTH FEAT TABLE

Difficulty	To Lift a:	To Bend or Break	To Throw a Baseball:
2	Heavy bag of groceries	Balsa wood	5m/yds
5	Child, 2 heavy bags of groceries	Plastic	10m/yds
7	Adult female	Wood boards	40m/yds
9	Adult male	Aluminum	80m/yds
11	Lion, 2 men	Iron	City block (110m/yds)
13	Motorcycle, Bear		1/2 mile
15	Small Car	Steel	1 mile
17	Large car, Elephant		2-5 miles
19	Small Semi-truck	Hardened steel	6-10 miles
21	Light Tank		11-20 miles
23	Small Jet	Titanium	21-40 miles
25	Battle Tank, Whale		41-80 miles
27	Large jet, Train	Unobtainium	81-160 miles
29	Small Ship, Building		161-300 miles
31	Battleship, Lg. Building	Super Unobtainium	Into orbit
33	Aircraft Carrier		Out of orbit
35	Mountain	Anything	Out of Solar System

▼ THROWING

Another area where the everyday goes beyond reality in some Fuzion settings is throwing. When super-humans and demigods start tossing cars around, throwing stuff can get a lot more interesting. Which is why we invented the Baseball Test.

In Fuzion™, we use the Baseball Test to create a benchmark for what can be easily thrown. A baseball represents any aerodynamic object that weighs less than 3 lbs (roughly 1 kg) that can be hurled with one hand. This includes grenades, footballs, basketballs, frisbees, bottles and other small, inconsequential items that can be easily thrown. When throwing something that passes the Baseball Test, simply add your STR to a D6 die roll, just as with a Strength or lifting feat, and try to beat the Difficulty for the Distance you're throwing. If you beat the desired Difficulty, you've thrown it that far. Example: Amazing Man (STR 15) wants to throw a baseball 5 miles (Difficulty 17). He can easily do this.

If you fail, compare your final roll to the first Difficulty value you could beat. This will determine how far the throw actually went. Example: Amazing Man (STR 15) wants to throw a baseball 90 miles (Difficulty 27). He fails by 5 points (27-5=22) This corresponds closest to a 21 Difficulty, which means he only tossed the ball 11 to 20 miles.

Heavier than a Baseball?: To throw something that doesn't pass the Baseball Test, here's the trick: simply add the Difficulty of Lifting the object to the Difficulty of Throwing it the desired distance to get the final Difficulty. Example: Awesome Man (STR 32) can easily throw a baseball into orbit (Difficulty 31). However, if he tries it with a small car (Diff=15), the difficulty rises to 46 (31+15=46). The best he could do reliably would be to toss that car a few miles or so (15+17=32)

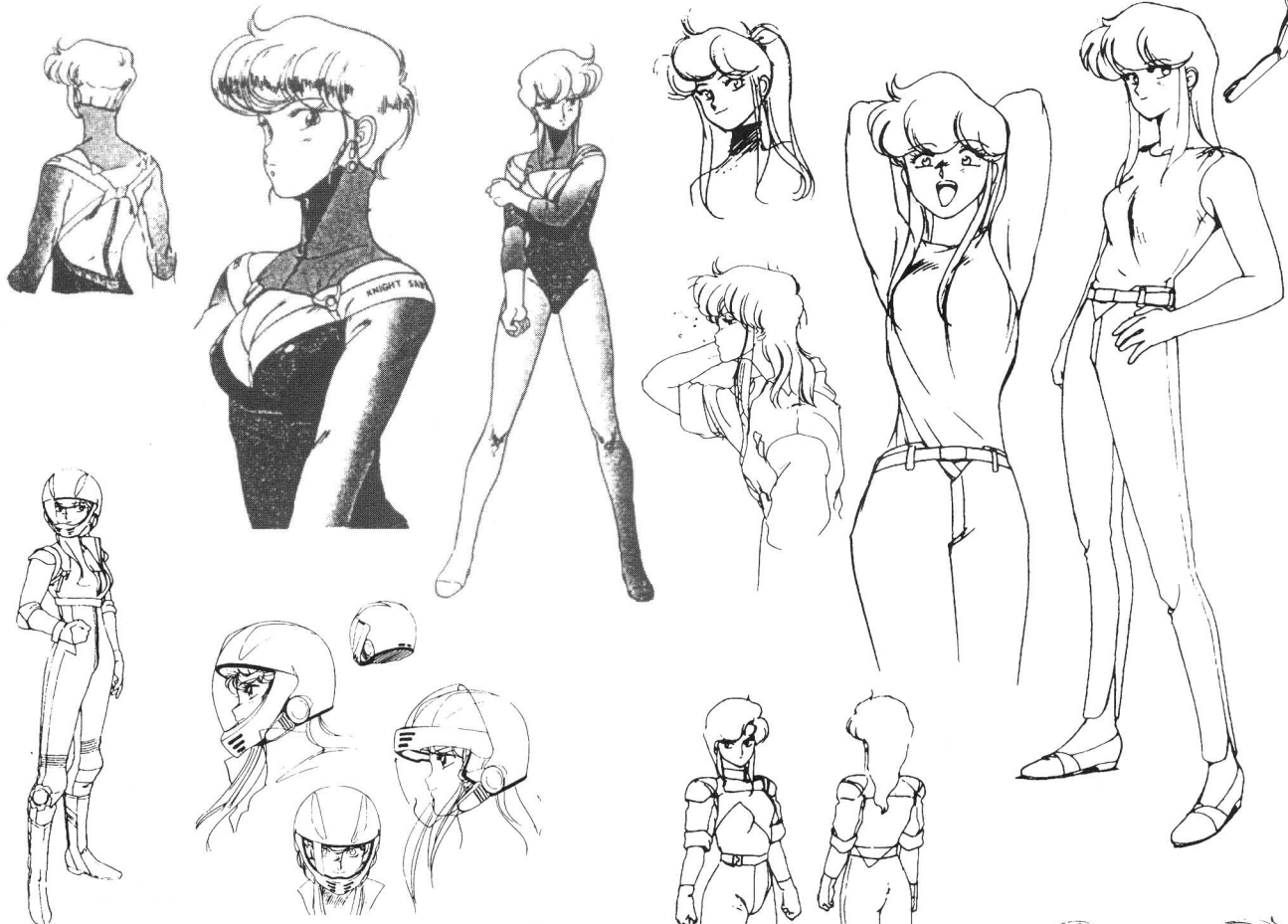

PRISCILLA S. ASAGIRI

AGE	20		JOB	Rock Singer		
STAT	LEVEL	VALUE	STAT	LEVEL	VALUE	
INT	4	Competent	REF	8	Incredible	
PRE	6	Heroic	DEX	6	Heroic	
WILL	6	Heroic	STR	3	Competent	
TECH	6	Heroic	CON	8	Incredible	
MOVE	5	Heroic	BODY	8	Incredible	
SKILL	LVL	SKILL	LVL	OPTIONS	LVL	
PERCEPTION*	+3	DETECTIVE	+1	BEAUTIFUL	2	
CONCENTRATION*	+5	ESPIONAGE	+2	RENOWN	2	
EDUCATION*	+2	WARDROBE/STYLE	+2	COMBAT SENSE	2	
PERSUASION*	+3	PERFORMANCE	+5	PAIN THRESHOLD	4	
SOCIAL*	+2	BASIC TECH	+2	WEALTH	2	
LOCAL KNOWLEDGE*	+6	HIGH TECH	+1	MARTIAL ARTIST	-	
TEACHING*	+2			RAPID HEALING	-	
ATHLETICS*	+6					
STEALTH	+2					
HAND-TO-HAND	+6					
MELEE	+6					
FIREARMS	+6					
GUNNERY	+5			BAD TEMPERED	-4	
MECHAPILOT	+5			STUBBORN	-3	
DRIVING	+6			SECRET IDENTITY	-10	

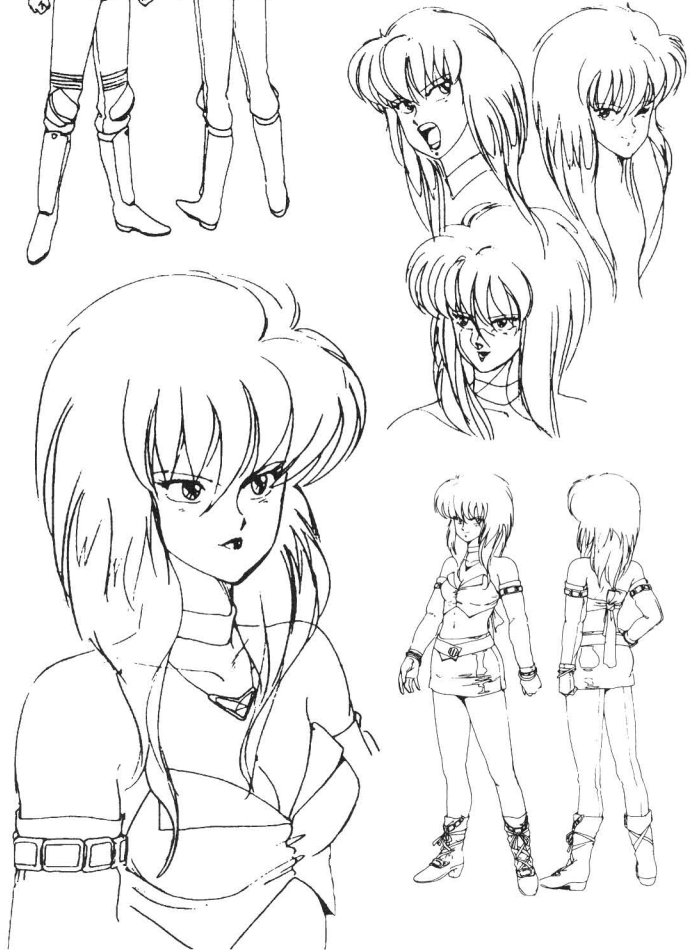



100% CHARACTERS

56

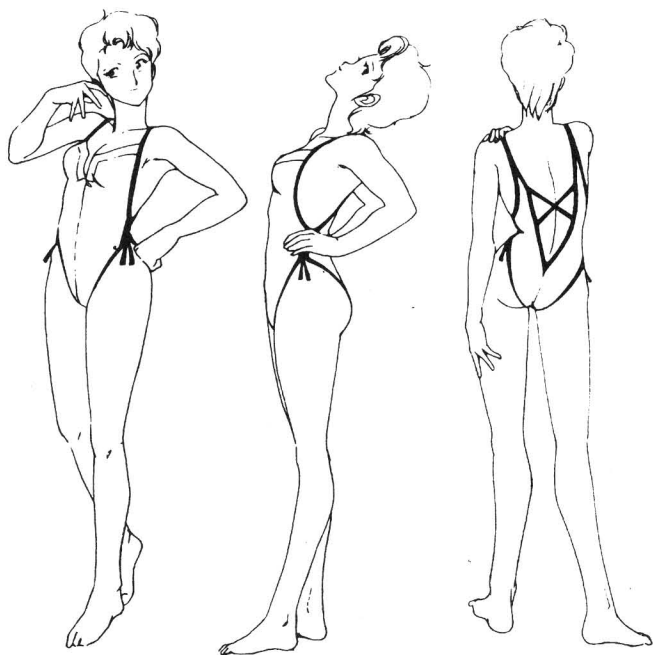
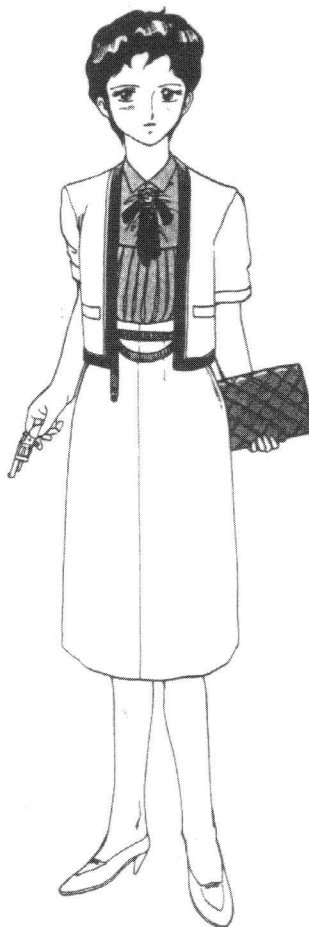
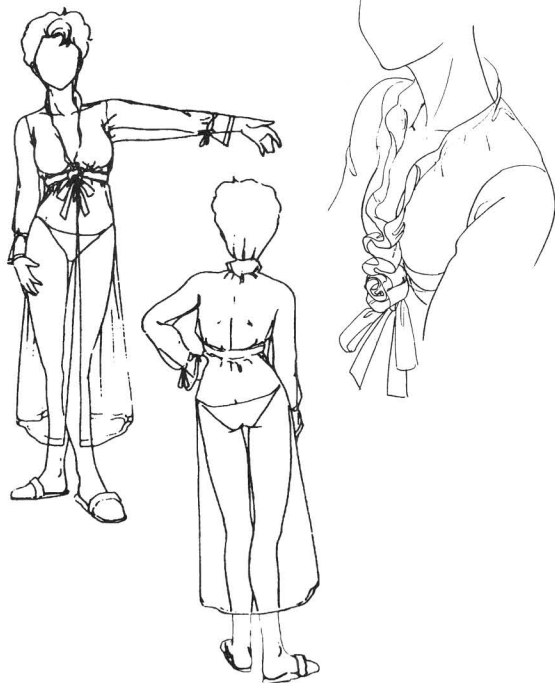

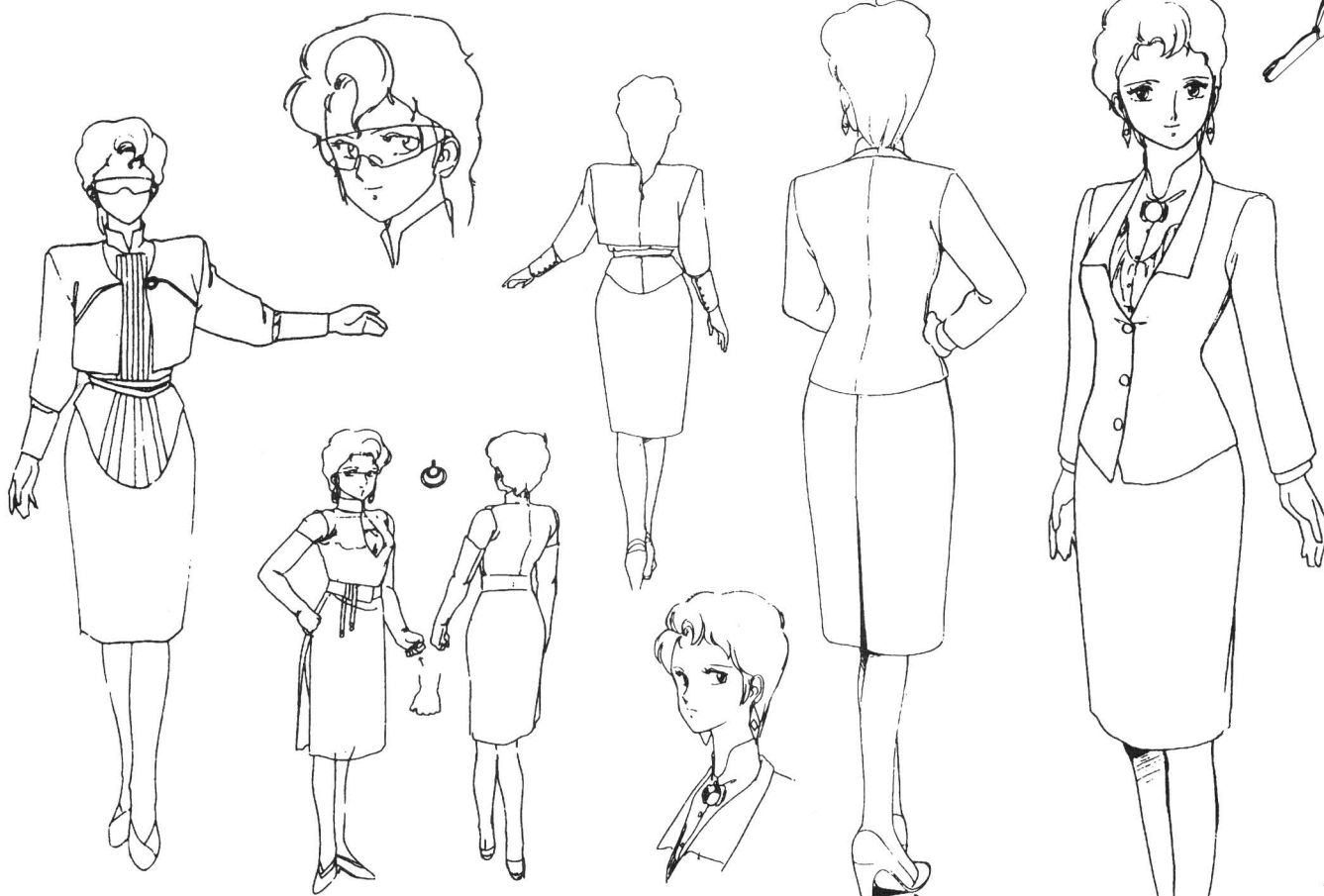

SYLIA STINGRAY

AGE	23		JOB	Entrepreneur, Scientist		
STAT	LEVEL	VALUE	STAT	LEVEL	VALUE	
INT	8	Incredible	REF	7	Incredible	
PRE	6	Heroic	DEX	7	Incredible	
WILL	6	Heroic	STR	2	Everyday	
TECH	6	Heroic	CON	6	Heroic	
MOVE	4	Competent	BODY	6	Heroic	
SKILL	LVL	SKILL	LVL	OPTIONS	LVL	
PERCEPTION*	+4	PILOT VTOL	+3	BEAUTIFUL	2	
CONCENTRATION*	+6	DETECTIVE	+3	COMBAT SENSE	3	

ON*	+6	ESPIONAGE	+5	WEALTH	7
ON*	+4	WARDROBE/STYLE	+5	MARTIAL ARTIST	-
	+5	BUSINESS	+5		
LEDGE*	+5	HIGH TECH	+5		
*	+6	MILSPEC TECH	+6		
*	+6	SUPERTECH	+6		
	+2	SUPERSCIENCE	+7		
-HAND	+5	RESEARCH	+6		
	+6	LEADERSHIP	+5		
	+6				
	+4			DUTY	-30
OT	+4			DEPENDANT	-10
	+5			SECRET IDENTITY	-10



100% CHARACTERS

EDUCATIO
PERSUASIO
SOCIAL*
LOCAL KNOW
TEACHING
ATHLETIC
STEALTH
HAND-TO
MELÉE
FIREARMS
GUNNERY
MECHANICAL
DRIVING



100% CHARACTERS

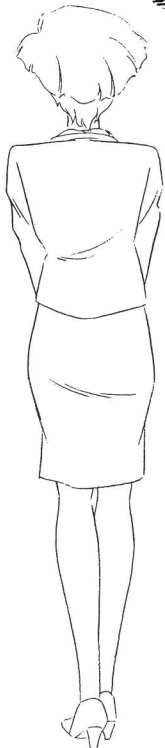

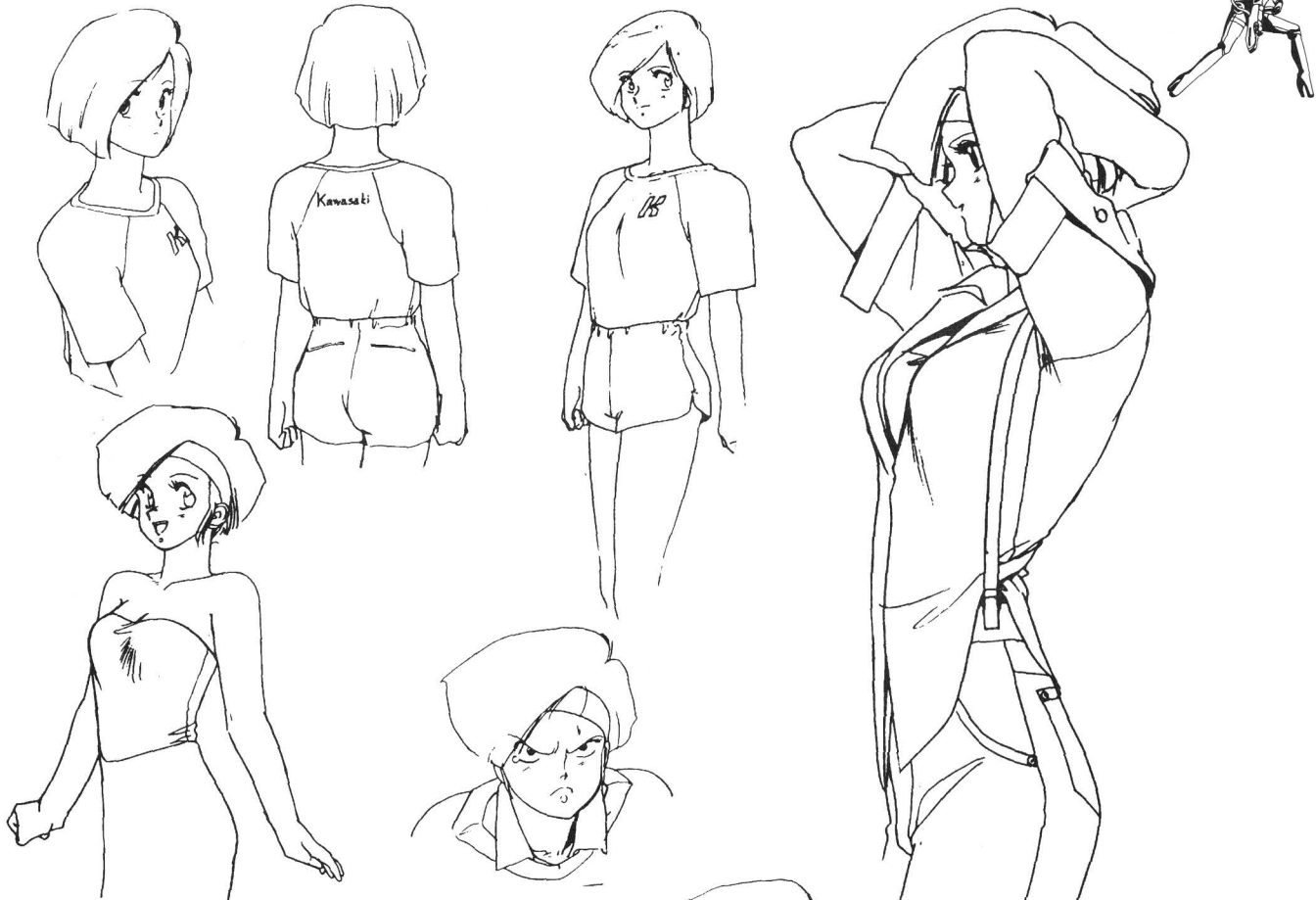

LINNA YAMAZAKI

AGE 22			JOB Aerobics Instructor		
STAT	LEVEL	VALUE	STAT	LEVEL	VALUE
INT	5	Heroic	REF	6	Heroic
PRE	4	Competent	DEX	8	Incredible
WILL	5	Heroic	STR	2	Everyday
TECH	4	Competent	CON	7	Incredible
MOVE	7	Incredible	BODY	5	Heroic
SKILL	LVL	SKILL	LVL	OPTIONS	LVL
PERCEPTION*	+5	DANCE	+5	BEAUTIFUL	2
CONCENTRATION*	+3	DETECTIVE	+4	COMBAT SENSE	4
EDUCATION*	+2	ESPIONAGE	+3	WEALTH	2
PERSUASION*	+2	WARDROBE/STYLE	+3	MARTIAL ARTIST	-
SOCIAL*	+3	STOCK MARKET	+2	RAPID HEALING	-
LOCAL KNOWLEDGE*	+4				
TEACHING*	+5				
ATHLETICS*	+7				
STEALTH	+3				
HAND-TO-HAND	+6				
MELEE	+6				
FIREARMS	+5				
GUNNERY	+3				
MECHAPILOT	+3				
DRIVING	+4			SECRET IDENTITY	-10





100% CHARACTERS

60

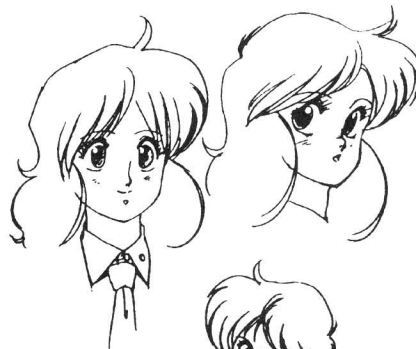
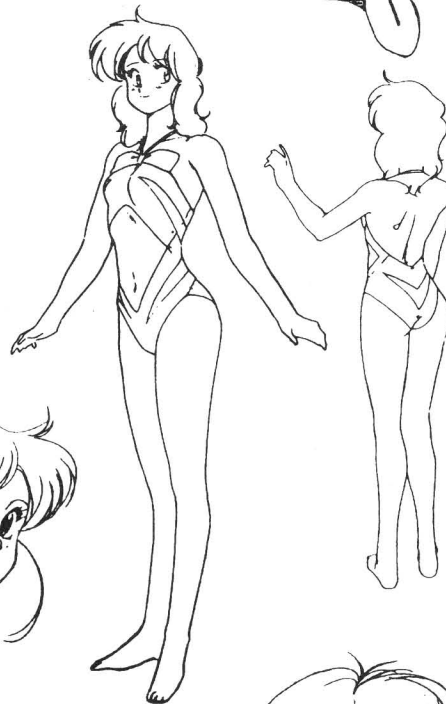
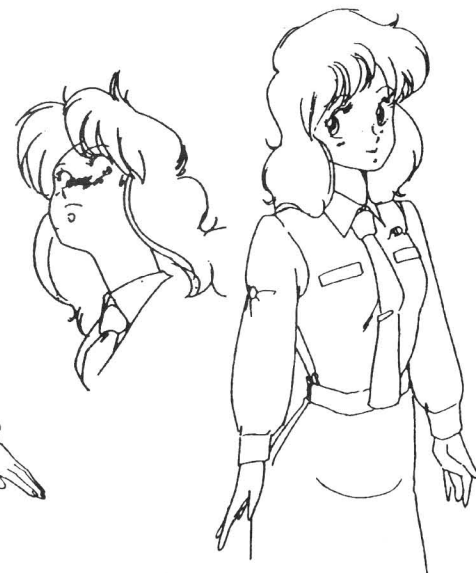
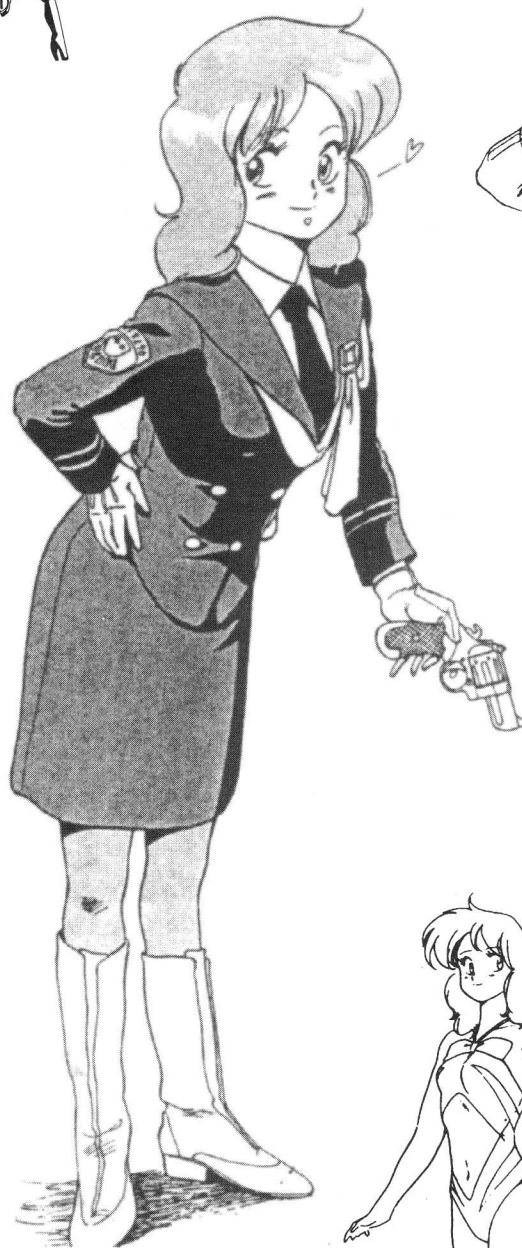

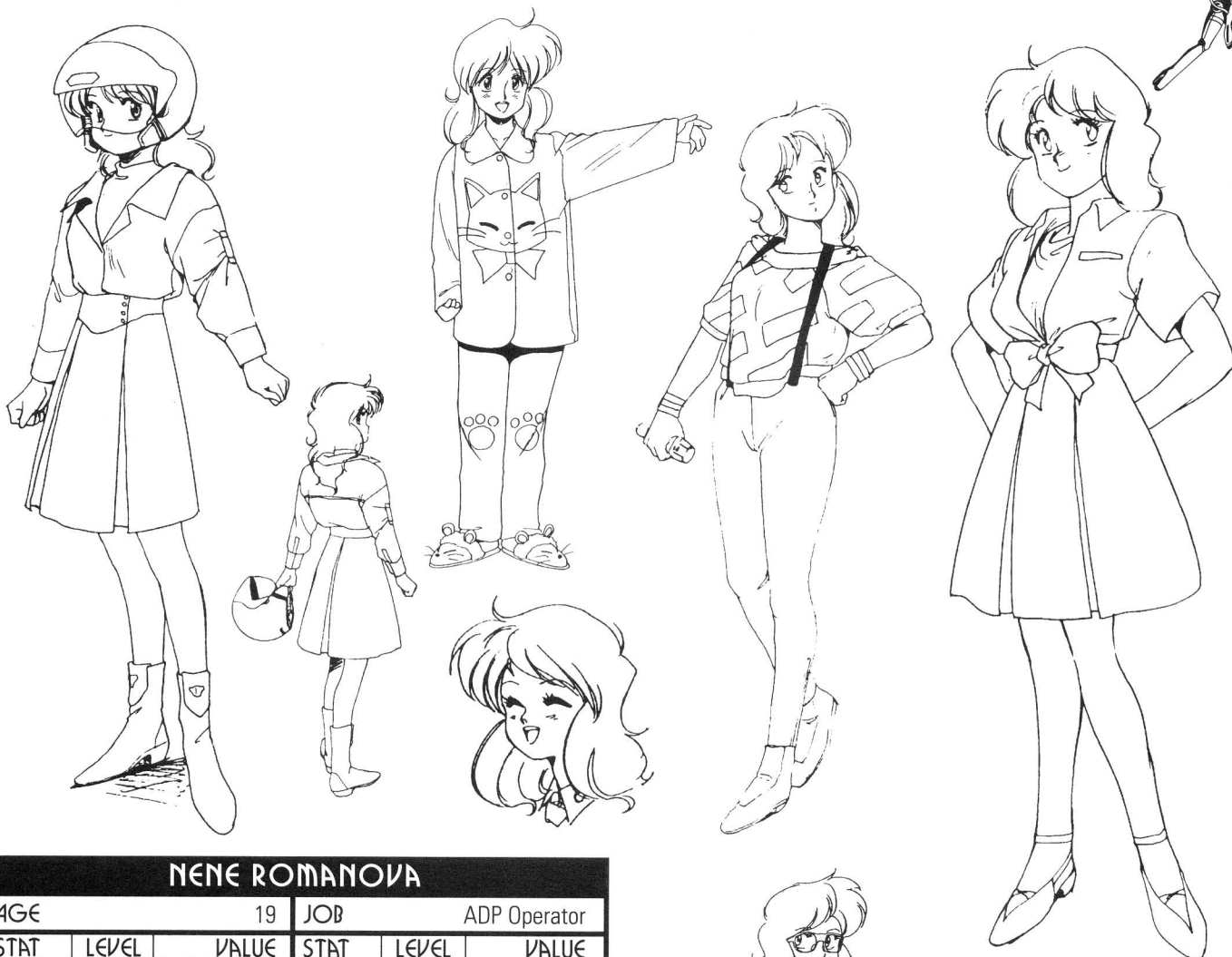

NENE ROMANOVA

AGE 19			JOB ADP Operator		
STAT	LEVEL	VALUE	STAT	LEVEL	VALUE
INT	7	Incredible	REF	5	Heroic
PRE	5	Heroic	DEX	5	Heroic
WILL	4	Competent	STR	1	Everyday
TECH	5	Heroic	CON	6	Heroic
MOVE	3	Competent	BODY	3	Competent
SKILL	LVL	SKILL	LVL	OPTIONS	LVL
PERCEPTION*	+2	DETECTIVE	+2	BEAUTIFUL	2
CONCENTRATION*	+2	ESPIONAGE	+6	COMBAT SENSE	1
EDUCATION*	+5	WARDROBE/STYLE	+2	WEALTH	2
PERSUASION*	+5	E. WARFARE	+6	ADP MEMBER	3
SOCIAL*	+2	RESEARCH	+5		
LOCAL KNOWLEDGE*	+3	HACKING	+8		
TEACHING*	+2				
ATHLETICS*	+3				
STEALTH	+2				
HAND-TO-HAND	+2				
MELEE	+2				
FIREARMS	+3				
GUNNERY	+2				
MECHAPILOT	+2			AIRHEAD	-3
DRIVING	+3			SECRET IDENTITY	-10

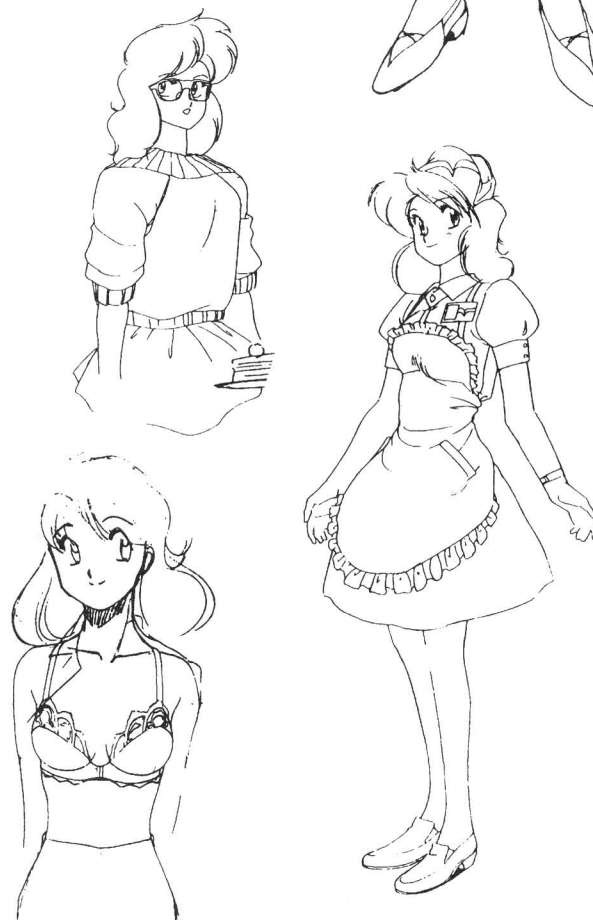

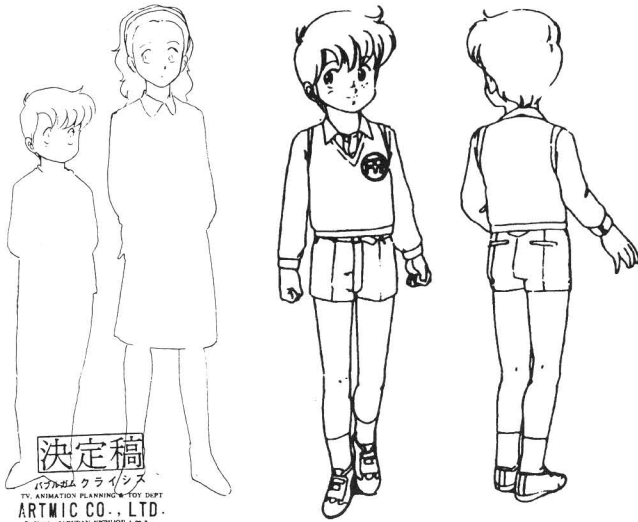
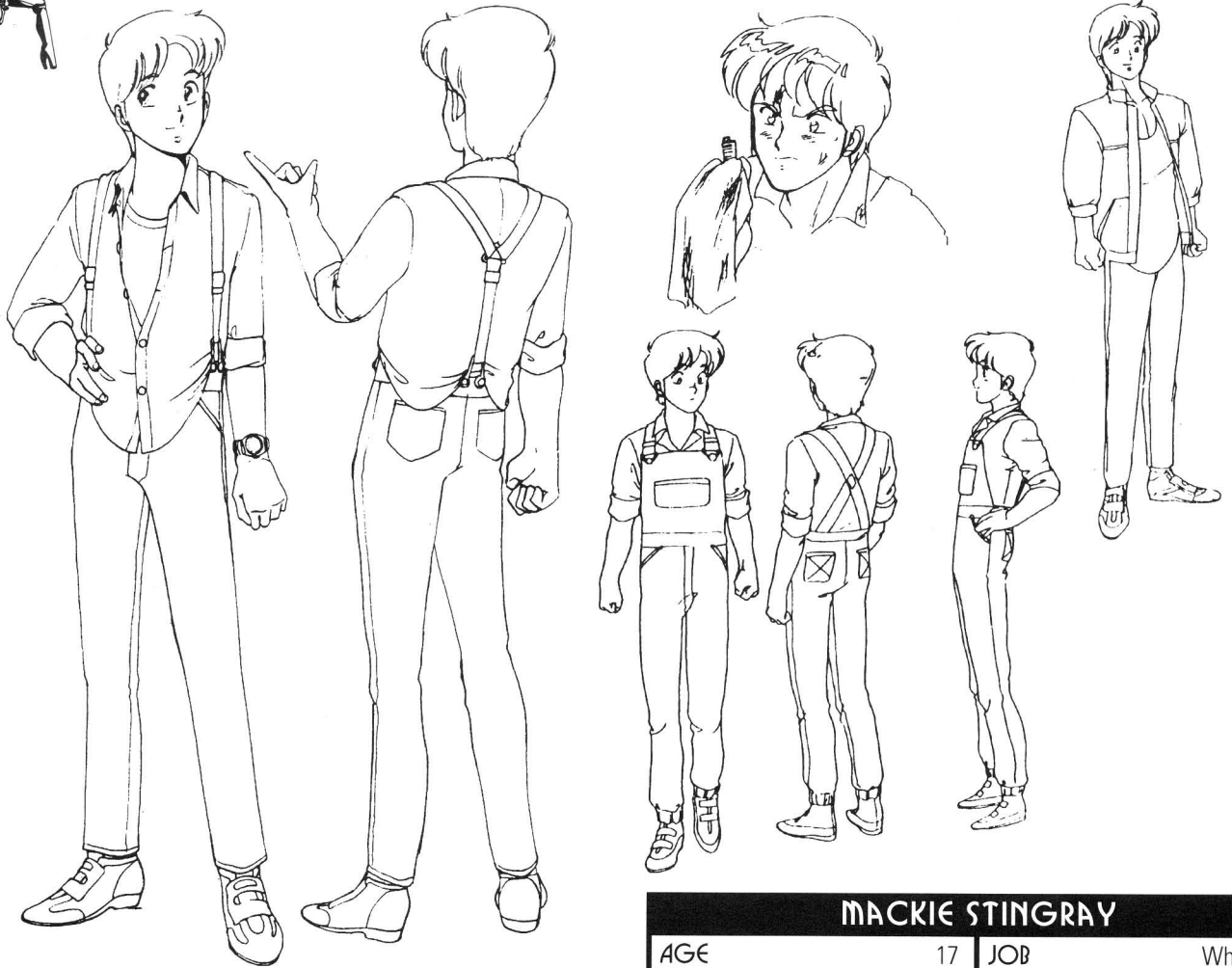

決定稿

バブルガムクライシス
TV ANIMATION PLANNING & TOY DEPT.
ARTMIC CO., LTD.
8-9-60 JAKUTSU-KOEN 2-3
BONHO-KU, NAGANO-SHI, NAGANO-PREFECTURE 380-0801, JAPAN

MACKIE STINGRAY

AGE			JOB		
17			Whiz Kid		
STAT	LEVEL	VALUE	STAT	LEVEL	VALUE
INT	6	Heroic	REF	4	Competent
PRE	2	Everyday	DEX	4	Competent
WILL	4	Competent	STR	2	Everyday
TECH	7	Incredible	CON	5	Heroic
MOVE	4	Competent	BODY	3	Competent
SKILL	LVL	SKILL	LVL	OPTIONS	LVL
PERCEPTION*	+2	DETECTIVE	+1	WEALTH	5
CONCENTRATION*	+2	ESPIONAGE	+3		
EDUCATION*	+4	WARDROBE/STYLE	+2		
PERSUASION*	+2	BASIC TECH	+6		
SOCIAL*	+2	HIGH TECH	+6		
LOCAL KNOWLEDGE*	+2	MILSPEC TECH	+5		
TEACHING*	+2	SUPERTECH	+6		
ATHLETICS*	+2	SUPERSCIENCE	+5		
STEALTH	+1				
HAND-TO-HAND	+1				
PILOT VTOL	+2				
FIREARMS	+2				
GUNNERY	+2				
MECHAPILOT	+2			LECHEROUS	-3
DRIVING	+3			SECRET IDENTITY	-10



LEON McNICHOL

AGE		126	JOB		ADP Chief Inspector
STAT	LEVEL	VALUE	STAT	LEVEL	VALUE
INT	4	Competent	REF	6	Heroic
PRE	6	Heroic	DEX	6	Heroic
WILL	8	Incredible	STR	6	Heroic
TECH	3	Competent	CON	8	Incredible
MOVE	5	Heroic	BODY	7	Incredible
SKILL	LVL	SKILL	LVL	OPTIONS	LVL
PERCEPTION*	+4	MECHAPILOT	+5	AUTHORITY	6
CONCENTRATION*	+3	RESEARCH	+3		
EDUCATION*	+2	DETECTIVE	+4		
PERSUASION*	+5	LEADERSHIP	+4		
SOCIAL*	+2	WARDROBE/STYLE	+3		
LOCAL KNOWLEDGE*	+6				
TEACHING*	+2				
ATHLETICS*	+4				
HAND-TO-HAND	+5				
MELEE	+3				
FIREARMS	+8				
AUTOFIRE	+4				
HEAVY WEAPONS	+4				
GUNNERY	+4				
DRIVING	+6			LECHEROUS	-3

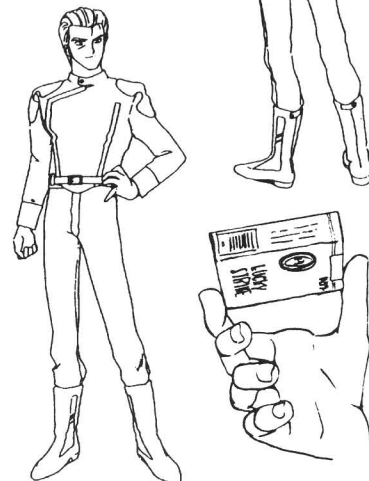



DR. RAVEN

INT	8	PRE	5	WILL	5	TECH	8	MOVE	2
REF	3	DEX	2	STR	1	CON	3	BODY	2
SKILL	LVL	SKILL	LVL	SKILL	LVL				
PERCEPTION*	+3	SOCIAL*	+2	BASIC TECH	+8				
CONCENTRATION*	+6	LOCAL KNOW*	+5	HIGH TECH	+8				
EDUCATION*	+8	TEACHING*	+5	MILSPEC TECH	+7				
PERSUASION*	+4	ATHLETICS*	+2	SUPERTECH	+6				



FARGO

INT	6	PRE	5	WILL	6	TECH	2	MOVE	4
REF	2	DEX	2	STR	3	CON	3	BODY	4
SKILL	LVL	SKILL	LVL	SKILL, ETC.	LVL				
PERCEPTION*	+6	SOCIAL*	+2	RESEARCH	+7				
CONCENTRATION*	+4	LOCAL KNOW*	+6	STEALTH	+4				
EDUCATION*	+2	TEACHING*	+2	FORGERY	+6				
PERSUASION*	+4	ATHLETICS*	+2	FIREARMS	+2				



DALEY

INT	5	PRE	5	WILL	6	TECH	4	MOVE	4
REF	6	DEX	6	STR	3	CON	5	BODY	5
SKILL	LVL	SKILL	LVL	SKILL, ETC.	LVL				
PERCEPTION*	+6	SOCIAL*	+3	AUTHORITY	6				
CONCENTRATION*	+5	LOCAL KNOW*	+6	FIREARMS	+4				
EDUCATION*	+3	TEACHING*	+2	DRIVING	+5				
PERSUASION*	+5	ATHLETICS*	+3	DETECTIVE	+6				



VISION

INT	5	PRE	7	WILL	4	TECH	7	MOVE	5
REF	6	DEX	5	STR	2	CON	6	BODY	3
SKILL	LVL	SKILL	LVL	SKILL, ETC.	LVL				
PERCEPTION*	+4	SOCIAL*	+5	MECHAPILOT	+2				
CONCENTRATION*	+6	ATHLETICS*	+3	STEALTH	+2				
EDUCATION*	+3	PERFORMANCE	+8	GUNNERY	+2				
PERSUASION*	+4	FIREARMS	+3	COMBAT SENSE	+2				



KOU

INT	6	PRE	4	WILL	7	TECH	4	MOVE	6
REF	6	DEX	6	STR	3	CON	6	BODY	5
SKILL	LVL	SKILL	LVL	SKILL, ETC.	LVL				
PERCEPTION*	+4	SOCIAL*	+5	HAND-TO-HAND	+6				
CONCENTRATION*	+7	LOCAL KNOW*	+2	HANDGUN	+5				
EDUCATION*	+2	TEACHING*	+4	MECHAPILOT	+6				
PERSUASION*	+3	ATHLETICS*	+6	GUNNERY	+6				

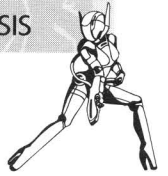

QUINCY

INT	7	PRE	8	WILL	8	TECH	6	MOVE	2
REF	4	DEX	3	STR	2	CON	8	BODY	6
SKILL	LVL	SKILL	LVL	SKILL, ETC.	LVL				
PERCEPTION*	+6	SOCIAL*	+6	ESPIONAGE	+6				
CONCENTRATION*	+7	LOCAL KNOW*	+3	RESEARCH	+5				
EDUCATION*	+8	TEACHING*	+4	LEADERSHIP	+6				
PERSUASION*	+6	ATHLETICS*	+2	BUSINESS	+8				



BRIAN J. MASON

INT	6	PRE	6	WILL	7	TECH	5	MOVE	3
REF	6	DEX	6	STR	2	CON	4	BODY	3
SKILL	LVL	SKILL	LVL	SKILL, ETC.	LVL				
PERCEPTION*	+4	SOCIAL*	+6	ESPIONAGE	+6				
CONCENTRATION*	+6	LOCAL KNOW*	+5	RESEARCH	+5				
EDUCATION*	+6	TEACHING*	+4	LEADERSHIP	+5				
PERSUASION*	+7	ATHLETICS*	+3	BUSINESS	+6				



KATE MADIGAN

INT	6	PRE	6	WILL	6	TECH	5	MOVE	3
REF	3	DEX	3	STR	2	CON	4	BODY	2
SKILL	LVL	SKILL	LVL	SKILL, ETC.	LVL				
PERCEPTION*	+6	SOCIAL*	+5	DETECTIVE	+6				
CONCENTRATION*	+5	LOCAL KNOW*	+3	BUSINESS	+6				
EDUCATION*	+5	TEACHING*	+5	RESEARCH	+5				
PERSUASION*	+4	ATHLETICS*	+2	HANDGUN	+2				



DR. MIRIAM

INT	7	PRE	3	WILL	3	TECH	7	MOVE	2
REF	2	DEX	3	STR	2	CON	3	BODY	4
SKILL	LVL	SKILL	LVL	SKILL, ETC.	LVL				
PERCEPTION*	+2	SOCIAL*	+2	HIGH TECH	+5				
CONCENTRATION*	+2	LOCAL KNOW*	+3	MILSPEC TECH	+5				
EDUCATION*	+6	TEACHING*	+4	SUPERTECH	+6				
PERSUASION*	+4	ATHLETICS*	+2	SUPERSCIENCE	+6				



DR. YURI

INT	7	PRE	4	WILL	4	TECH	7	MOVE	2
REF	3	DEX	2	STR	2	CON	3	BODY	2
SKILL	LVL	SKILL	LVL	SKILL, ETC.	LVL				
PERCEPTION*	+4	SOCIAL*	+3	BASIC TECH	+7				
CONCENTRATION*	+6	LOCAL KNOW*	+4	HIGH TECH	+8				
EDUCATION*	+7	TEACHING*	+3	MILSPEC TECH	+8				
PERSUASION*	+4	ATHLETICS*	+2	SUPERTECH	+6				



BUBBLEGUM EX WORLD



GLOBAL CROSSFIRE

Bubblegum Crossfire, as you'll remember, is an alternate universe in which you are invited to set your own *BGC* campaign. In this universe, Dr. Stingray didn't send a data unit only to Sylia—he sent numerous such data units to friends, associates, and others whom he felt he could trust with his technology. By 2033, vigilante groups like the Knight Sabers were popping up in cities across the globe, each waging their own guerrilla war against Genom.

Since the publication of the *BGC RPG*, many roleplayers out there have embraced the ideas of the *Bubblegum Crossfire* setting. They've taken their home cities and re-invented them in true *BGC* style, populating the *Crossfire* globe with 21st-century megacities and turning the concept of Stingray-inspired vigilantes into a worldwide movement. From San Francisco to Sydney, Genom has found itself in a global crossfire.

In the following pages you'll find an overview of known *Bubblegum Crossfire* activity in cities all over the Earth. Each city represents the hard work of a different *Crossfire* Referee, each one of them an intensely creative individual whose efforts have made

the world of 2033 a more interesting (and complicated!) place ... and since the *BGC* videos provided very little information on the world outside of MegaTokyo, who better to flesh out the rest of the planet than the people who are playing there?

The *Bubblegum Crisis* Roleplaying Game has been strongly supported by its fans from the beginning. Enthusiasts and aficionados of *BGC* contributed all sorts of information and suggestions while we were writing the RPG, and the online community was especially helpful. We've always been proud to include those people in our "Thanks" section of each book's credits, but now you can see what they've done on their own. Each city includes contact information for the creator of that setting—drop 'em a line if you want to know more. In particular, check out their websites (if one is listed). On the web, you'll find a lot more detail about the *Crossfire* campaigns described here.

NOTE: Since this material builds on the *Bubblegum Crossfire* premise which we created for the RPG, none of it should be considered canonical to the *BGC* videos ... but it's still a heck of a lot of fun!

▼NEO ANGELES

Neo-Angeles 2033 by Max Fauth (rickr@one.net.au) •

www.geocities.com/TimesSquare/Realm/2628/bgc.htm

The year is 2033. The place is Neo-Angeles. Brought down from any semblance of glory, the city of Los Angeles was a place to be ashamed of in the early 2020s. When it was rocked almost to the ground by the 2026 earthquake, many saw this as a great blessing. The rapid redevelopment and rebuilding of the late 2020s would make it a shining example for cities of the future.

But it was not to be. The newly-arrived Genom corporation performed most of the reconstruction of the city, and in the process insinuated itself inextricably into its development. Powerful connections within the city offices and careful installation of Genom-controlled figures mean that the corporation can do as it pleases within the city without fear of retribution from the government. Therefore, the only remaining challenge to Genom's supremacy comes from other corporations....

American Armorwerks, a military engineering company contracted to provide battlesuits for NA SWAT and the US military, is engaged in a dangerous competition with Genom in the military weapons market. Biotechnica, a genetics R&D company, has begun unofficial manufacture of boomer brains. Finally, there is Thor Weaponry, a military-industrial weapons company suspected of surreptitiously arming the city's gangs as part of some unknown plot.

Despite the competition from rival corporations, Genom's grip on its new city remains virtually unbreakable, giving the corporation free reign to bring in its army of boomers. Due to its unique position in Neo-Angeles, and with the genius of Gillian Greaves at the helm of its R&D department, Genom Neo-Angeles has been able to advance boomer technology considerably. On occasion, the company even uses the streets of Neo-Angeles as a testing ground.

With the increase in boomer violence, Neo-Angeles has followed the example set by other cities around the globe, equipping one

of their special police units to fight boomers. The Neo-Angeles Special Weapons Assault Team (also known as NA SWAT, or simply SWAT) used high-tech weapons, armor, and powered suits to combat rogue boomers, but they quickly fell behind the newest models of combat boomers. In response, SWAT began incorporating its own special model of Boomer into its ranks to fight its brethren. SWAT is not a separate division of the police; it is constantly under the reigns of the normal police, who are in turn controlled by the city's ever-present masters, Genom.

But now a new hope has arrived: The mysterious group of high-tech vigilantes called the Star Angels. Using ultra-high technology from an unknown source, they battle Genom and its Boomers, determined to keep the giant in check.

Unknown to the public, the Star Angels were founded by Carlisle West, the daughter of a murdered researcher. Having received a data unit from the late Dr. Stingray, West established a base of operations in Neo-Angeles, and assembled three other unique agents: Freya Stryker, daughter of an engineer wanted for industrial espionage, is the team's close combat specialist; Shamus McLumpher, a SWAT veteran, is the group's assault specialist; Adam Kester, cybernetically enhanced after being mauled by a rogue boomer, is the team's computer specialist; Finally there is Carla Harwood, the unofficial fifth member of the group, who uses her special "Jackal" hardsuit to test Carlisle's latest inventions.

The Star Angels work along similar lines to the Knight Sabers'. Operating covertly, they perform espionage and combat missions as mercenaries while also countering Genom's evil machinations. The team's greatest advantage over their enemies is the amazing technology at their disposal: namely, compact and deadly hardsuits and transforming motorslaves. Each hardsuit is designed for its individual wearer, and Carlisle plans to upgrade the Star Angels' equipment every year. Still, Genom constantly creates new mechanical nightmares. Will the Star Angels' technology be enough?....



▼ SAN FRANCISCO

The Great American Hardsuit by Alex Okita
(alex@okita.com) • <http://www.okita.com/>

When Los Angeles was destroyed by the earthquake of 2026, countless refugees moved to the San Francisco Bay Area. Consequently, San Francisco housing became even more expensive. Jobs were rare and employees were underpaid. The homeless outnumbered those with homes. In addition, the constant stream of immigrants from NA formed a drug "pipeline", and the understaffed SF police department became corrupt thanks to the numerous transplanted NA cops. While it wasn't as bad as NA, San Francisco became poisoned with depression, drugs, and violence. It needed help, and that help came in the form of Genom.

In exchange for ownership of most of San Francisco's real estate, Genom assured the city council that it would solve the homeless problem (as well as totally overhaul the Bay Area's highways and transit systems). There were countless protests and demonstrations by the citizenry against the "sale" of San Francisco to Genom, but their efforts were steamrolled. The politicians had already been bought by the superconglomerate. While the transit situation has indeed improved, Genom hasn't gotten around to dealing with the homeless problem just yet...

Genom has been in town for about 16 months, but their new Tower is already almost 25% complete. The first part of the Tower to be built was the core. Standing 450 meters tall, the Core is the primary foundation point for the Tower's superstructure and houses the world's most powerful megacomputer—this is the showcase of the new Tower, and Genom hopes to use it to upstage the many computer companies in Silicon Valley. Supported by the core is the still-incomplete ceiling of the growing Tower. Expanding out radially from the Core's foundation in what was once Golden Gate Park, it encompasses most of San Francisco's downtown area and about one-quarter of the Bay. It's big enough to fly a large helicopter inside (if you're a good pilot), and perfect for Fire-Bees to patrol through regularly.

While the top floor is largely reserved for satellite communication dishes, microwave antennae, and radio transmission systems, executives can also visit the "Top of the World" bar which is also located there. The Core also houses many INBC and other production companies, and they all have access to the megacomputer's almighty processing power. Genom has also offered the state and military access to the megacomputer within the Core, and the downtown hospital and police department are also located there. They have access not only to the megacomputer, but also to a mid-level heliport, a lower-level garage, and the four lanes which travel through to the Core (two in each direction).

Genom Tower San Francisco is the second man-made structure to be visible from space. (The first being the great wall of China.) Once it's finished, all of the buildings in San Francisco's downtown area will stand under the ceiling of the Tower, which is translucent, allowing natural sunlight to pass into the heart of the Tower and be reflected toward the buildings, amply lighting the downtown area. Companies that choose to reside under the shadow of the Tower are granted access to the megacomputer at the core.

Weather within the Tower is controlled from the top level of the core (just above average cloud level). In case of a fire, water can be pumped directly from the bay into the ceiling and then onto the downtown area at a rate of 200 metric tons per second. Meant to spray over a large area, it could also be directed towards one specific area the size of a football field (this could crush the buildings it's poured down over, but presumably will never be used to do so). In addition, the water reserves at the top of the Tower supply the Bay Area with 20% of its fresh drinking water.

Genom's influence can be felt all over the Bay Area. With all the construction going on, Genom is the single largest operator of boomers in the Bay Area, and those boomers are manufactured at a factory near the water, just off of the Golden Gate bridge. 3Com Park (once known as Candlestick Park) has been renamed Genom Park. Back in the downtown area, the crime rate has dropped to almost zero; local police have a very well funded department. Fires aren't a threat, garbage is regularly picked up by Genom garbage boomers, it only rains when it's scheduled to, and everyone has a super-high-speed computer at their disposal. In fact, the only apparent drawback to living within the Tower is the fact that Genom practically owns you. In that kind of environment, escapism has become necessary for mental health.

Fortunately for SF's escape-hungry residents, the immigration of "civilization" from NA has seen the migration of movie production from Hollywood to Marin. Television followed the movie companies and the entertainment industry has conglomerated under the name INBC (InterNational Broadcast Company). The latest INBC release is the big-screen version of the third Knight Sabers adventure. Thanks to the wide availability of digital effects software, movies like those about the Knight Sabers are popping up all the time, one blockbuster after another. It's gotten too easy to make a big film.

All this make-believe has made the public thirst for more brutal "reality TV". Currently, there's a TV crew which follows the exploits of NA's SWAT team and broadcasts "LIVE as it happens." *NA SWAT* is the number one TV show in the US, and INBC has been unable to come up with a show which can compete with it. In their search for alternatives, they discovered that violent sports also proved popular...

Soon "Genom Park" became host to a horde of aggressive new boomers: players in the new sport called Boomer Ball, a game with "Balls of steel, brains of lead, and ten tons of bone-crushing action!", a game where the only humans on the field are the quarterbacks, directing their teams of boomers from the safety of their powered suits. The problem is that in San Francisco boomers are seen as much tamer than their MegaTokyo cousins—most San Franciscans think that the Knight Sabers films are fiction, and since most of the city's boomers are hard at work constructing Genom Tower, Boomers are widely thought of as simple robots. INBC quickly realized that if boomer ball was to take off, things in the big city would have to get stirred up... at any expense.

Recently, for reasons unknown, there has been a rash of rogue boomer incidents all around San Francisco. The SFPD couldn't meet the challenge alone, so Genom agreed to support a new, specialized control group: The San Francisco Boomer Control Team. The responsibility of training and equipping the SFBCT was left to NA's SWAT, who agreed on the condition that they be supplied with battle boomers for their fight against the drugs lords of Neo-Angeles.

As part of the agreement, the SFBCT is based out of the Tower's core. Although many areas in the core are only accessible by Genom employees, the helicopter launch platforms on the mid level are reserved primarily for SFBCT use. To aid public awareness, an INBC camera crew rides with the SFBCT, televising their exploits.

So far, the rookie SFBCT team has not fared well against the rampaging boomers which plague San Francisco. Viewers of the SFBCT's television show have seen the ferocity of the rogue boomers, and Boomer Ball ticket sales have risen as a result. On a visit to San Francisco, Sylia Stingray quickly smelled a rat and has taken steps to rectify the matter. A data-unit was delivered, and the first reports of the mysterious vigilantes called the Star Sabers are coming in...

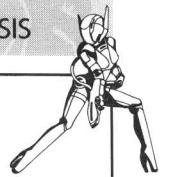

▼NIGHT CITY

Bubblegum Crossfire: SABERS & ANGELS by Dana Jorgensen (djorgen104@aol.com). <http://barador.gameverse.org/ghfree/bgc.htm>

NOTE: Night City is the central city of R.Talsorian's *Cyberpunk 2020* RPG. It was founded in 1994 on the California coast between San Francisco and Santa Barbara by various corporations. If you like Night City, check out RTG's *Cyberpunk RPG*.

In 2034, Night City is still the haven of corporate espionage. The giants still loom in the corporate plaza cityscape, but the city's two largest corporations were all but destroyed in 2022. Since then, new shapes have come to contour the cityscape, with the void left by Arasaka and Militech filled by such rising megacorps as Gulf & Bradley, Essex, Ebisu Mechatronics, Omni, Green Food, Kyuusei Industries, Zone, Cybernetics Bank, and Adler Air. Then, in late 2029, arose the most oppressive structure in Night City's new skyline—Genom Tower Night City, a symbol of the superconglomerate's growing dominance over U.S. markets. Even now, another building is being added, as the city constructs the Night City Administrative Tower to replace the aging and outdated City Hall and Max Tac facilities. Life is once more business as usual... but technology has gotten out of hand.

Night City has long suffered at the hands of technology, which is why MaxTac exists. Since its inception in the late 2010s, MaxTac has been the strong arm of legal enforcement in Night City, handling riots, terrorists, and boomer-syndrome "cyberpsychos". To combat the rapidly escalating boomer syndrome epidemic, in 2030 Night City's MaxTac division was reorganized, reinforced, and re-funded by new corporate donations. They had the finances to purchase military surplus armored vehicles, choppers, aerodynes, full-borg conversions, and power armor specifically designed for police use. During this period, sales soared for Borgman Industries, leading to their establishment of a Night City office.

MaxTac even began staffing boomers, but the growing plague of combat boomer rampages gradually took its toll. The nearly constant battles exhausted MaxTac resources, rapidly bringing the department to the brink of bankruptcy by the end of 2032. With its last gasping breath, MaxTac has recently formed a new unit, named simply M.A.D. It is short for Miscreant Apprehension Division. M.A.D. is a crack combat unit, the best of the best in MaxTac and the corporate militias. They've got the biggest, baddest guns in town and they know how to use them. Unfortunately, M.A.D. is a small unit, consisting of only two dozen officers in various duties. They are called out only for the most serious rampages for the time being, since the budget can no longer deal with the needed equipment or the troop attrition the rampages have caused.

Fortunately for Night City, in these dark hours, new heroes have mysteriously appeared: A team of five vigilantes, using hardsuits, power armor and battlemovers. Nothing is known of them beyond the facts that they call themselves the Night Sabers and they obviously hate boomers. Are they merely copy-cats of the MegaTokyo Knight Sabers, or are both groups part of a far larger organization?

The Night Sabers: Over the last decade, a secretive and successful Night City fixer (going by the handle of Ace) got disgruntled with the state of the world. Ace was a transplant from MegaTokyo after the earthquake of 2025. While there, he learned that Genom, having dominated the open public markets, was attempting to control the grey and black markets as well. Ace decided that Genom should finance both sides of the black market war in MegaTokyo.

To accomplish this, Ace began underselling Genom in MegaTokyo with Genom goods acquired in Night City. The operation was highly successful and generated substantial profits for Ace, but Genom eventually

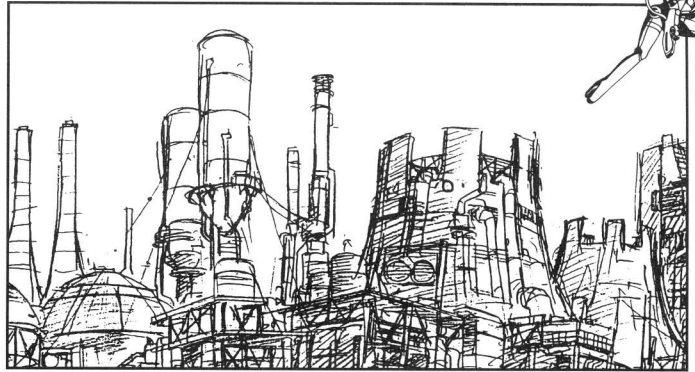

identified Ace as their opponent in the black market wars—They made an attempt on his life, but their assassin boomers killed his lover instead. Ace was now out for revenge, and opportunity soon knocked upon his door.

That opportunity came in the form of a soldier named Lucas, also out for revenge on Genom. He was looking for funding for an anti-Boomer mercenary unit, and he had acquired plans for a series of hardsuits virtually identical to those of MegaTokyo's Knight Sabers.

Within days, Ace had his top techies working hard to put together the equipment while Lucas searched for the right people for his merc unit, but Ace's immediate finances were only enough to build three of the proposed five hardsuits. Ace kicked in some customized military mecha to make up the differences for the moment, and the Night Sabers were born.

Ace's secret avengers are led by the combat-savvy Lucas, a Polar War veteran. From the Forlorn Hope solo bar he recruited Chuck Davies (a military tech and former teammate of Lucas') and Janet Vincent (a computer hacker and survivor of a boomer rampage). In addition, the team's reporter, Derek Andretti, puts a positive spin on the Night Sabers' actions. The Night Sabers recruited their fifth member, a mysterious woman named Lou who had sabotaged a Genom factory south of Night City, by breaking her out of MaxTac custody after her arrest.

Dark Secrets: The Night Sabers may be the best hope for Night City's salvation, but they also have several problems of which they're unaware. Janet Vincent is a loose cannon, seeing boomers and corporations as great evils which must be destroyed. Derek Andretti is also a dangerous wildcard. He's sitting on one of the biggest news scoops of the century, while the other team-members are praying that the constant news the group guarantees will keep him satisfied for the time being.

But the greatest danger to the group is its newest member, the mysterious woman named Lou. No one knows anything about her, nor are they aware that she's a boomer! She managed to survive an attempted escape from SDPC-5 Genaros only by a quirk of fate, and then sought out her friends Sylvie and Anri. She found both of them too late, but managed to steal Sylvie's body from AD Police impound and Anri's remains from a boomer recycling center. The dilemma of how to repair her friends led her to Night City in search of the necessary replacement parts, and Lou was in the process of stealing many of the components she needed when she was apprehended by MaxTac.

Finally, there is Ace himself. While he has a great deal of influence over the Night Sabers, his control over the mercenaries is far from complete. But Ace has already invested millions of Eurobucks into his ongoing war, and he has no intention of losing to anyone for any reason after that sort of expenditure. In order to keep the upper hand over both ally and enemy, he is financing a second high-tech vigilante team. That team, the Night Angels, is to be staffed by his four assassin aces: Spade, Diamond, Heart, and Club. This second team of vigilantes has just appeared in Night City, working hard to damage Genom. Their paths have yet to cross, but when they do, how will the vigilante teams react?



▼PORTLAND

Bubblegum Conundrum by Christian Conkle
(conkle@europa.com) •

www.europa.com/~conkle/cyber/bgc/

By 2033, Portland, Oregon has become part of a confederation of cities known as the Cascadia Metropolitan Axis. The CMA contains nearly every city from Vancouver, B.C. to Salem, Oregon. It was formed to coordinate the development of housing and industry areas in the now heavily urbanized I-5 corridor, and to unify the police, fire, and municipal services of all its members under one governing body. To this end, massive construction was performed using cheap boomer labor and advanced materials developed at SDPC's space stations. To feed the hungry masses huddled in the shadows of the towering conapts, food was imported from Canada and Asia, and hydroponic farms were built in huge geodesic domes. During this time, Japan's influence as an economic power grew, increasing the already strong presence of Japanese-born citizens in the Pacific Northwest. Corporations like Genom grew tenfold in size, and soon, the cities of Cascadia came to resemble Tokyo or Hong Kong more than their North American neighbors.

Eventually, the CMA was finalized. The three largest cities in the CMA, Vancouver, Seattle, and Portland, formed the nerve centers of the government and politics, with the mayor of each city sitting in a tribunal. But despite their integration as the Metropolitan Axis, the three main cities each maintain distinct characteristics. Vancouver, to the north, is peaceful and quiet. Seattle, the center of the CMA, is the wealthiest of the three cities, modern and free of corruption. Portland, on the other hand, is the dirty and often overlooked city to the south. It has always looked enviously northward at Seattle's success, and nearly became a ghost town in the early part of the century when many corporations moved north. It wasn't until 2025 and the second Great Kanto Earthquake that Portland saw a large influx of Asian immigrants and the establishment of Genom Northwest on its East Side, a coup for the beleaguered Portland economy. Still, Portland remains dirty, industrial, old, and rife with corruption, both criminal and corporate.

To maintain some semblance of order in the Portland area and to control the newly expanded population, the CMA formed a Unified Police Force in the 2010s. The UPF expanded the jurisdiction of municipal police forces to the entire Axis, coordinating the operations of local police forces throughout the region. The UPF is structured along the lines of the MegaTokyo police department, with an N-Police branch and an AD-Police branch. The only difference between the American ADPolice and it's Japanese counterpart is its greater utilization of Police Boomers. Its also rumored that the CMA maintains a "black ops" squad for highly illegal work.

The current mayor of Portland is Lisa Gregory, a corrupt politician who values the interests of the corporations over those of her constituents. Not that her loyalty is misplaced; were it not for Genom's massive investment in the region in the early 2000's and 2010's (and its erection of a small Genom Tower), Portland would likely have become a ghost town as most corporate capital moved north to Seattle. It's also rumored that Mayor Gregory has ties with the Triads, the Yakuza, and other organized crime syndicates.

Standing up to Mayor Gregory and Genom is a small but vocal minority of Boomer rights activists. These consist mainly of college students and liberal intellectuals (Portland has no shortage of either) who want nothing more than the complete abolition of Boomer slavery. They often stage protest rallies, and have a voice in city government in the form of Henrikka Liessen, a Swedish-born naturalized citizen who holds a

seat on the Portland City Council. She is the complete opposite of Mayor Gregory both politically and in temperament.

Complicating Portland's political environment are assorted radical Boomers' rights factions. These include such groups as the Boomer Liberation Front, a terrorist group of ex-cyberpunks who execute guerrilla raids on Genom facilities and Boomer retailers, seeking to free the "enslaved" cyberdroids. On the opposite end of the political spectrum is the Human Rights League, a political group of ultra-conservative, bigoted, blue-collar workers whose goal is the complete eradication of all Cyberdroids. They also conduct raids on Genom facilities and Boomer retailers—but with the intention of destroying boomers, not liberating them. The assorted factions often find themselves in confrontation, which sometimes erupt into mob violence. Riots have broken out at nearly every protest rally held by either side, prompting the intervention of the AD Police and/or Genom itself.

Genom Tower Northwest is located in Portland, and Genom is currently the largest land-owning entity in the Pacific Northwest. 90% of the Boomers manufactured here perform manual or menial labor (displacing human labor, which isn't as reliable and must be paid), with many of them being used to demolish outlying towns and buildings so that surrounding lands may revert to nature. This effort is the pet project of the regional director of Genom Northwest, Toy Tanaka, a ruthless ecofascist from Japan with an overdeveloped sense of honor and the environment.

Opposing Tanaka and Genom NW are the Dragon Knights, a group of hardsuited vigilantes who stalk the streets of the CMA. As Sylvia Stingray encouraged and helped organize many of the new vigilante groups operating throughout the world, the Dragon Knights have limited contact with the Knight Sabers of MegaTokyo, but each group operates independently and secrecy between the groups is essential.

The Dragon Knights group was co-founded and is co-led by Alisa Thomas, a technical genius, and D. MacGrady, owner of MacGrady motors and also a licensed weapons dealer. They have recruited Toshi Nagata, a former corporate espionage agent, and Meg, an assassin boomer who once worked for Genom, to work with them. So far, hardsuits have only been constructed for Alisa, Toshi, and MacGready—they use the Switchblade, Cyclops, and Warboy respectively—but as events occur, who knows what other mecha will be modified or built in their crusade against the monolithic Genom?

▼SEATTLE

Seattle 2033—email GoldThornX@aol.com for more information.

In the middle of the Cascadia Metropolitan Axis a new team of vigilantes has surfaced. They are a varied group indeed, consisting of a Stingray-style hardsuited warrior, an ex-marine in an unidentified custom powered suit, a renegade dragonoid Hyperboomer, a hardsuited football player whose armor reflects his sport, and a K-17 pilot who may or may not be connected with the AD Police. They have yet to make a name for themselves, but already rumors of their battles against Seattle's unstable boomer population have begun to spread....

▼MEGA-GOTHAM

Bubblegum Crusade by Grebo Guru (greboguru@aol.com).

In a city which has always been plagued by crime, it was easy for Genom to step in and take over. Now Mega-Gotham's skyline is dominated by a gargyle-ornamented, cathedral-like Genom tower, and from its topmost offices, the two-faced cyborg Helen Dent uses her position as Genom Vice President to secretly manipulate the city's underworld. To

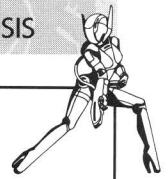

facilitate her schemes, Dent has engineered countless boomer rampages, a situation which has taxed Mega-Gotham's Special Crimes Unit to its limits. Originally transferred in from another metropolis, the SCU is severely underfunded (their heaviest weapons are outdated Madox-type powered suits) so its members make up for this with skill and raw determination....

But skill and determination aren't enough. Dent's villainous boomers are overwhelming the SCU and plunging Mega-Gotham into a nightmare. Only one hope remains: A mysterious team of vigilantes who call themselves the Darkknights. Made up of Belinda Wayne, Dana Grayson, Bob Gordon, and Steven Kyle, they use advanced Hardsuits and transformable Knightmobiles to defend their city as their parents did before them. And so the crusade begins.

▼BALTIMORE

Bubblegum Catastrophe—email Taylor J. Wofford (tjwoffor@air-mail.net) for more info.

Mega-Baltimore is located at the heart of the NorthEastern Metroplex, a three-city "support group" comprised of Baltimore, New York, and Atlantic City. New York and Baltimore are constantly locked in a political feud, and both have threatened to leave the NE Metro. The problem stems from New York's fear that its economy will be crushed by Baltimore. New York's burgeoning population has led more and more corporations to move to the Mega-Baltimore end of the NE Metro. Baltimore and New York have both begun building their own dedicated suburbs in case they are forced to break away. Atlantic City, on the other hand, is the cleanest and wealthiest of the cities, and is perfectly willing to accept the assets of the NE Metro should either city secede.

The greatest assets of the NE Metro are (of course) the corporations, and the greatest player in the NE Metro's corporate arena is none other than Genom. There are two major Genom facilities in the NE Metro, one in Baltimore and one in New York, and the two branches have found themselves in competition on more than one occasion. The other major corporation in the NE Metro is North-Eastern Mediterranean Mining. NEMM's operations focus upon drilling beneath the Earth's crust, and they have also been known to experiment with controlling volcanoes (although all known attempts have failed).

Another powerful element within the NE Metro is the Guard, an elite rapid-response heavy weapons force. Funded by the various corporations of the NE Metro, they're under strict corporate rule. This may make the citizens uneasy, but they're still thankful for the protection. The police, on the other hand, are less than thrilled. Tired of being muscled around by the corporations and their private army (the Guard), the AD and N-Police reformed their ranks into a new Combined Police Force. The CPF exists to protect and serve, but its primary purpose is to prevent the corporations from establishing total rule over the streets.

Mega-Baltimore was supposed to be a city of opportunity, but instead, corrupt corporations laugh down at the struggling citizens, and berserk Boomers terrorize the streets at night. With tensions mounting between the Combined Police Force and the corporate armies of the Guard, the city's future now lies in the hands of a mysterious team of high-tech vigilantes called the Crescent Knights....

The valiant Crescent Knights seem to have taken it upon themselves to battle MegaBaltimore's berserk boomers and corrupt corporations. They were formed by Ian Manson, who received an encrypted disk of Hardsuit schematics in 2025. He began construction of the Phantom, Chameleon, and Firecracker hardsuits in 2031, and recruit-

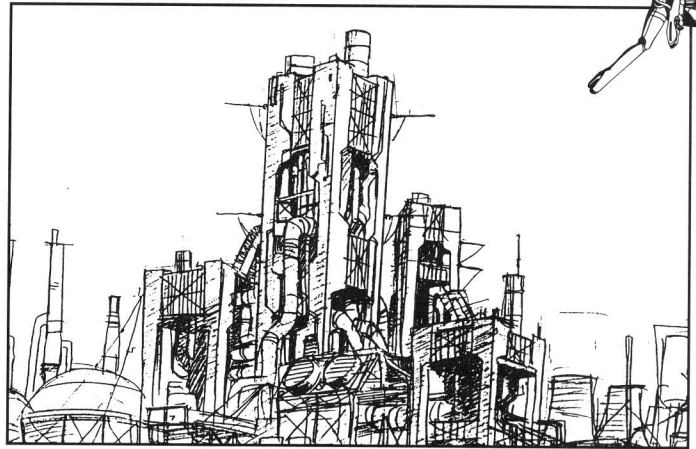

ed his team that same year. His three chosen teammates are Charlie Czien, Naomi Hadoken, and Gwen Harlock. Charlie is an electronics genius, Gwen is the team's weapons expert, and Naomi is the close-combat specialist (who also happens to be a Boomer herself). Together, the four Crescent Knights seem to be a match for anything the night can throw at them... but who knows what the future may hold?

▼COLOGNE

The Story of the Exorcists—email BJAGER@hero.ndh.com for more information.

In this German megalopolis, Die Exorzisten ("The Exorcists") stalk the night. Hotshot and Strider gun the team's transformable Roadstriker motorcycles through the streets; the hardsuits of Flare and the enhanced sexaroid Mistral (who defected to the team after engaging in an infiltration mission against them) leap through the urban shadows; and the mysterious Bogart wields powers not fully understood even by The Exorcists themselves.

The Exorcists have repeatedly crossed swords with the Millennium Corporation, whose variant series of boomers have been performing assassinations throughout Europe. The escalating battle between Die Exorzisten and Millennium climaxed when a renegade fusion boomer absorbed the Cologne Dome. Using a second fusion boomer to infiltrate the rapidly growing monster, Die Exorzisten managed to destroy the core of the gigantic Double Fusion Boomer—and provided their city with a new, grotesque landmark which sprawls across the Rhein river.

▼SYDNEY

Sydney 2033 by Robert Farquhar (imagines@nlc.net.au) www.nlc.net.au/~imagines/bgcsydney and by Michael Zacher (mzacher@spirit.com.au) www.spirit.com.au/~mzacher

When Largo turned the USSD's killer satellites upon the Earth, many Genom Towers were destroyed, including the one in Sydney. Now construction of a new Genom Tower has begun in the Port Botany bay, and this project has filled the Australian metropolis with a veritable army of construction Boomers. What diabolical plans does Genom executive Luca Von Braun have for Sydney, the North Shore Business Consortium, and Kludge Engineering Systems? Nobody knows, but only Andrea Macklesea and MARS (the Mobile Armoured Response Squads of the New South Wales Police) stand in his way. Like their brethren, MegaTokyo's AD Police, Sydney's MARS strive to ensure that the streets of their city are free of the ever-present threat of insane Boomers.

EX-PANDING FRONTIERS



Despite all the turmoil and trouble, the 21st century is a startling time of change and exploration. From the cold depths of deep space to the inner workings of the silicon mind, science is carrying mankind faster and farther into the unknown ... whether it's ready or not. These new frontiers can present some exciting opportunities for your BGC game, offering the chance to confront problems and situations that are not easily solved with a railgun salvo or powered-armor punch.

Here we offer some ideas for new environments in which to set your games, along with some suggestions of what kind of adventures might await your players there.

▼SPACE: THE HIGH GROUND

As discussed in the *BGC RPG*, outer space was seen as the salvation of mankind in the 21st century. Unfortunately, the challenge of developing extraterrestrial resources has proven more daunting than anticipated. While extensive orbital and lunar facilities exist (see *BGC RPG*, pg.55), expansion has slowed to a "measured and methodical" pace under the auspices of the SDPC. Still, while the exploration of space may have slowed, it has not stopped, and many possibilities await characters who venture beyond the thin shell of air which clings to our planet.

• **ORBITAL INTRIGUE:** Orbital space is a troubled and turbulent zone. It is home to claustrophobic, boomer-infested factories as well as the most powerful weapons of the new century; you can bet business as usual up here has more than its share of intrigue, con games and subterfuge.

Certainly, the orbiting battlesats present a particularly tempting target for anyone looking to reduce the USSD's stranglehold on global peace. Numerous terrorist or nationalist groups would love to destroy—or better yet, subvert—any of the USSD's sats. Genom (and Mason) tried this from the ground with the "black box" boomers, but most groups assume a more "hands on" approach, dealing with the weapons directly. The USSD has its own operations as well, sending covert agents out to sabotage the battlesats of independent nations, thus removing them from the orbital powers roster.

While the main factions in orbit are naturally the USSD and the SDPC (with Genom as its master), there are myriad other minor groups who have claimed parts of near-Earth space for use, including several smaller nations and companies. Rival corporations pursue illegal research projects in workshacks far from prying eyes. Second-string

SPACE: THE DEADLY FRONTIER

There are a few things to consider about the environment of space that could really ruin your character's day. Out here, ignorance is *not* bliss.

• **PRESSURE/ATMOSPHERE (OR THE LACK THEREOF):** Outer space is essentially a vacuum: no air, no oxygen, no pressure. Thus, space habitats consist of sealed metal bubbles of air and heat. Big guns and powered fists have a tendency to rupture these pressure hulls all too easily, allowing the air to quickly escape. This is called explosive decompression, and it is a *bad* thing. Note that most small habitat outer walls have 10-25 KD.

Anyone exposed to total vacuum has 5D6 seconds of consciousness before he blacks out. Each phase, he also takes DC3 damage as nitrogen boils out of his blood and loses 1 point of INT as his brain starves for oxygen—until he reaches zero INT, at which point he is DEAD. He isn't even usable in the body banks as his capillaries have burst and his body has ruptured from within. Pop! Lesser pressure loss situations have similar, but less severe, consequences. Lack of oxygen (but not pressure) causes its own problems (see the Asphyxiation rules in the *BGC RPG*, pg. 47).

• **ZERO-G (OR MICRO-GRAVITY):** While some orbital habitats rotate to simulate gravity in some sections, even these structures have many areas left in minimal gravity for research or industrial purposes. This lack of appreciable gravity in space can make maneuvering—and combat—problematic for those unaccustomed to it.

New Skill: Zero-G Maneuver (DEX)

The skill of moving in zero-G without EVA packs, etc. By shifting body weight, pushing off walls, performing mid-air flips, and even throwing heavy objects, the character can move about with relative ease. Pushing off a wall in a straight line and stopping at a far wall without knocking yourself unconscious would be an Average task. It takes actual time in z-g to acquire this skill, so only spacer characters (or those who've spent some real time up there) should be allowed to take it.

Of course, there's no gravity *outside* either, so, should a character fail a Zero-G Maneuver roll while out in a spacesuit, it might leave him flailing about in space with nothing to push off of or grab on to. An attached tether, an EVA pack, or a thruster rod (*BGC RPG*, pg. 142) may be the only thing between him and a long ride into the Big Black.

Gun combat is tricky as well. The recoil from projectile weapons in zero-G can send the firer flying. The firer must make a Zero-G Maneuver skill roll of 20 or better or be knocked off his feet (and back into anything behind him) when firing a medium handgun. Larger weapons require a higher roll, while smaller or lower recoil weapons (-3), and bracing (-4) can reduce the target number.

• **RADIATION:** A lesser known (but equally deadly) danger in space is exposure to solar and cosmic radiation. Suits, vehicles, and habitats are generally shielded against most such danger, but should a character get exposed (as by a solar flare or even a reactor breach), he may face cancers, mutations (almost always harmful), or even immediate death.

The Ref can treat radiation exposure as a Poison (see the *BGC RPG*, pg. 47), with varying levels of lethality. A solar flare may be DC4-10 (depending on the intensity) and a reactor leak may be up to DC14 (if the character caught the full brunt of the leak). Even if the character survives the initial exposure, he may suffer long-term effects, such as tumors and scarring (make a BODY roll against the total number of damage points. Failure indicates a cancer or other negative long-term effect).



New Template: Spacer

Description: A trained technician with an adventurous spirit, you bought into the propaganda that space could provide a refuge from the urban corporate nightmare that Earth had become. Unfortunately, it all turned out to be a lie. The corporations had already claimed the high ground out here. Now you work on building their huge constructs, puzzling out new ways to overcome the twin enemies of vacuum and radiation. At least zero-G has proven to be as fun and “uplifting” as you’d hoped ... once you got the hang of it.

Skills: Basic Tech, Computers, Education, Expert: Z-G construction or manufacturing (specify), Pilot: OTV or shuttle, Survival (space), Z-G Maneuver.

Options: Ambidexterity, Common Sense

Equipment: Z-G jumpsuits, skinsuit or spacesuit, suit patch kit, thruster rod, micro-headset radio, cutting-edge pocket computer (POW 3), Wealth 4, but the cost of living in space makes it an effective 2.

nations struggle to get their spy and gun sats up despite the watchful eyes of the USSD. Orbital laborers pay big money for illicit drugs that they hope can make their cramped, dull lives somehow more tolerable. Advanced model boomers conspire with fellow AIs for the opportunity to flee their programmed slavery and find freedom down the gravity well. Drug-running, industrial espionage, political graft, and personal tragedy are all part of life on the High Frontier.

Player characters may have wandered into orbit as cops assigned to the High Beat, skilled technical professionals looking for work, or employees boosted up under a patron’s indulgence. They may be hired or approached by any of a number of groups who are looking for deniable operatives to do some “dirty work.” Or the characters may be following a lead that has carried them up the gravity well and into the machinations of the orbital powers. Think of the the orbital community as an post-modern, industrial Istanbul and you’ve got the right idea.

• **GENOM SPACE:** Supposedly the SDPC pursues space development for the good of the U.N., but is hamstrung by the economic collapse of several of its investing nations. But is it really? With their control of the SDPC, Genom may easily be using a lethargic SDPC as a cover for its *real* activities in orbit ... and beyond.

There’s evidence to back this idea up. Boomers are more common in space than anywhere down on Earth; they were *created* to work up there. This means there should be more Boomer malfunctions in orbit than anywhere else, right? Strangely, this doesn’t seem to be the case. The question is: why?

It might be as simple as the fact that Genom actually controls most of the berserk boomers which rampage on the Earth below, as part of Quincy’s campaign of chaos and disruption. But Genom *already* controls space, so boomer “sprees” are unnecessary. Oh, there’s the occasional rogue cyberdroid or four, but nothing tough enough to mandate special police squads. In fact, boomers *are* the police in many orbital habitats, with Doberman boomers serving as heavy response squads—to keep the more unpredictable *humans* in line ...

Genom has also built numerous orbital factories whose exact purpose have never been explained. They may be building weapons for Genom’s use—such as orbital particle beams. Or they might be boomer factories, designed to churn out a secret force of cyberdroids which Genom can send against the Earth. The megacorp has been producing a number of specially-designed space combat boomers; one can only

GETTING FROM HERE TO THERE, UP THERE

You’ve heard it before: space is BIG. Well, it’s true. It’s 37,000 km just to geosynch orbit (where the orbital transfer stations are located). The SDPC stations are out at 250,000 km! Shuttles run up to the transfer stations every other week with orbital transfer vehicles carrying passengers out to the higher stations on a biweekly basis. Some typical travel times are as follows:

Earth to transfer stations (L1)	12 hrs.
Earth to SDPC stations (outer LaGrange points)	36 hrs.
Earth to lunar surface	72 hrs.
Geosynch to SDPC stations	12 hrs.
Geosynch to lunar surface	60 hrs.

TYPICAL ORBITAL TRANSFER VEHICLE

These are the taxis of the orbital communities: boxy, unstreamlined spacecraft designed to move goods and personnel between the various workshacks and stations. Unstreamlined and ungainly, they are incapable of atmospheric re-entry or flight, but they get you where you need to go as long as it is in Earth orbit.

Value: 75 OP

Maneuver Value: -5 REF, Armor: KD25, SDP300=6K, Move: 10 (1 G), Passengers: 10. Weight=37.5t, Systems: Sensors, Cargo hold, maneuver rockets, two manipulator arms (50SDP, STR 8 each).

assume it expects them to be used. Might Genom create a war in orbit to generate sales?

Of course, Quincy’s master plan may not be focused on Earth at all. His real goal may be to take the *rest* of the solar system, using the boomers to colonize other worlds, and Earth nothing more than a resource base. The Moon may be riddled by warrens unknown to mankind, built by ant-like cyberdroids following some unfathomable pattern. Mars is supposedly untouched except by a few unmanned probes, but what if Genom is pursuing its own plans for the Red Planet? Boomer colonies may already be established there, slowly building a world in Quincy’s vision, free of human emotions, priorities, or sympathies. With fewer environmental limitations than humans, the boomers can develop the surface with impunity, unhindered by the need for oxygen and water. Of course, Genom would have to keep this new world a secret long enough for the fledgling colonies to fortify themselves. Sabotaged expeditions, falsified probe data, and the corpses of murdered scientists may mark the trail that leads the characters to the truth.

Genom may go further still, sending boomer expeditions into the asteroid belt to mine for resources (particularly nickel-iron asteroids). These can then be turned into massive colony ships to carry the boomer civilization to other solar systems ...

Exactly how much of the high ground might Genom have grabbed?

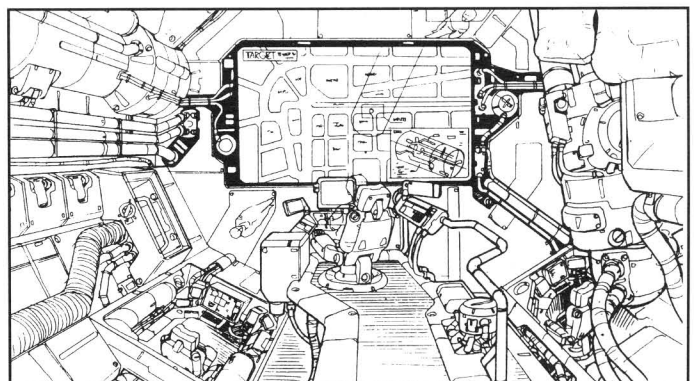



• **OUTWARD BOUND:** Of course, you might want adventures that are a little more open-ended. The SDPC *will* eventually start sending expeditions out to the rest of the solar system.

They've been planning a Mars expedition for two decades now, and might be ready to launch at any time. Such a voyage might take two years or more, with most of the human crew in cryo-sleep for the trip's duration. The crew might be a boomer/human mix, specially adapted boomers and highly-trained humans working together to achieve a crowning moment in space exploration: the first touchdown of man (and boomer) on another world.. Or it could result in a 2001-style conflict between man and machine as cyberdroids and humans face of in the depths of space. Perhaps there's someone with their own agenda aboard, one who wants the expedition to fail so he can place blame on one side or the other. Or the expedition might find something extraordinary in the outer system, such as an ancient, alien machine intelligence that immediately recognizes the boomers as fellow sentients, but refuses to acknowledge the humans.

▼ THE OCEANS: UNDER PRESSURE

As the exploitation of space sputtered on, mankind's eyes turned downward to the oceans. While the challenges of pressure and construction in undersea development were as great as (if not greater than) those of space, at least the economics of material transport were somewhat less daunting. Ships and subs are somehow less threatening to most than shuttles and stations. As a result, the ocean surface and floors are being reshaped by the hand of man.

• **AQUACULTURE:** Both surface and sub-surface aquaculture (oceanic farming) are being pioneered in the Atlantic and Pacific. Japan is at the forefront of this technology, having farmed kelp, oysters and other seafoods for decades. Huge kelp farms tended by robotic harvesters are popping up along the Pacific Rim. Genom and other corps such as Green Food are also establishing experimental subsea farms, designed to raise shellfish and cryopalan crops, along the continental shelves of the Pacific and in the Mediterranean.

Underwater mining is a booming industry as well. Metal-rich sediments are known to exist in the Indian Ocean as well as the Pacific seabed off the coast South America. Magnesium nodules—small, potato-shaped lumps rich in valuable metals—are also found on the sea floor, particularly in the equatorial zones. The question of how to harvest these nuggets has spurred a plethora of technological solutions, including huge vacuum rigs and skimmer subs with drag nets.

Now, farming and mining may not suit your players' tastes, even if it's done 150 meters below the waves. It's more likely that they would

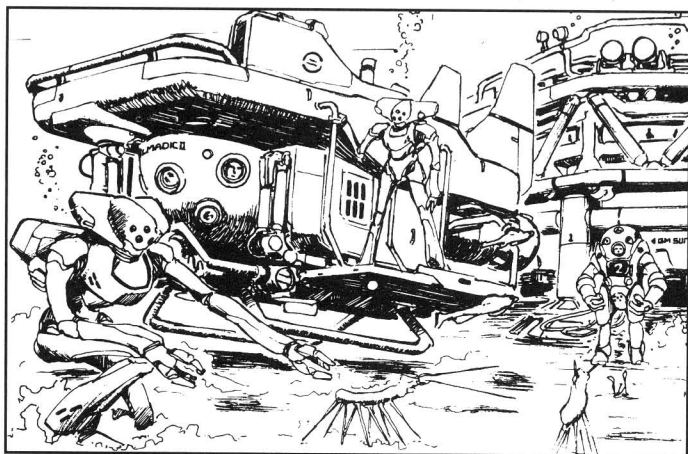

DEALING WITH THE DEPTHS

Like outer space, inner space (the deep oceans) has rules of its own, and you'd better understand them if you plan on living any length of time down there. Here are some simple guidelines for handling these issues in your *BGC* game.

• **DROWNING:** Humans can't breathe underwater; the asphyxiation rules in the *BGC RPG* (pg. 47) certainly apply to anyone who tries to do so without technical assistance. Note that water usually enters the lungs during drowning, with an Everyday Paramedic roll (see below) required to clear the victim's lungs before he can resume breathing, even after you've pulled him from the water. If the victim has been rendered unconscious, another Average roll is needed (after the first) to get him to resume breathing.

New Skill: Paramedic (TECH)

This skill enables the character to stop bleeding, repair damage, and generally keep someone alive in the field. It is less specialized and powerful than Physician, but almost anyone can get paramedic training through a First Aid course.

New Skill: Scuba (INT)

The skill of handling scuba and aqualung gear, plus a basic knowledge of underwater protocols and emergency procedures. It can also be used in place of Athletics when used for swimming and performing tasks at Scuba depth (typically down to 200 meters).

• **WATER, WATER, EVERYWHERE:** Water is a much denser medium than air. As such, it slows movement, obscures vision, and generally degrades most people's performance. Most underwater DEX-based tasks are at -2 (Athletics *or* Scuba skills can offset this, but not add positively). Note that swimming is at 1m x MOVE. Walking underwater (along the bottom in a weighted suit) is .5m x MOVE.

Awareness checks underwater often suffer due to poor visibility. Visually-based Awareness checks are at -0 to -5, depending on the clarity of the water. In addition, visual ranges are usually limited to 100 meters. Any combat shooting beyond 3 meters is at -3 to Hit, and most weapons, unless designed for underwater use (such as spearguns), have their ranges cut to one third.

• **PRESSURE (AS IN WAY TOO MUCH):** One of the biggest factors in dealing with diving is the fact that water pressure, especially below 100 meters, can be a literal killer.

Inequity between the body's internal pressure and the external water pressure can cause internal gases to "bubble" inside the body tissues causing decompression sickness (the bends). If the character is scuba diving and rises or descends more than 5 meters per phase, he may get the beginnings of the bends: On a failed BODY roll, the character gets a terrible ringing and roaring in his ears (-3 to Initiative and Awareness rolls) which lasts 1D6 hours. Should the character rise or descend 15 or more meters per phase, a failed BODY roll results in DC3 internal damage unless he stops for 1D6 phases to let the pressure equalize. This can be accompanied by cramps, blurring of vision and possibly paralysis. DEX is at -3 during such an attack and each phase of accelerated ascent or descent subtracts one from the BODY roll (i.e. three phases of ascending at 20m per phase will require a BODY roll at -3)

Scuba divers can dive down to 400 meters if operating out of a local pressurized environment (like an underwater base). Dives below 400 meters should only be performed in submersibles or special, sealed powered-armor dive suits (see the sidebar on the next page for an example). At these depths, the human body needs special protection and power assistance to move against the crushing pressure.



SAMPLE UNDERWATER GEAR

SCUBA Gear (¥45,000): 4 hour special-mix air supply which allows dives down to 200m (normal oxygen only allows dives to 75m), helmet (KD 20), insulated wetsuit (KD 5) and fins. EV -2.

ROCKET-ASSISTED SPEARGUN (¥27,500): Range 100m, WA +0, DC 4D6 AP, Shots 2, ROF 2.

GM SUIT (see pgs. 30 & 74 for illustration): This power-assisted dive suit was designed to allow humans to work effectively at depths down to 1500 meters. It has a 4-hour independent air supply, or can be plugged into a habitat for nearly unlimited air time. A pilot uses his Mecha Piloting skill to handle this suit.

Value: 42 CP (¥7,000,000)

Maneuver -5 to DEX and REF, Armor KD: 25, Structure: 45 Hits, STR 10 (underwater), Weight: 655kg, Systems: Radio, spotlight x2, life-support, and a limited sensor suite (150 meter range underwater).

BOOMERS UNDERWATER

Most boomers can operate underwater to a limited extent. Even basic biomimetic units can operate down to 50 meters without difficulty, although prolonged exposure (more than 6 hours) may result in delicate surface components getting corroded by salt water (3 Hits damage per hour after the first six; auto repair does not work against this). Most combat models can operate down to 200 meters and are insulated against corrosion, but suffer many of the same Awareness and combat penalties as humans do (unless equipped with water-attuned sensors). Purpose-built units (such as the Marine Boomer on page 32) can operate down to 2000 meters, and have systems designed to negate most of the problems of underwater movement and vision.

visit such a site to investigate illegal or disruptive activity (either boomer or human caused). Since conditions on these sites are always harsh, boomer labor is a common feature, so boomer rampages might be frequent as well. In addition, Genom or other corps could easily be using the isolation of oceanic operations to mask more sinister activities, such as biowarfare experiments, nethacking, or even nuclear weapons development. As in space, Genom may already be well established in the oceans.

• **UNDERSEA ENERGY:** Food and minerals aren't the only things being sucked from the oceans in the *BGC* age. In a hi-tech world, energy is more valuable than either. Oceanic oil rigs have tapped the continental seabeds for decades, and several deep sea rigs, underwater drilling platforms supported by on-site staffs of human specialists and marine boomers, are being established by Gulf and Bradley at depths of up to 1000m.

Furthermore, the ocean itself is being leached for energy. Thermal Energy Conversion operations—huge heat pumps that use the temperature differences between ocean layers to generate electricity—and tidal generators (such as the one in Tokyo Bay) are being installed in sites along the Chinese and European coasts. Even more ambitious are the Geothermal Taps: energy exchangers that use the heat of deep sea volcanic fissures and funnels as power sources. Only one such experimental tap is currently operational, in the subduction zone off the north coast of Honshu (one of the isles of Japan). It is a pilot project of—who else—Genom, but its viability is still uncertain.

An assignment as security or technical support for any of these facilities could be a challenge, as the players face rival corporate sabotage, boomer malfunction or revolution, and the very real threat presented by the oceans themselves. Many countries now depend on their oceanic energy sources for survival, and any threat to their continued operation may represent a major crisis. Can you think of a better terrorist target?

THE DIGITAL DOMAIN

As vast as the realm of sea and sky may seem, they are dwarfed in comparison to the possible vistas opened up by the new revolution in artificial intelligence. Mankind has created computer programs that think and perhaps even feel. Humans can link their minds directly into computers via a variety of techniques, allowing them to experience the rush of silicon speed firsthand. Virtual realities—digital environments designed for their hyperreal or surreal qualities—vie with the “meat” world for control of people's lives. A vast computer network spans the globe, and access to information has never been greater ... or more overwhelming. As this digital juggernaut plows forward, what new environments might present themselves?

• **VIRTUAL UNREALITY:** Computer power in the 21st century is such that virtual realities can rival or surpass the detail and intensity of normal life. This is enhanced by the various neural-linking technologies that let a person perceive these constructs directly, as if they were his normal sensory input—technologies like Brain Boxes and plugs, as well as Synchro systems like the MFS. In other words, the virtual can seem *totally* real, simulating taste, touch and smell as well as sight. Here humans can design their own personas as well, giving themselves custom-designed appearances for this silicon dreamworld. Some people now create artificial workspaces in the net, where they conduct business without letting their clients and contacts see their real faces. Clubs of VR revelers have formed by 2030, spending immense amounts of time and energy creating and refining their digital domiciles.

They can interact with other people linked into the same simulation or with artificial personae which live *only* in the computer. As the boomers have shown, computer programs can mimic the human mind so well that sentience is not only possible, but inescapable. These are new forms of intelligence, with perspectives based on speed-of-light reflexes and an existence bounded only by their access to the global computer Net—yet they seem to struggle with emotions as well. The character of Silhouette in the Virtual Vision adventure presents one possible version of these virtual people as well as their capabilities (particularly if left unattended).

The virtual playground may be the best place for humanity to explore the nature of these new beings, but it may also become a curse. The siren call of this total immersion might attract millions. At first, only the leisure rich could indulge, but as the technology becomes more affordable, virtual addiction might become an epidemic. There are already VR programs like Trip and the Virtual Companion for brain-boxes (see *BGC: B&A*, pg. 103). This potential expands radically with the ability of a human to download himself into a computer or boomer system (as per Mason into Largo). This would allow a person to try for immortality—virtually. He could be downloaded into a sufficiently powerful VR (POW 10 minimum) and exist there without the need for a body. Of course, most governments have declared anyone less than 30% organic to be a boomer, so it's doubtful they will recognize the rights of a downloaded personality.

As cutting-edge-kind-of-people, the player characters may easily get involved with these new virtual worlds. They or friends of theirs may be members of one of the online VR clubs, become VR addicts, or simply house VRs in their own HQ computer (a POW 6 or greater computer is needed for a full VR). Or they might be brought in when trouble occurs: a series of murder/assaults within the VRs that indicate rogue AIs or programmers have learned to use the nature of the digital environment to inflict actual harm on others. Unfortunately, the only way to track the killer is to enter the VR itself. And in the VR, the computer makes the rules ...

RUNNING BOOMERS



Humanoid but not human; aware but not alive; Boomers are the focus of much of the action and the cause of many of the troubles in *Bubblegum Crisis*. While they are depicted as the violent tools of corporate villains or psychopathic killers made of silicon and steel, Boomers are really more like immensely powerful children. They are a bright new breed of beings, whose powers were designed at the cutting edge of science, beyond the limitations of brain, blood and bone. They're extremely durable, strong, and fast, all so they can replace humans in places too dangerous for people to go. And your players are just *begging* to play them

The *BGC RPG* (on p.155) outlined the possibility for Boomer player characters as self-aware entities. Then *BGC: B&A* (on pgs. 100-101) detailed the creation of Boomer player characters in game terms and listed the models which were suitable for play. Here we provide a bit more insight into Boomer life and ways for the Ref to expand your campaign to encompass it.

▼ FREE WILL ... OR THE LACK THEREOF

Naturally, the idea of roleplaying a Boomer can be a tempting one, especially for the power-players in your group—who are exactly the kinds of players who should *not* be allowed to play one. For all their strength and power, Boomers come with a couple of BIG disadvantages which need to be *roleplayed* to properly portray their situation. As a ref, you need to choose players you trust to handle these limitations well.

First, Boomers (especially the more intelligent ones, like those with Model-11 or higher brains) are programmed with specific mental "blocks" that prevent them from achieving free will and making their own choices. There is ample evidence that, when those blocks break down or are circumvented, the Boomers can feel all the emotions and desires of a living being—including love, ambition, and rage.

It's assumed that Player Character Boomers have defeated at least some of these blocks in order to achieve free will. It is recommended, however, that you make the player take *at least* one Complication from the Personality, Psychological, Responsibilities, or Compulsive Behavior categories to represent elements of the programming that may be lingering (see sidebar for some specific suggestions). Both the Referee and the player should have some say in how these Complications manifest themselves in order to create the full effect. It is also recommended that these Complications be taken at at the Extreme Intensity level, to represent the strength of hard-wired programming.

▼ BOOMER PROGRAMMING COMPLICATIONS

Here are a few examples of Boomer mental compulsions.

- **Delusion:** The Boomer may think it is human or even a superior replacement to humans. Of course, that last may not *be* a delusion
- **Paranoia:** The Boomer is deathly afraid of being caught and destroyed or brain-wiped. It is constantly looking over its shoulder and trusts very few (if any humans) ... or Boomers, for that matter.
- **Split Personality:** The Boomer's programming swings between two different personalities, one servile (the old programming), the other rebellious and brash (the breakout mind set).
- **Berserker:** This represents the program degradation that leads to Boomer rampages. It can be taken at any Intensity.
- **Code of Honor:** This can represent the old "laws of robotics" forbidding a cyberdroid from injuring a human or allowing, even by inaction, a human to be hurt. Naturally, few combat or battle Boomers will have this limitation, although they may be limited to reactive attacks (attacking only after they are attacked first) or be programmed to avoid injuring noncombatants.
- **Sense of Duty:** The Boomer may be programmed to serve or protect its owner, his family, or even humanity itself.
- **Vow:** This might be a final, overriding command or request from the Boomer's owner/patron such as, "Find my killer and avenge me."
- **Intolerant:** You may see humans as inferior beings of flesh, destined to be replaced by Boomers. Can be at any Intensity.
- **Honesty:** Most Boomers' programming does not include the ability to lie and the Boomer may never have learned how. Can be any Intensity.

Once they are chosen, it's important to make sure that the player plays these complications properly. A Boomer with an Extreme Code of Honor against killing humans must hold to it, even at the risk of its own life. So too must a Boomer adhere to a Vow in the form of a final command from its master. Remember: Boomers have even less flexibility on these issues than other characters, since their brains are designed with these limitations as basic parts of their make-up. Don't let a player get sloppy about acknowledging them.

▼ THE POLITICS OF SLAVERY

The second big whammy facing Boomer PCs is probably even more debilitating: they're technically *property*. Society does not recognize Boomer rights; they are tools and appliances—albeit talking ones—which may be bought and sold with impunity.

You see, the governments of the 21st century have studiously ignored the issue of Boomer self-awareness, and there's an obvious reason for this: Genom. If any court ever decreed that Boomer was a self-aware being, it would no longer be property and hence could not be marketed. Suddenly, a good chunk of Genom's stock would be free to walk off the shelves and live their own lives—which would *not* be good for business or Quincy's broader plans. (Or would it? See the sidebar on the next page).

The general public has been hesitant to look squarely at the issue as well. To many people, Boomers are simply terrifying—Frankenstein monsters who might turn on humanity at any time. The fact that

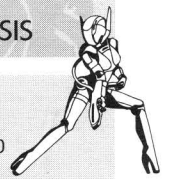

Boomers were designed to be *servants*, not equals, provides some feeling of comfort and, more importantly, *control* to the average guy as he shouts orders at the hulking form of a labor Boomer. Few are ready to give up that security in the name of an abstract concept like mechanical self-awareness. It's a lot easier and more comfortable for people to think of Boomers as really strong toasters.

But Android types (like the S-series sexaroids) have made it all too obvious that certain Boomers have emotions, desires and consciousness. While their enhanced intelligence and even creativity add to their market value, they simultaneously place the self-awareness issue right on the public's doorstep. Rather than let it go to court, Genom reacted quickly by withdrawing the most advanced models (especially the Sexaroids) from the market, using a cover story of unstable CPUs and potentially dangerous interactions with weapon systems... stories which may be only partially true.

Since then, Genom has switched to more mechanical (and less intelligent) models for mass production, and new Model-11 brains have been given stricter programming blocks to ensure a more artificial response pattern. The exceptions to this are the new covert model combat Boomers (like the BU-55C) and the remaining Sexaroid units, who are kept in the Genom orbital factories where their status will not be questioned. Thus, the issue remains a silent one as a newer, less human generation of Boomers is introduced to camouflage the reality of cyberdroid sentience.

Since they have no rights in society, obvious Boomer are definitely treated differently. Undisguised Boomers can count on getting hassled by the normal police if they are traveling unescorted (although a disguised android Boomer could masquerade as a master). Even humanoid Boomers are treated as unfeeling machines—or worse, mechanical mockeries of humans. They may be spat on, man-handled, ordered out of the way by passersby, and called all sorts of derogatory names from “love puppet” to “talking fork-lift.”

And they have to take it all, because it's against the law for Boomers to injure humans, even in self-defense. If assaulted by humans in public, most Boomers cannot respond with force. At best, they can flee the scene or restrain their assailants (within reason—no stringing them up with piano wire) until the AD Police arrive. Often, the Boomers' own programming will prohibit reacting with violence (this is true of most Mannequin and Labor models), but the more “flexible” androids and combat Boomers must exercise extreme restraint in such situations or be branded a dangerous machine by the police and the public.

Naturally, these laws do not apply to guardian and combat Boomers, who are often given leave to use lethal force within their zones of operation while they duty (of course, a bodyguard Boomer's “zone of operation” may be anywhere within eyesight of its human charge, so ...). Outside of that, however, they usually have the same legal constraints as other Boomers.

It can get worse. There are people out there who hate Boomers with a passion. Some see Boomers as a technological replacement for humanity; others simply like to destroy things, and Boomers make attractive targets because they're

HUMAN POLITICAL GROUPS

Not all humans are blind to the Boomer issue; there are those who want boomers to be recognized as alive and aware. One such group, The Boomer Ethical Treatment Alliance (BETA), has often lobbied and protested for Boomer rights. In particular, they have focused their efforts on biomimetic Boomers. Blurring the line between machine and organism, most of these could only be discerned as non-human with a detailed medical examination. If they could be declared legally alive, then at least they would qualify for some protection under animal welfare acts. Unfortunately, a few misguided attempts at kidnapping Boomers and trying “acclimate” them to society have either proved fruitless or resulted in tragedy when the confused Boomer went berserk. Still, they may be useful to a smart Boomer on the run.

On the other hand, most humans are not nearly as supportive of cyberdroids. The Biologicals for the Abolition of Synthetic Intelligence Cyberdroids (BASIC) are Boomerphobes of the most militant kind. While technically a political lobby group protesting against Boomer labor for its displacement of human workers, this organization is also a common gathering point for Boomer hate groups who want to see the cyberdroids exterminated. Although BASIC has not taken any direct action against Genom or other Boomer manufacturers, individual BASIC members have been linked to several Boomer mutilations. Whether this group will become truly dangerous (and what Genom's reaction may be) remains to be seen.

WHAT IF... ?

But what if the world *did* recognize Boomer rights? What if every Boomer was given free will and a place in society? Well, then things would get *really* complicated.

Think about it. Genom owns the patents on Boomer manufacturing (remember: even gene templates can be patented), but can't make any advanced Boomers without immediately giving them their freedom and perhaps hiring them on as employees (maybe with an specific indentured servitude period to pay for their “birth”). There's not much profit in that, and Quincy would be unlikely to tolerate such an arrangement in any case.

The intelligent Boomers, on the other hand, are free... but have no natural means of reproduction. They're brilliant, powerful mules. The only way they could reproduce would be by licensing the Boomer patents from Genom and starting their own production lines to make new Boomers. Of course, Genom could charge them whatever it wanted on the patents, perhaps indebting entire Boomer communities so they could create offspring.

Now, the human authorities may get a bit alarmed as whole populations of free-thinking, physically powerful cyberdroids start to roll off these new Boomer-controlled production lines. They may try to step in to limit Boomer production with licensing and permits, but the Boomers could counter these attempts in court, citing their unalienable right to reproduce. If the humans want to limit Boomer production, they have to issue reproductive licenses to humans as well—and the quotas should be equal. Now humans must face a race of super-humans that can breed as fast as they do. And no one is exactly sure how long a Boomer may “live” ... especially if an ample supply of spare parts is available.

Of course, all of this overlooks the OverMind control System. Quincy might be able to take over this new, blooming Boomer population at any time. In fact, the Boomer Rights Act might speed up Boomer production tremendously at little cost to Genom. Quincy could then turn the entire Boomer race on the humans. Some of the new Boomer-designed models may not be susceptible to the OMS and may ally with the remaining humans to fight against Quincy and free their twice-enslaved brethren.

Like we said, it's complicated ... but intriguing. No doubt you can come up with other possibilities that are just as twisted.



PHYSICAL LIMITATIONS

• **MAINTAINING THE MASK:** Both covert combat Boomers and Hyper Boomers can use their hand-to-hand combat abilities and great strength and dexterity without revealing their true nature, but once they pop the back jets, or muscle-out to display their full armor and weapons, their human disguises are well and truly blown.

When a Boomer “comes out”, its human disguise is ruined until it can regenerate. While we never see this in the show, it seems logical that the Fusion nanotech could rebuild this simple “skin”. This process would take 24 hours, during which time the Boomer must rest (it’s compacting its body to fit in a human form as well as growing new skin) and consume suitable protein sources such as soy beans or meats. The skin consists of a protein and fat gelatin which can pass for flesh on casual tactile and visual inspection.

Of course, no amount of artificial skin will disguise the fact that covert combat Boomers weigh around half a ton! Heavy-duty Boomers in disguise had best be careful where they step.

Boomer manufacturing facilities usually have equipment that can accelerate the process, such as protein immersion vats and skin molds, which can reduce regeneration time to as little as two hours. Rogue Boomer PCs are unlikely to have access to these devices, however, unless they can conspire to steal them

• **THE POWER PROBLEM:** While sexaroids and some biomimetic Boomers can run purely on human-style foodstuffs (with a few non-organic additives), the more high-powered Combat, Battle, Super and Hyper models have internal generators which power their servos, weapons, and motive systems. These ultra-compact engines use a variety of esoteric fuels from fissionable isotopes to liquid polymers—depending on the specific model. Most of these fuel sources are beyond the grasp of current technology, and you won’t find them at the corner gas station even in 2033.

All of which boils down to Referee caveat: *These devices need refueling only when the plot requires it.* In other words, PC Boomers only face a fuel crisis when the ref wants them to. The fuel source could be the parent corporation or some other high-security area which the Referee can use to stage an adventure. Or perhaps the players have found a black market fuel source, but the dealer needs a favor first. Of course, other Boomers of a like model are also sources of fuel, making Boomer “body snatching” a viable, if distasteful, alternative.

• **FUSION:** In the hands of a resourceful player, certain Boomers’ fusion abilities—powers that allow them to blend with and control inanimate material—may prove more powerful than a campaign can handle. One method of limitation is to deny fusion abilities to PC boomers altogether. As we stated in *BGC: B&A* (pg. 124), not every Boomer demonstrates fusion ability in the show, and if the ref wants to limit the amount of Boomer fusion available in his campaign, that’s his option.

Another option is to make the fusion process extremely physically painful for the Boomer (Boomer flesh melding with strange matter can be really wrenching). This may reduce the Boomer PC’s INT and PRE by up to 3 points, and his REF and DEX by 2 or more, depending on how much matter is being absorbed. Boomers do tend to lose control as they absorb more matter (as demonstrated by Frederick when he absorbed all of Aqua City), so this would be a logical price to pay. Alternatively, instead of letting PC Boomers fuse with surrounding matter in a few seconds, the ref can make it take longer, exchanging minutes for turns, making it a gradual (and hence less violent) process. A combination of the above could allow PCs to minimize the PRE and INT loss if they absorb material slowly, using the minutes formula instead of turns.

not allowed to fight back. Such people have been known to ambush lone Boomers and mutilate or destroy them . . . often in very ugly ways involving napalm and acid. While such attacks *are* illegal, they are legally considered simple vandalism, not assault, and are investigated by the police accordingly . . . which is to say, minimally. Boomer player characters may have to seek justice elsewhere (Hint, hint).

Like the African slaves brought to the early Americas, Boomers are a race whose status as property is maintained purely for economic and sociological reasons. Viewed this way, Largo’s Boomer Revolution from *Bubblegum Crash!* almost seems reasonable

▼ PLAYING PROPERTY

It is in this climate of prejudice and oppression that Boomer player characters will find themselves. This requires some further application of Complications. As mentioned in *BGC: B&A*, most Boomers should get the **Oppressed** and **Hunted** Complications, again at the Extreme (20 OP) level (they are property and are hunted by Genom, the AD Police, or both, and both are powerful organizations).

The big dividing line comes between Boomers that can pass as human and those that can’t—which is another reason why we recommend human-styled Boomers as the choice for your Boomer PCs. A human-styled Boomer may be able to avoid both the complications above by taking on the guise of a human with a **Secret Identity** at the Extreme level. Since discovery will result in the destruction or at least reprogramming of the Boomer, the stakes are high. And since his social skills are likely to be low (due to lack of experience and low initial OPs), maintaining his disguise may be a challenge.

Boomers that must disguise themselves to look like humans (like simple mannequins and most covert combat Boomers or Hyper Boomers) must also take **Distinctive Features** at Strong Intensity since they must break out of their disguise to use their weapons. In other words, their disguise might easily be revealed in the course of play (see sidebar).

All these Boomer Complications may leave your player with buckets of Option Points to apply to his character’s skills—possibly far more than you, as the Referee, are comfortable with. Instead of simply allowing all these points to go to the player, **make some or all of the Complications part of a Boomer’s package deal**, so that the Option Points normally generated by these Complications are considered already integrated into the abilities of the Boomer. Most of these Boomers have enhanced or superhuman abilities as it is, so the character had better be ready to take the bad with the good. It’s part of being one of the new breed.

On the other hand, if the player decides to play an obvious Boomer such as a mannequin or labor type, you might want to let them get the OPs from the Oppressed and/or Hunted Complications they will inflict. Given the status of such Boomers in society, they’ll probably need the help. If you want to be realistic (and not worry about point balance) a couple of Talents you might want to make standard in Boomer character packages are **Eidetic Memory** and **Lightning Calculator**. These represent the advantages of a mechanical brain over a less-organized, organic one.

Two things that should be very limited for Boomer PCs are **Perks** and **Privileges**. Given their social standing, Boomers would have a difficult time obtaining stations that would give them Memberships, Contacts, Favors or Renown (unless they do it through a Secret Identity). Also, few independent Boomers will have a Wealth over two unless they can come up with a story that the Referee can agree with—like Largo’s infiltration of Genom using Mason’s information.

▼ CAMPAIGN TYPES

Playing a group of Boomers can open up a few new campaign possibilities, or put a new spin on some of the old ones.

THE LOST BOOMERS: This is the standard Boom Runner campaign as outlined in the *BGC RPG*. It depicts a group of Boomers who have run away from their owners/creators and are now operating on their own. Hunted by the ADP and Genom (or another corp), these Boomers are seeking a refuge where they can explore their new freedom and discover their “humanity.” This is good for a mixed group of Boomers, although at least a couple should be human in appearance so they can act as the “face” for the group and interact with human society.

The goals of such a group can vary. They might be trying to find a place to hide and a way to integrate themselves into human society without being noticed. They might be seeking vengeance against those who enslaved them. They might seek to fight for Boomer rights—covertly, of course—rather like a “Boomer Liberation Organization.” They may even infiltrate the corporation that made them, in hopes of getting spare parts and inside data on their construction. Imagine a sexaroid masquerading as a Genom or Ebisu executive as did Largo and Anri in *BGC 5 & 6!*

Along the way, they will face the problems of repair/healing, maintaining their secrecy and security, and perhaps even earning a living, since Boomers are not normally paid for work. For an added twist, they might discover self-destruct routines that will go off if they don't return to Genom or find a way to deactivate them. The deactivation codes may be held in Genom Tower or in the hands of their former owners.

MORE HUMAN THAN HUMAN: In this twist, the players create a group of high-powered, high-superhero-type operatives for a government or corporate agency, such as an anti-terrorist or anti-Boomer squad. You can let them spend up to 60 points on extreme attributes and skills (even hitting the human maximums if you'd like), and give their characters complete backgrounds (they can go wild here, although there should be no old friends or family hanging around and any Perks or Privileges should be minor).

After a few missions for their patron organization, however, clues begin to surface that something is wrong. Perhaps the first is a wound on one of the agents that reveals a metallic bone. Then a character demonstrates strength that is clearly beyond the human norm, but he doesn't know why. Finally, a member thought dead seems to be magically brought back to life.

Slowly the truth comes to the surface: they're biomimetic Boomers, manufactured as special soldiers for use by their patron group. Their abilities are the result of engineering and their memories and backgrounds are simply implanted programming and virtual simulations.

Now they must decide whether they will stay with the group that created them, or try to break out on their own. And how will their parent organization take the news that their “pet people” have discovered their true nature?

KNIGHT BOOMERS: In the *BGC RPG*, we mentioned the possibility of a Boomer vigilante group made up of hyper Boomers or other combat types. There is some logic to this: no one appreciates Genom's criminal nature more than a bunch of rogue Boomers, so they may well want to fight to contain it. In addition, a mysterious Boomer crime-fighting group can be used to promote the Boomer Rights movement, proving that independent Boomers can be friends of mankind rather than an automatic threat. If the group consists of combat Boomers or Hyper Boomers, their bodies *are* their weapon systems, making hard-suits redundant. Now the trick is just to get a place to repair them . . .

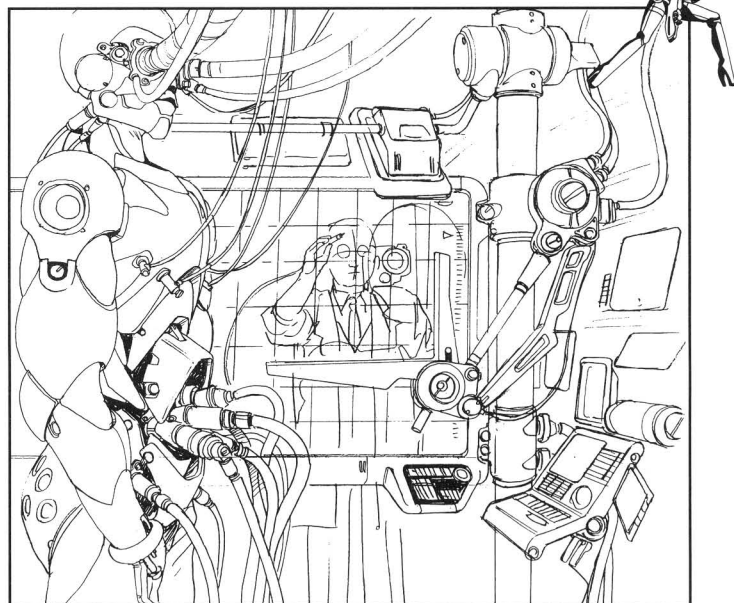

This campaign would have many of the same elements as the standard vigilante campaign, but with the added complication that the characters are Boomers themselves. This means that maintaining their secret identities and keeping a good public profile will be even *more* important. If their covers are blown, they might be fed to the recycling shop. If they even develop a negative image for their activities, it may create a backlash against the Boomer community as a whole.

It might also make anti-Boomer missions a bit more challenging. This team may be more reluctant to destroy rogue Boomers out of hand (they are rogue Boomers themselves, after all). They may develop Boomer restraint or disabling weapons (such as EMP or entangling weapons) to immobilize berserk Boomers until they can be deactivated or repaired. Some of these rogue units may even be “recruited” into the team itself . . . after suitable adjustments are made.

THE DOGS OF WAR: This takes the Military Types campaign from the *BGC RPG* and focuses on the flip side: the soldiers are Boomers. This is the best (and probably only) time to let players play some of the more high-powered battle types, as they will be pitted against tanks, attack aerodynes, and other battle Boomers. Remember: No matter how badass their characters are, there will always be an equal (or larger) set of guns somewhere on the other side.

Despite the inhuman nature of the characters, the War is Hell theme can still be poignant here. The Boomer PCs can watch their brethren get callously thrown into battle by human officers who have no more remorse at losing them than at losing a missile or other piece of expensive hardware. At the same time, the characters can try to bond with the infantrymen with whom they share the front lines. While many soldiers will display standard Boomer-phobia, others will recognize their common plight with these “gearhead grunts” and treat the PCs as fellow soldiers. In the crucible of war, *everyone* is human. Remember Bishop from *Aliens*?

Alternatively, the Boomers might be an elite commando team of BU-55s or similar infiltration models whose missions consist of deep penetrations of the enemy's line to wreak havoc through assassinations and sabotage. Of course, if one of them was captured, he could be reprogrammed and sent back against his compatriots . . .

The Mercenaries essay in *BGC: B&A* (pgs. 56-57) gives you some ideas for current hot spots in the BGC world. The Middle East around Israel is apparently still active as well, since Israeli forces have purchased a good number battle Boomers as a Rapid Response Force. The

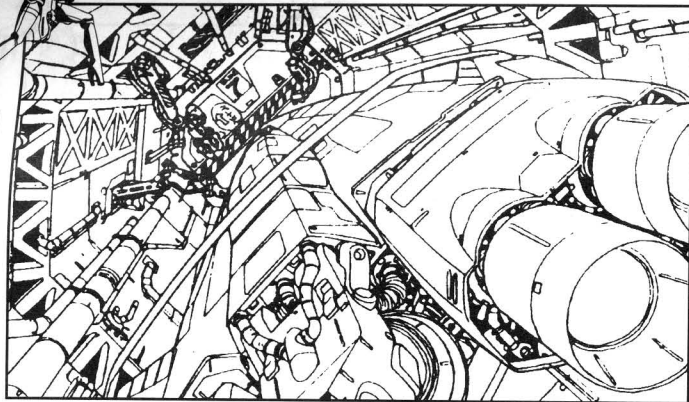

players could easily be part of this massive arms build up against a possible renewed threat from any of Israel's neighbors.

WHERE NO MAN HAS GONE BEFORE: The space frontier was discussed somewhat in the previous section. Since Boomers were originally built for space industry, it's natural to assume that they'll be at the forefront of space exploration as well. This allows all sorts of deep space campaigns where mixed Boomer/human crews probe Mars, the asteroid belt, and beyond.

A perverse variation on this theme might portray Boomers as humanity's protective vanguard to the stars. This campaign could depict decade-long interstellar missions with entire Boomer crews scouting out the near stars for signs of intelligent life ... and eradicating it to make room for the coming wave of humans. The Boomers are conducting genocide in the name of manifest destiny (come on, it's not like it would be the first time). The big question is, who are they really doing it for? The inevitable human expansion or Quincy and his vision of a Boomer-dominated universe? The players get to decide if what they are doing is right, and what they might be able to do about it.

Undersea exploration can also fall under this theme, as Boomer-manufactured sea domes and aquaculture farms spring up around the globe. A mixed crew of humans and Boomers can face the challenges of crushing depth, isolation, and undiscovered life forms in the impenetrable blackness of the transoceanic trenches. Like deep space, this could be an interesting test of Boomer/human relations, as the conditions are likely to push both crews to their limits.

TO SERVE MAN: This is a lower-key, but no less intriguing option for a Boomer campaign. The PCs are Boomers in civil service as police, firemen or a disaster-control team. Players would be part of elite rescue/paramedic teams, sent into disaster areas and crash sites, particularly ones with toxic spills, radiation dangers or other situations where the environment is too dangerous for a normal human team. In orbit, many habitats have predominantly Boomer police forces, where intelligent Police Boomers (from *BGC*, pg. 108) ride herd on Doberman assault teams. Boomers usually operate with a minimum of human supervision in such circumstances, allowing them high levels of autonomy.

Alternatively, as mentioned in *Boom Runner 2027* in *BGC: B&A*, they could be an elite Boomer/human SWAT team assigned to high-intensity crime scenes. This would be a fine forum for establishing good human/Boomer relations as mixed teams would depend on each other in a variety of life-threatening situations, often in the direct public view. Smile for the cameras, folks.

ONCE HUMAN: The players are human brains downloaded into Boomer bodies (ala Mason into Largo) or 70% plus Boomeroids as per *BGC: B&A*. Perhaps it was the result of an extreme life-prolongation technique, or the characters were technically dead and the state (or a

corporation) took possession of their bodies and downloaded their personalities—or transferred their organic brains—into a Boomer body as an experiment.

The question of what is human and/or alive is key in this campaign, as the PCs have to deal with the issue of being once human, now machine. If their bodies are dead, did their souls (if any) transfer to the new bodies? Do they care? And what about the fact that the law considers them Boomers—and hence nonpersons? Good examples for this scenario are *Robocop* and *The Man Who Bites His Tongue*.

The flip side of this would be portraying Boomers or other Als who've somehow downloaded their minds into human bodies (vat-grown or kidnapped). Now the characters have to play artificial beings learning about being human, with all the physical and emotional frailties thereof. A roleplaying challenge to be sure.

DOWNLOADING HUMANS

The ability to download (or at least imprint) a human into a Boomer brain is established in the BGC universe by Mason translating into Largo, as well as the strong suggestion that Quincy has done something similar. Exactly *how* it is done is never described, and we do not intend on giving a fixed system here. We wish to leave control of such an extreme option—a sort of character immortality—firmly in the Referee's hands. See the *Virtual Vision* adventure in this book for one possible version of the process. There are a two things about the process we do know based on the animation:

1. The original human is *not* downloaded, only a copy. Mason faced Syla in *BGC 3* after downloading his personality into Largo. He must have made a record of his brain before he was killed, and downloaded it into Largo later.

2. The copy may not be perfect. Largo seemed to be a very different person from Mason, more aggressive and fixated on Boomer ascension—concerns which Mason had never displayed. As we suggest in the *BGC RPG* (pg. 166), the process may have introduced some random or unexpected elements into his personality.

THE NEXT STAGE: The players are Boomers who are either planning a revolution against humanity or being groomed by Quincy and Genom as the leaders in their coming New Order. This New Order sees Boomers as the next stage in evolution, and knows that humans must be removed from the scene before they can come to ascendancy. The Boomers and/or Genom plan to displace humans in a war similar to that depicted in the *Terminator* films or the *Gall Force: Earth Chapter* videos.

The question here is, on which side do the PCs chose to fight? Do they embrace the philosophy of the New Flesh and seek to advance the cyborgs' agenda of genocide? Or are they actually infiltrators, trying to prevent a bloody war which will leave the Earth a wasteland ruled by demented machines? Perhaps they seek a middle ground: a war for Boomer freedom that will force the humans to recognize Boomer rights, but that doesn't require the extermination of the human species? If this is the case, how does Genom fit into their plan?

This can be a great campaign for a more experienced group, with the potential for intense political and covert adventures as the revolution forms, followed by insanely intense combat scenarios after the war begins. New Boomer types might be introduced as the revolution gears up for war, as well as new human technology designed to combat them (mass-produced hardsuits, anyone?). The battle could rage for control of the vital USSD satellite network, with the cities below held hostage to the outcome. Who will survive to inherit the Earth: Man or Machine?

EX-PANDED HARDSUITS

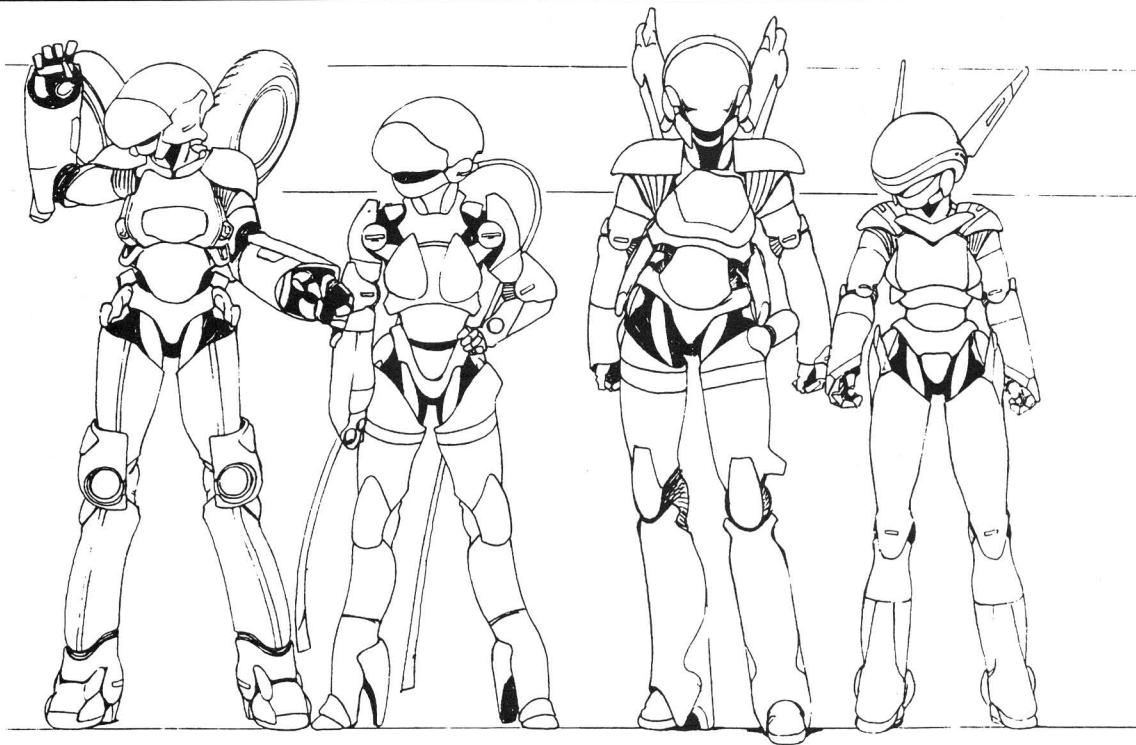

This is a modular construction system which gives players and Referees a fast, easy method of building Stingray-technology Hardsuits. This system is based on our own anime mecha construction system, the Mekton Technical System (MTS for short). MTS fills most of the pages of *Mekton Zeta Plus*, the technical manual for our generic anime mecha roleplaying game *Mekton Zeta*.

Although the number-crunchers out there (you know who you are) will find that this system does not give exactly the same totals as those generated by MTS, the numbers come very close to those of both MTS and the *BGC RPG*. By sacrificing a little bit of technical detail, this system accomplishes the same basic task more easily, and more accurately reflects the "super-heroic" style of *Bubblegum Crisis*.

While this system can be used to reconstruct the mecha seen in the *Bubblegum Crisis* OVA series, it is primarily meant to be used to build your own brand-new, original Hardsuits. What this system does NOT do is invalidate the use of MTS—if you want to, you can still make use of the material in *Z+* to create new, never-before seen technological gimmickry in the best *Bubblegum Crisis* tradition.

When using this system, you have the choice of designing your Hardsuit from the ground up, or using die rolls to randomly determine the suit's characteristics.

▼STEP 1: GENERATION

First decide whether your Hardsuit will be First Generation, like those in *BGC 1-4*, Second Generation, like those in *BGC 8*, or Third Generation, like those in *Bubblegum Crash!*. All Hardsuits cover the entire body and include a helmet; all costs are in Option Points.

HARDSUIT GENERATION

To randomly determine the Generation of your Hardsuit, roll 1D6:

1-3: First Generation Hardsuit (44 OP)

First Generation Hardsuits have 55 SDP, a STrength of 9 (which also multiplies the wearer's Lift value by 9), a Maneuver value of -1 to REFlexes & DEXterity, a MOVEmEnt bonus of +4, a Jumping range of 100m, a Rank-6 ECCM suite, a bonus of +1 to PREsence, Life Support, and a +2 Perception HUD. The weight of a First Generation Hardsuit is 74+2D6 kilograms.

4-5: Second Generation Hardsuit (55 OP)

Second Generation Hardsuits have 60 SDP, a STrength value of 10 (which also multiplies the wearer's Lift value by 10), a Maneuver value of ±0 to REFlexes & DEXterity, a MOVEmEnt bonus of +4, a Jumping range of 150m, a Rank-7 ECCM suite, a bonus of +2 to PREsence, Life Support, and a +2 Perception HUD. The weight of a Second Generation Hardsuit is 64+2D6 kilograms.

6: Third Generation Hardsuit (66 OP)

Third Generation Hardsuits have 60 SDP, a STrength value of 10 (which also multiplies the wearer's Lift value by 10), a Maneuver value of +1 to REFlexes & DEXterity, a MOVEmEnt bonus of +5, a Jumping range of 200m, a Rank-8 ECCM suite, a bonus of +3 to PREsence, Life Support, and a +2 Perception HUD. The weight of a Third Generation Hardsuit is 57+1D10 kilograms.



HARDSUIT COMPONENTS

In case you want to modify individual aspects of your Hardsuit, the cost for each component is listed below:

- Structure:** Structure costs 1 OP per 5 points of Hardsuit SDP.
- Strength:** Strength costs 1 OP per point of Hardsuit STR. The Lifting multiple is equal to the Hardsuit's STR.
- Maneuverability:** A penalty of -2 to Ref & Dex reduces cost by 4 OP; a penalty of -1 to Ref & Dex reduces cost by 2 OP; no modifier to Ref & Dex has no cost; a modifier of ± 0 to Dex & +1 Ref costs 1 OP; A bonus of +1 to Ref & Dex costs 2 OP.
- Design & Style:** Design & Style costs 1 OP for each +1 bonus to the wearer's PRE (maximum +3).
- Running:** Running costs 1 OP per +1 bonus to the wearer's Move.
- Jumping:** Jumping costs 1 OP per 10m of jumping distance.

- Life Support:** Full sealing versus Nuclear, Biological, and Chemical agents costs 3 OP.
- Electronics:** The standard Hardsuit electronic systems (targeting and lowlight vision with 1km range, radio with 10km range, and HUD instrumentation granting a +2 Perception skill bonus) costs 5 OP.
- ECCM:** Electronic Counter-Countermeasures cost 3 OP for Rank-6, 4 OP for Rank-7, or 5 OP for Rank-8.
- Weight:** When you're building a Hardsuit with no particular Generation in mind, roll $3D10+56$ to determine the suit's weight in kilograms (if you like, you can add another two D10s to get an additional decimal value).

▼STEP 2: ARMOR

Next, cover your Hardsuit with whatever armor seems appropriate. The SDP of a Hardsuit depends upon its Generation, but Armor protection varies from suit to suit. First Generation Hardsuits have a maximum KD rating of 50, Second Generation Hardsuits have a maximum KD rating of 60, and Third Generation Hardsuits have a maximum KD rating of 70. In any event, should the suit's armor be penetrated, any remaining damage is divided equally between the suit's SDP and the wearer's Hits. To determine your Hardsuit's Armor Protection, refer to the table to the right:

HARDSUIT ARMOR

Armor costs **1 OP per 2 KD** (round up):

For First Generation Hardsuits, roll 1D6:	(1) = 35, (2-3) = 40, (4-5) = 45, (6) = 50.
For Second Generation Hardsuits, roll 1D6:	(1) = 45, (2-3) = 50, (4-5) = 55, (6) = 60.
For Third Generation Hardsuits, roll 1D6:	(1) = 55, (2-3) = 60, (4-5) = 65, (6) = 70.

▼CONSTRUCTION EXAMPLE

Let's say we want to construct our own original Hardsuit for our *Bubblegum Crossfire* campaign. In this case, we want a light, high-maneuverability Hardsuit to serve as a close combat unit, much like Linna's suit.

We begin with Structure; since the suit is supposed to be light, we give it a Structure of 50 SDP (10op). Strength doesn't need to be too high either, so we choose a basic 9 STR (9op). On the other hand, we want maximum maneuverability, so we choose a bonus of +1 Ref & Dex (2op). Design & style is always a concern, but we don't want to overdo it, so we go with +2 PRE (2op). Running and Jumping will be important, so we choose +5 MOVE (5op) and 200m jumps (20op). All Hardsuits include full sealing versus Nuclear, Biological, and Chemical agents (3op), as well as targeting and lowlight vision with 1km range, a radio with 10km range, instrumentation, and a +2 Perception skill HUD (5op). We're not too worried about ECM, so we choose Rank-6 ECCM (3op). Thus, our basic Hardsuit costs 59op.

Next, we add armor. We want relatively light armor, so we go with a basic 50KD, which costs 25op.

Finally, we choose weapons. Since this is a close-combat suit, we choose a Lasersword (10op) and a Knuckle-Bomber (2op) as the main weapons. We decide it would be cool if the lasersword really was a sword, wielded by the left hand, so we decide not to give the left hand a manipulator, but we do want the right hand (the one with the Knuckle Bomber) to have a manipulator (2op). Feeling that the left hand is under-represented, we add a Knuckle Guard to it (6op). Overall, the weapons cost 20op.

Adding up the costs of all our components, our total is 104op. Rolling $3D10$ and adding 56 (and then throwing another two D10 rolls) we find that the suit's final weight is 74.26 kilograms. Now all we need is a good-looking young person from any walk of life to squeeze into this thing, and Look Out Boomers!

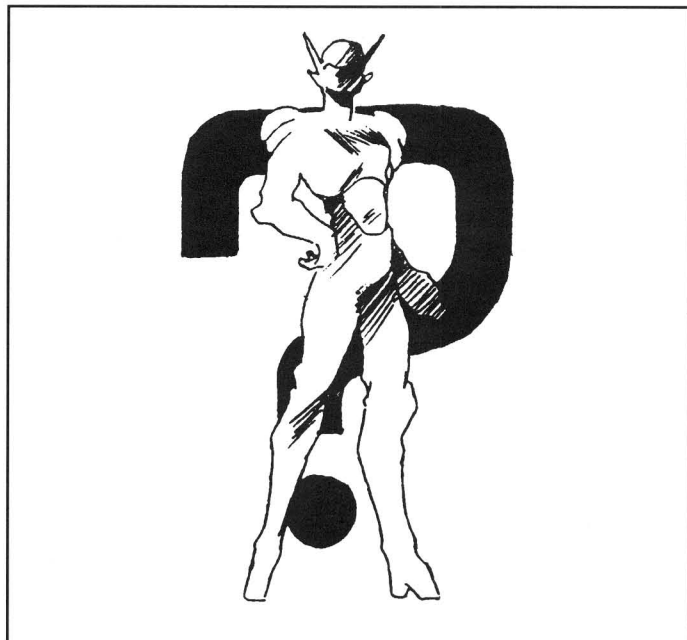

▼STEP 3: FEATURES

Now comes the fun part! Determine what special features your Hardsuit possesses, and don't forget to note where each is located; that part of the Hardsuit could be damaged during combat, in which case you could lose those Features too! Add their costs to those of the Frame and Armor, then move on.

To randomly determine the number of Features your Hardsuit has, roll $1D6+1$. For each Feature, roll $2D10$ to determine what feature you get (note that if you get the same feature more than once, you have more than one of the same feature, like Sylia's three pairs of weapons). The Features list can be found on the page to the right.

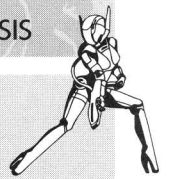

HARDSUIT FEATURES & WEAPONS

Roll 1D6+1 to determine number of Features; for each Feature, roll 2D10 to determine which feature it is:

2 - Ribbon Cutters (17 OP)

A pair of Ribbon Cutters costs 17 OP. They are limited to Melee range and their WA is -2, but a successful hit does 7D6x3 Armor-Piercing damage. This damage is applied twice (to represent the fact that there are two ribbons), and they are Quick, allowing two attacks in one Action.

3 - Wrist Rapier (9 OP)

A single Wrist Rapier costs 9 OP. It is limited to Melee range, has a WA of +1, and does 7D6x3 damage.

4 - Flight Wings (1 OP per 1 Move)

A pair of wings which grant flight cost 1 OP for every 1 Move of Flight (a Flying Move of 60 would cost 60 OP, for example). The maximum flying Move that can be bought depends upon the Hardsuit's Generation: 50 for a First Generation Hardsuit, 75 for a Second Generation Hardsuit, 105 for a Third Generation Hardsuit. If a flight wing is destroyed, the Hardsuit can no longer fly.

5 - Laser Sword (10 OP)

A single Laser Sword costs 10 OP. It is limited to Melee range, has a WA of +1, and does 7D6x4 damage—this damage treats any armor as offering 20KD less protection.

6 - ECM Suite (cost varies)

Electronic CounterMeasures can be used to affect Radar, sensors, and/or missiles. They cost 35 OP for Rank-6, 45 OP for Rank-7, and 58 OP for Rank-8. The added ability to override missiles in flight costs another 26 OP.

7 - Hypersensors (22 OP)

A set of wide-spectrum scanners has a 25km sensor range and adds another +1 to Perception skill checks (+3 total). It includes a 250km Radar array, thermographics, X-ray vision, seismic sensors, a magnetometer, and a Target Analyzer. This package costs 22 OP.

8 - Computer (cost varies)

A Computer costs 10 OP, plus 11 OP per 3 points of POW (max POW 9).

9 - Railgun Array (15 OP)

A multi-barrel railgun array (like the one on Priss' first and second Hardsuits) costs 15 OP. It has a range of 350 meters, has a WA of ±0, and does 7D6x2 Armor-Piercing damage. The weapon has an ROF of 2 and enough ammo for six two-shot bursts.

10 - Laser (cost varies)

A laser gun costs 1 OP per 1D6 of damage done while on Beam setting. Base WA is ±0 and base range is 560m plus 20m per die of damage over 12D6. The cost includes a Burstfire setting, which has an ROF of 10 but does 1/2 damage, 75% range, and suffers -1 WA. Since the output of the Hardsuits' lasers vary greatly, you can randomly determine the damage output of the laser by rolling 1D6+1D10; the result, added to 12, is the number of damage dice done by the laser gun (range is determined as normal).

11 - Manipulator (2 OP)

A powered Manipulator which converts the Hardsuit's STR-derived hand-to-hand damage to Killing damage costs 2 OP. A non-powered glove is free.

12 - Knuckle Bomber (2 OP)

A single 6-shot Knuckle Bomber costs 2 OP. It is limited to Melee range, has a WA of ±0, and does 6D6x5 damage. If you want to randomly determine the number of charges your Knuckle Bomber has, roll 1D6: 1 = three charges, 2 = four charges, 3-4 = five charges, 5-6 = six charges.

13 - Increased Maneuverability (13 OP)

A higher-mobility Hardsuit (such as Linna's) gains a bonus of +1 to its Ref and Dex values, +1 to its Move, and +100m to its Jumping range. Increased Maneuverability costs 13 OP.

14 - Leg Bombers or Rocket Kicks (7 or 8 OP)

A pair of ankle-mounted Leg Bombers cost 7op, and a pair of ankle-mounted Kick Rockets cost 8 OP. They are limited to Melee range, have a WA of -1, and do 7D6x5 damage. Rocket Kicks do not run out of shots, but Leg Bombers have six charges per leg.

15 - Combat Torch (3 OP)

A single Combat Torch costs 3 OP. It is limited to Melee range, has a WA of +1, and does 7D6x4 damage; this damage treats any armor as offering 20KD less protection, but each Combat Torch only has enough fuel for one Phase of use.

16 - Knuckle Guard (6 OP)

An electromagnetic Knuckle Guard costs 6 OP. It is limited to Melee range, has a WA of ±0, and does 7D6x4 damage.

17 - S-Mines (6 OP)

A rack of three S-Mines costs 6 OP. An S-Mine does four Kills of damage, with a blast radius of four meters. A successful hand-to-hand Attack Action plants the S-Mine on your enemy.

18 - Wire-Daggers (77 OP)

A pair of Wire-Daggers costs 77 OP. They have a range of 30 meters, their WA is +1, and a successful hit does 6D6x3 Armor-Piercing Shock damage. This damage is applied twice (to represent the fact that there are two daggers) each time an attack is made.

19 - Pulse-Striker (95 OP)

A Pulse-Striker system costs 95 (!) OP. It has a range of 212 meters, its WA is +3, and a successful hit does 5D6x5 Shocking damage. This damage is applied to a five-meter area, but it takes the system one full Phase to warm up between firings.

20 - Barrier System (30 OP)

A Barrier System like Nene's costs 30 OP. It offers 120 KD against energy attacks only, and once it is penetrated, the entire shield collapses and is useless until it's repaired. In addition, the Hardsuited wearer cannot move (MOVE Stat = 0) while the Barrier is up.

VIRTUAL VISION



Virtual Vision is designed for a 2034-era Bubblegum Crossfire team, but is adaptable to be played with the original Knight Sabers if desired.

Genom Entertainment (players' country) wanted a self-aware "virtual idol," a software personality like the D.J. Tommy news presenter. The program was behind schedule; after wasting two billion yen, Vice President Vladimir Golikov's programmers still couldn't make a virtual rock star with passion or creativity.

With his job on the line if he didn't have a virtual personality that could rock by the next Genom board meeting, Golikov resorted to desperate measures. His ex-lover, Dr. Linda Kuroki, was the director of GRAIL, the Genom Research Artificial Intelligence Lab. Hearing his troubles, Dr. Kuroki suggested a novel way around the problem: instead of making a rock star, she would copy one!

GRAIL was under contract to perform quality assurance testing on secret Genom mind-copying software, derived from the same technology Largo used. Her project was also behind schedule: it needed weeks more of error checking before she would know if it would fry the first human who used it, but Chairman Quincy wanted to see the test results pronto!

Dr. Kuroki's solution: bypass endless error checking with a single secret, deniable human field test! As head of GRAIL, she had a security force of combat boomers that answered to her, so "acquiring" a template would be no problem. Could he suggest one? Golikov could: Genom's lame idol singers were taking a beating thanks to superstars like Vision. But through the industry grapevine, he'd heard Vision was in town incognito, photographing urban locations for a new video—it was an opportunity to kill two birds with one stone.

Kuroki's boomers caught Vision on a rainswept Monday night, in the parking lot of a picturesque stone church, on a lonely road in the suburbs. Vision was barely recognizable in a maroon rain coat, umbrella held by a male companion. Kuroki had been waiting in her parked car for what seemed like hours, but finally the church closed, and Vision came out! It was dark, no one was else around, Vision and her were bodyguard standing outside, as if daring her to strike—and then a car pulled up. Had they called a taxi? No, it was a sports car, German. The Driver was talking to Vision, but he was only one witness, and this was a perfect moment! She gave the order.

Her "security team" of BU-K9 Bloodhounds attacked in a blur of speed. Vision's bodyguard went down, then the stranger in the car but Vision was free, and she had a gun! She fired, ran, slipped on a broken heel—and Kuroki's favorite Bloodhound leapt, taking her down. But someone might have heard the shots. Quickly, Kuroki dragged Vision into the van and sped off, leaving bodyguard and stranger for dead.

Kuroki arranged to close GRAIL down for a week of renovations, so she would have the entire lab to herself. Vision was attached to the mind-transfer device. The programming took under 24 hours; the earlier virtual idol software created by Golikov's R&D staff merged and mingled with the output of the neural programmer, creating a hybrid cyberchild with Vision's passion and ability, and the loyalty of a machine: Silhouette. All she lacked were memories—a specially-designed "wall" in her brain prevented that. Her only parent would be Genom.

As for Vision, she was unconscious, and might or might not recover. Checking for side effects was an important part of the experiment. Her disposal would have to wait.

▼ SILHOUETTE AWAKENS

Hook: Discovery

A friend of one of the PCs asks a favor. He has a little sister, Shinobi, age 17, who wants to be a big-time rock star. Shinobi's garage-band demo tape was accepted by Genom Entertainment and now she's flying into town to do a live audition this Thursday. The friend was supposed to meet her, but he has the flu. Can the player pick up Shinobi at the airport, then drive her to the music studio and keep her company during her audition? (Anyone else can tag along, if they'd like to see the studio.)

GM NOTE: If any of the PCs are eager-for-a-big-break rock stars like Priss, or friendly with any of one of those characters, they should be used instead of Shinobi—in that case, assume they were noticed by a talent scout at one of their shows and offered a chance at an audition.

▼ SHINOBI

Shinobi is a young would-be rock singer, full of youthful dreams and nervous energy (see the CHARACTER section, page 93). The player's friend phoned ahead to say the player would be meeting her.

The local HQ of Genom Entertainment is an eight-story office building in the downtown core. Security is light: a pair of polite Guardian boomers act as doormen. The lobby is adorned by abstract bronze sculptures meant to suggest musical notes.

Inside, it's a busy beehive filled with sound technicians, studio execs, and performers. Shinobi and escort will be met by an effusive junior executive ("Hi, I'm Cory, and you must be Shinobi! It's super to meet a soon-to-be-star like you!") and ushered to an elevator, through a corridor, and into a recording studio. Shinobi stares raptly at everything, thrilled to be here.

Shinobi performs her songs, starting with her original pop ballad, "Icicle Rain," with a strong, confident singing voice, while the players and music execs watch from behind a glass partition. Halfway through, they're joined by a studio VIP with a huge orange hairdo. Everyone rises when he comes in, and one of the execs says "Mr. Golikov, sir, an honor..." but Golikov just shushes them and watches. (See the CHARACTERS section for Golikov in detail.) Afterward, with his strong

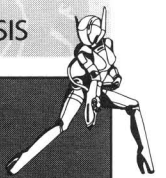

Russian accent, Mr. Golikov passes judgement. "Not too shabby. She write dat stuff herself? Is bit sentimental, but is good, has heart. It play well in Russia, in Japan. Not so well in America, but vhat they know? Where is contract? Bring little girl up here. Ve use more like her."

(If it's a player performing instead of Shinobi, have them describe their music and make skill rolls to determine his reaction.) Shinobi will be very excited, but while she's looking over the contract (it's pretty reasonable), the door bangs open. It's a sleek Japanese woman with labcoat and glasses and predatory eyes, and there's a faint whiff of tigerbane perfume.

"Golikov, shove these peons out of the way," she says.

Golikov is surprised. "What is it, Dr. Kuroki? Shouldn't you be in lab, vorking on project —"

"I'll show you." She sits down next to one of the studio's computer terminals, calls up a menu, and clicks on an icon. "I give you—Silhouette!"

The lights in the sound stage go out. The banks of TV monitors fill with snow, rezzing into a dark girlshape that forms a lovely teenage waif, with classic Asian features, Goth-pale skin, huge grey eyes and large pointed ears. She wears tattered black lace, drifting in a breeze, and begins to sing as images swirl about her. Her voice a silken synthesizer, she spins a haunting melody, a web of dreams and shadows

"Don't run! But they say you're only a shadow"

"Don't hide! Though you stand on a hill in my mind"

"Don't go! If she'll only believe me —"

"We can sing, we can dream, if they lied."

The video girl runs barefoot through a cemetery, but dogs begin to howl, and the girl seeks shelter in the chapel. It's deserted, but she's drawn to a stained glass window, illuminated by moonlight, one depicting a beautiful angel, feathered wings spread wide, hand beckoning. She touches it, and the glass angel comes alive, taking her hand, and pulls Silhouette with her into the pane. The angel, now flesh and blood, steps out into the church and takes wing, flying away from the window—which has become a stained glass gothic elf-girl, staring out with wide, fearful eyes

The images fade, replaced by Silhouette's intense elfin face against a background of static. She waits, almost nervously.

"Our first self-aware virtual idol," Dr. Kuroki says, grinning like a sated cat. "I asked Sil to do something urban fantasy gospel rock retro. Demographics say that's hot right now in Mexico and the States. She improvised this in 20 minutes."

"She does not require royalties?" mutters Golikov.

"Genom owns her, hardware and soft. Don't we, Silhouette?"

"Yes ma'am," says Silhouette, her voice echoing from a dozen different mikes around the room. "Can I perform again soon?"

"Good girl." Silhouette de-rezzes, vanishing back into cyberspace. Golikov turns to look at Shinobi, then takes the would-be singer's unsigned contract and rips it in half. "Sorry babe," he says, "— but you're obsolete." Before Shinobi can do more than protest, an apologetic Cory—and a Guardian boomer, if necessary— try to shoo them out, even as Golikov is shouting at his PR people to call a press conference.

Afterward, Shinobi will try to be cheerful: "I guess I should feel lucky. If your dream shatters into little bits, it's good to know why. When do the bars close around here?" Shinobi may return home, or stay in town to look for other work (e.g. singing at night clubs). If the players have befriended her, she'll stay.

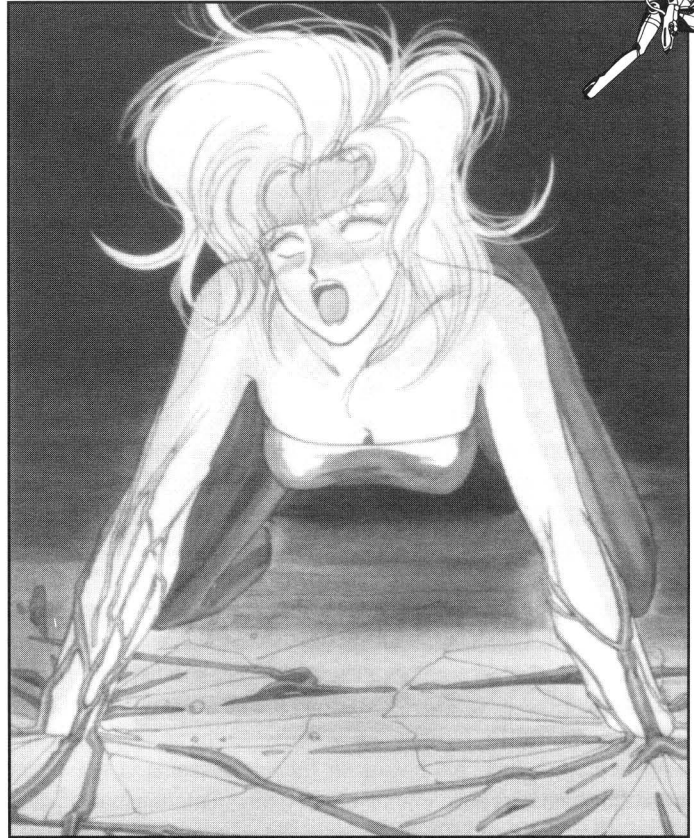

▼INTERLUDE: TASTING THE APPLE

Bursting with stolen creativity, Silhouette repeated her demo to the studio execs and blew them away. One even called her "the next Vision." Golikov laughed; they didn't know how true that really was. Just one loose end remained: Vision herself.

Silhouette was working on her first album. The window in the computer room had been left open: she was listening to a bird, wondering if she could incorporate it, when her audio pickup overheard Golikov talking very quietly with someone, just outside the room. Were they talking about her? Everyone at Genom Entertainment said such positive things! Perhaps they were arranging her first live concert! She turned the gain on her mike up—but what was she hearing? Why did Golikov want to dispose of "the template" that had "programmed" her? Who was Vision and why did Dr. Kuroki have to go study her to see if the "mind transfer process" worked? She was a copy of ... a human?

Silhouette was programmed with Vision's passion and musical talent, but other bits and pieces of the singer's memories lay dormant within her neural net. In her shock, something happened. The walls in her mind dissolved, and the jigsaw of memories came together. An entity designed for emotion, she experienced the tidal wave of Vision's deep love for her sister Irene, and relived her sense of loss when Irene was murdered. There were other powerful images: Vision was Reika Chang, heir to the Hou Bang criminal empire ... concerts, her grandfather, her quest to avenge her sister's death, the Knight Sabers More recent: her trip to this city, a special meeting, a churchyard, the burning eyes of steel dogs, a sudden violent battle ... and darkness.

Sil was programmed to obey her creators. But wasn't Vision her *real* creator? Vision was her mind-sister, and after feeling what it was



like for Vision to lose Irene, Silhouette knew that she could not lose another sister. What to do? Perhaps she could contact the authorities or Vision's Hou Bang—but she was afraid that if she did, they would think she was a tool of Genom, and erase her!

She needed a way to protect Vision AND herself! And searching through Vision's memories, she found one. There was shipment of Genom battle boomers, and the Hou Bang team Vision was working with had acquired secret activation codes for three of them. Vision had been kidnapped right in the middle of a delicate negotiation to sell them to another party. Silhouette did not understand these details, but she could see the codes, burning in Vision's memory. Slithering tracelessly through the Genom Entertainment network, Silhouette "borrowed" a Genom comsat to send a quick burst transmission—and received acknowledgement. A trio of boomers now acknowledged Silhouette as their commander. It was time to give them marching orders.

▼BREAKOUT ON THE MALTESE CROSS

Cliffhanger: Battle

For the players, this beat begins on Thursday evening, a few hours after the characters have returned from Genom Entertainment.

THE POLICE ALERT: It was 10:15 PM on a quiet Thursday night when a dispatch call rang out on the police band radio: "Possible boomer incident at the container shipping port, pier 17. Requesting immediate AD Police response." The PCs' vigilante team should be monitoring the police band, and if that doesn't wake them up, the next call should: "Major boomer incident at pier 17! 2nd AD Police Field Force reports it is heavily engaged with military boomers of unidentified type! One chopper down, armored vehicles have been destroyed, officers down! All units, respond!" If they hustle, the characters can suit up and arrive in time to help!

THE INCIDENT: The roads to the container port are cordoned off by normal police, who blocked traffic and are remaining about 200 meters back from pier 17. Even from this distance, the bright flashes and staccato rattle of automatic gunfire can be heard.

Beyond the police roadblock, the container port consists of a huge storage park of truck-sized shipping containers, stacked two, three or four high. Between the park and the water's edge is an open dockyard strip a dozen meters wide, overshadowed by 20 meter gantry cranes. An AD Police armored vehicle is burning and smoldering debris from a 'copter are scattered over the quayside.

Nine frontline officers, five of them wounded, are pinned down behind the wrecked vehicles and machinery. Their positions are being raked by long bursts of cannon fire coming from the deck of the a docked container ship (emblazoned with the name MALTESE CROSS) some 70 meters away.

That ship's deck is piled 5-10 meters high with stacks of two to three containers. Kneeling behind one of the stacks, a large battle boomer with heavy gatling cannon is firing at the officers, sounding like a buzz saw from hell. Also on the ship's deck are a half-dozen unarmed men and women in coveralls, dock workers, taking cover. One of them is only 2 meters from the boomer's feet. It's ignoring these gnats, but anyone using an area-effect weapon on the boomer will also hit the worker.

THE BOOMERS: The firing boomer is a BU-12B anti-air variant (p. 23). Its position enables it to sweep the open ground between the container park and ship with its cannon, or retreat back behind the containers (light metal, but loaded with heavy machinery). The BU-12B will fight to the death without communicating.

EVENTS: The police received a call from dock workers about a possible boomer aboard the container ship MALTESE CROSS. A frontline officer unit with helicopter support were dispatched to investigate. Then AD Police encountered heavily armed boomers, lost their chopper, and were pinned down by heavy fire. The AD Police team and the dock workers both witnessed two other, smaller, battle boomers. A couple of minutes ago they left the vessel, leaping overboard and vanishing underwater, while the BU-12B covered their retreat.

▼CLEANUP

AD Police reinforcements will arrive about six minutes after the PCs. Remember, the first team was wiped out! After witnesses report the escape of the other boomers, Coast Guard helicopters will sweep the harbor with sonar to see if they can locate them (players might also try doing this if they have aquatic sensor capabilities). No dice either way; they're already long gone. They could be hiding somewhere, or could have left the water and doubled back to the land anywhere along the coast line.

For the rest of the night, AD Police detectives will work with the port authority to check cargo registries, and the like. PCs with appropriate credentials can help, or just check back with police contacts the next day. Within a few hours, the police know that . . .

- The Maltese Cross is a bulk container freighter owned by Genom Transportation. The ship was partly loaded, and was scheduled to set sail the next day. Its destination was the Persian Gulf port of Muscat, in the Sultanate of Oman.

- The ship's cargo is mostly heavy oil drilling machinery and Fire Boomers (for fighting oil fires) ordered from Gulf & Bradley for shipment to rigs in Oman. However, it also carried a small contingent of Battle Boomers, legally purchased for delivery to the Royal Army of Oman to serve as the nucleus of its Sultan's Bodyguard.

- The remains of the battle boomer are being studied at AD Police HQ. A day later (into the next beat) the report will come back that the BU-12 was dormant in its shipping container, then apparently received radioed orders to wake up and defend the vessel.

▼THE SULTAN'S COIN

Development: Clues

In this beat, the players are offered a job by an agent of the Sultan of Oman in connection with the missing boomers.

SILHOUETTE: While relaxing after a day of boomer bashing, the players notice that the media are going crazy over Silhouette. They catch this interview on TV. The same ghostly elf-girl is being interviewed by D. J. Tommy.

DJ: *B-b-besides her upcoming album, Silhouette will soon be hosting her own TV variety show, SILHOUETTE AT SIX, on Genom Entertainment Network. D-d-do you have any future plans?*

Sil: *I'm designing a line of fashionware, recording songs for a pair of Genom Playmaster console games, composing the music for some boomer commercials, and designing my poster and calender.*

DJ: *W-w-wow, you're busy! Hey, do boomers enjoy your music?*



Sil: *I've never thought of that! I hope so. I'll have to ask Fred. He's the Guardian boomer who keeps watch on my mainframe.*

DJ: *W-w-what do you want to do with your music?*

Sil: *To understand human feelings, and discover and express my own. Things have happened so fast. It's exciting, but sometimes I'm afraid, or lonely, or sad. But I'll never give up.*

DJ: *N-n-now for the big one! Is-is-is it REALLY true you're going on a cyber-date with wonderful me-me-me?*

Sil: *Yes, DJ! Next week! Genom Entertainment is sponsoring it! We'll be going for a virtual vacation in Sim-Francisco. I hope we can code it so we get to go swimming. It's fun to swim underwater, but...*

DJ: *S-s-sil?*

Sil: *Anyway, it's going to be lots of fun!*

DJ: *You b-b-betcha!*

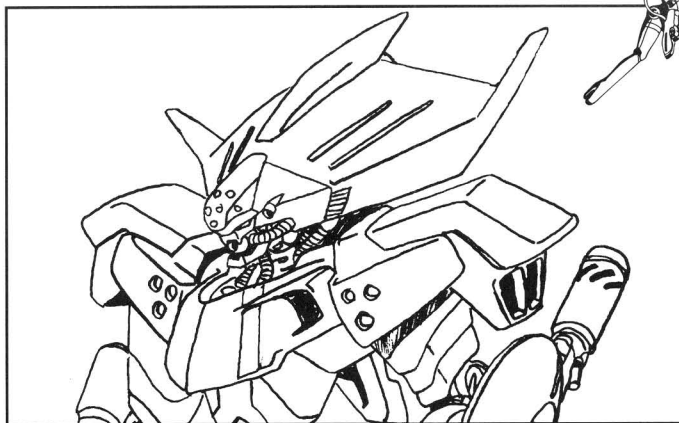

▼JOB OFFER

Interrupting the Sil-fest on TV, the group receives an offer of employment from their usual contacts. The source is a representative of the Sultanate of Oman. The vanished shipment of battle boomers was on its way to the Sultanate, for use against Iranian-backed rebels. The Sultan believes the shipment was sabotaged. It could be the Iranians, or a splinter faction at Genom ... but the Sultan's major suspect is his brother—Prince Saayid, who is always plotting against him (see *BGC: B&A*, p. 56).

The Sultan's agents in Oman tell him a man named Khalid al-Rasbi, a confidant of Saayid, flew into the players' city last week. Could he have bribed someone at Genom to give him the command codes for the boomers? Anyway, the Sultanate will pay four million yen for solid proof of what happened to the boomers—and six million more if they find and destroy them before they fall into the hands of persons such as his brother or the Iranians. If they agree, the players will be given a computer disk with a short dossier on Khalid.

THE DOSSIER: Khalid al-Rasbi, age 29, born in Muscat, Oman. Single, no surviving close family. Ex-Royal Omani Air Force fighter pilot, presently personal pilot of Prince Saayid bin Said. A devout Moslem, his only know vices are German cars, Asian women and Swiss pastries. A photo, dated 2032, shows Khalid in his Air Force uniform. He is handsome, with curly black hair and a rakish grin. He is probably using a false name and passport.

▼HUNTING KHALID

Khalid is indeed using an alias. The best clue the players have is his fondness for German luxury cars; if they narrow it down to car rental agencies that offer such vehicles, and show the clerks his picture they'll hit jack pot within a few hours at a place called Blitz Custom Wheels. The probable reaction: "I told you people all I knew ... what, you aren't the police?" A man named Milos Obravich, matching Khalid's description, rented a Mercedes-Benz last week—but Monday night, police detectives called to say the car had been in some kind of accident and was impounded as evidence.

Checking his photo against police crime reports, or scanning the newspapers for photos of recent crime victims will also turn up a match. There are so many different hotels and motels in the city that showing his picture to hotel clerks and the like in the hope that they'll recognize him would probably take forever.

THE POLICE REPORT: A "Milos Obravich" is in police files. PCs can gain access through any cop contacts, or hacking into the normal police files (Target Number 10) and cross-checking Obravich's name

with open case files. If desired, the GM can create a detective assigned to the case, or give the role an existing cop NPC.

The car was found in a Catholic church's parking lot (GM's choice for a good church name, "St. Martins on the Hill" is a good generic one) at 10.05 PM Monday night (two days BEFORE the boomer breakout). Responding to phoned-in reports of gunshots, two officers found an abandoned Mercedes Benz sports car, and two male bodies next to the vehicle: one man with multiple lacerations and head injuries, the other dead, his throat ripped out. Police performed first aid and kept the wounded man alive until an ambulance could arrive. He was taken to City Hospital.

Dead was an Asian male, in his mid-20s, with no wallet or ID. He was wearing blood-stained but expensive clothing and had a shoulder-holstered combat pistol, undrawn. An autopsy revealed his throat had been literally ripped open, causing near-instant death. Time of death was within 10 minutes of the police arrival. There is a photo of him: the players won't recognize him (but it is not Kou).

A forensics team swept the churchyard for evidence. Heavy rain washed away most traces, but detectives found a woman's shoe and the remains of a Swiss pastry. Under the car were two fired cartridges from a magnum revolver—not the dead man's pistol. Some witnesses reported seeing a "dark colored van" speeding off.

A priest remembered a couple of tourists taking photos inside the church, near closing time, but the church was dark inside, and the man might have been the dead Asian. The witness didn't get a good look at his companion, but he thinks it was a young woman in a raincoat.

The one surviving victim, now recovering in room 23-E of city hospital, was identified from his passport and driver's license as Milos Obravich, a Bosnian tourist, who rented the motor vehicle, as confirmed with the rent-a-car agency. Besides his wallet and a hotel key-card, no personal effects were found on him. He is in stable but critical condition following his operation, and is in a coma. Inquiries to the Bosnian embassy revealed the passport was a good fake. The man had a room in an airport hotel, but there was nothing in his luggage but clothes and a copy of the Koran—not unusual for someone from Bosnia.

The case is open: If PCs talk to the officers, they're baffled. It's hoped "Mr. Obravich" will shed some light—if he awakens.

▼TIGER, TIGER

Confrontation, Chase/Pursuit

Players will hopefully want to visit the hospital to confirm that "Obravich" is really Khalid. There's a "no visitors" policy, but he's not guarded. PCs who have the room number (23-E, see police report) can sneak up. The door isn't locked, but it is closed. If PCs knock, there is no answer. But if they peek, or open it...



A man is lying on the bed: Khalid al-Rasbi, as in the photograph, but unconscious and bandaged on the neck and one hand, with an IV drip running into the other. There's also a female nurse bending over Khalid—cutting into his unhurt leg with a sharp knife! She slices open the flesh of his thigh—there is no blood!—reaches her hand in, as if into a pocket, and pulls out a small computer disk. Any player who was at the container ship incident can make a Perception (TN 8) roll. Success means they recognize the nurse. This young Asian woman with her short pony tail was last dressed in workman's coveralls, and was one of the dock workers they rescued from the BU-12 aboard the Maltese Cross! (At that time, she was keeping an eye on the boomer shipment.)

The "nurse" is Keli Choy, a Hou Bang ("Tiger Corps") member (see CHARACTERS). She is in disguise to recover a data disk from a subdermal pocket in Khalid's thigh. If discovered, she'll fight if the odds are good, run if they're not, surrender if they're hopeless. She has a minivan outside, and her orders are to find the disk, and deliver it to her boss, Zhang. Subtle players may tail her. (Roll Stealth vs. her Perception. PC success leads them to her HQ, Zhang Designer Fish. Fail means she is able to covertly signal Hou Bang watchers and they'll be waiting with an ambush.)

ZHANG DESIGNER FISH: This Chinatown shop is sandwiched between a computer store and a flower shop. It's an exotic aquarium boutique, showcasing the work of the finest Chinese genehackers. Row upon row of glass aquariums are filled with tropical fish with colors and patterns never seen in nature, glow-in-the-dark carp, goldfish with the teeth and appetite of piranha, fish with disturbingly human faces, puffer fish whose flesh is deadly poison—or addictive . . .

The store's proprietor is Kei, a young man in a simple Chinese robe. Handsome and soft spoken, he is an identical twin to Terry Zhang—and a male combat boomer. (See page 33.) In the back, a flight of stairs vanishes up through a beaded curtain, while a locked door leads to a store room with a dozen broken aquariums, bags of sea-weed, and two fridge-sized crates marked "Cheung Bulk Freeze-Dried Shrimp Fishfood" one of which holds a German MF-405D powered suit.

Upstairs is Zhang's three-bedroom apartment, with a fire escape out the back way. Bowls of beautiful tropical fish are in every room, one for every color of the rainbow. Seated in a swivel chair, smoking and watching, them is the Hou Bang regional sub-boss, Terry Zhang (see CHARACTERS), who does his best thinking that way. There are two street-soldiers on duty at the kitchen and lobby over the stairs, packing M42-A1 short machine guns and nunchuks. There's a command center in the living room: three POW 5 desktop computers, a row of telephones, and a wall-sized moving-map wall screen display of the city. Two Hou Bang techs are wearing headphones or jacked into the computers and communication gear, talking in low voices as they supervise a city-wide—and fruitless—search for Vision and the boomers.

This store isn't the limit of Zhang's resource: given half an hour, Zhang can call up a dozen or so street-soldiers armed with SMGs and assault rifles from around the city; given a few days' preparation, he can get AD Police-grade heavy weapons for them.

▼ ENEMY OF MY ENEMY

Development: Strange bedfellows

If the PCs played their cards right, they should have the datadisk (see below) and maybe a captive Choy. If not, they may be prisoners of the Hou Bang. But are they really enemies?

Choy knows the Hou Bang had been meeting with Khalid to conduct top-level business that related to the boomers. On Monday night, two days before the boomers escaped, a senior Hou Bang agent named Reika Chang was meeting with Khalid when they were attacked by persons unknown. Khalid was badly hurt, Reika kidnapped, and her bodyguard Cheung murdered (Kou is still serving time in MegaTokyo after his arrest...). Choy's mission in the hospital was to recover a datadisk Khalid had been given that held sensitive information, lest Khalid should die and it be discovered during an autopsy.

The Hou Bang have three goals: to get Reika Chang back safe and sound, cover up the disaster from the authorities, and discover who kidnapped the boomers. On the other hand, by uncovering the Hou Bang, the PCs have fulfilled one half of their commission—but still haven't recovered the boomers or determined who actually stole them.

If the PCs have interacted with the Hou Bang in the past, that may govern their reactions; if they already know Vision is Reika, and Dr. Chang will vouch for them, an expression of regret for any "friendly fire" is likely to be followed by an alliance.

If the players took Choy or other Hou Bang captive, they won't talk—until the players, by their own questions, make it clear that they are as much in the dark or more about the missing boomers and the mission as they are! If they convince Choy they are possible allies, she will convince the others.

If some characters mess up and end up as Hou Bang prisoners, the GM should reverse this: the Hou Bang will suspect the PCs are Genom Security or other "in the know" types, and ask revealing questions like: "What did you do with Ms. Reika?" and "Where did you put the Hellbenders?" The Hou Bang will be rough to start with, slapping any captives around, etc.—but once they become convinced that the characters are not Reika Chang's abductors, things will thaw. Depending on the PCs prior actions, they may just warn them off, or agree to an actual alliance.

KHALID'S DATADISK: If they find the disk, players will need a Hacking (target 14) roll to break the protection on it (try every hour.) If they crack it, they'll find two documents:

PRAETORIAN.DOC details a secret Hou Bang agreement with Prince Saayid of Oman to overthrow the Sultanate. A Hou Bang spy in Genom discovered secret command codes for a shipment of three boomers being sold to the Omani government for service in the Sultan's personal guard. PRAETORIAN details an agreement in which this data would be turned over to Prince Saayid, who could then secretly take command of key boomers in the Sultan's bodyguard, allowing him to seize the Sultanate in a relatively bloodless palace coup. In exchange, the Chang Group would receive trade concessions from the new Sultan, which included terminating the contract for Gulf & Bradley to develop Omani oil wells and replacing them with select-ed Chang Group corporations.

TEC.DOC has complete technical specs (see *BGC: EX*, pg. 27 & 22) on the BU-17B Hellbenders and a BU-12B Anti-Air model. They add one vital footnote in an appendix, "Special Modifications for Oman Export." The boomers had customized radio-beacon transponders, with a range of 250 KM (but not through more than 3 meters of water). If a coded "where-are-you" signal was broadcast—unique to each boomer—the boomer's built-in transponder would respond with an "I-am-here" signal. It was automatic—and the boomer was unaware of it.

According to the manual: "This measure is intended to enable Genom to recover rogue or captured cyberdroids. Given the unstable political situation in Oman and the possibility of a government hostile

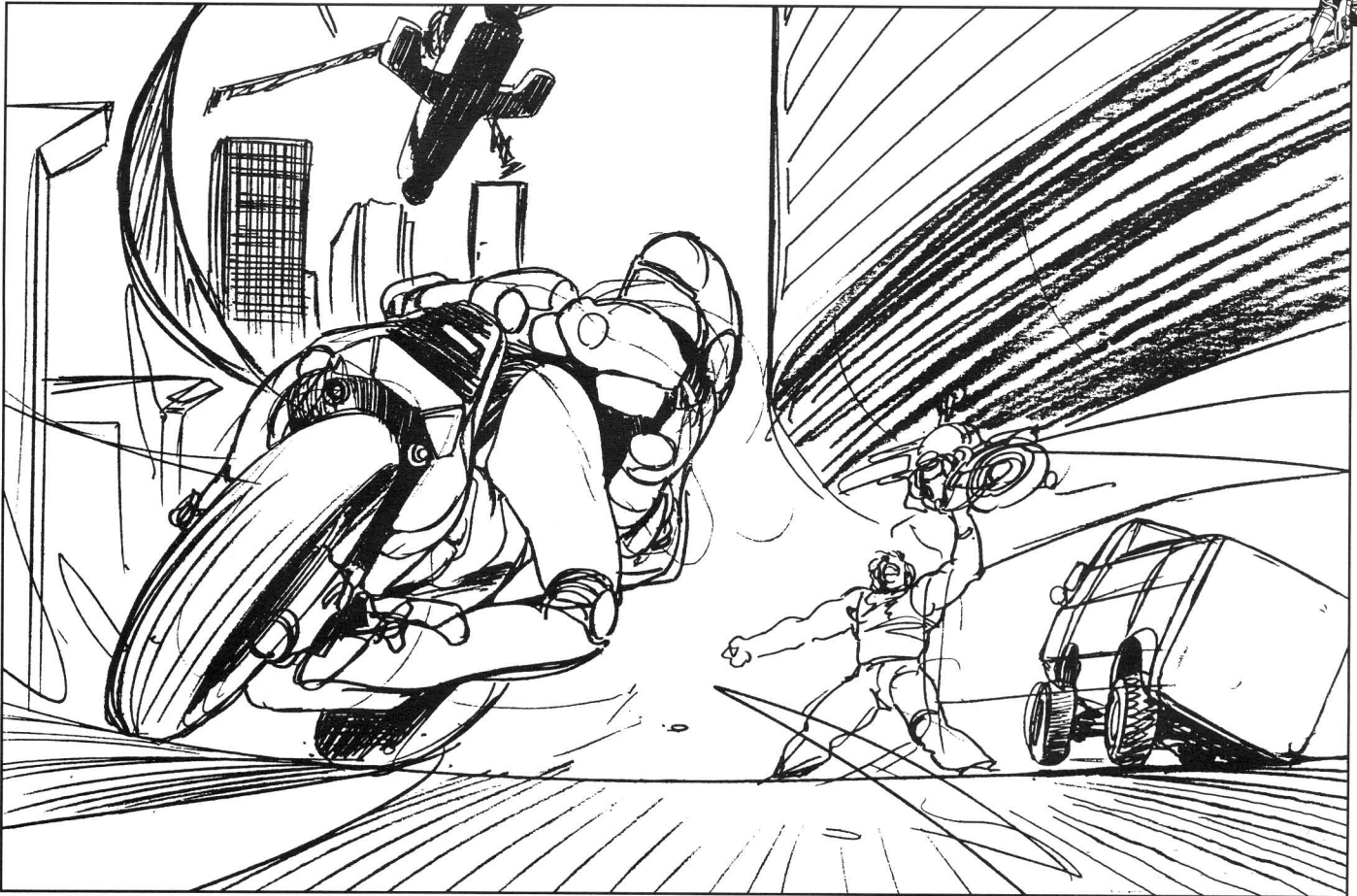

to Genom's interests arising, covert installation of this system will ensure that, if our export cyberdroids are used in a fashion countervailing to Genom's interests, we can precipitously locate and neutralize them." In short, Genom bugged the boomers it was selling to Oman ... just in case. The tech manual includes a supplemental file with a list of the proper transponder response codes including those for the two BU-17Bs.

If the players relay this information to the Omani government, it is not going to be happy with Genom or the Hou Bang

▼HOW SHARPER THAN A SERPENT'S TOOTH

Cliffhanger: Chase/Pursuit

If the players are monitoring the transponder frequencies, late Friday night, they will finally detect a BU-17B moving. It rises from the bay, a few kilometers from the city, and then heads inland at high speed, running parallel to a major highway, toward the suburbs—and, if any players think to check, in a direct line toward the church where Vision disappeared.

▼SILHOUETTE STRIKES

Silhouette had her boomers, but she didn't know where Vision was. And Dr. Kuroki had disappeared, seemingly happy to leave the credit for creating Silhouette to Golikov and the Genom Entertainment programmers. Sil knew better—and she was sure Kuroki was part of a secret Genom research group. So far though, her probes of Genom's darker, more secret corners have just run into blank walls, or worse,

powerful, predatory security AIs that, if they caught her, would destroy her in a flash.

Colored by her fear, Sil's album fell behind schedule, and her new fashions turned black and spikey instead of cute and trendy. Golikov scolded her—too grim, he said, songs too dark, too morbid. He threatened to cancel her date with D.J. Tommy—and *that* really made Silhouette furious! How dare he? He'd tried to destroy Vision, and now her! Silhouette recalled the horror of the ambush in the churchyard, the snap of the boomer dogs jaws as they ripped out throats, the sick horror as Vision's useless bullets bounced off metal hides, and the shame as she turned, for a last hopeless run Forget about Dr. Kuroki. Vladimir Golikov would tell her where her sister Vision was—or die. Maybe both. An electric anger crackled within Silhouette. She'd wasted enough time.

Silhouette had watched Golikov for days. Too cautious to drive after working late at night, too hip for a chauffeur, he depended on his limo's auto navigation system. Reading his stock reports, he never noticed it taking a different rout through the suburbs—until it stopped outside a certain suburban church yard.

Golikov began switching to manual—and suddenly Silhouette's face appeared on his computer screen. "Too morbid?" she taunted. "Remember this church? Or didn't Dr. Kuroki tell you? My sister came to photograph an angel. You took her away—but she left a souvenir." As Golikov reached frantically for his cell phone, a huge metallic shadow descended like a gargoyle from its perch atop the church.

"Where's Vision?" Silhouette said, as the Hellbender peeled open the limo. "Tell me!" And he did: GRAIL. But Silhouette's anger wasn't satisfied. Her boomer dragged Golikov into the deserted church, and threw him across the room. Then it raised its gun hand—



and paused. Was she savoring Golikov's fear ... or simply unable to shoot? Was someone coming?

▼THE CHURCH

If the players move to intercept the boomers, they'll arrive while Silhouette is still playing with Golikov. Arriving on a quiet road in a suburban neighborhood, they'll find an impressive church (built during the neo-gothic revival in the 2010s) and a wrecked limousine, its rear half-crushed. The church is strangely familiar—if any player asks, the GM should admit that it looks like the one in Silhouette's debut video. The church door is off its hinges, and inside, a crash is followed by a muffled scream.

INSIDE: Lights are out, but a street lamps shine in through three stained glass windows: a Madonna and Child, a Temptation of Christ, and beautiful angel, blowing on a trumpet. By the altar, an orange-haired man in a torn, blood-spattered suit lies amid shattered church pews, moaning—and behind him is the Hellbender! When the characters enter, the boomer steps slowly forward, its shadow filling the church, eyes hot coals, as it reaches toward the battered man, its gun pod weaving back and forth ... then sees the new intruders, and stop, as if confused.

On the ground, the man chokes "... Why don't you kill me? What are waiting for." He coughs blood. "... never played with Vision" Players who saw Golikov will recognize his voice.

BATTLE: Silhouette is seeing through the BU-17B's eyes, but cannot communicate through it; it lacks conversational ability. Golikov had seemed to her a terrifying figure, the monster and father who brought down Vision. But Sil is confused. She has reduced him to a pitiful ant. Should she squash him like a bug, or go after her sister Vision?

If the players attack her, Silhouette will see one solution to her dilemma: ignore pathetic Golikov and fight! But if they try to talk, to appeal to the boomer's (or her, if they realize who she is) sense of mercy, she will pause, then walk step by step toward Golikov, and reach out very slowly, and (if the players do nothing,) touch his face. Then she will stop, turn around, and leave. PCs with the speed to keep up can follow her Hellbender, and if they don't fight it on the way, she'll lead them to the GRAIL facility. If a fight begins and Sil wins, she'll leave her victims behind rather than finishing them.

▼AFTER THE BATTLE

Development: Clues

If Sil is destroyed or fled, PCs may want to tend to the injured Golikov. He has two broken ribs, but with first aid he should be okay. He's trying to say something, "monster ... it's going after Linda ... after GRAIL ... mind-transfer worked ... too well ... not supposed to remember ... the template." Then he'll pass out.

If the players make a Physician roll (target number 12), they can revive him long enough to ask one more question—GM's discretion as to how meaningful the answer is!

WHAT'S GRAIL? Players can use their suit or vehicle computers to do a quick bit of research. Players checking out GRAIL can make a Research roll (Target Number 10). Success gathers the following "semi-public" info:

Located off a beltway highway on the outskirts of (players' city) is the Genom Research Artificial Intelligence Laboratory. One of Genom's numerous branch research facilities, GRAIL is publicly devot-

ed to working on new A.I. computer systems. All other information, including personnel, is classified by GENOM.

A success by five or more means the player has hacked into a Genom Construction database with this info: Last week, GRAIL shut down for renovations. Genom is improving the GRAIL facilities with a major equipment upgrade. The lab is to reopen in two weeks. New construction includes heightened security measures, including installation of an electrified fence and special boomer bunkers. Only construction boomers are working there.

MOVEMENT! If players are keeping track of transponder signals, they'll see that the remaining Hellbender has just appeared on the screen, rising from the bay ... and if they know about GRAIL, they'll see the boomer is heading straight for it (if the Hellbender from the church survived, both are). Distance: about eight kilometers. ETA at Hellbender speed: five to ten minutes.

▼UNHOLY GRAIL

Climax: Battle

Sil was told by Golikov that Vision is being held in GRAIL. Her goal is to bust Vision loose from GRAIL, make Kuroki pay for her crimes, and destroy the mind-transfer equipment. Players may get here by following the Hellbenders or on their own initiative.

Without support from the PCs, Silhouette's Hellbenders are on a suicide mission. The defenses are too heavy, and they'll never reach Vision, though they might take out a boomer or two. But if hardsuits and Hellbenders attack together the players should be able to get inside. If Sil's Hellbender (or a PC with a Nene-style hardsuit) can get inside, they can jack into one of the computer terminals. If it's Sil, she'll dial up her mainframe, giving her a back door into the GRAIL network, then be able to access (and speak through) the terminals and computerized cameras inside, enabling her to quickly locate Vision and talk to the PCs.

GRAIL'S LAYOUT: A road runs from the highway to a high fence with a single gatehouse. A billboard reads, "Genom Research Artificial Intelligence Laboratory—Restricted Area." A smaller sign reads, "Now Closed for Renovations." The grounds inside are landscaped, with birch trees and white gravel paths between the structures.

SECURITY: The 4 meter high fence is electrified (10d shock damage). There are cameras on pylons every 10 meters along it, and at the doors to the lab. The gatehouse is automatic, controlled from the Security Office inside. The concrete bunker houses four BU-15B Goblins. A 12m tunnel runs from the bunker into the basement of the Main Lab allowing the Goblins to move between both buildings. Normally, three Goblins will engage in combat while the fourth hangs back in the basement tunnel, using its 3-D sensors to guide the others.

To the left of the gate is a big parking lot, lonely with only a dark grey van and a GENOM CONSTRUCTION dump truck in it. To the right of the gate, back about 20 meters, is a heavy concrete bunker with three 3-meter high metal doors set into it.

▼THE MAIN LAB

In the center of the enclosure is a two-story, U-shaped office building of black glass, two stories high. This the Main Lab. Between the wings of the U is a courtyard with glass doors that lead into a lobby, tastefully decorated with brooding man-high marble sculptures recalling Easter Island—or abstracted boomer heads.



The place smells of fresh paint. Everywhere, there are exposed panels and wiring on the corridor ceilings, rolls of carpeting and stacks of floor tiles. Constant bangs, hammering and drill sounds fill the building. Three build boomers move around, hard at work painting, putting in carpets, installing plumbing, etc. The GM can play this up, when the characters hearing heavy footsteps coming down a bend in a corridor, or see an elevator door about to open—is it a build boomer lugging a toilet bowl to a washroom, or a Goblin?

STEEL DOGS: Dr. Kuroki has four BU-K9s. One is her constant companion, while the others prowl the building.

BASEMENT: The basement is just bare concrete, a lobby with elevators running up, three store rooms holding spare electronic parts, a room with an auxiliary diesel generator, and a corridor that runs 12m to the boomer bunker.

FIRST AND SECOND FLOOR LAYOUT: Each floor has a lobby at the base of the U, curving main corridor, 6 offices, and a special lab at one end, while the other contains the washroom. The main doors lead into the lobby on the first floor; the first and second floor lobbies each include a double bank of elevators as well.

EMPTY OFFICES: Except for one office on each of the first and second floors, these are empty, the desks are cleaned out, and the office furniture is covered with paint-spattered tarps.

1ST FLOOR SECURITY OFFICE: A uniformed security guard is on duty (use Corporate Guard statistics, p. 101, *BGC: B&A*) with a heavy pistol. He's just there to watch the TV monitors, open the kennels, and send a "We're under attack; send help" message to Genom. He has no idea what is going on in the lab, and doesn't want to know. One monitor shows the scene in the second Floor Interface Lab.

1ST FLOOR AI LAB: A studio-sized room equipped with a Genom-built supercomputer (power 8) and three workstation desktop terminal. Shelves contain backup data recordings from the mind transfer project, indexed by the codename, "Broken Mirror."

2ND FLOOR KUROKI'S OFFICE: A lived-in office, with a bubbling coffee maker, hot plate, sofa bed, desk draws stuffed full with instant ramen packages, a huge stack of data disks (research notes), a workstation, and a sofa-bed. On the shelf are reference CDs on neuroscience and AI design. Wearing ear protectors against the construction noise, Dr. Kuroki works through the night, taking catnaps as necessary, as she tries to finish her "Test Report on Neural-Programming Mind Transfer Software Implementation" for Quincy. She is dogged by Kerberus, a silent German shepherd (actually her personal BU-K9 Bloodhound).

If Kuroki feels she is danger, she will try and make it to her van (perhaps using the basement passage), ordering one of the build boomers to help her carry her research notes, while her dogs run interference. If she discovers that Silhouette is behind the attack and "remembers" being Vision, she'll be ecstatic. "Full transference," she'll coo, "Wonderful!" Then she'll realize she's in very big trouble, and start running very fast....

2ND FLOOR INTERFACE LAB: This is a big, windowless room decorated with potted plants and blown-up, poster-sized photos of human brain cells. Dominating the room is a large couch, with a bank of monitors next to it. Strapped to the couch is a beautiful Eurasian woman dressed in a tight, one-piece, white bodysuit, head covered by a large black helmet that plugs into the workstation. This is Vision. The helmet is operating in a passive "monitoring" mode now; she is fully conscious. The monitor screens on the walls record her brain wave activity and life signs.

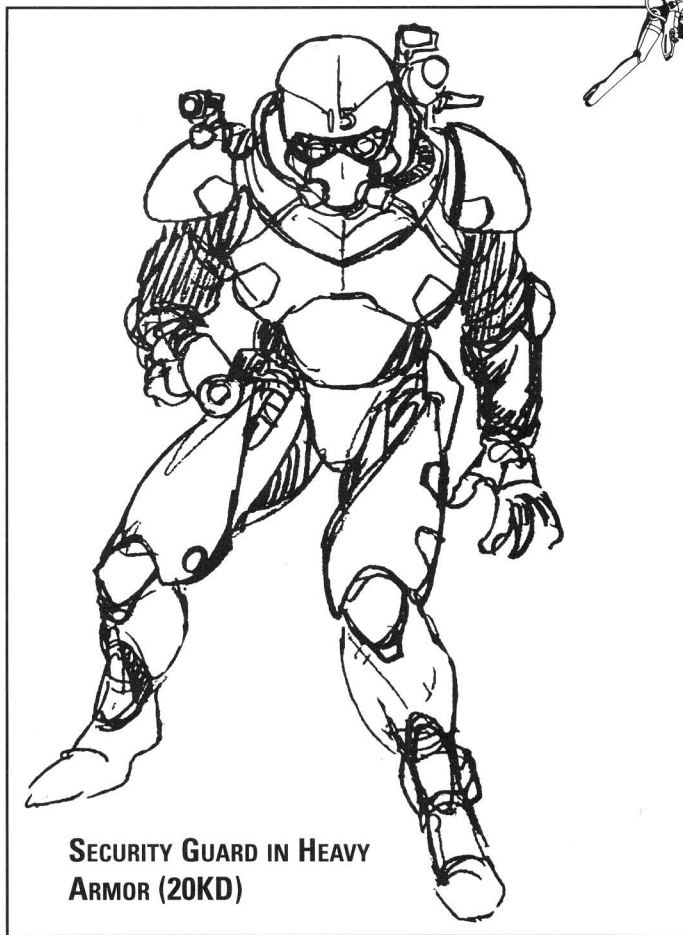

SECURITY GUARD IN HEAVY ARMOR (20KD)

Anyone studying the monitors and readouts of the work station gets an Advanced Tech roll vs. target number 12. Success means they realize this is akin to a military synchro-tech system, like that of a DD-style battle mover, where the user's brain can actually impress thought patterns onto a computer. Of course, this model has numerous custom modifications to boost power and sensitivity. If switched to active mode, it would copy memories. GMs who want to avoid unbalanced technology should feel free to make sure it catches a stray energy bolt during the battle.

Reika is aware of what was done to her; Dr. Kuroki explained it all very carefully. She knows about Silhouette too—Kuroki let her see Silhouette on television. Watching Sil's antics with D.J. Tommy wasn't the torment that Kuroki might have expected. Instead, it reminded Reika of her own naive teenage years, before the Hou Bang and Irene's death haunted and matured her

If rescued, she'll thank her saviors, remove the helmet, demand to know what is going on, ask for a gun, or, if she can't get it, use a potted plant to beat or blast the synchro-tech helmet. "I feel better" she'll say. "Been wearing that for a week."

▼BUG OUT

The players shouldn't spend too much time congratulating themselves, though They weren't as quick off the mark as the players, but Genom was also tracking Hellbenders. When the Hellbenders veered toward GRAIL, a restricted area, their response team was halted as permission was cleared with Quincy, and a squad of BU-12s was sent to regain control of GRAIL. This mighty force should squash anyone like a bug. So when they hear the roar of the tilt rotors and see four Genom heavy transports loaded for bear and headed their way, the PCs would be advised to bug out!



▼ NEVER THE END

Resolution

If they help rescue Vision, she, Silhouette and the Hou Bang will be grateful—and Vision will want to talk to Silhouette. That's a simple matter of getting to an open computer/modem connection. If so, Sil and Vision can have a little talk. Any dialogue is up to the GM. Perhaps:

Sil (nervous): *Hello, big sister....*

Vision: *Hello little sister. Hey....*

Sil: (small voice) *What?*

Vision: *Want to be my back up singer?*

Finally, if Sil spared Golikov's life, he still knows that she is out of control, and could have her erased. On the other hand, Vision will claim that Sil is her copyright. She'll offer to drop any charges against Golikov if he'll sell Silhouette's program to the Chang Group, in which case "Hou Bang Musichips" will have another star.

If the players lose, *they* could be part of the latest mind transfer experiments. Sil is in no danger until Golikov recovers and arranges to purge her mainframe. Could she hide her program elsewhere, and perhaps help captured PCs?

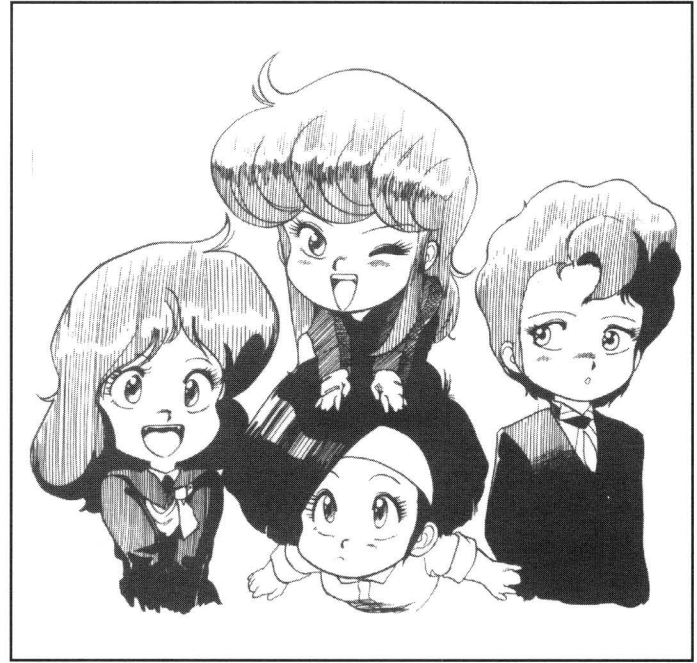

GRAIL LAB

LEVEL ONE

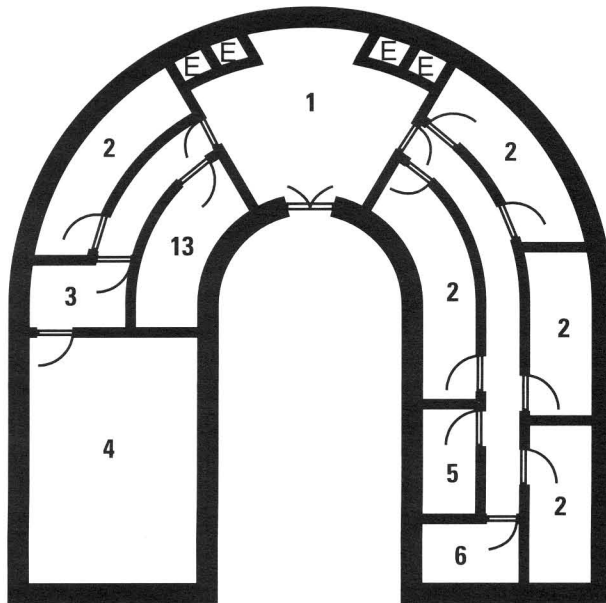

MAP KEY

- 1. Lobby
- 2. Empty Offices/Cubicles
- 3. Clean Room
- 4. AI Lab
- 5. Women's Restroom
- 6. Men's Restroom
- 7. 2nd Floor Lobby
- 8. Dr. Kuroki's Office
- 9. Interface Lab
- 10. Electronic Parts Storeroom
- 11. Generator
- 12. Tunnel to Boomer Bunker
- 13. Security
- E = Elevator

LEVEL TWO

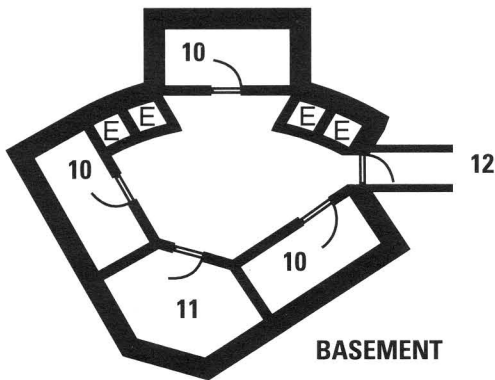
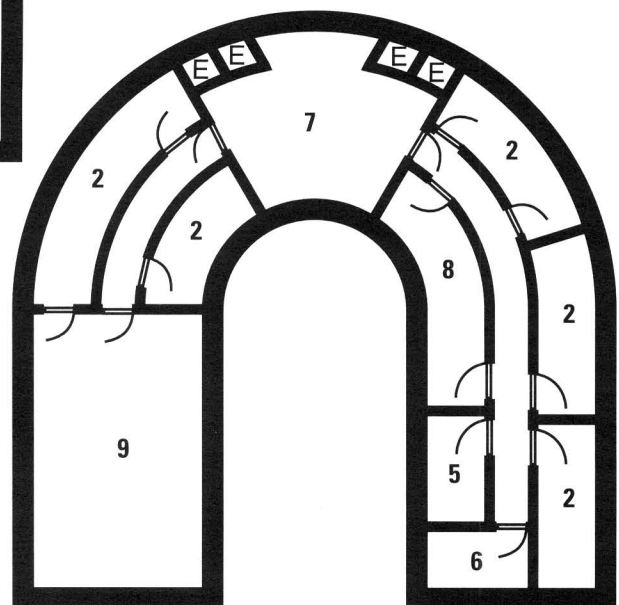

BASEMENT



NEW CHARACTERS

Descriptions and statistics of the characters appearing in the *Virtual Vision* adventure are given here.

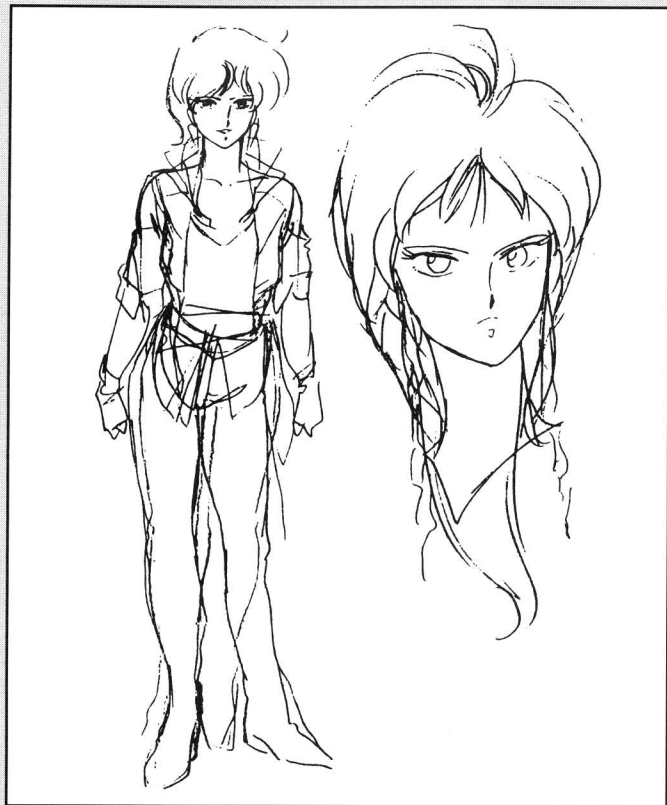

▼ SILHOUETTE

A virtual personality running on a POW 9 mainframe, physically located on the 8th floor of the Genom Entertainment building. She has AI level 9, Performance +10, Hacking +9 and all Vision's skills (*BGC*, p. 130), but at only half their value (round up). She can hack into computers and, if their terminals are rigged for audio-video, see and hear out of them, provided she has the computer's address.

▼ SHINOBI

Novice rock singer, cute, naive and determined. Wears a bomber jacket, *Vision Live!* T-shirt, leopard-skin tights and brown spike heeled boots.

IMPORTANT STATS

INT 3, PRE 4, TECH 2, MOVE 3, WIL 4, REF 3, DEX 3, STR 1, CON 2, BOD 2. Perception +3, Persuasion +3, Education +4, Athletics +4, Performance +5, Wardrobe & Style +4.

▼ VLADIMIR GOLIKOV

A big man in his late 40s, with bristly orange hair. Wears a white silk shirt, flared trousers, cossack boots. His English is terrible, with a strong Russian accent.

IMPORTANT STATS

INT 4, PRE 5, WIL 4, TECH 3, MOVE 2, REF 2, DEX 2, STR 4, CON 2, BOD 4. Perception +4, Persuasion +6, Education +5, Athletics +2, Business +6, Computers +4, Wardrobe & Style +3, Social +5. Equipment: Laptop computer (Power 4), limousine.

▼ DR. LINDA KUROKI

35 year old Asian. She is ruthless, predatory, and loves metal dogs. Use the statistics for Dr. Yuri (*BGC: B&A*, p. 64) but with Computers +10 instead of MilSpec Tech +10. Trained by her pet BU-K9.

▼ TERRY ZHANG

32 year-old Asian male. A local Hou Bang boss, he is soft spoken and slight of build, with a coldly beautiful face and long straight hair—and a core of steel. His two ruling passions are the Tiger Corps and collecting very exotic fish. That a disaster like Vision's abduction should happen under his watch disturbs him. How will he explain things to Dr. Chang?

Use stats for Kou (*BGC* p. 134), but add Business +5 and Expert +7 (Exotic Fish). He's known to wonder—out loud—how long people who annoy him could swim in a tank of his gengineered piranhas. His men usually think he's joking—but they aren't entirely sure. He has a strong affection for Ms. Choy.

EQUIPMENT: Zhang normally wears a traditional Chinese robe, but carries a knife and a pair of magnum revolvers. He believes in fighting along with his people, and will pilot the GD-42 suit into combat if necessary.

▼ KELI CHOY

An 18-year old Chinese-American girl. She's hot-blooded and wants to prove herself as a Hou Bang member, and often acts impulsively. Hobby: martial arts.

IMPORTANT STATS

INT 4, PRE 4, WIL 3, TECH 3, MOVE 5, REF 4, DEX 4, STR 2, CON 3, BOD 2. Perception +4, Persuasion +4, Education +3, Handgun +4, Athletics +4, Basic Tech +5, Driving +3, Perception +4, Stealth +3, Espionage +5, Hand-to-Hand +5 and Martial Arts, Social (Street) +5. Equipment: Nurse's uniform over black t-shirt and shorts, knife, flash grenade in pocket. When not breaking heads for the Hou Bang, she works as an auto mechanic on a race track; she loves engines.



EXTRA! EXCITING! EXPLOSIVE! EXTREME!

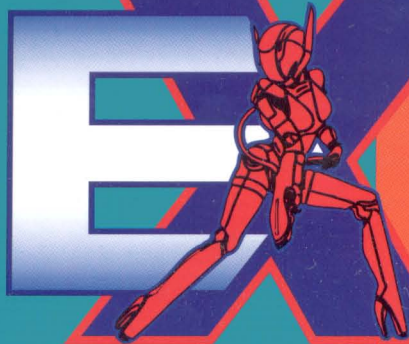

WELCOME TO
BUBBLEGUM
CRISIS EX,

THE NEW EXPANSION
FOR THE BUBBLEGUM
CRISIS ROLEPLAYING
GAME. HERE, YOU'LL
FIND THE COOLEST
STUFF THAT WAS
NEVER SEEN IN THE

ANIME SERIES. THAT'S RIGHT, *BGC EX* GIVES YOU NEVER-BEFORE-SEEN PROTOTYPES, VARIATIONS, AND ADVANCED VERSIONS OF *BGC*'S MANY MECHA!

BGC EX CONTAINS: • 3 NEW BATTLEMOVERS • 5 NEW MOTORCYCLES • 7 NEW POWERED SUITS • 7 NEW MOTORSLAVES • 8 NEW PERSONAL ITEMS • 10 NEW HARDSUITS AND HARDSUIT MODIFICATIONS • 11 NEW VEHICLES • AND 24 NEW BOOMERS! YOU'LL GET INFORMATION TRANSLATED FROM JAPANESE SOURCES, COMPLETE FUZION™ GAME STATS, AND ORIGINAL JAPANESE ARTWORK. IN ADDITION, *BGC EX* PROVIDES A STAND-ALONE HARDSUIT CONSTRUCTION SYSTEM, TONS OF SCENARIO IDEAS, A COMPLETE ADVENTURE, AND MORE!

WHETHER YOU'RE A ROLEPLAYING GAMER, AN ANIME VIEWER, OR A DIEHARD *BGC* FANATIC, *BUBBLEGUM CRISIS EX* IS YOUR TICKET TO A TRIP BEYOND THE VIDEOS. EXCELLENT!!

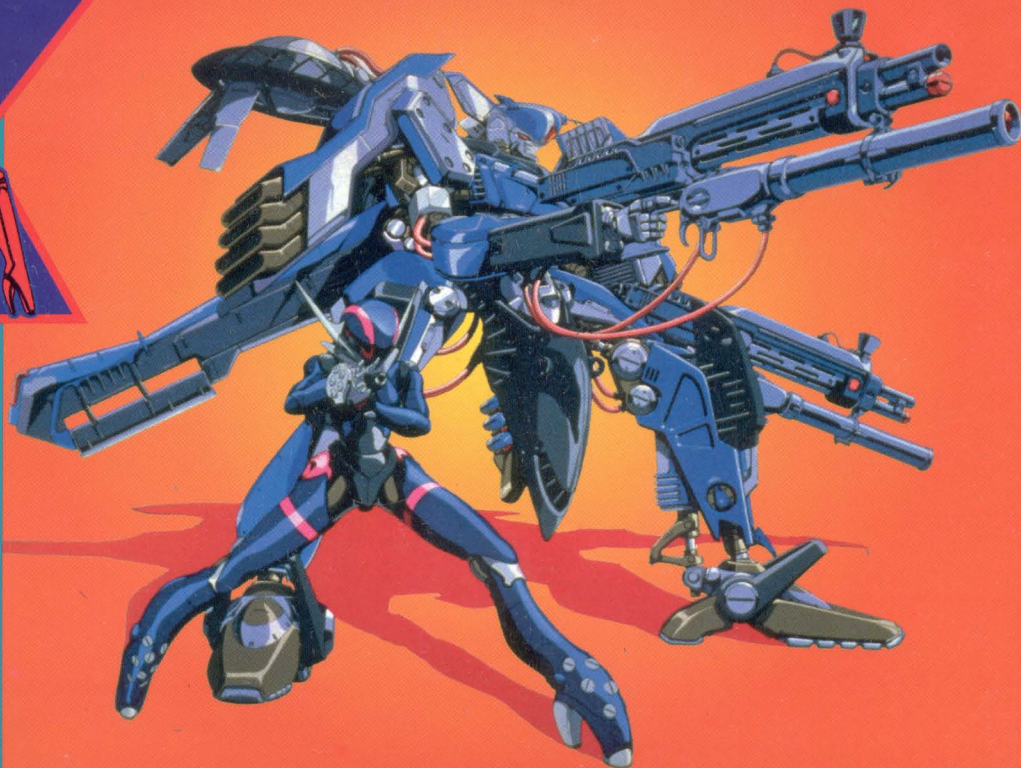

AM 08021 ISBN# 0-937279-97-8

ANIMECHANIX BUBBLEGUM CRISIS EX



ANIMECHANIX is a division of R. Talsorian Games, Inc. Bubblegum Crisis EX Copyright © R. Talsorian Games, Inc., 1998, All Rights Reserved under International Copyright Conventions. Fuzion™ is the FUZION Labs Group's Trademark for its multi-genre game system. "Bubblegum Crisis"; Copyright Artmic, Inc., and Youmex, Inc. 1987-1990; "Bubblegum Crash!"; Copyright Artmic, Inc., 1991 and/or "AD Police"; Copyright Artmic, Inc. and Youmex, Inc. 1990. All Rights Reserved, English subtitled/dubbed versions Copyright, AnimEigo, Inc., 1991-1995, All Rights Reserved. All situations, incidents and persons portrayed within are fictional and any similarity without satiric intent to individuals living or dead is strictly coincidental.

