

BUBBLEGUM CRISIS

BEFORE
AFTER

AD POLICE & BUBBLEGUM CRASH! - THE ROLEPLAYING SOURCEBOOK



FURTHER ADVENTURES IN THE ANIME WORLD OF BERSERK BOOMERS AND HI-TECH HEROES!

BUBBLEGUM CRISIS

BEFORE
AFTER

AD POLICE & BUBBLEGUM CRASH! – THE ROLEPLAYING SOURCEBOOK





BUBBLEGUM CRISIS

AD POLICE & BUBBLEGUM CRASH! – THE ROLEPLAYING SOURCEBOOK

BEFORE AND AFTER CONTENTS

INTRODUCTION	3	WELCOME TO 2034	46	ADP MECHA 2034	90
AD POLICE	4	WALL-TO-WALL BOOMERS	48	OTHER MECHA 2034	92
AD POLICE FILES SUMMARIES	5	VIRTUAL PERSONALITIES	48	GAME MATERIAL	98
WELCOME TO 2027	8	GENOM IN 2034	49	REFEREE NOTES	99
CYBERNETICS & BOOMER SYNDROME ..	10	MEGATOKYO 2034	50	CYBERNETICS RULES	102
GENOM IN 2027	13	GEO CITY	51	HI-TECH VIGILANTES	106
MEGATOKYO 2027	14	THE CYBERPUNK UNDERGROUND ..	53	CREATING A HEADQUARTERS ...	109
AD POLICE PROCEDURES	16	AD POLICE 2034	54	NEW CHARACTER TEMPLATES	110
ADP CAMPAIGNS	22	KNIGHT SABERS 2034	55	<i>BGC</i> ADVENTURE "MEGACRISIS"	112
ADP CHARACTERS	26	MERCENARIES IN <i>BGC</i>	56	2027: 30 PIECES OF SILVER ...	112
ADP MECHA	32	<i>BG CRASH!</i> CAMPAIGNS	58	2033: VIRTUAL VENGEANCE ...	116
BOOMERS 2027	36	CHARACTERS 2034	62	2034: SINS OF THE FATHER ...	118
ANDROIDS & SEXAROIDS	37	KNIGHT SABER TECH 2034	66	MECHA CONSTRUCTION IN <i>MZ+</i> ...	121
BUBBLEGUM CRASH!	42	KNIGHT SABER MECHA 2034 ...	68	FUZION™ CONVERSIONS	125
<i>BGC!</i> EPISODE SUMMARIES	43	BOOMERS 2034	75	<i>BGC</i> ERRATA	127

BEFORE AND AFTER CREDITS

WRITER: David Pulver

TECHNICAL MATERIAL AND FUZION™

ADAPTATION: Benjamin Wright

FUZION™ ROLEPLAYING RULES: David

Ackerman-Gray, Ray Greer, George MacDonald, Steve Peterson, Mike Pondsmith, Benjamin Wright

OTHER WRITING CONTRIBUTIONS: Mike

Pondsmith, David Ackerman-Gray

TRANSLATOR: Ryosuke Taketomi

EDITOR: Janice Sellers

LAYOUT DESIGN: Benjamin Wright

GRAPHICS: Benjamin Wright, David Ackerman-Gray, Alex Okita

ANIMEIGO SUPPORT: Janice Hindle, Suzanne Stanley, Robert Woodhead

BELETED THANKS: Ryosuke Taketomi (sorry we forgot to credit you for your invaluable translation work on the *Bubblegum Crisis RPG*), Thomas Chan (sorry we forgot to credit you for your contributions to the *BGC DYN* lists).

ONLINE RESEARCH THANKS: Robert Farquahar (imagines@nlc.net.au), keeper of the Sydney 2033 page (www.nlc.net.au/~imagines/bgcsydney) • Brian Edmonds, keeper of the *BGC* website (<http://www.cs.ubc.ca/spider/edmonds/anime/bgc.html>) • Michael Ko, keeper of the MegaTokyo Interactive Map website (<http://hops.cs.jhu.edu/~vincie/megatokyo.html>) • Jeanne Hedge, keeper of the *BGC* Synopses website (<http://www.accsyst.com/jhedge/bgcindx.htm>) • Eric Tiberius Cheng, keeper of the *AD Police Files* website (<http://www.cyberus.ca/~etc/adp.html>) • Andy Skuse, keeper of the Raven's Garage website (<http://exculink.com/~askuse/ravengar.html>) • Julian James Kuleck, keeper of the *GURPS-BGC* website (<http://phoenix.kent.edu/~jkuleck/>

<http://www.yi.com/hom/McdermottAndy/bgc.html>) • Ping Lin, Enrique Conty, Mike Gaines, Chandra Reyer, Nick Celani, Thomas Chan, and "Celia Stingray", compilers of the *BGC DYN* lists • Steve Pearl, editor of the *BGC* FAQ and moderator of rec.art.anime.misc • C. J. Scott (a.k.a. "The Pig"), who figured out the connection between Mason and Largo • Ben Cantrick (alias Macky Stingray)

ADDITIONAL THANKS: Peter Nordgren, Evan Hughes, Salomon Farin, Dan Quackenbush, Steve Gill, Nick Celani Frank, Douglas M. Akin, Andreas van Ruth, Todd Showalter, Patrick Hall, Ami Mizuno, Ken Arromdee, C. Rosetti, Stephen Douglas, Shawn Kester, Chris Holmes, Ross M. Simmerman, Phil Yff, The Nomad.

ANIMECHANIX

AM 08011 • ISBN# 0-937279-92-7

ANimechanix is a division of R. Talsorian Games, Inc. Bubblegum Crisis: Before & After Copyright © R. Talsorian Games, Inc., 1997. All Rights Reserved under International Copyright Conventions. Fuzion™ is the FUZION Labs Group's Trademark for its multi-genre game system. "Bubblegum Crisis"; Copyright Artmic, Inc., and Youmex, Inc. 1987-1990; "Bubblegum Crash!"; Copyright Artmic, Inc., 1991 and/or "AD Police"; Copyright Artmic, Inc. and Youmex, Inc. 1990. All Rights Reserved, English subtitled/dubbed versions Copyright, AnimEigo, Inc., 1991-1995, All

Rights Reserved. All situations, incidents and persons portrayed within are fictional and any similarity without satiric intent to individuals living or dead is strictly coincidental.

INTRODUCTION

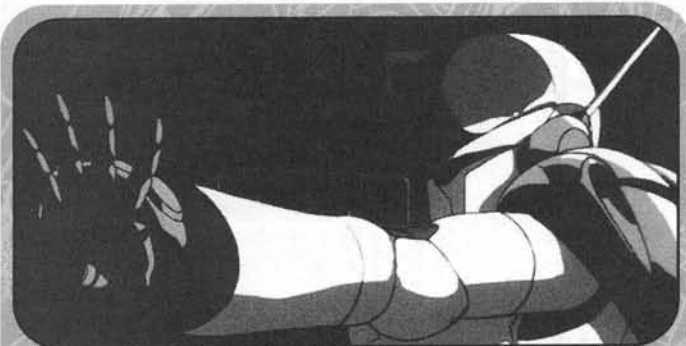

"SHOWTIME, IN A TOWN FULL OF MISUNDERSTANDINGS,
TONIGHT, THE HEART WALKS A TIGHTROPE,
STRAINING MY EYES IN THE PITCH DARKNESS...
...UNABLE TO SEE ANYTHING, I SEEK TOMORROW.
THE BUSTLING TOWN IS DANCING...
...WITH A SEEMINGLY SECRET HEART, TONIGHT,
WITH STARDUST REFLECTED IN YOUR EYES...
...YOU EMBRACE FREEDOM...
...AND FIRMLY CATCH YOUR OWN DREAM, NOW!"

—COOL EYES

▼ ABOUT THIS BOOK

The *Bubblegum Crisis Roleplaying Game* is based on the Japanese anime video series *Bubblegum Crisis* (or "BGC" as it's sometimes called). We here at R. Talsorian and AnimEigo have been very gratified with its huge success—but we also knew there was more to do. There were two entire chapters of the BGC story we had yet to bring to gaming life: *Bubblegum Crash!* and *AD Police*. This book provides in-depth coverage on these shows, along with new data, game rules and adventures. Throughout this book, it's assumed that you have a copy of the *BGC:RPG*, but even if you don't, you'll find a huge wealth of data and art on one of the best anime series ever done.

Bubblegum Crisis was produced by Artmic design studio and was released as an 8-part video-only series in Japan from 1987-1990. *Bubblegum Crisis: Before and After* is based on *Bubblegum Crisis'* two spin-off series: The 3-part prequel series *AD Police* (released in Japan in 1990), and the 3-part sequel series *Bubblegum Crash!* (released in Japan in 1991).

AnimEigo, one of the premiere American anime importers and distributors, has released subtitled and dubbed versions of *Bubblegum Crisis*, *Bubblegum Crash!* and *AD Police* for the U.S. market. If you haven't seen these videos yet, check them out! Bug your local video store or contact AnimEigo at: P.O. Box 989, Wilmington, NC 28402-0989, Email 72447.37@compuserve.com, Web <http://www.animeigo.com/>.

As some fans may know, *BGC* was originally supposed to be 13 episodes long. However, only eight were made due to legal complications. The last five episodes were eventually boiled down into the 3-part sequel series *Bubblegum Crash!*, but many fans feel that the storyline was never fully resolved. But *BGC's* legal problems are now over, and we're happy to report that there will be a new *BGC* TV series on the air in Japan in late 1997. Word has it that the new series will run about 26 episodes and there may also be a movie or new OVA series. Although details are still sketchy, we do know that fans can look forward to... a fifth Knight Saber! R. Talsorian Games will keep you posted as details become available.

▼ FUZION™ EVOLUTION

The *Bubblegum Crisis Roleplaying Game* was the first game to use the new Fuzion™ game system, but it's far from the last. The list of Fuzion™ games already includes: Hero Games' classic superhero roleplaying game, *Champions: New Millennium*; Gold Rush Games' *Segoku* and *Usagi Yojimbo*; the superb anime *Armored Trooper VOTOMS RPG* (from R. Talsorian and Central Park Media); and later in the year gamers can look forward to Fuzion™-powered versions of *Cyberpunk* and *Mekton Zeta*.

Thus, Fuzion™ is a work in progress. In order to bring the *BGC RPG* up to date, *BGC Before & After* features a few small differences from the base rulebook. From now on, all BGC books will use these changes:

New Terminology: PERSONality has been changed to PREsence because "presence" is a more accurate description of the Stat's use; a character's PD (Physical Defense) has been changed to SD (Stun Defense) because that's what it really is; and all armor's PD (Physical Defense) has been changed to KD (Killing Defense) to distinguish it from SD; additionally, the term "Campaign Points" has been changed to Option Points.

Scaling Kills: In order to avoid "conFuzion™", the many mecha of the BGC RPG have been sorted into various scales. Human scale mecha (such as Hardsuits, Powered Suits, and Boomers) and Small Vehicle scale designs (such as cars, motorcycles, Motorslaves, Battlemovers, trucks, and helicopters) will always be listed with KD, SDP and their weapons will do damage in D6's—Kills will no longer be used for them. Therefore, all damages dished out by mecha of this scale should be multiplied by 14D6 (rounded nearest) in order to find their scale-correct damages. For example, the Mouth Laser of the BU-55C (*BGC* p.99) does 22D6, since $1.6 \times 14 = 22.4$.

Another way of looking at Kill conversions is to check how many *non-fractional* Kills the attack does—each full Kill is 14D6. Add these 14D6 increments up, then refer to the right to convert any remaining *fractional* Kills to dice:

0.0K:	+0D6	0.5K:	+7D6
0.1K:	+1D6	0.6K:	+8D6
0.2K:	+3D6	0.7K:	+10D6
0.3K:	+4D6	0.8K:	+11D6
0.4K:	+6D6	0.9K:	+13D6

Large mecha (such as aircraft, tanks, and giant robots) will use Kills, and no fractions will be used—In the *Bubblegum Crisis RPG* book, *only* the Orca Shuttle, Sky Carrier, and the VA-61 Satellite will use Kills. Read below to see how damage works in these different scales:

All SDP- and Hit-rated targets attacked by D6-rated weapons: Damage is applied normally, by determining the total amount of damage rolled, subtracting armor, then applying any remaining damage to the SDP.

Human-scale targets attacked by Kill-rated weapons: For *any target weighing 1000kg or less (which has Hits or SDP)*, damage is applied by adding 13 to the number of Kills of damage; the result is the number of dice of damage that is done to the target. Determine the total amount of damage rolled, subtract armor, then apply any remaining damage to the SDP.

Small Vehicle-scale (SDP-rated) targets attacked by Kill-rated weapons: Damage is applied by multiplying the Kills of the weapon by 50, subtracting armor, then applying any remaining damage to the SDP.

Large Mecha-scale (Kill-rated) targets attacked by D6-rated weapons: Damage is applied by dividing the DC of the attack by 14, dropping fractions. The result is the Kills of damage done (e.g., a 33D6 attack becomes a 2-Kill attack). Subtract the Kills of armor from the attack, then apply any remaining damage to the target's Kills.

Kill-rated targets attacked by Kill-rated weapons: Damage is applied normally, by subtracting the number of Kills of armor from the Kills of damage, then subtracting any remaining damage from the target's Kills.

THE AD POLICE FILES

THE D POLICE FILES

4



EPISODE GUIDE: AD POLICE FILE-1

THE PHANTOM WOMAN

FLASHBACK: A BEAUTIFUL BOOMER ATTACKS NORMAL POLICE ROOKIE LEON MCNICHOL. TAUNTINGLY, SHE CLOSES IN, EARRINGS TINKLING. AT THE LAST MOMENT, LEON GATHERS HIS NERVE, SHOOTING AGAIN AND AGAIN.



MEGATOKYO, 2027: A WAITRESS BOOMER RAMPAGES THROUGH A TEA SHOP. AN AD POLICE ASSAULT TEAM ARRIVES—AMONG THEM ARE VETERANS JEENA MALSO AND ALUS, AND NEWLY TRANSFERRED ROOKIE LEON. DURING THE BATTLE, THE BERSERK BOOMER TAKES ALUS' LIFE, AND THE ENRAGED ADP OFFICERS SHOOT THE MANNEQUIN TO PIECES.

AFTERWARD, LEON TURNS DOWN AN ABRUPT PASS MADE BY JEENA. LATER, AT A BAR, THE TEAM LEARNS THAT ALUS HAD A HUGE LIFE INSURANCE POLICY AND (COINCIDENTALLY?) FREQUENTED THAT SAME TEA SHOP. THE INSURANCE AGENT WON'T PAY UP, IMPLYING THAT ALUS MAY HAVE SABOTAGED THE BOOMER HIMSELF. JEENA AND LEON GET SIX HOURS TO CLEAR ALUS. FROM THE SHADOWS, A WOMAN WATCHES LEON, EARRINGS TINKLING.

IN THE PATROL CAR, JEENA ASKS LEON WHY HE TURNED HER DOWN, AND HE TELLS HER ABOUT THE CRAZED FEMALE BOOMER WHO ONCE ATTACKED HIM—IT HAD GONE MAD DUE TO DISORDERS MANIFESTED DURING SEX, BECAUSE IT HAD BEEN ILLEGALLY RECYCLED. JEENA FIGURES THAT'S A POSSIBLE LEAD, AND THE PARTNERS CHECK OUT SEVERAL RECYCLING

PLANTS, WITH NO LEADS—UNTIL SOMEONE HACKS INTO THE POLICE NET, HIGHLIGHTING TWO LOCATIONS. THEY SPLIT UP, AND JEENA'S PLANT TURNS OUT TO USE ILLEGAL PARTS TO UPGRADE D-CLASS BOOMERS INTO SEX MODELS. EXAMINING THEIR FILES, SHE FINDS THE BOOMER THAT KILLED ALUS, AND RECOGNIZES ANOTHER'S PICTURE: THE WOMAN WATCHING LEON AT THE BARI!



WHILE LEON IS STALKED BY THE PHANTOM WOMAN, JEENA FORCES THE TRUTH FROM THE PLANT OWNER: THE PHANTOM WOMAN HAD BEEN DESTROYED BY THE POLICE, BUT HER BRAIN WAS ILLEGALLY RECYCLED INTO AN A-GRADE SEXAROID. HER MEMORY WAS ERASED, BUT ONE IMAGE REMAINED: LEON, PUMPING BULLETS INTO HER BODY.

PROPELLED BY A MURDEROUS LUST, THE PHANTOM WOMAN ATTACKS LEON. UNSTOPPABLE, SHE PINS HIM TO THE

GROUND—AND JEENA ARRIVES, SHOOTING HER DEAD. AFTERWARD, ALUS' INSURANCE POLICY IS PAID OFF, BUT LEON REMAINS MELANCHOLY...



EPISODE GUIDE: AD POLICE FILE-2

THE RIPPER

IN THE CRIME-RIDDEN SUBWAY CALLED PARADISE LOOP, A YOUNG PROSTITUTE IS GUTTED BY A MASKED, KNIFE-WIELDING WOMAN. THIS IS THE SIXTH SUCH MURDER IN THE LAST FEW WEEKS, AND A THEORY THAT THE MURDERER IS A BOOMER BRINGS IN THE ADP. N-POLICE DETECTIVE IRIS CARA DISMISSES THIS THEORY, SUGGESTING HUMAN EMOTIONS AS THE MOTIVE. IRIS AND HER PARTNER VANESSA BACH ARE ASSIGNED TO WORK JOINTLY WITH LEON AND JEENA. LATER, VANESSA ADVISES IRIS TO GET HER EYE REPLACED AT THE CYBERNETICS BANK OF TOKYO.



ON THE BODY OF A FRESHLY KILLED BOOMER, LEON FINDS A CARD FOR THE CYBERNETICS BANK. THERE HE FINDS IRIS, AND LECTURES HER STERNLY AGAINST CYBERNETICS. IRIS SEES A DOCTOR ANYWAY, WHO ADVISES CYBERNETIC REPLACEMENT. ON THE WAY OUT, IRIS OVERHEARS A BUSINESSWOMAN ARGUING ABOUT REVERSING AN ORGAN-REPLACEMENT OPERATION. CATCHING UP WITH LEON AND JEENA, IRIS SUGGESTS THEY FOLLOW THE WOMAN. THEY LOOSE HER IN A SLUM ABOVE PARADISE LOOP, AND ANOTHER DEAD PROSTITUTE IS FOUND THERE THE NEXT DAY.

IRIS AND VANESSA IDENTIFY THE BUSINESSWOMAN AS CAROLINE EVERS, WHO HAD HER UTERUS AND OVARIES REMOVED AND THE LOWER HALF OF HER BODY MODIFIED. WITHIN TWO YEARS, SHE WAS PRESIDENT OF GREEN CORPORATION. IRIS STAKES OUT THE GREEN BUILDING... AND THE ADP ARE ALSO WATCHING.

LATER, IRIS FOLLOWS CAROLINE INTO PARADISE LOOP, BUT IS AMBUSHED BY HER. CAROLINE HAD SACRIFICED HER WOMANHOOD TO GET AHEAD IN A MAN'S WORLD, BUT WAS BETRAYED BY HER LOVER, WHO CHEATED ON HER WITH A PARADISE LOOP PROSTITUTE. EVER SINCE, SHE'S BEEN DRIVEN TO MURDER—AND TO MORE CYBERNETICS. IS SHE HUMAN OR BOOMER? IRIS DECLARES THAT ONLY HUMANS KILL OUT OF HATRED.

SUDDENLY THE AD POLICE ARRIVE, HOSING THE SUBWAY WITH BULLETS, REGARDLESS OF CIVILIANS—WITH 70% OF HER BODY ARTIFICIAL, EVERS' IS NOW A "DOOMEROID", NO LONGER LEGALLY HUMAN. IRIS INSISTS OTHERWISE, BUT IT'S TOO LATE—AN ADP MECHA BARRICADES THE SUBWAY LINE. THE TRAIN JUMPS THE TRACKS, KILLING CAROLINE AND THE OTHER JUNKIES AND STREET PEOPLE ABOARD.

IRIS DECIDES TO HAVE HER EYE REPLACED AFTER ALL, DELIBERATELY THROWING AWAY A PART OF BEING HUMAN.

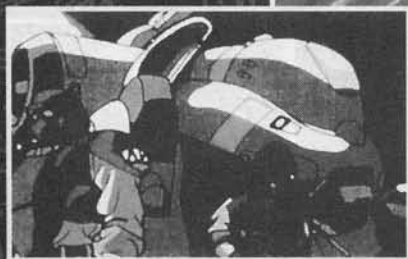

EPISODE GUIDE: AD POLICE FILE-2

THE MAN WHO BITES HIS TONGUE

BILLY FANWARD, INJURED IN THE LINE OF DUTY, HAS BEEN REBUILT AS EXPERIMENTAL ANTI-BOOMER BATTLE-CYBORG UNIT NO. 1. WHEN THE AD POLICE FACE A POWERFUL COMBAT BOOMER, BILLY SAVAGES IT. LATER, AT A BAR, JEENA CONFIDES TO LEON THAT SHE AND BILLY USED TO LIVE TOGETHER, BUT NOW HE'S BECOME COLDLY MECHANICAL. JEENA CONSIDERS HER OWN CYBERARM, AND WORRIES THAT SHE MIGHT END UP THE SAME.

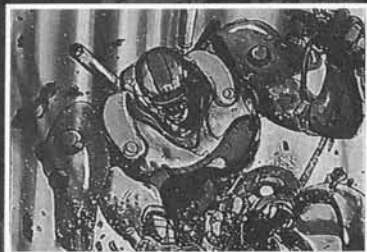

BILLY IS THE PET PROJECT OF DOCTOR TAKAGI YOOKO, WHO'S CONCERNED ABOUT BILLY'S SENSORY DEPRIVATION—THE ONLY PART OF HIM STILL FLESH IS HIS TONGUE, WHICH HE BITES TO STAY SANE. DR. TAKAGI CONCLUDES BILLY NEEDS MORE STIMULATION, SO SHE TEASES HIM WITH HER BODY AND ADMINISTERS EXTRA DOSES OF THE POWERFUL CENTRAL-NERVOUS STIMULANT DA-27.

SEX AND DRUGS JUST MAKE BILLY MORE AGGRESSIVE. JEENA NOTICES THE CHANGES IN HIM AND ANGRILY CONFRONTS DR. TAKAGI. SHE BRUSHES JEENA OFF, BUT BILLY IS NOW ADDICTED, AND HE DEMANDS EVER-HIGHER DOSES SHOT INTO HIS TONGUE. TAKAGI REFUSES, AFRAID HE'LL FRY HIS BRAINS BEFORE SHE HAS TIME TO UNVEIL HER EXPERIMENT. HOWEVER, BILLY FINDS HIS OWN SECRET SOURCE: THE CASSETTE BOOKS HE ORDERS FROM THE "BRAIN BOOKS CENTER" CONTAIN SMUGGLED DOSES OF DA-27.

TAKAGI REALIZES BILLY IS DETERIORATING, BUT SHE JUST HOPES HE'LL LAST LONG ENOUGH FOR HER TO WIN FAME AND GLORY AT THE NEXT BIG SCIENCE CONFERENCE. THEN? HE CAN DIE IN THE LINE OF DUTY. UNFORTUNATELY, BILLY HAS BEEN MONITORING THE DOCTOR. BETRAYED, ALL HE WANTS IS THE NEXT DOSE OF DA-27, BUT THE CONCERNED JEENA INTERCEPTS HIS DRUGS. DEPRIVED OF HIS FIX, BILLY STARTS HALLUCINATING, FLASHING BACK TO HIS PAST—HIS FAILED BOXING CAREER, HIS INJURY, HIS REBIRTH AS A MONSTER. WHEN DR. TAKAGI VISITS HIM, IT'S TOO MUCH—HE SNAPS!

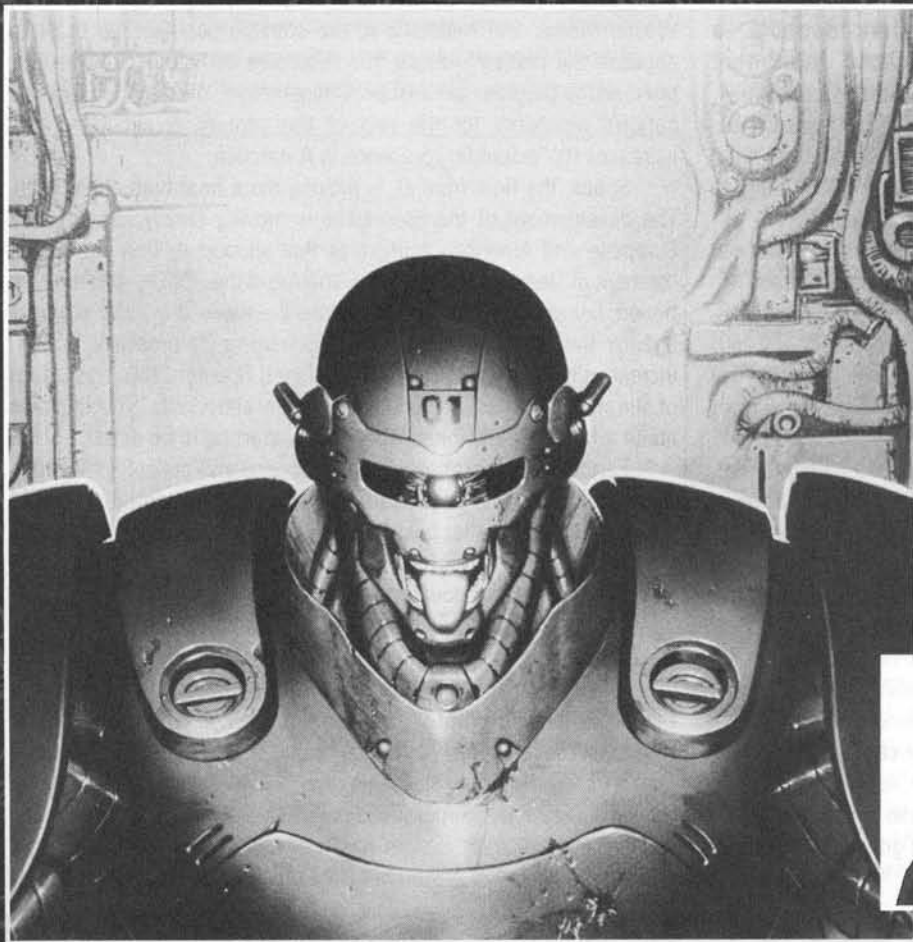

JEENA RACES TO FIND BILLY—TOO LATE. DR. TAKAGI IS DEAD, AND BILLY IS ON A RAMPAGE. THE AD POLICE FIGHT HIM, BUT HE'S TOO MUCH FOR THEM. JEENA FINDS A WOUNDED DIEORK, WHO URGES HER TO KILL HER EX-LOVER. JEENA TAKES UP A HEAVY RIFLE AND VOWS TO DO IT.

AS BILLY PREPARES TO FINISH OFF AN INJURED LEON, JEENA CONFRONTS HIM—AND BILLY RECOGNIZES HER. FOR A MOMENT, HIS HUMANITY RETURNS, AND HE BEGS JEENA TO KILL HIM. TO END WHAT IS LEFT OF HIS HUMANITY, TO SHOOT HIS TONGUE. SHE OPENS FIRE.



AFTERWARD, JEENA WONDERS IF SHE, TOO, WILL SHARE BILLY'S FATE.

WELCOME TO 2027



2027 is a dark year in a dark decade—a decade of promises whose fulfillment always seems just around the corner.

Governments and corporations (what's the difference?) are promising to complete clean, vibrant, technologically integrated cities, with housing and jobs for everyone—just leave everything to the private sector, and the market will take care of it all.

The new Advanced Police are promising an end to riots and boomer crimes—just give them the heavy equipment they need.

Cybernetics and artificial organs promise an end to human frailties—just give up your flesh, and you can live forever.

Space development promises a new frontier, the movement of polluting industries into orbit, and a global shield against nuclear weapons—just trust the SDPC!

People have bought into this, but they're just beginning to realize the cost. Things are going too fast and not fast enough. Damaged slums are being demolished, replaced by technologically integrated cities. Small businesses are being devoured by mammoth corporations. The stars are occluded by orbiting weapons. Foreigners are replacing natives. Machines are replacing humans.

The ordinary citizen wants to turn off that fast-forward on his life, but the button's stuck, and if anyone pushed "stop" civilization would crumble. So people in the 2020's go seeking other solaces: a way out, a way to control things, a niche they can call their own. More and more turn to the gods of the megacity, such as Genom, the media gestalt, and the replacement of fragile flesh with the hard certainty of metal and circuitry. Others reject these gods, joining gangs, cults, or terrorist groups.

▼ DIFFERENCES IN THE 2020'S

In the 2020's, life is cheap. This is especially true in MegaTokyo—with a *million* people dead in the Second Great Kanto Earthquake only a few years ago, what's an extra body or two?

▼ THE WORLD SITUATION

As Japan goes through its growing pains, the rest of the globe is also in flux. The UN is already flexing its muscles in the international arena: Indonesia, the Middle East and South America have all seen the deployment of UN Peacekeeping forces to prevent the development of nuclear arsenals in the hands of despots. The first of the USSD sats are up and even now being aimed at a recalcitrant dictator in the Balkans

The United States has just started the Technologically-Integrated Economic Cities project to repair its blighted urban landscapes. Its international reputation is at its lowest ebb as it strives for internal stability in order to rebuild, but Japan continues to eclipse it economically—Japanese-American relations are currently tense. Similarly, the European Community is retrenching and making sure its own house is in order after internal dissension due to food shortages and the continued influx of Third World immigrants. EC trade with Russia is strong as the former soviet state works to feed its population and catch up technologically. China has just managed to crush an attempted revolution by a coalition of reformers who promoted Western ideas and freedoms to the starving populace. In order to appease the hungry masses, the resurgent communist regime has promised a program of "resource acquisition" that will ensure the nation's prosperity for the rest of the century. It simultaneously increases its "scientific" presence in Antarctica.

Space, the final frontier, is proving more final than anticipated. The development of the Moonbase is moving slowly, draining the European and American economies that support it. Only the establishment of Genaros 1 in 2026 by Genom and the SDPC—and the continued launches of the USSD gunsats—mark any real progress against the Big Black. But Genom is making its presence in orbit increasingly obvious as specially-designed Boomers take over much of the more dangerous work from human astronauts. The question about who will really inherit the stars is starting to be asked.

Earthside, corporations like Genom are still consolidating their power. In the 2020's, they're busy crushing their competition, absorbing or devouring smaller business. Soon there'll be no one left to stop them—certainly not the corrupt, debt-ridden dinosaurs that people still elect as national governments.

Even so, the 2020's are a time for subtlety. Instead of sending combat boomers or mercenaries to obliterate their rivals in broad daylight and using their government contacts to quash any investigation, the 2020's megacorporations are more restrained. They prefer to use single assassins (human or boomer), and are careful to make sabotage look like industrial accidents.

In addition, the corporations are still concerned with their public images. For example, Genom has only just completed MegaTokyo, and is basking in the gratitude of the citizens. Most people still see



the corps as saviors rather than menaces, and the corps would like to keep it that way ... even if it takes a few deaths.

▼ POLLUTION-RELATED ILLNESSES

"Someday I plan to live out in the country, where the air is clean."
— A MegaTokyo citizen, AD2032

The 2020's are a time of unrestrained industrial growth. The release of toxic byproducts from new industrial processes into the air, soil and water have left many people with irritated or damaged lungs, eyes, skin, or other organs. In parts of MegaTokyo, the pollution is so bad that not even weeds can survive. In many developing regions like Central and South America and the Central Asian Republics, the situation is a lot worse.

Visionaries promise to solve this problem by moving industry into space sometime in the next decade—just vote for more tax-subsidies and government research grants to the Space Development Corporation, for Genom's new boomers designed to clean up toxic waste, for the latest in environmentally friendly tailored bacteria and pollution-eating nanomachines

In the meantime, if toxic contaminants have irritated your eyes or lungs, or noise pollution has damaged your hearing, don't despair! Just go to the Cybernetics Bank and get a replacement.

▼ CYBERNETICS AND GENETICS

This is the big change in attitude. In the 2020's, it's chic to replace your body with artificial parts. (In the 2030's, nobody's doing it. Why? See *Cybernetics and Boomer Syndrome* on p. 10.) It isn't just humans being modified, either. Wealthier zoos are using cloning to breed rare animals in captivity. This technology also makes its way to the street—freelance gene hackers and cyberdocs pander to jaded tastes by creating grotesque "toy" animals, such as fish with tiny human faces.

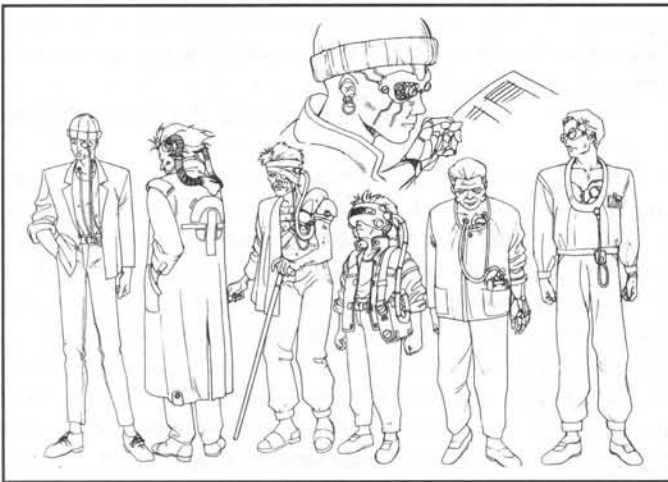

▼ ARMORED VIGILANTES?

In the '20's, Syla Stingray is busy setting the groundwork for the Knight Sabers, testing and refining her father's designs. Powered suits and battlemovers exist in military and even some advanced police arsenals, but they're still extremely rare, and are big, slow, clunky designs. If you want to take on a boomer or a 'borg, odds are you'll have to do it *without* a hardsuit.

▼ LAW AND ORDER

"I don't like the police — especially the AD Police."

— Priss S. Asagiri, AD2032



Frightened by riots, terrorism, and the new specter of boomer crime, a nervous citizenry has unloaded sweeping powers on the newly formed Advanced Police.

Unfortunately, the Advanced Police of the 2020's are more likely to abuse these powers, especially when confronting lower-class citizens such as slum-dwellers. This is because the Advanced Police were formed to deal with human enemies: rioters, terrorists, heavily armed drug dealers, and so on. The police are facing an urban war, and many officers have a siege mentality: "Ordinary citizens don't understand us, and the Normal Police are useless desk-jockeys, while we're the ones out dying for little pay or glory."

A lot of Advanced Police are ex-military; officers like Leon and Jeena who transferred from Normal Police are exceptions rather than the rule. Rough, hard officers like Dieork or Alus have little patience with normal citizens who get in their way and show no mercy to scum like gang members, rioters, or terrorists.

In the showcase central business districts and Academy Zones of the new Technologically Integrated Economic Cities the Advanced Police tiptoe around their corporate masters, but within the residential areas and slums the frustrated officers cut loose. Sure, these guys stop riots, terrorists, and berserk boomers, but too often the cure is worse than the disease: "We had to destroy the neighborhood to save it" is a joke too real to be funny. Not that the corporations care if a few slums and their occupants get wasted — they were destined for the bulldozers anyway

In fact, the police in 2027 are often employed to "clean up" undesirable neighborhoods. For example, in the effort to catch "boomeroid" Caroline Evers, the AD Police also sealed off Paradise Loop and killed dozens of cyberpunks. It's a good bet that when City Hall approved the release of heavy mecha, they were just as interested in lancing a boil on the technologically integrated city as in catching the Ripper.

So how did this change for the better in the 2030's? Take the MegaTokyo's AD Police as an example. First, many of the more militaristic officers died in the line of duty, or retired. In the AD Police, the rise of Leon McNichol to the position of Inspector began to influence things for the better, as he determined to improve the bad image of the AD Police. Second, the cops were successful—most of the gangs were curbed and the riots quashed. Moreover, as corporate warfare and boomer crime began to escalate, the officers began to perceive their enemies not as street punks and terrorists but as the very corporations that had helped establish them. No detective likes having his investigation into a crime blocked by pressure from "Upstairs." "Us and them" became not cops vs. citizens, but cops vs. corps.

The corporations, of course, were aware of the threat that an independent, increasingly suspicious police force would pose. Legislation limiting the police began to be written. In 2027, the AD Police could send armored vehicles running over cars and crashing through walls to stop a runaway waitress boomer. In 2034, faced with a platoon of power-suited mercenaries, the AD Police needs permission of the Diet (the Japanese parliament) before they could use their powered suits and heavy equipment.

Quite a difference seven years makes ...

CYBERNETICS & BOOMER SYNDROME

Japan is at the bleeding edge of the world cybernetics movement. Cybernetics become commercially available in the early 2020's, a few years before the Great Kanto Earthquake. In the mid-2020's, cybernetics are everywhere. But in the 2030's, the decade of the Knight Sabers, they're nowhere to be seen. What's the story?

In the first decade of the 21st century, developments in organic biochips, nanotechnology (see *BGC* p.96) and synthetic organ substitutes led to commercial cybernetic parts. These were initially used entirely for medical purposes, to replace lost or failing limbs and organs.

At first cybernetic implants were simply a transitory solution, made necessary by the long waiting lists for suitable organ transplants. Someone waiting for a lung transplant, for example, would install a cybernetic lung inside her body, rather than spend months carrying around a portable lung machine. Later, in the 2020's, the damaging effects of toxic pollutants and, in Japan after 2025, the vast number of casualties from the Kanto Two quake, many with maimed limbs, led to an acceleration of cybernetic replacement. Treating them completely overwhelmed pre-Quake organ banks and meant that the "ordinary person" had to be content with artificial parts. The mass production of artificial limbs and organs for boomers also helped pushed down the price of human cybernetics—in fact, often the same parts are used in both cyberware and boomers. With so many people sporting cybernetics, many people began to see cyberware as perfectly natural.

"So I completely rid myself of all womanly functions. I had them made cybernetic. After that, my work became flawless, and soon I had my own company."

— **Caroline Evers, President of Green Corporation, AD2027**

By the early to mid 2020's, *elective* cybernetics had become popular. These types of cybernetics include implants that healthy people could use to augment their capabilities, or to control normal human drives that got in the way of their concentration and productivity. Cyberware promised everything from better vision to better sex, and became the "in" thing for the corporate worker on the go. Trouble getting organized? Wire a spreadsheet into your brain. Ulcers making your life miserable? Get a *cybernetic* stomach.

The combination of organ shortages and high demand led directly to "mass-market" cybernetic providers. One such institution is the Cybernetics Bank (see p. 14), where customers can trade organic parts in exchange for "better" cyberware. To save money, some cybernetics banks even graft limbs and other parts from dismantled or recycled boomers directly onto human patients!

▼ BOOMER SYNDROME

"Even if you replace just a small part of your body, you become something other than human!"

— **Leon McNichol, ADP Front Line Officer, AD2027**

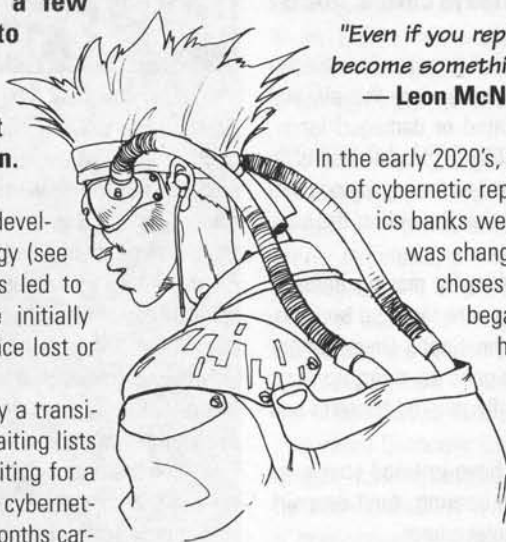

In the early 2020's, no one was aware of the long-term hazards of cybernetic replacement—or if corporations and cybernetics banks were aware, they covered it up. By 2027, this was changing, as reports of a disturbing range of psychoses associated with cybernetic replacement began to be collected by police and mental health workers.

While the vast majority of individuals who underwent minor cybernetic replacement never experienced difficulties, a significant minority of people suffered severe psychological trauma. This so-called "boomer syndrome" (named for the similar

problems that caused some cyberdroids to go crazy) is a mental disease linked to several different causes, from purely psychological problems to actual mechanical dysfunction.

The most frightening aspect of boomer syndrome is its progressive nature. Someone may start out with minor problems, or with brief attacks that last a few minutes or hours at a time. Over a period of months or years, the symptoms become more severe and the manifestation of the attacks more and more frequent.

▼ SYMPTOMS OF BOOMER SYNDROME

"A change inside the body brings about a change in consciousness, you see."

— **Caroline Evers, aka The Ripper, AD2027**

• **Sensory Deprivation.** Cybernetic implants in the 2020's are unable to duplicate the full spectrum of human sensations. A cybernetic limb may include basic pressure receptors, but typically lacks sensitivity and often has no ability at all to feel pain or temperature. If the *entire* body is plated over with a metal exoskeleton, the danger of sensory deprivation becomes even more acute. Many cybernetic eyes, ears and noses lack some of the quality of human senses—for instance, a cybernetic eye may indeed have telescopic and night vision capabilities, but its color vision may have the bright, false colors of a cartoon or video display rather than more subtle shadings of reality. Sensory deprivation can easily lead to ever-increasing dissociation from reality: a sense that *nothing* is real, that it's all just a game.

• **Lack of Emotion.** This is usually the result of sensory deprivation. The subject becomes disconnected from other people, and often begins to think





of himself as a machine. This can be exacerbated if the people around him treat him more as a machine than as a human, thanks to any visible cybernetic parts.

- **Biochip Distortion.** Our strongest emotions—like rage, lust, or fear—are generated by hormone-producing glands in the endocrine system. Unfortunately, the pseudo-organic biochips that are used in many cybernetic implants have a flaw: They can be distorted by hormonal signals. What this means is that a cybernetically-enhanced individual who finds himself in the grip of fear, anger or lust can often adversely affect his own cybernetics, causing neural interface malfunctions. Worse, the stress from these malfunctions can lead to more rage, fear, or anger, further disrupting the biochips—a feedback loop.

- **Neural Interface Problems.** Cybernetics are connected directly to the brain and nervous system by biochips and optical fibers. If the interface isn't perfect, unwanted feedback can result. Imagine a misaligned wire or short-circuit somewhere deep inside your body that's sending scrambled data or random electrical signals to your brain—and, unnoticed, is gradually worsening. It may start out as a normal-seeming headache or something else minor, like a periodic sound or odd smell that no one else can perceive. If untreated, it can easily escalate into epileptic-like spasms, seizures, hallucinations, or worse.

- **Phantom Pains.** These could be caused by a neural interface problem or a poor "fit" in the cybernetic part, or be purely psychosomatic. They include itches, cramps, and other irritating feelings in cybernetic parts that *shouldn't have* that kind of sensation. For example, Caroline Evers replaced her lower body with cybernetics, but she still experienced phantom menstrual cramps.

- **Sociopathy.** This is closely related to disassociation. If everything is unreal, what do other people matter? If *you* can't feel pain, why should you worry about *their* pain? Depending on the individual's mental stability, sociopathic tendencies brought on by boomer syndrome can manifest as violent mood swings, compulsive lying, kleptomania, sadism, split personality, suicidal despair or homicidal rage.

- **Cyberaddiction.** Individuals suffering neural interface problems, phantom cramps, and other boomer syndrome disorders sometimes develop the delusion that their problems are caused by their remaining organic body parts. If so, they often become "cybernetics addicts", attempting to replace more and more parts with cybernetic replacements. This is generally futile, as it simply exacerbates whatever problems they already suffer from.

- **Psychomorphing.** These are terrifying hallucinations in which the sufferer's body seems to be transforming into something monstrous—his face distorting, his remaining human parts melting or morphing into circuitry, metal, and plastic. Psychomorphing hallucinations are often the "final stage" of boomer syndrome, and are typically followed by self-destructive behavior or homicidal rage.

- **Cybermorphosis.** This is a rare, horrifying, and little-understood phenomenon in which a person's cybernetic parts briefly "come alive" altering their appearance into a more machinelike form. For example, someone's concealed cybernetics may suddenly appear as a pattern of

writhing cables under his skin. If cybermorphosis takes place, it is usually in conjunction with other severe symptoms, such as a seizure or homicidal mania. Cybermorphosis is most likely caused by the inadvertent use of recycled boomer parts in cybernetic implants—severe biochip malfunctions reactivate the boomer's "cloning" functions, resulting in this sort of terrifying mecha-morphosis.

▼ BOOMER LAW REVISIONS

"She's already a boomeroid—a Boomer Exceedingly Close To Human. If over 70 percent of the body has been made cybernetic then the individual is treated as a boomeroid. She's the test case for next month's Boomer Law revision."



— Leon McNichol, ADP Frontline Officer, AD2027

In late 2027, the Diet passed new legislation to deal with the cybernetics situation. In short, the law did *not* ban cybernetics. It simply said that if you replace too much of your body, you are no longer human. The Boomer Law revision had two obvious effects. First, the law made it possible for the AD Police to execute summarily humans who had become "boomeroids" with a minimum of fuss. In fact, since a boomeroid (previously human) had no owner, there wasn't even the need of a Destruction Approval form.

Second, the law signalled the gradual end of the cybernetics movement. Any law which classed a partially cybernetic person as nonhuman was bound to have a chilling effect on the organ replacement business, even if it had no impact on the "average" recipient of a single cybernetic kidney or artificial eye. Sure, the law was supposed simply to regulate cybernetics, make them safer—but its very arbitrariness worked against that. The government said cybernetics made you dangerously inhuman after 70% of your body was gone—but what was the difference between 69% and 70%? What if the government had *underestimated* the dangers? Or maybe next year the Diet would legislate away your humanity if you were 35% machine. Would you take the risk? From 2028 to 2032, people gradually abandoned cybernetics. This also saw the end of corporations like the Cybernetics Bank.

Wait a minute—the Diet enacted a law that was *bad for business*? What gives? If the law was against the best interests of cybernetics manufacturers and organizations like the influential Cybernetics Bank, whose interests did it serve?

Japan's cabinet and the Nationalist party unanimously approved the law—as it was expected to. No one will ever know exactly what backroom deals in smoke-filled rooms led to the Boomer Law revision, but some of the factors are worth looking at.

- **Citizen Pressure?** This seems to be the answer—people were going crazy, and something had to be done. But a close look at the tim-





ing of the laws suggest otherwise. When the Boomer Law revision was enacted, the average citizen still thought cybernetics were a good thing. "You'll never live a long time if you're against artificial organs" was the popular wisdom, even among well educated individuals like corporate executives and police officers. Some people who did have cybernetics were nervous about them, and there were always conservatives who felt that replacing body parts with metal was bad for the soul. However, the dangers of cybernetics were little understood by the public or the medical profession in 2027.

• **The Police and Public Safety?** Some AD Police officers were morally opposed to cybernetics—Leon, for example. But it's likely that the AD Police supported the boomeroid law for the same reason that many police departments favor gun control. That is, a "borged up criminal was a lot more dangerous to them. That the AD Police didn't take "boomer syndrome" seriously is borne out by the fact that, after the boomeroid laws were enacted, they maintained a cyborg combat unit of their own—Billy Fanward.

• **Genom?** On the face of it, the boomeroid law seems to be against Genom's interests. After all, it's very likely that many of the cybernetic parts installed at places like the Cybernetics Bank were made in Genom factories. Genom was well placed to dominate the cybernetics business, if it wanted to. Certainly cybernetics were no more dangerous than boomers themselves, and Genom's own public relations machine was capable of ensuring a ready market for Boomer sales despite numerous "incidents."

In 2027, Genom had just reached the pinnacle of its influence. It had rebuilt MegaTokyo in only two years, and its boomers were in massive demand to handle the labor shortage. It's hard to believe that the Japanese Diet could blow its own nose without Genom's permission, let alone pass a law it didn't like. So why did Quincy allow it? The most logical answer is that the Boomer-Revision Laws were *something that Genom wanted*. There are good reasons to believe this to be the case.

Genom's main goal was to sell boomers. Cyborgs, though they might use boomer parts, were unwanted competition. Why sell only a cybernetic arm to make someone stronger when you can sell an entire boomer? Economically, cyborgs were a diversion. Moreover, if Genom parts were misused and a cyborg went insane, the company's already shaky public image might suffer—perhaps more than if a boomer went crazy. Genom scientists may have been aware of the danger of boomer syndrome, and felt it would be considerably easier to work toward stable boomers rather than stable cyborgs.

Furthermore, unlike cyborgs, boomers, despite their power and propensity for accidents, could be programmed and *controlled*. The secret Over-Mind Control System (OMS) gave Quincy a cybernetic leash on every boomer made. If boomers replaced police, workers, even citizens—if the world became "wall-to-wall boomers"—Quincy would be its ruler. But cyborgs had no such mental restraints. If the armies of the world started clamoring for cybersoldiers instead of boomers, Genom would lose a good deal of its business. Being uncontrolled, cyborgs might represent a potential threat to Genom's long-term plans.

Did Genom mastermind the boomeroid laws? Perhaps only Quincy and the inner circle of Japanese ministers know.

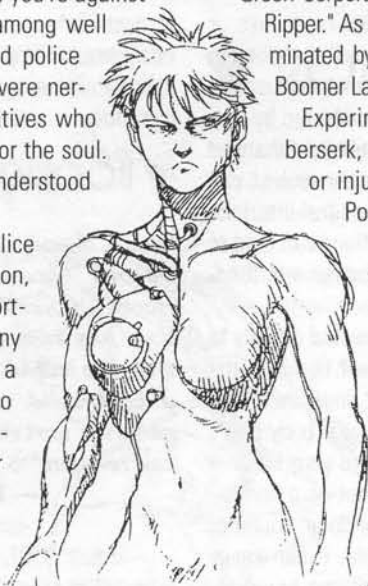

▼ SELECTED BOOMER SYNDROME INCIDENTS

• **2027:** An ex-Cybernetics Bank patient, Caroline Evers, president of Green Corporation, is discovered to be a serial killer known as "the Ripper." As she is now 70% cybernetic, she is hunted down and terminated by the AD Police in the first application of the revised Boomer Laws.

Experimental Anti-Boomer Cyborg Billy Fanward goes berserk, murdering his "creator", Dr. Takagi Yooko and killing or injuring several officers before being killed by the AD Police.

• **2032:** Psychic Brain-Trip systems—neural-interface helmets used to cause entertaining hallucinations—are taken off the market after a series of incidents shows they cause tumors and insanity very similar to that experienced during boomer syndrome cases.

• **2033:** J. B. Gibson and his Griffon car merge via the Mind Feedback System, resulting in mutual insanity. The Cybermonster Griffon is destroyed by AD Police, and Gibson is placed in therapy.

▼ BILLY AND BOOMEROID LAW

Soon after the Boomeroid Laws were passed, the AD Police deployed its own prototype combat cyborg. Billy was certainly a boomeroid—his entire body except his tongue was machine. Why, if they supported the boomeroid laws, did the AD Police internally develop their own fighting machine?

Actually, the answer's simple. Billy would have been dead if he hadn't been brought back that way. Billy *was* a boomeroid—not legally human. That's one reason why his doctors considered him an experimental animal rather than a human being.

THE REVISED BOOMER LAWS IN PLAY

In a game that runs past 2027 and follows the official timeline, the revised boomer statutes will be in place.

So what if the law says you're a boomeroid and you *aren't crazy* (yet)—does that mean it's "shoot on sight?"

Not at all.

If you're working for an agency like the Advanced Police, the military, or a corporation like Genom, you'll be fine. Of course, if you fail to obey orders, they'll probably decide your attitude isn't quite right, and start using drugs and mindwipe. Try to make a break for it, and they'll hunt you down and shoot you like a mad dog. That's what the law's about.

Suppose you're freelance—like Caroline Evers, you've replaced yourself bit by bit, but, unlike her, you've managed to stay sane. What happens if the authorities find out you're a boomeroid? As a danger to public safety, you'll be asked to surrender yourself to the authorities. If you resist, they'll get a termination order and the Advanced Police will come a-hunting. If you don't resist, you can undergo surgery to be returned to normal (if you can afford it), accept voluntary euthanasia (if you can't), or vanish into some government or corporate secret lab—there to become one of their newest experimental subjects. If you're willing to play ball, they might even take you on as a special operative. You may be treated more as a boomer than a human being, but you'll probably see a lot of action as well.

GENOM IN 2027

Genom has just embarked on its massive period of growth. Its first great megaproject, the transformation of Tokyo, has succeeded. Now it is intent on consolidating its gains.

▼ THE GENOM TOWERS

These monolithic superarcologies are still under construction and are consuming a great deal of Genom's resources, time, and attention. By early 2027 the MegaTokyo Tower's underground levels have been completed and the immense foundation pit has been dug. The "pit" contains a massive ongoing construction project that runs night and day.

By mid-2027, the tower starts to rise out of its foundation, beginning its inexorable and seemingly endless growth. Other Towers around the world have also begun construction, except for the Tower in Sydney, Australia, where the real estate is still being surveyed.

▼ GENOM'S HEADQUARTERS

Genom has hundreds of warehouses, company buildings, and offices throughout MegaTokyo. In 2027, its main offices are located in the Genom Building (opposite the Sun Tower Hotel). By March of 2028, the Genom Building will be largely empty: Most personnel will have moved into the partially completed Genom Tower, while the Genom Building is converted into a computer center.

▼ GENOM'S LEADERSHIP

Quincy is just as firmly in control in 2027 as he is in 2032, and is just as reclusive and autocratic. The ruthless Brian J. Mason is impatiently waiting for Quincy to die, hoping to succeed to the chairmanship. In 2028, a rogue fusion boomer hints to Mason that this isn't going to happen—this may be the spur for Mason to begin actively plotting against the chairman. Meanwhile, Kate Madigan is still climbing the ranks of the security division.

▼ GENOM'S SPECIAL PROJECTS

Most of Genom's effort is taken up purchasing land, building the Towers, and expanding its industrial base, as well as engaging in mundane activities like bringing out several new models of car every year. However, several "secret projects" are ongoing in 2027 that will bear fruit in the next decade:

- **BU-55C:** This was "a new type" so these combat boomers are probably undergoing development in various secret labs in 2027.
- **Fusion Boomers:** These are still a deep secret until their first terrifying appearance in 2028.
- **Over-Mind Control System:** It is possible that OMS was still under development in 2027. If so, this raises the intriguing possibility that some early-model cyberdroids (perhaps those with more biological parts) may *not* be vulnerable to the OMS.
- **Military Boomers:** As usual, Genom spends a lot of R&D effort in developing these. For every success (BU-12B) that makes it to the world arms market, it's likely that several other models are rejected at various early testing stages and end their days scrapped for spare parts or buried in some warehouse. Of course, these could be salvaged by vigilantes or Genom splinter groups!



▼ GENOM'S COVERT OPERATIONS

Genom is a little more ruthless in 2027, and is paranoid about maintaining its good name. Unlike the "lumbering giant" (see *BGC* p.164) of the 2030's, the younger, meaner Genom will act decisively to eradicate any threat to its public image. Like a young lion, Genom is not yet confident enough that it can brush aside minor threats. It needs to ensure good public relations worldwide. Part of the reason for this is its massive construction and real-estate program—it wants to be seen as a "good neighbor" so that city councils in MegaTokyo and around the world will approve its numerous land purchases and rezoning applications.

So, if Genom discovers a threat, it has no qualms at all about using murder to remove it. It's not interested in making public examples, as in the death of Irene Can in 2032. It wants quiet, untraceable deaths. The elimination of Priss' street gang lover, who was murdered after discovering "a certain organization's" secrets, may be one example of such an operation.

Genom's favorite tactic is to send a single boomer assassin to quietly murder its target, then arrange for some other event (riot, boomer rampage, etc.) in the area to make the death look like another case of senseless, random violence.

Things Genom is especially paranoid about:

- **The Mysteries of Quincy and the 2nd Great Kanto Quake:** Anyone caught digging too deeply into either of these enigmas (see *BGC* p.166) is likely to be tracelessly murdered.
- **International Relations:** Allegations that Genom is violating armaments export laws or is involving itself in Polar War politics or Third World coups, for example.
- **Product Safety:** Genom is proud to make quality products. Any "false rumors" and "unsubstantiated allegations" that Genom cars, boomers, or whatever were unsafe would be ruthlessly suppressed. Genom will use lawsuits or out-of-court settlement, steal evidence, bribe witnesses, or commit murder to keep its good name.

MEGATOKYO 2027



"In this town whether you're Boomer or human ... it's all the same, in the end."
—Leon McNichol, AD2027

MegaTokyo in 2027 isn't very different from the city of 2033. But only two years ago, nearly one million people died. Is it any wonder that the survivors are a little crazy?

NOTE: In both this section and the MegaTokyo section on p.50, we have not given specific map locations for these sites, since no such information was available.

▼ AD POLICE HEADQUARTERS



THE OLD AD POLICE HEADQUARTERS: This squat warehouse building is the interim headquarters of the fledgling AD Police. Much of its interior is dark, garbage-strewn, stained, and generally run-down. The building has offices, extensive garages, and separate guys'n'girls locker rooms. Officers complain of cold showers and frigid air conditioning, resenting their organization's second-class treatment and dependence on Normal Police for equipment and facilities.

AD POLICE DISTRICT-3 HEADQUARTERS: Originally a fashion building, this round skyscraper in District Three was purchased by the city government to be the "new headquarters" for the AD Police. They moved into it in the middle of 2027, making it their permanent home. The new HQ marked the AD Police's expansion in manpower and prestige and their acquisition of state-of-the-art equipment, especially extra garage facilities, rooftop helicopter landing pads, and brand-new computers and communications gear.

The new headquarters building is described in detail on BGC pages 120 and 147. Differences in 2027-2029 are:

Look and Feel: The building is starker, less lived-in. The Frontline Officers dominate the show—special units like Mecha and Investigations are still small, and even higher-ranking officers tend to wear combat-issue fatigues rather than shirt and tie. The HQ has an impersonal "too big" look to it—there are fewer officers, and lots of dark corners and empty offices that have yet to be filled.

Cybernetics Lab: The ADP HQ included a cybernetics research and development unit staffed by outside technicians, where the Anti-Boomer Cyborg Program was under way. After the Billy Fanward incident, research and development of this nature was suspended indefinitely. The lab is still used, mostly to identify and analyze boomers for forensic evidence.

Weaponry: The building initially lacked its automatic weaponry. Gun turrets were installed in 2028 during the renovations necessitated by the Billy Fanward incident. Gas jets were added after an assault on a Genom highrise in 2029 underlined the vulnerability of modern buildings to terrorist threats.

▼ NORMAL POLICE HEADQUARTERS



This new multistory skyscraper in the heart of downtown Tokyo is the headquarters of the Normal Police. It's a much nicer place than the old AD Police headquarters, with large, well lit conference rooms and showers that aren't ice-cold. Until the Advanced Police get their new headquarters, this doesn't help relations between the two agencies.

▼ SALVAGE OPERATIONS

85,000 people were killed as a direct result of the Great Kanto Earthquake. (Another million died from fires, food shortages, injuries, riots, and disease afterwards.) Many of the dead were buried alive. Not all were recovered—and Genom construction crews sometimes find buried bodies left over from the quake.

▼ CYBERNETICS BANK OF TOKYO

"They cut your organs out and replace them with cybernetics, then they put the organs into the Bank and sell them off to fat cats who want organ transplants. They're glorified Organleggers!"

—Leon McNichol, AD Police Officer

This highrise hospital building houses one of the more controversial institutions of 2020's MegaTokyo. The Cybernetics Bank is dedicated to making cyberware available for the masses.



The Cybernetics Bank prides itself on its democratic approach to cyberware. In its waiting rooms can be found street punks, police officers, and billionaire businesswomen.

The Cybernetics Bank provides counseling for people who are considering cyberware. However, the doctors are a little biased—they'll recommend you get a replacement for even the slightest injury. They're a little less forthcoming if you change your mind, though, and will attempt to actively discourage "reverse" operations.

In addition to replacement operations, the Cybernetics Bank also offers tune-ups and repairs for damaged cybernetics.

▼ NEW BUSINESSES

THE BRAIN BOOK CENTER: This cramped shop supposedly retails audio cassette books. Actually, it's the front for drug pusher Hyde Cash, who sells a variety of illegal drugs, especially the powerful brain stimulant DA-27. Cash is flamboyant, lecherous, and completely shameless. For a valued customer, Cash will deliver the drugs in person, concealed within a cassette tape. When Billy Fanward was addicted to DA-27, Cash was even willing to deliver in person to the AD Police HQ! However, Cash isn't a fighter—if he's caught, he'll try to run or talk his way out rather than use violence.

THE GENOM BUILDING: Located in District Six, this is a big ugly skyscraper directly across from the Sun Tower Hotel. It serves as one of Genom's major interim headquarters while the Genom Tower is under construction. In 2028, the Tower is sufficiently complete that Genom can move its main offices out. The building then undergoes renovation to turn it into a computer center, housing the ALEX super-computer. While mostly empty, the building (and the ALEX computer inside it) was seized by terrorists in 2028 shortly before it formally opened; much of it was destroyed by a fusion boomer and orbital strike, but Genom later rebuilt the facility.

GENOM TOWER: This edifice has been under construction since 2025, but so far only the foundations are complete. See *Where's Genom in 2027?*

GREEN BUILDING: Another large highrise office building, located a few blocks away from the Cybernetics Bank of Tokyo. This contains the spacious head offices of Green Corporation (see *BGC* p. 58). From 2024 to 2027, Green Corporation's president was Caroline Evers (see p. 31).

PERCHE: This is one of several shopping and recreational complexes in MegaTokyo. It is home to various avant garde shops and boutiques including Creature, Rad Out, the Smut Tape Inn, Tomato, and others.

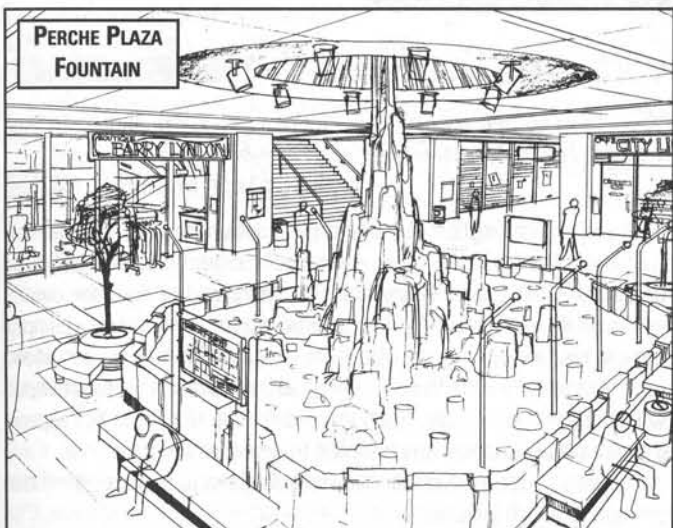

SUN TOWER HOTEL: A fancy highrise hotel in District Six, this is just across from Genom's interim headquarters. It's a good place for a date.

▼ PARADISE LOOP

"They say that riding Paradise Loop means prostitution and drugs."
— Vanessa Bach, Normal Police detective, AD2027

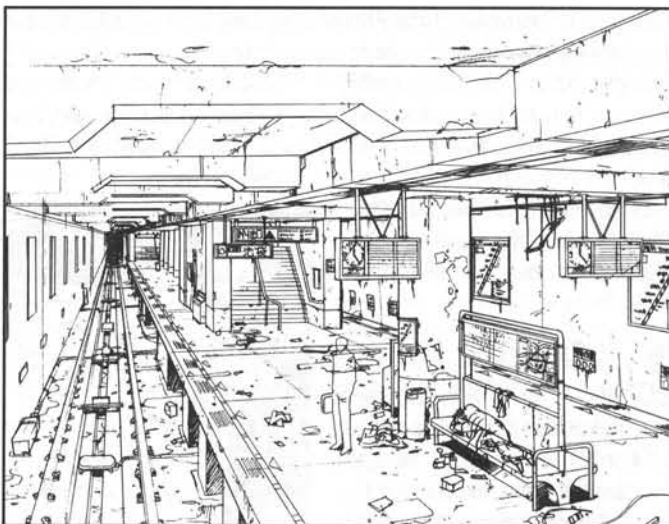

This is the slang term for what remains of Tokyo's old subway system. The majority of the underground subway was shut down and replaced by maglev trains following the Kanto Two quake. However, the electricity inexplicably remained functional on a single loop line, and at least one train continued to run.

Paradise Loop is haunted by drunks, punks, muggers, prostitutes and the occasional serial killer. The stations can be reached by long spiral staircases which lead downward from the street. Portions of this underground labyrinth remain lit, while other areas are cloaked in darkness. Many sections are flooded, with water levels ranging from ankle- to waist-deep.

In late 2027, Paradise Loop was sealed off by an AD Police operation, which destroyed a train and blocked at least one of the Loop's tracks. The network of tunnels is still accessible after 2027, and probably still inhabited by various street people, but whether other trains continue to run is up to the Referee.

▼ UENO ZOO

The largest zoo in Tokyo. In the 2020's, it has a major genetics program that has experimented with cloning rare and endangered animals. In 2027, news of a successful cloning of a panda provides a welcome distraction from terrorism, boomers, and riots. Over the next few years, no elementary school class can resist a trip to see the cute cloned baby panda and its mother.

▼ ROOFTOP CEMETERIES

In MegaTokyo, land prices are so high that only the rich or lucky can afford an actual graveyard burial. Instead, landscaped cemeteries are being built upon the flat tops of highrise buildings—at least they're closer to heaven. What's left of Billy Fanward (his brain) is buried in a shallow grave in one such cemetery. It's near Yokohama, with a good view of Tokyo Bay.

AD POLICE 2027

▼ AD POLICE STRUCTURE

"Listen up! AD Police will handle this incident! Normal Police retreat! Repeat: Normal Police retreat!"

— ADP officer, AD2027

The exact organization of the AD Police is fairly flexible, with officers regularly reassigned to different duties as the need arises. There aren't enough officers to man fully each department; as a result, officers are expected to help out where needed. For example, a detective who usually works investigations will often also accompany or command a field unit.

Nevertheless, the AD Police does have a few specific subunits that officers may be members of. These include:

▼ FRONTLINE ASSAULT SQUADS

The AD Police's frontline officers (*BGC* p.121) are organized into eight-man squads—the number that fit in an ADP Troop Transport. In practice, the Japanese labor shortage, combined with attrition from injuries, deaths, and temporary assignments to other duties, often results in a squad of only four to seven people being deployed.

Between assignments, frontline officers spend a lot of time waiting in the various squad locker rooms in the ADP Headquarters, waiting for the next incident to respond to, maintaining equipment, or training. In the 2020's, the ADP's smaller manpower pool sees officers assigned to a wide variety of extra duties, such as investigations. In the bigger ADP of the 2030's, frontline officers are more specialized as "police troopers."

AD Police doctrine says that a noncombat boomer can be taken out by three trained officers. If they have time, squads may split into one or two three-person "assault teams", plus the commander and an officer with a heavy or special weapon. In tactical situations, this also allows a "leap frog" advance—one officer providing cover while two move forward, or vice versa.

In practice, however, a boomer incident usually doesn't allow for careful tactical deployment—oftentimes, officers are lucky if they have time to pile out of their vehicles, take cover, and open fire!

▼ MOBILE UNITS

The armored fist of the AD Police is the "mobile unit", sometimes called a "Detachment" or "Mobile Field Force." When a group of armored vehicles roars out of AD Police headquarters to deal with a boomer incident, this is what's on the move.

In 2027, the AD Police has only two or three numbered detachments; each detachment consists of two to three squads of Frontline Officers (see *BGC* p.121), each carried in an ADP Troop Transport. One of the unit's troop transports is usually configured as a Command Vehicle; there may also be one to two ADP Interceptors (such as the commander's own vehicle). The manpower in a Detachment varies, as squads may sometimes be absent handling individual assignments. Also, while a squad supposedly has eight officers, many squads are chronically understrength. The AD Police had only a couple of mobile detachments in 2027—in fact, until it moved to its new HQ, it didn't have room for more.

In 2028, the AD Police expanded considerably (to fill its new headquarters), and the detachments were officially renamed "mobile

field forces," although many officers just call them "units" or "mobile units." The increased threat of boomers has made it necessary to beef up their firepower, so a mobile field force is typically assigned a single Helicopter Truck (*BGC* p.123) equipped with Firebees, or a ADP Transporter (*BGC* p. 125) with a couple of K-suits. In dire situations, two or more mobile field forces may be scrambled against the same incident, but one is supposed to be sufficient—in theory.

A mobile unit is normally commanded by a senior Front Line Officer, a detective, or an inspector. The unit commander is normally assigned operational control of a couple of helicopters, either from AD Police or from Normal Police. In 2027-28, Dieork commands the AD Police Second Detachment, with Leon and Jeena assigned to its Third Squad. In 2032, Inspector Leon McNichol often commands his own mobile unit; by 2033, Daley Wong does as well.



▼ INVESTIGATION SECTION

"You'll have to use your heads—unless you want people to say that AD Police detectives are even dumber than boomers!"

— Inspector Leon McNichol, AD2034

The Investigation Section consists of plainclothes detectives under the direction of the AD Police Chief and a senior inspector (Leon McNichol, from 2033-34). It's small—tiny in 2027—compared to the huge detective sections maintained by Normal Police precincts, but this simply reflects the orientation of AD Police toward SWAT-type activities. Detectives usually work in pairs: either an inspector and a detective, or two detectives. In 2027-29, frontline officers with Normal Police experience are often temporarily reassigned to detective work.

The Investigation Section has several duties to perform, the most common of which include:



• **BOOMER LAW VIOLATIONS:** The section on *Boomer Law* (*BGC* p. 116) details various crimes that involve boomers. AD Police detectives are responsible for solving cases relating to theft, fencing or illegal recycling of boomers, as well as locating runaway boomers and boomeroids. While out-of-control combat boomers will usually just go on a rampage, more intelligent and human-like models such as sexaroids, assassin boomers, advanced prototypes, or boomeroids may simply vanish into the population, which requires investigation to track them down.

Theft, recycling, or fencing of boomers are all crimes committed by humans. In some cases Normal Police may insist on a joint operation especially if the criminals are also involved in other illegal activities. More often, though, the overworked and underfinanced Normal Police are all too happy to unload jurisdiction over *any* case that might involve boomers on the AD Police, so stolen boomers are left entirely to the ADP.

• **FINDING STOLEN BOOMERS:** If boomers or boomer parts (such as an AI) have been stolen from a warehouse or laboratory, AD Police may be assigned to the case. This is due to their special expertise in this area, and the danger of confronting the stolen boomer if it's been reprogrammed by the thief.

When a boomer has escaped or been stolen, AD Police detectives will usually follow certain procedures:

1. Check out boomer fences and recycling shops. If you don't act fast, there's a good chance a boomer may end up dismantled into its component parts or recycled into other machines, making it a lot harder to trace.

2. Know where to find the local cyberpunks. A few street gangs make a living by hijacking boomers off the streets and selling them to recyclers and fences, so keep an eye on your local cyberpunks.

3. Investigate the owner! Sure, he's the victim—but if a boomer has run away or been stolen, there may be more to his story than he's letting on. Was it a special prototype? Did it have illegal weapons or systems (e.g., fusion capability or sex functions) that no one wants to admit? Was it mistreated by its owner? Does it carry secret data on its owner's illegal activities in its brain? Could it be the former mistress of the company president, with access to top secrets? Was anything else missing along with the boomer (like a top-secret battle mover)?

Few owners are willing to reveal this sort of information, but detectives shouldn't take everything at face value. Intimidation, sleuthing, or computer research can turn up data that could save a detective's life! But use restraint when dealing with powerful corporations—there's no sense attracting pressure from "upstairs" to drop the case.

4. Many boomers are extremely valuable. If one has gone missing, AD Police may not be the only party that is looking for it.

5. Cultivate informers! A good officer will have one or two sleazy characters in his pocket who have a good idea what's going on in the boomer underground of cyberpunks, recycling shops, and fences. Informers in companies like Genom are particularly valuable, but hard to come by. Informers may be people who have a grudge against their bosses, or someone the officer has caught at a minor violation but let off, in exchange for providing future favors and information. Other good sources of information are crusading crime reporters or (sometimes) vigilante groups—this is usually a *quid pro quo* arrangement, where the detective informally trades information. The ADP officially frown on paying informers, but this can be done "out of pocket" (i.e., with the detective's own funds); in rare cases a payoff can be authorized with the chief's permission. If the detective was transferred from Normal Police, he'll probably retain many street-level contacts.

6. Hit the pavement! 90% of investigative work is simply going door to door, looking for witnesses to a particular crime or people who might have seen a certain suspect.

▼ OPERATIONS SECTION

"Which database did you pull this from?"

"Neo-NATO's top secret line!"

—Leon McNichol & Nene Romanova, AD2033

Not all AD Police are plainclothes detectives or armored SWAT troopers. Just as vital are proper communications and information support, and to this end, AD Police maintains state-of-the-art facilities run by a staff of highly trained operators who report to a Section Chief.

The main job of Operations Section is acting as police dispatchers: manning the phones, computers, radios, and map displays in the Data Control Room in the AD Police headquarters. ADP operators handle requests for aid from Normal Police, Highway Patrol or the public, which they reroute to appropriate agencies (e.g., when someone calls because his cat is stuck up a tree, they refer him to the Normal Police or the fire department) or dispatch AD Police units to handle. Operations Section also monitors the location of all units on the map displays and handles requests for backup or information from AD Police officers in the field, and is trained to retrieve rapidly information from computer databases.

AD Police operators are also trained in electronic monitoring and surveillance techniques, such as tracing calls and pinpointing the location of cellular phones. They are responsible for maintaining computer security—this means tracking down and blocking any hackers who attempt to infiltrate the AD Police network. Police often cite inadequate communications or communications security as the biggest reason for tactical failures—this was dramatically illustrated in the "Phantom Woman" incident, when a hacker got into the AD Police net and was able to insert data that lured frontline officer Leon McNichol into a trap.

The Data Control Room is a high-stress job, and AD Police operators alternate shifts there with other work. This includes clerical work, such as filing reports on incidents, comparing supply expenditures (e.g., ammunition) with inventories, and so on. They can also be "borrowed" by detectives or inspectors to assist on investigations. This involves performing data searches, typically accessing the Database of Criminal Records and Evidence (see "Tools of the Police", *BGC* p. 115) or other sources, or accompanying them into the field to take notes, drive them around, etc. Operators may also be assigned to traffic detail (see p. 20). For an AD Police operator template, see p. 110.

▼ AIRCRAFT AND POWERED SUITS

"Hornet squadron here—we're going to try a forced landing on the roof—aagrh!"

"Looks like air assaults are impossible."

—ADP pilot (deceased) & Inspector Daley Wong, AD2033

ADP's highest-tech vehicles are its powered suits and aircraft. These range from the tiny Firebee minicopters (*BGC* p. 124) to the mid-sized combat choppers and the very large heavy choppers and transporters (*BGC* p.125) that can carry an entire squad of frontline officers, a single Kumo battle mover or (after 2030) one or two Powered Suits (*BGC* p. 127). These are piloted by specially trained Pilot Officers. The elite within this force is Hornet Squadron, which is made up of officers specially trained for air-to-air combat, who pilot Hornet pursuit choppers (*BGC* p. 124).



Only Firebees are directly assigned to particular mobile units. Combat choppers are controlled directly by headquarters—officers in the field can request them, but whether they arrive depends on what other incidents are taking place. Authorization to assign powered suits, Hornets, heavy choppers or ADP transporters to a particular operation has to come from the chief's office—although if you're a senior inspector, no low-ranking pilot will argue if you say you have authorization.

▼ FORENSICS SECTION

"My body was taken to the police. There, I was dismantled and my components examined. My memory"

— **The Phantom Woman, AD2027**

The ADP HQ has a state-of-the-art crime lab equipped to handle everything from ballistics analysis to genetic fingerprinting. Initially the lab technicians were "borrowed" from Normal Police or hired from civilian life (and may include some "renegade" technicians hired away from Genom). By 2033, the AD Police academy at Kobe was training its own people.

ADP are among the leading specialists in boomer analysis. If parts from a boomer are brought into the lab, AD Police forensic scientists can normally identify the type of boomer, its manufacturer, and (they hope) what was wrong with it within a few hours. The forensics and analysis lab is on the 12th floor of the ADP headquarters.

▼ RESEARCH & DEVELOPMENT SECTION

AD Police does not have scientists of its own. However, the budget of the agency makes it something of a testing ground for new gadgets and a showcase for military equipment and electronics manufacturers. A wide variety of new gear, from new anti-armor railguns to virtual reality firing ranges, is constantly undergoing evaluation; occasionally some of these devices may be placed in the hands of inspectors or frontline officers (or "borrowed" by them without authorization). A staff of civilian-contracted scientists is on hand to run the latest project. The most controversial of these was the experimental Anti-Boomer Cyborg Program (see "Billy Fanward" on p. 34) that ran in 2027 before its abrupt termination. A more successful project was the development of the K-12S especially for ADP.

Regular AD Police frontline officers are often kept in the dark about the nature of the programs going on "under their nose." It's likely that some of the R&D programs are in fact funded by Genom or its subsidiaries—which, if true, would be ironic, since their main focus is the destruction of Genom's other products.

The 15th floor of the ADP New Headquarters (and maybe the classified 22nd-24th floors) is devoted to various ongoing research and development programs.

▼ TECHNICAL SECTION

AD Police frontline officers, pilots, and operators usually receive enough mechanical or electronic training to perform routine maintenance. However, like R&D, most maintenance and repairs on AD Police vehicles are performed by civilian contractors assigned to the headquarters garages. There are usually two dozen such mechanics working at AD Police at any one time, usually in the vehicle repair shop at the 2nd sublevel.

▼ OTHER SECTIONS

AD Police also has numerous "desk officer" sections, such as Planning, Public Relations, Accounting, and Equipment Acquisitions.

▼ AD POLICE RANKS

Rank in the AD Police and Normal Police follows the same pattern as other Japanese police forces. Promotions normally require the recommendation of a superior, a year or so in the previous grade, and passing a written and oral examination. However, promotion in the ADP from 2027 to 2032 is relatively rapid, due to the manpower shortage and high attrition rate. The ranks are:

Officer: Most rookie Frontline officers, highway patrolmen, data operators, as well as specialized jobs like accounting. Example: Leon McNichol (in 2027).

Corporal: An officer with a few years experience is usually promoted to corporal after passing an examination. Example: Jeena Malso (2027); Nene and Naoko (2032-33).

Sergeant: Sergeants lead Frontline Officer squads, pilot helicopters or suits, or have important desk jobs. This also includes junior detectives in Investigations. Example: Iris Cara and Vanessa Bakke.

Assistant Inspector: These include detectives in the Investigations Section, or commanders of helicopter squadrons or mobile units. Example: Daley Wong.

Inspector: The most senior detectives and section chiefs are this rank. Those in charge of mobile units often use the title "Commander." Example: Leon (in 2032) and Dieork.

Chief: The head of the AD Police. From 2027-2033, this is Chief Todo. He is replaced in 2034 by the new chief.

Note that in the Normal and the Advanced Police, "Operator", "Frontline Officer", "Pilot", and "Detective" are positions, not ranks.

▼ AD POLICE RESPONSE TIMES

"Damage report! Where the hell are our choppers?"

— **Inspector Leon McNichol, AD2034**

If an officer's in trouble, how long until backup arrives? If your group of armored vigilantes is slugging it out with boomers, when do the AD Police appear to confuse things?

The short answer is that it takes however long the Referee thinks will be dramatically appropriate—it's possible that all units have been diverted to a major incident in another part of the city, for example, or that a patrol chopper loaded with K-11's just happens to be passing overhead when the call for help comes in. But assuming everything goes according to routine, here's a typical breakdown of a boomer incident by response time:

First 30 seconds (10 phases): Citizens or Normal Police call the AD Police hotline, reporting a possible boomer incident. The call is screened by an AD Police operator, who will determine the location and nature of the incident and relay it to her immediate superior (either the section supervisor or whichever senior officer is on duty). They'll decide on the level of response—whether to send a single ADP Troop Transport with a squad, or a full Mobile Unit with helicopter backup. The operator will then dispatch that unit. If it's an "officer needs assistance" call, the operator may simply check the location of the nearest unit and dispatch that without going through her supervisor.

In 2-4 minutes (40-80 phases): If any helicopters are available, usually 0-2 patrol choppers will arrive on scene. Depending on the situation, they may engage the target, provide assistance, or simply track it. Depending on the severity of the incident, either a single squad or a mobile field force is now on its way to the area. Other officers in the area may also converge. Also, any senior off-duty personnel assigned to that unit may be alerted (by pager watch) and dispatched to the incidents.



LEVELS OF RESPONSE

Threat	Personnel	Equipment
Non-combat boomer	ADP squad	One Troop Transporter
Combat boomers	Mobile Unit	2-5 troop transports, 0-2 combat choppers, 0-1 helicopter trucks
Battle boomers	Mobile Unit	As above, plus a good chance HQ will authorize heavy chopper or ADP transporter with extra troops or mecha.

In 5-8 minutes: The squad or mobile unit arrives on scene and engages the target. If the target is fast-moving (like a jet-equipped combat boomer on a rampage downtown) the unit will attempt to get into position to intercept it. AD Police frontline officers are most effective when out of their vehicles (they can't shoot from inside), so helicopters may be used to drive the target into a roadblock manned by AD Police.

Meanwhile, Normal Police or Highway Patrol officers will begin to seal off streets, setting up roadblocks or barricades to divert traffic away from the danger area. AD Police officers (often operator-grade) may be dispatched to assist the Highway Patrol in manning traffic checkpoints.

If the target is deemed especially dangerous (e.g., power-armored soldiers, battle boomers, lots of combat boomers), an ADP Transporter (*BGC* p. 125) loaded with an extra squad or mecha may be authorized to take off and provide additional support.

9-15 minutes: If necessary, further backup (a second unit, additional choppers) will be available—unless they're busy with incidents elsewhere in town. If previously authorized, an ADP Transporter may deploy whatever force it carries.

AD POLICE SECURITY

The AD Police headquarters has several levels of external and internal security. These include:

- **Police Officer:** A single police officer is stationed outside ADP headquarters at all times, with a second officer on duty inside the garage, manning a barricade. By 2034, these officers have been replaced by Guardian boomers (p. 81). Their main job is to give directions to visitors (civilian parking outside AD Police is not permitted, however).

- **ID Cards:** Officers and civilian subcontractors (mechanics, R&D, etc.) are assigned personal photo-ID cards. It's possible to get as far as the receptionist desk on the main floor without an ID. For instance, someone wanting to talk to an inspector would simply go in and ask the receptionist to buzz the inspector's office; if he vouched for the visitor, he could go on up. An AD Police officer can also bring a guest into the building with him to visit his office, for example.

- **Automatic Defenses:** These are detailed on pp.120-121 of *BGC*.

- **Data Security:** ADP's computers contain vast reams of information on private citizens and corporations. To protect their right to privacy, most data is secured by protection blocks which require the voice prints of senior officers—sometimes even the chief. However, a skilled hacker can defeat these (see "Hacking", *BGC* p. 60); having a digital recording of the senior officer or chief's voice gives a +4 bonus to skill.

- **Mobile Units:** If there are no boomer incidents or other major threats going in the city (fat chance!), ADP HQ may have as many as two hundred and fifty frontline officers, 20-30 armored vehicles, and a few dozen helicopters and powered suits ready to meet an intruder. However, usually only one or at most two mobile units are "in garage" waiting to go—more often, they are engaged in incidents scattered around the city. Typically, half the vehicles will be down for maintenance (with the frontline officers off duty and only technicians available); of the remaining units, half of them will be responding to incidents (often broken up into

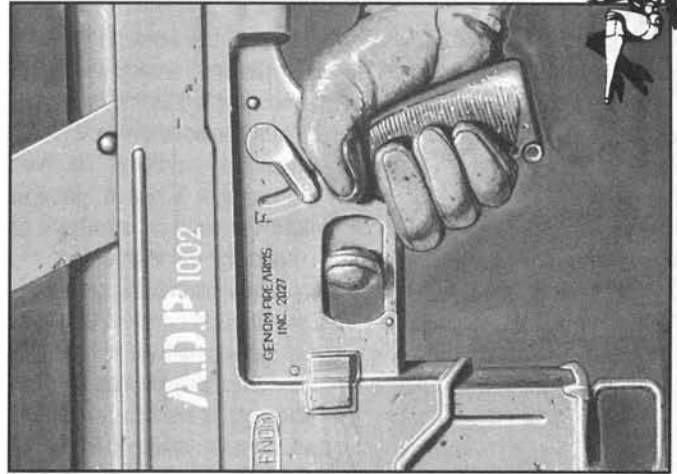

squad-size units dealing with minor boomer problems). This means that only about one-quarter (or less) of ADP's strength will be "on hand"—maybe less than that if two major incidents occur at once.

OTHER AD POLICE DUTIES

"Oh come on, it's too early in the morning to be having a riot."
— **Inspector Leon McNichol, 2032AD**

AD Police were originally founded to deal with the riots and disorder that followed the 2nd Great Kanto Earthquake. While boomer hunting has become their main function in the 2030's, they still handle civil disturbances and other "SWAT-type" cases.

- **RIOT CONTROL:** This involves sending officers to dangerous situations to *prevent* a riot, through a show of force or careful diplomacy. In the 2020's and 2030's, most riots are protesting corporate policies, and the AD Police sometimes finds itself caught between brutal corporate rent-a-cops (or boomers) and citizens. In theory, corporate security only has jurisdiction over corporate property and may be severely restricted in their ability to use lethal force. In practice, corporate boomers and rent-a-cops will do whatever they can get away with to punish rioters or trespassers if no one's watching—or if the police look the other way.

In the 2020's, the AD Police still have memories of the violence and disorder surrounding the Quake—looting, arson, and wanton vandalism—and of the casualties they suffered trying to contain it. Thus, they are likely to side with the corporates, and use more-than-justified force to squash demonstrators. By the 2030s, many AD Police officers are getting tired of being pawns of the business interests, and are willing to show more spine. Also, paranoid government or corporate officials sometimes order AD Police to disperse *peaceful* protests, resulting in them turning violent.

- **Labor Disputes:** The classic situation of striking workers vs. strike breakers—this can get ugly fast if the strike breakers are boomers! However, labor disputes are rare in MegaTokyo: By 2020, most big corporations have successfully destroyed unions, while the labor shortage means that there are more than enough well paying jobs for those who do want work.

- **Housing Disturbances:** These are citizens protesting the demolition of their homes to make room for new corporate facilities. Most of these are lower-class citizens who can't afford to move on, or simple squatters. The threat can include mobs threatening corporate wrecking crews, or residents who have barricaded (and maybe armed) themselves and who refuse to move out.

- **Other Riot Situations:** These include demonstrations outside embassies to protest a foreign government's policies, animal rights



protestors outside biolabs, rowdy fans at rock concerts or sporting events, antiwar rallies against Genom for manufacturing weapons or against Japan's support of Neo-NATO in the Polar War, and so on. Any of these can turn into a riot if someone overreacts. AD Police usually show restraint in these situations—while no one cares much if a group of low-life squatters are taught a lesson, political activists and rock concert fans are often the children of middle or upper class families. If you club down a teenage girl with a *Save the Whales!* t-shirt, and it turns out she was the maverick daughter of a Genom executive, you could be in real big trouble.

Manufactured Riots: Sometimes extremists will infiltrate a peaceful demonstration and attack police with hidden snipers, Molotov cocktail, or rock throwers. Their goal is to get the police to respond indiscriminately against the entire crowd, either to create martyrs and radicalize the movement, or to have the riot serve as cover for another criminal action. A skilled AD Police detective will be able to spot these agitators and quietly arrest them without provoking other demonstrators. This can involve deploying plainclothes officers into the crowd or searching surrounding buildings for snipers, etc. beforehand.

• **DIGNITARY PROTECTION:** AD Police are sometimes assigned to protect government, foreign, or corporate dignitaries in situations where there may be a threat of kidnaping, violent protest, or assassination. For example, if Genom executives are making a public speech, AD Police may be assigned to keep an eye on things, especially in an age in which attempted assassins may well be boomers themselves.

Usually the immediate "close protection" bodyguards will be from Normal Police, corporate agents, or another government agency, but AD Police will be nearby to provide well armed backup in case assassin boomers, armored vigilantes, snipers, or terrorists are involved. In some cases, AD Police officers will intervene to protect high-spirited citizens exercising their democratic rights to protest from overzealous corporate rent-a-cops or bodyguard boomers.

• **HEAVY ARREST:** This is a police term for a planned attempt to go in and arrest suspects who are believed to be well armed, possess armed bodyguards or be located in a fortified building—situations in which Normal Police would be at high risk of injury. These include attempts to arrest Yakuza or Triad leaders, drug kingpins, corporate bosses, arms smugglers, and criminals who are known or suspected to employ boomer bodyguards, such as a boomer fence or the owner of a boomer recycling plant.

Heavy arrests are usually made by a single AD Police squad or (if necessary) by a full mobile unit. A typical arrest occurs at dawn. Usually they are well planned, with a judge having approved search and arrest warrants in advance. AD Police will carefully study blueprints of the target building, and station snipers to cover entrances and exits.

• **TERRORIST, SNIPER, AND HOSTAGE SITUATIONS:** This is the classic "SWAT" situation. If the AD Police are storming a building where armed suspects are holed up, they will take the time to set up a command post, and place snipers, and heavy weapons in cover positions (often behind armored vehicles). They'll also find and interrogate witnesses to determine the perpetrators' numbers and resources, and download plans of the building. Barricades may be set up to keep out traffic and civilians evacuated, and the press kept at



arm's length. They may also send officers into positions where they can cut off power, water, or phone/data lines leading into the site. Emergency services (paramedics, firemen) should be called for to evacuate any casualties, deal with blazes or explosions, and so on.

A detective or inspector will attempt to negotiate with the hostages. While the AD Police won't let a criminal or terrorist go, they will attempt to trade small favors for release of hostages—e.g., agreeing to send in food, videos, etc., or possibly find friends or relatives to talk to the hostage-taker.

Unlike a heavy arrest situation (which depends on surprise) or a boomer incident (which is usually over very quickly), a terrorist or hostage drama can easily last hours or days. This means that news cameras will be on scene, and the inspector or detective in charge of the incident will be constantly second-guessed by the Monday-morning quarterbacking of the press, public, and his superiors, and any "higher-ups" in government or corporations. Success may put him on a fast track to promotion, but a bloody failure can send his career into the toilet.

A particularly dangerous complication can occur if the ADP are called in to deal with a terrorist attack on a big corporation like Genom or on government property. This could result in a confusing operation in which multiple groups (AD Police, corporate security, the Army, or even USSD) are all involved at once. Security forces may insist on taking over parts of the operation—e.g., assaults on "secret" areas. This sort of help can be welcome, but it can also be a nightmare for the AD Police officer running the show, particularly if any of the participants have secret orders or attempt to use the AD Police assault as diversionary (and expendable) "cover." Just this type of situation occurred in 2028, when terrorists seized Genom's old headquarters and a complex joint operation of this nature ensued.

• **CLEANUP:** After an incident, AD Police, Normal Police, and paramedics will secure the area to find any hidden perpetrators, injured victims, or dangerous materials (e.g., weapons, boomer parts, drugs, unexploded rockets, explosives, etc.). If these materials are not removed promptly, scavengers may easily pick up very dangerous parts—imagine a group of cyberpunks finding the blown-off head of a fusion-capable boomer and selling it to a recycling company! Cleanup after a boomer incident is complicated by the fact that a running battle can leave debris strewn over a few kilometers!

While cleanup is going on, the Normal Police are also responsible for contacting any evacuated citizens to inform them that the area is safe, while Highway Patrol will remove any barricades. The officer in charge will usually also make a statement for the press, and may have time to pose for a photograph—of course, if his unit's taken casualties or failed in its objective, a terse "no comment" is the best approach.

Back at HQ, reports must be filled out, casualties visited in hospital, and so on. There may or may not be a formal debriefing or informal critique following the incident—or if something went badly wrong, a face-to-face with the police chief and (possibly) a board of inquiry.

• **TRAFFIC DETAIL:** Due to manpower shortages at Normal Police, AD Police officers are sometimes assigned to assist Normal Police or the Highway Patrol in traffic control. This is considered a fate worse than death by a frontline officer, so it's often foisted on operators. All police are also expected to assist Highway Patrol in enforcing traffic regula-





tions, if they aren't busy doing something more important (like chasing boomers). To this end, every AD Police car is equipped with standard sensors that can estimate speed, as well as a small portable barricade.

• **PAPERWORK AND COURT APPEARANCES:** Even with computers, paperwork just seems to pile up. The ADP was deliberately organized to reduce the bureaucratic workload, but it still takes up a lot of time.

AD Police officers spend less time in court than Normal Police, as boomers don't get lawyers. However, sometimes an AD Police officer will arrest a human perpetrator. If so, he'll usually be called as a witness to a court case. Referees may wish to roleplay his cross-examination by defense lawyers, and base part of the conviction on how well he handled the arrest procedure—see *MegaTokyo Law* on BGC p. 116 for what is and is not due process in 21st century Japan.

Japanese court procedures do not involve an American-style judge and jury. Instead, criminal trials usually involve a panel of three judges, who come to a majority decision after hearing evidence presented by prosecution and defense lawyers. While there was a movement to give Japan a jury system in the late 20th and early 21st centuries, tradition and the need for swift justice following the Kanto 2 quake resulted in the judge-only system being retained. Corporations also prefer it: It's easier to bring influence to bear on a trio of judges (who may owe their appointments to corporate sponsors) than a panel of citizens.

▼ PRESSURE FROM UPSTAIRS

"You try dealing with officers like you who go wild every time there's a big case and see if you don't end up just like me! My head's on the chopping block all the time!"

— Chief Todo, AD2032

The AD Police were initially heavily funded by Genom and other corporations in an attempt to bring law and order to the urban landscape. Now the corps want their money's worth, and regularly lean on government officials to instruct the police chiefs to drop certain cases, or take on others.

If the police chief does not comply, he'll lose his job. This is simply influence peddling, and is done at such rarefied levels of power that there really isn't anything that can be done about it. Still, a lot depends on the individual police chief. Some chiefs are toadies, doing everything their masters tell them in the hopes of saving their pension.

A good police chief, like Chief Todo (BGC p.118) walks a fine line: He'll publicly order his men off cases or chew them out, but will privately back up trusted officers, sometimes giving them hints couched as warnings. Of course, if the officers screw up, the chief will have to discipline them—but if they catch the criminals, then the resulting good publicity from the media is often enough to get them off the hook.

▼ DEATH AND INJURY

"Dumb bastard! Why'd you have to get killed by some damn Boomer!"

—Frontline officer Jeena Malso, AD2027

This can really mess up the officer's day. An injured officer can expect good medical care and sick leave. In theory he's not supposed to come back to duty until he's well; in practice, AD Police is short enough on man power that if someone wants to be a hero, he can return to duty early.

• **Line of Duty Insurance:** All officers receive life insurance and disability pension sufficient to support themselves or their families in the event of death or crippling injury. However, loss of an arm, eye or leg

may not be enough to be invalidated out of the force. During the 2020's, AD Police insurance will pay for the basic (no enhancements) cybernetic parts to replace any missing body part, so that the officer can return to duty within a few weeks of his injury.

• **Dogtags:** AD Police officers wear these for the same reason that soldiers do: to make it easier to identify their corpses. A boomer packs nearly as much firepower as a tank, and sometimes the dogtag is all that's going to survive.



SYLIA'S AD POLICE REPORTS: THE EARLY FILES

Sylia Stingray closely monitored ADP operations in the 2020's, using the data gathered to assist in developing antiboomer combat tactics. Here are some excerpts from her personal case reports:

Mid-2027—ADP1, *Phantom Lady*: The ADP frontline officers suffer one dead while engaging a waitress boomer in hand-to-hand combat. The boomer is eventually destroyed by massed assault weapons fire, with considerable collateral damage. It appears the AD Police drastically underestimated the strength of a berserk civilian-model boomer.

Mid-2027—ADP1, *Phantom Lady*: ADP officer Leon McNichol is ambushed by a malfunctioning sexaroid. After McNichol is injured, officer Jeena Malso dispatches the sexaroid with a single shot from her police-issue handgun. It appears at least one officer in the ADP is capable of precision shooting.

Mid-2027—ADP2, *The Ripper*: AD Police engage a rogue "salariman boomer" illegally upgraded with combat boomer weaponry. In a combined operation involving heavily armed helicopters and frontline officers, AD Police successfully destroy the boomer. One officer is slightly hurt.

Mid-2027—ADP2, *The Ripper*: In cooperation with Normal Police, the AD Police stalk, trap, and terminate the boomeroid known as the "Ripper", with a masterful coordination of surveillance teams, heavily-armored frontline officers, and the new "Kumo" battlemover. Personal note: While effective, the ADP tactics show a disturbing disregard for civilian casualties.

Late-2027—ADP3, *The Man Who Bites His Tongue*: Over a period of weeks, boomer incidents increase in intensity, as ADP finds itself engaging a series of heavily armored combat boomers. The AD Police tests out its experimental antiboomer cyborg. The cyborg proves highly effective as a solo combat unit, but has difficulty coordinating with helicopters and officers. However, its behavior seems increasingly erratic. I hope the ADP knows what its doing.

Late-2027—ADP3, *The Man Who Bites His Tongue*: Tragically, it appears they did not. Their antiboomer cyborg went berserk, killing or injuring several technicians and officers. Luckily, AD Police were able to contain the incident within their HQ, or severe civilian casualties might have resulted as well. Unfortunately, the failure of their cyborg system has left me with serious doubts as to ADP's ability to face the boomer problem alone. It seems my course was well chosen. I pray that ADP can hold the line until my preparations are complete.

AD POLICE CAMPAIGNS

Bubblegum Crisis™ is a fusion of the cyberpunk, anime and superhero genres. In *AD Police*™, there aren't any superheroes—not for another five years. It's a world where technology can beget new crimes every day and where "Am I human?" is a question that can be a matter of life or death. Humans become machines—and can't handle it. Boomers become more human—and can't handle it. And it's ordinary cops on the street, people like Leon, Jeena and Iris—and you—who have to clean up the mess.

Some possible campaign backgrounds for 2027 include:

ON THE LINE: Perhaps the best type of campaign for 2027 is AD Police officers, but serving in a different squad than Jeena and Leon, perhaps with an associated Normal Police officer or a friendly crime reporter.

They'll operate in MegaTokyo, or another similar city with its own Advanced Police. *BGC* p. 154 gives a good general discussion on how to run AD Police games. The big difference in AD 2027 (besides no chance of being bailed out by the Knight Sabers!) is that playing an ordinary frontline officer is a much more viable role. First, the expected opponents are less heavily armed—you're much more likely to face mannequins, boomeroids, and human terrorists than you are combat boomers. For that reason, the officer with his body armor and assault rifle actually has a fighting chance! Second, the ADP in 2027 is still a fledgling organization, with limited manpower. There are fewer specialized detectives around, and by necessity frontline officers are often used in roles that would go to the higher-ranked inspectors or Investigations Section in 2032-4.

JEENA AND HER FRIENDS: If you like, you can play the main characters from the *AD Police* videos: Jeena, Leon, and maybe Dieork and Iris. The only difficulty is a shortage of "named" characters, although new ones could be added! If you've got only a pair of players, a Jeena/Leon team-up can be fun—or Jeena/Dieork in 2028-29, if you want to sidestep the problem killing Leon may have for continuity with *Bubblegum Crisis*!

KNIGHT SABERS OR BUBBLEGUM CROSSFIRE: Unless you want to go into alternate history territory, this isn't an option. In 2027, the Knight Sabers don't know each other, Sylia's still perfecting her father's designs, and no one else has any powered suits except the Army. As for the other Knight Sabers, Nene and Linna are leading relatively normal lives, while Priss was living in the orphanage and cutting classes to run with her biker gang. Playing a biker gang might be fun, though

OTHER CAMPAIGNS: Military, Space Cop, Corporate Weasel, and Media Virus campaigns are just as viable in 2027 as in 2032. Other cyberpunk campaigns are also possible. How about a team of freelance boomer repo men, who try to recover runaway or stolen cyberdroids for a bounty before the AD Police can terminate them?

FAST-TIME CAMPAIGNS: 2027-2032: Ambitious Referees may want to try a campaign that starts in 2027 and runs all the way to the decade of the Knight Sabers. It might be best to assume scenarios take place at three to five month intervals. This works well in a campaign where PC's are all AD Police officers, because there is no need to worry about what they're doing between adventures—they can be assumed to be busily training, handling minor incidents, or working at instructor or desk jobs. The advantage of a fast-time campaign is that it allows the Referee to emphasize the cyberpunk theme of "techno-shock" (*BGC* p. 154). As the

campaign accelerates toward the 2030's, the PC's can see the world change around them. They may clean up rioters, terrorists, Yakuza, and boomeroids, only to see Genom itself loom larger and larger, becoming the locus of more and more investigations, untouchable by the law. When the time comes, will they stay within ADP or take up Sylia's gauntlet and become outlaw vigilantes?

BOOM RUNNER 2027: A campaign where PC's play boomers (or a mix of boomers and boomeroids) fits the "What is human?" cyberpunk themes of *AD Police* like a glove. Hints on running a boomer-based game can be found on *BGC* p. 154. An interesting possibility is to mix boomers and boomeroids on a special Advanced Police (or Genom!) squad that hunts down *rogue* boomers. Referees and good

roleplayers should consider the ironic possibilities that boomers and boomeroids aren't the same. Boomers may start out cold and emotionless, but gradually grow more human, while the boomeroids struggle to retain their humanity as they become more machine-like. For a darker twist, how about playing Mason's team of boomer women? Or players may not know who "created" them—"the Agency" may be anyone from a Genom splinter group to Neo-NATO. Maybe they originally belonged to another group, but were salvaged and mind-wiped. Who knows?

▼ AD POLICE ADVENTURE HOOKS

Here are a half-dozen adventure outlines to get you started running an AD Police campaign. They are designed on the assumption that players will take frontline officers or inspectors, but with a few modifications are usable in the 2032-2034 era. For example, vigilantes may enter the fray when the AD Police fail to solve a particular case.





▼ PORT AUTHORITY

One of the players receives an anonymous tip from a Chinese-accented informer on his or her answering machine: Yakuza are loading stolen military weapons intended for smuggling to the Third World in a few hours. He names the ship (of Philippino registry) and the pier. The informer suggests the player's unit handle this themselves *without* telling the chief—"There are eyes in your chief's office." As the tip involves military weapons (a violation of armaments export laws), it is a job for AD Police.

Will the players go along with him, or suspect a trap? In fact, the tip is genuine; he's a dock worker who is secretly a Hou Bang agent. That Triad would rather the AD Police wiped out their rivals! The "Yakuza" spy in the chief's office is just a red herring (in this adventure, anyway)—the Hou Bang are simply afraid that any operation against the Yakuza may be called off by higher authorities in bed with the Japanese syndicate.

There isn't time for much investigation: It's early evening when the player gets the tip, and the ship sails tomorrow before dawn. If the PC's check out computer data on the pier and ship, they can confirm details of the freighter, which is actually a fast hydrofoil that is a surplus Israeli patrol vessel. It is supposedly loading Genom-manufactured farm machinery bound for Manila. Since Normal Police generally deal with the Yakuza and Triads, PC's may want to check sources there. There is no word on any unusual smuggling activity, but patrols have been *diverted* away from that wharf area—apparently the Police Ministry wants a big anti-drug sweep near Kawasaki City tonight. Suspicious? But do the Yakuza have that kind of pull? Maybe.

If the players decide to mount an "unauthorized" patrol of that area, they'll find the hydrofoil freighter, and discover the tipoff was right. The freighter and nearby warehouse are full of well armed Yakuza (rifles, some heavy weapons and labor boomers), frantically loading crates marked "Farm Machinery" into the ship. Someone tipped them off about a leak, and now they are planning a rapid departure! The "Farm Machinery" are really disassembled battle boomers bound for the nasty civil war raging in the Philippines. If attacked, the Yaks ashore will try to fight long enough for the ship to get out to sea, then scatter

But while the ADP are dealing with the situation—and maybe calling for backup—there's another twist. The reason Normal Police were called off was not because the Yakuza got to the Ministry. It was because Genom Security has traced the theft of boomers from its warehouse. As the ship tries to escape, a tilt-rotor will appear overhead, ejecting a pair of Genom combat boomers (BU-C-208's, perhaps). Their goal is to sink the ship (getting into its engine room and blowing the power plant) in order to destroy evidence that Genom was building battle boomers in Japan in the first place. Genom is mostly interested in taking out the Yakuza, but will engage any ADP who are in the way.

What if the PC's didn't listen to Hou Bang and attempted to get official authorization for the raid? Genom will be tipped off, and will arrange a "boomer incident" elsewhere in the city—the PC's can still make their raid, but they won't be able to call for backup—they're dealing with the other "manufactured" incident.

▼ ANIMAL HOUSE

BioDiscovery is a new bio-research company in the Kabuto area. An animal rights group, claiming that BioDiscovery is engaged in cruel animal experiments, has organized a noisy protest outside. Players will be summoned to protect the building—BioDiscovery is an important corporation, and this sort of demonstration can't be allowed to interfere with business! The players' instructions are to "protect the plant and prevent

a riot—and don't use excessive force: these are college students, not street scum."

The demonstration is taking place in the morning. Outside the BioDiscovery building, a hundred protestors (mostly university students) chant slogans and wave signs denouncing cruelty to experimental animals. A few leaders are using megaphones. Inside are a small number of besieged rent-a-cops, lab technicians, and scientists. BioDiscovery says it is testing organ transplant techniques on animals to help save human lives.

Referees can make the situation interesting by having someone notice that an ADP officer is involved with part of the crowd! The demonstrators want BioDiscovery to pledge to stop animal experiments. A few "Animal Freedom League" radicals are shouting to storm the plant and "free the tortured puppies", but most of the crowd are content to demonstrate loudly but peaceably. Players may be able to arrest the radicals—this will calm the situation down if they do it with minimum force (such as subduing them without weapons), otherwise it could inflame it. A TV crew is on the scene, with a news aerodyne overhead.

Soon after the ADP arrive, cars holding BioDiscovery lab workers arrive at the plant. They ask to be escorted in. If the PC's allow this, a pushing match will break out between BioDiscovery workers and sign-wielding protestors. If the players can break up both sides, or get BioDiscovery's techs to back off, things will calm down. If they overreact, a dozen demonstrators will attempt to overturn police vehicles, burn cars (there are several in the parking lot), toss rocks, and grapple with police.

If they've kept their heads, the players should be able to disperse or contain the demonstrators without too much trouble. The activists will gradually disperse by evening, but promise to return the next day. Players may be thanked by BioDiscovery. Later in the day, BioDiscovery's parent corporation will install electric fencing and signs saying "Danger: 50,000 volts!"

PC's may become interested in what BioDiscovery is working on. BioDiscovery is rather paranoid about its research, but persistent cops may be able to bully or charm their way into the labs, or use Hacking skill to dig up information.

It turns out the corporation is operating on a research grant from Genom to investigate effects of boomer syndrome. It is using chimps, monkeys, and dogs, extensively replacing their body parts with cybernetics and subjecting them to various stress tests. There is nothing illegal about BioDiscovery's activities—it has proper research permits. However, the lab has a high "yuckiness factor"—puppies on dissection tables, animal brains connected to life support systems, a decapitated monkey head in a life support jar whose eyes follow a visitor, cages of boomeroid dogs howling and frothing at the mouth, a cyborg chimp with metal arms and cables running out of its head. Many of the animals have gone insane. The scientists believe that their results prove boomer syndrome is more dangerous than most people (in 2027) think—in their minds, they are doing a public service, since they expect this data will lead to a reevaluation of boomer laws and more restrictions on cybernetics implantation.

However, the situation isn't over yet. If the players are smart, they won't trust the BioDiscovery electric fence, and will still be watching the facility. Late at night, Animal Freedom League radicals will arrive and crash a truck through the electric fence. The truck will skid out of control and hit a generator on the side of the building, cutting a power supply. A dozen radicals will smash into the building. A melee with security guards will follow. The activists will break into the lab, attempt to rescue the surviving animals, and trash the place. They have improvised



Molotov cocktails, axes, and crowbars. At the same time, a stolen aerodyne painted in Network News colors will land on the ceiling of the laboratory, releasing a second team of activists, who will break in through upper story windows.

Unfortunately, by smashing their way into the lab, the AFL activists will accidentally release the animals. Bad move. The berserk, boomeroid animals attack the skeleton late-night lab staff, activists, and the security guards. The players shouldn't be able to stop the break-in itself, but if they are on site, they'll be able to contain some of the violence and save a lot of lives. The boomeroid chimps are similar in capabilities to generic labor boomers; for the enhanced dogs, use the stats of the K-9 dog on p. 110 but with a 5D6 killing bite and SDP 10. If they left the facility unprotected, some of the boomeroid animals will be inside hunting down trapped lab workers and activists, while others will have got out, leading to future scenarios. Maybe an escaped boomeroid hound will be found leading a pack of normal wild dogs, terrorizing (and devouring) street people! For an extra twist, some of the boomeroid animals may have had *augmented intelligence* and have their own agenda

▼ INCIDENT AT ABASHIRI

As part of a program to secure a bid for the next Olympic Games, the Diet (with Genom support) has passed a series of laws aimed at deterring street crime and simultaneously dealing with the organ shortage. Those prisoners on death row at Abashiri Prison are now to be broken down for organs. The medical transplant equipment for doing so has been installed in the maximum security hospital wing of Abashiri Prison (located in Hokkaido).

The legislation has already had some effect. Several members of the Tokyo People's Liberation League (a left-wing terrorist organization "fighting to save MegaTokyo from Genom") are being held in Abashiri. Knowing he faces execution, one member has offered to turn states' evidence, revealing important information about the terrorist group's free members, in return for a deal. Since AD Police are involved in counterterrorism, some of the players are sent as members of the team to interrogate him.

However, while the PC's are cloistered with the prisoner in an interrogation room, a riot breaks out! Other prisoners are also upset with the new legislation—using a fake weapon, one of the prisoners was able to subdue a guard and take hostages. A computer bug in the prison's new electronic security system frees several dozen convicts. They take many guards hostage and barricade themselves in one wing of the prison, and occupy the prison hospital. Then they threaten to use the organ transplant gear to start "breaking down" the guards and known informers until their demands are met—the PC's will hear these demands over their radios. Another group of inmates are actively hunting through the building looking for other victims. The players are trapped "behind enemy lines" and, from frantic calls on the PA system and police radio net, should be aware that if they simply hunker down and wait for rescue, several innocent guards will die before a planned assault can be readied. Maybe they can disguise themselves as prisoners, help rescue the guards, or coordinate things with a rescue team. Their prisoner may be willing to help the players sneak about the prison—he knows his way around, but can they trust him?

▼ IF THINE EYE OFFENDS THEE

The players observe Inspector Slater, an AD Police detective from Investigations, in a bad temper. Mio, a cute data operator, notices the players watching and explains Slater's unit has been chasing the

Zhupanova Faction for several weeks. A Russian Mafia group, they import cheap Russian cybernetics for sale to implant clinics; the low-grade parts (often from recycled agricultural boomers) have resulted in an increase in boomer syndrome. Slater is upset because he's had many tips—no one's protecting Russian mobsters—but whenever he's arranged a raid, they've found only empty warehouses, or their informers turn up dead. It's frustrating!

Late at night, the players are summoned. An NP officer spotted a suspected Zhupanova Faction member entering a warehouse near the airport. The players' unit is to assist Slater. When the PC's are en route to the scene, Mio tells them that Slater's squad is already in the warehouse—he's too impatient to wait. As the PC's arrive, they see an explosion and fire! Slater's squad is caught inside! There's no time for fire services to arrive, so the players must perform an impromptu rescue.

With Slater dead or hospitalized, the PC's are transferred to handle the case. Examination of the rubble shows that Zhupanova members were there, but slipped out through a basement door into the sewers a few minutes before the raid, leaving behind a bomb and several crates marked "Tractor Parts" that contained cyberware. But what tipped them off? Sweeping ADP HQ for bugs and polygraphing officers will turn up nothing—but may annoy lots of people! ADP encrypts its communications security codes every few days, making it hard to "listen in."

If the officers look into communications security, they will find that one of the officers in charge of setting up the codes is Mio. She is perfectly innocent—but checking her background reveals she had one eye replaced a few weeks ago (to correct failing vision). If the PC's investigate, they will find Mio chose it because the clinic offered very cheap rates. In fact, the doctor was buying black market bionics from the Zhupanova Gang. When Mio's doc found out his client was an ADP operator, he implanted an eye which activates whenever Mio is using a computer screen—it records what she's working on. Then whenever she makes a call out from ADP, it "piggybacks" on the signal line to transmit the data to the Zhupanova mob. If the players make the connection, they can plug the leak and raid that clinic—or maybe send out false data to trap Zhupanova!

▼ MOONLIGHTING

AD Police are called in to investigate a series of brutal nighttime execution-style murders in Timex City (the Outer District, from *BGC* p. 148). The deaths are of street kids, prostitutes, and cyberpunks, all gunned down by military-style weapons.

The PC's' squad will be assigned to the case. However, Normal Police cooperation is noticeable by its absence—no one really cares what happens to these people. The atmosphere in Timex City is also antipolice, thanks to the lack of protection: If our heroes start wandering around heavily armed at night, they might be mistaken for the killers! Investigation of the area will turn up a few scared kids or winos as witnesses. They report a dozen or so men in black fatigues and ski masks and who use assault rifles and motorcycles.

The killers are actually a group of rogue AD Police officers from a different unit! They are moonlighting as a commando squad, paid for and supplied by a few senior businessmen in the Tokyo Merchants Association. There are plans to build a new shopping plaza in the Outer District, and that requires a "clean-up."

The players can get several clues to what is happening. First off, if they try staking out or patrolling areas, they won't run into anyone. As the commandoes are also ADP, they'll know when the PC's draw equipment and leave the squad room, and be tipped off. However, the



players can have lots of interesting and dangerous encounters in the Outer District itself—weird cultists, scared street gangers, prostitutes who turn out to be cyborgs or boomers, and so on, keeping their nights interesting! In order to succeed on a stake-out, they'll have to do it without the commandos' knowledge. A stake-out will be most effective if planned by off-duty PC's disguised as punks.

The first time a stake-out succeeds, the Referee should probably just have the players arrive "a moment too late"—a few potshots exchanged, the rescue of a wounded Outer District denizen, and black motorcycles escape into the night.

With trouble breathing down their necks, the outlaw officers may decide to "warn off" the players. Since *they* know who their fellow officers are, they could plant a bomb in one of the PC's' apartments (just big enough to injure) or send some masked figures to beat him up near his home while saying, "Stay off the case." Naturally this won't work—will it? The final moment in the case will come when the PC's down one of the "black cyclists", rip the mask of a face, and reveal a brother officer. Will the players accept the excuse of, "We were just cleaning up scum?"

▼ DIGITAL GHOSTS

One of the players (or perhaps a Nene-type ADP operator such as Mio) is playing a new state-of-the-art virtual-reality arcade game called *Mecha Inferno* at the local Game Center. Upon reaching the ultimate level, they have a shock: The face of the "boss" enemy mecha pilot is a dead ringer for Ami Yamada, a classmate or friend from school or work—whom the player thought died in the Great Kanto Quake in 2025. This is spooky! What's going on?

Research at the Game Center will reveal the game is a new one, purchased from Phoenix Electronics, an up-and-coming computer company that offers cutting-edge virtual-reality games at rock bottom prices. If they play more Phoenix video games they'll find two others in which different sprites or bosses resemble Ami. There is no legal case against Phoenix, but something suspicious seems to be going on. Will the player be able to use ADP resources to find what is happening?

Phoenix is based in Kawasaki (an industrial city that has now merged with MegaTokyo). Making arcade games is just one facet of the company—they also design military simulators for Neo-NATO, USSD, and JSDF. To the public, they offer the usual blend of PR hype and secrecy that characterizes corporations, especially those involved in defense work. They have a public office building, as well as a "secure lab" facility where defense work is developed. Could another old friend of Ami's be working there, inserting her image into computer games? The public lists of employees available show no names that ring a bell.

However, the research reveals one of Phoenix's top scientists is one Dr. Murgan. According to his biography, his previous work was at the defunct Wiz Laboratories—Dr. Stingray's company! A possible source for more details on Wiz and Murgan are Stingray's surviving

assistants, Drs. Haynes and Yuri. Yuri won't give anyone the time of day unless it's a megayen consulting project, but gentle Dr. Haynes is always willing to reminisce about his days with Dr. Stingray. He recalls Murgan as an abrasive but brilliant researcher who had many arguments with Dr. Stingray. The cause of strife was a pet project called a "biogestalt computer" which Dr. Stingray discovered him using company time to work on. Dr. Haynes doesn't know the details, but when Murgan refused to stop work on it, Dr. Stingray fired him. No open scientific literature exists on "biogestalt computers." Official inquiries run into denials and security; if the PC's attract the notice of the company, they will contact the police department and "put pressure" on the chief to muzzle the nosy cops snooping around—as Phoenix is involved in JSDF and USSD business, it's the brick wall of "National Security."

Checking details of Ami's death may be more fruitful. The National Family Register reveals she died of injuries after being evacuated from the quake area to a hospital in Kawasaki. Her family were also dead, leaving no surviving relatives. If the players dig deeper (visiting the hospital) they can find a doctor who treated her. He recalls Ami Yamada's injuries, though paralyzing, were not fatal—she was supposed to be transferred somewhere for outpatient care. Checking

of hospital records will show Ami wasn't alone: A half-dozen other paralyzed or comatose patients without surviving relatives have also vanished into bureaucratic limbo! Method and opportunity suggest that one of the data entry clerks may be the culprit; motive may even be provided by his addiction to gambling at illegal "boomer fights" sponsored by the local yakuza

If captured (with perhaps a raid to shut down an illegal "boomer boxing match" thrown in), the clerk will admit to having delivered the miss-

ing patients—alive—to an organ bank, reprogramming some of the hospital boomers. In the hopes of a lighter sentence he admits the organ bank is still operating and reveals its location. A raid will turn up evidence that one of the major clients of the organ bank is Phoenix Electronics. But they weren't buying hearts or lungs—they were purchasing brains.

The secret lies in the sealed "black lab" of Phoenix Electronics: Dr. Murgan's *biogestalt computer*. It's a biomechanical hookup that uses live human brains as its processing system. Phoenix Electronics has been using the biocomputer to design the complex software in both their military simulations *and* their state-of-the-art arcade games. While most of the brains have been submerged in the gestalt, Ami's independent spirit has survived integration into the computer, and she is calling for help in the only way she knows how: by manipulating the animation of the video games the biocomputer is designing to signal that something is very wrong.

Will the ADP officers challenge the corporate power to get to the bottom of the mystery—and perhaps cross the line between "police officer" and "vigilante?" Or will this be one case that they decide to drop, leaving Ami's mind—and those of the other victims—ghosts trapped forever in the machine?

Boomers tend to die messily...



ADP CHARACTERS



▼LEON MCNICHOL

AGE: 20. HEIGHT: 195cm

Leon joined the Normal Police right after high school. Once, while out on the streets, he found himself faced with a rogue female boomer. He destroyed it, but was shaken by the experience. Afterward, he volunteered for the AD Police's Frontline Officers, and was assigned to the 2nd Detachment, 3rd Squad. He badly flubbed his first few missions, but was taken under the wing of Jeena Malso; with her tutoring he rapidly matured into a capable officer with strong leadership potential. During this period Leon retained good relations with the Normal Police, and worked on at least two major joint operations. On one he met Iris Cara, and began dating her.

NOTES

In 2027, Leon is more serious and less self-confident than he would later become. He models himself after the more experienced Jeena, gradually adopting her habits of reckless driving, steady marksmanship, love of big guns and unfazeable attitude. While close friends, they never become lovers: Jeena's bionic arm reminds him too much of a certain female boomer

LEON

AGE		20		JOB		ADP Frontline Officer			
INT	5	PRE	6	WILL	7	TECH	4	MOVE	6
REF	8	DEX	8	STR	6	CON	6	BODY	8
LUCK	13	MAX	400kg	LIFT	200kg	CAR	100kg	THRW	70m
PNCH	6D6	KICK	7D6	RUN	18m	LEAP	3m	SWIM	6m
STUN	40	SD	-12	HITS	40	RCVR	12	RES	21

SKILL	LVL	SKILL	LVL	OPTIONS	LVL
PERCEPTION*	+5	HAND-TO-HAND	+4	MEMBERSHIP:	
CONCENTRATION*	+4	FIREARMS	+6	AD POLICE	3
EDUCATION*	+3	AUTOFIRE	+5		
PERSUASION*	+5	HEAVY WEAPONS	+4		
SOCIAL*	+2	DRIVING	+5		
LOCAL KNOWLEDGE*	+6	RESEARCH	+3		
TEACHING*	+2	DETECTIVE	+4		
ATHLETICS*	+4				
WARDROBE & STYLE	+3				
ATHLETICS	+5				
MELEE	+4				

EQUIPMENT: Motorcycle, Magnum Revolver, casual clothes with ADP-issue bulletproof vest (KD10) or motorcycling leathers (KD5), shades, average lifestyle (modest apartment).



JEENA

AGE	24		JOB	ADP Frontline Officer					
INT	5	PRE	7	WILL	8	TECH	3	MOVE	6
REF	8	DEX	8	STR	5 (7/10)	CON	8	BODY	7
LUCK	13	MAX	400kg	LIFT	200kg	CAR	100kg	THRW	50m
PNCH	6D6	KICK	6D6	RUN	18m	LEAP	3m	SWIM	6m
STUN	35	SD	-16	HITS	35	RCVR	13	RES	24

SKILL	LVL	SKILL	LVL	OPTIONS	LVL
PERCEPTION*	+5	FIREARMS	+8	MEMBERSHIP	
CONCENTRATION*	+4	HEAVY WEAPONS	+7	AD POLICE	3
EDUCATION*	+3	DRIVING	+7	BEAUTIFUL	1
PERSUASION*	+5	DETECTIVE	+5	COMBAT SENSE	+3
SOCIAL*	+5	RESEARCH	+3	LECHEROUS	-3
LOCAL KNOWLEDGE*	+3	WARDROBE & STYLE	+3		
TEACHING*	+2	COMPUTERS	+4		
ATHLETICS*	+7	HACKING	+3		
WARDROBE & STYLE	+3	STEALTH	+3		
HAND-TO-HAND	+7			HUMANITY	56.5
MELEE	+5			SOCIAL ROLLS	-3

EQUIPMENT: Handgun, sports car, casual clothes, ADP fatigues (KD10) or full Frontline equipment (p34), Average Lifestyle (modest apt).

CYBERNETICS: Cyberarm w/ Wire-Fingers (Boomerware; in late 2027, Jeena adopts a Real-Skin covering for this arm).

▼ JEENA MALSO

AGE: 24. HEIGHT: 205cm

Jeena started out in Normal Police, but was attracted by the intense nature of the ADP and quickly transferred. Early on in her career, a solo boomer-hunt (always unwise, but she couldn't resist the adrenaline rush) cost Jeena her right arm. Morosely, she chose to have the boomer's own right arm grafted onto her body as a replacement. Afterwards, she lived for a time with fellow officer Billy Fanward until his death in the line of duty. In 2027, she took a shine to the rookie Leon and proceeded to teach him the ropes.

They formed an effective team, handling a number of cases, including the final termination of Billy. Though he had been revived as a cyborg, he quickly succumbed to boomer syndrome, something Jeena feared herself. Billy's second death served as a catharsis, and by 2028 she was back to her perky self—just in time to be taken hostage by anti-Genom terrorists led by her college boyfriend Max. Jeena ingeniously turned the tables on them, but lost her boomer arm: Leon shot it off to save her from a fusion capable boomer that had merged with it.

NOTES

Jeena is energetic, passionate, impulsive, and cheerful. She has a tomboy's fashion sense, preferring t-shirts, jackets and jeans. On the job, she's a tricky, ruthless fighter, a perfect shot, and a reckless driver—all traits Leon picks up. She also flirts shamelessly with anyone she thinks is cute. After a bloody battle, she likes to find a lover to burn off her tension with.

There's no sign of Jeena in the 2030's. Maybe she's dead, or perhaps she retired when her cyberarm was wrecked—it's unlikely she'd want a second one. If so, Jeena's police skills and love of action means she's probably working somewhere as a private eye or security consultant. Beware the one-armed lady



▼ COMMANDER DIEORK

AGE: 42. HEIGHT: 215cm

Dieork is the commander of the ADP Frontline Officer's 2nd Detachment. He's married, but the stress of police work put a strain on the relationship, and he is now separated from his wife. He seems to live only for his job.

NOTES

Dieork is a gruff person with little patience with anyone who isn't a cop, whether a restaurant owner or a general in the USSD. To his subordinates, he's a stern disciplinarian, and woe betide anyone who disobeys orders! Nevertheless, he looks after his troops, and they respect him. Dieork shuns fast cars and fancy clothes, and doesn't wear plain clothes—he's more at home in combat fatigues or tactical armor. His fate in the 2030s is unknown—he isn't the kind of guy to take a desk job; it's a good bet he either retired with disability or was killed in the line of duty.

DIEORK

INT	4	PRE	5	WILL	6	TECH	5	MOVE	5
REF	6	DEX	5	STR	6	CON	6	BODY	8
LUCK	11	MAX	200kg	LIFT	100kg	CAR	50kg	THRW	60m
PNCH	6D6	KICK	7D6	RUN	15m	LEAP	2.5m	SWIM	5m
STUN	40	SD	-12	HITS	40	RCVR	12	RES	18
SKILL		LVL	SKILL		LVL	SKILL		LVL	
PERCEPTION*		+6	SOCIAL*		+4	LEADERSHIP		+7	
CONCENTRATION*		+3	LOCAL*		+6	FIREARMS		+6	
EDUCATION*		+3	TEACH*		+3	AUTOFIRE		+5	
PERSUASION*		+7	ATHLETICS*		+5	MELEE		+5	

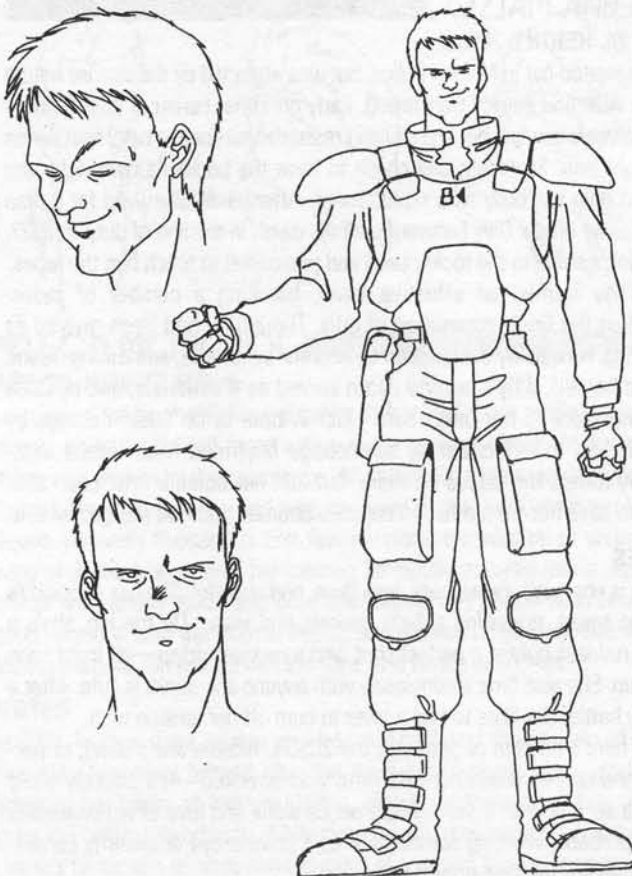

▼ ALUS

Deceased 2027.

Alus is typical of veteran AD Police officers. He joined the force soon after it was established. He was assigned to its 2nd detachment, 3rd squad, becoming a close friend (and occasional sexual partner) of Jeena. His signature weapon was a garotte, which he used to bind Boomers, but he was killed by a boomer in 2027, ironically while responding to an incident at a Chinese teashop he enjoyed frequenting when off-duty.

NOTES

Alus recognized the risks of AD Police service: He took out a big second life insurance policy (700,000,000 yen) to make sure his loved ones were provided for, shouldering a heavy debt load to manage the payments on his officer's salary.

ALUS

INT	3	PRE	4	WILL	6	TECH	4	MOVE	5
REF	6	DEX	5	STR	5	CON	6	BODY	6
LUCK	9	MAX	200kg	LIFT	100kg	CAR	50kg	THRW	50m
PNCH	5D6	KICK	6D6	RUN	15m	LEAP	2.5m	SWIM	5m
STUN	30	SD	-12	HITS	30	RCVR	12	RES	18
SKILL		LVL	SKILL		LVL	SKILL		LVL	
PERCEPTION*		+4	SOCIAL*		+2	HAND-TO-HAND		+5	
CONCENTRATION*		+2	LOCAL*		+4	FIREARMS		+5	
EDUCATION*		+2	TEACH*		+2	AUTOFIRE		+5	
PERSUASION*		+3	ATHLETICS*		+5	MELEE		+5	



▼ IRIS CARA

AGE: 20's

Iris is a gentle but strong-willed and idealistic Normal Police detective. Her hard work and self-initiative, compared to many officers who are happy to let the ADP do all the work, led to her rapid promotion to detective rank. Until recently she had spent little time on the mean streets. As a result, Iris has a certain innocence. Despite this, she is a good detective, and in 2027 was the first to connect Caroline Evers with the "Ripper."

NOTES

Iris is proud of being a member of Normal Police. At first she disdained ADP for its gangbuster approach to crime solving. After Leon saved her life, they began a romance that lasted into 2028 (much to Jeena's disgust). Iris' main weakness—and her greatest strength—is a strong sense of empathy for both criminals and victims. One of her eyes is artificial, but has no special abilities.

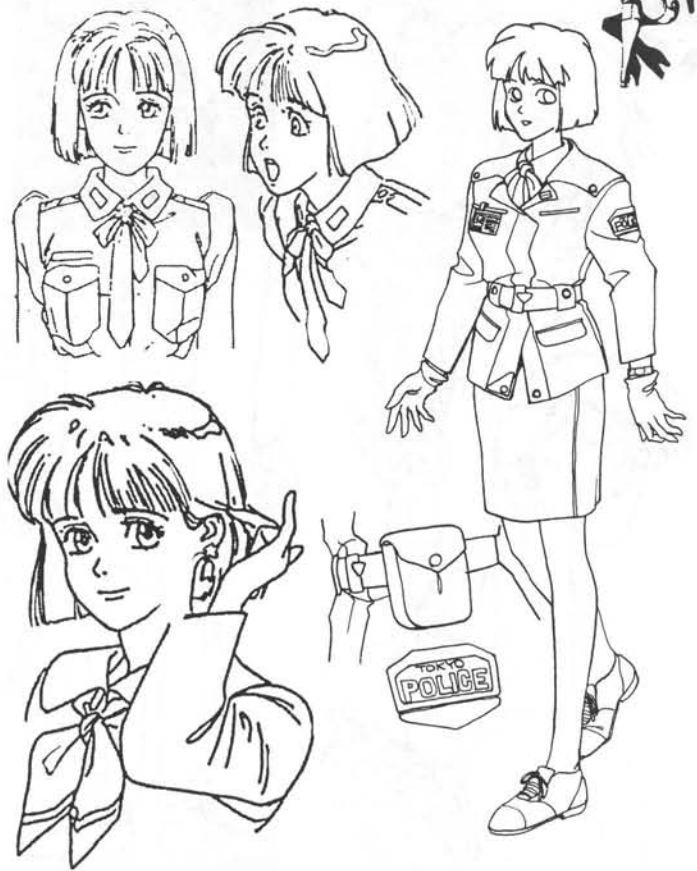

IRIS

INT	5	PRE	4	WILL	4	TECH	4	MOVE	4
REF	4	DEX	4	STR	2	CON	3	BODY	2
LUCK	10	MAX	72kg	LIFT	36kg	CAR	18kg	THRW	20m
PNCH	2D6	KICK	3D6	RUN	12m	LEAP	2m	SWIM	4m
STUN	10	SD	-6	HITS	10	RCVR	6	RES	12
SKILL	LVL	SKILL	LVL	SKILL	LVL				
PERCEPTION*	+7	SOCIAL*	+6	FIREARMS	+1				
CONCENTRATION*	+4	LOCAL*	+3	RESEARCH	+4				
EDUCATION*	+4	TEACH*	+3	DETECTIVE	+4				
PERSUASION*	+7	ATHLETICS*	+4	WARDROBE & STYLE	+3				

▼ VANESSA BAKKE

AGE: 20's.

Vanessa is a young Normal Police detective. She's Iris' partner and best friend, and worked with her on the Ripper case. She is a natural beauty and a follower of fashion—she buys 100% into the current trend that cybernetics are the answer to every physical problem. In fact, her pinky finger is artificial (not that you can tell).

NOTES

While a competent officer and good at digging up information, Vanessa is more worldly-wise than Iris and considers Normal Police a job rather than a vocation. If she can help it, she'd rather loaf or shop than work late on a stake-out.

VANESSA

INT	5	PRE	5	WILL	4	TECH	4	MOVE	4
REF	4	DEX	4	STR	2	CON	4	BODY	2
LUCK	8	MAX	72kg	LIFT	36kg	CAR	18kg	THRW	20m
PNCH	2D6	KICK	3D6	RUN	12m	LEAP	2m	SWIM	4m
STUN	10	SD	-8	HITS	10	RCVR	12	RES	12
SKILL	LVL	SKILL	LVL	SKILL	LVL				
PERCEPTION*	+4	SOCIAL*	+6	FIREARMS	+2				
CONCENTRATION*	+3	LOCAL*	+4	RESEARCH	+5				
EDUCATION*	+4	TEACH*	+3	DETECTIVE	+4				
PERSUASION*	+5	ATHLETICS*	+4	WARDROBE & STYLE	+4				





▼TAX INSPECTOR SAEKI

AGE: 30-something. HEIGHT: 160cm

This soft-spoken, slightly oily man's job is to uncover fraud in big insurance claims—for example, discovering if someone who collected a big insurance policy was a suicide, had burned their own business, or whatever. As crimes and boomer rampages result in many insurance claims, the ADP may find Saeki nosing around the aftermath of any tragedy, making life miserable for the victim's survivors. However, if there is fraud involved, he may well turn up some clues they have missed.

NOTES: Saeki will always try to dig up as much "dirt" as possible to cast doubt on any claim, in order to ensure that the company has to pay the minimum possible. However, he's honest enough that if he has proof of a legitimate claim, he may change his mind.

CYBERNETICS: Right Cyberarm (*note change to STR), Flex-Cords.

SAEKI

INT	5	PRE	4	WILL	4	TECH	3	MOVE	3
REF	2	DEX	3	STR	2/4*	CON	3	BODY	2
LUCK	7	MAX	72kg	LIFT	36kg	CAR	18kg	THRW	30m
PNCH	3D6	KICK	3D6	RUN	9m	LEAP	1.5m	SWIM	3m
STUN	10	SD	-6	HITS	10	RCVR	12	RES	12
SKILL		LVL	SKILL		LVL	SKILL		LVL	
PERCEPTION*		+4	SOCIAL*		+6	LAW		+4	
CONCENTRATION*		+4	LOCAL*		+4	RESEARCH		+5	
EDUCATION*		+5	TEACH*		+3	DETECTIVE		+3	
PERSUASION*		+6	ATHLETICS*		+2	BUSINESS		+5	

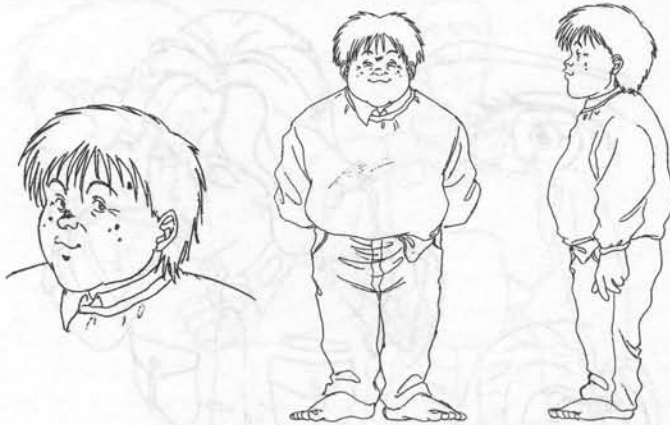

▼HACKER

AGE: 20-something. HEIGHT: 150cm

Beneath an old Shinto shrine in a back alley is a messy basement packed with knick-knacks and adorned with anime posters. This is the home of an overweight computer otaku who has few social graces, but is an excellent hacker and is willing to rent out his services. One of his specialities is cracking into criminal databases—sure it's dangerous, but it's a lot more juicy than boring old corporate files. One of his occasional clients is Jeena Malso, who has used him to dig up information on criminal boomer recycling. He doesn't mind working for cops, provided they don't spread it around. Or maybe he was caught at an illegal hack, and now he owes the police some favors . . .

IMPORTANT STATS

INT 6, PRE 1, WILL 3, TECH 6, MOVE 1, REF 3, DEX 1, STR 2, CON 1, BOD 5. Computers +6, Research +6, Hacking +7, Computer Language +7.

▼DR. YOOKO TAKAGI

This brilliant cyberneticist pioneered the process of full-body replacement, and her first test subject was the late ADP frontline officer Billy Fanward. She was authorized to field-test her "invention" under real-life combat conditions and was given a laboratory in the basement of the ADP headquarters, where she and her assistant Dr. Manabe could observe Billy's performance. Attractive in an everyday sort of way, Dr. Takagi had a fetish for her metal man—turned on by her cyborg creation, she attempted to alleviate Billy's sensory deprivation by using him as a sex toy. However, her only real interest in Billy was to make a name for herself, and her sexual teasing (combined with the DA-27 she administered to him) led to her bloody death at Billy's hands.

IMPORTANT STATS

INT 8, PRE 3, WILL 4, TECH 7, MOVE 3, REF 4, DEX 3, STR 2, CON 3, BOD 2. Education +7, High Tech +5, MilSpec Tech +6, Supertech +8.





THE RIPPER

AGE	30s		JOB	Executive (Serial Killer)					
INT	5	PRE	9	WILL	6	TECH	3	MOVE	5/12
REF	4	DEX	5	STR	3 (6/10)	CON	5/10	BODY	4
LUCK	9	MAX	100kg	LIFT	50kg	CAR	25kg	THRW	30m
PNCH	4D6	KICK	5D6	RUN	15m	LEAP	6m	SWIM	5m
STUN	20	SD	-20	HITS	20	RCVR	13	RES	15

SKILL	LVL	SKILL	LVL	OPTIONS	LVL
PERCEPTION*	+4	BUSINESS	+9	HIGH PAIN THRESH.	
CONCENTRATION*	+4	DRIVING	+2	MEMBERSHIP.	
EDUCATION*	+6	RESEARCH	+3	GREEN CORP	10
PERSUASION*	+4	STREETWISE	+5	OBSSESSED:	
SOCIAL*	+6			KILL PROSTITUTES	(15)
LOCAL KNOWLEDGE*	+5				
TEACHING*	+2				
ATHLETICS*	+4				
WARDROBE & STYLE	+6				
HAND-TO-HAND	+3			HUMANITY	-9
MELEE	+4			SOCIAL ROLLS	-6

EQUIPMENT: Ripperknife (laser-enhanced blade, DC8). Wealth level 10 (earns 1.2 billion ¥/year after taxes), luxury condo.

CYBERNETICS: Cyber-Womb, Major Organ Replacement, Cyber-Optics with Night Vision, 4 Boomerware Cyberlimbs with Realskin.

▼ CAROLINE EVERS, AKA THE RIPPER

AGE: 30's. Terminated in 2027.

Five years ago, Caroline Evers was competing for a promotion in Green Corporation (*BGC* p. 58). She lost when her male rival graphed her menstrual cycle against her productivity, convincing her boss she was unsuitable. Humiliated, Evers completely removed all womanly functions by replacing her womb and uterus with cybernetic parts. A driven woman, it only took her three more years for her to rise to company president. In early 2027, the man who had stolen her promotion came to her, unemployed, and asked for a job. She made him her husband.

Then tragedy struck. Caroline began to experience phantom menstrual pains in her cyborg parts. Attempting to stop them, she had more and more of her body replaced. At the same time, she discovered that her husband was seeing a prostitute. Confronted, he claimed Caroline was not a "real woman" any more. That was too much for her. She murdered him, then used her corporate resources to cover it up. But she had gone over the edge. She began to experience blackouts, seizures and episodes of murderous rage. Afterward Caroline would find herself holding a bloody knife over the body of a murdered prostitute. She tried to get help at the Cybernetics Bank, but they claimed her operation was too extensive to reverse. By that time a joint ADP and Normal Police task force was on "the Ripper's" trail. After a chance meeting, Detective Iris Cara fingered her as a suspect. Declared a "Boomeroid" under new legislation, Caroline Evers was hunted down and destroyed by the ADP.

NOTES:

Caroline suffered from these boomer syndrome symptoms: phantom pains, biochip distortion (seizures), sociopathy (irrational desire to kill) and cybermorphism.

ADP EQUIPMENT

**ADP
FRONTLINE
OFFICER
ARMOR
(2027)**

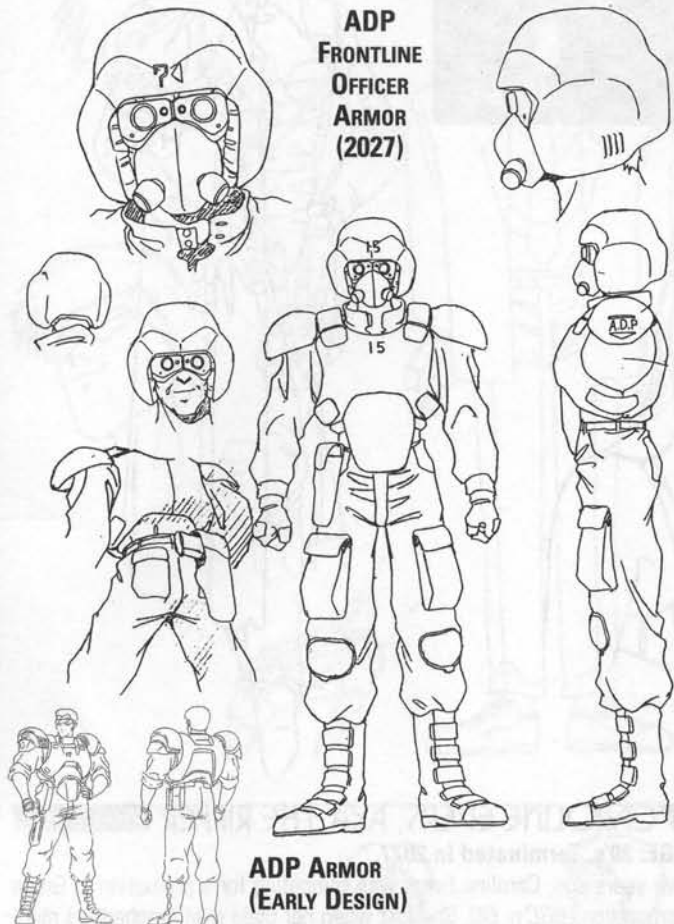

**ADP ARMOR
(EARLY DESIGN)**

▼ADP FRONTLINE OFFICERS' GEAR

In 2027 the ADP's status as an anti-boomer force is still relatively new, so their military origins are even more obvious than in the 2030's; their vehicles are painted olive drab, and their uniforms sport tans and greens over the blues and grays that will become standard in the 2030's.

In the 2020s, the ADP's armor bears no ID plate, and their entire kit is lighter than it will be in the 2030s (once the expectation of long field marches is dropped). Each officer wears fatigues beneath a ceramic body shell. The officer's ID number appears on the chestplate and helmet, which houses a gasmask, IR goggles, and a radio. As this armor was primarily intended to protect against small arms fire, it's lighter but also affords less protection than the thick, heavy flak armor that will be adopted in the 2030s.

The ADP in 2027 use the same weaponry as their future counterparts, except that the "Stomach" has not yet been developed. Instead, the Anti-Boomer Heavy Rifle is issued.

ADP FRONTLINE OFFICER'S GEAR (2027)

ARMOR WEIGHT	11.5 kg	OVERALL KD	18
ENCUMBRANCE	-2 Dex*, -1 Ref, -1 Move	TORSO & HELMET KD	20
		LIMB KD	15

*DEX penalty is reduced by 1 if not wearing the helmet. Head and torso have hardshell armor which is effective against all types of damage, including bullets, blades, blunt trauma, and fire. Fatigues are made from a lighter weave, which has full KD vs bullets, 1/2 KD vs blades, and no protection vs blunt trauma and fire.

SIDARM	ADP-issue Combat Handgun
LONGARM	M-42A1 Short MG (or 12-gauge Pump Shotgun)
MELEE WEAPON	Police Baton (or Knife)
OPTICS	IR Thermograph, Lowlight Vision.
EQUIPMENT	Radio (10 km), Gasmask (8 minutes of air), Boomer Deactivator (handheld remote device; switches off parasympathetic system of any civilian boomer; does not work on berserkers).

ANTI-BOOMER HEAVY RIFLE

▼ANTI-BOOMER HEAVY RIFLE

This is a large anti-boomer gun made for use by AD Police snipers. Unlike a Gerlitch, it can be used without a bipod—a cool marksman can kill a boomer with several well placed rounds. While they originally used other weapons, by 2034 this one will become the most popular gun among fire-support gunners as well because of the addition of full-auto capability.

WA	Range	DC	ROF	Shots	Cost
+1	400m	11D6AP	1 (25 in 2034)	20	¥110,000

N-POLICE REVOLVER

▼NORMAL POLICE REVOLVER

The N-Police use a .357 Magnum double-action revolver loaded with KTW rounds (solid bronze slugs coated with Teflon, good for shooting through an engine block), fitted with a red plastic-insert front ramp sight and a no-slip molded handgrip. Quite reliable, but hardly popular with AD Police!

WA	Range	DC	ROF	Shots	Cost
+0	50m	5D6AP	2	6	¥70,000

▼ELECTRONET SHELL

This is an electrical-surge net shell which can be fired from the Anti-Boomer Assault Gun (see *BGC* p.129, #4). It acts as a ranged Entangling attack (*BGC* p41) at -1WA, and if it hits it does 12D6 Shock damage—this damage treats the Boomer's SDP as Stun points, with the same effects and results.

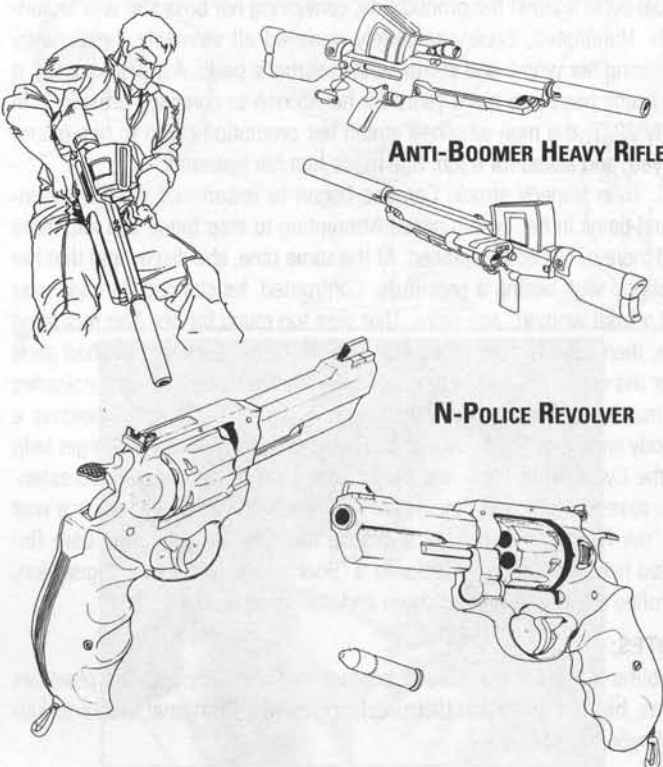

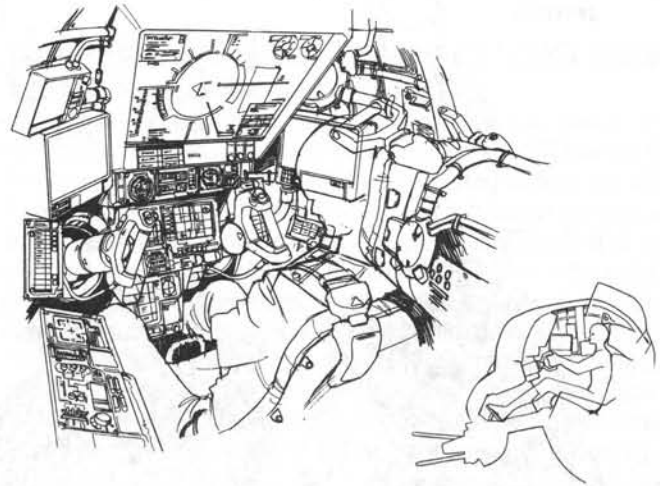
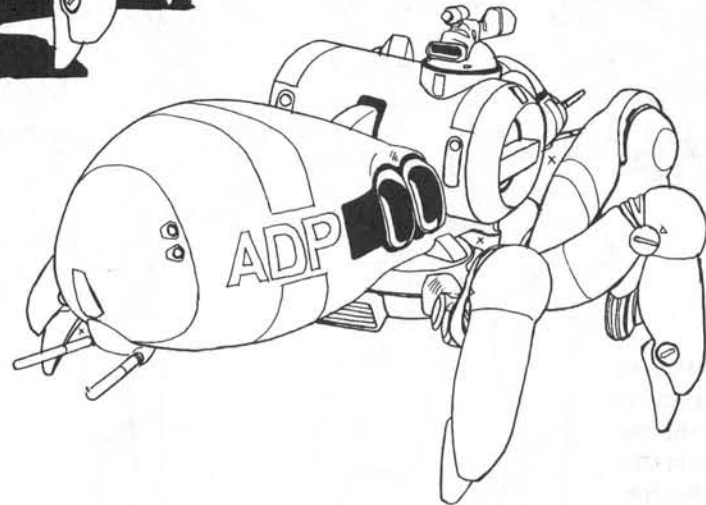
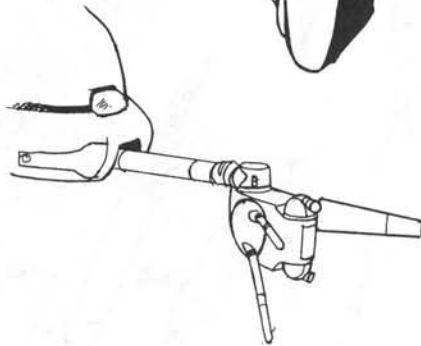
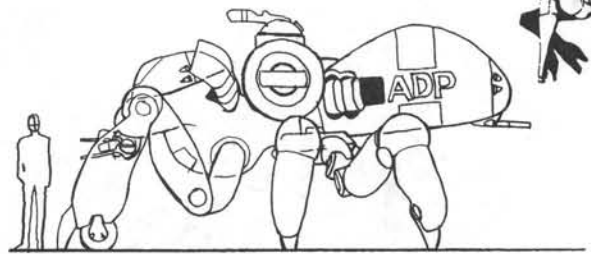
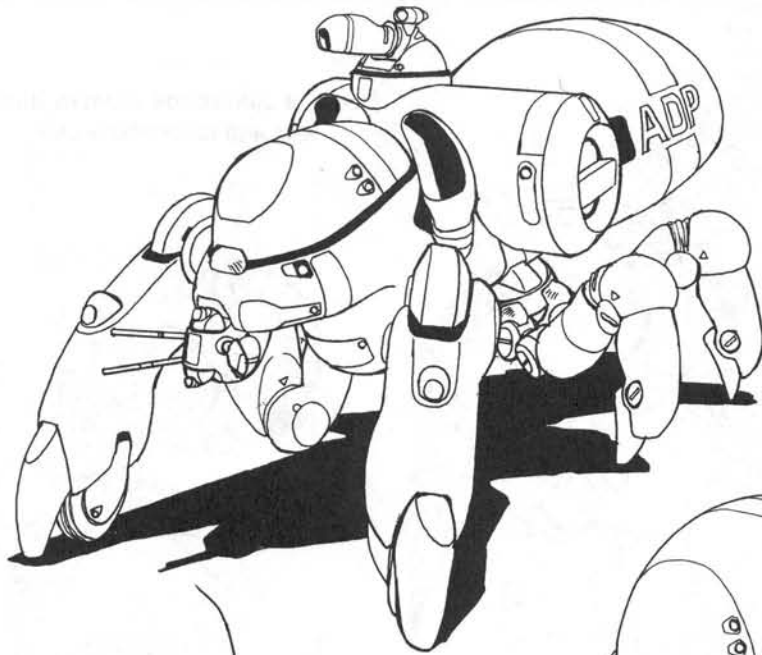

KUMO BATTLEMOVER 27 CP

WEIGHT	3300 kg	GENERATOR POWER	4 hours
MANEUVER	-5 DEX & REF	RUNNING	MOVE 18 (54kph)
STRENGTH	STR 9	JUMPJETS	-

SENSOR RANGE	1 km	COMM RANGE	30 km
--------------	------	------------	-------

ID#	LOCATION	ARMOR	STRUCTURE
1-6	Torso	40 KD	70 SDP
7	R. or L. Foreleg	40 KD	50 SDP
8	Hind Leg	40 KD	30 SDP

9: WEAPONS	WA	RNG	DMG	LOC	SPECIAL NOTES
SPRAY TURRET	+2	50m	*	Hull	*ROF ∞, 5 bursts
MELEE	-2	-	9D6*	Legs	Killing damage

10: SUBSYSTEMS:

- Spray turret fires crash foam, which hardens upon contact with air. Crash foam has a 70% chance of putting out fires where it is sprayed, and fills 2.16 square meters of area per successful "hit." A REF +Driving (or Athletics for boomers) roll vs (+2 per "hit") is required to avoid being immobilized by the foam. The crash foam compound is stored in the battlemover's "abdomen" section.
- Sensor suite (optical, audio, radio, targeting, thermograph, seismic detector, magnetometer, low-light vision, instrumentation, Heads-Up Display with +3 Perception), Spotlight. Entire system is mounted on articulated boom which can look around corners.
- Life Support (full sealing vs Nuclear, Biological & Chemical agents)

▼ **KUMO BATTLEMOVER**

The Kumo ("Spider") was the first walking machine used by the ADP. This one-man battlemover's rear section walks on four computer-controlled legs, while the frontal pilot compartment is individually "floated" on two large, wheeled forelegs. The overall design provides an extremely stable platform, which is just what the ADP needed for riot-control duties. Its light armor is bulletproof and its turret has a powerful liquid cannon whose tank can be filled with either water (for sweeping away rioters) or a fast-hardening crash foam useful for sealing off streets or acting as a barricade against speeding vehicles. However, it was not designed to face boomers, and while able to clamber across wrecked cars or rubble, its lack of speed, agility, and armament soon led to its rapid replacement by more capable mecha (the K-suit series). ADP officers were aware of its limitations, and rarely deployed it for anything other than "combat engineering" type duties.

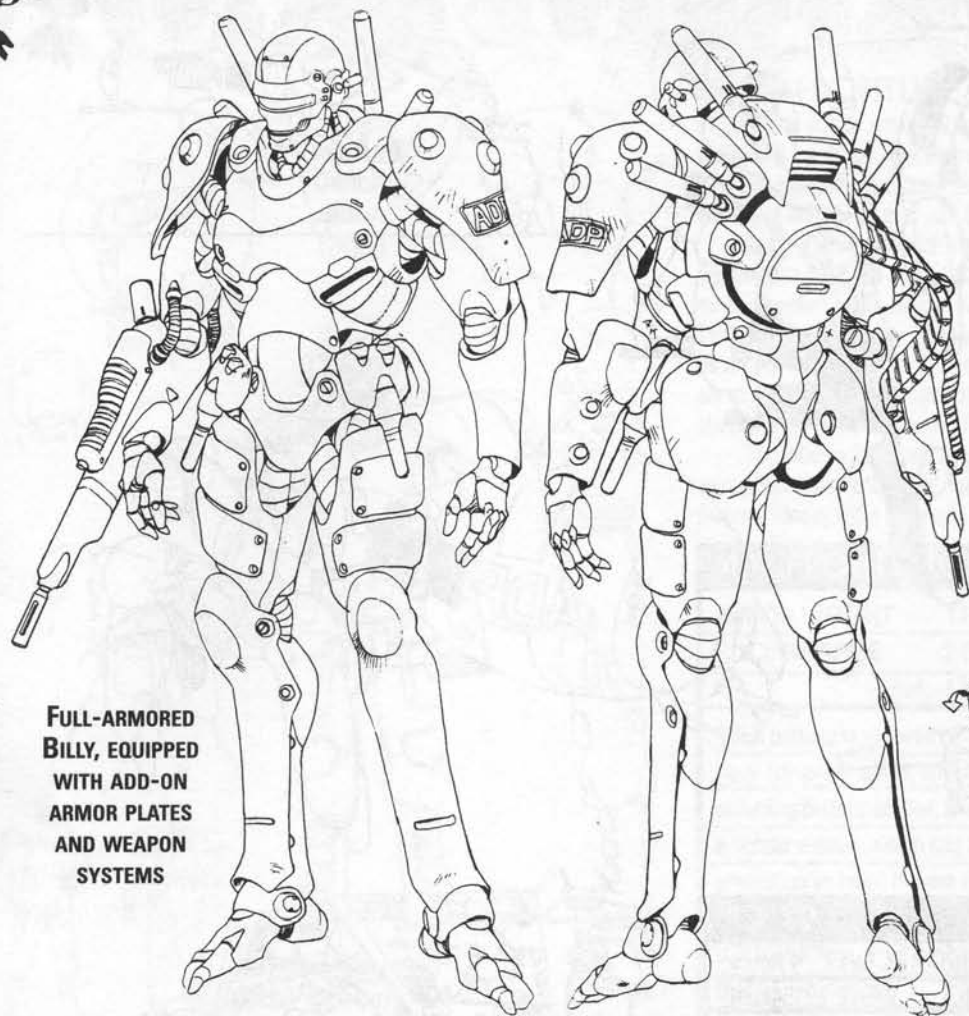

FULL-ARMORED BILLY, EQUIPPED WITH ADD-ON ARMOR PLATES AND WEAPON SYSTEMS

DETAIL OF CONNECTION BETWEEN BILLY'S ARM AND MACHINEGUN UNIT

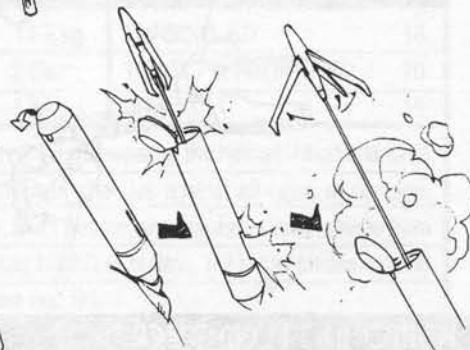
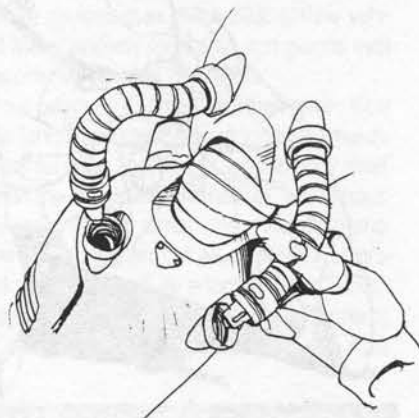

DETAIL OF BACK-MOUNTED ELECTRONET SYSTEM

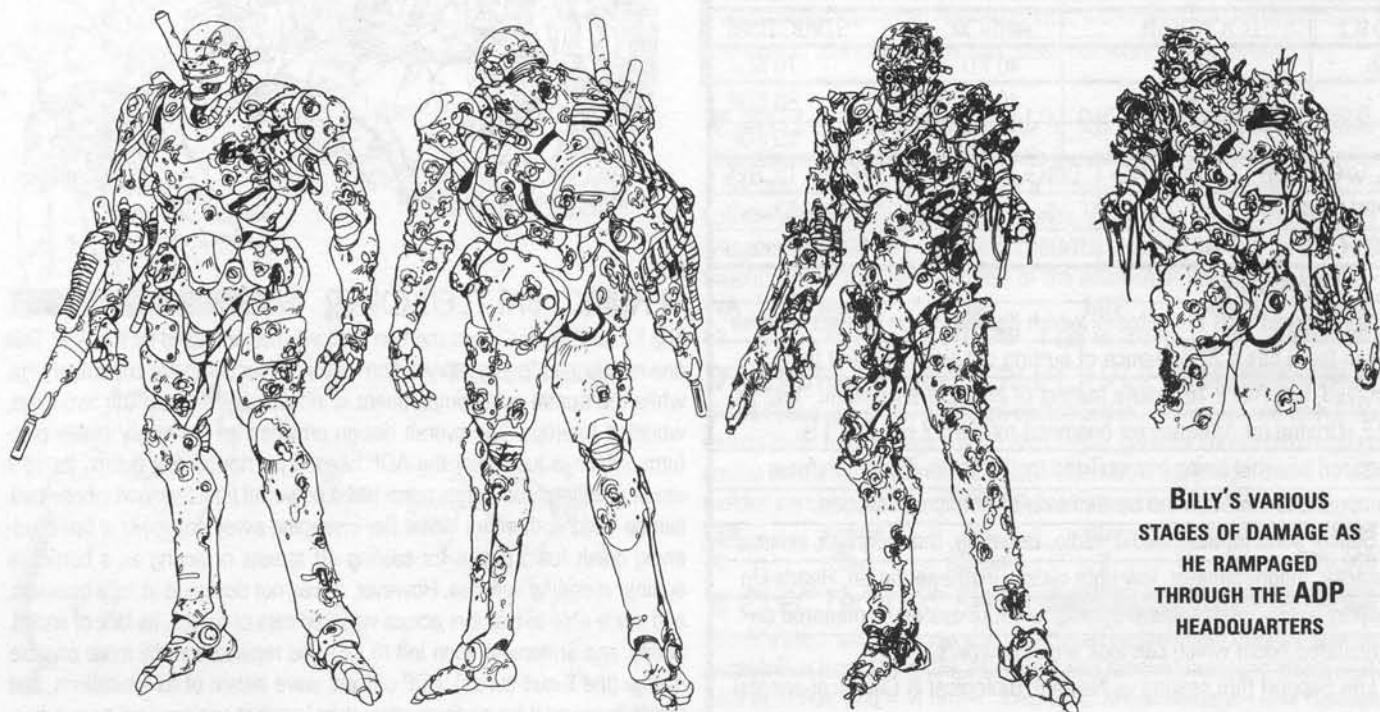

BILLY'S VARIOUS STAGES OF DAMAGE AS HE RAMPAGED THROUGH THE ADP HEADQUARTERS

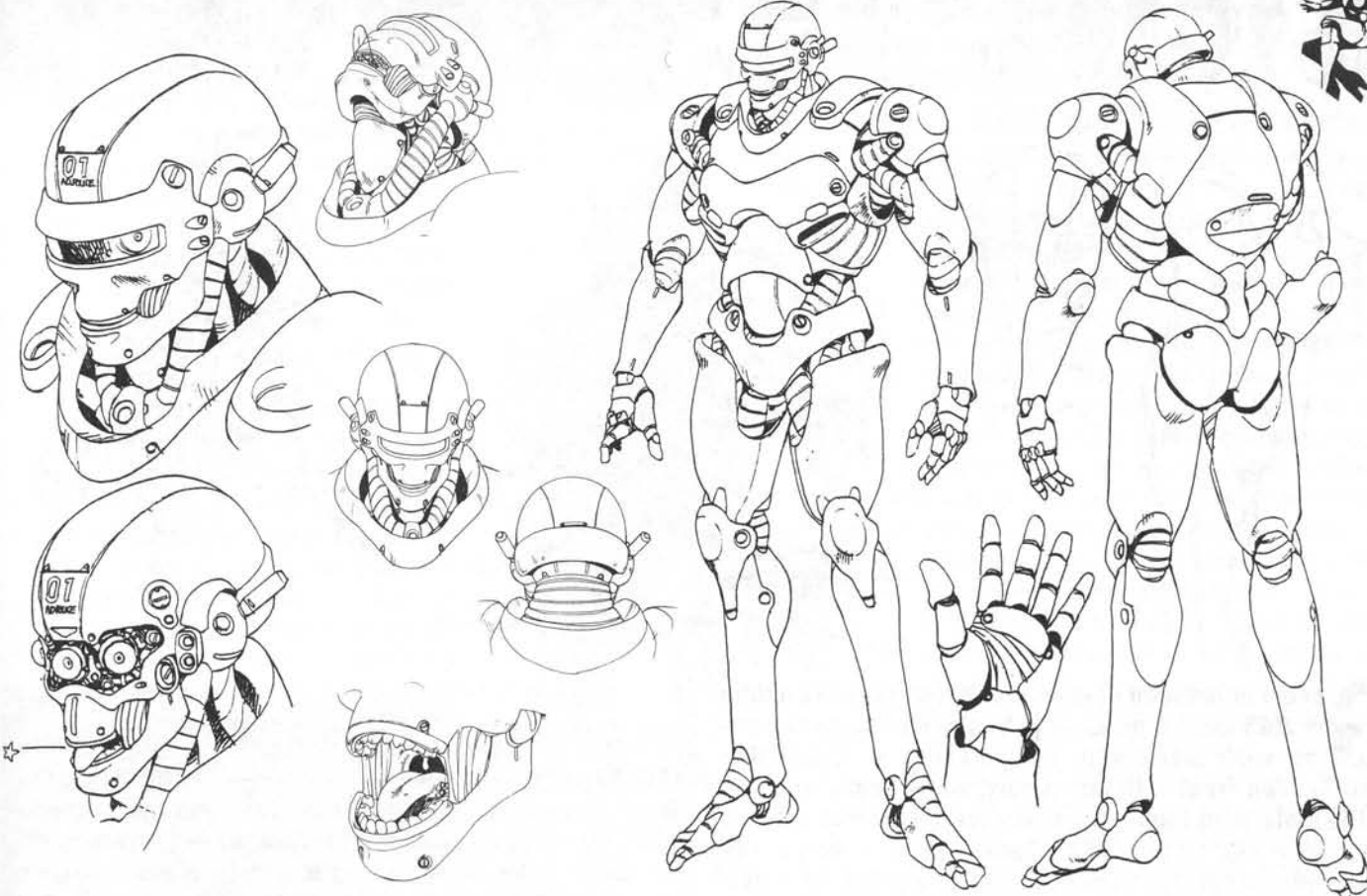

BILLY FANWARD

REF	9	INT	3	CYBER-BODY	12
DEX	5	PRE	6	CYBER-LIFT	5,000kg
CYBER-STR	12	WILL	5	HUMANITY	-21
CYBER-MOVE	12	TECH	2	SOCIAL ROLLS	-7

SKILLS: Perception +4 • Athletics +4 • Hand-to-Hand +7 • Melee +4

• Firearms +6 • Autofire +6 • Heavy Weapons +6.

ANTI-BOOMER CYBORG 282 CP

WEIGHT	575 kg	TYPE	Experimental Cyborg
ARMOR	55 (or 30) KD	RUNNING	36m (36kph)
STRUCTURE	60 SDP	FLY/SKIM	-0-

WEAPONS	WA	RNG	DMG	LOC	SPECIAL NOTES
HAND-TO-HAND	+0	-	12D6*	Arms	*Killing, halves KD.
MACHINEGUN	+1	425m	10D6*	(RA)	*ROF 25, 20 Bursts, not AP.
ELECTRONET	+2	20m	18D6*	(Back)	*see notes below:

Acts as a ranged Entangling attack (*BGC* p. 41), and if it hits it does 18D6 Shock damage—this damage treats the Boomer's SDP as Stun points, with the same effects and results. A successful Entangle can also be used to perform a Martial Throw, doing 12D6 damage.

SUBSYSTEMS: Full cyborg body with human brain and tongue • Interface plugs • Night Vision, IHUD, Thermograph, & Targeting • Commlink • Add-on armor & weapons systems: Adds 25KD to base 30KD for a total of 55KD, includes Electronet and machinegun.

▼BILLY FANWARD, ANTI-BOOMER CYBORG

AGE: Mid-20s. destroyed by AD Police in 2027.

Billy was a Frontline Officer, an amateur boxer who was always being knocked out, a dogged fighter who never had any luck. In 2027 he died in a boomer incident, only to be revived on the operating table as the ADP's fearsome Anti-Boomer Battle Cyborg. With access to add-on weapons and armor and command of his own heavy weapons squad (Unit G-4), he was more than a match for any boomer. But was he human? All that was left of his flesh was a brain, notochord, and tongue—which he habitually bit to help relieve his extreme sensory deprivation. This condition led to other boomer syndrome problems: lack of empathy, psychomorphing hallucinations, and sociopathic rage... first against boomers, then everyone else.

Billy's boomer syndrome was aggravated by the way he was treated. His mechanical body required regular maintenance and recharging, so he was isolated from other officers in a basement garage, seated in a special chair. People began to treat him as a machine: When he was hurt, it was "mechanical damage," not injury. His scientist creators experimented on him at will, addicting him to a DA-27 stimulant to treat his sensory deprivation. Billy's story also had a twisted "beauty and the beast" element, as his scientist creator used his metal body to satisfy her fantasies. This Dr. Takagi even considered erasing Billy's memory—as a boomeroid, he was legally "dead," a thing, not a person.

Billy is a model for the problems boomeroid PCs will face. Not every story needs a tragic ending, but Referees should play up the angst... of being treated and maintained like a machine, of having no social life, and of seeing friends, pets, children and loved ones recoil in horror. If a PC starts as a boomeroid, he could begin with his memory erased, leaving the player to try and discover his identity. Ultimately, the best hope for redemption lies in finding someone who will treat the boomer like a human being and friend, rather than a fighting machine.

BOOMERS 2027

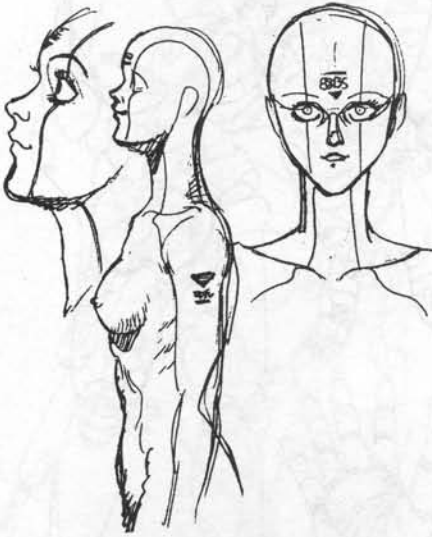

Genom introduced commercial boomers to the public in 2023 amid a massive publicity campaign (featuring such memorable buzzphrases as “Cyberlabor Will Set You Free!”). Unfortunately, while useful and versatile tools, their high price tags severely limited sales.

Then, in 2025, the Second Kanto Earthquake rocked Japan, and the island nation suddenly had a desperate demand for a cheap labor force. Conveniently, Genom was there to supply it. As the boomer factories cranked up production to meet government and corporate rebuilding needs, it was possible to drop the prices on the more mass-market models, making C and D-class boomers affordable to mid-sized businesses or even upper-class individuals. While the overseas markets developed more slowly, the Japanese were soon eating up idea of artificial humans with a spoon.

Boomer assembly workers, construction aids, and even secretaries and waitresses became “must have” novelty items. Restaurants and clubs would feature boomer service as a key draw, and the public would flock to see these fascinating simalcrums of humanity. Even businesses that didn’t really need them would acquire boomer workers as a sign of prosperity and progressive outlook—lack of one became a serious stigma in the competitive and status-conscious Nippon corporate world. Genom encouraged this fervor with ever more sophisticated models, some that seemed more human than human. And prices continued to go down.

Boomers quickly penetrated the domestic market so thoroughly that an entire economy based around them sprang up. Cyberdroid recycling became a “booming” field as older models were cast aside in favor of newer ones. These discarded boomers would be reconditioned in specially-licensed shops. They would then be sold to the next lower economic block of small businesses and middle-class individuals who eagerly bought up these second-hand status symbols. Of course, the reliability of these rebuilt units was often in question

As sales grew, so too did the incidents of erratic boomer behavior. The early boomer brains seemed very sensitive to disruption—often with violent consequences. As the number of “Boomer Waitress Slays Twelve” headlines increased, the public, now too enamored of their toys to give them up, demanded a police response. So the Advanced Police, originally created to keep the peace in the new cities, was assigned to deal with a new type of crime: Malfunctioning Cyberdroids. Business has been brisk.

▼COMMERCIAL BOOMERS

LABOR MODELS ————— ¥6,250,000 (50 CP)

There are a wide variety of mechanical household and commercial labor boomers, such as assembly line workers (often stationary, with tool hands), kitchen boomers (with four arms for speedy cooking and dishwashing), bartenders (both mixing and serving), and housekeepers (for vacuuming, dusting, laundry, and even windows).

200 TO 400KG; AI LEVEL = 2; ALL RELEVANT SKILLS +2.

INT 1, TECH 4, WILL 1, PRE 1, REF 2, DEX 3, STR 7, BOD 10, MOVE 6.

Armor = 25KD, Hits = 50SDP, REC = 14/t. Hand-to-Hand = 7D6.

Systems: Modular tools and appliances, as appropriate to design.

MANNEQUINS ————— ¥5,000,000 (40 CP)

These are C- and D-class cyberdroids which can be used as assistants in such duties as waiting tables, performing secretarial and clerical duties, and babysitting. Often illegally modified for sex functions.

ABOUT 200KG; AI LEVEL = 3; ALL RELEVANT SKILLS +3.

INT 2, TECH 5, WILL 2, PRE 3, REF 3, DEX 3, STR 4, BOD 8, MOVE 9.

Armor = 20KD, Hits = 40SDP, REC = 8/t. Hand-to-Hand = 4D6.

Systems: Semi-realistic appearance; occasionally built-in tools, such as a coffeemaker or paper-shredder. Some are practically androids, with a high percentage of organic components.

ANDROIDS ————— ¥20,000,000 (160 CP)

Though B- and A-class organic-technology cyberdroids such as these are far more complex than other commercial boomers, their production is comparatively cheap. However, being designed as executive secretaries, hostesses, or models, they are almost always very attractive, anatomically correct, and capable of simulating emotions. These features command a high price, inflating their value by as much as ten times (especially since purpose-built Sexaroids are illegal).

ABOUT 50KG; AI LEVEL = 4; ALL RELEVANT SKILLS +4.

INT 3, TECH 6, WILL 3, PRE 6, REF 3, DEX 3, STR 3, BOD 6, MOVE 6.

Armor = 0, Hits = 30SDP, REC = 6/day. Hand-to-Hand = 3D6.

Systems: Fully realistic appearance, maintenance-free systems.



▼ ANDROIDS AND SEXAROIDS: BIOMIMETICS IN 2027

Many of the older boomer models, especially sexaroids like the Phantom Woman and the "discontinued" 33-S series, seem to be much more human-like than newer boomers. Not only do they look (and smell, feel, and bleed!) like us, they often act like humans as well, blurring the line between man and machine. Supposedly more "advanced" models, such as the new Adama (developed in 2034), seem almost a step backward. Why?

In fact, the answer is simple. Many early android-model boomers are a result of pseudo-organic "biomimetic" technology. Effectively, they're artificial *analogs* of human beings. A 2020's-era android-class boomer, such as a sexaroid, has an internal structure that is almost an organ-for-organ duplicate of a human being. A heart-like organ pumps circulatory fluid, muscles contract, lungs provide oxygen, hormone-analogs carry messages, and so on. Even the brain's neural connections are patterned on those of a human brain. What differs is the *materials* used: an artificial blood supply, bones made of exotic composites, plastic organs, biochip nerves, and so on. This can lead to what some ADP officers dub the "spaghetti syndrome": The blasted guts of a terminated biomimetic android can keep a rookie officer from ordering spaghetti for quite some time

Even so, while the biomechanics used are similar, the actual biochemistry is very different. For example, some androids have a power pack in their "heart", others eat human food, or may be prone to unique malfunctions (such as the 33-S's propensity for losing the ability to resupply its own blood). Most drugs (medicinal or recreational) will have no effect at all; others may have unpredictable side effects! (Referees can roll 1d6 the first time a particular drug is used: On a 6, it does something odd or harmful, otherwise nothing happens.) Balancing this is the "maintenance free" nature of many of these endoskeletal models: Just like a human, they don't require tune ups or battery recharges, and their biomechanical parts have the same self-repair capability of a human.

Nevertheless, there are basic limits on the capabilities of biomimetic androids, and in the late 2020's, Genom began to reach them. A decade of experience has shown that, okay, you could build an android who was essentially a copy of a human. It was maybe a bit stronger, a bit faster . . . but it was also just as impossible to control. Biomimetic units were notoriously unstable and independent—just like people (the Sexaroids being perfect examples), and the resultant rash of violent boomer crimes threatened to kill (pardon the pun) the market. Since boomers with more mechanical components (particularly CPUs) demonstrated greater programming reliability and potential for expansion, Genom and their subcontractors moved

in that direction. If a boomer needed to look human or repair itself, the new advances in nanotechnology, such as matter cloning and fusion, could allow it to do just that.

▼ SEXAROID VS. ANDROID

Lots of seductive boomers can be seen wandering around MegaTokyo in the 2020's—so much that AD Police seem to almost wink at them.

But aren't sexaroids rare and illegal?

Yes . . . and no! A "sexaroid" is an android designed for sexual functionality. These cyberdroids are near-legendary (and completely illegal), being purpose-built with exotic features like mesmerizing eyes or exotic chemical pheromones (the same effect in game terms, but instead of being blocked by sunglasses, it won't work in a strong wind or on someone with a gasmask). There are rumors that executives even *omit* the final "obedience" blocks in the brains of certain sexaroid models. Why? Well, it's nice owning a beautiful toy who'll do whatever you want with a smile on her face, but let's face it: When you're a corporate boss, it's *power* that turns you on. It's no fun having someone who obeys because she's programmed to. You want to own someone who *knows* she is a slave, but has to make you feel happy anyway. She'll obey because if she doesn't, she'll be punished—or dismantled.

While making boomers designed *explicitly* for sex is illegal (at least in Japan), Genom has found a way around that: It seems that a boomer which is marketed as a beautiful "executive secretary, hostess, or model" seems to sell better if ads mention it is "anatomically perfect in every detail" and "capable of a full range of simulated emotional and physical responses." The high end of these creatures are effectively sexaroids in every respect: A- or B-class boomers made to order with beautiful, life-like bodies and charming, seductive personalities, differing from the 33-S and their ilk only in their lack of exotic features (and free will). The low end are "love dolls"—pretty

C- or D-class mannequins with a few hardware and software upgrades. Often these are recycled models, and an entire illegal cottage industry exists in Megatokyo (particular in the Outer District) devoted to upgrading secretarial and waitress models to include sex functions.

While sales of boomers with sex functions are good for Genom's bottom line, the down side is that *because* it is an illicit, under-the-table business, it is also a breeding ground for boomer malfunctions. Using an android for something it was not trained to handle is stressful—doubly so when it is an activity as hormone-charged as sex. While a purpose-built sexaroid like a 33-S has been designed to deal with such experiences, an illegally upgraded "secretary" boomer suddenly finding itself asked to perform in the bedroom as well as the boardroom has not! When it starts acting funny, its owner is not likely to call Genom's product support hotline and explain what he was *really* doing with it!

The result? A sexy android that becomes progressively unstable and deranged, like the Phantom Woman

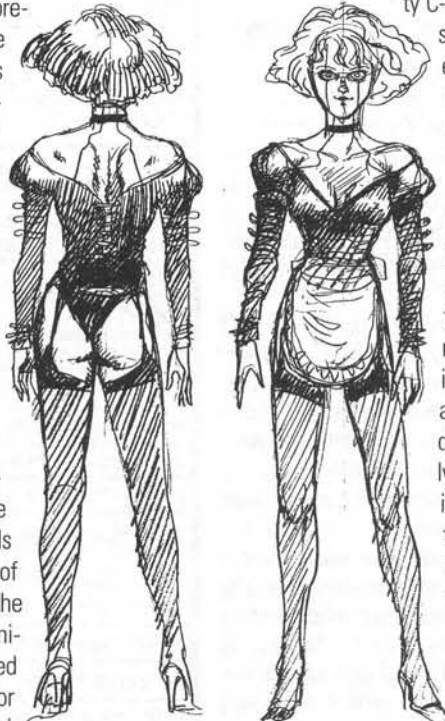

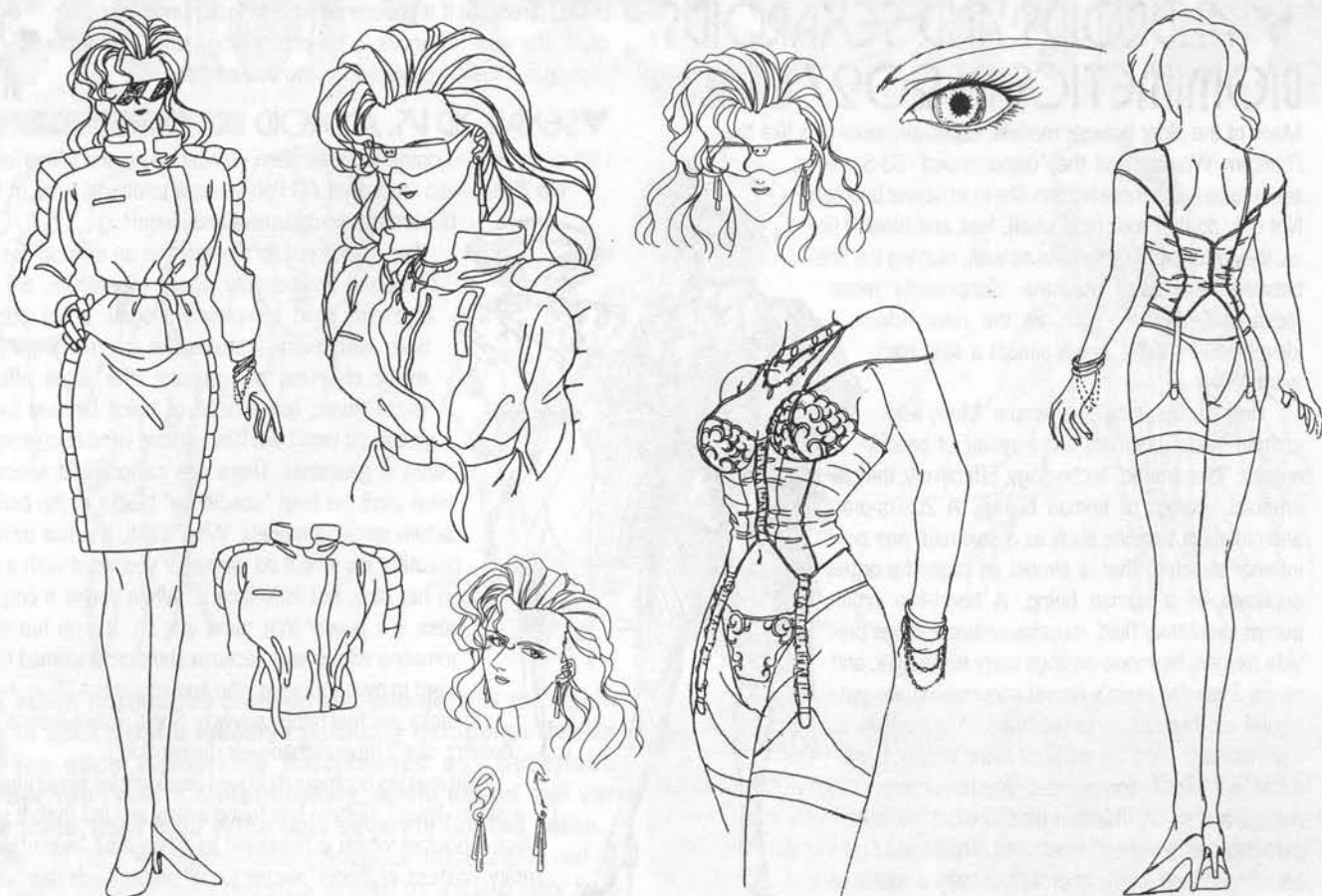

THE PHANTOM WOMAN

WEIGHT	52.5 kg	TYPE	Android
ARMOR	-0-	RUNNING	6 (18kph)
STRUCTURE	30 SDP	FLY/SKIM	-0-
REF	4	INT	5
DEX	4	PRE	7
STR	5 (9*)	WILL	0
MOVE	6	TECH	4
AI RATING	Level 4	SKILLS	+4*
BODY	6	RECOVERY	6/day

WEAPONS	WA	RNG	DMG	LOC	SPECIAL NOTES
HAND-TO-HAND	+0	-	5D6*	A, A	*Killing damage!

*HTH note: Psychosis has resulted in increased strength (see *BGC* p. 116-117); STR increases to 9, thus HTH damage becomes 9D6.

SUBSYSTEMS: Imprinted AI brain. • Nonprofessional recycling resulted in mental malfunction: Psychosexual obsession with being killed by (or killing) Leon McNichol. • Organic systems with Beautiful appearance; does not (indeed, cannot) rip out of human visage. • Effectively no Fusion ability and organic "cloning" functions limit regeneration to a REC of 6 per day (not per Phase). • High quality (A-Class) construction includes sexual characteristics. • Optics include thermographic and magnetic resonance imaging (which can render metal objects in 3-D "schematic" style). • Phantom Woman is mute, but similar A-class boomers would be capable of speech. • Possesses sex functions, but unlike more advanced 33-S Sexaroids, has no special hypnotic abilities. • Referees can use Phantom Woman's statistics for a "typical" mid-range sexaroid-type boomer.

▼THE PHANTOM WOMAN

Dead in 2026, recycled and destroyed again in 2027.

An A-class female android model, externally identical to a beautiful woman. Used as a concubine by her owner, the hormone signals distorted her biochips, resulting in mental dysfunction. After running away (and possibly murdering) her owner, she began posing as a prostitute, killing those men who couldn't satisfy her appetites. Her handiwork was discovered by the Normal Police, but she soon began stalking them, cornering the young Leon McNichol. Nearly overcome by her deadly allure, Leon mastered himself at the last moment, shooting her several times.

Her bullet-riddled body was examined by the police, but the remains were bought by a junk dealer and sold illegally to a recycling outfit. Throughout this ordeal, the female boomer's brain and memory survived, recording the pain and humiliation of her fate. Her parts were used to build another A-class boomer. She was reborn, once again beautiful, but with a different face. However, attempts to wipe her memory failed. She retained an image of her nemesis: Leon McNichol. Before the recycling job could be completed (and her vocal cords connected), she escaped.

In her second incarnation, the Phantom Woman was obsessed with catching Leon alone. She had no interest in other men (disabling any who made a pass at her). Despite being mute, her knowledge of computers enabled her to lure Leon away from his partner. Was she looking for vengeance, pain, love, or death? Or all of them at once? She didn't know herself. Jeena's last-minute intervention saved Leon—and a ghost was put to rest.

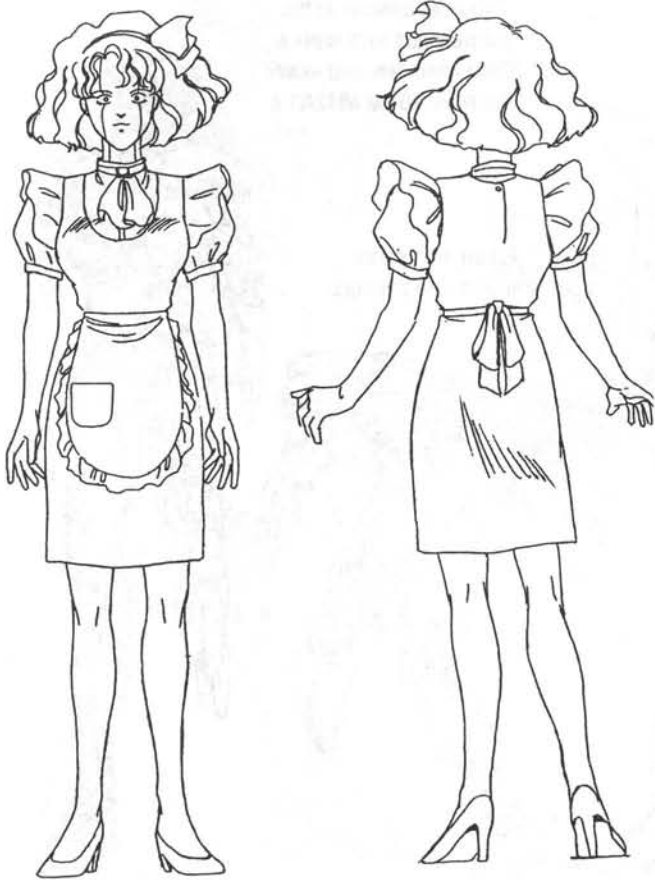

BU-E-35 WAITRESS BOOMER

WEIGHT	295 kg	TYPE	Mannequin
ARMOR	20 KD	RUNNING	9 (27kph)
STRUCTURE	40 SDP	FLY/SKIM	-0-
REF	4	INT	2
DEX	4	PRE	3
STR	5 (9*)	WILL	1
MOVE	24	TECH	4
AI RATING	Level 3	SKILLS	+3*
BODY	8	RECOVERY	4/t

WEAPONS	WA	RNG	DMG	LOC	SPECIAL NOTES
HAND-TO-HAND	+0	-	5D6*	A, A	Killing damage.

*HTH note: When a BU-E-35 goes mad due to overuse and/or careless recycling, psychosis results in increased strength (see BGC p. 116-117); STR increases to 9, thus HTH damage becomes 9D6.

SUBSYSTEMS
• Robotic brain.
• Near-human appearance; does not (indeed, cannot) rip out of humanoid visage.
• Effectively no Fusion ability.
*Related Skills include: Perception, Social, Wardrobe & Style, and Domestic.

▼BU-E-35 WAITRESS BOOMER

These C-class Mannequin-type boomers were built to resemble pretty women, but with gray or blue skin with obvious seams. They were sold as waitresses and store clerks, and were designed for 12-hour shifts—longer use overheats them. Normally this might not be serious, but cheap remanufactured models are often sold, as small businesses can't afford the latest design. If substandard parts (or those from a boomer that had previously malfunctioned) were recycled, what might be a simple "overheat and shut down" error may turn into a berserk boomer! This type of boomer is also sometimes illegally rebuilt as a cheap "love doll."

Note: When terminated by the ADP, this cyberdroid was treated to serious overkill—which is understandable, considering that their comrade had just been killed by this crazed hellion. To make sure that every last part of the boomer was destroyed (not even a wriggling leg or hand), five officers emptied their M42A1's into its body. Five shots shattered the head, five more wrecked the spine, another five shredded the body, and the limbs were destroyed by another five rounds each. In all, the waitress boomer's dancing skeleton took 35 rounds before it was guaranteed to be neutralized. The other 295 rounds just helped the ADP officers express their frustration and anger at the death of Alus.



PHYSICAL DAMAGE AFTER TAKING THREE HITS FROM A 20MM CHAINGUN AND HEAVY FIRE FROM 10MM M42A1'S

FLIGHT THRUSTERS DEPLOYED AND ENGAGED

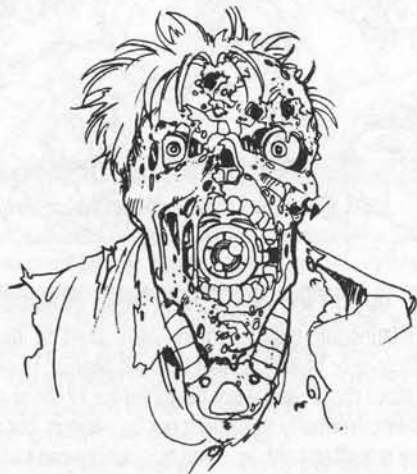

▼SALARIMAN BOOMER

Typical of combat cyberdroid designs in the late 2020's, this enigmatic covert boomer disrupted MegaTokyo and laughed in the face of the AD Police. Appearing in the middle of the Ripper murders on a downtown rooftop, its "skin" was ripped away by a helicopter gunship. This attack failed to keep it from injuring Jeena, but the "salariman" finally perished from a well aimed revolver shot from Leon's pistol. Fast and agile on its feet and in the air, it had the signature combat boomer strength and mouth-mounted laser beam, but because it was an infiltration model (posing as a salariman) it was lighter and thus weaker. Was it a prototype that had escaped the lab, or was it intercepted on some secret mission? And why did it carry a cybernetics bank ID card? For one possibility, see p. 112....

SALARIMAN BOOMER

WEIGHT	287.5 kg	TYPE	Combat/Covert		
ARMOR	15 KD	RUNNING	12 (36 kph)		
STRUCTURE	45 SDP	FLY/SKIM	37 (111 kph)		
REF	5	INT	2	AI RATING	Level 4
DEX	5	PRE	5	SKILLS	+4*
STR	8	WILL	5	BODY	9
MOVE	12	TECH	2	RECOVERY	16/t
WEAPONS	WA	RNG	DMG	LOC	SPECIAL NOTES
HAND-TO-HAND	+0	-	8D6*	A, A	*Killing damage
MOUTH LASER	+0	555m	14D6	Head	-

SUBSYSTEMS

- Imprinted AI brain.
- Flight jets in back.
- Optics with targeting, lowlight, and IR functions.
- Scrambled radio with 50km range.
- Human disguise function: Must rip out of human disguise in order to deploy weapons and equipment; INT + Perception vs 20 to detect.
- Limited Fusion ability: Can absorb, control, and animate 72kg of mechanical material.

*Related Skills include: *Perception, Persuasion, Athletics, Hand-to-Hand, Firearms, Melee, Driving, Business, Espionage, Computers, Hacking, Forgery & Stealth.*

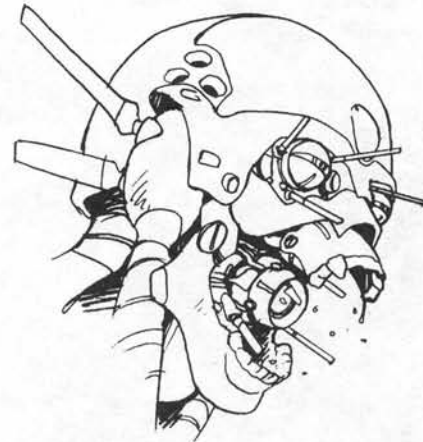
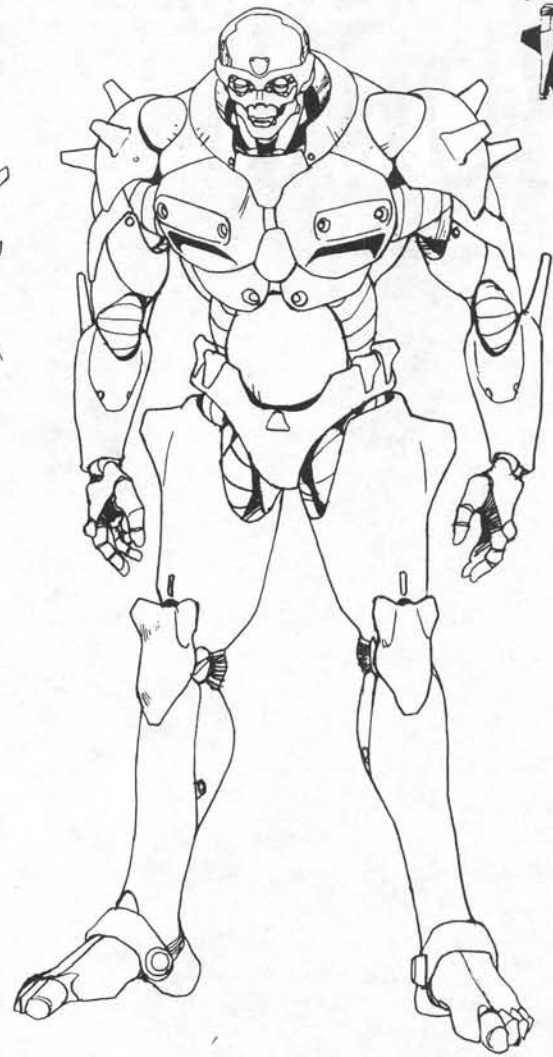
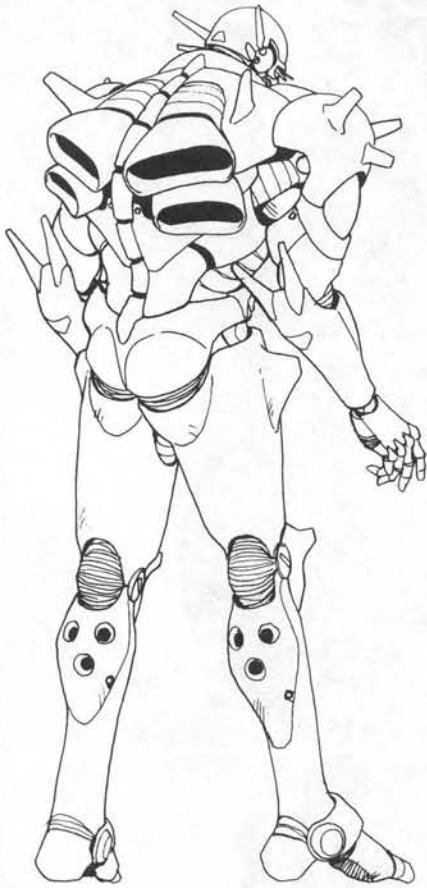

BU-C-208 COMBAT BOOMER

WEIGHT	555 kg	TYPE	Combat		
ARMOR	40 KD	RUNNING	36 (108kph)		
STRUCTURE	65 SDP	JUMP-JETS	100m		
REF	5	INT	2	AI RATING	Level 5
DEX	5	PRE	5	SKILLS	+5*
STR	10	WILL	4	BODY	13
MOVE	15	TECH	3	RECOVERY	18/t

WEAPONS	WA	RNG	DMG	LOC	SPECIAL NOTES
HAND-TO-HAND	+0	-	10D6*	RA, LA	*Killing damage
MOUTH LASER	+2	666m	15D6	Head	Infinite BV!

SUBSYSTEMS
• Imprinted AI brain.
• Jumpjets in back; cannot fly or skim.
• Shieldable optics with targeting, lowlight, and IR functions.
• Scrambled radio with 50km range.
• Human disguise function: Must rip out of human disguise in order to deploy weapons and equipment; INT + Perception vs 20 to detect.
• Limited Fusion ability: Can absorb, control, and animate 141kg of mechanical material.
*Related Skills include: Perception, Athletics, Hand-to-Hand, Firearms, Melee, Stealth.

▼BU-C-208 COMBAT BOOMER

A big, fast boomer of baroque design, the BU-C-208 was an interim (and expensive) model developed by Genom before the successful mass-production of the BU-55C. It is capable of running at blinding speed, and is armed with the classic mouth-mounted laser beam—but this weapon's targeting system was so sophisticated that it could be fired with high accuracy even in mid-air while the boomer was upside down! A rogue BU-C-208 was successfully destroyed by the experimental anti-boomer cyborg Billy Fanward in late 2027AD.

BUBBLEGUM CRASH!

BUBBLEGUM CRASH!

42

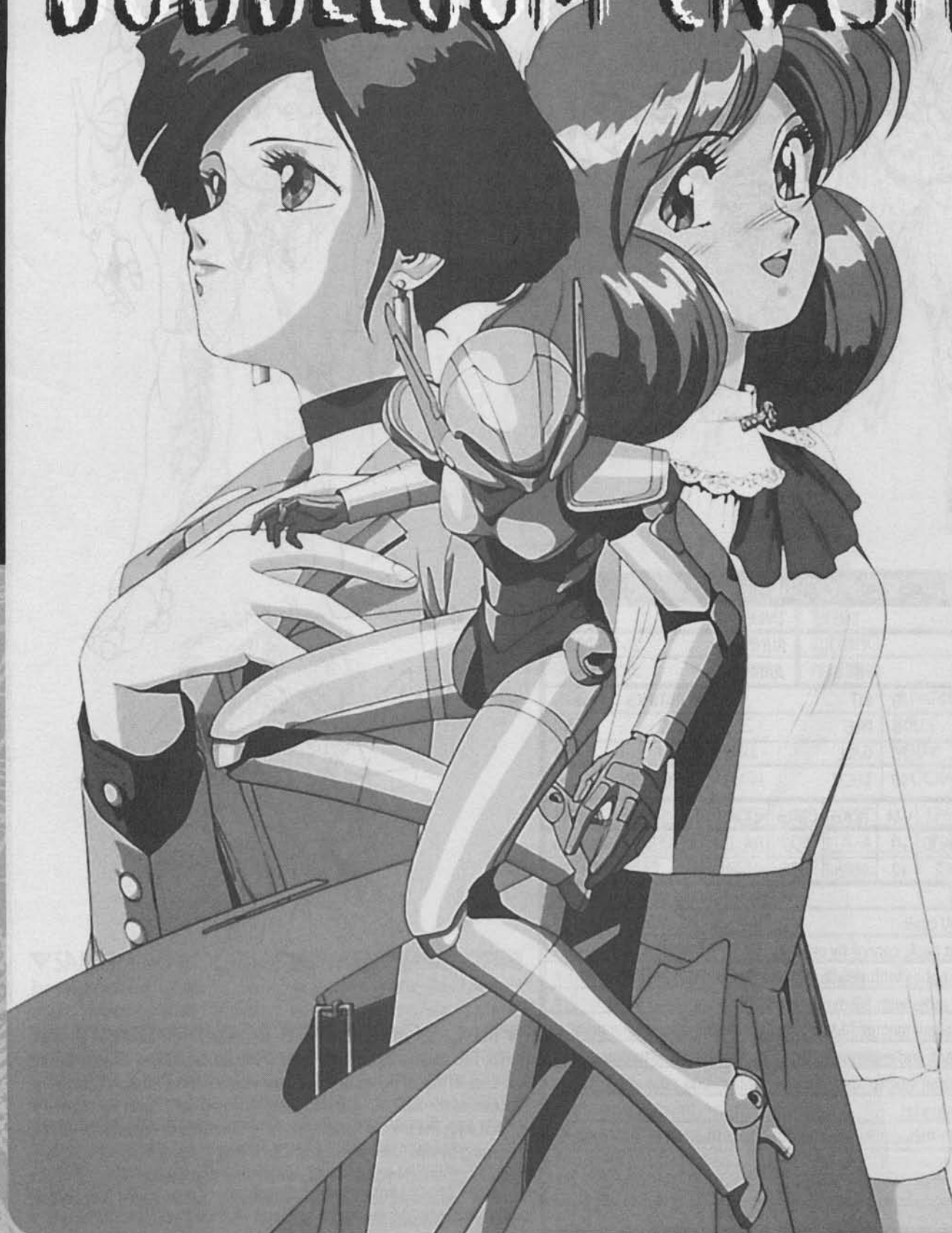

EPISODE GUIDE: BUBBLEGUM CRASH! 1

ILLEGAL ARMY

MEGATOKYO, 2034. SECURITY BOOMERS ARE GUARDING THE GLORY BANK WHEN MILITARY POWERED SUITS SUDDENLY ATTACK AND BLAST THEM TO BITS. THE AD POLICE ARRIVES AS THE BANDITS BEGIN LOOTING THE BANK, BUT THE SUITS EASILY ESCAPE. LEON BEGS THE NEW POLICE CHIEF TO DEPLOY A SPECIAL POWERED ARMOR UNIT, BUT HE REFUSES.



ELSEWHERE, PRISS PURSUES HER DREAM OF A PRO DEBUT, WHILE LINNA HAS ABANDONED AEROBICS FOR A LUCRATIVE STOCK MARKET JOB. SYLIA'S BEEN AWAY A LONG TIME, AND NENE FEARS THAT THE KNIGHT SABERS ARE DRIFTING APART. AFTER THE BANDITS HIT ANOTHER BANK AND STEAL A COMPUTER COMPONENT, NENE HACKS INTO A NEO-NATO DATABASE AND CONNECTS THE BANDITS' POWER SUITS TO THE ILLEGAL ARMY, A SUPPOSEDLY DEAD MERCENARY OUTFIT LED BY A COLONEL LANDO! IN FACT, COLONEL LANDO HAS BEEN REBORN—AS A CYBORG ORDERED BY A MYSTERIOUS VOICE TO STEAL COMPONENTS FOR A NEXT-GENERATION AI.

THE NEXT DAY, SYLIA RECONTACTS THE KNIGHT SABERS. DESPITE NENE'S FEARS, SYLIA HAS NO INTENTION OF DISBANDING—SHE'S UPGRADED THEIR EQUIPMENT, AND THEY'VE BEEN HIRED TO STOP THE ILLEGAL ARMY FROM STEALING THE AI COMPONENTS.



THE ILLEGAL ARMY ARE MET BY AD POLICE OUTSIDE THEIR NEXT TARGET, BUT LEON IS DEFEATED BY LANDO, AND THE MERCENARIES ESCAPE AGAIN. MEANWHILE, PRISS STORMS OUT WHEN HER AGENT TRIES TO PACKAGE HER AS AN IDOL SINGER, AND LINNA RESIGNS WHEN HER COMPUTER STOCK CRASHES DUE TO LANDO'S THEFTS!



THE MERCENARIES ATTEMPT TO SEIZE THE LAST AI MODULE, ONLY TO DISCOVER IT'S A FAKE AND THE KNIGHT SABERS ARE WAITING. WITH THEIR UPGRADED SUITS, THE SABERS MAKE QUICK WORK OF THE ILLEGAL ARMY. HOWEVER, EVEN AFTER HIS SUIT IS WRECKED, LANDO'S BOOMEROID BODY FIGHTS ON, ULTIMATELY ACTIVATING A CITY-BUSTING SELF-DSTRUCT SYSTEM. NENE AND PRISS DISARM IT, BUT THE DYING LANDO PROPHESES THAT HIS MYSTERIOUS MASTER WILL CREATE A DREAM WORLD OF CHAOS AND TERROR, ONE FIT FOR NEITHER HUMAN NOR BOOMER.

EPISODE GUIDE: BUBBLEGUM CRASH! 2

GEO CLIMBERS

AT A LABORATORY BENEATH GEO CITY, A NEW "SECOND GENERATION" BOOMER, ADAMA, HAS BEEN DEVELOPED BY ONE OF DR. STINGRAYS COLLEAGUES, DR. HAYNES. BUT HIS RIVAL, DR. YURI, IS BITTERLY JEALOUS OF HAYNES' SUCCESS, AND YURI'S BOOMERS SLAUGHTER HAYNES AND HIS STAFF! THE AD POLICE BLAME THE LAB MASSACRE ON ADAMA, WHO IS NOT ON THE SCENE. MEANWHILE, UNDER GEO CITY, DR. YURI DEMONSTRATES THE IRON LIZARD, A POWERFUL CRAB-LIKE BOOMER HE HOPES TO SELL TO THE ARMY. BUT YURI NEEDS TO REPLACE ITS FAULTY AI WITH THAT OF THE STOLEN ADAMA.

SYLIA TELLS THE KNIGHT SABERS THAT ADAMA'S AI IS THE ONE THE ILLEGAL ARMY SOUGHT. SHE IS CONVINCED THAT THE GENTLE HAYNES' ADAMA IS NOT RESPONSIBLE FOR THE MASSACRE. PRISS IS SKEPTICAL, BUT THE KNIGHT SABERS AGREE TO SEARCH FOR HIM. THAT EVENING, THE MYSTERIOUS "VOICE"—THE SAME THAT COMMANDED LANDO—DEMANDS ADAMA FROM YURI. HOWEVER, THE CHILD-SIZED BOOMER HAS SELF-ACTIVATED, AND SNEAKS OUT OF YURI'S LAB AND HEADS UNDERGROUND, TRYING TO GET "HOME" TO GEO CITY. SOON EVERYONE IS CHASING ADAMA: LOCAL CYBERPUNKS, AD POLICE, KNIGHT SABERS, AND DR. YURI'S BOOMERS!



PRISS FINDS HIM FIRST. IN A SERIES OF ENCOUNTERS WITH YURI'S BOOMERS AND THE AD POLICE, THEY REPEATEDLY SAVE EACH OTHER'S LIVES. FIGHTING ALONGSIDE ADAMA, PRISS FINDS HER ANTI-BOOMER PREJUDICE BEGINNING TO MELT.

ADAMA REACHES THE SUPERCOMPUTER IN HAYNES' LAB, WHERE HE UPLOADS HIS MEMORIES. UNFORTUNATELY, YURI HAS ALSO ARRIVED WITH THE IRON LIZARD. AS ADAMA AND PRISS ARE FIGHTING FOR THEIR LIVES, LINNA AND NENE ARRIVE IN THEIR HARDSUITS, BUT THEY BARELY SLOW DOWN THE MONSTER. PRISS AND ADAMA FLEE TO THE ROOF OF THE COMPLEX, WHERE SYLIA AND THE KNIGHTWING JET ARE WAITING. AS PRISS GETS ABOARD, ADAMA IS WRECKED.

AVENGEFUL PRISS SUITS UP AND, WITH THE HELP OF A SET OF STRAP-ON CRAB ARMS, DEFEATS THE LIZARD IN A DESPERATE HIGH-RISE BATTLE. WHEN YURI REFUSES TO SURRENDER, SYLIA EXECUTES HIM. THE "VOICE" SPEAKS TO SYLIA THROUGH THE COMPUTER, WARNING HER IT HAS COPIED DATA FROM ADAMA'S AI TO CREATE A NEW WORLD.

PRISS COMFORTS THE "DYING" ADAMA, PROMISING TO KEEP HIS AI FROM BEING MISUSED. AS THE KNIGHT SABERS FLY HOME, PRISS TELLS SYLIA SHE IS STARTING TO BELIEVE IN THE DREAM OF A WORLD WHERE HUMANS AND BOOMERS CAN BE FRIENDS.



EPISODE GUIDE: BUBBLEGUM CRASH! 3

MELTDOWN

ALL OVER MEGATOKYO, THE BOOMERS ARE REVOLTING! AS THE AD POLICE STRUGGLES TO CONTAIN THE "BOOMER REVOLUTION", THE MYSTERIOUS "VOICE" MANAGES TO STEAL SEVERAL COMBAT BOOMERS. SYLIA AND NENE TRACE THE BOOMER MALFUNCTIONS TO A VIRUS BASED ON ADAMA'S AI WHICH SUBVERTS NORMAL ANTI-VIRUS PROGRAMS.



THE STOLEN COMBAT BOOMERS ATTACK THE AD POLICE AND THE KNIGHT SABERS FLY TO THE RESCUE. THIS IS ONLY A DECOY, HOWEVER. LED BY A FUSION BOOMER, ALL THE CITY'S BOOMERS ARE MELDING INTO A GIANT DATA-EATING MONSTROSITY AT MEGATOKYO'S CENTRAL DATABANK! USING A COUNTER-PROGRAM DEVELOPED BY MACKIE, THE KNIGHT SABERS BREAK THROUGH THE FUSION BOOMER'S JAMMING AND DESTROY ITS CORE WITH THE KNIGHTWING'S CANNONS.

BUT A NEW MENACE EMERGES: THE GIANT ROBOT BORING MACHINE BRÜM-BAR IS TUNNELING TOWARD THE CITY'S FUSION REACTOR COMPLEX, THREATENING AN EXPLOSIVE MELTDOWN THAT WILL DESTROY MUCH OF JAPAN. AS THEY TRY TO INTERCEPT THE BORE, THE KNIGHT SABERS ARE CONFRONTED BY THE "VOICE": LARGO FROM *BGC 6 RED EYES*! THEY ALSO FACE THREE LARGO AVATARS—POWERFUL COMBAT BOOMERS THAT TRANSFORM AND ATTACK LINNA, NENE, AND PRISS.

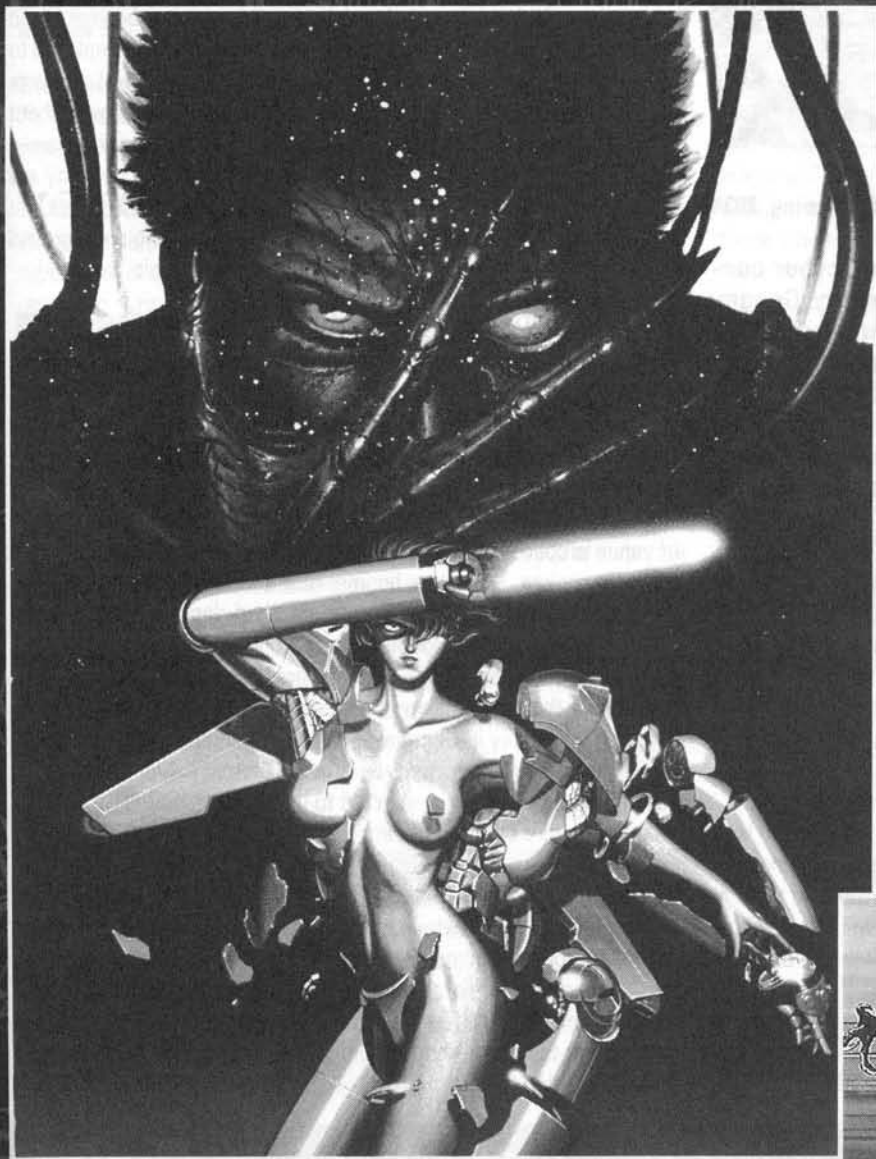

INSIDE THE BORING MACHINE, SYLIA DISCOVERS LARGO'S REAL BODY FLOATING IN A TANK. LARGO DESCRIBES SYLIA AS A "LIFE-FORM NEITHER HUMAN NOR BOOMER" AND DECLARES THAT HE LOVES HER. SYLIA REJECTS HIS OFFER TO BECOME CO-RULER OF THE WORLD AND OPENS FIRE, BUT LARGO'S BODY MELTS WITH SYLIA'S SUIT—AND HER MIND. INSIDE A VIRTUAL REALITY REALM, LARGO TRIES TO SEDUCE SYLIA TO HIS CAUSE, CLAIMING THAT BOOMER REPLACEMENT OF HUMANS IS THE EARTH'S ONLY HOPE.

MEANWHILE, THE OTHER BOOMERS BEGIN FUSING WITH THE KNIGHT SABERS. HOWEVER, THIS PUTS THE GIRLS IN CONTACT WITH SYLIA. WITH THEIR MORAL SUPPORT, SYLIA SNAPS OUT OF THE VIRTUAL WORLD AND FIRES, BLOWING LARGO'S BODY TO PIECES. THE OTHER KNIGHT SABERS THEN MAKE QUICK WORK OF THEIR OPPONENTS, AND THE BRÜM-BAR GRINDS TO A STOP BEFORE THE FINAL REACTOR WALL.

AS SHE FLIES OFF TO VISIT MACKIE IN GERMANY, SYLIA REMEMBERS HER FATHER'S DREAM—AND LARGO'S WARNING THAT HUMANITY MAY YET DESPOIL THIS BEAUTIFUL PLANET.

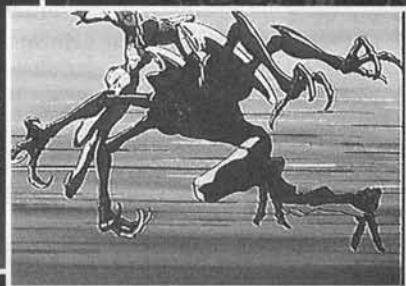

WELCOME TO 2034



"Now! begins the unending dream"

— Unending Journey—Time of Beginning, 2034

2034 began as the year of the cyber-consumer. Led by a profit-hungry Genom, every corporation fell over one another in a race to release the latest in mass-marketed slick-packaged cyberproduct. Virtual people, boomers with built-in coffee makers, massage boomers, cyber-kun power boosters, dirt-cheap artificial organs—first-quarter technology stocks went wild, allowing canny brokers to make unprecedented profits.

Domestic boomers were selling like hot cakes, priced so cheaply even a small business could afford a brand new model. With fewer people purchasing (potentially dangerous) recycled boomers, boomer rampages were also down—and the average citizen began to doubt the need for agencies like AD Police.

As a new spirit of throw-away consumerism swept the developed world, mediacorps even revived the idol singer, and the closed doors of the corporate music industry suddenly gaped wide to sign up fresh new talents to feed the expected fad.

More serious developments were also at hand. The global high technology sector was ebullient, buoyed by accelerating consumer boomer sales. A new spirit of corporate cooperation seemed to be in the air. Rumors flew about the net that Genom, Omni, Zone Corporation, and Stephan Labs were about to announce the development of a new AI, one that heralded a new generation of stable, super-intelligent boomers that would be good friends and partners of mankind. The Technologically Integrated Economic City program had taken another giant step forward, as the first of the underground

Hyper-Intelligent Spaces opened to the public. Not the dark troglodytic cavern some had feared, MegaTokyo's Geo City is a green, spacious fairyland. But its golf courses and residential plazas were priced out of the reach of the average citizen, a dream community surrounded by gates and guards

"Mankind will likely befoul and destroy this beautiful planet."

— Largo, AD2034

Shortages continue to plague the world of 2034. In Japan, and indeed in many developed nations with a low birthrate, the labor shortage continues. In the "poor south" of Africa and South America, there is no shortage of people, but there is of skilled labor and education, while rising sea levels—thanks to global warming—threaten coastal cities. Overcrowding is a problem everywhere, as people pour into the megacities, straining limited resources.

Ecological catastrophe continues to loom. The average citizen is still more worried about jobs or boomers or crime than the environment—but what about those privy to secret environmental studies performed by corporate supercomputers? So far, the world remains in a precarious balance, as human technology struggles to repair humanity's ravages. Ultimately, terraforming techniques, labor boomers, and nanotechnology planned to reshape Mars or Venus may be deployed to repair the Earth. Things aren't that bad—in MegaTokyo or London or New York, most days you can see the sun and breathe the air without choking. But in many developing nations, the situation is far worse—and there are some who suspect that developments like Geo-City are not simply a solution to overcrowding and stratospheric land prices, but also represent a corporate plan for humanity—burrowing underground to escape ultraviolet radiation, acid rain, and polluted air.

▼ THE BURSTING BUBBLE

In MegaTokyo, the optimism of the first few months of 2034 turned to terror. Over a period of a few weeks, a series of power-armored bank robberies sent shockwaves through MegaTokyo's stock market, as gold and advanced AI components were stolen. This was followed by a frightening tidal wave of boomer malfunctions culminating in a brief "revolution" in which thousands of people lost their lives and billions of yen in property damage was suffered. Confidence in boomers was severely shaken, and many boomer-related stocks took steep nose-dives. Genom and Zone Corporation initiated damage control statements attributing the "Boomer Revolution" to a terrorist computer virus rather than any flaw in the boomers themselves, and most people believe the terrorists were connected with the so-called "Illegal Army." A laboratory in Germany is already rumored to be offering cutting-edge anti-virus "counterprograms" to protect boomer AI's against such problems. Genom is expected to be planning a massive ad campaign to restore public confidence.

Nevertheless, the "Boomer Revolution" has shown how vulnerable society is to techno-hijacking, whether by computer virus or fusion boomer—in a world where orbital satellites, fusion reactors, the Tokyo-Net, police boomers, even your friendly neighborhood coffee-boomer can turn against you, how can you be secure? Cyberdroids and the omnipresent Net have been so thoroughly integrated into society that to remove them would be akin to a man with a collapsed lung unplugging his life support.



Perhaps most frightening is the realization that the attacks were the result of a small group of terrorists, not a nation or corporation. Quincy just wanted to *own* the world. Largo and others of his ilk seek to destroy mankind

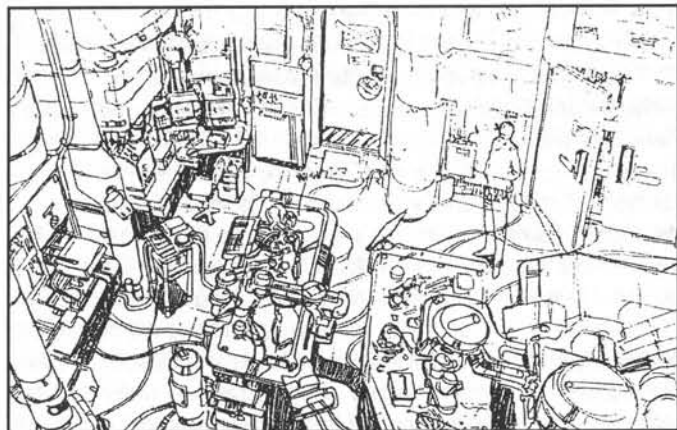

▼ DIFFERENCES IN 2034

"It's the labor shortage. I hear these cheap boomers are selling like hot cakes."
— Inspector Daley Wong, AD2034

The more things change. For all the economic and terrorist turmoil of 2034, there have been few earthshaking changes in the last twelve months, but some new social trends have begun to emerge.

▼ CYBER FUNK AND IDOL SINGERS

The latest corporate-sponsored street fad sweeping the global village, cyber funk is a fusion of rap and disco featuring funky dance music, repetitive lyrics, aerobic dance, and strobing computer-generated videos. Cyber funksters sometimes wear VR helmets or video glasses so they can watch their band's music videos all day. Major bands include Cyber Funker, Russia, and Rapid Eye Movement (not to be confused with the 20th century band with similar initials).

Rivaling cyber funk on the 2034 pop charts is the return of the idol singer. With her frilly dress (most are female) and teenybopper lyrics, the idol singer's as substantial as a soap bubble and just as filling, a synthetic supernova rocketed into stardom on a tidal wave of corporate promotion only to collapse back into obscurity the moment the fickle teenage public gets bored. But popular "idol hitmakers", like the famous Fuyumoto, always have another in the wings. Idol singers aren't trusted to write their own songs—instead they're produced by studio hacks or professional composers, who often use computer demographic studies and teams of psychologists to choose the songs that will appeal to the lowest common denominator of modern youth. Singer/songwriters like Priss and Vision would rather die than be turned into idols.

▼ JAPAN'S BRAIN DRAIN

In 2034, the locus of cyberdroid research is showing signs of shifting away from Japan to Europe. In particular, the cutting edge boomer research laboratory of Dr. Geary (a colleague of Dr. Stingray) in Germany is attracting some of the best up-and-coming scientists in the field of artificial intelligence. One of the reasons for this is the destruction by satellite weapon in 2033 of the GPCC center, the heart of Genom's cyberdroid research and development program. While the

loss of lab facilities was serious, far more critical were the deaths of many of Genom's most talented research scientists. Genom is actively recruiting and offers superior salaries and benefits, but its recent history of terrorist incidents and research accidents must certainly contribute to many people's choice of Germany as a safer and friendlier work environment.

▼ THE HIDDEN COST OF BOOMERS

While Genom may be losing its edge, it still controls the lion's share of the world cyberdroid market. Its new range of domestic and labor boomers aptly demonstrates this, being cheap enough that even small businesses can afford a new (rather than recycled) boomer. While not very bright, the boomers are easily capable of performing tasks such as waiting tables, cleaning houses, and construction work.

In developed nations, these boomers are increasingly displacing unskilled migrant or "guest worker" immigrant laborers and domestics. This threatens to have a destabilizing effect on those developing nations that export surplus migrant labor to their wealthier neighbors—in fact, without that safety valve, some sociologists are predicting increased domestic turmoil and even revolution in several already troubled Third World countries. Genom is naturally concerned, and has offered to make military and combat cyberdroids available at low prices to those Third World governments worried about possible insurrections.

At the same time, the increased availability of inexpensive cyberdroids has allowed racist or nativist political parties in wealthy nations to make a more compelling case for limiting foreign immigration. Who needs troublesome foreigners when you can use reliable machines? Of course, Genom has repudiated media stories linking it with donations to right-wing political parties in Europe (particularly those who oppose Arab and Eastern European immigration).

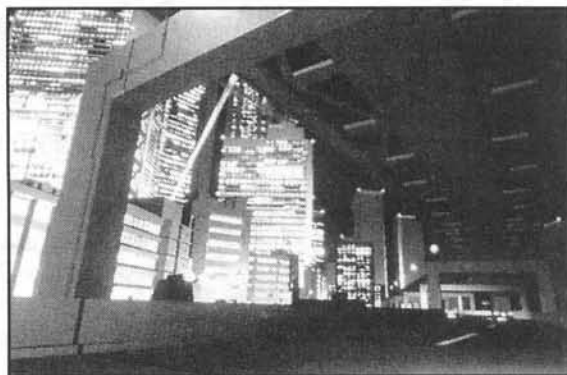

WALL-TO-WALL BOOMERS

"I wish the company would quit buying these cheap boomers! I swear, these boomers break down all over the place!"

—Construction foreman, AD 2034

Genom's new mass-market boomers are mainly C- and D-class designs optimized for the domestic, labor, and security market. The AI's of these cheap boomers represent a quite different path in design. They make much less use of organic components, and their stripped-down computer brains are much simpler (AI level 3-4 at best).

The goal of this was as much product safety as low cost. While a cheap AD 2034 C- or D-class boomer is just as likely to malfunction if it is abused, damaged, or overworked, Genom estimates it is 5-10 times less likely to suffer program degradation resulting in severe mental dysfunction (i.e., going berserk) than previous models. Does this mean fewer boomer incidents? Not exactly—the way sales are going, there are 5-10 times as many boomers in use now!

Genom's marketing division has built up the "safe and friendly" image of their mass-market boomers. While most aren't bright enough to hold an actual conversation, they've been programmed to respond to pleasantries and to be very polite. By 2034, many office workers are on a "first name" basis with their secretarial, parking attendant, or security boomers. This attitude did not survive the boomer revolution—afterward, most people were back to thinking of boomers as useful but potentially dangerous. The average mother tells her children "watch out for cars and boomers" before sending them to school.

The cheap boomers are undoubtedly a commercial success—in fact, they are so omnipresent that some people think major cities like MegaTokyo are going to have more boomers than humans in a few years. Although the brains are more reliable, they are also a lot dumber. Sure, they aren't as likely to go crazy—but they're a lot more likely to do something stupid, like leave a spoon inside a hot dog they're making or walk into traffic and be run over.



"Even though they look like human beings, they've got no more brains than an orangutan."

—Leon McNichol, AD2034

Also, many of the new built-in features (coffee makers, for example) are less than reliable, while the boomers also require frequent battery recharging, and often are unable to do so without human supervision. There's been some speculation that Genom has been rushing the new models into production to earn the capital it needs to finance reconstruction of the destroyed Genom Towers. The short battery life has led to the marketing of various accessory power packs for boomers, such as "Cyber-Kun", a popular clip-on power booster that can enhance a boomer's endurance.

In order to function better, many cheap boomers are designed to periodically contact a more sophisticated "supervisor" computer at their manufacturer via modem, usually during downtime when they are recharging their batteries—this is a form of "online support" except that no human is involved. The supervisor analyzes a log of what the boomer did over the last few hours, and pinpoints "bad" strategies and corrects them so the same errors don't happen again; updates may also be disseminated to other boomers. In essence, this allows Genom to sidestep the problem of fitting a "cheap brain" into a boomer. Ironically, this "error checking" system is one of the major reasons that Largo's boomer revolution virus spread so fast, since it allowed the virus to enter the boomers via the Tokyo Net. Whenever the boomers stopped to recharge, they also downloaded instructions which told them to pour hot coffee on people and yell, "Viva la Revolution!"

▼VIRTUAL PERSONALITIES

"Hi! This is D.J. Tommy with the evening news!"

—D.J. Tommy, virtual personality, AD2034

2034 has seen not only a boom in cyberdroid sales, but the rise of computer-generated personalities—and their acceptance by the public as media stars. The most popular one is D.J. Tommy, an artificial newscaster.

A "virtual personality" is a program written with its own character and which has developed a kind of sentience. Most virtual people also computer-generate some form of image or icon as their "body", but with the right software they can literally look and sound like anything.

Why virtual people? Well, if you've going to put an actor, presenter or other performer onto TV, video, a CD, or the Net, his image and voice are going to be converted into digital signals anyway. If you have a good enough computer, why not dispense with the performer and synthesize the entire image? That way you don't have to pay him any salary, and the virtual person can be erased or modified if he gets out of line (in theory).

GAME NOTES: A virtual person is a "lesser AI" (BGC p. 69)—its intelligence levels are about the same as a human being's (AI level equal to the POW of computer, usually 6-8) or smarter boomer. Since they're mainly used in the entertainment industry, many of them have been programmed with or encouraged to develop deliberately quirky personalities and speech patterns. This has endeared them to the viewing public—in many ways they are the "human face" of AI's, funny, fumbling, and non-threatening. A few cynics believe that virtual personalities like Tommy represent an example of deliberate social engineering by companies like Genom, in order to lull the public into acceptance of non-human intelligence.

GENOM IN 2034

In 2033 the Genom Production Control Center (GPCC) in MegaTokyo and the Genom Towers in Berlin, Chicago and Sydney were destroyed by Largo. Their rebuilding and the need to hire personnel to replace the casualties consumes most of Genom's energy and capital. Genom expects GPCC will be repaired by 2035 and the wrecked Towers partly operational by 2036-2037.

Since the Towers burrowed deep into the ground, their foundations remained intact, which has sped up the rebuilding. In fact, some personnel (and boomers) in underground levels survived the attacks, although many were buried alive and died before they could be dug out. What if some boomers or superweapons are *still* buried—or were reported "destroyed" but were salvaged by Genom splinter factions eager to dethrone Quincy?

▼ GENOM AND BOOMERS

In 2034 Genom marketed a new range of cheap boomers (see the previous page). The brisk sales of these low-cost cyberdroids is what financed the reconstruction of the many destroyed Genom Towers, but the rushed production schedule and lack of many of Genom's brightest scientists (who were killed at GPCC) contributed to quality control problems—and their cheaper brains were vulnerable to Largo's virus.

The resulting "Boomer Revolution" did little *physical* damage to Genom, although some MegaTokyo personnel were killed or injured by boomers. However, its reputation was damaged, resulting in a sharp decline in sales in mid-2034 and the crash of weaker associated corporations (such as Omni). Genom is now in the process of attempting to bail out or buy up these corporations, but its lawyers are also busy fending off thousands of liability claims and lawsuits! Genom's relative weakness may now encourage corporate rivals like the Chang Group to steal contracts, markets, or entire companies away from it. However, a wounded lion is more ferocious than ever, and a money-strapped Genom may be more likely to resort to covert "black operations", hoping to crush the first challenger utterly and send a strong warning to others.

▼ GENOM AND THE KNIGHT SABERS

Since the death of Brian J. Mason, Quincy and Sylia seem to have maintained an undeclared truce. There have been no more attacks on the Knight Sabers by Genom or its employees, while the Knight Sabers have similarly avoided open conflict with Genom. In fact, by eradicating Largo (twice) and quickly halting the Boomer Revolution, the Knight Sabers (while trying to save MegaTokyo) also ensured that Genom would survive as a company.

It's quite possible that Quincy now regards the Knight Sabers as "useful." By carefully leaking selected information to Sylia's agents on the plots of ambitious subordinates and/or Genom splinter groups, Quincy may believe he can manipulate the vigilantes into crushing his rivals—in essence, doing his dirty work for him. Due to the Sabers' well known enmity for Genom, no one would ever believe that they were really doing Quincy's will... or is all this just a plan of Sylia's to get her closer to Genom's inner circle in an attempt to defeat the structure from within?



▼ GENOM'S FUTURE

So, after the destruction wreaked by Largo and the subsequent reconstruction, what is Genom plotting for 2034 and beyond?

- **PR BLITZ.** Genom's advertising and media divisions are embarking on a massive public relations campaign to repair their corporate image as makers of "safe" boomers. They emphasize the revolution was the work of terrorists with a computer virus, not Genom's hardware. And if any muckraking journalists, lawyers, or politicians have contrary opinions, or discover the links between Largo, the Boomer Revolution, and Genom, they'd better stay very quiet, or suffer an unfortunate accident

- **ADAMA'S AI.** Through the Zone Corporation, Genom will be privy to some (if not all) of the secrets of Adama's AI. However, Genom does not want boomers that are *people*—it wants better slaves! Therefore, Genom may be working on boomer AI's which are as smart and *stable* as Adama, but without his annoying moral scruples. Some research may be aimed at putting an Adama-style AI into battle or combat boomers, while others may be aimed at boomers that can act as corporate executives or scientists. What if you put an Adama-style AI into a sexaroid?

- **QUINCY'S HEIR.** Genom has suffered a lot of attrition among senior executives over the course of 2033. With the death of Mason, Quincy has no right hand man. If Kate Madigan (*BGC* p. 95) survived, she may have been promoted to this post—otherwise, it's wide open. Will Quincy find an executive he can trust, or will the other members of the board blame Quincy for some of the 2033-34 disasters and attempt to engineer a coup? Since Quincy offered a job to Largo, perhaps he considers the rest of Genom's senior boardroom to be dominated by spineless yes-men. If so, his choice may be an outsider. In fact, what if he decided to tempt Sylia herself with the offer—and how would he react if she refused?

- **DR. GEARY'S LABORATORY.** In Germany, Mackie and Sylia have resumed their father's research at Dr. Geary's laboratory. If they are able to develop (and patent) true "second generation" boomers superior to those manufactured by Genom, this would be a tremendous blow to Genom's market share. It's quite likely that Genom may instigate overt or covert operations to purchase, steal, or sabotage any new inventions. This could open a new chapter in the ongoing conflict between Genom and the Knight Sabers

MEGATOKYO 2034

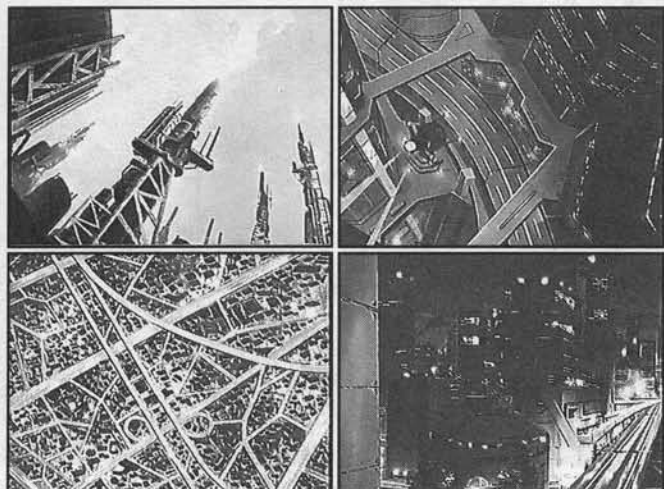

"The ostentatious city they created with the technology they produced"
— Largo, AD2034

Aside from the completion of Geo City, there haven't been that many changes in MegaTokyo since 2033, but a few places have risen to prominence:

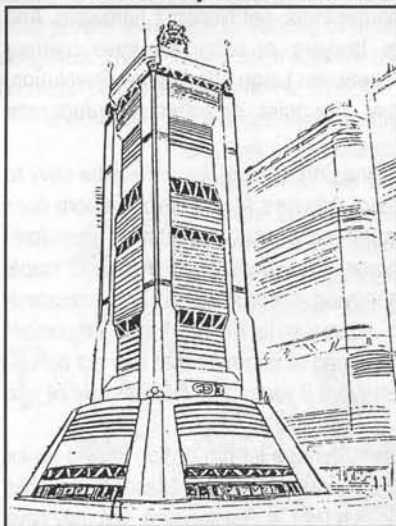

MEGATOKYO CENTRAL DATABANK BUILDING:

This giant structure houses the computers that maintain the Tokyo Net (along with the workers who maintain them). There are also offices devoted to information analysis (such as census data) and to backup electronic and hard copies of everything from property to marriage records. In 2034, the building was partially absorbed by Largo's Fusion Boomer, then damaged by the Knight Sabers.

DR. YURI'S BUILDING: A narrow condo-like building, about five or six stories high, in District Seven. It's usually dark at night, with only a few windows lit. Yuri's personal boomer-research lab is near the top, filled with computers and equipment closets. The basement has computer-locked cradles for combat boomers and connects to MegaTokyo's sewer system. With Yuri dead, who will inherit it?

IMPERIAL HOTEL: Located in central MegaTokyo, this is the best known hotel in the city. As well as high-priced rooms and suites, exclusive dining rooms can be rented by anyone who would like to hold a private feast.

GPCC CONSTRUCTION SITE: Massive reconstruction is underway at the ruins of the Genom Production Control Center (*BGC* p. 150).

SCIROCCO: An upscale restaurant known for its excellent pastries, cakes, ice cream, and other desserts. When she can afford it, one of Nene's favorite places to eat.

GLORY BANK: This is a major financial institution located in the Kabuto area. Its high-security armored vaults hold over 30 billion yen worth of gold bullion, as well as safety deposit boxes that can contain everything from valuable bonds and securities to AI components. There are usually a pair of Guardian boomers on duty outside, with more on guard inside the bank. Despite their visible presence, Glory Bank insures its boomers are polite and well-mannered, which suits its high-class clientele.

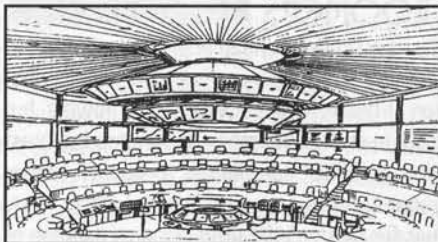

AMAROK STOCK CO. BUILDING:

This is the asian-sphere headquarters of the large, influential stock brokerage house. While employees enjoy an unusual amount of

freedom, physical security is tight—if this place were taken over, financial havoc could be wrought.

STUDIO OMEGA: A recording studio where Priss demoed her new songs. The record company execs have a short attention span and prefer a pretty face to original music.

STORM SEWERS: MegaTokyo's extensive storm sewer system consists of a citywide web of dimly lit brown or rust-colored passages (many of them 3-4 meters wide) connecting large, multilevel chambers. Access is provided by ladders and manholes—some buildings also have subbasements that lead directly into the sewers; the sewers also connect to parts of the MegaTokyo subway.

Except on rainy days, the sewers are relatively clean and dry. Pumping stations and maintenance shacks are sealed off by armored doors equipped with computerized locks, but may contain repair equipment and boomers. As the sewers are usually deserted, they should not be overlooked as a rapid means of covert travel for squads of combat boomers or armored vigilantes.

"PISS" COFFEE HOUSE:

This is a typical coffee bar and restaurant that serves light meals. It's frequented by all sorts, including off-duty police officers, but watch out for the cute-but-buggy coffee-boomer

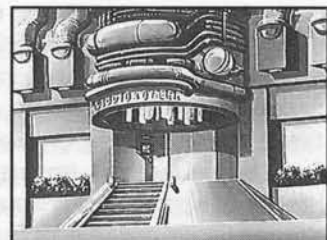

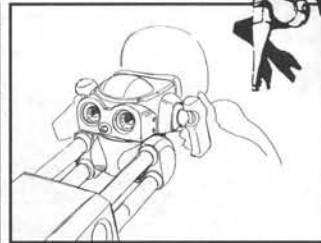
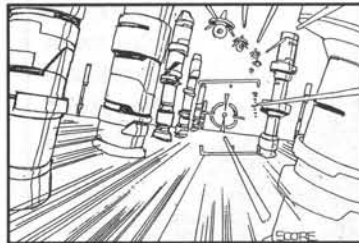
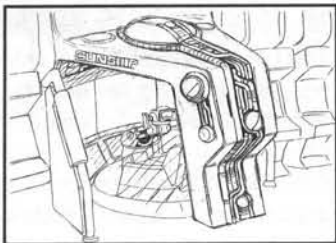
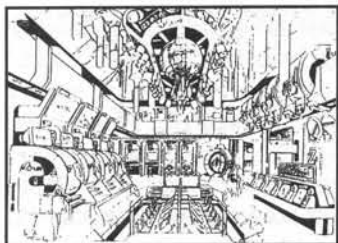

MEGATOKYO GAME CENTER: This is an arcade megaplex located in downtown MegaTokyo. The games feature state-of-the-art arcade consoles and are played with the aid of virtual reality optics, or goggles and gloves. The games include fighting games, shooters, RPG's, flight simulators such as the popular "Gunship", and others.

The center is a good place to meet teenagers and young computer hackers such as Nene. The terminals are all connected to the Net, so as to allow multi-player games and challenging someone at another Center. However, someone skilled with computers can also get into the system remotely—Sylia casually hacked into Nene's console to communicate with her (although she may have learned this trick from Mackie).

TOKYO ATOMIC PLANT: The "Hearth" power plant (*BGC* p. 145) suffered minor damage to its containment walls from Largo's attack. It's likely that more secure defenses will be erected in the future.

STEPHAN LABORATORIES: A research complex associated with Zone Corporate. They were subcontractors in the Second Generation AI project that produced Adama. In 2034 their building was the site of the showdown between the Knight Sabers and the Illegal Army, and suffered minor damage as a result.

SIMIZU BUILDING: This District 3 highrise office building is still under construction. The labor boomers working here were among the first to be possessed by Largo's AI virus.

USED BOOMERS SHOP: Located in District 7, this garage-like shop is a good place to buy or sell second-hand cyberdroids, no questions asked. It's often frequented by local street punks. The owner is not fussy about accepting stolen goods, but drives a hard bargain. The interior of Used Boomers is dark and crowded, filled with deactivated boomers, lit only by the lurid glow of a computer console or the bright pulse of a laser cutter as a hapless boomer is chopped up for parts.

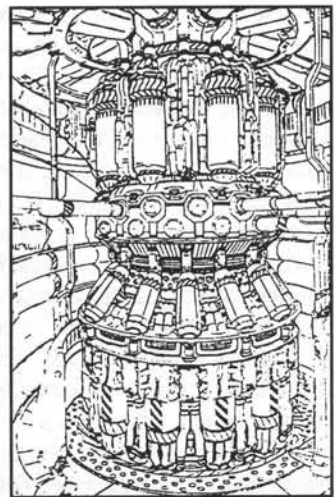

▼GEO CITY

"There's no horizon to be seen; it's obscured by buildings. Fly away, to a city with neither darkness nor sun." — "Fly Away"

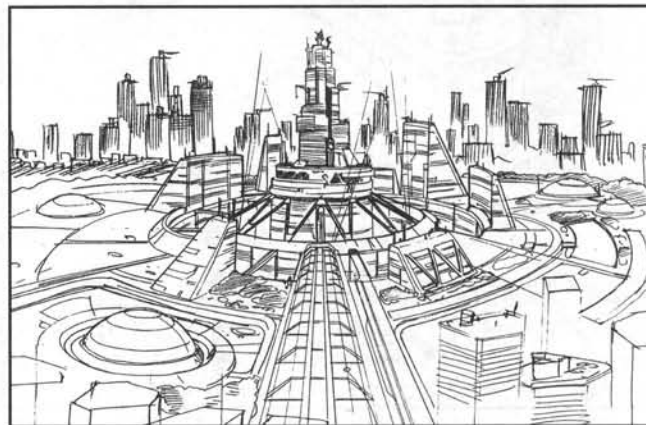

The cancer-like spread of urban centers such as MegaTokyo have reached their natural limits. To devour any more rural land was economically, psychologically, and ecologically unacceptable. In MegaTokyo, the situation is so bad that even the dead are now buried on rooftops. But an organism dies if it cannot grow

Cities could and still do grow skyward, but structural limitations have restricted skyscrapers to a certain size without massive foundations. Unfortunately, the effort required to produce more than a few man-made mountains such as Genom Towers is financially unacceptable. Nor could a city support many such megastructures without them literally blocking out the sun!

For coastal cities, expansion into the ocean was one option, and several such programs have been undertaken. Already many cities have floating space and air ports, or have begun expanding into bays, sometimes even creating artificial islands out of garbage. Actual floating cities, such as Genom's AquaCity project, are a natural development. However, the vulnerability of aquacities to tidal waves (and terrorism) and the threat of rising waters from global warming have made such efforts risky, and the spectacular destruction of AquaCity in 2032 put a temporary damper on further oceanic expansion, at least in Japan.

"Say what you like, but there's no more open space left aboveground. It's underground from now on, I tell you."

— Linna Yamazaki, AD2034

Increasingly, city planners are finding their solution to be a chthonian one, burrowing as much as a third of a kilometer under ground. Late 20th-century and early 21st-century megaprojects such as the Channel tunnels between England and France provided the technological know-how. These were followed by similar vast "underwater highway" projects in Japan. The move underground has spurred

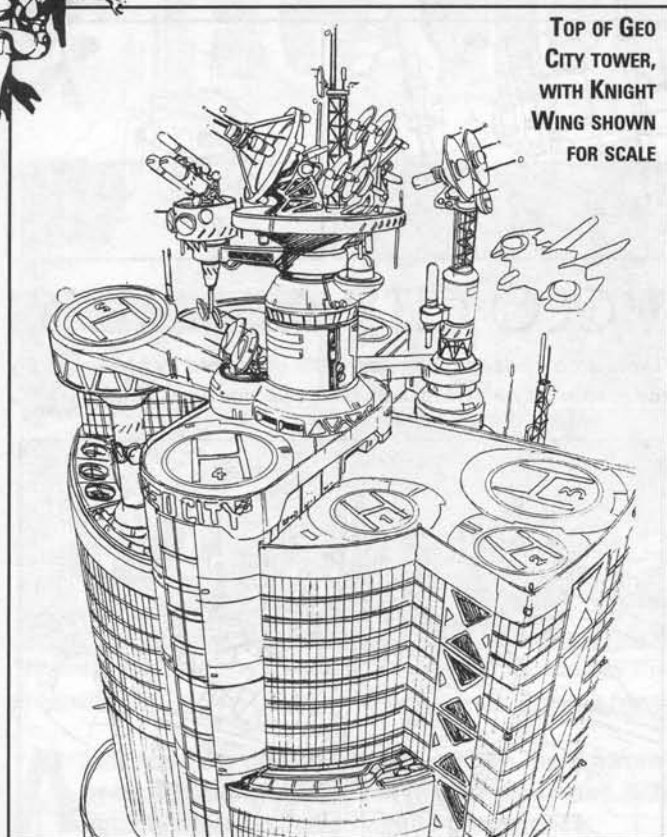

TOP OF GEO CITY TOWER, WITH KNIGHT WING SHOWN FOR SCALE

the creation of specialized technologies. Using techniques developed in projects such as the second Channel tunnel, a whole range of new underground equipment was developed, such as the Brüm-Barr boring machine (p.95).

An underground city does have one vulnerability: earthquakes. However, many areas of the world are geologically stable. In Tokyo, the site of the first major such development, most experts believe that another major earthquake is not due in the region for decades, and that by that time, advances in earthquake prediction and prevention will be at hand. That's the theory, anyway.

"Welcome to Geo City. Descending 300 meters into the ground, this giant underground city establishes a new form for Tokyo. Completed just this year, this Hyper-Intelligent Space is but a single element of the Underground Development Plan."

— Geo City promotion, 2034AD

Geo City is an enormous underground arcology, the intended keystone in MegaTokyo's future development. The structure consists of a large highrise tower complex above ground and multiple underground levels. The main goal of Geo City's designers was to make it *comfortable*. While some basement power and storage levels are a maze of corridors, the largest part of Geo City is taken up by enormous cathedral-like areas filled with shopping plazas, parks, apartments, and even golf courses, which give a true sense of space.

As a "hyper-intelligent space", Geo City's climate, security systems, doors, elevators, and lighting are all controlled by near-AI computers, and domestic boomers and other robots are everywhere. As psychologists have demonstrated that light levels are of major importance in a community's health, the artificial lighting in Geo City is selected to closely resemble sunlight—in fact, much of it *is* natural sunlight, conducted underground by a fiber optic tubes.

▼ TRANSPORTS

Geo City is linked to the rest of MegaTokyo by highways and the subway, both of which run directly into the complex. Within Geo City, high-speed elevators connect the different levels. Geo City is a gated community, with fences separating the complex from MegaTokyo proper, and manned guard posts on the highways leading into it. While most of Geo City's commercial district is open to the public, its security will keep out undesirables such as street gangs.

▼ FACILITIES

Geo City contains an amazing range of facilities. In fact, almost anything you want in a community can be found there, from day care centers to four-star restaurants. Among the many features are:

- **Golf Courses:** These green spaces are very popular with the elite of MegaTokyo, where golf is as much a status symbol as a boomer bodyguard. The most modern course in Japan, the Geo City golf course features computerized holographic scoring and friendly boomer caddies. Annual memberships are expensive, but can be defrayed (or a profit made!) by renting out use of your golf membership to the less fortunate.
- **Health Spas:** After a spin around the golf course, soak in one of Geo City's relaxing saunas, then enjoy a soothing massage from its state-of-the-art massage boomers.
- **Shopping Districts:** Geo City has some of the most exclusive shops in MegaTokyo—if you want the latest in designer sportswear, elegant business furniture, or consumer electronics, don't look any farther. But don't expect bargains—rents in Geo City are high, and prices match them.
- **Laboratories:** Portions of Geo City have been leased to university and corporate research facilities. Perhaps the most famous lab is the boomer research facility of the late Dr. Haynes, where he and his staff were murdered in 2034. The lab contains a very advanced supercomputer (POW 9). After Haynes' death, the lab was temporarily shut down, but it is likely that Zone Corporation or Omni—partners in the AI project—will reopen it.
- **Military Staging Area:** Yes, Geo City has everything, including soldiers! USSD and Japanese Self Defense Force maintain a small military base. This includes a testing arena with reinforced walls and armored glass windows, accessed by multiple elevators. Here the military performs secret tests of new combat boomers and powered suits. The military are also tasked with providing aid to civil powers (AD Police, paramedics) in the event of any disaster—there are usually a half-dozen combat boomers and a few squads of soldiers on duty at any time.

▼ SECURITY

Geo City is a technological jewel in MegaTokyo's crown, but it's also a headache for the AD Police. Geo City uses more boomers per square kilometer than any other place in MegaTokyo. Its attractiveness as a residential and shopping area for some of MegaTokyo's wealthiest citizens as well as the presence of military and corporate research and development facilities, makes it a prime terrorist target. Geo City does have high-speed elevators for evacuations, and its own underground hospital and fire station, but its underground location means that in the event of a boomer or terrorist incident, AD Police would be severely limited, with no room to deploy helicopters and many elevators and corridors too small for a K-suit. This means sending in frontline officers on foot—and while the military has promised assistance in the event of a threat, veteran officers like Leon are cynical enough to suspect the Army would either try to take over management of any incident or be more concerned with protecting visiting generals or scientists than helping citizens.



▼ MEGATOKYO'S CYBERPUNK UNDERGROUND

"Little miss cyberpunk!"

— Linna Yamazaki, AD2034

MegaTokyo's cyberpunks haven't vanished. Some have sold out or gotten lives, but many of the silicon-and-metal lowlifes of the 2020's remain. No longer welcome on the streets of MegaTokyo, they've literally gone underground. Now they prowl the city-within-a-city hidden in the fissure left by the Kanto II quake: the Outer District, the last refuge of technology's refuse.

Timex City and the Outer District are described on *BGC* p. 165. In 2034, with MegaTokyo on the fast track to prosperity, the Outer District is the place where the city dumps its past and squanders its future.

That wasted street person mumbling to herself on the corner might not be on drugs—as likely she's in the early throws of boomer syndrome. Look for the crystal eyes or the cable jack; it's just another kind of needle track. The older folks are burnouts left over from the 2020's—no need to tell them, they all know about boomer syndrome, but it's too late, they've already traded in the meat. Maybe one of those feral street kids is hers—see them eyeing that cleaning boomer? If the owner doesn't watch it, soon it'll end up in a chop shop for 2,000 yen, and the kids'll buy the latest cyberfunk disk—or maybe a soyburger, if they haven't eaten today. What about those fellows in the nice clothes, with the nervous sidewise glances? They're just shoppers from MegaTokyo. Black market electronics, boomers, prostitutes, drugs, and artificial organs—it's all for sale.

It's said that a few of the smarter boomers infected by Largo's virus were never recaptured and ended up here. Is that fellow with the red crystal eyes and the rising sun headband a cyberpunk or a boomer? He's built like an ox—but maybe he's just using growth and muscle hormones—you can buy them like candy down here, just like the growth restraint pills. See that group of kids shooting hoops with a boomer's head? Some of 'em have been 12 years old since the Big Quake. Time's funny here. The days are short and the nights are filled with neon and mechanical laughter.

When Genom began selling its cheap, brand-new cyberdroids, many owners sold off their old models to buy the shiny new ones. Most of the used boomers went to legitimate recycling shops, or even back to Genom for a small rebate. But if a boomer was unstable, or had already been recycled once or twice, no legitimate operation would take it. They ended up clogging the junk shops of the Outer District, sold for scrap, even dumped on the street. With so many obsolete boomers around, it wasn't long before people began to find uses for them

▼ CYBER-FIGHTS

You see those "Cyber-Kun" ads with the boxing boomers? Cute, but this is for real. Take two down-and-out boomers, rent an old warehouse as ring, and order them to dismantle each other—fists, chain-saws, anything goes. On a good night, you'll see 200 screaming fans packed around the ring, paying 5000 yen a piece for standing room only. The winner gets a cut of the ticket sales; the loser can sell what's left for junk. But the real action is in the betting, with odds given on boomers based on their models and conditions. Of course, there's always a chance the battling boomers will get a bit *too* peppy and go



after the crowd—but you like to live dangerously, right? Some places have a few Yakuza soldiers or a moonlighting AD Police officer standing around with heavy weapons, just in case.

▼ CYBERPARTS

Cyberware is no longer socially acceptable or commercially popular, but black market chop shops exist that provide the Edge culture with custom cyberware ... including salvaged parts from boomers. Integrating obsolete boomer parts into your body isn't safe—but it is *cheap*. Now you know why the Outer District is the only place in MegaTokyo where boomer syndrome is still one of the top ten leading causes of death. (see p. 102 for game rules on cyberware)

▼ BOOMER PROSTITUTES

Her plastic skin is starting to peel off and her programs are a little frayed, but this is Timex City: In the dark, you can pretend she's real. Obsolete boomer prostitutes are a common sight at sleazy bars or on street corners. Most are a bit confused, but that's not surprising—once a beautiful doll, now she's too messed up to be worth recycling. Her only purpose is to satisfy the indiscriminating and bring the yen back to her owner—unless she's a stray on her own. Either way, the hormonal rush is gradually burning out her biochips—but if she flips out with a customer, who's going to care? Anyone desperate enough to pick her up won't be missed.

▼ BOOMER KIT-BASHING

Some frustrated technoartists salvage boomers from junk shops, buying cyberdroid wreckage even recyclers don't want. One exotic dance club owner bought a sexaroid real cheap—she didn't have a head. He hired someone to run cables from her spine to the bar's sound system computer. Now she dances on the stage, a headless puppet on fiber optic strings. There's a blind cyber-sculptor who reworks boomer heads into living clocks and desk lamps. Salarimen with billion-yen incomes come all the way to the Outer District to buy them. A Yakuza lady once had him sculpt a lamp using a combat boomer's head—it was gift-wrapped and sent to an executive known to collect these toys, and who had reneged on gambling debts. When the lamp was plugged in, the BU-55 opened its eyes, and then its mouth—its laser had enough power for one shot.

Welcome to the Outer District. Not much has changed, really

AD POLICE 2034



"You, too, can be one of the elite! Join AD Police, for youthful adventure!"
—AD Police ad on video blimp, AD2034

"Dying with your boots on isn't very trendy. Besides, you can't spend your own insurance money."
—ADP officer, AD 2034

By 2034, the AD Police has been stereotyped as incompetent boomer-fodder by the MegaTokyo media. Lisa Vanette's somewhat biased coverage aside, the temporary 2033 seizure of their headquarters by Dr. Miriam's rogue boomers was the last straw for most people. "If they can't protect themselves, how can they protect us?"

When Chief Todo retired, the government decided it was time for a new approach. However, too many competing interests also saw an effective AD Police as a danger, resulting in them agreeing on a choice which was no threat to anyone. Unfortunately, that also included the criminals. Rather than promote anyone up from the ranks, or, as was more often the case, find a candidate from a chief of police in another city who wanted to "move up" to MegaTokyo, they chose to appoint a retired corporate executive with experience in advertising. The idea was to have someone who could improve the police's image; the idea sold to the public was to have a new broom, an outsider who would bring new thinking. When he faced his first challenge, the result was a disaster.

The new chief has tightly controlled the use of heavy equipment such as powered suits and helicopters, for fear of offending the public and his upstairs masters. While it is possible to get helicopter or K-suit support, the new chief's insistence that he personally approve each deployment means that it is too often "too little, too late."

This "minimum force" policy came at exactly the wrong time. In 2034, a gang of heavily armed mercenaries, the Illegal Army, was on the move. In the first encounter with the AD Police, Leon McNichol's unit was caught without helicopter support—under Chief Todo, at least one chopper would have been there as backup. This allowed the Illegal Army to escape. In later engagements, when AD Police officers armed with assault rifles were gunned down—or, worse, simply ignored—by powered-armored mercenaries, morale and pride plummeted.

The ADP were used to being undergunned, but this time they felt betrayed—they had the equipment, but weren't being allowed to use it effectively. The return of the Knight Sabers ended the Illegal Army's rampage, but did nothing to restore the AD Police's reputation.

The ADP won back some of the public's trust when officers heroically responded to hundreds of boomer incidents caused by the "boomer revolution." Even so, they came close to losing their headquarters to a small number of invading boomers (again), requiring help from the Knight Sabers (again). The ADP still must overcome many problems:

- **Equipment Restrictions:** It's harder to get authorization for a powered suit. Issue of weapons heavier than a rifle or special ammunition (such as grenades) is tightly controlled. Heavy weapons such as railguns are no longer issued routinely to patrol cars, only to armored transports, and usually only one per squad; requisitioning one for a special mission by anyone under inspector rank is nearly impossible. Instead of being pre-loaded aboard helicopters, powered suits are kept in their own vehicle bays, meaning it can sometimes take ten or fifteen minutes to deploy one, even after authorization is given! For this reason, support helicopters often carry teams of armed officers rather than suits.

- **Manpower Problems:** This is most acute in the casualty-prone Frontline Officer section. Resignations and sick leaves are at an all-time high, and many squads are fielding only one third or half as many officers.

- **Low Morale:** ADP officers are more inclined to wait for backup or retreat until they have superior numbers. Some officers, such as Leon and Nene, remain as dedicated as ever, if a little disillusioned; others, like Daley, have adopted an air of fatalism. Since it's harder to get things done through normal channels, gung-ho officers are more likely than ever to break the rules—stealing weapons from the armory, hacking computers to alter inventory, or even bribing fellow officers with dessert coupons to perform illegal computer searches (well, they probably did that before, anyway). This casual atmosphere of rules-bending and contempt for the chief and senior bureaucrats can inadvertently encourage actual corruption among less dedicated officers

Despite the problems it faces, the ADP isn't going to be shut down. The huge expenditures for new equipment have made it a cash cow for Japan's defense industries, and a good testing ground for new hardware. In fact, to replace resignations and combat losses, it has embarked on a new recruiting drive. Here the new chief's corporate background has actually paid off, with high-profile advertising measures aimed at improving ADP's image. The fastest road to promotion in the AD Police these days may lie in coming up with a good PR gimmick to warm the chief's heart. Officers may be sent to organize bake sales, do demonstrations for school kids, teach boomer safety classes, and so on. There are even rumors of a possible TV series, and of getting some of the cuter young female officers to star in an idol promotion

ADP recruitment standards may also be somewhat lower in the future. A "police academy movie" situation (recruiting any warm body) is unlikely, but more boomers may join the force despite the dangers that they've demonstrated in the past.

▼BOOMER LAWS IN 2034

With the rise of boomer crimes—and more boomers—the city has introduced a few new laws. Boomers are now forbidden to ride the subways on their own (imagine a boomer rampage in the confines of a train!). To salve public fears, automatic sensor-locks have been installed on all subway turnstiles. If a boomer tries to pass through unaccompanied, even if it pays the fare, a door will slide shut (KD20, 20 SDP), blocking the turnstile until a human opens it. Still, organic android-types such as sexaroids aren't detected; it's also easy enough to leap (or fly!) over the turnstiles.

KNIGHT SABERS 2034

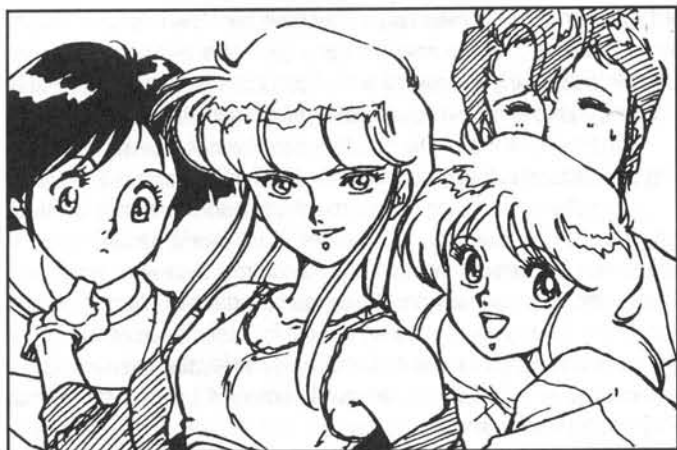

"The Knight Sabers ... You know, I haven't heard anything about them lately."

—Leon McNichol, AD2034

For the Knight Sabers, 2034 came in like a lamb, but went out like a lion. At the beginning of the year, the four members had been scattered to the four proverbial winds: Linna had quit her aerobics-instructing job at Phoebe's so that she could get rich quick at Amarak Stock Company; Priss had abandoned the underground club circuit to take a shot at a professional debut; Syla had dropped out of sight, seemingly abandoning the team. Only Nene kept the torch burning, staying on with the ADP and holding on to the ideals the Knight Sabers stood for.

As it turned out, Syla hadn't abandoned the Knight Sabers—she dropped out of sight so that she could remodel LADYS633 and create a new generation of hardsuits and other equipment. Why? Because, in the months before, Syla had been plagued by dreams of an evil version of herself named "Reishi" ("Syla" rearranged in Japanese); in her waking hours, she was haunted by a malevolent presence which even went so far as to anonymously send her flowers—it was a mock courtship which she knew would lead to an awful end. With Mackie away in Germany (Nene had given him a tearful send off at the airport), Syla knew it was up to her to prepare her team and herself for the ultimate showdown which she could feel approaching.

As one might expect, Priss' pro debut turned out to be a pipe dream—her manager had effectively "sold her out" to make her one of a nearly faceless legion of disposable idol singers. Linna's insider trading scam turned out to be equally fruitless, resulting in a speedy resignation. Nene's faith had proved to be well placed when Syla suddenly reappeared, and none too soon—when the Illegal Army hatched the first stage of Largo's evil scheme, the Knight Sabers were ready!

▼ LIFE AFTER CRASH!

Collectively, the Knight Sabers are in good personal and financial shape after *Bubblegum Crash!*. Their first new job (hired by Zone to stop the Illegal Army) was, for once, actually completed to the client's full satisfaction—as a result, their own personal fortunes are probably in good shape.

Syla after Crash! Syla has lost another old friend (Dr. Haynes) but remains committed to leading the Knight Sabers. At Mackie's urging, she appears willing to devote more time to completing (and perhaps going beyond) her father's research. With the demise(?) of Largo, Syla has no

known enemies, although she's likely to remain on guard against Quincy's long-term plans. Syla remains the only Knight Saber known to have killed a human being, adding a second notch to her list (after Mason) when she executed Dr. Yuri after he refused to surrender to her.

Priss after Crash! Priss has given up her job as lead singer for "Priss and the Replicants" to pursue a solo career, composing new songs of her own. Considering how many concerts she was late for, maybe her band finally dumped her! In *Geo-Climbers* she claims to hate all boomers (obviously she didn't even want to think about Sylvie and Anri) but getting to know Adama has alleviated this prejudice.

Linna after Crash! Linna's life has changed the most. She has given up aerobic instruction for the stock market and very much enjoys her new, more cerebral career—and the money it makes! In fact, she's taken to offering unsolicited financial tips to Syla and Priss. In a fit of pique at the Illegal Army (for causing her to lose money on Omni stock), she quit Amarak, but after their obliteration she announced plans to get a position at another brokerage firm.

Nene after Crash! Nene's life hasn't changed. For a short time, she feared the Knight Sabers were breaking up, and in her efforts to keep that from happening, she demonstrated how vital it was to her self-image. Nene's new suit design enables her to be more aggressive in combat, and for her that's the cat's meow.

Mackie after Crash! Mackie has grown up. He's moved away from MegaTokyo and is living in Germany, studying artificial intelligence systems and working at Dr. Geary's lab. During the "boomer revolution", Mackie played a vital role in developing countermeasures to defeat the new virus. He's now more self-assured, and has decided to devote himself to continuing Dr. Stingray's research. In time, it's quite possible he'll become the intellectual equal of his sister. He is very comfortable in Germany, but misses Syla (and Nene). When he'll return to MegaTokyo is unknown.

Fargo after Crash! Syla's favorite informer has been keeping to the shadows, but is still around, working overtime: Syla received dozens of job offers during the Knight Sabers' brief absence, and checking them all out to make sure they are legitimate is a full-time job!

▼ SECRECY AND INFLUENCE

In 2032-33, the Knight Sabers took careful measures to guard their secrecy, but in 2034, Syla seems to have thrown caution to the winds. While she certainly kept her plans for upgrading the Knight Sabers HQ and equipment secret (not even telling the other members), their new procedures appear to make secrecy impossible (the Knight Wing takes off from the top of LadyS633 building in a glare of floodlights in a manner that must be visible to the entire neighborhood, after all). What gives?

Well, one can always suspend disbelief—Syla's known to be rich, so it's logical she has a private airplane. If she wants to paint it black and it happens to look just like the one that the Knight Sabers fly, maybe no one will notice. Clark Kent's glasses fooled everyone, right?

There's also another possibility: Simply put, Syla is now extremely well connected. She's on good terms with the Hou Bang syndicate (thanks to Linna and Vision) and with the AD Police; as long as Quincy does nothing out of line, she's no longer opposing Genom, and he owes her for taking out Largo. More importantly, she knows a great many secrets, such as the USSD/Black Box affair or details of GPCC's weapons trade. You can be sure Syla has let it be known that all their secrets are safe—as long as no action is taken against her organization.

MERCENARIES IN BGC

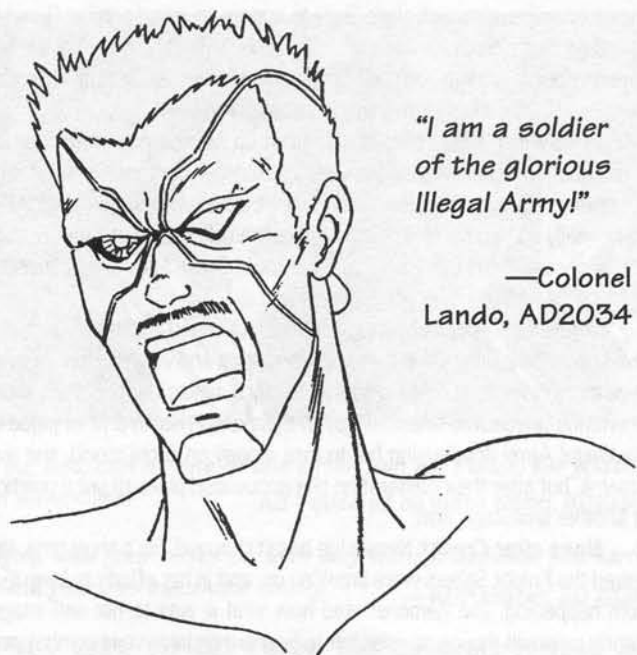

"I am a soldier
of the glorious
Illegal Army!"

—Colonel
Lando, AD2034

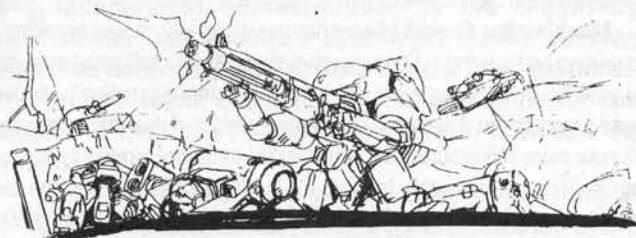

In this corporate age, teams of high-tech freelance warriors are increasingly common. Some are true mercenaries like the original Illegal Army, ready to fight anywhere and anyone for the right price. Others are like the Knight Sabers, battling as much for ideals as for money. Many are small: In the 2030's, a few mecha are worth more than a company of conventional soldiers, and are much easier to covertly transport in or out of a trouble spot.

▼WHO HIRES MERCS?

Urban vigilantes like the Knight Sabers often restrict their operations to one city. In contrast, mercenary *soldiers* travel the world to find work. Their employers include:

- **Third World Governments:** These hire mercs when their own armed forces are badly trained or of doubtful loyalty. The classic example is the Arab oil sheik with mercenary bodyguards to fend off coup attempts and track down guerrillas.
- **Developed Nations:** Countries like Japan or the United States or groups like Neo-NATO have efficient military forces, but their intelligence agencies sometimes hire mercs for a "black op" that can't be traced back to them, using a third party as a go-between (so captured mercs can't reveal who they work for). The objective might be anything from penetrating a foreign country's borders and exterminating a nest of international terrorists or criminals that are being given a safe haven there, to helping native rebels overthrow the local government.

• **Corporations:** Big megacorps may have their own security forces, but companies like Genom will often use mercenaries the way governments do, hiring a group via a third party so that if the mission fails no one can prove their involvement. Typical "deniable" ops include:

Corporate Warfare: The target is a rival company, e.g., kidnaping top scientists, stealing prototypes, or blowing up labs.

The Big Stick: Using mercs to interfere in the affairs of other countries. If, for example, an unstable Third World nation's government refused to give Genom a lucrative contract to develop a rich uranium mine, the company could hire mercenaries to help local rebels overthrow the regime. Of course, Genom is subtle: Once its mercs put pressure on the government, Genom may offer the contract again, sweetened by a promise to sell battle boomers to crush the rebels. Pity about the mercenaries

A corporation can also use mercenaries for "legitimate" missions. In these cases, the mercs will be hired openly for:

Hostage Rescue: If company personnel have been taken captive by local terrorists or rebels, a corporation sometimes feels local police are too corrupt or poorly trained (as in many poorer countries) to handle it. If so, they'll send in high-tech mercs, sometimes without the local government's permission.

Security Detail: If a nation or city is torn by riot or revolution, the corporation may dispatch mercs to guard its valuable property (offices, labs, factories, mines, plantations, airports, etc.) and act as bodyguards for its personnel.

Crime Suppression: If local criminals interfere with business and police can't stop them, a corporation may hire mercs to "take out" the malefactors and leave the bodies for the cops to sort out. The Knight Sabers were hired to do this for Zone Corporation; Genom might hire mercs to get rid of vigilantes!

▼ GLOBAL HOTSPOTS

Name a region: From Antarctica to Zaire, you can find brushfire wars and military coups. Some hotspots making mercenaries rich or dead in the 2030's include:

• **The Middle East:** Iranian-backed rebels are menacing the wealthy sultanate of Oman, which has invested the last of its oil money into power satellites and now controls a chunk of the USSD. The wealthy Sultan wants mercenaries to trounce the rebels, while his Beijing-educated brother is plotting against the throne with Chinese backing. The USSD suspects the space port at Muscat is being used as a transshipment point for battlemovers illegally manufactured at Genaros to be sold to Pakistan for a threatened offensive against India . . .

• **Southeast Asia:** The Philippines government has signed a trillion-yen deal with the Chang Group to construct a new base at the excellent Subic Bay harbor for lease to the Chinese navy. However, disaffected minorities and anti-communist rebels backed by Genom (annoyed it didn't get the base contract) and Neo-NATO (worried about Chinese expansion) are causing trouble. Genom and Neo-NATO have been

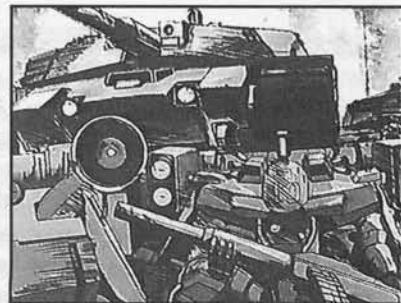

covertly hiring mercs to assist the rebels, while the Chang Group is providing support to the government army. Over half of the area of the Philippines archipelago is mountainous jungle: This is good terrain for guerrilla warfare and wonderful for testing new mecha! In 2033 the anti-communist guerrillas suffered a serious blow when government troops assisted by Chang's Kyuusei Industries battlemovers wiped out a major rebel camp, annihilating the infamous Illegal Army mercenary unit as it trained for an attack on the navy base.

• **South America—Surinam:** An army coup has just toppled the government, causing widespread anarchy. The exiled president, backed by Dutch Crown (a European corp associated with Genom that controlled Surinam's lucrative bauxite mines), is trying to put together a mercenary force to "restore the government" or rescue many hundreds of its workers trapped there.

• **Africa—Tanzarr/Zambique:** These southwest African countries used to be one nation (Tanzambique, formed in 2013 from Mozambique, Tanzania and Zambia). In 2033 the popular prime minister died suddenly (killed by a mysterious virus), leading to disintegration of the fragile multi-ethnic coalition into two nations. These are now fighting for control of a disputed border area. The losing Tanzarr is hiring foreign mercenaries to beef up its forces; its erratic president is rumored to be a puppet of his exotic mistress, whom some believe to be a sexaroid.

▼THE POLAR WAR



This is the big one. Fighting in the Polar War is for national armies rather than mercs, but the background of the war can easily involve *Bubblegum Crisis* characters. Players could become ensnared in

plots to recover or destroy superweapons being shipped there, discover secret plots by Genom to influence the conduct of foreign policy relating to the war, and so on. Playing a veteran of this frozen hell is also a good background.

The "war in the ice" began in 2026, when a series of joint Euro-Japanese expeditions discovered extensive mineral and oil deposits in Antarctica. The Antarctic Treaty that banned mineral exploitation was due to run out in 2041, and with world resources in dwindling supply, Australia, Argentina, the USA, and Europe all announced they would not re-ratify the treaty.

Several nations began prospecting and establishing mining camps, although actual drilling was prohibited until 2041. Then in 2029, a Franco-German "geological survey camp" was caught conducting illicit wildcat drilling operations, but also using an under-ice pipeline that was pumping out oil reserves from an area that was claimed by Argentina, with backing from China. When it looked like France would stall a UN investigation while German engineers removed the evidence, China acted, sending commandoes to capture the mining camp. Unfortunately, what was intended to be a surgical strike turned into a bloodbath, as French troops had already been sent to assist in "sanitizing" the drilling area. Before anyone knew it, Chinese, French, and German forces were fighting each other in Antarctica, and the Polar War was on!

The Polar War is an undeclared, limited conflict: Neither side wants to escalate the fighting beyond Antarctica, or to use nuclear weapons. About 7,000 Chinese (with allies from Argentina) and 6,000

Neo-NATO soldiers are involved. The objectives are the partially completed mining camps of the other side, as well as airstrips and supply bases. Confusing the issue are some 5,000 civilian mine workers and numerous labor boomers, including over a thousand Europeans in Chinese-occupied areas—the Chinese would like to ship them home to reduce the supply drain, but as long as the workers are there, Neo-NATO won't bomb their bases.



Much of the war is invisible, fought beneath the waves and under the ice shelf, as submarines and robot mines play hide-and-seek under the frigid waters. On the ice shelf, blizzard conditions will often ground aircraft and conventional vehicles, so most armored thrusts are made by battlemovers, powered suits, and boomers. Battles are fought at point-blank range as mecha advance under the cover of blinding snowstorms, hoping to seize control of airstrips, supply bases, or valuable mines and oil pipelines. In between ceasefires, workers rebuild the damage.

Unprotected infantry cannot hope to survive the sub-zero temperatures—soldiers wear heated spacesuits or powered armor. All food must be shipped in; when subs or fighters intercept supply convoys, starving troops in the interior attack enemy bases just for food or batteries for heaters! As cyberdroids don't eat or freeze, both sides clamor for more battle boomers. Also, risking expensive battle boomers is preferable to sending back soldiers in body bags and losing popular support at home.

• **The UN and the Polar War:** The UN keeps trying to mediate ceasefires. Most collapse, but sometimes both sides honor them long enough to build up their forces. In 2032, UNPAC (the United Nations Peace in Antarctica Command) was deployed after journalists brought back pictures showing environmental damage and suffering civilians. UNPAC became a "third force" as 1,200 armed UN peacekeepers arrived from Japan, Canada, Norway and Russia to fulfill four missions: (1) Ensure food and medical supplies and Red Cross doctors reach civilian workers and POWs trapped by the conflict. (2) Enforce the regular negotiated ceasefires by physically interposing themselves between the combatants so anyone planning a surprise attack must run over the UN first. (3) Protect areas UN resolutions designate as "wildlife safe havens" (dubbed "Penguin Patrol" by disgusted soldiers). (4) Clean up robot mines, rogue battle boomers, or oil spills during ceasefires. It's lots of fun.

• **Genom and the Polar War:** Genom is profiting by selling battle boomers to both sides. Also, through its puppets in the Japanese foreign and defense ministry (like the late Defense Minister Callahan), Genom can secretly influence UN policy, since Japan bankrolls the peacekeeping operations. By getting Japan to back some UN ceasefires and block others, GENOM controls the tempo of the war, ensuring no one side has a decisive advantage. Of course, Genom also sells boomers to equip the UN forces



BG CRASH! GAME HOOKS

These are a collection of mini-scenarios set in the 2034 period. They're intended for a vigilantes campaign such as *Bubblegum Crossfire*, but can be adapted for other settings.

▼ REDEMPTION

While visiting their favorite brilliant-but-eccentric Street Tech (we'll call him "Pops"), the players meet his new assistant, Rachel, a pretty but shy young woman who calls him "Uncle." While they get their cycle gas tanks topped off or whatever, trouble comes calling. It's a half-dozen local thugs, who proceed to threaten mayhem because Pops refuses to pay "protection" like the other freelance garages. When one of them lays a hand on "Uncle", Rachel's eyes light up and she tosses the thug 20 feet into a wall. If the PC's want to join in, they can—otherwise the rest yell, "A boomer!" and make a speedy exit. Cleaning up the mess, Pops waves around a wrench: "Good riddance to bad rubbish!" Rachel is more modest: "I hope I didn't hurt him. But he deserved it."

Pops admits Rachel is indeed a boomer, a high-end endoskeletal android with a Model-11 AI. Some scavenging kids found her late one night—her body was badly damaged, but the brain was intact. Figuring the kids would just sell her to some recycler who'd botch the job (another berserk boomer), he decided to buy her. Her memory was badly scrambled, so he deleted it and started over, naming her Rachel.

Over the next few days, Rachel may meet the players again. She's like a kid, curious about the world, always asking questions. Maybe she'll call them for advice on buying Pops a birthday present or some such. In introspective moments, she stares soulfully at the Genom Tower, wondering whom she was built for. Was she an executive's love toy? A soldier? A bodyguard?

Unfortunately, the local thugs (we'll call 'em Yakuza) can't afford the humiliation of a thrashing—it's bad for business. A few days later, one of the PC's gets a frantic call from Rachel. Pops has been shot and his shop busted up while Rachel was out running an errand. She saw the thugs driving off: She was too busy performing first aid to pursue, but noticed their leader had one yellow slit-pupiled cybernetic eye. Players familiar with organized crime may recognize crimelord Shinji "Tiger Eye" Matsura, currently trying to "take over" the district.

Pops is barely conscious—he'll live if they get him to a hospital. He asks if his notebook computer is okay? Rachel says it's gone—along with their money—but what's important is he's alive. Pops insists the computer *is* important: In it was a datadisk he was working on—one that contained Rachel's lost memories! He hadn't really deleted them, he'd been trying to unscramble them for her and had just about succeeded when the thugs arrived. He hadn't told her, afraid he might not succeed.

With Pops on life support in the hospital, Rachel feels a new emotion: anger. She wants the players to help make her uncle's attackers pay—and regain her identity. If they won't help, she'll go it alone.

If the players have any criminal or police connections, they'll be able to find out that besides running protection rackets, "Tiger Eye" Matsura is fairly thick with Genom, having helped break a few unions that protested the use of boomer labor a few years ago. He got a pair of BU-55C boomer bodyguards as payoff. His HQ is an office and warehouse complex near the docks.

The players can help Rachel, either for revenge or to regain her memories—but there's one more twist. Her disk reveals she was indeed owned by Genom, but was part of a Genom assassin team like Mason's boomer women. She killed innocents (maybe even someone a player lost to Genom) and "died" while covering her boss' retreat in a botched covert operation (much like the boomer women were defeated covering Mason's retreat at the end of *BGC 2: Born to Kill*). Some local cyber-

punks picked the site clean before the AD Police showed, and eventually sold her to Pops.

So when (or if) Rachel recovers her memories, she'll be almost two people, integrating a new ruthless personality. Which side will win, dark or light? And how will she react—madness, split personality, suicide, or perhaps a desire to seek redemption for her sins? Maybe the players have a new member for their team

▼ PEACE IN HEAVEN

A new radical group calling itself "Peace in Heaven" has hijacked a Japanese cruise ship on the high

seas. They've taken the crew and passengers captive, among them a former US president and a Genom vice president. The ten well-armed terrorists demand that the UN renounce use of satellite weapons, or they'll begin executing hostages. They offer to free children aboard if the USSD blows up one of its own satellites as a gesture of good faith. The terrorists appear to be equipped with military-style weaponry and body armor (about equivalent to an AD Police team).

The players are contacted by an executive at USSD. From the broadcast of the terrorist ransom demand, he knows his estranged daughter Shinobu is aboard the ship—not as a hostage, but as one of the terrorists! As a senior USSD official, he knows the UN, Japan, Genom, and the United States are discussing whether to negotiate or use force. While Japan favors negotiation, the US plan to use Navy SEALs to assault the ship, kill the terrorists, and rescue the hostages. So far no one has been killed—before that happens, he wants them to use their advanced technology to get aboard, subdue his daughter without killing her, and get out. If they want to be heroes and eliminate the other terrorists too, fine. He can furnish plans of the cruise ship: Except for a few lookouts, the terrorists are staying below decks.

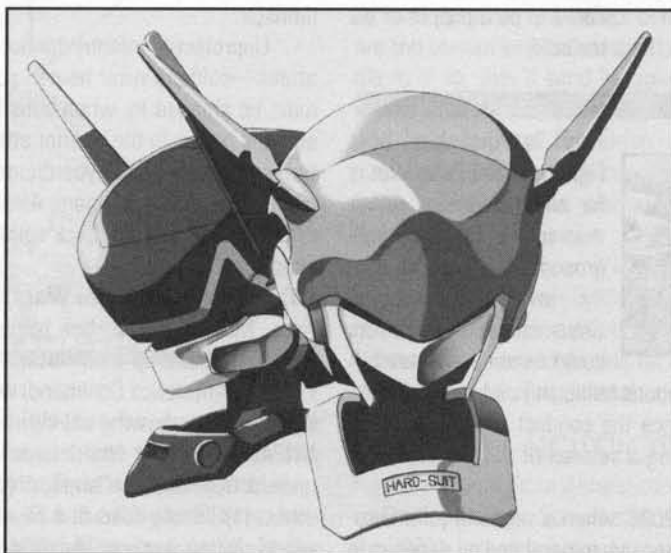



Unexpected complications? Most of the hostages are in the main ballroom, under guard, but the ex-president, her husband, the Genom VP and his secretary are being held in the engine room. When on guard, the terrorists wear body armor and gas masks—there's no way to tell Shinobu from the others!

Worse, Genom doesn't trust the US military—they've decided upon a preemptive strike as well. The Genom VP's executive secretary is actually a Boomer Woman (*BGC*, p.102), and has been in contact with Genom via a scrambled radio in her head. A Genom helicopter has dropped four combat boomers, who are swimming underwater toward the ship, intending to climb aboard and rescue the VP.

Finally, Shinobu is not a dupe, but is actually the leader of the terrorists! She's guarding the VIP's, and is a former USSD officer (which is how she got the military weaponry). She was the duty officer in command of the satellites when Largo's killer dolls took them over. Horrified at the carnage they caused, she attempted to get improved safeguards installed, but her criticisms only led to her being fired. She now feels this is only way to rid the world of the scourge of satellite weaponry.

▼ THE FROZEN CHOSEN

The players notice an advertising blimp, whose flashy video shows famously cute idol singer Ritsuko Yashida promoting the "Truth of Osiris", a new cult that claims to offer good health, salvation, and eternal life in six easy lessons—the first for only ¥10,000. Order the "Truth of Osiris" video-book now!

Soon afterward, the players are hired by Chad Quinn, Ritsuko's wealthy manager. He says Ritsuko lost her voice following a strenuous singing tour, and went to a health-spa run by the "Truth". She found it to be lots of fun, with hot spring baths and everyone being really friendly and warm, so she decided to take the advanced meditation course at the main compound.

Two weeks ago, Chad got a phone call: Ritsuko was crying incoherently and wanted him to pick her up. When he drove to the compound, they wouldn't let him in—she was "meditating." The next day, as he was trying to get the local cops to listen, Ritsuko called, smiling over the vidphone link: The tears had been her "old self" purging itself, and now she recognized the Truth of Osiris, and has been initiated as an Eternal—a senior initiate. She was cancelling her singing contract, since "money and fame are illusions."

Chad says she seemed vacant and repeated herself a few times in the conversation. He thinks she's been brainwashed. He wants the team to rescue her—at least long enough for him to talk to her face to face. If the players check out the cult, they'll find other allegations of brainwashing. Some lawyers and reporters who've tried to probe the cult have ended up vanishing, reappearing later as members. The cult's guru is Bryan Cobalt (now calling himself "Osiris"). He's a Genom executive who "got religion" after being buried alive for 24 hours in the rubble of a Genom Tower after the satellite attack. Cult literature is a half-baked mix of Christian parables and Egyptian myths about eternal truth and life mixed with "visions" Cobalt experienced as his air ran out. In his

speeches, he seems more rambling than rhapsodical, and seems to lack the burning wild-eyed charisma of a Jim Jones or a Manson—but his organization does have money.

The cult's headquarters is the Osirian Temple, a heavily fortified, barbed-wire compound with a pyramid-shaped highrise "temple", plus attached helicopter pad and guard towers. About 200 white-clad junior initiates train here, doing yoga exercises, chanting mantras, and fasting; binoculars also show armed guards (the cult is licensed as a corporation and has its own security). Besides the main temple, the cult owns health spas, like the one Ritsuko went to, and Babel 2, a city television studio.

The cult doesn't keep Ritsuko's schedule a secret—cursory surveillance reveals she and an entourage travel via helicopter from the Osirian Temple to Babel 2 once a week to film promotional videos. Security in Babel 2 is light compared to the Osirian Temple. The highrise studio's lobby is open to visitors but the elevators and stairs are closed, with Guardian Boomers as security. The two dozen floors are mostly offices run by ordinary employees, but the topmost floors are devoted to a special television and video studio run by true believers; on the roof is a landing pad for helicopters and a mooring tower for their video blimp. So this makes rescuing Ritsuko easy, right? Wrong.

If the characters try to snatch Ritsuko, her entourage are *all* boomers who will fight to protect her. Most are low-grade android models, but one is a BU-55C combat boomer. After they rescue her, Ritsuko herself seems a bitapid and repetitive—in fact, they've rescued a boomer duplicate! It's a good physical copy, but with only a moronic brain. Where is Ritsuko, then? Raiding the temple will reveal the secret. She's received the Guru's promise of "eternal life"—in Egyptian style. She (and over a hundred other cult members) have all been frozen in cryogenic sleep within the bowels of the Osirian Temple.



Only the guru himself and one or two of his inner circle are human. Not magnetic enough to be a true messiah, he's surrounded himself with the ultimate mindless cult: boomers programmed to obey his every word.

Of course, Genom has supplied Cobalt with these Boomers surreptitiously in an experiment to see how a society of cyberdroids might function. They let the psychotic Cobalt take all the risks while they observe the results. Of course, they may not appreciate their experiment getting disrupted by a bunch of vigilantes . . .



▼ ROCKFALL

An executive at SDPC receives a message from an agent on Genaros. Two weeks ago a female mannequin-model boomer was smuggled into the Moonbase—according to the informer, this mannequin was an agent of Largo! Apparently, it had been upgraded with a Model-11 imprinted AI instead of the usual Model-9. Choosing a female mannequin model for this upgrade was quite sinister and clever—ever since 2027 (when a rogue Bu-R-31 went crazy), maintenance models assigned to sensitive areas have been regularly examined, but “harmless” boomers like mannequins are rarely given close security checks.

While plans to smuggle this boomer up to the Moonbase had been set in motion by Largo before his defeat, a solar flare delayed shuttle service until recently. It looks like this boomer was supposed to have reached the Moonbase at about the same time as the “boomer revolution”. She may have been part of Largo’s doomsday plot, so it’s not something that can be ignored.

The players are hired by the SDPC executive. Their job is to go to the Moonbase disguised as human or android workers, locate the boomer, and eliminate it before it can get into any mischief. They are being hired because there must have been a security leak for someone to have smuggled the boomer up, so regular Moonbase or SDPC security can’t be trusted. The players know what the particular boomer model looks like (a standard “waitress”-type model), but unfortunately, several were shipped to Moonbase at that time, and the source says it could be any one of the group. The only clues would be its more intelligent behavior, or opening up its braincase to examine the AI.

The players’ agent has “fixed” things with SDPC security so that they can

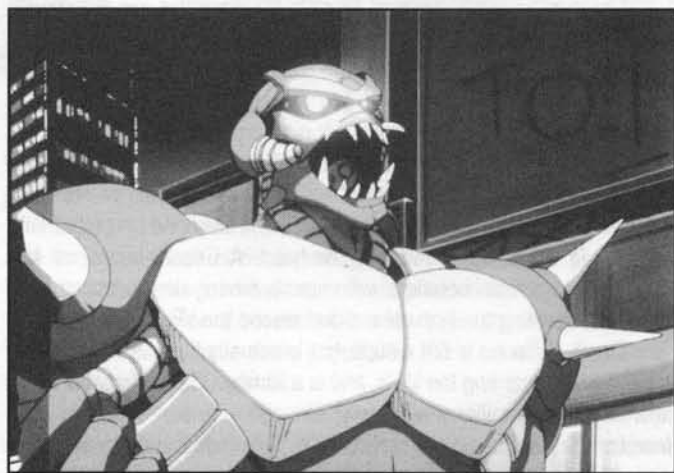

take a flight to Genaros; they’ll be mixed with some short-term contract workers from Earth, and be able to smuggle their hardsuits up in their personal luggage, then onto Moonbase by disguising them as spare spacesuits. Moonbase quarters are barracks-style, so they’ll have to find a hiding a place for the suits in the base.

Moonbase (*BGC* p. 165) is a maze of underground tunnels with several hundred workers and twice as many boomers. It’s always expanding, with boomers digging new tunnels or mine shafts—many areas are not yet occupied. Outside, human workers generally supervise boomers maintaining the solar cells, the automated tracks that carry ore from the shafts to the mines, and the huge massdrivers that accelerate loads of lunar ore to the La Grange points, where they are used to construct more space stations.

To maintain their covers, the PC’s have work assignments: Their hardsuit training lets them use spacesuit-style power-loaders to do construction work on the lunar surface, helping build or maintain solar collectors and massdrivers. There are gambling, drugs, bar fights, illegal sexaroids, and other vices (some of which the PC’s could accidentally get involved in). Keeping the peace are Moonbase security: a security chief and a half-dozen SDPC rent-a-cops armed with heavy gyrojet rocket pistols (as .454 Magnum but WA +0 and only 1/2 damage at 1-2m/yard range, as the rocket is still accelerating). They’re backed by several Doberman boomers that are normally kept locked down except for major emergencies.

The Moonbase is BIG, and there are lots of female mannequins doing various menial jobs, but by hacking into the base computer they can get a list of the model numbers of those that were shipped in at the right time to be their suspects: Only three match! One is a day shift waitress in the main cafeteria, one is a nurse on the night shift in the moonbase pharmacy, and the third works in the hydroponics tunnels. All are perky, fairly moronic models with minimal intelligence—if not properly instructed, they could easily leave a spoon in a hot dog. They’re supposed to work 12-hour shifts, then cool off for another 12 hours in out-of-the-way closets near their workstations. As conversing with the boomers is a bit of a dead end (“yes sir, no sir”) the players may want to talk to the human supervisors of the suspect boomers—or steal them to open up their brains.

- The boomer that has the waitress job is perfectly normal and well adjusted. If the players are able to examine it, the brain is a standard Model-9.

- There are a couple of boomers assigned to several hydroponics farms, but there’s no sign of this one. If asked, the farm’s supervisor,

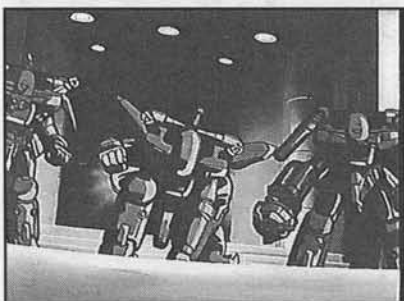
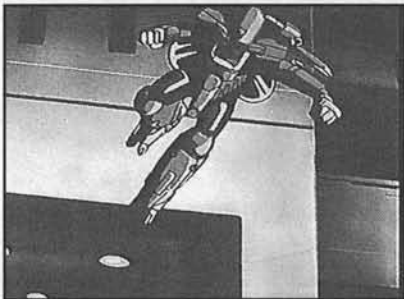
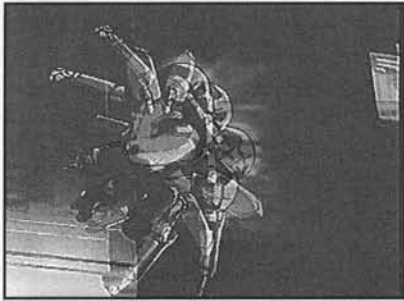
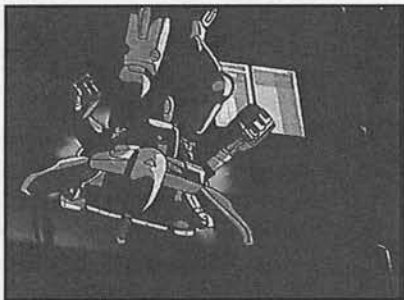
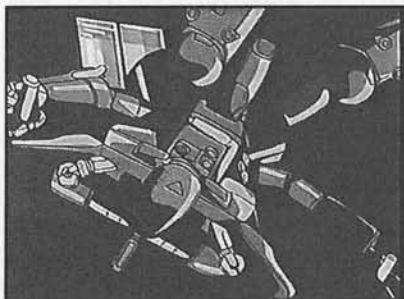



Giles, denies having it and claims it must be a computer error. In fact, the mannequin's been diverted by Giles to cultivate his private marijuana plantation in a disused mine shaft! Giles' plants grow to huge size in the low lunar gravity, and the boomer moves from one to another with a watering can. However, duty in a hot, humid environment has overheated its circuits and she's on the edge of a berserk breakdown; any stress could set her off. Nevertheless, this isn't their suspect—the brain is a normal Model-9. Players can find the boomer's lair by shadowing Giles—he goes to check on his plants at night. Or Giles may follow the players, thinking they are SDPC investigators after *him*, and try to do away with them.

- The nurse boomer works night shift at the sick bay. The doctor there is very jumpy. She's taken to making late-night inspections of her lab, and carrying a rocket pistol. A week ago, her nurse boomer was alone minding the pharmacy and it was attacked! Someone crept up on it, stunned it with an electrical device, and stole several drugs (morphine-like synthetic endorphins) from the dispensary. Security never found the assailant. The boomer had to be sent off to the repair shop, but it's back on duty now. If the players are able to examine its brain, it's a normal Model-9!

So where's the terrorist boomer?

The clue is the doctor's "boomer mugging." The nurse boomer was Largo's agent. She used her position to access medical records of station personnel to find a pawn. Her choice was Ken, a boomer repair technician who was in charge of the graveyard shift at Boomer Maintenance. He'd been in sickbay before, recovering from a drug problem. During Ken's work shift, Largo's agent stole the drugs, then short-circuited herself. At the repair shop she offered Ken a fix if he'd do her a favor. After quizzing Ken on which boomers were undergoing major repairs, she picked a repair and maintenance model assigned to the Moonbase Main Operations Center, and had Ken transplant her brain into it. Ken replaced the nurse boomer's brain with a standard issue Model-9 AI from stocks; with this done, the "Trojan boomer" told Ken where to find the cache of stolen drugs.

The players may find something fishy in the nurse boomer's "mugging" and check out the technician who fixed her. If so, they'll find him high on the drugs; he's been abusing them all week. With appropriate threats (e.g., to rat on him to management) he'll spill the beans. If the players *don't* figure it out, the Referee can have Ken stagger into a mess room in the players' presence and collapse: Needle marks on him show he's OD'ed. Once they take him to the sickbay, analysis of Ken's blood shows the drugs he took were the stolen endorphins—and when Ken is revived, he's scared enough to tell his story.

Meanwhile, the Trojan boomer has been performing acts of sabotage in the Operations Center under the cover of routine maintenance. At the right moment (either when the players have figured out what's going on, or if they're totally stuck!) the boomer finishes its work. An

electrical surge from the sabotaged panels electrocutes the operations crew (human and boomer) at three of the four main consoles—the boomer twists the last tech's head off.

Now in command of the control center, it jacks itself into the computer and reprograms Lunar Massdri-

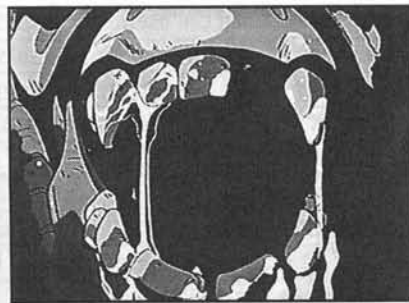

ver #1 to fire its next salvo of ore not into lunar orbit ... but towards Earth! It then seals the doors to the main control room, jams all communication channels connecting Moonbase with the rest of the universe, and orders the Doberman kennels unlocked! In Moonbase's Auxiliary Control room, shocked data operators note the illegal orders to the Dobermans and send an emergency override to lock them down, but not before three are released with orders that can't be countermanded: Two will guard the Main Operations Center against all intruders while the other heads for Auxiliary Control itself, intending to destroy it.

As the Doberman lurches toward Auxiliary control, human security officers are gunned down and alert klaxons and screams echo through the Moonbase! Over the P.A. system are warnings of an out-of-control Doberman and an unauthorized massdriver launch. Data operators in Auxiliary Control calculate the meteor will strike Earth in a matter of hours. Worse yet, USSD's radar and satellites are set up to intercept missiles fired from Earth, not rocks fired from the moon! They may not notice the rocks were launched on the wrong trajectory in time to stop them—and whoever has seized Central is blocking all outgoing communications. Worse yet, the mass driver has been programmed to launch a new salvo every five minutes!

What can the players do? Well, if they'd figured out what was going on at this point, they're probably in their hardsuits and on the way to stop the trojan boomer. If they feel up to fighting the two Dobermans, they can retake the main control room and end the threat—if Ken is alive, he might know some maintenance tunnels to crawl through to outflank the Dobermans on guard. Or if they can stop the third Doberman from destroying Auxiliary Control, they can use its computers and their own hacking expertise to shut down the massdriver and/or open communications with USSD. (The rogue Dobermans are no longer accepting outside commands.) Or they can try go onto the Lunar surface and trash the feed mechanism to the massdriver (it has to get those megaton slugs from somewhere). No matter what they do, the boomer will probably send another Doberman after them. Priorities, priorities

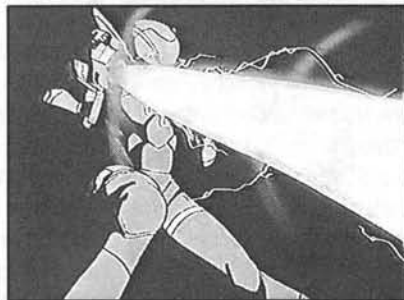



**LANDO IN SURGERY,
BEING CONVERTED INTO
A BOOMEROID**

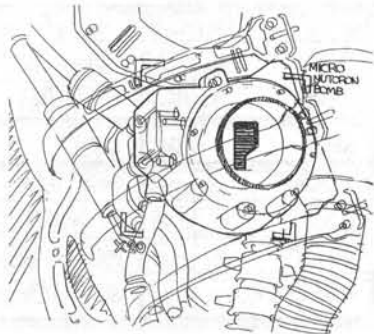
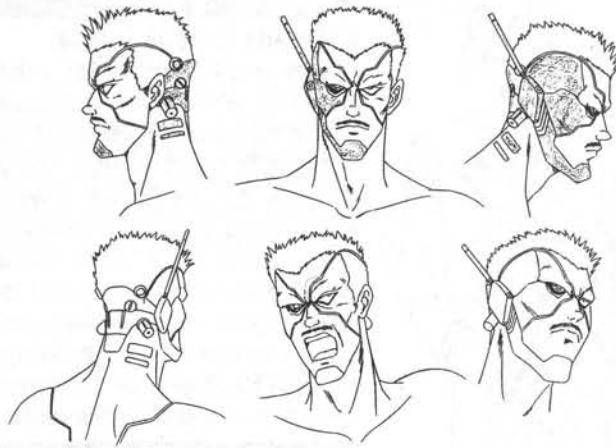

**LANDO'S IMPLANTED MICRO-
NEUTRON BOMB**

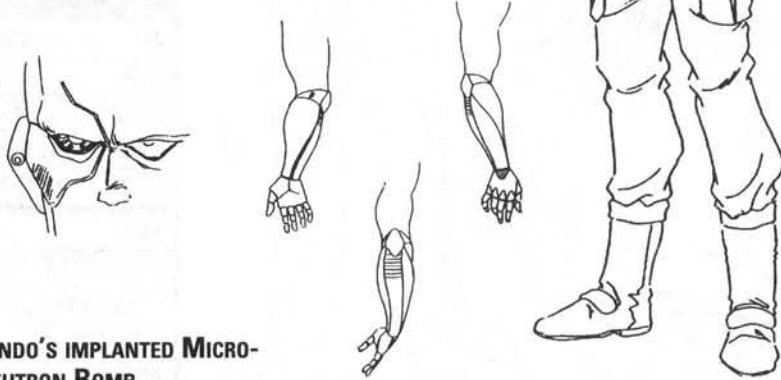

COL. LANDO

AGE		Unknown		JOB		Mercenary			
INT	4	PRE	5	WILL	7/2	TECH	4	MOVE	10
REF	7	DEX	7	STR	10	CON	-	BODY	10
LUCK	11	MAX	2.5t	LIFT	1.25t	CAR	625kg	THRW	100m
PNCH	10D6	KICK	11D6	RUN	30m	LEAP	5m	SWIM	10m
STUN	-	SD	-	SDP	50	RCVR	-	RES	21/6

SKILL	LVL	SKILL	LVL	SKILL, ETC.	LVL
PERCEPTION*	+4	TEACHING*	+5	AUTOFIRE	+7
CONCENTRATION*	+4	ATHLETICS*	+7	HEAVY WEAPONS	+6
EDUCATION*	+3	LEADERSHIP	+7	MECHAPILOT	+5
PERSUASION*	+5	HAND-TO-HAND	+5	GUNNERY	+6
SOCIAL*	+3	MELEE	+7	STEALTH	+6
LOCAL KNOWLEDGE*	+3	FIREARMS	+7	COMBAT SENSE	+4

CYBERNETICS: "Half-Boomer" Full-Cyborg Body with Advanced Fusion capability (Lando can absorb, control and animate 1090kg of material) and Implanted Self-destruct mechanism (Micro-Neutron Bomb, capable of destroying everything in a three km radius—trigger mechanism is a very small target, requires micro-optics to target, Target Number is 30). • Night Vision & Thermograph (skull splits along seams for Image Enhancement & Targeting) • Enhanced Audio "Lens" & Commlink antenna • Interface plugs (back of skull & neck) • Weapon Joint.

NOTES: All cybernetics are Boomerware, mostly covered by Real-Skin material; Lando's Humanity is -1.5 (penalty to social rolls is -9).

▼ COLONEL N. J. LANDO

Height: 173cm, Weight: 109kg. Deceased as of 2034.

Lando was the commander of the "Illegal Army", a European mercenary unit that fought in such hotspots as South America, the Middle East and Southeast Asia. A few years ago, a major Japanese concern (probably Genom) hired Lando's outfit for an operation in the Philippines, but it went horribly wrong. Then, as they were preparing to evacuate their wounded, the survivors were ambushed by an assault aerodyne. Most were killed in the ensuing rocket attack.

Colonel Lando was believed dead, but actually his badly injured body was recovered by Largo's agents. Lando was rebuilt as a heavily armed cyborg and given intense brainwashing to accept his boomeroid body and make him loyal to Largo's cause—the creation of a new world order controlled by boomers. He assumed command of a reborn Illegal Army made up of boomers using the Army's old identities and powered suits. He led them on a series of successful robberies (which seemed to be gold thefts, but were just cover for acquiring the new AI), only to be trapped by the Knight Sabers. Refusing to surrender, Lando was killed by the Knight Sabers while activating his self-destruct device.

NOTES: Lando had a very military bearing, even saluting when told not to. He cared about his men and sometimes had flashbacks to their deaths—in particular, the face of one dying young soldier (who looked a bit like Leon) still haunted him. He was loyal to Largo, partly due to the brainwashing, but also because Largo was once his commander (probably as Brian J. Mason, running Genom's covert operations). Lando was proud of the Illegal Army's tradition and had vowed never to surrender.



▼DR. YURI

AGE: Early 40s; died in 2034.

A clever engineer who worked with Dr. Stingray at Wiz Laboratories, he went on to betray his mentor's dream by developing boomers for the military. A man driven to succeed at any cost, Yuri was assumed to be the heir to Dr. Stingray's genius, but his skill lay in the design of boomer bodies rather than minds, and he was ultimately eclipsed by Dr. Haynes, whose Adama represented the breakthrough Yuri had failed to reach. Torn by jealousy, Yuri allied himself with Largo, killed Haynes and his staff, and stole Adama, hoping to use its AI to make his Iron Lizard boomer work. When his plans were thwarted by the Knight Sabers, he chose to go down fighting. He was shot dead by Sylia to avenge Dr. Haynes' death.

NOTES: Though Dr. Yuri preferred to work without human assistants, he was fond of boomer assassins. His building is on p.50.

DR. YURI

INT	8	PRE	5	WILL	5	TECH	8	MOVE	3
REF	4	DEX	3	STR	2	CON	4	BODY	3
LUCK	11	MAX	72kg	LIFT	36kg	CAR	18kg	THRW	20m
PNCH	2D6	KICK	3D6	RUN	9m	LEAP	1.5m	SWIM	3m
STUN	15	SD	-6	HITS	15	RCVR	6	RES	15
SKILL	LVL	SKILL	LVL	SKILL	LVL	SKILL	LVL	SKILL	LVL
PERCEPTION*	+5	SOCIAL*	+4	BASIC TECH	+9				
CONCENTRATION*	+7	LOCAL*	+5	HIGH TECH	+10				
EDUCATION*	+9	TEACH*	+4	MILSPEC TECH	+10				
PERSUASION*	+5	ATHLETICS*	+3	SUPERTECH	+7				

▼DR. HAYNES

AGE: Early 40s, died in 2034.

The brilliant Dr. Haynes was a specialist in artificial intelligence and a member of Dr. Stingray's original design team at Wiz Laboratories. After Dr. Stingray died, he comforted the young Sylia and swore to continue her father's work. He went to work for Zone Corporation, and in 2034 he succeeded in his quest, developing Adama, a boomer with a new type of AI (see p.75) whom he hoped would become a good friend of mankind. However, Haynes was a gentle man, who never understood the darker emotions to which many people are prone. When he shared his triumph with Dr. Yuri he was shocked to learn of his former coworker's jealousy. He died moments later, gunned down (along with his staff) by Dr. Yuri's Terrorist Boomers.

NOTES: Haynes was married, and left behind one daughter. A grieving Sylia attended his funeral and later avenged his death.

DR. HAYNES

INT	9	PRE	4	WILL	4	TECH	8	MOVE	2
REF	3	DEX	3	STR	2	CON	2	BODY	3
LUCK	10	MAX	72kg	LIFT	36kg	CAR	18kg	THRW	20m
PNCH	2D6	KICK	3D6	RUN	6m	LEAP	1m	SWIM	2m
STUN	15	SD	-4	HITS	15	RCVR	4	RES	12
SKILL	LVL	SKILL	LVL	SKILL	LVL	SKILL	LVL	SKILL	LVL
PERCEPTION*	+4	SOCIAL*	+5	BASIC TECH	+8				
CONCENTRATION*	+7	LOCAL*	+4	HIGH TECH	+9				
EDUCATION*	+10	TEACH*	+6	COMPUTERS	+10				
PERSUASION*	+5	ATHLETICS*	+2	SUPERTECH	+10				





▼PRISS' MANAGER

AGE: Late 30's

This smarmy talent agent knows the music industry inside and out, and can boast strong connections with Studio Omega and such big names as Fuyumoto. His sexual orientation has come into question many a time, but whether he prefers girls, guys, or both, almost everybody finds him rather intense. He represented Priss during her bid for a professional debut, but how the two met is a mystery. While he did manage to get Priss a recording contract, it was only by presenting her as an idol singer—an image she refused to accept.

NOTES

This fellow oozes flattery and has a touchy-feely manner, especially with female clients; he calls aspiring songstresses "babe" and is always trying to hit on them, which often ends in him receiving a painful personal lesson. Having been dumped by Priss, he's now looking for a new client.



PRISS' MANAGER

INT	3	PRE	4	WILL	3	TECH	3	MOVE	2
REF	2	DEX	2	STR	2	CON	2	BODY	2
LUCK	5	MAX	72kg	LIFT	36kg	CAR	18kg	THRW	20m
PNCH	2D6	KICK	3D6	RUN	6m	LEAP	1m	SWIM	2m
STUN	10	SD	-4	HITS	10	RCVR	4	RES	9
SKILL	LVL	SKILL	LVL	SKILL	LVL				
PERCEPTION*	+3	SOCIAL*	+6	BUSINESS	+6				
CONCENTRATION*	+3	LOCAL*	+5	WARDROBE & STYLE	+4				
EDUCATION*	+3	TEACH*	+3	CONTACTS	5				
PERSUASION*	+7	ATHLETICS*	+2	(MUSIC INDUSTRY)					

▼NEW AD POLICE CHIEF

AGE: 50's.

Chief Todo's replacement in 2034 is a washed-up corporate bureaucrat fobbed off on the AD Police to earn his retirement pay. Having never actually been a frontline police officer, this timid political appointee avoids controversial decisions at all costs, believing his mandate is to ensure that the ADP makes as few waves as possible—this means sucking up to his superiors and avoiding public complaints by not deploying heavy weaponry. He is rumored to have ties to a major video game company, and to have given them a contract to redesign the ADP's firing range (under the auspices of "saving costs for live ammunition"). He is married, has one daughter, and bears more than a passing resemblance to a late 20th century United States President.

NEW AD POLICE CHIEF

INT	3	PRE	2	WILL	1	TECH	2	MOVE	2
REF	2	DEX	2	STR	2	CON	2	BODY	2
LUCK	5	MAX	72kg	LIFT	36kg	CAR	18kg	THRW	20m
PNCH	2D6	KICK	3D6	RUN	6m	LEAP	1m	SWIM	2m
STUN	10	SD	-4	HITS	10	RCVR	4	RES	9
SKILL	LVL	SKILL	LVL	SKILL	LVL				
PERCEPTION*	+2	SOCIAL*	+5	BUSINESS	+4				
CONCENTRATION*	+3	LOCAL*	+4	LAW	+4				
EDUCATION*	+5	TEACH*	+4	ADP PROCEDURE	+3				
PERSUASION*	+3	ATHLETICS*	+2	EX. BUREAUCRACY	+6				



KNIGHT SABER TECH

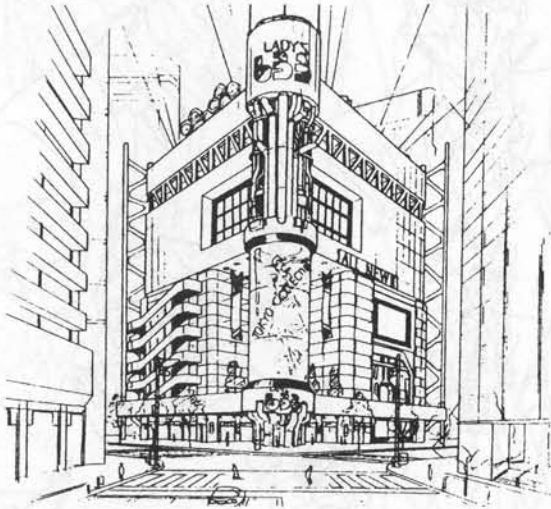

In 2034 Sylia decided to call a temporary halt to the Knight Sabers' activities. She had been having terrible dreams and was being haunted by a "secret admirer"—premonitions of a coming threat to herself, the Knight Sabers, and MegaTokyo. With Mackie going off to study in Germany, Sylia had a good opportunity to make significant changes in her life and the way the Knight Sabers operated—changes that would be needed to face this new challenge.

Sylia had her building secretly remodeled from a lingerie shop to a high tech boutique. Several stores were replaced, out of a desire for greater privacy or more space. The building retains all the features it had in 2033 (see *BGC* p.64), but in addition, it now includes:

Hyper-Recall Machine: Another of Dr. Stingray's creations (recently brought out of storage), this device allows one to perceive and experience incidents in one's subconscious. Sylia finds it invaluable—she simply reclines on the machine's seat, locks the hatch, then presses the switch. As the Recall Machine begins to buzz, she can trace her memories

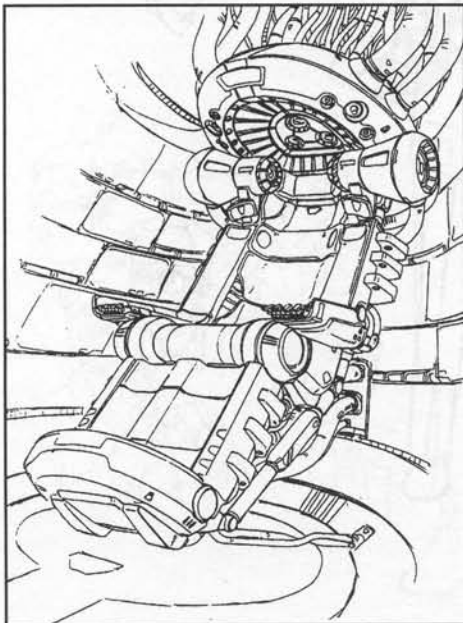

through a psychologically-generated virtual-reality dream-state (this adds a +5 bonus to Concentration rolls involving memory).

Knight Wing: This is the Knight Sabers' newest aircraft, which replaces their older truck as a mobile command center and transport. Sylia's decision to deploy the Knight Wing also foreshadows a wider role for the Knight Sabers *beyond* MegaTokyo itself. See page 73.

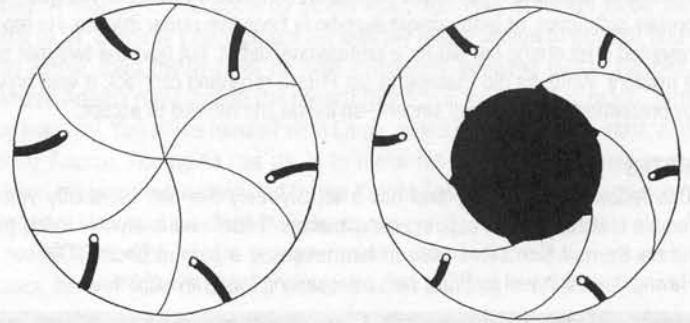

VTOL Launch

Tower: The tower on Ladys633 has been redesigned, connecting directly with the hardsuit lockers and underground hanger. Atop the tower roof is an iris-type door for the Knight Wing to exit or enter via vertical takeoff & landing. The tower is surrounded with spotlights that illuminate the launch tower and Knight Wing as it takes off.

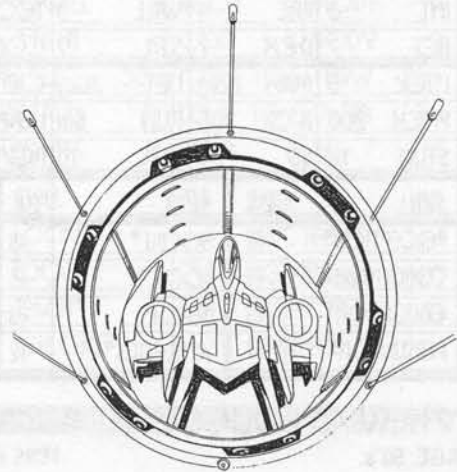

Hardsuit Locker: This new storage facility is located underground and connects to the Knight Wing's hangar. When not in use, the suits are stored at freezing temperatures in a special computer-locked container—as Mackie is no longer there to act as a mechanic, this feature reduces the suits' routine maintenance requirements by retarding oxidization. To open a locker and defrost and warm up the suit, a latch in the center of the locker is turned, deploying the hardsuit, ready for entry.

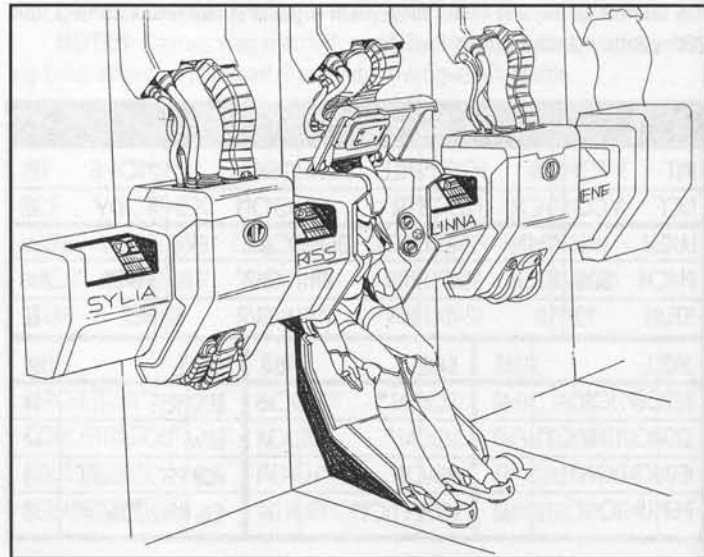



▼VERSION-3 HARDSUITS

"Get a load of these souped-up parts!"

—Priss, AD2034

Following her regular upgrade plan, Sylia redesigned the Knight Sabers' hardsuits in 2034 to keep them several steps ahead of the latest developments in technology. All the hardsuits were significantly improved in terms of maneuverability, speed, and armor protection. However, unlike the second-generation upgrades, the Version-3 hardsuits represent a radical rethinking of the various members' roles in combat.

While Sylia's own hardsuit has remained effectively the same (other than a greater flight speed), the others' hardsuits were drastically altered: Priss' hardsuit had all weapons removed (except for defensive rapiers) so that it could mount mission-specific power-up parts; Linna's close-combat speciality was enhanced by replacing her lasers with ranged weapons which can entangle and incapacitate opponents;

Nene's hardsuit was finally given significant firepower in the form of wide-angle electron weaponry, which is well suited to her electronic warfare skills—and helps make up for her awful marksmanship!

In addition to these specific changes, all the hardsuits no longer sport powered manipulators on the right hand, instead using energized mesh gloves (which grant superior manual dexterity). The deletion of the manipulators also included the removal of the standard forearm laser guns; Sylia observed that most boomers were dispatched by a hardsuit's "special weapon", so the lasers tended to be of little value. The new helmets were all given "eye slit"-style visors, which, while purely cosmetic, did give them a more intimidating appearance. To accommodate this new design, the helmet visors were redesigned; Linna's visor is hinged on the axes in the ear section, while for the other hardsuits the visor must first be lifted up and then opened.

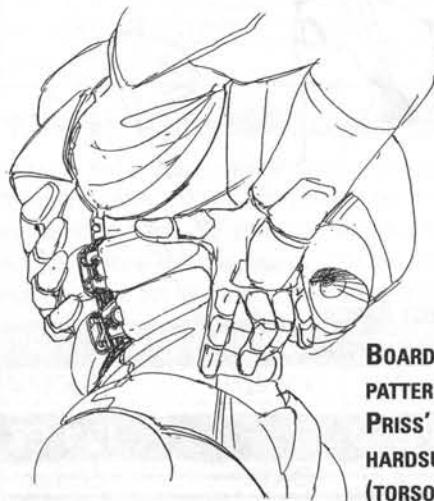

BOARDING PATTERN:
PRISS'
HARDSUIT
(TORSO)

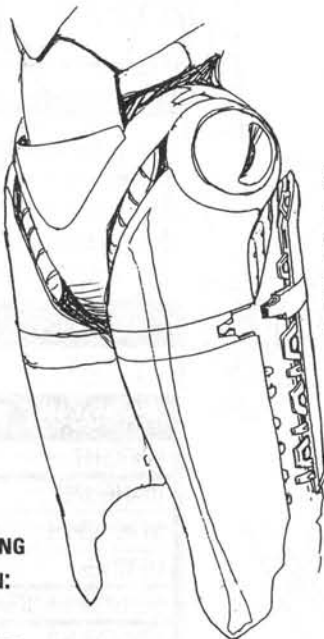

BOARDING PATTERN:
PRISS'
HARDSUIT
(SHOULDERS)

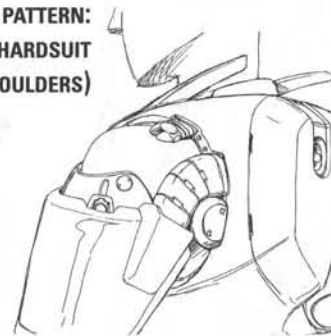

BOARDING PATTERN:
PRISS'
HARDSUIT
(LEGS)



BOARDING PATTERN:
SYLIA'
HARDSUIT
(TORSO)

DETAIL OF HARDSUIT'S
UPPER BODY LINEAR
MOTOR TRUSS

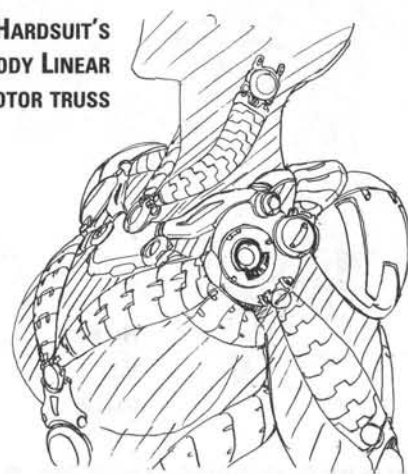

DETAILS OF HARDSUIT PRISS' TORSO & HIP LINEAR MOTOR TRUSS

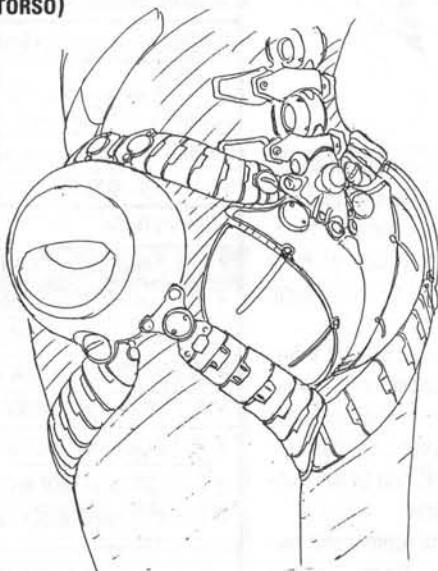

DETAIL
OF
LINNA'S
H.U.D.

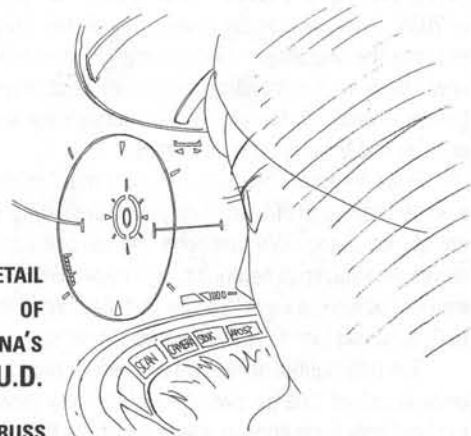

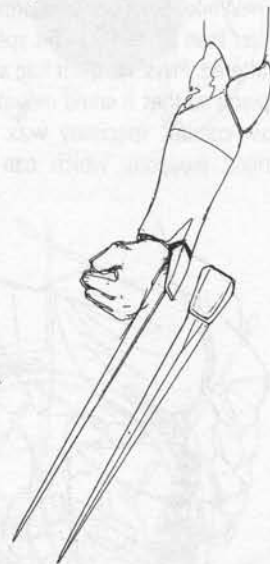
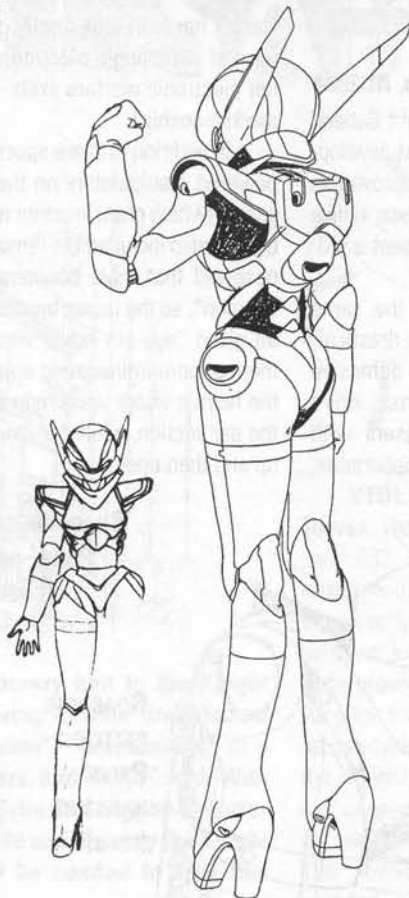
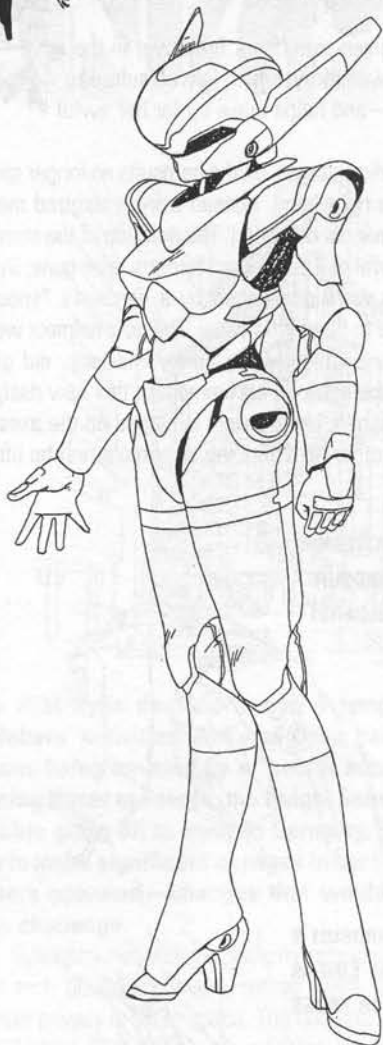

WRIST RAPIER
DETAIL



HELMET
VISOR
DETAIL



▼ HARDSUIT PRISS VERSION-3

In 2034, Sylia once again redesigned all the Knight Sabers' Hardsuits, realizing the next stage of evolution in powered-armor technology. Priss' new Hardsuit has mobility, endurance, and armor protection of even greater levels than her previous model, but the Version-3's basic design concept has been drastically changed.

Priss' Version-3 Hardsuit is now a true "soldier" unit. Though it has a limited selection of built-in defensive weaponry, it has access to a variety of interchangeable weapons and assault equipment. The backpack serves as a universal hardpoint, and depending on the particular mission, various "power-up parts" can be installed. With the addition of this feature, Sylia has significantly increased Priss' role in combat.

The only built-in armament consists of twin forearm rapiers and two wrist-launched energy swords—while very powerful, these "combat torches" only have enough power for about three seconds of use each.

HARDSUIT PRISS VER-3 124 CP

WEIGHT	57.58 kg	POWER	50 hours		
MANEUVER	+1 DEX & REF	DESIGN & STYLE	+3 PRE		
STRENGTH	STR 10	RUNNING	+5 Move		
LIFTING	Wearer's x10	JUMPING	200m		
SENSOR RANGE	1 km	COMM RANGE	10 km		
ARMOR KD	65 Hits	STRUCTURE	60 Hits		
WEAPON	WA	RNG	DMG	LOC	SPECIAL NOTES
RAPIER	+1	-	21D6	RA	Retractable.
RAPIER	+1	-	21D6	LA	Retractable.
COMBAT TORCH	+1	-	28D6*	1h	*-0.4K PD; one Phase of use.
COMBAT TORCH	+1	-	28D6*	1h	*-0.4K PD; one Phase of use.
HAND-TO-HAND	+0	-	10D6	A, A	Stun damage only.

SUBSYSTEMS

Hardsuit Armor is Fusion-Proof

- Life Support (full sealing vs Nuclear, Biological & Chemical agents).
- Information Processing Helmet (optical, audio, radio, targeting, low-light vision, instrumentation, Heads-Up Display; +2 Perception).
- ECCM System (Rank = 8) and radio scrambler.
- Maneuvering Vernier-Rockets and Jumpjets.
- Flat-actuated linear motor system (innerwear necessary).
- Emergency armor-ejection function (blows armor off wearer).
- Quick-change mounts on backpack assembly, with helmet datalink.



▼SPIKE-SHOOTERS

This is Priss' "default" set of power up parts. Mounting on the backpack in the form of winglike pods, twin Spike-Shooters can transform into a firing position. These electrothermal weapons use plasma as a propellant to fire 40cm tungsten spikes at 1200m/sec². Each launcher holds ten spikes and can be fired individually or paired with the other Spike-Shooter.

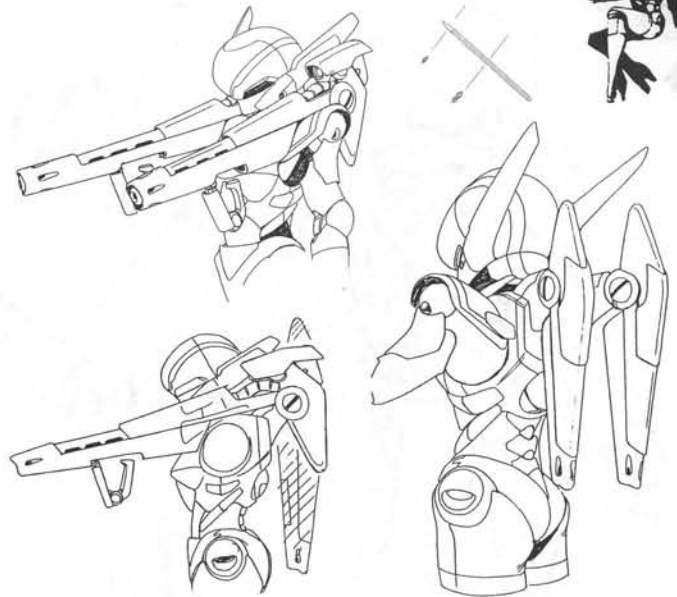

PRISS' SPIKE-SHOOTERS +24 CP

WEIGHT +10.20 kg | SUIT WEIGHT 67.78 kg

STAT MODIFIERS: None.

WEAPON	WA	RNG	DMG	LOC	SPECIAL NOTES
SPIKE-SHOOTER	+1	550m	20D6*	T/1h	*AP, 10 shots, X-Link.
SPIKE-SHOOTER	+1	550m	20D6*	T/1h	*AP, 10 shots, X-Link.

ARMOR AND/OR DEFENSES: None.

SUBSYSTEMS: Electronic-optical targeting scopes, "transformable" carriage/firing deployment, handgrips, backward-blasting plasma-propellant gas vents.

▼HYPER-ARMS

This power-up system was designed to increase a Hardsuit's upper body strength. The Hyper-Arms are worn as an exoskeleton over the Hardsuit, equipping each arm with powerful claws and laser cannons. The claws can also be launched off as grapples, and the built-in laser cannons are very high-powered, but take a long time (10 seconds) to power up for a firing.

PRISS' HYPER-ARMS +122 CP

WEIGHT +129.00 kg | SUIT WEIGHT 186.58 kg

STRENGTH STR 15 | LIFTING Wearer's x15

WEAPON	WA	RNG	DMG	LOC	SPECIAL NOTES
CLAWS (EACH)	+2	*	42D6	RA	*Grapple range 150m, 10D6 damage.
LASER CANNONS	+0	275m	42D6*	A, A	*X-Link, Warm-Up = 3.

ARMOR KD: 65KD, Fusion-Proof; when attacking arms, Hyper-Arms'

KD must be penetrated before Hardsuit's own PD can be affected.

SUBSYSTEMS: Cylindrical gyro-balancers, Emergency armor-ejection function (detaches Hyper-Arms set from Hardsuit).

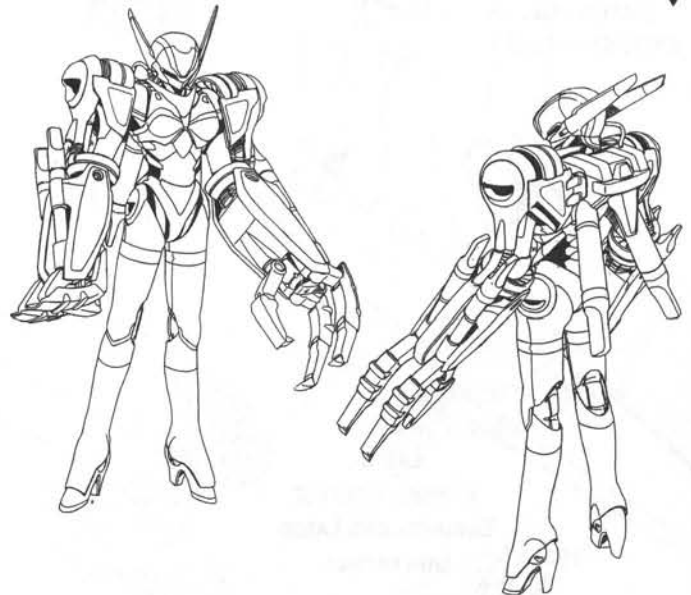

▼HANDCANNON

This power-up system includes a backpack generator and a slender forearm shield equipped with a powered manipulator. When the back of the power-hand slides back it reveals the barrel of an energy projectile cannon. Powered by the backpack, this deadly plasma weapon owes its exceptional accuracy to a boom-mounted sensor located on the left side of the backpack.

PRISS' HANDCANNON +141 CP

WEIGHT +17.00 kg | SUIT WEIGHT 74.58 kg

STAT MODIFIERS: None.

WEAPON	WA	RNG	DMG	LOC	SPECIAL NOTES
PLASMA CANNON	+2	550m	22D6*	A, 1h	*Does dmg twice per hit!
MANIPULATOR	-2	-	10D6*	RA	*Killing damage.
SHIELD	*	65KD		RA	*Defense Ability = -0

ARMOR AND/OR DEFENSES: None.

SUBSYSTEMS: Backpack power generator (with direct power feed to cannon), optical triangulation sensor on articulated mast.

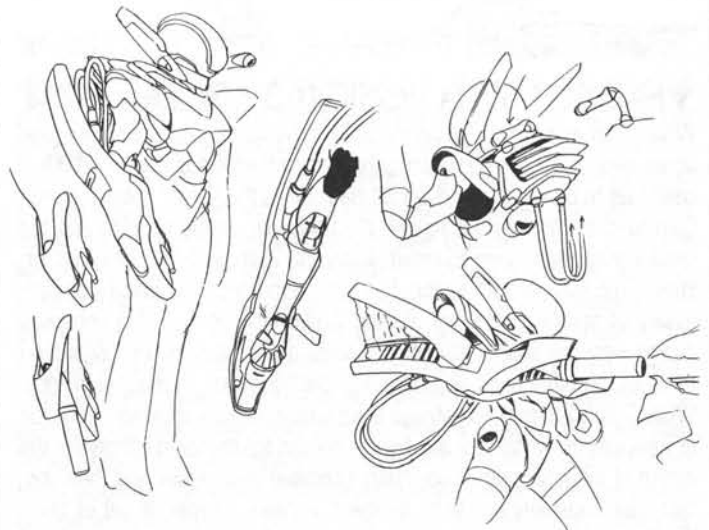

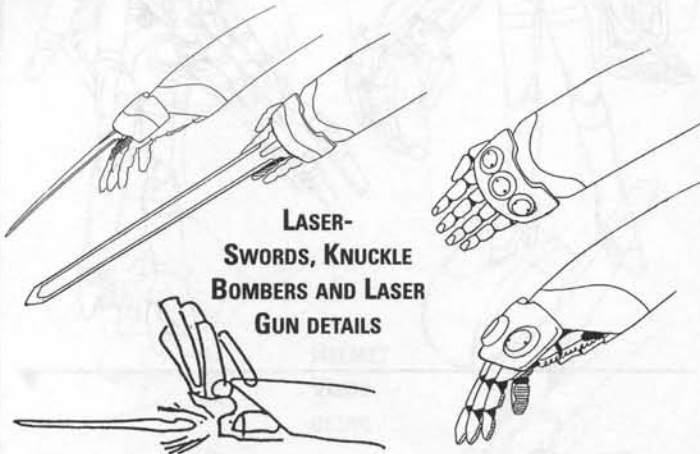
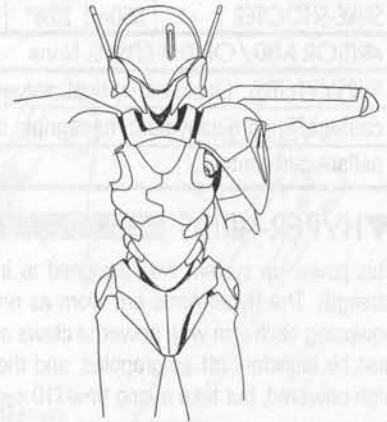
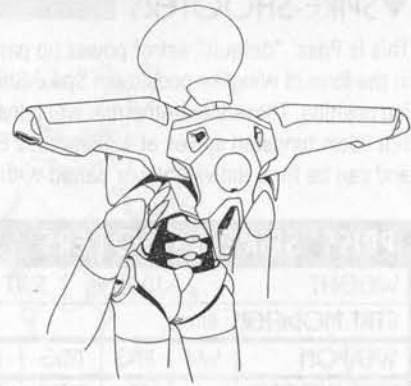
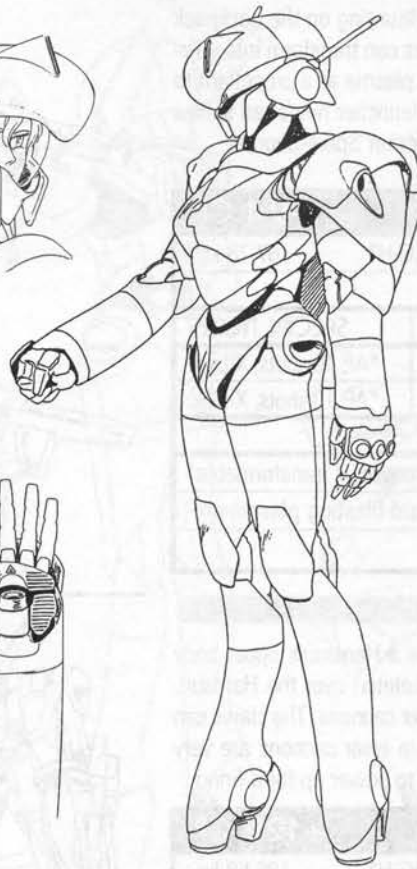
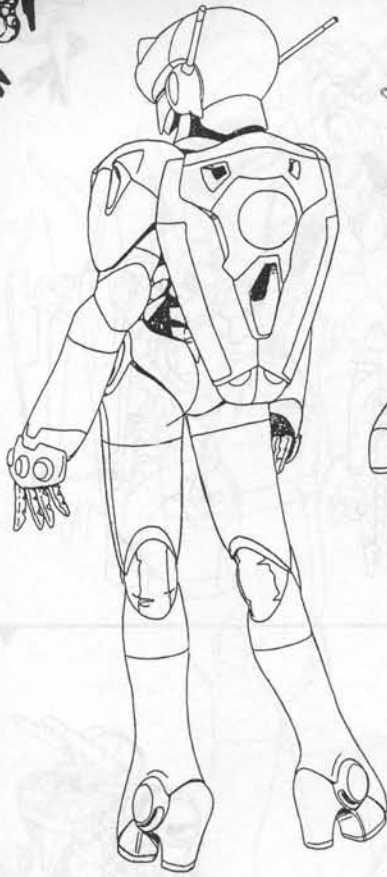

LASER-SWORDS, KNUCKLE BOMBERS AND LASER GUN DETAILS

▼ HARDSUIT SYLIA VERSION-3

When Sylia redesigned the Knight Sabers' Hardsuits once more, her own armor wasn't left out—following the same principles applied in 2033, it continues to be the most advanced Hardsuit in the Knight Sabers' armor. Compared to the previous model, the backpack engine housing and the vernier wings have been enlarged, drastically increasing the Hardsuit's air-speed. The suit's control system has also been improved, which was necessary to maintain effective piloting while airborne (but also enhances overall maneuverability). Its improved linear motor network is stronger than those of the other suits, and its armor plating boasts superior resilience. While Sylia's Hardsuit has always been armed with the optimum selection of weapons, its armament has been modified for improved efficiency; the output of the laser barrels has been increased once again, and their contact-firing capability has been removed. Instead, a separate set of traditional shaped-charge Knuckle Bombers has been installed.

HARDSUIT SYLIA VER-3

308 CP

WEIGHT	67.06 kg	POWER	50 hours
MANEUVER	+1 DEX & REF	DESIGN & STYLE	+3 PRE
STRENGTH	STR 10	RUNNING	+5 Move
LIFTING	Wearer's x10	FLYING	57 (305kph)
SENSOR RANGE	1 km	COMM RANGE	10 km
ARMOR KD	70 KD	STRUCTURE	60 Hits

WEAPON	WA	RNG	DMG	LOC	SPECIAL NOTES
LASER BEAM x2	+0	850m	25D6	A, A	Linked.
LASER BURST x2	-1	650m	14D6	"	ROF 10, Linked.
KNUCKLE BOMBER x2	+0	-	28D6	A, A	3 shots each, X-linked.
LASER SWORDS	+1	-	28D6*	A, A	*-0.4K PD.
HAND-TO-HAND	+0	-	10D6	A, A	Killing only.

SUBSYSTEMS

Hardsuit Armor is Fusion-Proof

- Life Support (full sealing vs Nuclear, Biological & Chemical agents).
- Information Processing Helmet (optical, audio, radio, targeting, low-light vision, instrumentation, Heads-Up Display; +2 Perception).
- ECCM System (Rank = 8) and radio scrambler.
- Maneuvering Vernier-Rockets.
- 2 Flight Wings (if a called shot at -3 is made and armor is penetrated, a wing is destroyed and flight becomes impossible).
- Flat-actuated linear motor system (innerwear necessary).
- Emergency armor-ejection function (blows armor off wearer).
- Quick-change sleeves for battlegloves.

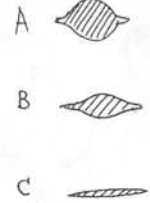
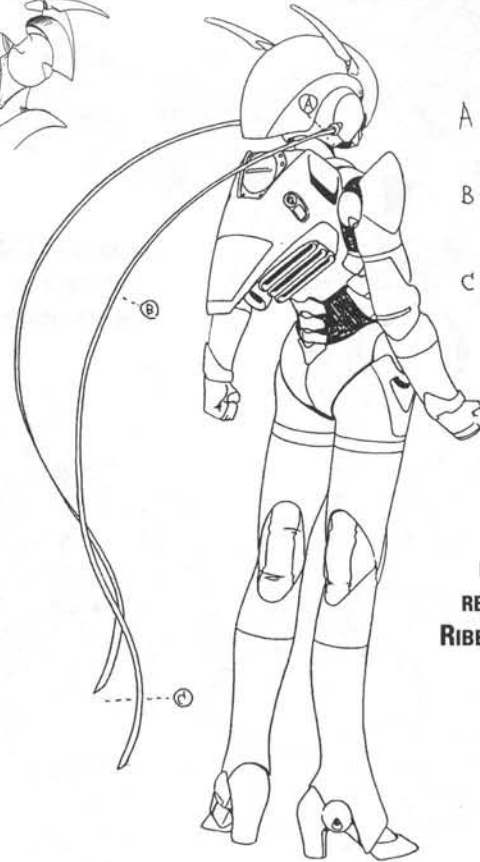
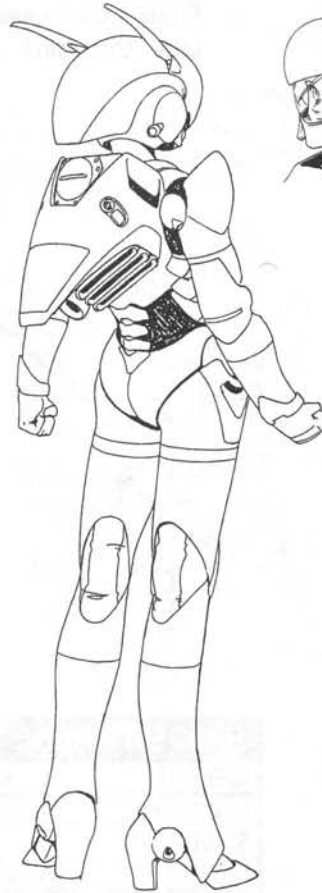

DETAIL OF
RETRACTABLE
RIBBON-CUTTERS

HARDSUIT LINNA VER-3

283 CP

WEIGHT	58.88 kg	POWER	50 hours
MANEUVER	+2 DEX, +2 REF	DESIGN & STYLE	+3 PRE
STRENGTH	STR 10	RUNNING	+6 Move
LIFTING	Wearer's x10	JUMPING	300m
SENSOR RANGE	1 km	COMM RANGE	10 km
ARMOR KD	60 KD	STRUCTURE	60 Hits

WEAPON	WA	RNG	DMG	LOC	SPECIAL NOTES
WIRE-DAGGERS	+1	30m	17D6*e	A, A	*each (Link), AP, Shock.*
RIBBON CUTTERS	-2	-	21D6*e	H	*each (Link), AP, Quick.*
HAND-TO-HAND	+0	-	10D6	A, A	Stun only.

SUBSYSTEMS *Hardsuit Armor is Fusion-Proof*

- Life Support (full sealing vs Nuclear, Biological & Chemical agents).
- Information Processing Helmet (optical, audio, radio, targeting, low-light vision, instrumentation, Heads-Up Display; +2 Perception).
- ECCM System (Rank = 8) and radio scrambler.
- Maneuvering Vernier-Rockets and Jumpjets.
- Flat-actuated linear motor system (innerwear necessary).
- Emergency armor-ejection function (blows armor off wearer).

* Both Wire-Daggers must hit in order to deliver their shock, but since both Wire-Daggers are Linked to each other, this is not generally a concern..

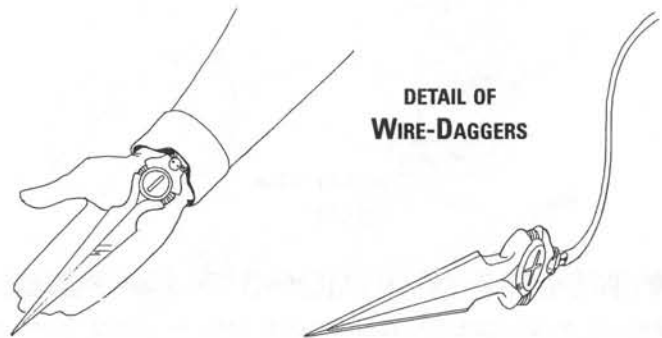

DETAIL OF
WIRE-DAGGERS

▼HARDSUIT LINNA VERSION-3

While Sylia's own Version-3 Hardsuit was simply an improved version of previous models, Linna's suit was radically redesigned to highlight her hit-and-run tactics. To this end, the suit's already exceptional maneuverability was increased even further, and a high-powered "pseudoflight" jumpjet engine system was added (housed in a larger backpack unit). While Linna's signature Ribbon Cutters have been retained (2 meters in length, and retractable into the helmet), her finger-lasers and knuckle-bomber have been abandoned. In their place, a combination ranged energy/melee weapons system called Wire-Daggers was mounted in the suit's wrist sections. The Daggers (whose blades feature the same laser-edge as Sylia's Laser Swords) can be launched at high velocity from the wrists, punching through armor to reach delicate inner circuitry; the right Dagger has a positive electrode while the left one has a negative electrode, allowing the weapon to deliver a high-voltage electrical attack. Compared to the Knuckle Bomber and lasers, this weapon is perfect for Linna's hit-and-run combat style.

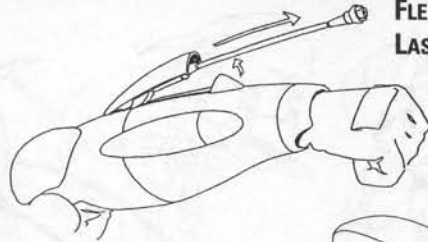
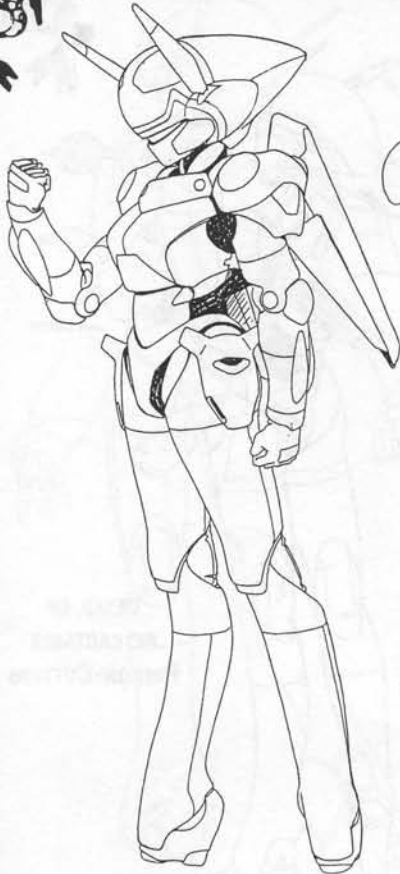

FLEXIBLE CORDS AND LASER GUN PORTS

BACKPACK ECM SYSTEM AND VERNIER-WINGS

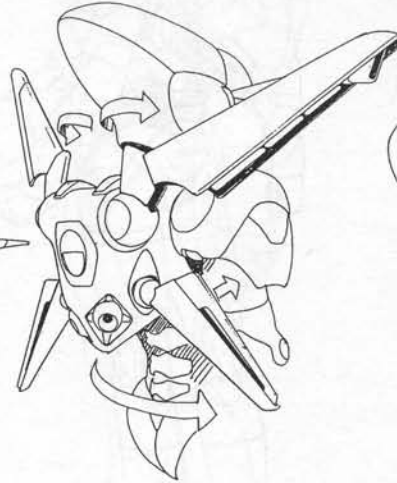

HELMET HYPER-SENSORS AND SHOULDER PULSE-STRIKERS



HELMET VISOR DETAILS

▼ HARDSUIT NENE VERSION-3

Originally, Nene's hardsuit was dedicated to defense—namely jamming and data management. However, her Version-3 suit's offensive capability has been increased through an ability to apply and manipulate electrical fields; it's equipped with a Pulse Striker, which uses high-frequency electrons to burn out the inner circuitry of its targets. The backpack also houses electronic warfare equipment: The wings' jamming antennae emit ECM/ECCM signals powerful enough to override a missile's guidance systems, effectively putting any missiles fired at Nene under her control. These wings, when deployed, also house vernier nozzles for increased flight capability. The helmet's electronic systems include a set of powerful Hypersensors, which cover the entire scanning spectrum—even seismic detectors, which receive input from flexible cords launched from the hardsuit's wrists. These cords can also be used to interface with other hardsuits, computers, machinery, and can even be used to physically hack the systems of an enemy boomer! The wrist-ports from which these prehensile cords are extended also house modest laser guns, whose defensive role is backed up by a Barrier System: This experimental energy shield erects a spherical electromagnetic field around the hardsuit to deflect incoming energy attacks (such as lasers)... up to a point.

HARDSUIT NENE VERSION-3						390 CP
WEIGHT	62.70 kg			POWER	50 hours	
MANEUVER	-0 DEX & REF			DESIGN & STYLE	+3 PRE	
STRENGTH	STR 10			RUNNING	+4 Move	
LIFTING	Wearer's x10			JUMPING	200m	
SENSOR RANGE	25 km			COMM RANGE	Orbital	
ARMOR KD	55KD			STRUCTURE	60 Hits	
WEAPON	WA	RNG	DMG	LOC	SPECIAL NOTES	
LASER BEAM	+0	650m	14D6	A, A	Gun on each arm, no Link; ROF 10.	
LASER BURST	-1	450m	7D6	"	ROF ∞.	
LASER SCRIBBLE	+3	200m	1D6+2	"	ROF ∞.	
PULSE-STRIKERS	+3	212m	25D6	A, A	*5m area, shock, warmup 1.	
HAND-TO-HAND	+0	-	10D6	A, A	Stun damage only.	
BARRIER SYSTEM: 120KD vs <i>energy attacks ONLY</i> ; stops any attack of less than 120 points, but once penetrated, it is useless 'til repaired. Erecting it takes 1 Action, which can be "Aborted" to (see <i>BGC</i> p.41), but Nene <i>can't move</i> while barrier is up.						
ECM/ECCM: Wings house Rank-8 Anti-Missile/Radar/Sensor ECM & ECCM, 50m radius (a -3 called shot that penetrates armor destroys a wing). With ECM, Nene can try to take over missiles while they're in flight: This takes 1 Action, which can be "Aborted" to, (<i>BGC</i> p.41) and requires an INT +EW Skill +3 (her computer) roll vs missiles' attack roll. Success means Nene can attack with the missiles herself!						
COMPUTER SYSTEM: POW = 9, with prehensile connector cords. By jacking into the chinks in an enemy's armor (as per <i>BGC</i> p.49, #5, Special Case 2), she can take over Boomers, Powered Suits, Battlemovers and other mecha; this requires an INT +Hacking skill +3 (for the computer) +die roll vs the Boomer's INTx2 +die roll (or a base 10 +die roll for other mecha). If Nene succeeds, she is in control of the target for as many Phases as her margin of success (i.e., if her roll was 6 more than the target's roll, she is in control for 6 phases).						
SUBSYSTEMS: <i>Hardsuit Armor is Fusion-Proof</i> • Hypersensor Helmet: Optical, audio, scrambled radio, targeting, low-light vision, instrumentation, thermograph, X-ray, seismic scanners, magnetometer, Target analyzer, Heads-Up Display; +3 Perception. • Backpack radar array (250km range), • Life Support (full sealing vs Nuclear, Biological & Chemical agents). • Maneuvering Verniers & Jumpjets. • Flat-actuated linear motor system (innerwear necessary). • Emergency armor-ejection function (blows armor off wearer).						

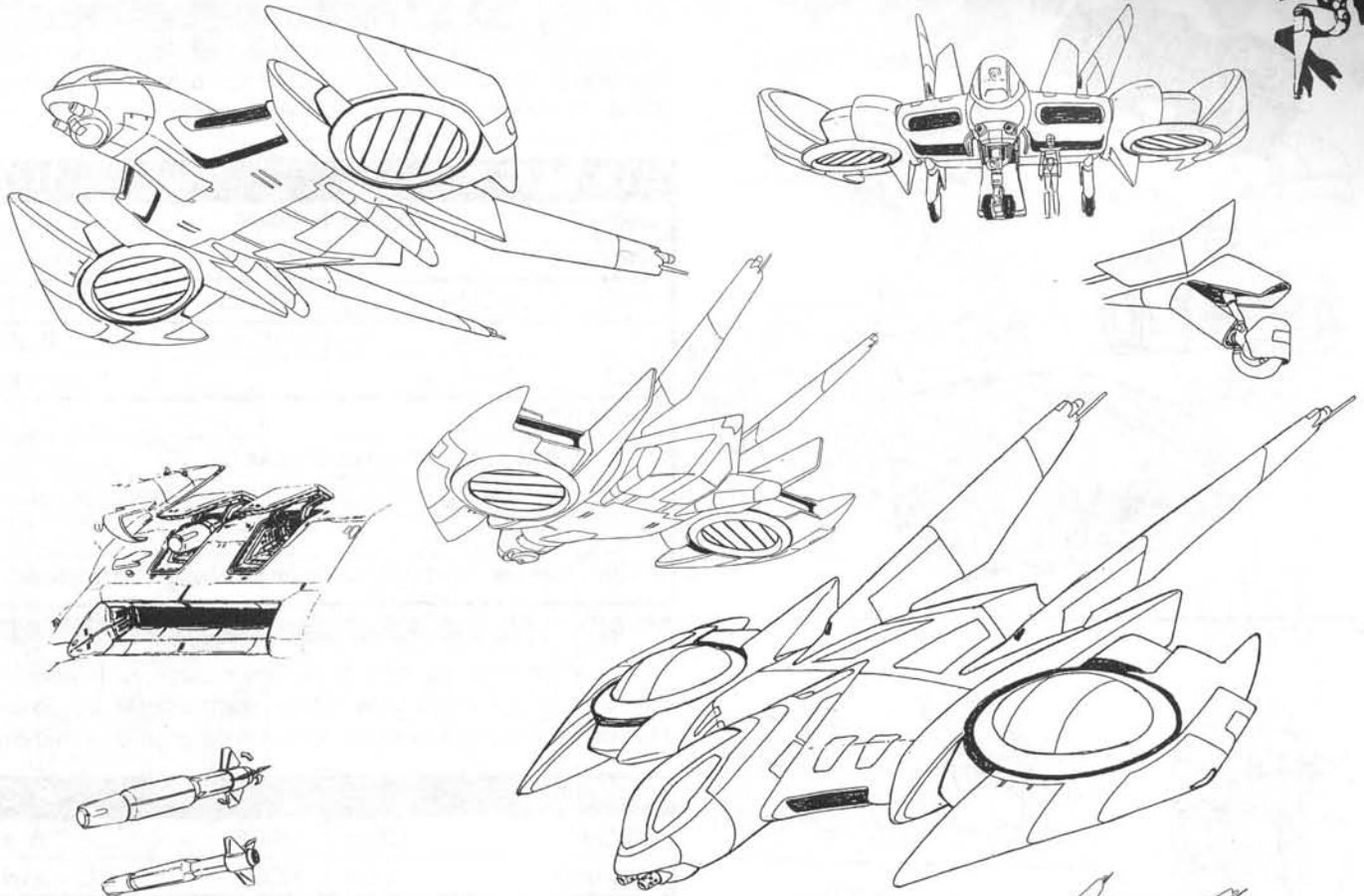

KNIGHT WING

166 CP

WEIGHT	7,450 kg	SPACE	1 pilot, 3 passengers		
MANEUVER	-0 REF	MOVE	281 (843kph)		
ID10	LOCATION	ARMOR	STRUCTURE		
1-5	Fuselage	1K	4K		
6-7	Right Wing	1K	2K		
8-9	Left Wing	1K	2K		
10 WEAPONS	WA	RNG	DMG	LOC	SPECIAL NOTES
LASER TURRET	+0	785m	2K	Fus	ROF = 2.
MISSILES x4	+0*	900m	3K*	Fus	*Smart (18 +die).
BEAM CANNONS	+3	1600m	4K*2	W,W	*Each (X-Link), Warmup=3.

SUBSYSTEMS

- Twin variable-geometry turbofans with rear jet nozzles (for VTOL capability and high-speed flight).
- Deployable Hypersensor array: Wide-spectrum scanner systems (50km range, +5 Perception), radar (500km), orbital comm range.
- POW-9 computer system (can be added to Nene's own computer bonuses), ECCM System (Rank = 8), radio scrambler.
- Life Support (full sealing vs Nuclear, Biological & Chemical agents).
- Emergency ejection system for pilot, closed interior cabin (for 3).
- Storage bay (with a capacity for 1000kg of storage, such as Hardsuits, Hardsuit add-on equipment, Motorslaves, etc.)
- Any number of missiles (up to 4) can be fired at up to 4 targets in one Action; they can also be used to shoot down incoming missiles.

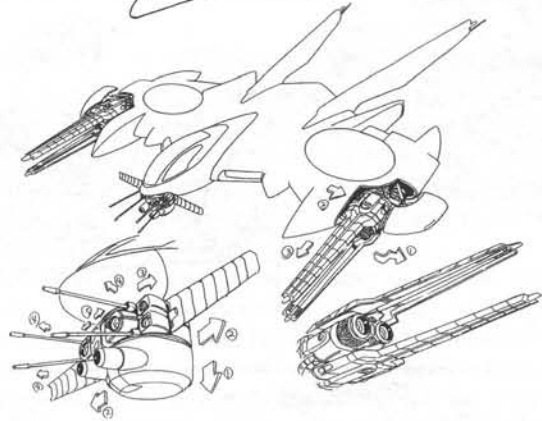

▼KNIGHT WING

After the apocalyptic battle with Largo atop Genom Tower, Sylia recognized the necessity of high-speed response and air support. When she upgraded the Hardsuits in 2034, a combat aircraft exclusive to the Knight Sabers was also constructed. Like the Skycarrier before it, the Knight Wing serves as a mobile command center for the Knight Sabers, but it is smaller, faster, more maneuverable, and much more capably armed—in addition to four interceptor missiles and a dual-barrel laser bolt turret, its wings conceal twin beam cannons. The cannons deliver a devastating blast, but suffer from a slow recharge rate. The Knight Wing's hangar is located inside Lady633; with only a six-second launch time, it can respond to any threat in the city immediately. Sylia normally pilots the VTOL craft from the cockpit, while the others are seated in an enclosed rear cabin which features a powerful computer suite. A storage deck can store 1000kg of equipment, and the chin turret conceals a set of Hypersensors as well as housing the laser-bolt guns.

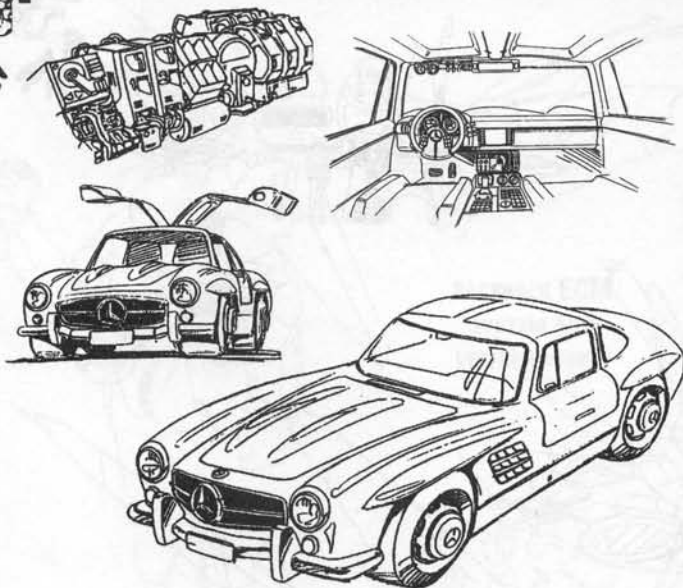

▼SYLIA'S CAR

Sylia's car is a classic: A 1954 Mercedes-Benz 300SL. At least, that's what it appears to be. In fact, it's a gasohol-powered replica, equipped with the latest high-tech devices (including a cellphone, fax, computer, stereo, GPS, etc.), which are stowed in secret pop-out panels.

SYLIA'S CAR 11 CP

WEIGHT		1,200 kg	SPACE		1 driver, 1 passenger
MANEUVER		-3 Ref	MOVE		67 (200kph)
1D10	LOCATION	ARMOR	STRUCTURE		
1-7	Chassis	15 KD	45 SDP		
8-10	Wheels (4)	-	10 SDP each		

SUBSYSTEMS

- Cellular phone, radio (10km range), scrambler, fax.
- Voice stress analyzer (+2 to Perception to detect lies), stereo system, global positioning system.
- POW-3 computer with cellular modem link to Ladys633 computer system.

▼PRISS' BIKE

If you mention Priss, you have to mention motorcycles. However, her newest motorcycle didn't really feature prominently in the series—although it is an excellent machine, forkless in design, with an all-ceramic

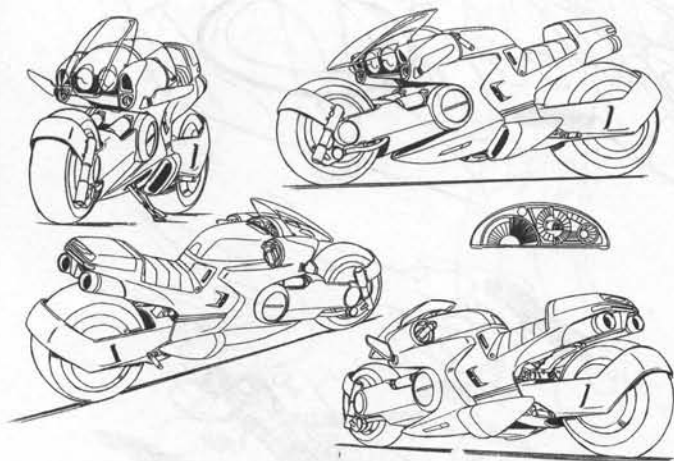

PRISS' BIKE 8 CP

WEIGHT		136 kg	SPACE		1 driver
MANEUVER		-0 Ref	MOVE		133 (400kph)
1D10	LOCATION	ARMOR	STRUCTURE		
1-7	Chassis	5 KD	28 SDP		
8	Front Wheel	-	7 SDP		
9-10	Rear Wheel	-	9 SDP		

SUBSYSTEMS

- Powered rear-view mirrors, European-styler dual-headlight arrangement, digital instrumentation.
- All-ceramic gasohol-powered engine.

▼LINNA'S WAGON

Being a pragmatic person, Linna tends to like compact minivans—they're small enough to park easily in the city, but have enough room to carry a lot of cargo. Linna's new wheels for 2034 is actually her largest car yet.

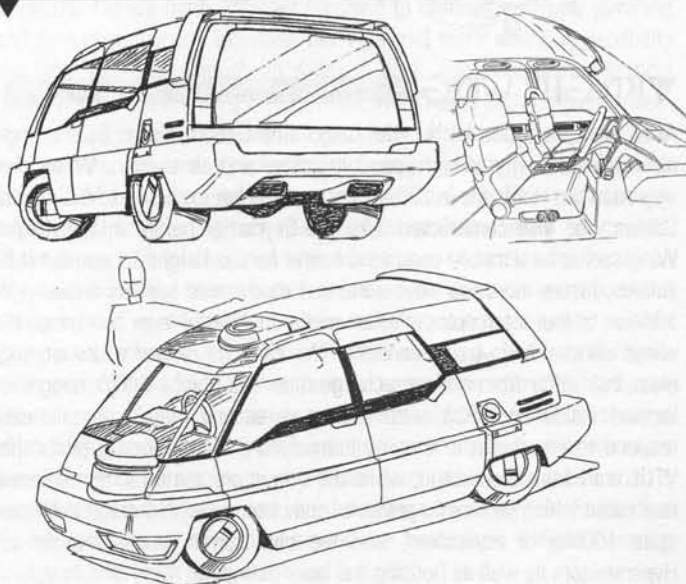

LINNA'S WAGON 4 CP

WEIGHT		1063 kg	SPACE		1 driver, 4 passengers
MANEUVER		-4 Ref	MOVE		60 (180kph)
1D10	LOCATION	ARMOR	STRUCTURE		
1-8	Chassis	8 KD	55 SDP		
9-10	Wheels (4)	-	5 SDP		

SUBSYSTEMS

- Spotlights
- Stereo
- Traffic navigation system
- Large cargo space

BOOMERS 2034

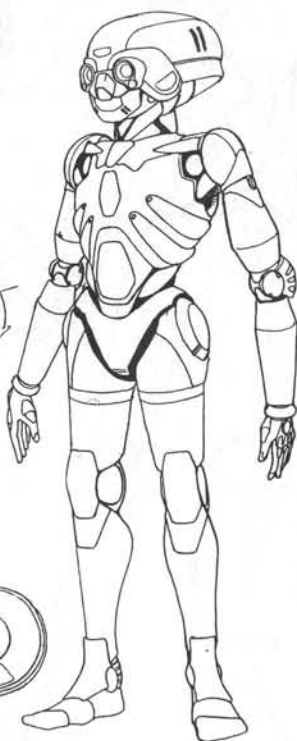
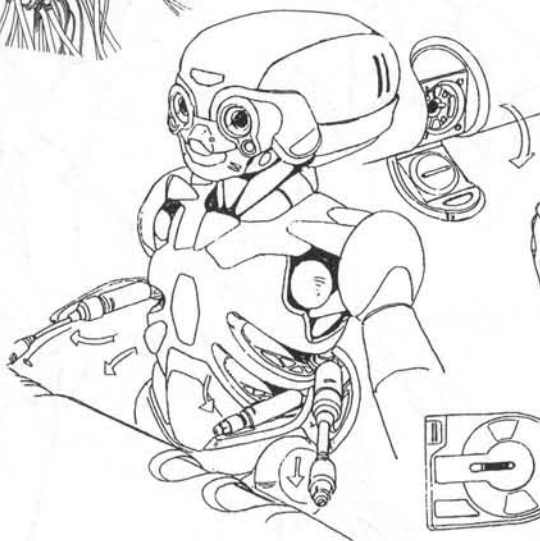
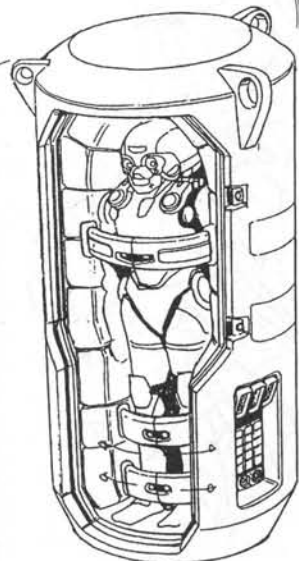
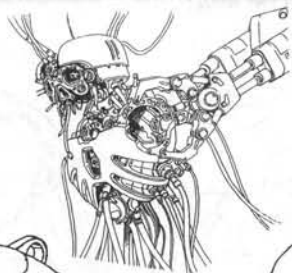

ADAMA

WEIGHT	180 kg	TYPE	Second Generation		
ARMOR	10 KD	RUNNING	6 (18kph)		
STRUCTURE	30 SDP	FLY/SKIM	-0-		
REF	3	INT	10	AI RATING	Level 7
DEX	3	PRE	6	SKILLS	see below*
STR	2	WILL	10	BODY	6
MOVE	6	TECH	10	RECOVERY	4/t
WEAPONS	WA	RNG	DMG	LOC	SPECIAL NOTES
HAND-TO-HAND	+0	-	2D6*	A, A	*Killing damage.
SUBSYSTEMS					
<ul style="list-style-type: none"> • Adama's special AI is capable of line-of-sight electronic communication with other Boomers; using this method, Adama can effectively Hack a Boomer's brain (given a proximity of 3m/y and 3 Phases). • Imprinted AI brain; No human disguise function; no Fusion ability. • Interface jacks in ribs for I/O with Geo City's computer system. 					
*SKILLS					
PERCEPTION	+4	ATHLETICS	+2		
CONCENTRATION	+6	COMPUTER	+8		
EDUCATION	+3	HACKING	+10		
PERSUASION	+5	RESEARCH	+6		
SOCIAL	+4	HIGH TECH	+7		
LOCAL KNOWLEDGE	+1				
TEACHING	+5				

▼ADAMA

Created by Dr. Haynes in Geo City's 41st sublevel, this short-lived but revolutionary cyberdroid was the first Second-Generation Boomer. C1XA4-TPAA was named "Adama" after Dr. Stingray's first Boomer ever, whose name was a reference to the second of the Cabbalah's seven Earths: A world characterized by a memory-wiping malaise and populated by the restless, melancholy descendants of Adam.

Unlike previous boomers, whose AI's were derived from the human brain, Adama was equipped with a new type of *fully inorganic* artificial intelligence. This innovation made him the first fully mechanical (i.e., non-biological) boomer to display mental abilities comparable to those of a human being. While previous boomers have displayed similar levels of intellect (the 33-S series, for example), they were all biological Android types.

Adama's AI was also remarkable in that its special algorithms could interface seamlessly with any computerized system. This could be achieved through an optical link (such as can be achieved with eye contact between two Boomers) or physical access (which could be achieved via Adama's universal datalink cables, which are deployed from his rib sections). Once an interface has been achieved, Adama could effectively reprogram—on the fly—anything from a microwave oven to a boomer brain. However, in order to download his own visual memories, Adama must connect to the super-computer mainframe on sublevel 41 of Geo City.

In order to make him less threatening to human beings, Adama's physical capabilities were limited to human levels, so his raw strength and physical endurance were roughly equivalent to those of an average person.

Adama's first experience was to be kidnaped by Dr. Yuri, who framed Dr. Haynes and planned to install Adama's AI in the prototype "Iron Lizard" battle boomer. Adama was rescued by Priss, and although he was terminated by the Iron Lizard, he was able to prove Dr. Haynes' innocence ... and he made Priss see boomers a little differently.



FEMALE-MODEL TERRORIST BOOMER—THIS WAS THE ONLY ONE OF DR. YURI'S POSSE TO SURVIVE *Geo Climbers* PHYSICALLY INTACT. WHERE IS SHE NOW?

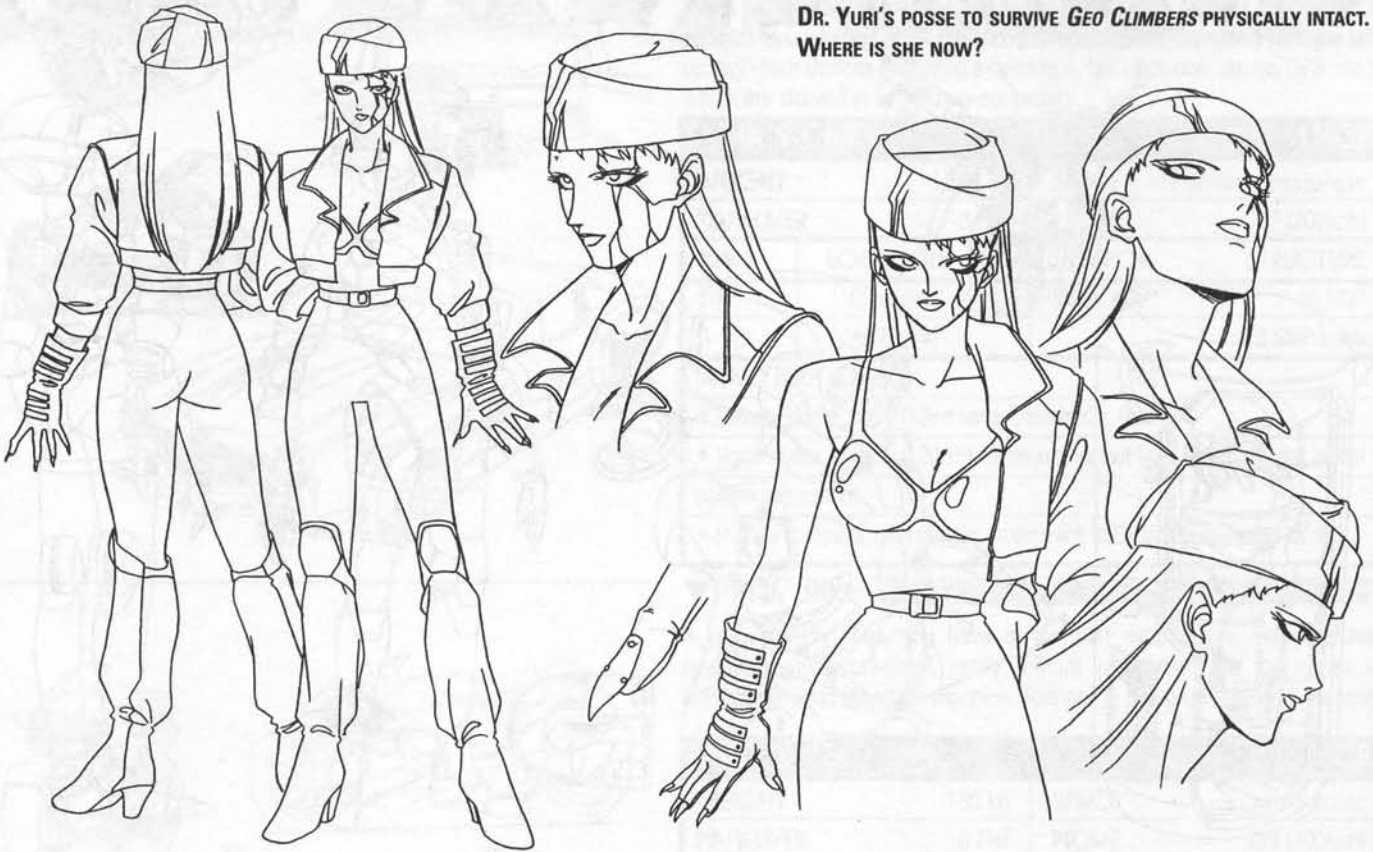

THE OTHER FOUR TERRORIST BOOMERS IN DR. YURI'S GANG, EACH WITH ITS OWN DISTINCT "CYBERPUNK" STREET-STYLING



▼ **TERRORIST BOOMERS**

When the nefarious Dr. Yuri planned to kill Dr. Haynes and steal the second-generation prototype Adama, he needed some cheap muscle to do his dirty work ... and cheap muscle is what Terrorist Boomers are all about. These imitation combat boomers are constructed by street techs who recycle civilian cyberdroids into kitbashed fighting machines and then sell them on the black market.

In order to carry out his plan, Dr. Yuri purchased five Terrorist Boomers. Since they didn't come with any built-in weapons, Dr. Yuri armed them with an assortment of second-hand assault weapons which were purchased as illegally as the boomers themselves. After Dr. Haynes and his staff had been assassinated, these five stone-cold killers were sent to recapture Adama and kill his rescuer—Priss. All of them were destroyed by Priss, except for the female-style boomer (featured above), whom Adama reprogrammed into a smiling moron.

GAME NOTE: If any player is interested in buying his own gang of Terrorist Boomers, they go for ¥5,400,000 (or 43 CP) each. Hey, that's one robo-thug per week at Wealth level 10!

TERRORIST BOOMERS

WEIGHT	360 kg	TYPE	Combat		
ARMOR	25 PD	RUNNING	6 (18kph)		
STRUCTURE	50 SDP	FLY/SKIM	-0-		
REF	5	INT	3	AI RATING	Level 4
DEX	5	PRE	4	SKILLS	+4*
STR	8	WILL	4	BODY	10
MOVE	6	TECH	3	RECOVERY	16/t
WEAPONS	WA	RNG	DMG	LOC	SPECIAL NOTES
HAND-TO-HAND	+0	-	8D6*	RA, LA	*Killing.

SUBSYSTEMS

- Robotic brain.
 - Optics with targeting, lowlight, and IR functions.
 - Scrambled radio with 50km range.
 - Cyborg appearance: Physical styling resembles "cyberpunk" subculture; does not rip out of this disguise.
 - Effectively no Fusion ability.
- *Related Skills include: *Perception, Athletics, Hand-to-Hand, Firearms, Melee, Driving.*

Commonly used weapons include: Assault module, battle rifle, and Razor Gloves (+1D6 damage in Hand-to-Hand combat).



TERRORIST BOOMER LEADER

WEIGHT	425 kg	TYPE	Combat
ARMOR	30 PD	RUNNING	18 (54 kph)
STRUCTURE	60 SDP	FLY/SKIM	42 (126 kph); 2/∞
REF	6	INT	4
DEX	6	PRE	6
STR	10	WILL	5
MOVE	18	TECH	3
AI RATING	Level 5		
SKILLS	+5*		
BODY	12		
RECOVERY	20/t		

WEAPONS	WA	RNG	DMG	LOC	SPECIAL NOTES
HAND-TO-HAND	+0	-	10D6*	A, A	*Killing damage.
FINGER-CLAWS	+0	-	14D6	Arm	Each hand has claws.
MOUTH LASER	+0	720m	18D6	H	-

SUBSYSTEMS:

- Imprinted AI brain.
- Scrambled radio w/ 50km range.
- Shieldable optics with targeting, lowlight, & IR functions.
- Human disguise function; must rip out of disguise in order to deploy weapons; INT + Perception vs 20 to detect.
- Limited Fusion ability; can absorb, control, and animate 125kg of mechanical material.

*Related Skills include: *Perception, Persuasion, Computers, Leadership, Expert: Tactics, Athletics, Hand-to-Hand, Firearms, Melee, Driving.*



▼ TERRORIST BOOMER LEADER

Having bought himself a posse of cheap, disposable thugs, Dr. Yuri wisely decided to spend the extra cash to buy his gang a competent field leader. Using his connections and contacts within Genom, he bought a genuine combat boomer which had been programmed for tactics and intimidation.

While this combat model was by no means top of the line, it was still far superior to the Terrorist Boomers (not to mention the average human). Unlike the street-made Terrorist units, this cyberdroid was equipped with vicious finger-daggers and the signature C-series oral cavity laser lens. As always, these weapons could only be used at the expense of the polymer "skin" camouflage. However, its diametric optic arrays allowed multi-spectrum scans without shedding any skin (only shades).

Given the high cost of a true combat boomer, this cyberdroid eschewed the Terrorists' "cyberpunk" styling, instead sporting a cooler, more European appearance.

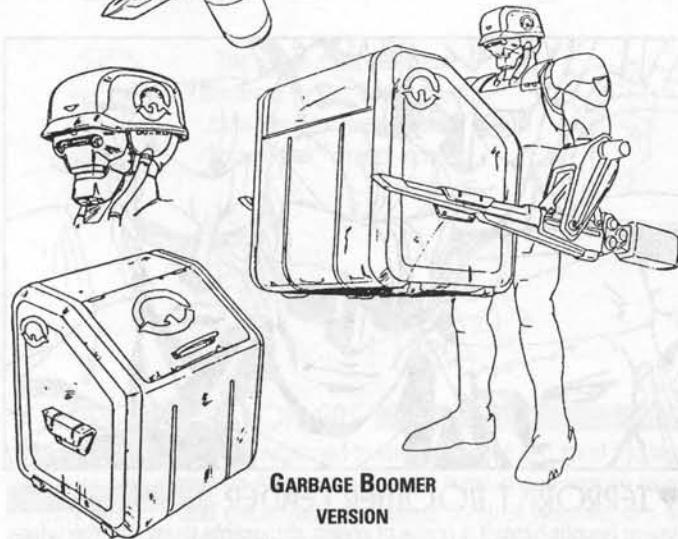
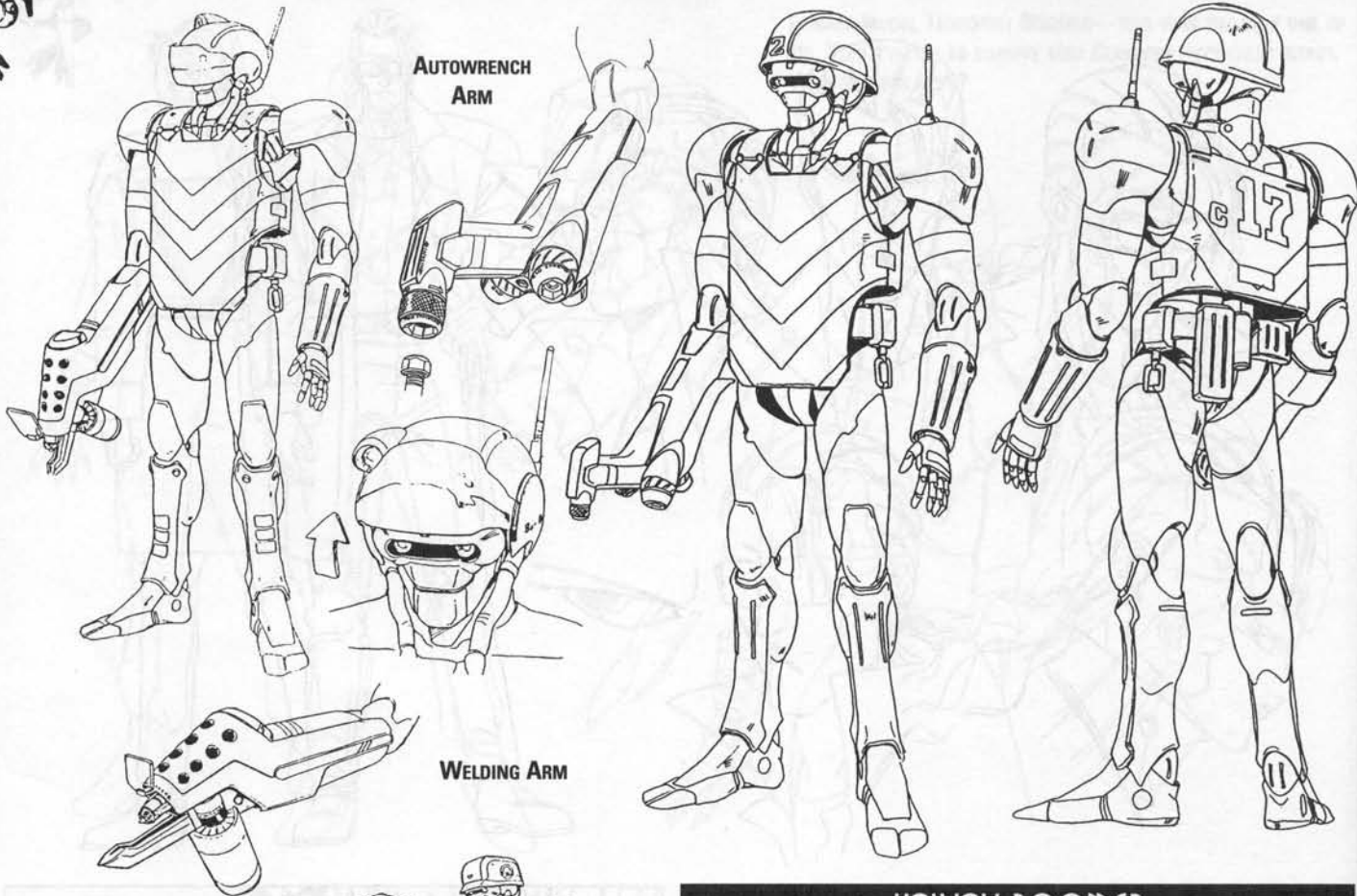

GARBAGE BOOMER VERSION

▼ UTILITY BOOMER

Utility Boomers are designed to be modular, thus fulfilling a variety of roles. They are most often used in menial tasks such as construction, mining, and sanitation. As part of Genom's new crop of cheap cyberdroids, their batteries need frequent recharging (this power storage device gives off a very hot thermographic pattern, unlike the cold pattern of more sophisticated boomers); during this downtime, they contact a supervisory computer through the Net (see p.48). Construction types are usually equipped with a tool on the right arm, such as a welder or autowrench. Sanitation models have both forearms replaced with forklift-style blades designed to fit the latches on city dumpsters, and are transported by special driverless garbage trucks with built-in compactors (see p.96).

UTILITY BOOMER

WEIGHT	522 kg	TYPE	Labor
ARMOR	20 KD	RUNNING	6 (18 kph)
STRUCTURE	55 SDP	FLY/SKIM	-0-
REF	4	INT	2
DEX	2	PRE	1
STR	9	WILL	2
MOVE	6	TECH	7
AI RATING	Level 3		
SKILLS	+3*		
BODY	11		
RECOVERY	16/t		

WEAPONS	WA	RNG	DMG	LOC	SPECIAL NOTES
HAND-TO-HAND	+0	-	9D6*	RA, LA	*Killing damage.
WELDING TORCH	-1	-	8D6*	R. Arm	*EMW (-20 KD), ∞ ROF.
ARM FORKS	+1	-	10D6*	Arms	*Each; Linked.

SUBSYSTEMS

- Robotic brain and cheap voice synthesizer.
- Optics with lowlight function and radio antenna with 10km range.
- Built-in battery requires recharging once per day.
- "Tool belt"-style equipment packs, storing assorted construction tools and devices.
- Interchangeable arms: Options include an Autowrench which can accommodate numerous heads, an arc welder (includes a welder's-mask shield for optics), or a pair of forks designed to heft garbage dumpsters.
- No Fusion ability.
- Related skills include: *Perception, Athletics, Building, Demolitions, Operate Heavy Machinery, Basic Tech.*

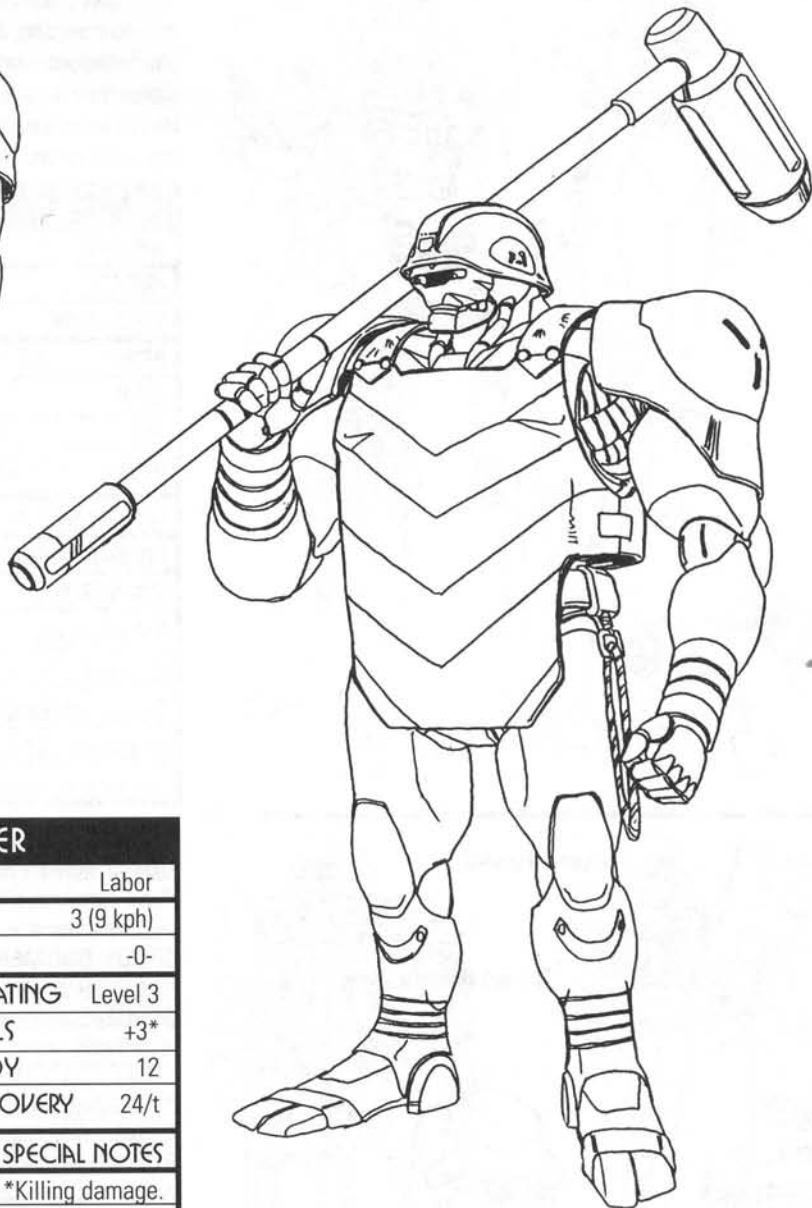
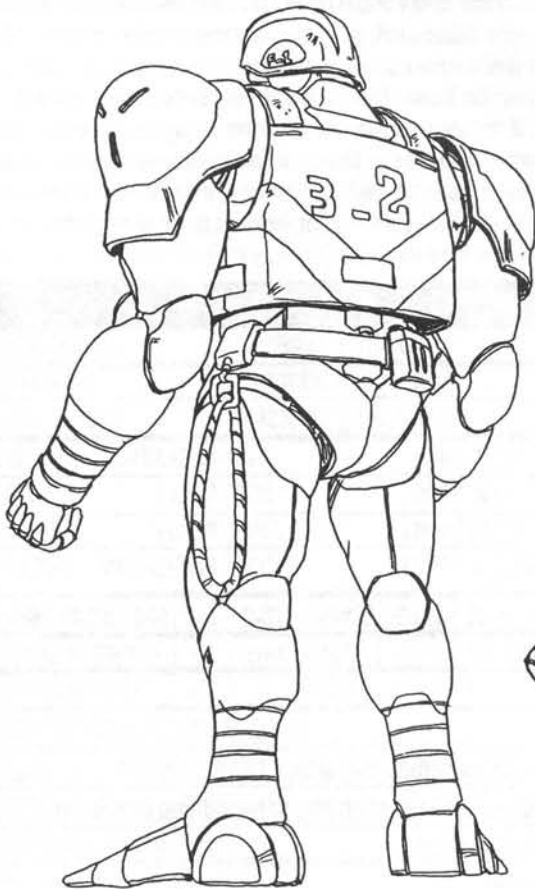

CONSTRUCTION BOOMER

WEIGHT	730 kg	TYPE	Labor		
ARMOR	20 KD	RUNNING	3 (9 kph)		
STRUCTURE	60 SDP	FLY/SKIM	-0-		
REF	3	INT	2	AI RATING	Level 3
DEX	4	PRE	1	SKILLS	+3*
STR	12	WILL	2	BODY	12
MOVE	12	TECH	6	RECOVERY	24/t
WEAPONS	WA	RNG	DMG	LOC	SPECIAL NOTES
HAND-TO-HAND	+0	-	12D6*	Arms	*Killing damage.
SLEDGEHAMMER	-1	3m	15D6	2-hand	(handheld)

SUBSYSTEMS

- Robotic brain and cheap voice synthesizer.
- Optics with lowlight function and radio with 1km range.
- Built-in battery requires recharging every 2+1D6/2 days.
- Latches and cables for use while working on "High Steel".
- No built-in tools, but can use oversized tools such as bolt guns, jackhammers, steam rollers, asphalt-cutting rotary saws, etc.
- No Fusion ability.
- Related skills include: *Perception, Athletics, Building, Demolitions, Operate Heavy Machinery, Basic Tech.*

▼ CONSTRUCTION BOOMER

The 2034-model Construction Boomers are part of the same group of cheap cyberdroids as the Utility Boomers, but are designed around a non-modular principle: Construction Boomers are just *strong*. They do the really heavy jobs, those that the smaller Utility Boomers can't handle, such as carrying steel girders, moving modular building components (such as skyscraper air conditioners), and lifting other objects that weigh about, oh, five tons! Like Utility types, Construction Boomers use low-capacity batteries which tend to run hot, and access online support while recharging (see p.48). Even so, MegaTokyo's seemingly endless growth overwhelms even boomer labor, leading to frequent breakdowns and occasional insanity due to overwork.



▼UP-74 COFFEE BOOMER

As another of Genom's recent batch of mass-market cyberdroids, the UP-74 is a fairly standard D-grade mannequin with blue-green skin and little conversational ability. Its most distinctive feature is a built-in coffeemaker; housed in the chest section, it transfers fresh-brewed coffee through a channel in the arm to the pot, ready to serve. In addition, the left forearm features a built-in digital ordering unit and credit transactor. The front of the UP-74's uniform doubles as an access panel for the coffeemaker, which is prone to breakdowns—hey, what do you expect for a measly 8.7 million Yen?

COFFEE BOOMER

WEIGHT	247 kg	TYPE	Mannequin		
ARMOR	15 KD	RUNNING	3 (9 kph)		
STRUCTURE	35 SDP	FLY/SKIM	-0-		
REF	2	INT	2	AI RATING	Level 2
DEX	2	PRE	2	SKILLS	+2*
STR	4	WILL	1	BODY	7
MOVE	3	TECH	3	RECOVERY	8/d
WEAPONS	WA	RNG	DMG	LOC	SPECIAL NOTES
HAND-TO-HAND	+0	-	4D6*	Arms	*8D6 if crazy.
SUBSYSTEMS:					
Robotic brain.					
Built-in digital order pad/credit transactor.					
Built-in coffeemaker, linked through arm to hand-fitted coffee pot.					
Effectively no Fusion ability.					
No disguise function.					

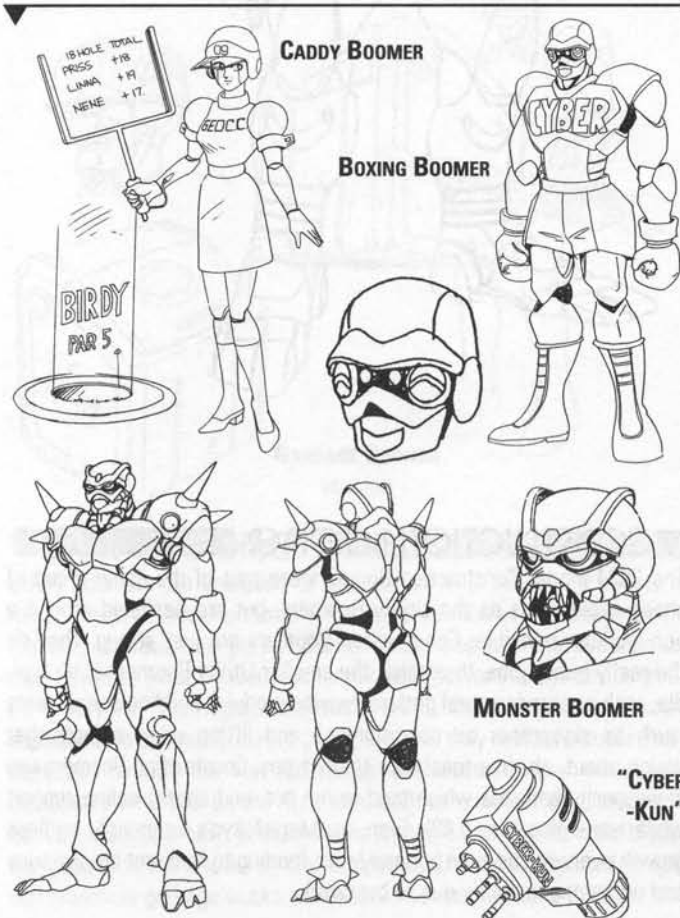

▼BACKGROUND BOOMERS

Several minor cyberdroids appeared in the *Bubblegum Crash!* videos, doing little more than providing some background color. However, you may have more uses for them:

CADDY BOOMER: 265kg; Labor-type; AI Level = 2
 Golf is big in Japan, so these simple, cheap cyberdroids sell quite well. Geo City has several of these units, which are designed to lug clubs and record golf scores with their holographic counters.

INT 1, TECH 3, WILL 2, PRE 2, REF 3, DEX 1, STR 5, BOD 8, MOVE 12.
 All relevant Skills +2; Hand-to-Hand = 5D6; KD 15, SDP 40, REC 10/t.
 Systems & Notes: Radio (1km), holographic score-counter.

BOXING BOOMER: 325kg; Labor-type; AI Level = 4
 While this cyberdroid appeared in an ad for the "Cyber-Kun" power-up device, similarly modified units have been known to be used in underground gambling boomer fights (see page 55).

INT 2, TECH 6, WILL 3, PRE 2, REF 6, DEX 5, STR 8, BOD 10, MOVE 18.
 All relevant Skills +4; Hand-to-Hand = 8D6; KD 15, SDP 50, REC 16/t.
 Systems & Notes: Optics with lowlight & IR, radio (10km); often street-modified and prone to malfunction.

MONSTER BOOMER: 420kg; Combat-type; AI Level = 4
 This fearsome-looking cyberdroid is merely a cosmetically modified Ebisu Generic Boomer (BGC p.108), used in the AD Police's recruitment ad campaign. However, it's entirely possible that street-modified Generic Boomers used by organized crime groups would be similar.

INT 2, TECH 2, WILL 3, PRE 5, REF 6, DEX 6, STR 10, BOD 10, MOVE 18.
 All relevant Skills +4; Hand-to-Hand = 10D6; KD 35, SDP 50, REC 20/t.
 Systems & Notes: Optics with lowlight & IR, radio (10km); Mouth Laser (WA+0, 500m, 10D6), Shoulder Spikes (WA-1, +4D6 to Ramming attacks).

"CYBER-KUN": This small battery booster can either extend your Boomer's STR by +1 (at the cost of halving operating time) or it can increase the operating time of your Boomer by +50%. Cost: ¥249,999.



▼ GUARDIAN BOOMER

These cyberdroids are variants of the Police Boomer (see *BGC* p.108), designed to serve double duty as doormen and guards for wealthy, security-conscious companies. To remain inconspicuous, a Guardian Boomer usually wears a uniform and hat, but its voice is quite authoritative and it is equipped with knuckle-mounted tasers for subduing troublemakers. Still, the clanky, literal-minded Guardian Boomers are no match for heavily armed opponents, so a police-direct commlink is built into the wrist. Since they regularly interact with workers, each one gets a "pet name."

GUARDIAN BOOMER

WEIGHT	295 kg	TYPE	Mannequin		
ARMOR	20 KD	RUNNING	9 (18 kph)		
STRUCTURE	40 SDP	FLY/SKIM	-0-		
REF	6	INT	5	AI RATING	Level 5
DEX	6	PRE	6	SKILLS	+5*
STR	6	WILL	4	BODY	8
MOVE	9	TECH	3	RECOVERY	8/t

WEAPONS	WA	RNG	DMG	LOC	SPECIAL NOTES
HAND-TO-HAND	+0	-	6D6*	Arms	*Killing damage.
TASER KNUCKS	+0	-	6D6*	Hands	*Shock damage.

SUBSYSTEMS: Robotic Brain.
 Optics with targeting, night vision, camera functions.
 Scrambled radio (50km) with direct phonelink to AD Police.
 No Fusion ability.
 No disguise function.

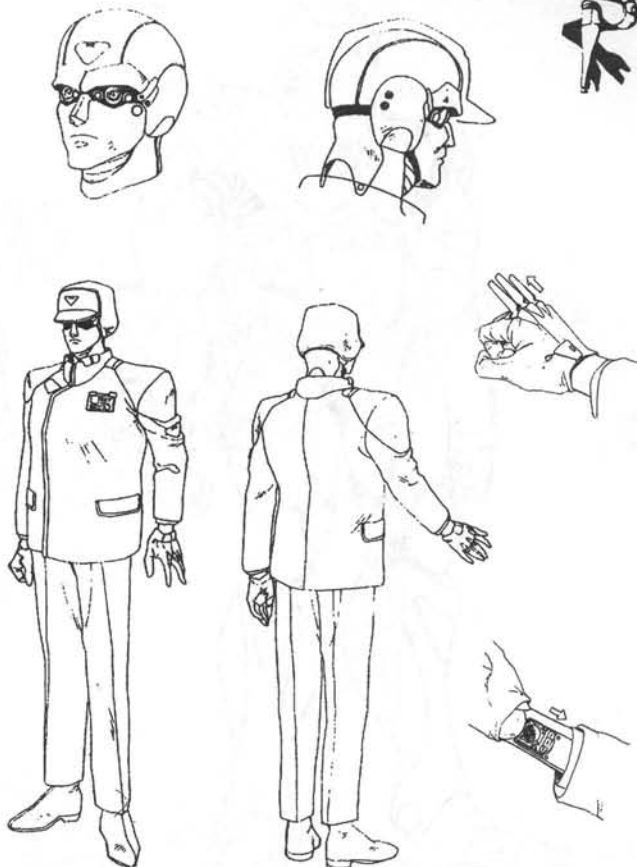

▼ ILLEGAL ARMY COMBAT BOOMERS

Lando's subordinates in *Bubblegum Crash!* were orthodox combat boomers who were modeled after the original members of the Illegal Army—N.S. Frazier, N.R. Brown, N.S. Mouri, and N.R. Rose—all of whom were killed in action years ago. These boomers sported high-powered mouth lasers.

ILLEGAL ARMY COMBAT BOOMERS

WEIGHT	700 kg	TYPE	Combat		
ARMOR	30 PD	RUNNING	18 (54 kph)		
STRUCTURE	60 SDP	FLY/SKIM	42 (126 kph); 2/∞		
REF	6	INT	3	AI RATING	Level 5
DEX	6	PRE	6	SKILLS	+5
STR	10	WILL	5	BODY	12
MOVE	18	TECH	4	RECOVERY	20/t

WEAPONS	WA	RNG	DMG	LOC	SPECIAL NOTES
HAND-TO-HAND	+0	-	10D6	A, A	*Killing damage.
FINGER-BLADES	+0	-	14D6	Arm	On each hand.
MOUTH LASER	+0	850m	25D6	H	-

SUBSYSTEMS:
 • Imprinted AI brain. • Flightjets in calves & back, scrambled radio w/ 50km range. • Shieldable optics with targeting & lowlight functions. • Human disguise function; must rip out of disguise in order to deploy weapons and equipment; INT + Perception vs 20 to detect. • Limited Fusion ability; can absorb, control, and animate 175kg of mechanical material.

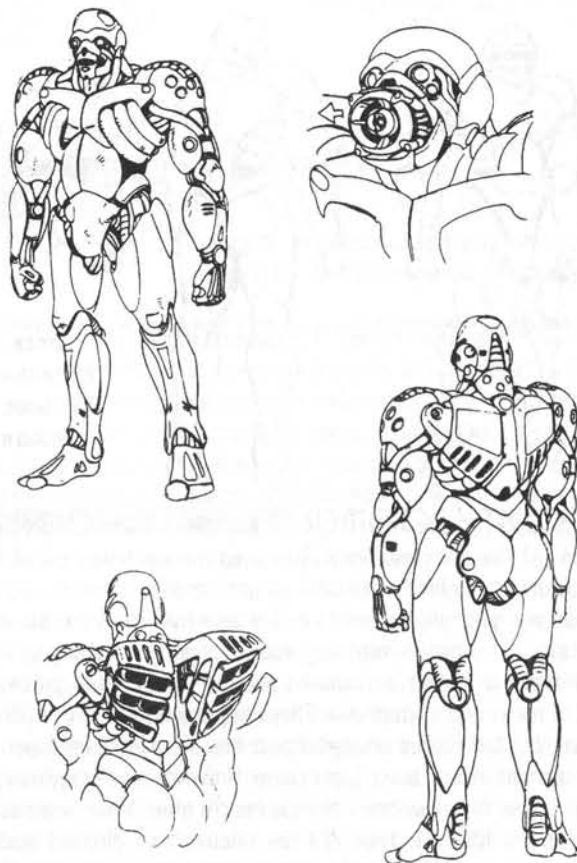

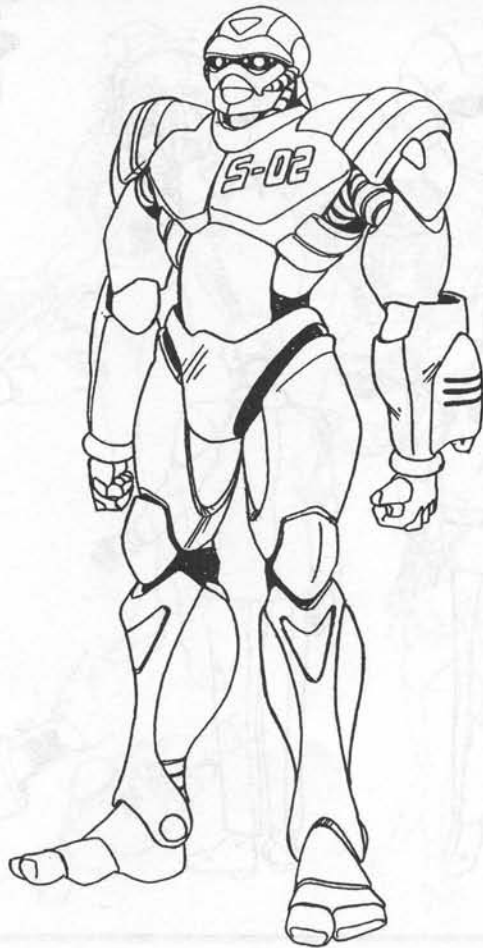

FOREARM
BEAM GUN

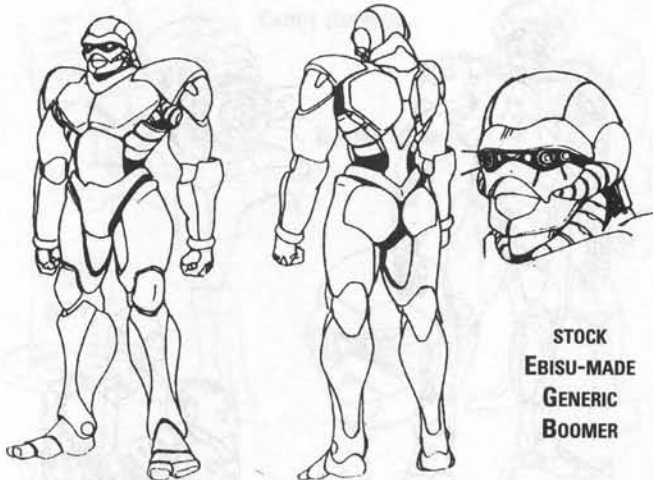

STOCK
EBISU-MADE
GENERIC
BOOMER

▼ SECURITY BOOMER

This one of the many everyday cyberdroid models based off of Ebisu Mechatronics' highly successful generic-model boomer. Security boomers are generally posted to highly sensitive areas outside of the public eye, since they're too dangerous-looking to occupy guard positions—that's a job for a Guardian Boomer—they often protect the vaults of banks and laboratories. They are programmed to use hand-to-hand combat techniques whenever possible, but they're equipped with beam cannons in both arms, just in case. However, since they only have enough power for a few beam firings, they're often armed with assault rifles like the M42-A1. Their AI's are relatively simple, but also just smart enough for the boomer to cry out when "injured." Height: 190cm.

SECURITY BOOMER

WEIGHT	360 kg	TYPE	Combat		
ARMOR	25 KD	RUNNING	18 (54 kph)		
STRUCTURE	50 SDP	FLY/SKIM	-0-		
REF	6	INT	2	AI RATING	Level 4
DEX	5	PRE	6	SKILLS	+4*
STR	6	WILL	3	BODY	10
MOVE	18	TECH	2	RECOVERY	12/t

WEAPONS	WA	RNG	DMG	LOC	SPECIAL NOTES
HAND-TO-HAND	+0	-	6D6*	Arms	*Killing damage.
BEAM GUN	+0	655m	15D6*	Arms	*Each, but not Linked.

SUBSYSTEMS

- Robotic brain.
- Shieldable optics with targeting, lowlight, and IR functions.
- Scrambled radio with 10km range, including "hot link" to AD Police.
- No human disguise option, but added armor.
- No Fusion ability.
- Related Skills include: *Perception, Athletics, Hand-to-Hand, Firearms, Melee, Driving.*



NOTE MOVEMENT RANGE OF
TAIL-MOUNTED LASER BEAM

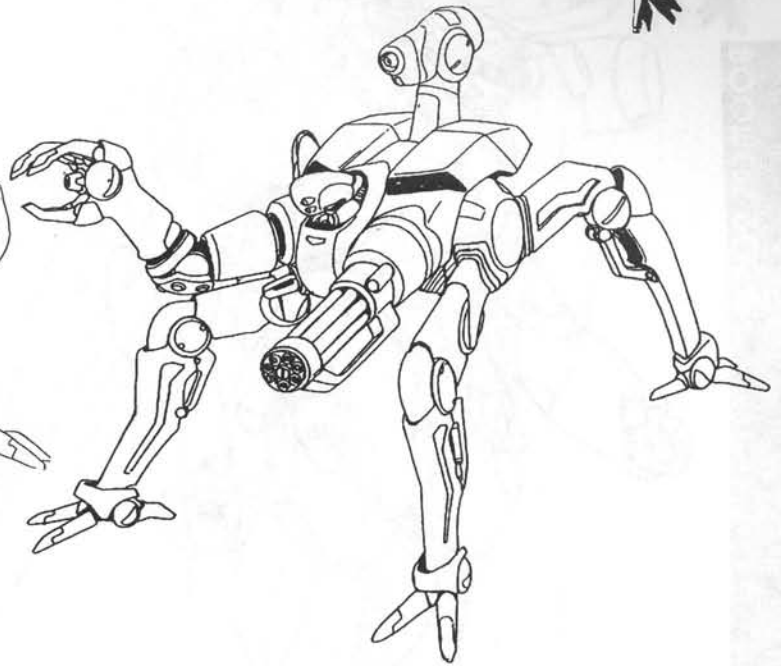
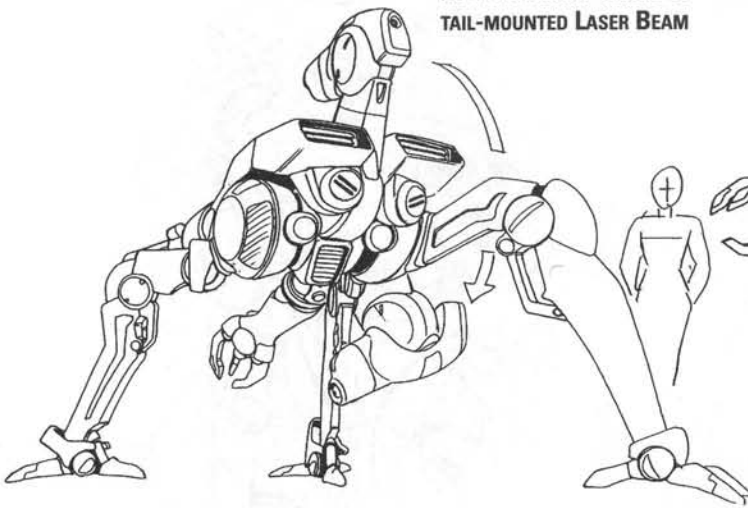

HEIGHT COMPARISON BETWEEN PRISS,
IRON LIZARD, AND HARDSUIT PRISS

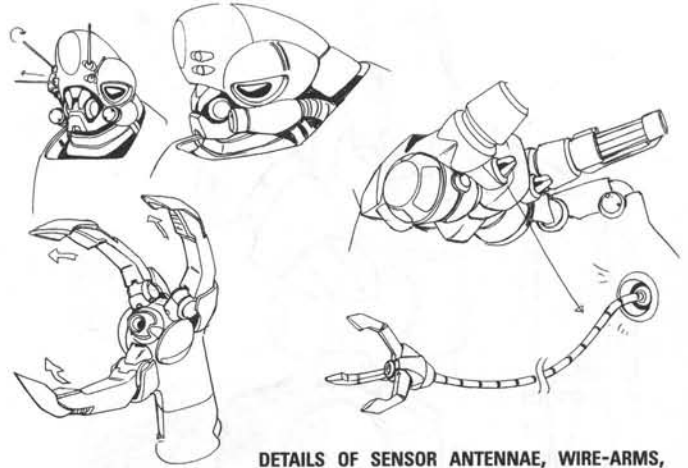
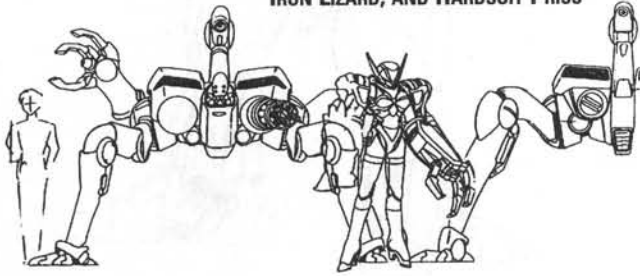

DETAILS OF SENSOR ANTENNAE, WIRE-ARMS,
AND CLAW WITH BUILT-IN OPTICAL SENSOR

IRON LIZARD

WEIGHT	1912 kg	TYPE	Experimental		
ARMOR	75 KD	RUNNING	12 (36 kph)		
STRUCTURE	150 SDP	FLY/SKIM	-		
REF	9	INT	1	AI RATING	Level 5
DEX	9	PRE	7	SKILLS	+5*
STR	14	WILL	9	BODY	30
MOVE	12	TECH	1	RECOVERY	28/t
WEAPONS	WA	RNG	DMG	LOC	SPECIAL NOTES
CLAW	+1	-	2.6K*	Arm	*Armor-Piercing.
WIRE-ARMS	+2	250m	0.2K	T	Twin grapnels.
30mm GATLING	+0	1225m	1.0K	T	ROF = 150, 10 bursts.
LASER BEAM	+0	5.5km	3.0K	Tail	ROF = ∞.

SUBSYSTEMS

- Robotic brain.
- Shieldable optics with targeting, lowlight, and IR functions.
- Weapon notes: Wire-arms are strong enough to support twice the Iron Lizard's own weight, and claw has a built-in sensor (increases accuracy, and good for looking around corners).
- Scrambled radio with 300km range.
- No Fusion ability.

*Related Skills include: *Perception, Athletics, Hand-to-Hand, Firearms, Melee, Heavy Weapons.*

▼EM-302 IRON LIZARD

This experimental battle boomer was designed and developed by Dr. Yuri deep within the military staging area underneath Geo City. Its speed and power set it apart from conventional battle Boomers, but its AI was too buggy to realize the body's full potential. Frustrated that his first-rate boomer had a third-rate brain, Dr. Yuri kidnaped Adama and planned to transplant his AI into the Iron Lizard. The Knight Sabers made short work of this plan.

Despite its shortcomings, the EM-302 was still an excellent war machine. Its four-legged profile gave it excellent balance and stability, and it sported a variety of weapons. Its 30mm gatling gun was ideal for midrange combat, and in close-range or hand-to-hand confrontations it enjoyed a high degree of versatility thanks to its enormous claw and its dual Wire-Arms (launched from the front section).

The EM-302's cortex was too belligerent to follow safety programming (designed to prevent it from hurting people) or exercise any kind of judgement or self-control. Therefore, when he sent it into combat against the Knight Sabers, Dr. Yuri controlled it by remote through a headset synchro-system—this added +2 to the Iron Lizard's INT.

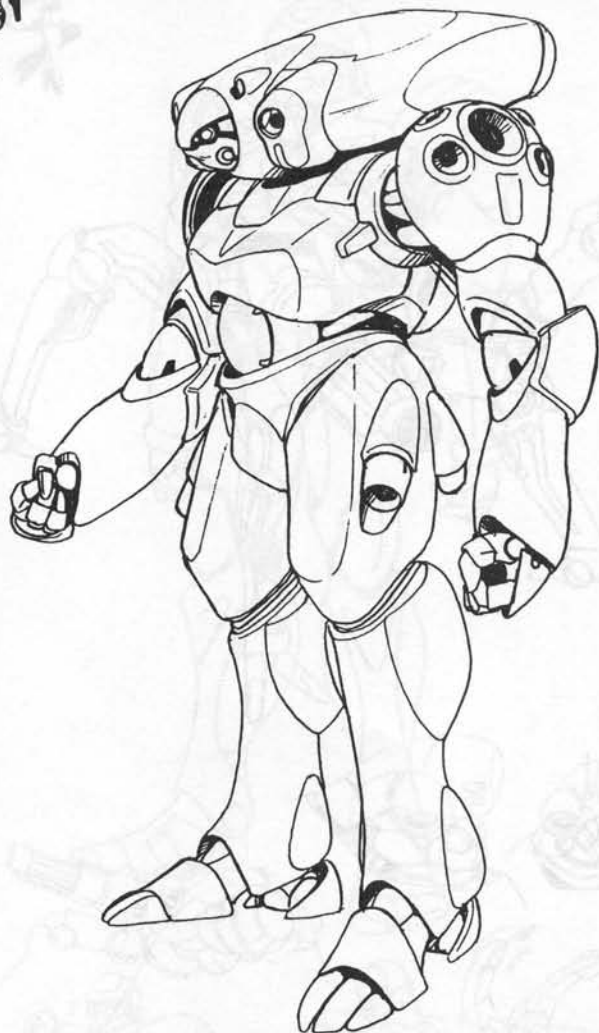

SKETCH
OF
TOP
VIEW

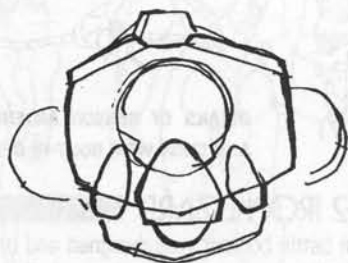

▼BU-12T TEST BOOMER

While the Bu-12B has been a remarkable success, efforts to improve the basic design are always in progress. An official plan to upgrade the Bu-12B has resulted in numerous improvements which were implemented in the 2034-model battle Boomer. The Bu-12T was an interim model which served as a test base for many of these improvements. Most notably, the Bu-12T sports twin multi-role Laser Beam Guns in the head which vent gas out the back. In addition, its armor is composed of superlight composite materials, making it incredibly light for a 2.1-meter cyberdroid. However, there were enough bugs in this model to prevent its final approval from the military, so the few Bu-12T's constructed were relegated to combat-test duty. Since the Bu-12T's were turned down before their flight system was designed, clusters of vernier rockets were installed in their shoulders to ensure their usefulness in their new "target practice" role.

BU-12T TEST BOOMER

WEIGHT	330 kg	TYPE	Battle		
ARMOR	60 KD	RUNNING	12 (36 kph)		
STRUCTURE	100 SDP	JUMPJETS	35m Jumps		
REF	6	INT	3	AI RATING	Level 6
DEX	7	PRE	6	SKILLS	+6*
STR	12	WILL	9	BODY	20
MOVE	12	TECH	5	RECOVERY	24/t
WEAPONS	WA	RNG	DMG	LOC	SPECIAL NOTES
HAND-TO-HAND	+0	-	12D6*	A, A	*Killing damage.
LASER x2	+0	840m	25D6*	RA	*Each (X-Linked), BV = ∞.
SUBSYSTEMS					
• Robotic brain.					
• Jumpjets in thighs.					
• High-maneuverability vernier-rocket clusters in shoulders.					
• Armored optics with targeting, lowlight, and IR functions.					
• Rank-3 ECM & ECCM suite.					
• Scrambled radio with 500km range.					
• Limited Fusion ability: Can absorb, control, and animate 82.5 kg of mechanical material.					
*Relevant Skills include: <i>Perception, Hand-to-Hand, Athletics, Heavy Weapons, Melee & Demolitions.</i>					

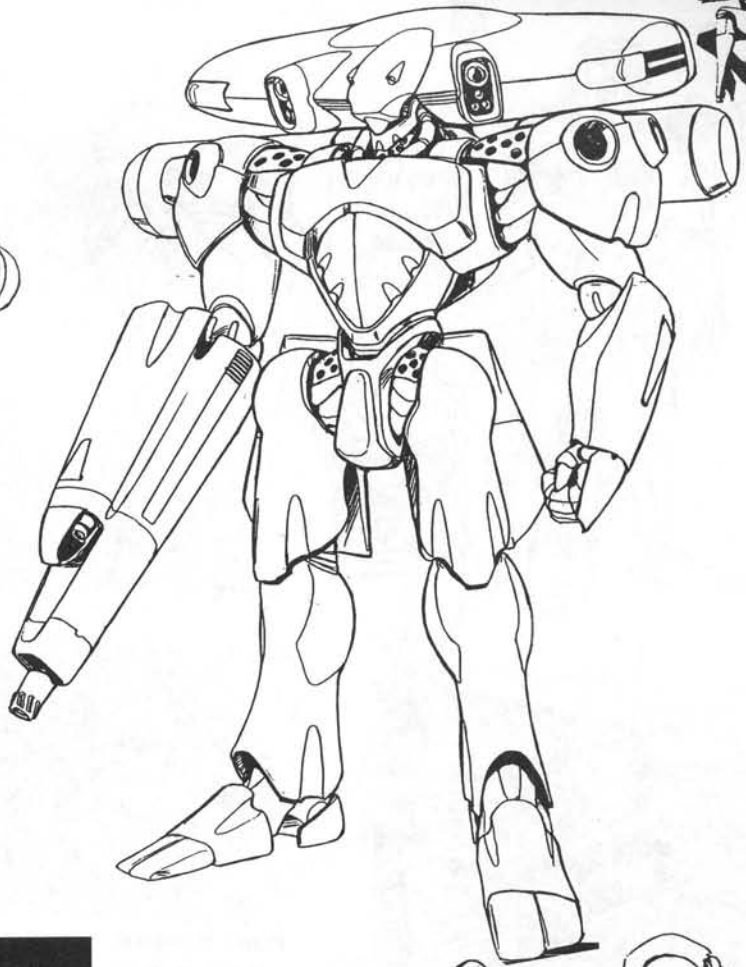
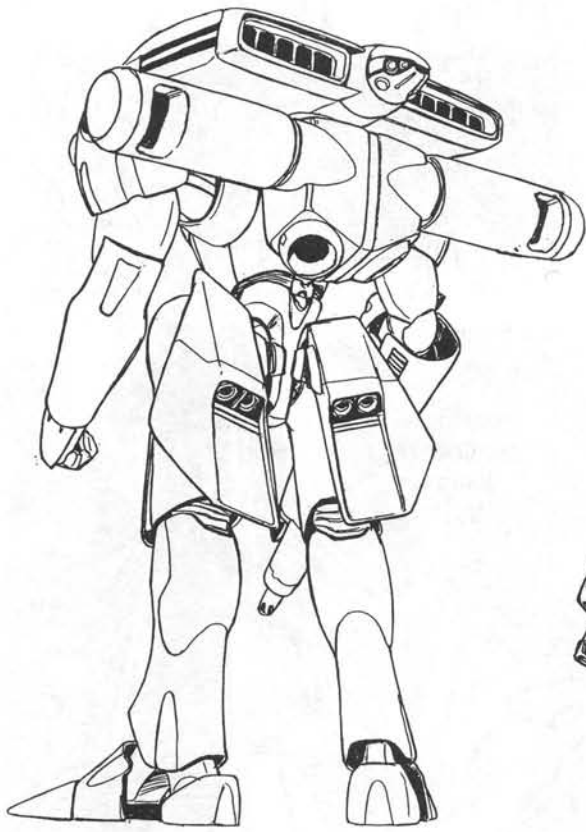

ADVANCED BATTLE BOOMER

WEIGHT	1118 kg	TYPE	Battle		
ARMOR	70 KD	RUNNING	15 (45 kph)		
STRUCTURE	100 SDP	FLY/SKIM	48 (144kph); 3/∞		
REF	7	INT	3	AI RATING Level 6	
DEX	7	PRE	6	SKILLS +6*	
STR	13	WILL	9	BODY 20	
MOVE	15	TECH	4	RECOVERY 26/t	
WEAPONS	WA	RNG	DMG	LOC	SPECIAL NOTES
HAND-TO-HAND	+0	-	13D6*	A, A	*Killing damage.
MACHINEGUN	+2	440m	12D6	RA	ROF=20, 20 bursts.
LASER x2	+0	840m	25D6*	RA	*each (X-Linked), BV = ∞.

SUBSYSTEMS

- Robotic brain.
- Flightjets in rear armor-skirts and backpack.
- Twin balancer pods (20SDP each) mounting vernier rockets (if one of these is destroyed, the Boomer can no longer fly/skim effectively).
- Armored optics with targeting, lowlight and IR functions, including a rear-view backup sensor (can't sneak up behind this one!).
- Machinegun's targeting sensors can be used to look around corners.
- Rank-4 ECM & ECCM suite; scrambled radio with 500km range.
- Limited Fusion ability: Can absorb, control and animate 480kg of mechanical material.

*Relevant Skills include: *Perception, Hand-to-Hand, Athletics, Heavy Weapons, Melee & Demolitions.*

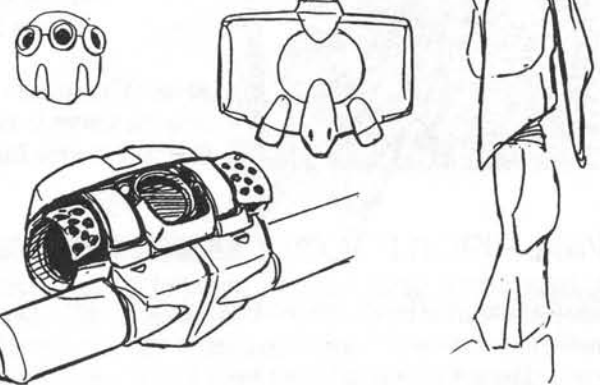

▼ ADVANCED BATTLE BOOMER

This is an improved version of the milspec Bu-12B battle Boomer, new for 2034. Following the planned upgrade program for the 12-B, twin Laser Beam Guns are built into the head for precision attacks (like those of the 12-T, their cooling gas is vented out of the back of the head), and a modular arm mount grants access to a selection of interchangeable weaponry—the model seen in *Meltdown* had an antipersonnel machinegun attached to the right arm, but a variety of firepower is available, including a large-bore railgun, a self-loading missile launcher, or a beam cannon.

Other improvements include secondary sensors on the back of the head (rendering sneak attacks almost impossible) and additional vernier rockets for enhanced mobility. Like all military cyberdroids, its neural systems are encrypted with military-grade algorithms, but even such supposedly airtight coding proved useless against Largo's AI virus.



LARGO'S
CUSTOM
VIRAL
FUSION
BOOMER

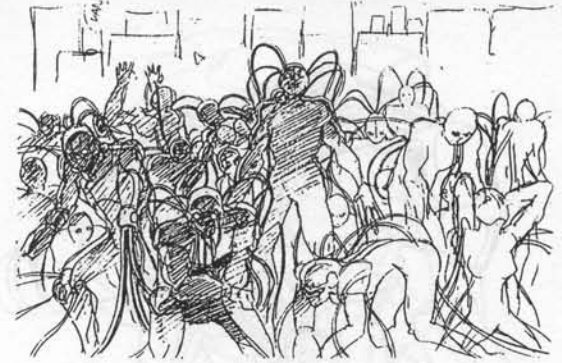
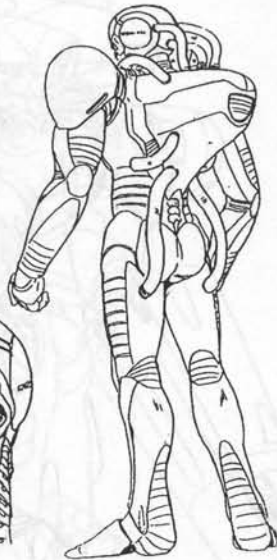

VIRAL FUSION
IN ACTION



MERGED WITH
THE CENTRAL
DATABANK
BUILDING



FUSION BOOMER AT
CENTER OF MASS-
BOOMER BODY

40-METER FACE FORMED
FROM THE SUMMIT OF THE
CENTRAL DATABANK BLDG

▼ VIRAL FUSION BOOMER

Using his substantial Genom resources, Largo had this Fusion-capable boomer custom-built to his specifications (as evinced by the large pipes protruding from its head and back). In particular, its body housed the four coveted processor chips which formed the unique AI Largo needed to infect the MegaTokyo Net and subjugate the city's boomers. Once enough of the boomer population had been infected with his AI virus, they were summoned to the Central Databank Building. There, Largo's "cyber-prophet" induced them to continuously fuse with each other until they formed one seething cyberdroid: a mass-body as well as a mass-mind.

Once the boomer mass had achieved sufficient size, it fused with the entire Central Databank Building, taking over the computer systems there and expanding the power of the AI. As the boomer mass formed a hideous 40-meter tall face on the side of the building, the cross-formed AI was able to act at its full power level, increasing from four AI Level-7 chips to a single AI Level-24 data-hungry entity. This super-AI had a total Hacking ability of the Fusion Boomer's INT 9 plus Hacking skill 7 plus 9 for the AI ($24 \div 3 = 9.333$, rounded down), or 25 + a die roll! The AI also acts as a Rank-10 ECCM suite, frustrating Hypersensors and missiles.

VIRAL FUSION BOOMER

WEIGHT	550 kg	TYPE	Fusion-capable		
ARMOR	45 KD	RUNNING	24 (72 kph)		
STRUCTURE	70 SDP	FLY/SKIM	-0-		
REF	6	INT	9	AI RATING	Level 7
DEX	7	PRE	10	SKILLS	+7*
STR	11	WILL	6	BODY	14
MOVE	24	TECH	5	RECOVERY	22/t

WEAPONS	WA	RNG	DMG	LOC	SPECIAL NOTES
HAND-TO-HAND	+0	-	11D6*	Arms	*Killing damage.

SUBSYSTEMS:

- Imprinted AI Brain.
- Scrambled radio with telepresence link (~100km) to Largo.
- Shieldable optics with night vision & thermograph functions.

Unlimited Fusion ability: Can fuse with and animate any mechanical material, adding countless tons to its own body; it can fuse with several units and/or objects at the same time as long as they are of roughly equal size (such as boomers, buildings, etc). It can control any machine which is considered part of the structure with which it fuses. Note that at the core of the fused material will reside the Fusion Boomer's original AI, with unchanged SDP. Absorbs 1 ton first Phase, +2 tons next Phase (total 3t), 4 tons (7t), 8 tons (15t), 16 tons (31t), etc.

- Relevant Skills include: *Perception, Leadership, Hacking, Hand-to-Hand, Athletics, Firearms, Melee, Heavy Weapons.*

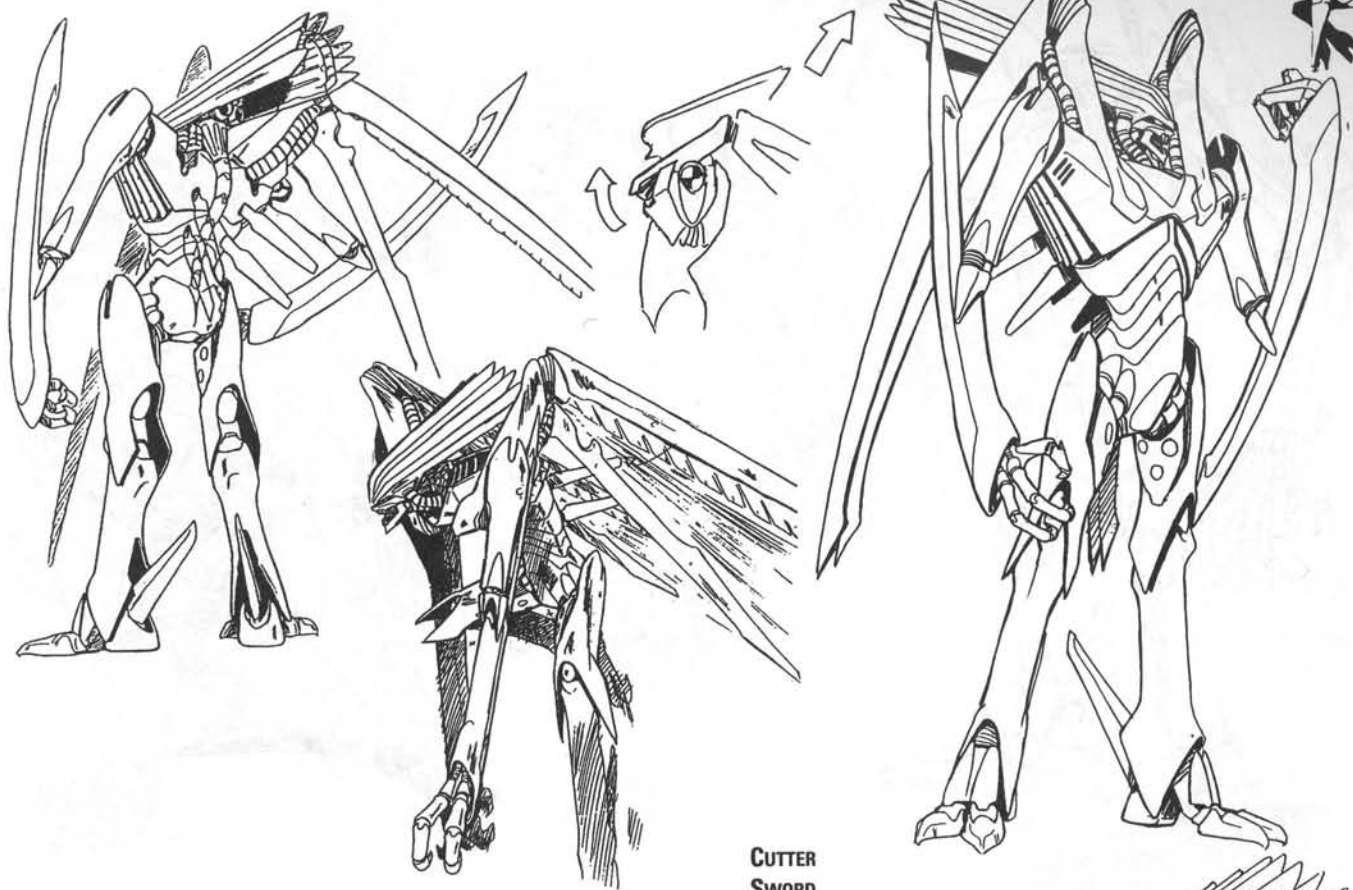

CUTTER SWORD FIRING PATTERN

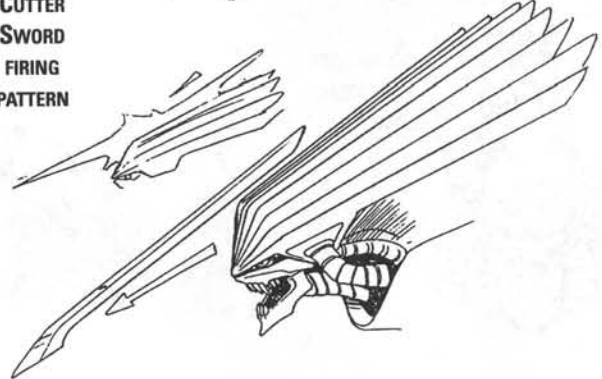

LARGOBOOMER (CUTTER TYPE)

WEIGHT	700 kg	TYPE	Experimental		
ARMOR	90 KD	RUNNING	30 (90 kph)		
STRUCTURE	90 SDP	FLY/SKIM	111 (333kph) ∞/∞		
REF	8	INT	8	AI RATING	Level 8
DEX	9	PRE	8	SKILLS	+8*
STR	13	WILL	9	BODY	18
MOVE	30	TECH	6	RECOVERY	26/t

WEAPONS	WA	RNG	DMG	LOC	SPECIAL NOTES
HAND-TO-HAND	+0	-	13D6*	Arms	*Killing damage.
CUTTER SWORDS	+0	525m	17D6*	Head	*AP, 10 shots
LASER CUTTER	+1	-	30D6*	R Arm	*EMW; -20KD.
LASER CUTTER	+1	-	30D6*	L Arm	*EMW; -20KD.

SUBSYSTEMS

- Imprinted AI brain with advanced AI (acts as a Rank-10 ECCM suite, frustrating HyperSensors and missiles).
 - High-output thruster nozzles in wings.
 - Shieldable optics with targeting, night vision & thermographics.
 - Scrambled radio with telepresence link (~100km) to Largo.
 - Hyper-Fusion ability: See the description in Largo's write-up, p.62.
 - Disguise function: Looks exactly like Largo, but must rip out of disguise in order to deploy weapons and equipment.
- *Relevant Skills include: Perception, Hand-to-Hand, Athletics, Firearms, Melee, Heavy Weapons.

▼ CUTTER-TYPE LARGOBOOMER

In the final showdown, Largo again fielded three powerful Boomers designed to destroy the Knight Sabers. This time, however, the vigilantes faced three cyberdroids with combat capabilities comparable to the original Largo himself! In their humanoid form, these cyberdroids were virtual clones of Largo—but when they shed their disguises, these monstrous "LargoBoomers" proved to be the most fearsome opponents the Knight Sabers had ever faced. Being based on the stolen second-generation AI system, these boomers had a host of incredible abilities: They were capable of neutralizing Nene's HyperSensors and Pulse-Strikers, and they all possessed Hyper-Fusion ability. Because all three were controlled by Largo's multiplexed consciousness via telepresence, their Hyper-Fusion allowed him to attack his victims' minds...

The cutter-type LargoBoomer fought Priss. While it's not particularly large, the high-output thrusters on its back gave it incredible mobility and athletic prowess. Its main armament consists of a large laser-cutter built into the back of each forearm, backed up by a mane of cutter swords which are fired from the head section.

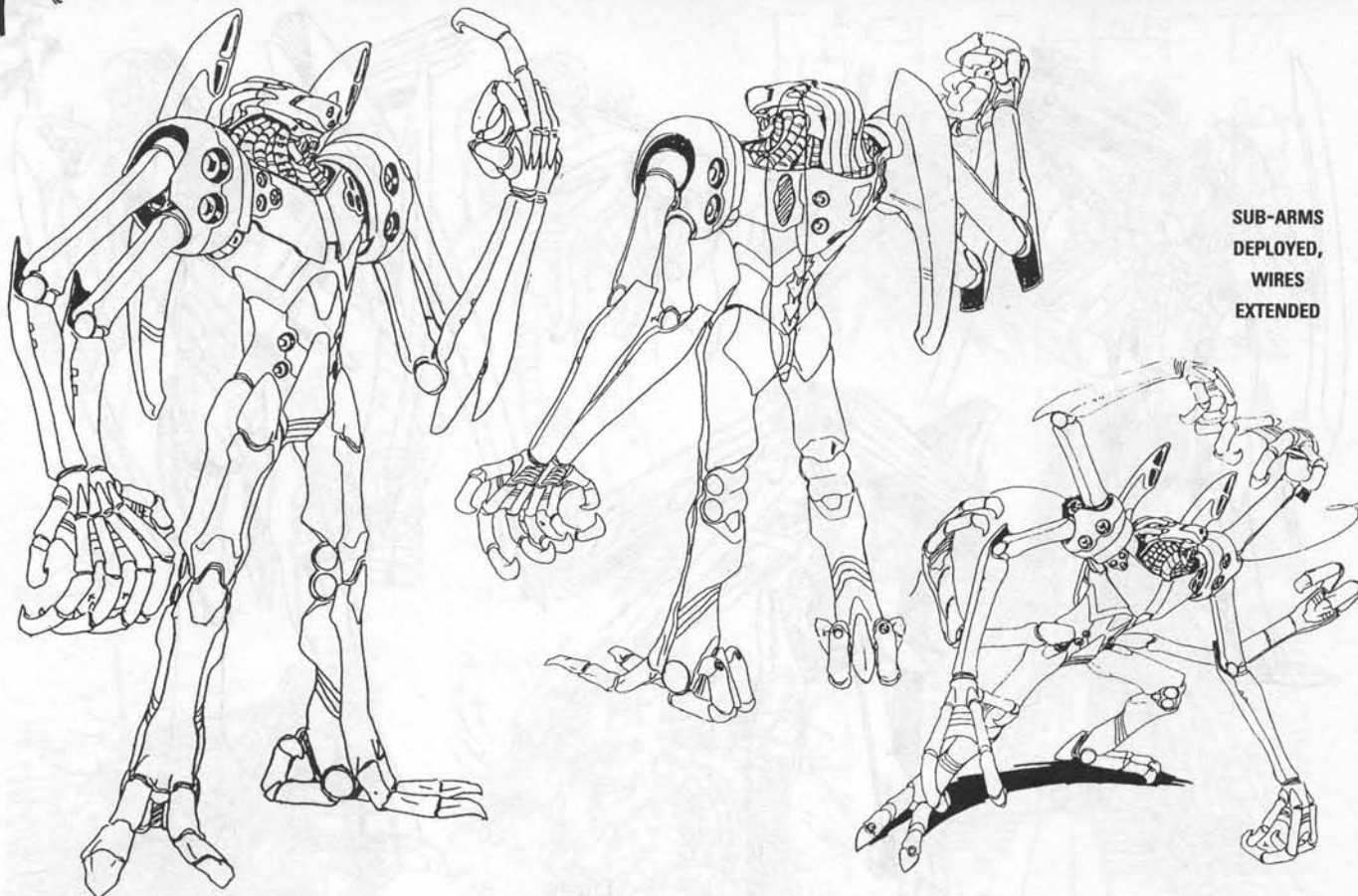

SUB-ARMS
DEPLOYED,
WIRES
EXTENDED

BODY LASER
GUN FIRING
PATTERN

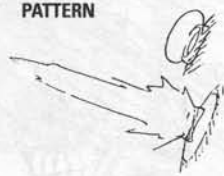

▼ SPIDER-TYPE LARGOBOOMER

This is the second of the three Largo-style combat boomers, designed to emulate the deadly abilities of a spider. Like the other LargoBoomers, its neural system is based on the stolen second-generation AI system, so it has the same powers as the other two LargoBoomers: It is capable of countering the effects of Nene's Pulse-Strikers and her HyperSensors, and it possesses Hyper-Fusion ability. Due to the fact that it, like the others, was controlled by Largo's multiplexed consciousness via telepresence, its Hyper-Fusion allowed him to attack his victims' minds...

The spider-type Largoboomer fought against Linna in the final showdown. It is deadly in hand-to-hand combat due to its ability to split each of its arms and legs apart, turning it into an eight-clawed nightmare that can attack from multiple angles at the same time! It can also extend prehensile wires from its shoulders to ensnare its foes or use as climbing grapples, and it is bristling with laser guns—the one in the mouth is especially powerful.

LARGOBOOMER (SPIDER TYPE)

WEIGHT	835 kg	TYPE	Experimental		
ARMOR	100 KD	RUNNING	28 (84 kph)		
STRUCTURE	100 SDP	JUMP	18m		
REF	8	INT	8	AI RATING	Level 8
DEX	9	PRE	8	SKILLS	+8*
STR	14	WILL	9	BODY	20
MOVE	28	TECH	6	RECOVERY	28/t

WEAPONS	WA	RNG	DMG	LOC	SPECIAL NOTES
HAND-TO-HAND	+1	-	14D6*	Arms	*Can attack 3 times/Phase.
SHOULDER-WIRES	-1	50m	STR14	Shldrs	*Grapple/entangle.
MOUTH LASER	+0	-	44D6*	Head	*Warm-up = 2.
LASER GUNS	-2	-	16D6		Twenty-two linked guns; see below.

14 guns on body, 3 guns on forehead, 8 on back of body; Works as an Autofire attack with ROF equal to number of guns fired (ROF 14-17 front, ROF 8 back).

SUBSYSTEMS
<ul style="list-style-type: none"> Imprinted AI brain with advanced AI (acts as a Rank-10 ECCM suite, frustrating HyperSensors and missiles). Shieldable optics with targeting, night vision & thermographics. Scrambled radio with telepresence link (~100km) to Largo. Hyper-Fusion ability: See the description in Largo's write-up, p.62. Disguise function: Looks exactly like Largo, but must rip out of disguise in order to deploy weapons and equipment. Relevant Skills include: <i>Perception, Hand-to-Hand, Athletics, Firearms, Melee, Heavy Weapons.</i>

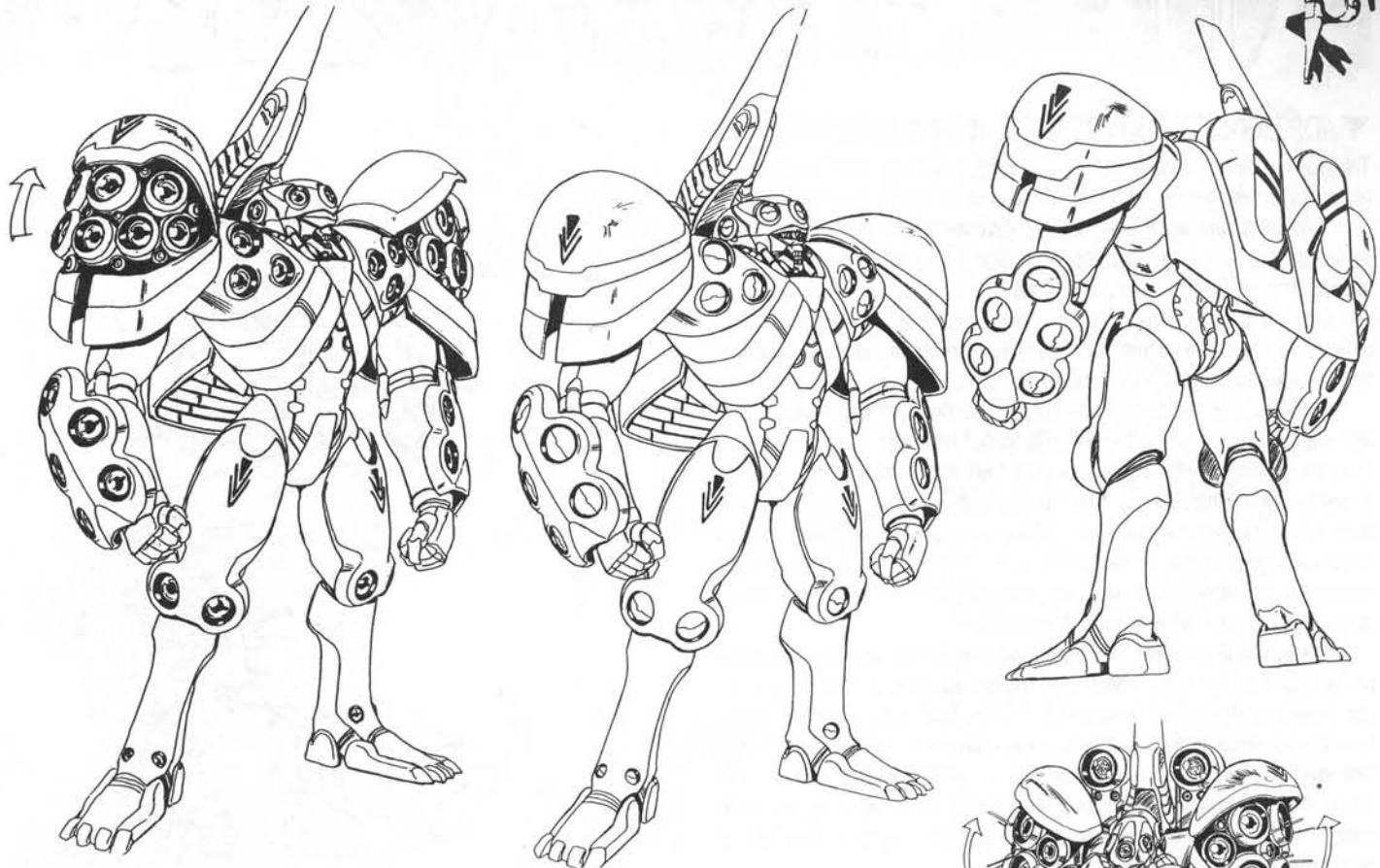

LARGOBOOMER (BLASTER TYPE)

WEIGHT	1330 kg	TYPE	Experimental		
ARMOR	110 KD	RUNNING	26 (78 kph)		
STRUCTURE	110 SDP	JUMP	5m		
REF	9	INT	8	AI RATING	Level 8
DEX	8	PRE	8	SKILLS	+8*
STR	15	WILL	9	BODY	22
MOVE	26	TECH	6	RECOVERY	30/t
WEAPONS	WA	RNG	DMG	LOC	SPECIAL NOTES
HAND-TO-HAND	+0	-	14D6*	Arms	*Killing damage.
SHIELDS	*	-	150KD	Arms	*Defense Ability -2.
LASER LENSES	+0	1km	14D6+	*	See notes below:

73 lenses (9 head, 6 chest, 5/arm, 4/leg, 18/shoulder, 2/pod) used like as 1 Autofire attack with ROF equal to # of lenses fired (max 73). Base attack does 14D6, +1D6 per point by which boomer's Attack Total beat target's Defense Total, with a max # of added dice equal to the ROF faced by the target. Laser attack can be split between as many targets as there are lenses (i.e., 73 targets), so an attack split between 6 targets will do 14D6 plus up to +12D6 per target.

MEGA-LASERS +0 1km 37D6* Pods *Warm-Up Time = 3. Can disrupt Barriers (like Nene's), halving KD. X-Linked to other lasers—if used, the **last** hit in the laser autofire attack includes a hit by the Mega-Laser array!

SUBSYSTEMS: 2nd-gen AI brain (Rank-10 ECCM). • Shieldable optics w/ targeting, night vision & thermograph. • Scrambled radio w/ telepresence link (~100km) to Largo. • Hyper-Fusion: See Largo's write-up, p.62. • Looks like Largo, but must burst out to deploy weapons and equipment. • Relevant Skills: Perception, Hand-to-Hand, Athletics, Firearms, Melee, Heavy Weapons.

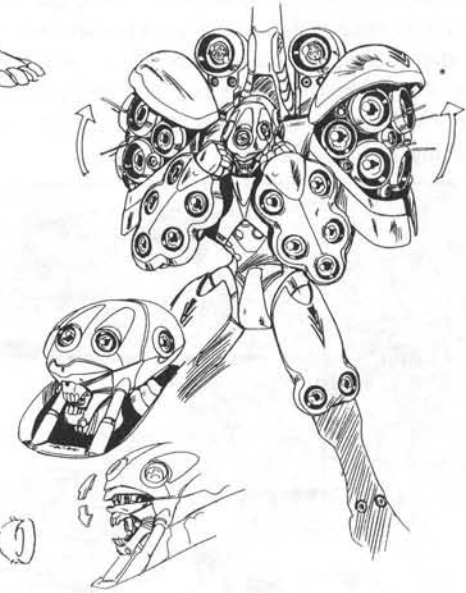

▼BLASTER-TYPE LARGOBOOMER

This is the heaviest of the three Largo-type death machines. Its brain, just like those of its brothers, uses the technology of the stolen second-generation AI, so it's also able to neutralize Nene's HyperSensors and Pulse-Strikers, and it also possesses Hyper-Fusion ability. Because it, like the others, was controlled by Largo's multiplexed consciousness via telepresence, its Hyper-Fusion allowed it to attack his victims' minds...

The blaster-type LargoBoomer fought Nene. Its plated with heavy armor, but its most notable feature is its immense assault capability. It's armed with a seemingly countless number of laser cannons which are distributed all over its body. As a consequence, there are hardly any dead angles or blind spots—even if the blaster-type were to be attacked from all sides at once, it could easily counterattack. The laser lenses can all be protected behind blast shutters—which proved to be its undoing when Nene forced it to close its shutters while firing all its lasers!

ADP MECHA 2034

▼ADP HEADQUARTERS 2034

The AD Police's HQ has changed little in the past year. Most of the changes are policy-based, brought about by the new chief. These changes include:

Virtual Shooting Range: Leon's favorite stress reliever has been replaced! The new range uses light-guns that fire IR beams; its clever scoring system evaluates the firer's marksmanship and gives pointers. The guns can simulate a wide range of weights, balances, ammunition types, rates of fire, and recoil effects, and the holographic targets can simulate anything from a target range to a human being to a 55C.

In theory, this means that officers can practice with more weapons at less expense—one can actually fire a rocket launcher or cannon, which few officers had the chance to do before. Still, many officers are skeptical. It may help your aim, but there's no flash or fury—without this, officers may flinch when they fire their real guns! Nevertheless, while Frontline Officers have been ignoring the VR range (it's no fun anymore), many young computer-nerd operators have been seen practicing with it—why blow money at the Game Center when it's free here in HQ?

Guardian Boomers: The HQ has been equipped with boomer security guards. A bureaucratic reaction to the HQ invasion of 2033, they were not especially welcomed by veteran officers, who were used to seeing boomers as foes rather than friends—and suspected that this might be the first step in a bid to replace human officers with boomers. They proved worse than useless in 2034, succumbing easily to the AI virus. The glee with which Leon and other police destroyed them attests to their lack of popularity. It's hoped they won't be replaced.

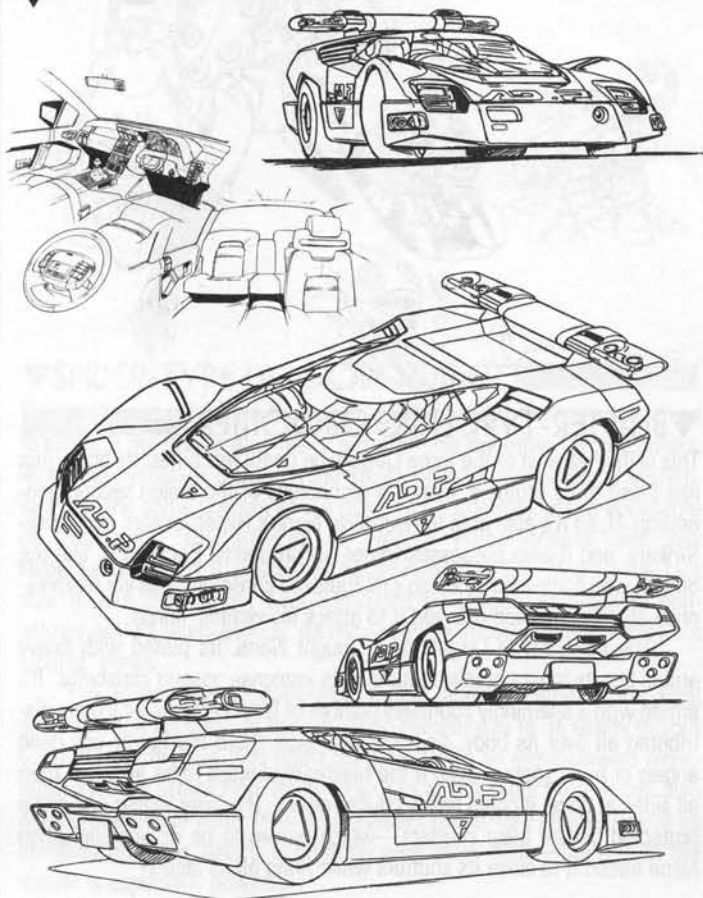
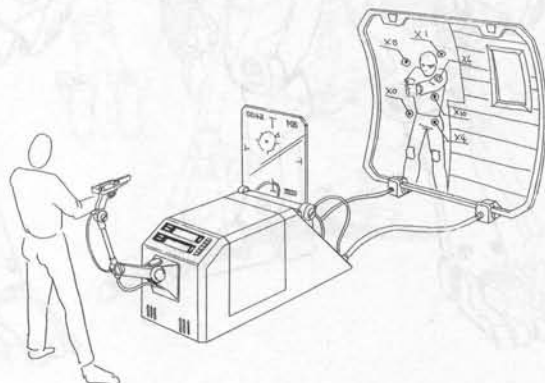
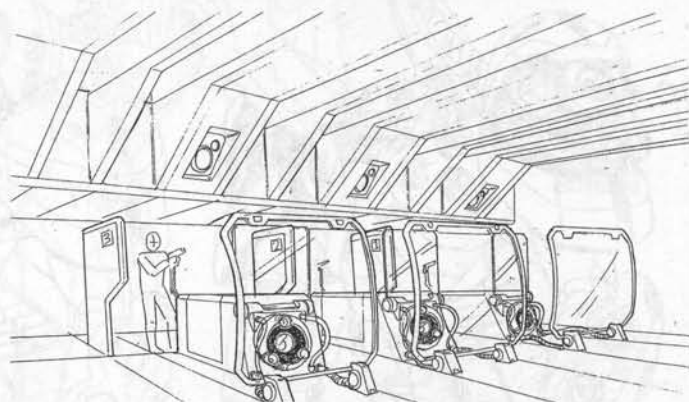

▼ADP PATROL INTERCEPTOR

While the AD Police haven't gotten much new equipment under the new chief, they have at least been able to replace most of their wide variety of different police cars with a standardized model used by all ranks. Despite its sleeker body styling, the new Patrol Interceptor is functionally identical to the Road Chaser variant of the ADP Interceptor (see *BGC* p.122), except that it doesn't need to deploy an added air scoop and spoiler to reach its top speed. The Patrol Interceptor also has a sliding sunroof—which is handy for shooting at airborne boomers.

ADP PATROL INTERCEPTOR 12 CP

WEIGHT	1,000 kg	SPACE	1 driver, 1 passenger
MANEUVER	-2 Ref	MOVE	100 (300kph)
1D10	LOCATION	ARMOR	STRUCTURE
1-7	Chassis	20 KD	50 SDP
8-10	Wheels (4)	-	10 SDP each

SUBSYSTEMS

- Headlights
- Loudspeaker
- Siren
- Emergency lights
- Rear-view monitor
- Police-band radio
- Datalink to ADP computers
- Sliding sunroof

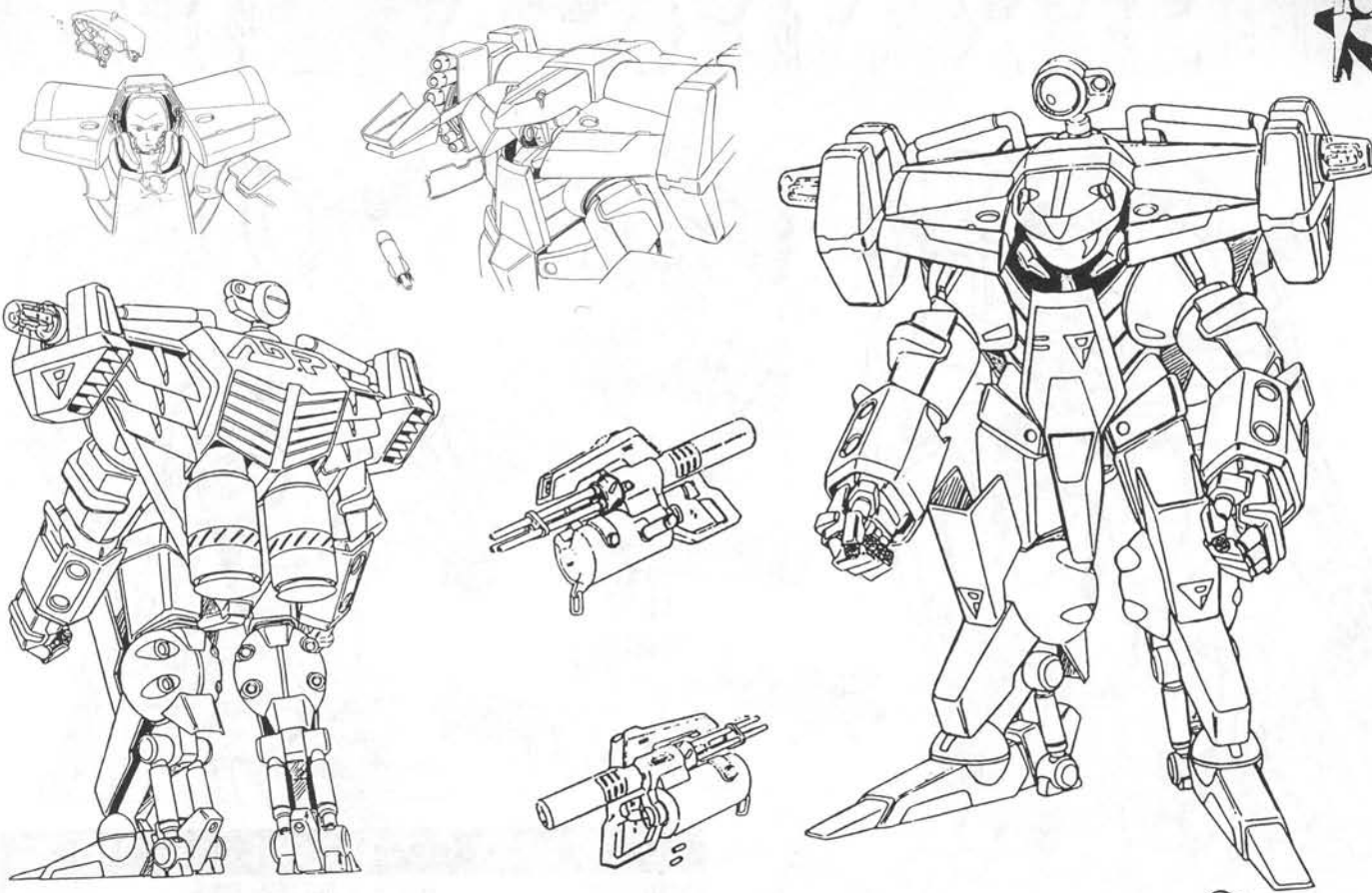

ADP K-17 POWERED SUIT					110 CP
WEIGHT	1316 kg		BATTERY TIME		6 hours
MANEUVER	-4 DEX & REF		RUNNING		Max MOVE = 6
STRENGTH	STR 13		HOVERING		36 (108kph)
SENSOR RANGE	3.5 km		COMM RANGE		100 km
ARMOR KD	50 KD		STRUCTURE		53 SDP
WEAPON	WA	RNG	DMG	LOC	SPECIAL NOTES
MISSILE BAY	+3	550m	14D6	Torso	6 shots, Link.
MISSILE BAY	+3	550m	14D6	Torso	6 shots, Link.
GATLING GUN	-1	425m	11D6	Hands	ROF 40, 25 bursts.
HAND-TO-HAND	+0	-	13D6	A, A	Killing only.
SUBSYSTEMS					
• Life Support (full sealing vs Nuclear, Biological & Chemical agents)					
• Sensor suite (optical, audio, radio, targeting, low-light vision, instrumentation, Heads-Up Display with +2 Perception).					
• ECCM System (Rank = 3) and radio scrambler.					
• Hoverflight array on back which allows the powered suit to "skim" along the surface (if a called shot at -3 is made and armor is penetrated, the hoverducts are destroyed).					
• Missiles are Linked (not Cross-Linked).					
• Spotlight (top-mounted) and shoulder-mounted rotating red lamps.					
• Emergency ejection function (blows operator out of back of suit).					
• Forearm hardpoints.					
• K-17's armor is <i>Fusion-Proof</i> .					

HANDHELD GATLING GUN

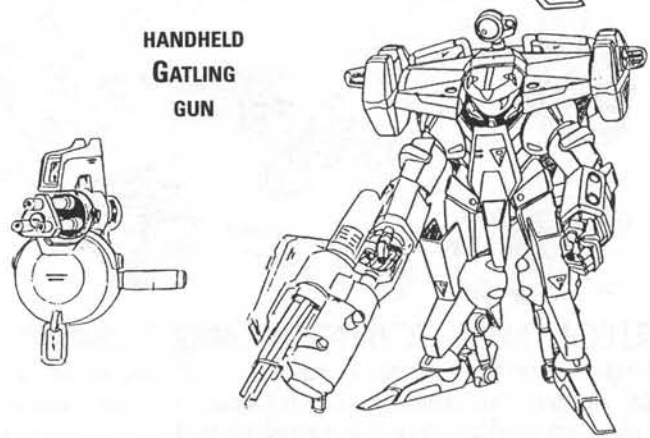

▼K-17 POWERED SUIT

This new powered suit was adopted for use by the AD Police as a compromise between the outdated K-11 and the budget-breaking K-12S. While it is slated to become the new standard ADP powered suit, there are still many K-11's and some K-12S's in service due to hesitation from the accounting department.

While there are still doubts concerning how it fares against military battle-type boomers, the K-17's mobility and firepower are definitely improved over previous models: The powered suit has twin missile bays located in each shoulder section, protected by swing-out armored covers. All together, 12 missiles can be fired (6 from each shoulder). In addition, it can carry a triple-barreled Gatling gun to quell unruly boomers—this is one of the more powerful firearms in the AD Police's arsenal, but it has proved ineffective against the armor of military battle boomers. Armor-piercing rounds would solve this, but the new chief simply won't allow that.

OTHER MECHA 2034

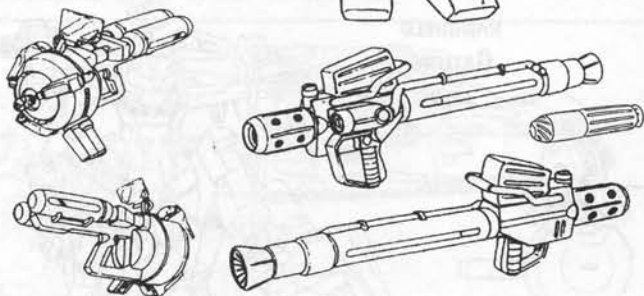
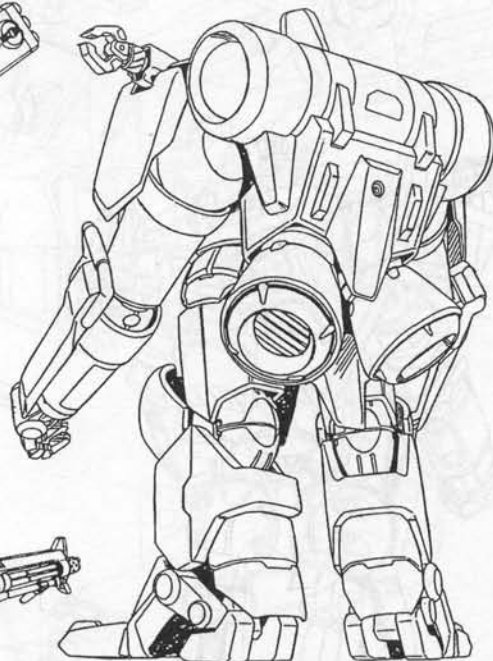
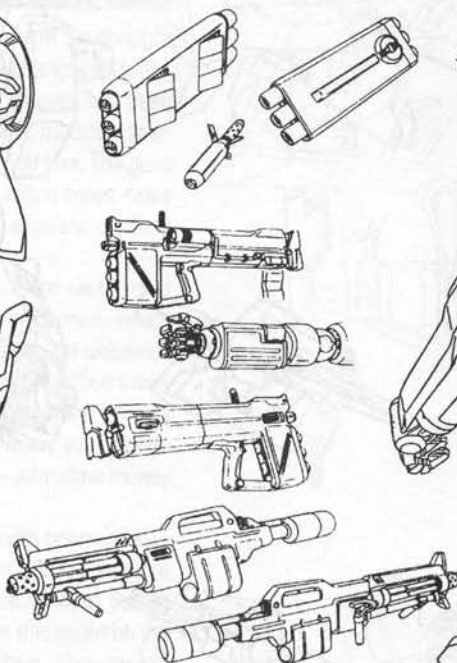
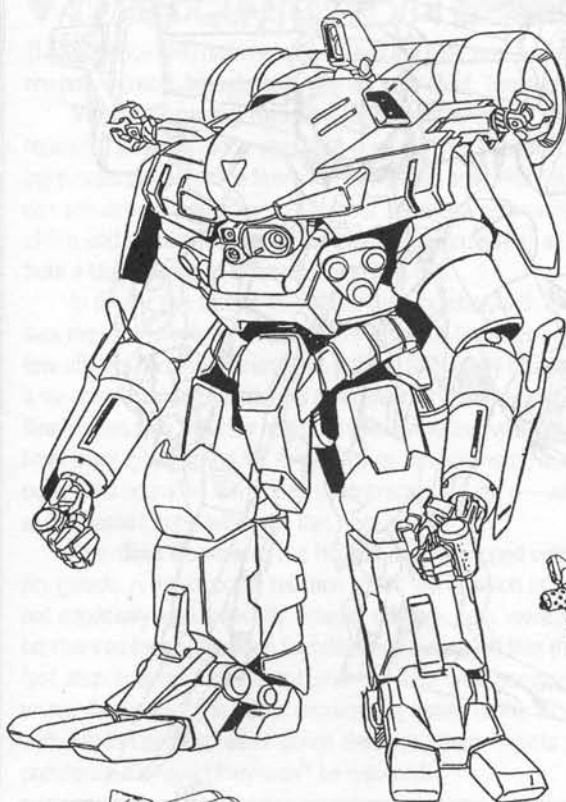

▼ILLEGAL ARMY COMBAT SUIT

Although defects halted the development of this EC-designed suit, the Illegal Army (through its connections to "a big Japanese concern") acquired the plans and developed their own fighting machine. It has composite armor, sports Cutter Swords in the forearms, can handle a variety of sidearms, and can mount rocket launchers on shoulder option latches. A simple computer in the forearm manages battlefield data and does code-breaking. Furthermore, the suit's "Lethal Weapon" mode deploys hidden weapons to hose the enemy with fire. This formation requires that the hands be totally discarded, turning the suit into a walking heavy weapon.

Statistics: Height 2.505m. Dry Weight 980 kg. Power Unit Honda Z. Max Power 78/900Q. Max Torque 55/750Q.

LANDO'S FUSION FORM: When Lando's suit was crippled in battle he used his boomeroid Fusion ability to merge with the remnants of his suit, turning himself into a mass of armor and machinery. This form adds +1 PRE, gives Lando 30KD armor, adds +5 to his SDP, grants a STR of 12, and can sprout a myriad of prehensile wire-razors (WA +1, 10m range, 12D6AP damage, 5m Area effect). However, the tentacles are vulnerable to electric charge: If an electric weapon is used against them (any whip-like weapon is +2 to hit them), Lando's body gets no defense against the electrical damage.

ILLEGAL ARMY COMBAT SUIT 210 CP

WEIGHT	1168 kg	BATTERY TIME	9 hours
MANEUVER	-2 DEX & REF	RUNNING	Max MOVE = 6
STRENGTH	STR 14	JUMP/HOVER	30m/33 (100kph)
SENSOR RANGE	2 km	COMM RANGE	40 km
ARMOR KD	60 KD	STRUCTURE	60 SDP

WEAPON*	WA	RNG	DMG	LOC	SPECIAL NOTES
HAND-TO-HAND	+0	-	14D6	Arms	Killing only.
CUTTER SWORD x2	+1	-	14D6*	Arms	*Armor-Piercing
GRENADE LNCHR x2	-2	500m	12D6	Chest	5m Area, 3 shots, Link.
ROCKET LNCHR x2	+0	700m	21D6	Shldrs	6 shots each, Linked.
AUTO BAZOOKA	-1	425m	11D6*	2-hand	*10m Area, 3 shots.
GATLING MG	+1	500m	17D6	2-hand	ROF 80, 8 bursts.
MACHINEGUN W/	+1	500m	15D6	2-hand	ROF 20, 15 bursts.
ROCKET LNCHR	-2	550m	14D6*	"	*5m Area, 3 shots.
LASER CUTTER	-2	-	7D6*	2-hand	*EMW, BV∞, 10 phases use.
MISSILE LNCHR x2	+1	1.35km	21D6	Back	4 shots, Linked.
LASER CANNON	-1	550m	17D6	R. Arm	3 shots, must drop hand.
VULCAN GUN	-1	425m	11D6	L. Arm	3 bursts, ROF 80, drop hand.

LETHAL WEAPON MODE: Vulcan & Laser replace hands, Missiles deploy; all weapons may be fired each phase at different targets; Maneuver improves to -1; STR becomes 16. Lasts for 2 phases.

SUBSYSTEMS: Life Support (sealed vs Nuclear, Biological & Chem) • Sensors (optical, audio, radio, targeting, low-light vision, instrumentation, HUD, +2 Perception). • ECCM System (Rank = 3), radio scrambler. • 1 Option Latch per shoulder • Engine nozzles on back to jump, or skim surface (called shot at -3, penetrating armor, destroys engines). • Desert environment adaptation. • Spotlight. • Emergency ejection function (blows operator out back of suit). • Forearm computer (POW = 3) with decryption programs loaded. *First 3 weapons are built-in, next 5 are options, last 3 are Lethal Weapon mode only.



**WEAPON
ASSORTMENTS
FOR THE
VARIOUS
ILLEGAL ARMY
MEMBERS**

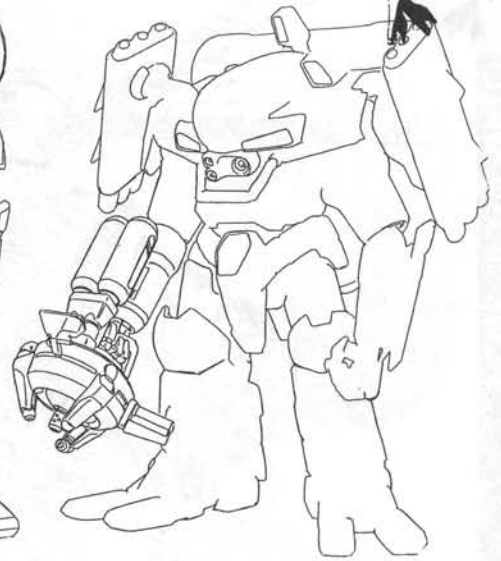
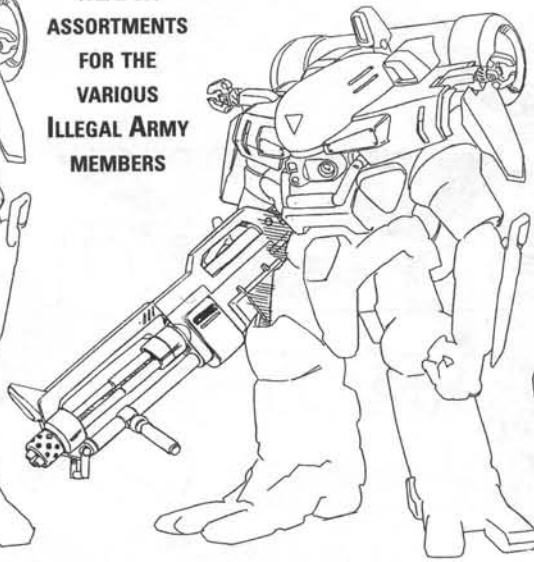
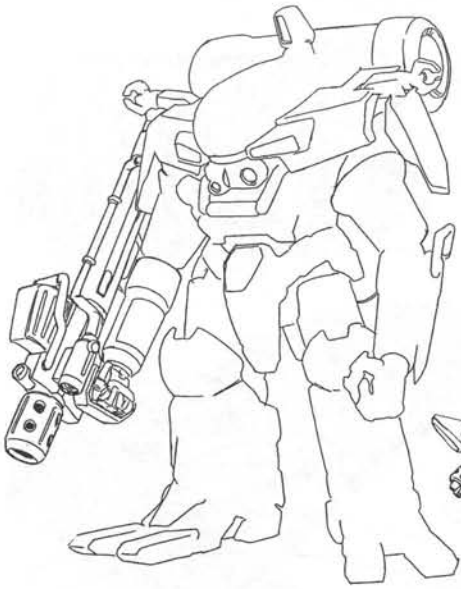

**CUTTER
SWORD
DETAIL**

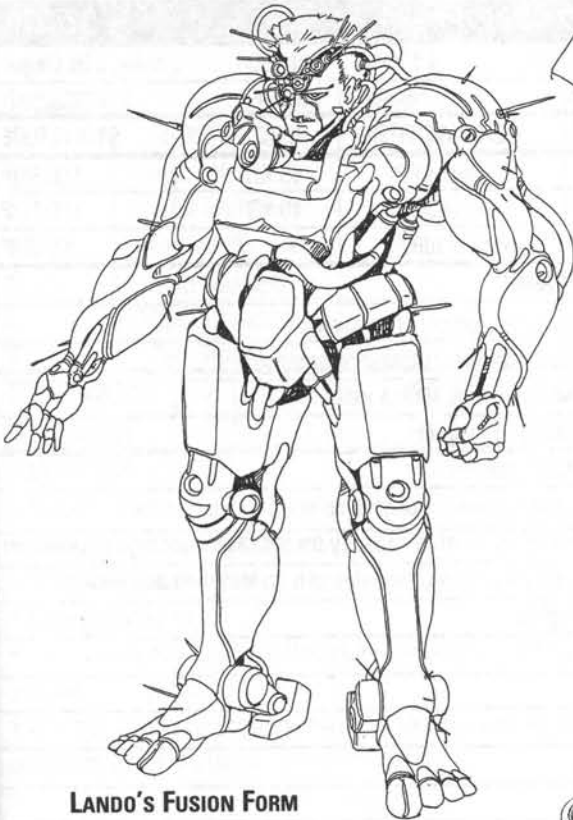
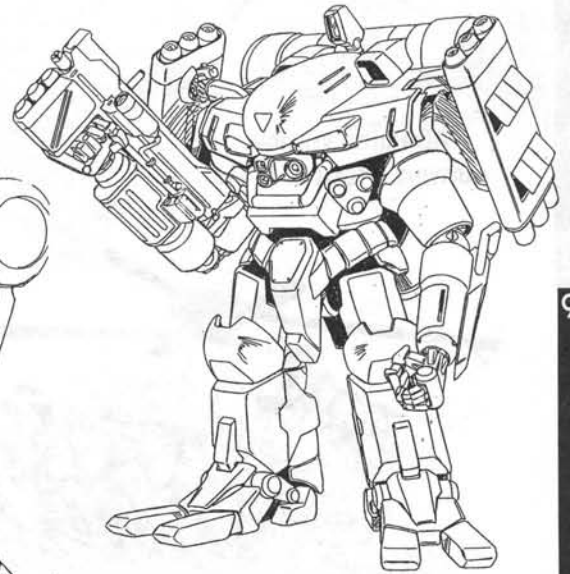
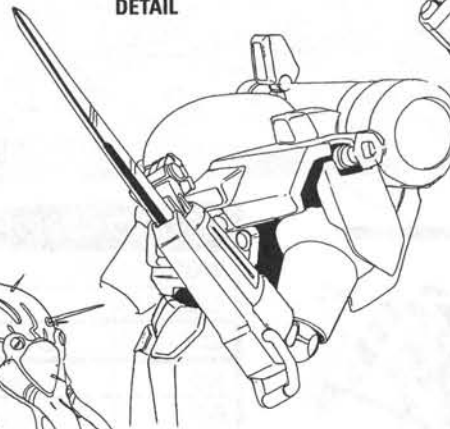

**LANDO'S FUSION FORM
(MERGED WITH THE WRECKAGE
OF HIS POWERED SUIT)**

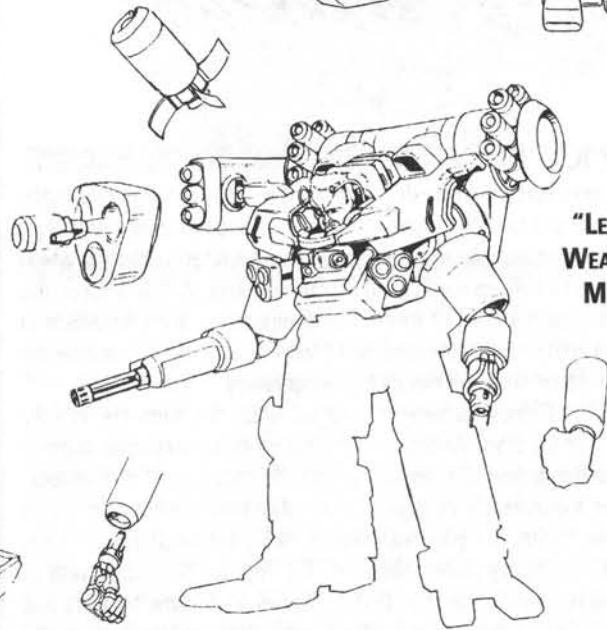

**"LETHAL
WEAPON"
MODE**

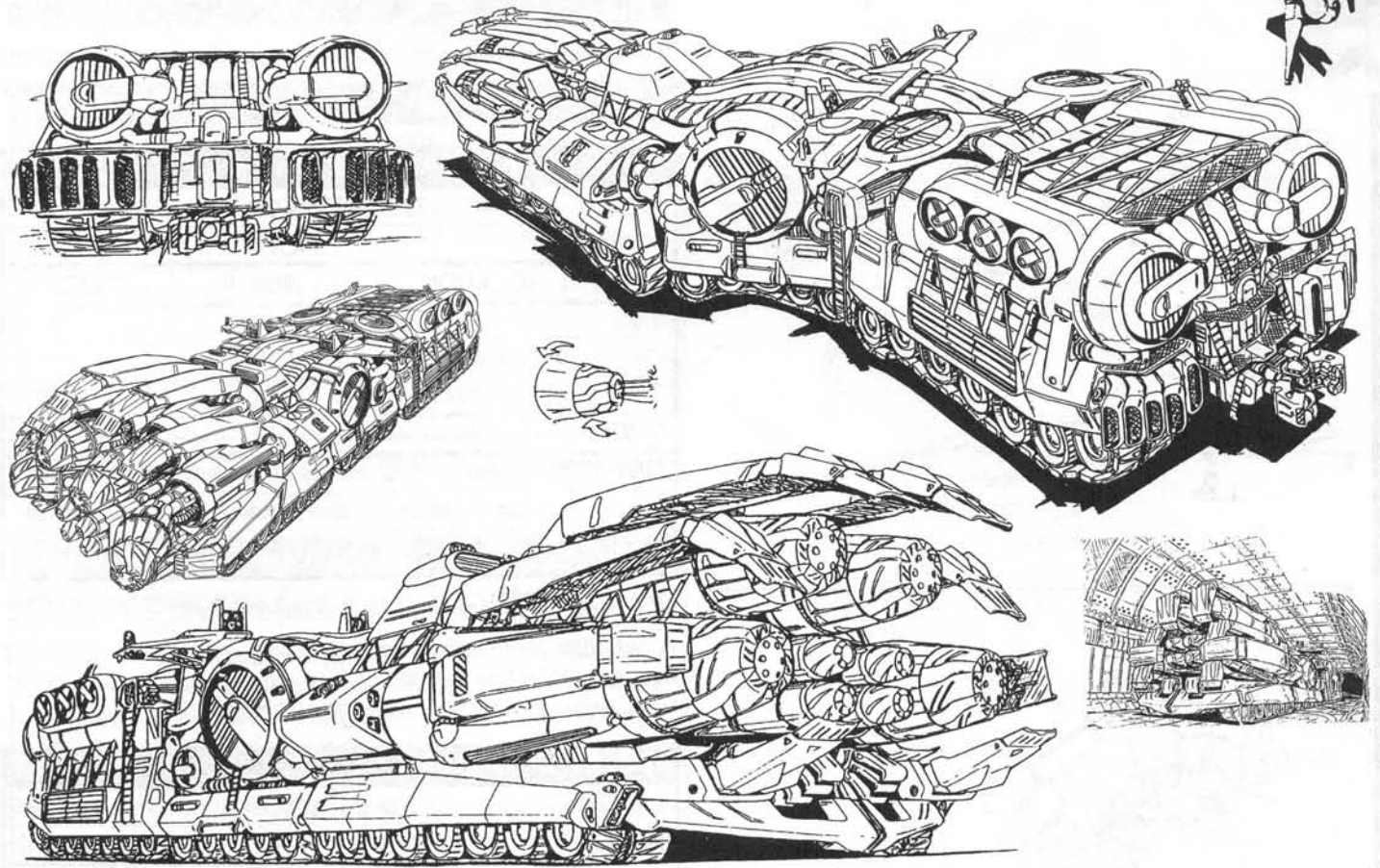

BRÜM-BAR **300 CP**

WEIGHT	300 tons	SPACE	Ship-sized crew
MANEUVER	-12 REF	MOVE	7 (20kph)
1D10	LOCATION	ARMOR	STRUCTURE
1-2	Front Hull (Drills)	10K	55K
3	Middle Hull (Joint)	10K	25K
4-6	Rear Hull (Engine)	10K	70K
7	Front Treads (2)	-	20K each
8	Middle Treads (2)	-	10K each
9	Rear Treads (2)	-	20K each

10 WEAPONS	WA	RNG	DMG	LOC	SPECIAL NOTES
LASER DRILLS	+3	5m	20K	FH	1/2KD, ROF = ∞.

- SUBSYSTEMS**
- Nuclear reactor engine.
 - Crew catwalks all over surface.
 - POW-6 computer system.
 - Emergency lights.
 - Crew space and facilities: Bridge, engine room, meeting room, storage, etc.
 - Can drill through any material with up to 38K of armor, moving at its maximum speed of 20kph.

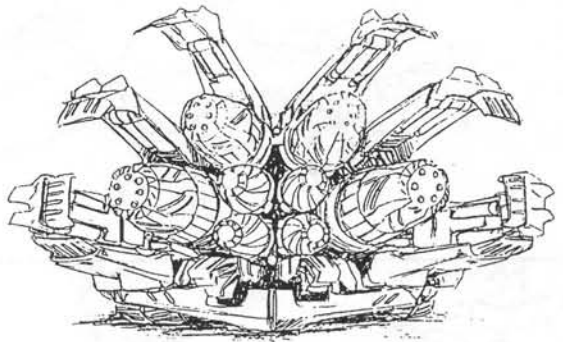

▼ **BRÜM-BAR**

This German-made monstrosity is an enormous (40 meters long and weighing 300 tons!) nuclear-powered underground drilling machine. It was designed for creating underground pathways such as are needed to bore out subway tunnels, but it became an indispensable part of Largo's plan to destroy MegaTokyo. Using his ability to manipulate Genom resources, Largo managed to get his hands on it and directed its laser drills and earth-raking claws at breaking through the defensive barriers of the "Hearth" atomic powerplant. The Brüm-Bar (or "Grumpy Bear") was indeed a top-notch underground machine; it tore its way past the Atarun subway station and through several of the Hearth's barriers, but it was eventually stopped by Sylia's destruction of Largo, whose life-support tank was fused with the Brüm-Bar.

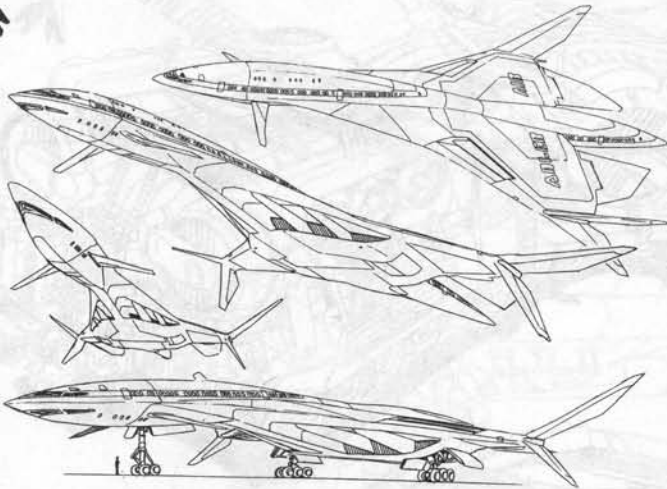

▼HST

This is a modern hyper-sonic transport used by Adler Air for international flights. It uses supersonic flight speed and suborbital flight paths to carry over 500 travelers quickly and comfortably.

HYPER-SONIC TRANSPORT 150 CP

WEIGHT		175 tons	SPACE		12 crew, 500+ passengers
MANEUVER		-9 Ref	MOVE		Mach 1.8
1D10	LOCATION	ARMOR	STRUCTURE		
1-2	Nose Area	1 K	45 K		
3-6	Fuselage	1 K	70 K		
7-8	Right Wing	1 K	30 K		
9-10	Left Wing	1 K	30 K		

SUBSYSTEMS: Trans-sonic supercruise turbine engines • First class and coach seating sections • Full staff of stewardess boomers (human cockpit crew) • Emergency lifeboats, floatation jackets, etc.

▼ADVERTISING BLIMP

In early 2034, these commercial airships were introduced by advertising companies. With their spotlights playing across the city streets and marketing jingles droning from their speakers, they're a common sight now.

ADVERTISING BLIMP 150 CP

WEIGHT		7000kg	SPACE		2 crew
MANEUVER		-10 Ref	MOVE		28 (85kph)
1D10	LOCATION	ARMOR	STRUCTURE		
1-5	Gas Bag	-0-	15 1K sections		
6-9	Underside Hull	1K	8K		
10	Maneuver Fans (6)	1K each	1K each		

SUBSYSTEMS:
Flashing warning lights.
POW-6 computer (for autopilot).
10 video flatscreens for running ads.

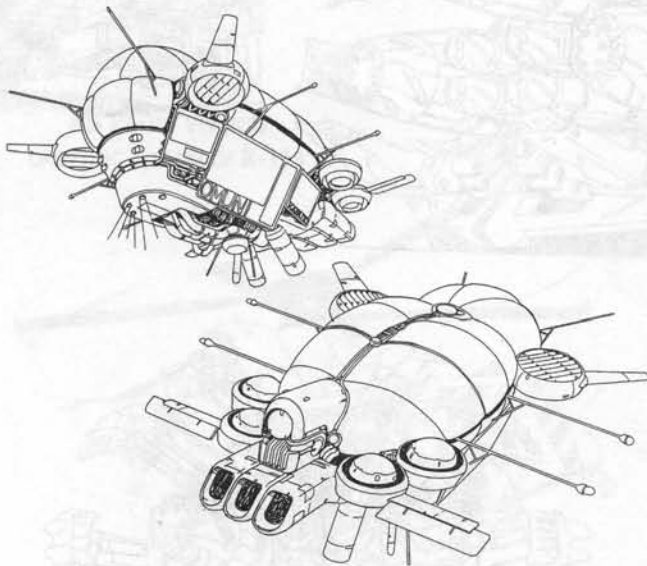

▼GARBAGE BOOMER TRUCK

This is a typical garbage truck—in 2034, such vehicles have no driver's cabin or windows, since they're operated by the two onboard Garbage-Boomers, who see through the front sensor.

GARBAGE BOOMER TRUCK 23 CP

WEIGHT		4100kg	SPACE		2 Garbage Boomers
MANEUVER		-6 Ref	MOVE		30 (90kph)
1D10	LOCATION	ARMOR	STRUCTURE		
1-3	Front Cab	10 KD	30 SDP		
4-9	Rear Dumpster	25 KD	60 SDP		
9-10	Wheels (4)	-	20 SDP each		

SUBSYSTEMS:
Twin storage closets for Garbage-Boomers.
Front traffic sensor.
Rear trash compactor door.

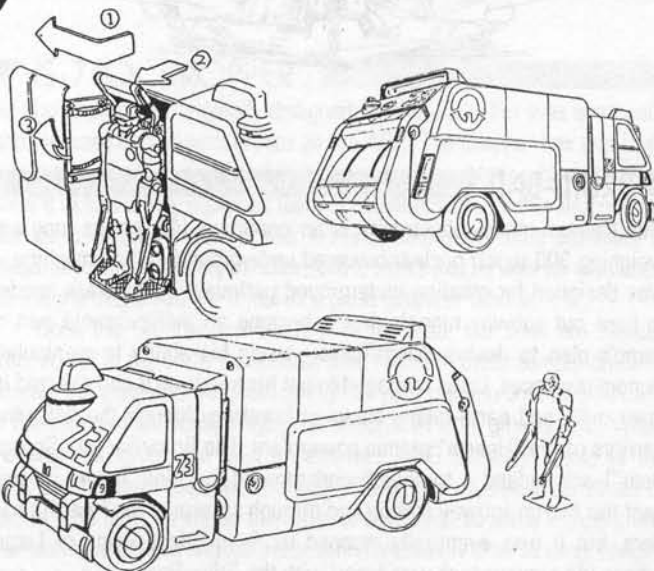



▼PRISS' HANDGUN

Used by Priss to dispatch Dr. Yuri's Terrorist Boomers

PRISS' HANDGUN 13 CP

WA	Range	DC	ROF	Shots	Cost
+0	60m	8D6AP	2	7	¥133,000

This semiautomatic handcannon is an updated version of the Member-II. Instead of being a cut-down rifle action, this pistol is a purpose-built autoloader. Its double-column magazine has a larger capacity and recoil is damped quite effectively by a four-ported muzzle and the countermass of the bolt's action. A thumb-operated safety locks the slide and ensures no misfires, and the muzzle has been modified to accept pistol-grenades (see *BGC* p.141). Armor-piercing bullets and High-Explosive Anti-Tank grenades are "standard" for Priss' use, but others are available.

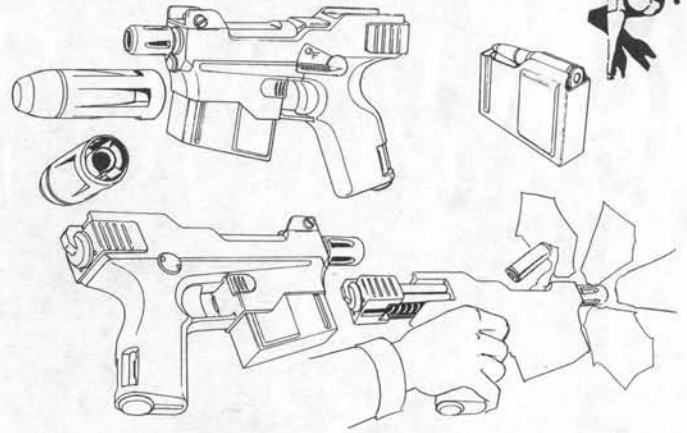

▼ASSAULT MODULE

These rifles were used by two of Dr. Yuri's Terrorist Boomers in *Geo Climbers*.

ASSAULT MODULE 10 CP

WA	Range	DC	ROF	Shots	Cost
+1	300m	7D6	30	90	¥100,000

This is an advanced individual combat rifle designed for full-fledged military troops. It is packed with a variety of modern features: The weapon fires caseless ammunition, allowing a high magazine capacity; a laser-sight is mounted ahead of the magazine well; an optical camera-scope is built into the carrying handle, with its display screen mounted on the back end of the handle. A high-capacitance battery loads into the front of the weapon, between the barrel and the lasersight, feeding power to the laser, the optical scope, and to the electrical firing system.

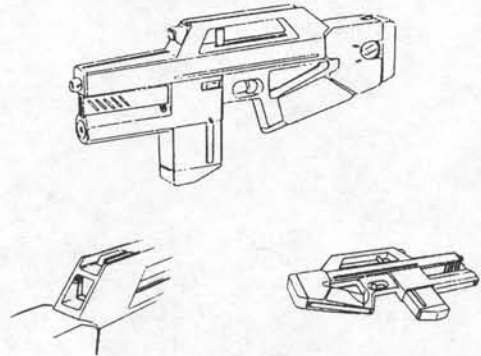

▼BATTLE RIFLE

These rifles were used by two of Dr. Yuri's Terrorist Boomers in *Geo Climbers*.

BATTLE RIFLE 9 CP

WA	Range	DC	ROF	Shots	Cost
+0	400m	8D6	25	75	¥90,000

Occupying a role similar to the old FN-FAL or H&K G-3, this weapon falls between an assault rifle and a machinegun. The straight-line design and bullpup configuration keep the rifle balanced and make recoil more manageable, and it can be quickly reconfigured for right- or left-handed use. The ammo clip is an unusual design, combining aspects of helical and drum magazines, affording a healthy capacity. To change magazines, the shoulderstock is pulled back by its built-in handle and the clip is dropped, to be replaced by a full one.

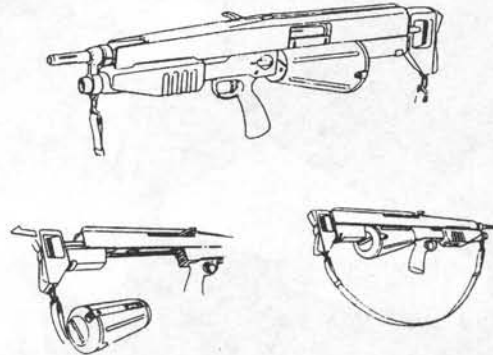

▼LASER CUTTER

A boomer fence threatened Adama with this device in *Geo Climbers*.

LASER CUTTER 12 CP

WA	Range	DC	ROF	Shots	Cost
-2	1m	9D6-EMW	∞	∞	¥120,000

This is a powerful "energy chainsaw" used for dismantling durable objects such as scrap cars, building materials... or the occasional stolen boomer. It is very powerful, capable of slicing through a block of concrete in seconds, but a laser cutter is a serious power-hog: It must be hooked up to an external generator to run, but as long as it is, it has unlimited power! The cutter's damage treats armor as 20KD less, and applies damage once for each point rolled over the Target Number.

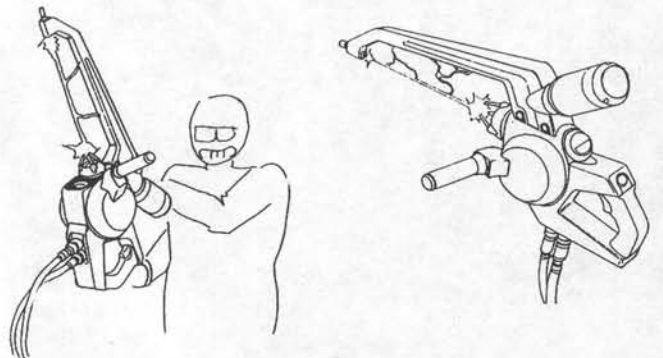

GAMING MATERIAL

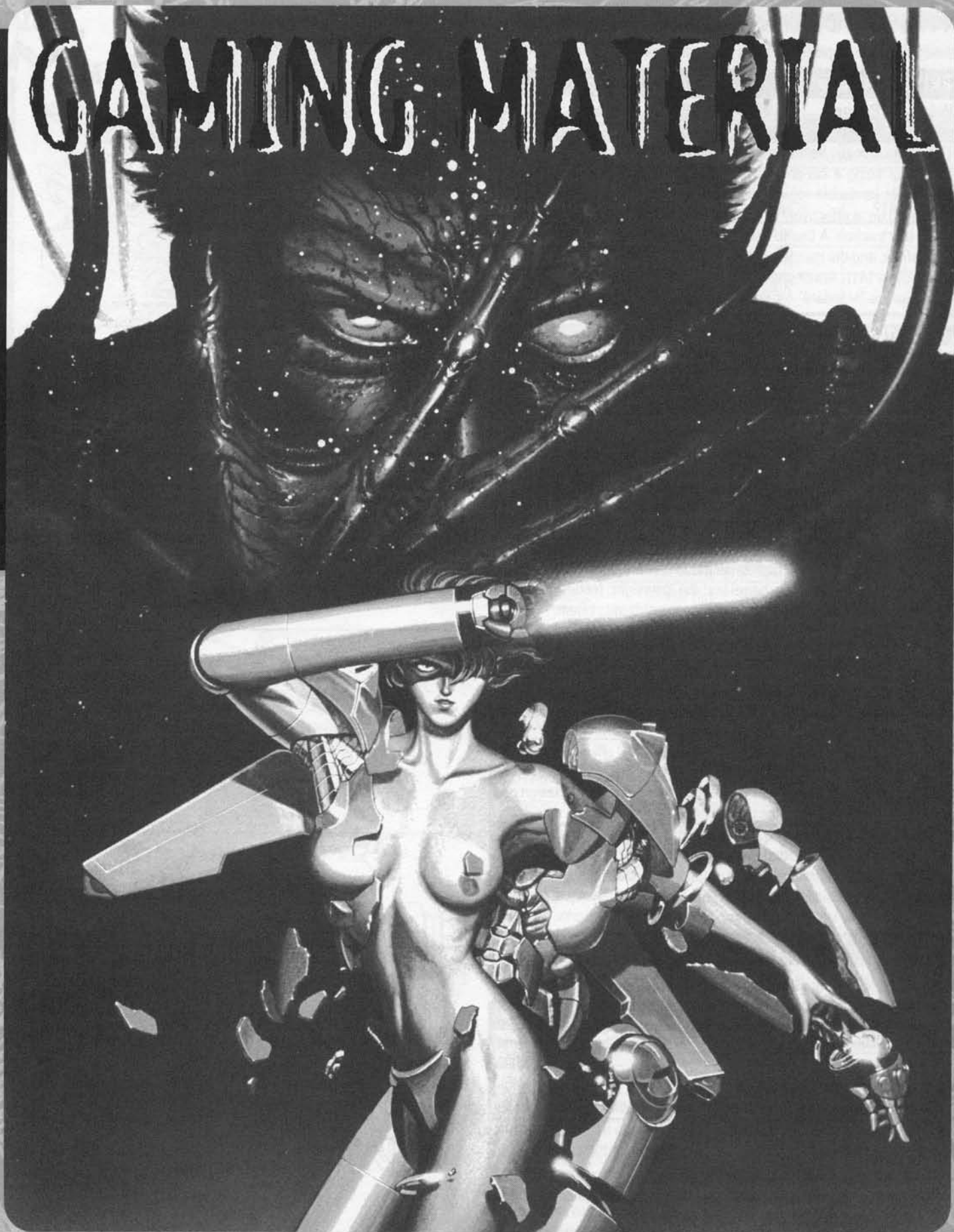

REFEREE NOTES

The *Bubblegum Crisis* universe varies from the realistic street-level cyberpunk action of *AD Police* to the superheroic conflicts of *Bubblegum Crisis* and the wild over-the-top escapades of *Bubblegum Crash!* In the videos, this is tied to the timeline, with the “power level” increasing dramatically from 2027 to 2032 to 2033 to 2034.

While the individual *characters* aren’t much more powerful in each story, the hardware available to the heroes and the might of the villains escalates dramatically in the later videos. Just as importantly, the stakes get higher! In *AD Police* they deal with problems that affect individual lives, like street crime or boomer syndrome; in *Bubblegum Crisis*, exotic super weapons are stolen and city blocks destroyed by satellite weapons or by rampaging superboomers. In *Bubblegum Crash!*, a failed mission can destroy MegaTokyo.

Referees may wish to adjust starting campaign point totals based on the power level. Using the guidelines on *BGC*, p.28, *AD Police* qualifies as “Heroic (action TV)”, the *AD Police* manga (2028) as “Legendary (action movie style)” (at one point, Jeena reprises the movie *Die Hard*). *Bubblegum Crisis* and *Bubblegum Crash!* are respectively “Superheroic” and “Cosmic” levels.

Which power level to play at is a matter of taste, best agreed upon by the Referee and players, or slowly escalated over a long-term campaign. While the maximum power available depends on the timeline, just because it’s 2032-4, it doesn’t mean you can’t run a street-level *AD Police* campaign—the Knight Sabers can’t handle everything! However, bear in mind that it’s a lot easier to soup up an existing campaign, but difficult to “tone down” the power level—there’s that extra hardware to explain away and, perhaps more importantly, after you’ve saved the world, taking down a single rogue boomer is a bit anticlimactic. On the other hand, soap opera is always fun regardless of the power level: You may be able to save the world, but what good is that if your lover left you because you couldn’t remember your anniversary? Of course, it’s always possible to start a second campaign using the *BGC* setting with a different group or an earlier period. In fact, since the *AD Police* videos were made after *Bubblegum Crisis*, that’s exactly what the animators ended up doing!

▼ VILLAINS

Over the three series, the major “enemy” changes: In 2027, it’s people or boomers twisted by boomer syndrome. In 2032-33, it’s Genom. In 2034, it’s Largo—Genom isn’t even mentioned! If you think of each “video” as equivalent to an adventure session, this amounts to a significant shift in adversaries every three to eight adventures—don’t get stuck using Largo forever! But a good enemy needs motivation. What makes a villain tick?

Revenge: The basic theme of *BGC*. A vengeance-obsessed villain mainly differs from our heroes in being less careful about innocents caught in the crossfire. He or she can still be a sympathetic character, such as J.B. Gibson or Vision. Any villain who has been thwarted in his other motivations may also end up wanting revenge against the heroes! Someone who is being eaten up by jealousy or hatred may even want revenge without a good cause (as was the case with Dr. Yuri).



Power: The villain is motivated by a desire for power over others. He may be trying to improve his existing power base, or protect what he’s got. His goals depend on his power level: A henchman may just want to zealously follow orders in the hope of promotion, or be plotting against his boss, while the scheme of a corporate president can rock the world. This is Mason/Largo’s main motivation, though sometimes he seems to slip into . . .

Madness: The villain is an insane psychopath—the “Ripper” serial killer is a good example. Discovering the roots of insanity may be a clue to defeating him. Brainwashing or fanatical devotion can motivate henchmen, as was the case with Colonel Lando.

Greed: This is usually the province of lesser henchvillains, although corporate executives are often motivated by greed as well as their quest for power.

A Cause: Someone willing to fight and kill for a cause who happens to oppose the players. It may be anything from freedom to saving the environment to building an invention. Some lieutenants follow a villainous leader out of duty or love, rather than having any dark motives of their own. As with revenge, a “just cause” can make the villain a sympathetic character and even a possible ally. Examples include Sylvie and Anri.

▼ TOUCHDOWN TO TOMORROW: INTEGRATING 2034 |

After looking at the cool technology and megavillains in this book, players and referees might be tempted to leap straight forward to 2034, either starting a campaign there or moving the timeline forward. Souped-up technology and world-shaking adversaries can definitely make the game more exciting. However, high-powered campaigns do work best with a bit of experience under the belt—a new player can easily slip up, and then the Referee has to figure out why the city *wasn’t* destroyed.

One way to integrate *Crash!* smoothly with a *Crisis* campaign is to work with the episodic structure of *BGC*. Have a month or two pass between adventures, so a campaign begun in 2032 or 2033 will reach 2034 after seven to eight adventures, like the videos. Knowing what’s coming, the Referee can foreshadow social changes and create adventures where players gradually encounter more powerful foes or allies and then upgrade their gear and headquarters in response, rather than just because it’s “in the book.” The “Hi-Tech Vigilantes” section on p.106 discusses upgrading to 2034 tech. It’s fun to give newly upgrad-

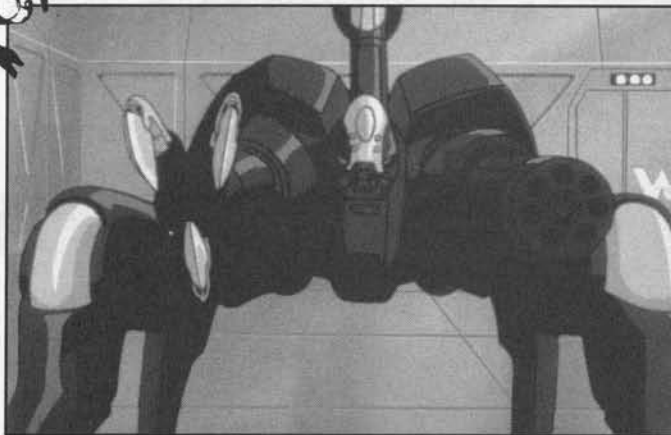

ed heroes an initial scene where they can blow apart “obsolete” foes like BU-55C’s. Then throw the 2034-era boomers against them!

Incidentally, the world of 2034 should not be seen as an “all or nothing” option. Feel free to pick and choose some parts and not others—this includes the social developments as well as the equipment lists. Maybe in *your* 2034 MegaTokyo, you like the new world of cheap boomers and a weakened Genom, but you’d prefer the AD Police to be in good shape. Fine—just assume that Chief Todo decided not to retire. Maybe he was on sick leave when the Illegal Army struck, and now he’s back.

- **AD2027 Cybernetics in the 2030’s:** The 2020’s had some cool technology as well. Again, it’s up to the Referee whether players should have 2027-era cybernetics in the 2030’s. The technology is still there, in places like the Outer District, and the rules for boomer syndrome do discourage excessive use of cybernetics, nor are the cybernetic gadgets available that powerful compared to hardsuits and boomers. Also, remind players that they’ll be fighting boomers—and while a fusion-capable boomer can’t fuse with a human, it can take over *this* cybernetics! So cybernetics do not really affect game balance *per se*.

On the other hand, a vital element of *BGC* is that vigilantes are very human. In most *BGC* videos, a Knight Saber is caught *sans* hardsuit and forced to use her wits to survive. If the heroes had hidden implants (especially weapons, extra strength, or a radio) it would be less challenging; if the heroes had obvious cybernetics, the chances of going undercover, or of being mistaken for a normal person (which generates most of the subplots) diminish.

- **Cybernetics and Cyberdroids:** Cybernetic implants may be added to androids, especially the more biological types. The effects are just like adding them to humans, including Humanity. By adding a cybersnake implant some of the sicker “mad boomers” that are found in the *AD Police* manga are possible.

▼ CREATING BOOMER CHARACTERS

Boomers (or Billy-style boomeroids) can be fascinating PC’s. While players not familiar with the *BGC* setting should probably start out with human characters, a boomer is a good choice for an experienced roleplayer who wants a new challenge (or whose PC died a heroic death). Here are some suggestions on how to integrate them into a campaign while minimizing problems of game balance.

CHOOSING A BOOMER: This depends on the “power level” of the campaign. The Referee should only allow boomers that look like or can be disguised as humans to be taken, regardless of power level, as an obviously nonhuman body impedes the kind of romantic soap opera interaction vital in *BGC*-style anime. For reasons of game balance, Referees

should also ban boomer PC’s with advanced fusion capability, or with “Black Box” satellite linkage like Largo. That leaves these types of boomers as suitable PC’s:

- The best choice is biomimetic (aka. “endoskeletal”) androids. These are models with human-range stats, little or no armor, no built-in gimmicks (like weapons, flight jets or Fusion capability), and whose regeneration takes place on a daily rather than turn-by-turn basis. Types: BU-33S Sexaroid, Phantom Lady-type android, and the commercial android on p.36. While all the examples of these types that appear in the videos are female, male versions do exist!

- Endoskeleton-type combat androids. Similar to the above, but with built-in weaponry and body armor. The Boomer Woman is a good choice—Dr. Yuri’s boomer terrorists aren’t really bright enough to make good PC’s! Identical male versions of the Boomer Woman do exist. Their power level is more suited to *Crisis/Crash!* campaign power levels than *AD Police*. Boomers of this type are too heavy to use hardsuits—see below.

- Powerful combat or experimental boomers that use disguise functions to appear human. Types: Old Model Combat Boomers, BU-55C, Female Combat Boomer, Miriam’s Strike, Heavy and Assault Boomer, all Hyperboomers. These can make playable PC’s in *Crash*-power level campaigns, but we don’t recommend it. Such a character has hardsuit-level power 24 hours a day, which eliminates any sense of danger in many encounters. Their fusion abilities are also open to potential abuse.

STAT POINTS: A boomer player character has no stat points—their boomer’s statistics are “built in,” unique to their model. Some boomer designs specify that certain stats can be varied (such as mental stats on the BU-33S). If no changes are specified, Referees can allow the player to increase one stat by +1 in exchange for decreasing another stat by 1; only INT, PRE, WILL or TECH can be so increased or decreased. This represents minor variations between individual AI’s of the same basic type.

CAMPAIGN POINTS: Boomer PC’s can use Campaign Points to buy Skills, Talents, Perks & Privileges. The Referee should use Campaign Points to balance boomer characters with other humans—on average, most boomers have lived much shorter and less varied lives than people. Divide the normal level of Campaign Points given to human player characters as follows:

Android models: 1/2 CP; Mannequin models: 1/3 CP; Combat and Hyper boomers: 1/5 CP for mass-produced Combat models, 1/10 CP for experimental types like Hyperboomers.

If “relevant skills” are listed in the boomer type description, the player must use CPs to buy at least one level in each of them. No skill level may exceed the boomer’s AI level to start with, although skills can improve above it by experience.

COMPLICATIONS: Boomers can get extra Campaign Points by taking complications. The obvious ones are Enemies (the boomers are hunted by their previous owners or by AD Police) and Oppressed—Enslaved (20; you’re property). Boomers (especially from space) are often Outsiders

Some recycled boomers may have physiological impairments, such as the Phantom Lady’s loss of her voice, or suffer various Psychological Complications (maybe even the Delusion that they’re human). A boomer player character has probably broken down most of the “walls” in his mind. However, a boomer may also be freed as a result of having lost its owner, but still have some vestiges of its programming remaining. These can be handled by Responsibilities or Personality Traits. For example, Adama has a Sense of Duty, since he was programmed by Dr. Haynes to be a friend of mankind. A boomer could also be following its owner’s last commands, which are represented by a Vow—protect his loved one, fulfill a quest, fight the owner’s enemies, whatever.



NO HARDSUITS: A boomer weighing over 150 kg or possessing built-in armor should not be able to use a hardsuit. While a human-sized boomer may be able to fit into one, its much greater weight-to-body-volume ratio is too much for a hardsuit's own servo capabilities. (Of course, some types of hyperboomers can *look* like hardsuits.)

MAKING REPAIRS

Repairs to boomers, vehicles, or mecha take an hour's work in a garage and a Tech skill roll. Use a target of 12 for mundane tech (cars, copters, etc.), 16 for most boomers, 20 for superscience like hardsuits or hyperboomers; see *BGC* p.38 for modifiers. If the roll succeeds, multiply the degree of success by 0.1 and add 0.1 to determine the Kills repaired—thus, a success by 3 means 0.4 Kills; if using SDP, convert Kills to SDP normally. Chinks in armor can be patched at the same rate. To get something that was destroyed working again (or fix a wrecked location on a large mecha), half its lost Kills must be repaired.

▼ MORE MYSTERIES OF BGC

Here are some more *Bubblegum Crisis* enigmas that can be used to inspire adventures:

LEON'S LOST LADIES: What happened to Jeena Malso and Iris Cara? Finding out could be the focus of a 2032-34 adventure, which might draw in the PC's and Leon. In the *AD Police* manga, Jeena was touched by the consciousness of the same "Armstrong" entity that may have contaminated Brian J. Mason's mind (see *BGC* p. 166)—perhaps this may have left her sensitive to Largo.

DD & THE MICRO-NEUTRON BOMB: When Sylia ordered the Knight Sabers to scatter at the end of *BGC 5: Moonlight Rambler*, they left behind not only the two mangled BU-55C's, the DD and Sylvie (all potentially valuable), but also the DD's city-busting micro-neutron bomb! The bomb itself was seemingly undamaged, and probably contained bomb-grade fissionable material. Did the AD Police or Genom recover it? Was it, in fact, the same self-destruct device which eventually turned up in Lando's body, or might someone else have it?

"IT WOULD BE MORE ACCURATE TO SAY IT CEASED FUNCTIONING": As Largo points out, Sylvie and Anri are machines. In *ADP 1: The Phantom Lady*, a sexaroid-type boomer is brought back from the dead, retaining some memories even after severe damage and deliberate mind wipe. Neither Sylvie nor Anri suffers severe head injuries, so it's conceivable whoever recovered their bodies could resurrect them, perhaps with memory losses. Both know many secrets: Priss' identity and conspiracies in Genom and SDPC. What would Priss do if she learned Sylvie had been resurrected, and was in someone else's hands?

THE FRIENDLY ASSASSIN: In *BGC Crash 2: Geo-Climbers*, Adama uses his advanced AI to access the AI of the female terrorist boomer, making her believe that she and Priss were friends. That boomer was last seen on a train station, waving goodbye. What *did* happen to her? While Adama probably just altered her perceptions, it's possible he destroyed some of the "walls" in her brain—which might make her a suitable play-er character.

LARGO'S BACK DOOR?: Largo's unfinished body was located *inside* the Brüm-bar drilling machine. Wouldn't he have died too when it blew up the reactor? Since Largo did not seem suicidal, maybe he intended to download his consciousness at the last minute ... or perhaps this wasn't the last of his bodies!

GENERIC NPC'S

Here are some simple write-ups for a variety of typical characters a Referee may need in his *Bubblegum Crisis* adventures. You should feel free to use these as "basic models" and modify them to fit the specific situation.

SALARIMAN (OR WOMAN)

Stats & Skills: INT 4, TECH 4, PRE 3, WILL 4, REF 3, DEX 3, STR 3, CON 3, BOD 3, MV 4. Business +5, Computers +3, Perception+3, Social +3, Wardrobe & Style +3.

Equipment: Laptop computer (POW 3), cellphone, business suit.

CORPORATE TECHNICIAN

Stats & Skills: INT 3, TECH 5, PRE 3, WILL 2, REF 3, DEX 3, STR 2, CON 2, BOD 2, MV 4. Basic Tech +5, Computers +3, High Tech or Milspec Tech +4.

Equipment: Corporate Lab with POW 6 computer, lab smock, corporate ID.

STREET TECHNICIAN

Stats & Skills: INT 4, TECH 5, PRE 3, WILL 3, REF 3, DEX 4, STR 3, CON 3, BOD 2, MV 4. Basic Tech +4, High Tech or Milspec Tech +3, Computers +3, Perception +2, Firearms +2.

Equipment: Coveralls, portable tool kit, workshop with POW 4 computer and lots of assorted techno-junk, maybe a combat pistol.

PUNK/GANGER

Stats & Skills: INT 2, TECH 3, PRE 3, WILL 3, REF 4, DEX 4, STR 3, CON 2, BOD 2, MV 4. Perception +3, Athletics +3, Hand-to-Hand +3, Melee Weapons +4, Handguns (if any) +3.

Equipment: Street clothes, cellphone (everyone has one). If heavy combat is called for, give them submachine guns, carbines, or combat revolvers. For more restrained mayhem, they'll use nunchuks, swords, and knives, with a couple of them having concealed combat revolvers. Bozosoku (motorcycle gangers) will have motorcycles and Driving +4 as well. At the Ref's discretion, they may have some cybernetics such as optics, brain boxes, fashionware, and implanted blade weapons.

NORMAL POLICE OFFICER

Stats & Skills: INT 4, TECH 3, PRE 4, WILL 5, REF 5, DEX 5, STR 5, CON 5, BOD 5, MV 5. Detective +2, Perception +3, Athletics +2, Hand-to-Hand +3, Melee Weapons +3, Handguns +5, Driving +2.

Equipment: Uniform, portable police radio, Combat Revolver, notepad/palmtop computer (POW 1).

CORPORATE GUARD (HUMAN)

Stats & Skills: INT 2, TECH 2, PRE 3, WILL 3, REF 4, DEX 4, STR 4, CON 3, BOD 4, MV 4. Perception +2, Athletics +2, Hand-to-Hand +3, Melee Weapons +3, Handguns +4.

Equipment: Uniform (or a suit if undercover) armored to 10KD (EV-1), earpiece comlink, sunglasses, corporate ID. If heavy combat is called for, give them submachine guns, otherwise combat revolvers. At the Ref's discretion, they may have some cybernetics such as optics, pain editor, audio, and implanted cyberweapons.

CYBERNETICS RULES

In 2027, it's all the rage to replace human parts with synthetics: Cybernetics are available at commercial hospitals called Cybernetics Banks, where customers can receive "free" cybernetics by trading in body parts as follows: **Arm: Standard cyberarm. Leg: Standard cyberleg. Eye: Basic cyberoptic. Ears: Basic Cyberaudio. Kidney: Cyberkidney. And so on . . .**

By the 2030's, however, the dangers of boomer syndrome have been recognized, and the Cyberbanks have gone out of business. Still, a cyberpunk underground continues to exist, and cybernetic replacements can still be purchased from unlicensed underground clinics run by street techs.

Be it 2027 or 2034, the law states that if you replace too much of yourself you can be declared a "boomeroid", and considered a boomer in the eyes of the law—break the law and you're subject to summary termination. While 70% is the legal limit on artificial parts, the trick is knowing what that means in body bits replaced. Here are some basic guidelines: arm or leg: 20%, hand or foot (alone): 5%, Eye: 3%, Neural Processor Implant : 10%, each individual organ: 5-10%, Major Organ Replacement (see below): 45%, each area body-plated (see below): 10%.

Of course, the police make the final call on when you actually cross the line. Many law-abiding citizens with elaborate cybernetics are left alone, while moderately enhanced malcontents and criminals might be declared boomeroids at the drop of a hat. Of course, if you slide into the Boomer Syndrome, it probably won't matter what percentage you're at . . .

▼SURGERY

Each type of cybernetics has a Surgery Code. This represents the minimum level of medical care required to install the cybernetics, the length of time needed, and the cost and the target number difficulty of the surgical operation (in case a player wants to try it himself). If surgery fails, the damage is taken, but the cybernetics are not installed. Try again?

Negligible (N): Any mall clinic or back alley bodyshop. Takes 1 hour, does 1 point of killing damage. Target Number: 10.

Minor (M): Medical center or average street clinic. Takes 2 hours, does 1D6 points killing damage. Target Number: 15.

Major (MA): Full hospital with surgery center—either a top line "black clinic", corporate surgical facility, or cybernetics bank. Takes 4 hours, does 2D6 killing damage. Target Number: 20.

Critical (CR): As above, but the surgery takes 6 hours and does 3D6 killing damage. Target Number: 25.



▼HUMANITY LOSS

The technical and psychological aspects of boomer syndrome are discussed in detail in the AD Police chapter ("Cybernetics and Boomer Syndrome", p.10). Here's how it works in the game:

The Derived Stat of Humanity (HUM) is equal to WILL x10.

The mental deterioration caused by boomer syndrome is measured by humanity loss—as cybernetics are added to the body, they subtract from the Humanity score. Every enhancement has a corresponding Humanity Cost (HC), sometimes a dice range. Keep track of all cumulative points—those 1's and 0.5's can add up!

This can start to cost you. For every 10 full points lost from Humanity, a corresponding -1 penalty is applied to your ability to deal with people. For example: If you lose 33 Humanity, you suffer -3 to any skill rolls involved in relating to people, such as seduction attempts, detecting lies, being convincing, etc. Intimidation attempts are not affected.

When you have 9 ~1 Humanity points left, you'll seem unusually cold or withdrawn, and find it difficult to be interested in anything (except perhaps one particular obsession that gnaws at you).

When you have 0 ~ -9 Humanity points left, you are teetering on the brink. Sometimes you seem normal, but much of the time you are chilly, forbidding, and distinctly unpleasant. Stress (overwork, combat, etc.) gives a 1 in 6 chance that you'll experience boomer syndrome symptoms described on pp.10-11: pains, headaches, psychomorphing, sudden rage, etc. They'll only be temporary, lasting anywhere from a few turns to a few hours. At this point, you may realize you need help, or may no longer care.

When you drop below -10 Humanity points, you're in the grip of boomer syndrome-induced insanity. You may become a rampaging psycho immediately, or suffer more subtle problems, as described in the "Boomer Syndrome" section, e.g., a Jekyll-and-Hyde split personality where you perform sociopathic acts part of the time (which you may or may not remember) but also have periods of relative normality. A total collapse into berserk rage or catatonia can occur within weeks, days, or even hours. The Referee can take over an insane player character at any time.

THERAPY: A psychologist can treat a person suffering from boomer syndrome. In the BGC era, these techniques are all experimental, and range from drug treatments with powerful stimulants (which can also result in addiction) to electroshock to counseling. If all cybernetics are removed, therapy can restore 4D6 Humanity points per week. Therapy can also be attempted *without* removing all cybernetics—if so, make a Science (Psychology) roll vs. TN 20. If successful, 1D10 Humanity is regained, but on a failure, another 1D6 is lost!

▼BUYING CYBERNETICS

Cybernetics are very affordable, thanks to mass-marketing and boomer technology. Most people prefer natural-looking cybernetics—cyberoptics that look like eyes, interface plugs in inconspicuous places, etc.—and the prices listed reflect this style choice. Remember, while the prices are listed in yen (¥), player characters can purchase cybernetics with Option Points at a ratio of ¥20,000 to 1 OP.

Despite the low cost of cybernetics, some people can't afford the good stuff (or don't care for it). In that case, you can get really obvious and unsubtle cybernetics—large plug sockets with bulky cables, external organ modules, goggle-like cyberoptics, etc.—for 75% of the listed price. In fact, if you're buying street tech, that may be the only kind you can get. But there's a catch: This kind of obvious cybernetics automatically gives you the Distinctive Features complication (and not in a good way). Plus, such cybernetics have an additional 1D6 Humanity Cost for each piece, since it acts as a constant reminder of your lost flesh.

Another way to get cheap cybernetics is to go to a boomer recycling shop and buy used boomer parts. This *doubles* the Humanity Cost of that bit of cybernetics (but no one knows this for sure in 2027) but *halves* the price. In the 2030's, the cybernetics market is completely underground—there is a 2 in 6 chance that cybernetics may be boomerware even if you pay full price for it!



▼ CYBERNETICS LISTS

▼ FASHION CYBERNETICS

These high-tech cosmetic augmentations are the height of radical chic in the 2020's.

Light Tattoos: Subdermal, light-emitting chemical patches inserted between skin layers. Available in multiple colors and patterns. Surg. N, ¥1-4,000, HC 0.5.

Chronoskin: A digital LED watch implanted just below the epidermis (usually on the hand) or under the fingernails. Can reset by pressing the display gently until numbers change. Surg. N, ¥10,000, HC 1.

Techhair: These are reactive hair implants that can glow, change color, stand on end, and so on. Surg. N, ¥1-5,000, HC 2.

▼ NEURAL CYBERNETICS

Basic neural cybernetics consist of a "switchbox" processor implanted in the lower spine and interface sockets for linking to external gear. It takes 1D6+7 days to weave the processor's nanotech threads throughout the nervous system. After that, it can be fitted with external interface plugs into which cables can be inserted, providing various capabilities.

These interface plugs can be installed in the wrists, base of the neck, temples, or behind the ears, in order to tap into major nerve trunks to allow the user to control a plugged-in computer (like a Brain Box, see below), access the Net without using a keyboard, download information directly into the brain, etc. They also allow the user to operate vehicles, heavy machinery, automated factory equipment, electronic devices (like digital cameras), and so on via direct mental control with inhuman responsiveness (+2 Skill). Devices must have been designed for direct neural control and have a cable to plug into a socket (this adds 40% to the mecha's cost). This is the cybernetic precursor to Synchro-technology (see *BGC*, p. 62).

The basic neural processor and two plugs are Surg. M, ¥240,000, HC 2D6. Each additional plug is M, ¥40,000 and HC 1D6.

The processor can be equipped with coprocessor chips to expand its abilities (each takes one plug):

Boosted Senses: Adds +2 to any Perception roll involving smell or touch; allows tracking by scent. Can be turned on or off at will. Surg. N, ¥30,000, HC 3.

Pain Editor: Overrides the pain receptors of the brain—treat this as twice as good as the High Pain Threshold talent (bonuses are cumulative with it). Surg. N, ¥40,000, HC 2D6.

▼ PLUG-INS

There are a variety of external devices designed specifically to "plug in" to an interface socket and provide enhanced abilities for the user. These are usually small electronic modules that can be hung on straps, left in pockets or backpacks, or mounted on wrist or belt. They all have cables for linking to one of the wearer's neural plugs. The output can be routed to IHUD optic or directly into the brain (hence the Humanity cost).

Brain Box: Portable computer designed to expand the user's mental abilities. They are usually POW 3 (sometimes as high as 5) notebook computers with modems, which can plug into a phone jack and be used to access the Net. ¥60,000 (+40,000 per POW over 3), HC 1.

In addition, a Brain Box can run a variety of special programs (but it can only load one at a time). Some examples are:

- **BOOST:** allows the computer to act as an intellect boost for up to one hour per twenty-four. INT +1, ¥20,000, HC 2D6.
- **NETWORK:** Allows the user to access the Net via the plugs (+2 to Hacking rolls). ¥10,000
- **TRIP:** A virtual reality drug which is immensely entertaining and involving (and very addictive; make a WILL+Concentration vs. TN 20 or be hooked). ¥20,000.
- **VIRTUAL COMPANION:** This is a computer-generated friend which only the user can see (via his link). It acts as a companion and "playmate" to the user, with a fully programmed set of emotional (and tactile) responses. Only Brain Boxes of POW 4 or greater can run this program. There have been rumors of VC programs taking over the minds and bodies of their users, but that's ridiculous ... right? ¥50,000, HC 1D6.

Exo-Boomer: An exoskeletal framework with its own power pack and super-strong synthetic muscles based on boomer technology. It gives you increased STR, but requires a neural plug to operate. An Exo-Boomer adds 50 kg to your body weight and makes you too heavy to swim. The battery lasts for about twelve hours of usage. STR 10, ¥120,000, HC 2D6. These can be surgically grafted to the wearer (Surg. MA, +3D6 HC).

Sensor Modules: These are various external sensor packages which can be strapped to the body or handheld, and when plugged into an interface socket they expand the user's senses.

Each sensor module is ¥50,000, HC 1.

- **Chemical Sniffer:** Allows user to analyze the chemical components of particular smells.
- **Motion Detector:** Sonic or infrared sensor that detects motion (direction and strength) in a 20 sq. meter/yard area around the user.
- **Radar:** 100m range radar unit which detects objects in 180-degree (forward) arc. Does not work underwater (use sonar instead).
- **Radiation Detector:** 10m range, relays data and exposure levels if it detects radiation.
- **Sonar:** 50m range active sonar unit, detects objects in 180-degree (forward) arc.

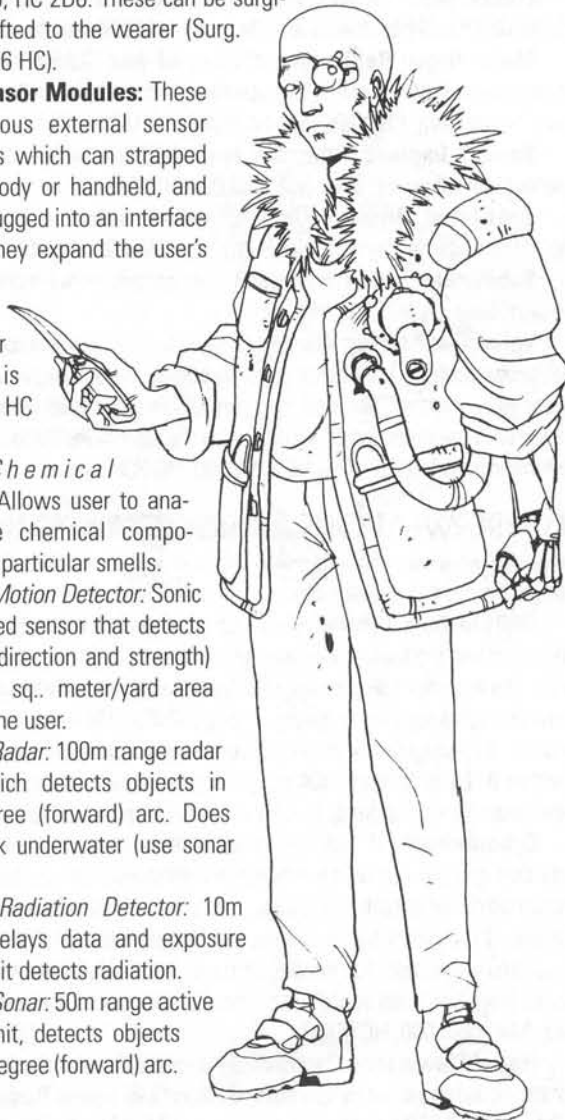



▼IMPLANTS

These devices allow performance of special tasks. Spotting subdermal armor or pockets that are not concealed by clothing requires a Perception roll vs. TN 25 if a visual search or TN 20 by touch or thermographic scan.

Adrenaline Booster: An artificial gland which releases adrenaline analog hormones on command. Adds +1 to REF for 1D6+2 turns, three times per day. Surg. M, ¥80,000, HC 2D6.

Contraceptive Implant: Prevents pregnancy for up to five years. Available for both sexes. Surg. N, ¥20,000, HC 0.5.

Cyberkidney: +4 to resist poisons including alcohol, and reduces bathroom visits. Surg. MA, ¥300,000, HC 2D6.

Cyberwomb: Replaces a woman's uterus and ovaries with cybernetic parts, and ensures that pregnancy, menstruation, and menopause will not occur. Surg. MA, ¥200,000, HC 3D6.

Flexcords: These are prehensile, built-in interface cables for use with cyber-controllable equipment. Creepy. MA, ¥80,000, HC 1D6.

Gills: User can breath water for up to 4 hours. (If the water is polluted, he may be poisoned.) Surg. MA, ¥80,000, HC 3D6.

Cyberlungs: You can hold your breath 25 minutes if inactive, 10 minutes if active. Surg. MA, ¥60,000, HC 2D6.

Filters: Replaces most of the nose; add +4 to rolls to resist the effects of inhaled gas, fumes, etc. Surg. M, ¥12,000, HC 2.

Major Organ Replacement: Many of your internal organs are replaced with better-functioning cybernetics. Your CON is +5 (to a maximum of 10). Surg. CR. ¥600,000. HC 5D6.

Sexual Implant: After the operation, it's better than ever. Available for all sexes. Surg. MA, ¥60,000, HC 2D6.

Subdermal Armor: A layer of ballistic mesh armor (KD 18) implanted under the torso's skin. Surg. CR, ¥240,000, HC 2D6.

Subdermal Pocket: A sealed 2" x 4" plastic pocket hidden under the skin. Surg. M, ¥40,000, HC 2D6.

Voice Synthesizer: Allows the user to mimic any voice or tone previously recorded (chip holds up to 10 voices). +4 on Disguise attempt where voice matters. The user can control his vocal tone, volume, and quality with the precision of a musical synthesizer. Adds +2 to any vocal Performance skill rolls. Surg. M, ¥160,000, HC 2D6.

▼CYBERWEAPONS

These are weapons implanted into the user's limbs or body (most can also be mounted in cyberlimbs).

Built-in Gun: Cyberarms can conceal guns within their framework. Spotting the built-in weapon requires an INT+ Perception +die roll vs 20. The maximum size weapon you can mount depends on your Body score: 0-1: Mini revolver or handgun only; 2-7: Combat handgun, combat revolver; 8+: Magnum revolver, sawed-off shotgun, submachine gun, Member II, Earth Shaker, .454 magnum pistol, grenade launcher (two rather than six shots). Surg. N, cost is twice the gun's price; HC 2D6.

Cybertentacle: A 1/2-meter prehensile tentacle implanted in the body that can coil out of the cyborg's throat to rake at victims using a sharpened tip or retractable spines. It has WA +2 and does 3D6 killing damage. If the victim and user kiss, the tentacle can enter the victim's throat and eviscerate for double damage, continuing until the victim breaks free (use Grab rules). The tentacle can mount one cyberoptic. Surg. MA, ¥240,000, HC 4D6.

Finger Claws: Long (3-inch) blades implanted under the fingernails that can be extended out by spreading the hand into a claw. They allow the user to do DC 3 STR-powered killing damage. Surg. M, ¥80,000, HC 3D6.

Finger Razors: Half-inch metal or ceramic blades which deploy from under the fingernails. They allow the user to do DC 2 STR-powered killing damage. Surg. N, ¥20,000, HC 2D6.

Punch Daggers: Very long (1-foot) blades implanted along the back of the hand, extending out of the knuckles when clenched into a fist. They do DC 5 STR-powered killing damage. Surg. M, ¥120,000, HC 3D6+1.

Spike Heel: 6-inch spike extendible from heel allows kicks to do killing damage. Surg. M, ¥100,000, HC 2D6.

Weapon Joint: This is a gun hardpoint built into the elbow of a cyberarm. You may remove the lower arm and attach any 2-handed weapon, allowing one-handed use. You can't wear armor or clothing on that limb while the mount is used, however. Surg. N, ¥20,000, HC 1D6.

Wire Fingers: Artificial fingertips which can be fired off at high velocity, trailing 5 meter wires. The fingertips do 2D6 damage; if more than one is fired at a time, the margin of success determines how many fingers hit. Surg. M, ¥120,000, HC 3D6+1.

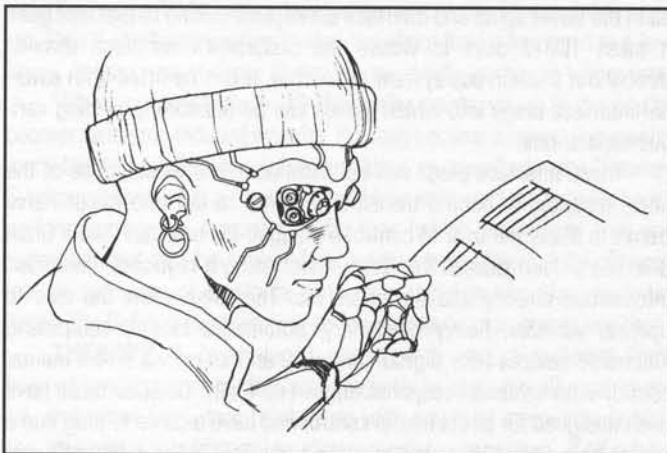

▼CYBEROPTICS

These are cybernetic replacements for normal eyes. The basic cyberoptic is functionally identical to a normal eye, although some models may look nonhuman. Eyes automatically protect user from being blinded by flashes, harsh sunlight, bright spotlights, laser blinding, etc. Basic cyberoptics are Surg. MA, ¥100,000 each, HC 2D6 each. Each may have up to four built-in features at extra cost:

Night Vision: The user can see in total darkness, using infrared heat emissions or ambient light amplification. Surg. N, ¥40,000, HC 0.5.

Internal Heads-Up Display (IHUD): Scrolling alphanumeric in edge of visual field, used to display text outputs of other cybernetics (usually plug-ins, etc). Surg. N, ¥60,000, HC 1.

Image Enhancement: Through high-definition imaging, this option can magnify images like a lab microscope, act like a 20X telescope, and add +2 to visual Perception checks. Surg. N, ¥30,000, HC 0.5.

Targeting: Projects a targeting sight into the field of vision, giving an extra +1 to skill. Surg. N, ¥80,000, HC 2.

Thermograph: Allows user to see heat patterns of objects and people; the color spectrum indicates the heat, with dark blue being coolest to yellow-white being hottest. Can distinguish hidden cybernetics (which are cooler than body temperature), operating time of machinery (by its cooling gradient), etc. Surg. N, ¥50,000, HC 0.5.

Videocam: A digital camcorder that records its view to an internal chip (20 minutes of motion video, or nigh-unlimited stills). This video recording can be downloaded via interface plugs to an external source. Takes up two option spaces. Surg. N, ¥60,000, HC 0.5.



▼CYBERAUDIO

Cyberaudio systems patch into the auditory nerves and speech centers of the brain. A basic cyberaudio system replaces both ears and includes a subvocalizing mike on the mastoid bone. The ears may look normal, but some favor boxy speakers, antennae, cat ears, or other fashion statements. Surg. M, ¥100,000, 2D6. Any cyberaudio option can be added, at extra cost:

Enhanced Audio: This digital fine-tuning of cyberaudio amplifies faint sounds and edits out distracting noise to allow zeroing in on a particular sound (+2 to audio Perception), and edits out loud noises like explosions (you won't be deafened or stunned by them). Surg. N, ¥40,000, HC 1.

CommLink: A miniature radio transceiver and cellphone, with a 3km range. To talk, you subvocalize; output can be received as either a tinny voice in the back of your head or, if you have IHUD optics, as text. Surg. N, ¥30,000, HC 1.

Recorder: Allows anything heard by the user to be recorded on a microchip (up to 6 hours). It can be downloaded via interface plugs. Surg. N, ¥20,000, HC 0.5.

Scrambler: Makes phone splice or radio link conversations private, unless the interceptor has a sophisticated descrambling unit, takes a minute to listen in, and makes a TN 20+ INT+Electronic Warfare skill roll. Surg. N, ¥20,000, HC 0.5.

▼CYBERLIMBS

This is what the average person thinks of as cybernetics: artificial arms and legs, created using much the same technology as boomer limbs. All cyberlimbs are Surg. CR. An arm costs ¥630,000, a leg ¥440,000. Both are HC 2D6.

Cyberlimbs have only limited sense of touch, but can turn off pain, never get tired, and take up to 20 points of damage before becoming useless (and another 10 points after that before destruction). Damage to cyberlimbs isn't counted against the body's Hits. Due to its extra toughness, a cybernetic arm or leg adds +1 to its DC when punching, kicking, and using implanted melee weapons, and can do 1/2 normal DC as killing damage. A cybernetic arm also has STR 10 for crushing things only. It gets the average of STR 10 and the user's normal STR when using the Grab maneuver, but can't lift or punch with more than original STR, because it's attached to the "meat" of human back and shoulder muscles. One cybernetic leg is nothing special, but if the user has *two* he has an effective MOVE Stat of 12 for purposes of leaping.

The basic cybernetic limb comes with a standard hand or foot (as appropriate). Common options include:

Coverings: Normally, cyberlimbs are obviously made of machinery. However, they can be given realistic skin covering (looks and feels natural, *reduces* HC by 1D6/2) or be armored (KD 20) for Surg. N and ¥40,000.

Grapple Hand: Hand can be launched off and used as a throwing grapple, with a 30m spool connected to the wrist (supports 100 kg). Surg. N, ¥50,000, HC 3.

Hidden Holster: Available for a cyberleg only, this is a hidden storage space for one pistol and one clip of extra ammo (Perception roll vs. 20 to notice). Maximum size weapon is as per pop-up guns. Surg. N, ¥20,000, HC 1.

Tool Hand: The fingers conceal retractable microtools (screwdriver, adjustable wrench, soldering iron, socket wrench). Surg. N, ¥40,000, HC 2.

▼BODY-PLATING

Very obvious protection—armored composites are layered directly onto the head and torso. Many people may mistake a body-plated cyborg for a boomer!

Head Plating: Covers the entire head with KD 25. Makes cyborg obviously inhuman, but the "look" may range from helmet-like to monstrous. Surg. MA, ¥120,000, HC 5D6.

Torso Plating: KD 25 protection covering chest, stomach, and vitals, with joints to allow free movement. -1 DEX and REF. Surg. CR, ¥400,000, HC 3D6.

▼FULL CYBORG BODIES

In the ultimate expression of modern cybernetic technology, a human brain can be placed in an artificial body! This is extremely rare, expensive, and experimental work, generally the focus of a large corporate or government project. Full-cyborg bodies can be bought at varying sizes and power levels, replacing the character's STR, BOD, and MOVE stats, eliminating the CON stat and STUN points entirely, and giving the character SDP rather than Hits. All limbs are considered to have the same capabilities as cyberlimbs, and cyberoptics and cyberaudio are all included (although options cost extra). Needless to say, any full cyborg is considered a boomeroid and gets the Complication: Distinctive Features!

Physical Stats: Each 1 point of STR, BOD, and MOVE and each 5 SDP costs ¥300,000 and 1D6 HC (the shock is less as it's all at once); thus a cyborg with a STR, BOD, and MOVE of 8 will have 40 SDP, cost ¥2,400,000, and take 8D6 HC (max STR: 12). Surgery: 2x CRITICAL. The Humanity loss can be reduced by 1D6 if another "meat" part is also kept. However, there is an extra 1D6 HC each week for the first month, then 1D6 each month for the first year, then 1D6 each year for the next six years. After that, either you have adjusted or you've gone mad!

Other Stats: A full cyborg retains his own INT, TECH, WILL, PRE, REF, and DEX, but REF, DEX, and MOVE can be bought up for ¥350,000 and 2 HC per +1 each; thus buying +2 REF and +2 DEX will cost ¥1,400,000 and take 8 HC.

Armor: Full cyborgs have a natural KD of 5, but this can be bought up at a cost of (KD x KD) times ¥500—the maximum KD is equal to the cyborg's SDP, and each 5 KD costs 1 HC.

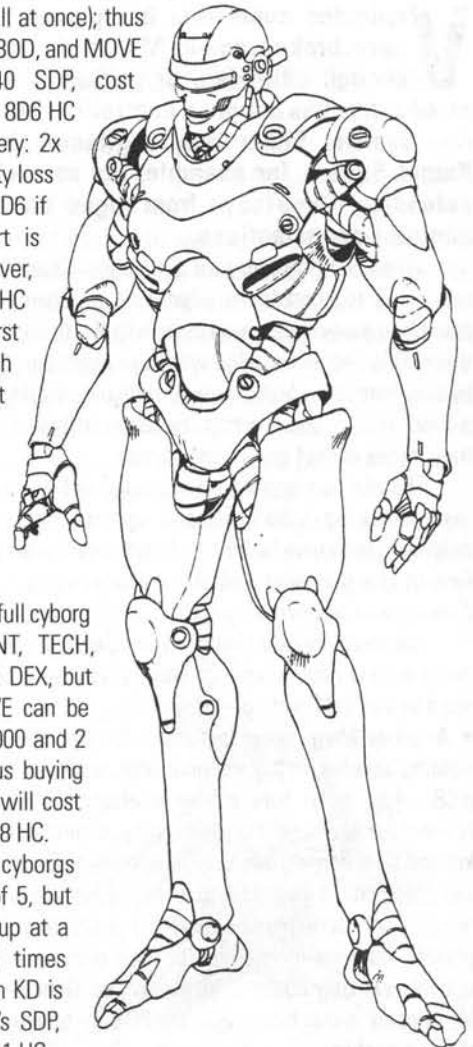

HI-TECH VIGILANTES

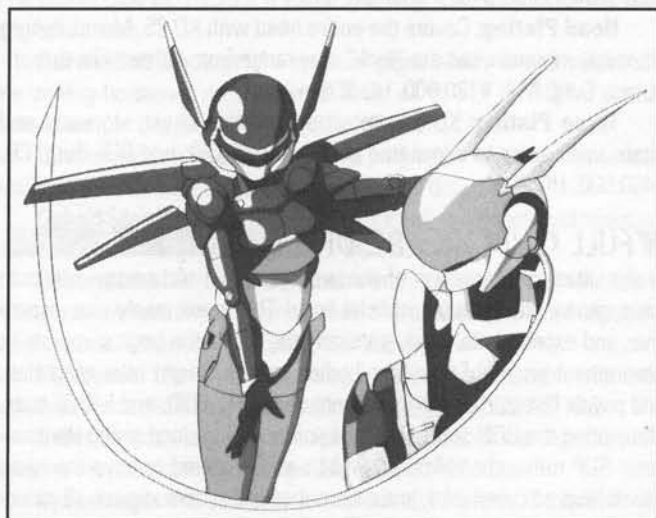

"You can't just do as you please in this town"
—Linna Yamazaki to the Illegal Army, AD2034

Vigilantes come into being where law and order have broken down. Maybe the police aren't well enough equipped, or perhaps corporate or organized crime has bought a controlling influence in the justice system. Either way, vigilantes fill the gap—the Knight Sabers, for example, act as a check on Genom, defending MegaTokyo from rogue boomers and out-of-control Genom factions.

When creating your own *Bubblegum Crossfire* vigilante team, the first thing to consider is what kind of enemy would be powerful enough to motivate a group of individuals to come together to oppose them. This should be a foe whose minions can be effectively battled by sexy heroes in sleek powered suits (i.e., world hunger probably isn't a good choice!) and one that conventional law enforcement or the military forces cannot or will not oppose.

The obvious opponent is Genom and its boomers; the players' team takes up Sylia's crusade against the megacorporation, but defending their own home city. There they thwart the plots of the local Genom vice president and other splinter groups, as described in the *Bubblegum Crossfire* setting (*BGC* p.167).

But there are other evils beyond Genom! Some enemies that may make worthy opponents—or alternatives to Genom after it is weakened in the 2034 setting—include:

- **Another Megacorp:** Instead of Genom, the team could focus on fighting another rising multinational, such as Gulf & Bradley (*BGC* p.58)—just make sure it's an interesting opponent for hardsuited heroes! For example, a company may dominate the powered-suit market and be scheming (along with Genom) to fan the fires of war around the globe; its agents may use prototype armored suits and battlemovers, be working with Neo-NATO or China, or be trying to steal the players' hardsuit technology for their own ends. They might also be actively working against the weakened Genom—as local corporate VP's deploy secret hit squads, the PC's try to avenge innocents caught in the crossfire.

- **Organized Crime:** *BGC 7 "Double Vision"* portrays the Chang Group as honorable, but other Triads, the Yakuza and the Mafia may be nastier than the worst Genom executive. Referees shouldn't stick to 20th-century "drug lord" stereotypes; the 21st century has a host of exotic new crimes: Combat boomers, nukes, and biochem agents sold to Third World dictators, virtual reality "mind drugs", black market sexaroids, and more. As they also control illegal boomer recycling shops and "legitimate" front companies that are really arms manufacturers, organized crime could have nearly as many boomers and armored troopers as Genom, in which case a turf war between mecha-using gangs could tear a city apart! If the police are overwhelmed or corrupt, armored vigilantes may be the town's only hope

- **USSD:** In the 20th century only a few fringe groups feared the UN would become a world superpower. Well, the New World Order now wields an orbital sword of Damocles! What if a senior UN executive were using the satellite weapons, secret agents, or other UN forces for "special interventions" aimed at furthering his own ambitions rather than world peace? Already, the USSD's orbiting particle beam satellites have accidentally killed more people than boomer rampages (although most of the victims were Genom employees). Is USSD *really* the innocent pawn of groups such as Largo's, or were these attacks part of another, greater plot aimed at replacing Genom with a UN-run world government?

Whatever enemy the Referee chooses as the team's reason for existence, it's important to *make things personal*. Fighting for abstract principals isn't as much fun as a vendetta! You can follow *BGC's* lead by making one of the organization's bosses directly responsible for the death of a team member's loved one. Another good option is to have a player character who used to work for the enemy, but has now "seen the light" and opposes them. "Redemption" is as powerful a theme as revenge. To an extent, Sylia feels this way: Her father invented the boomers, so she has an obligation to control the harm they do. How about a team founded by a teenage son or daughter of the evil Dr. Yuri, who tries to make up for Father's misdeeds by using suits based on designs that he worked on, but never actually developed? In fact, this can be taken one step further by having a sibling or parent who is still *working* for the villainous organization. As they are your flesh and blood, you feel a responsibility to reform them ... or bring them to justice.

▼ TOOLS OF THE TRADE

It takes advanced technology to allow a small group of outlaws to stand up to an evil megacorporation or rampaging boomer. So where did they get those wonderful toys? The *Bubblegum Crossfire* campaign idea (*BGC* p.167) offers one answer—the largess of Dr. Stingray—but that doesn't have to be the only path:

- **Another Genius:** The team's suit designs weren't derived from Dr. Stingray—some other inventor known to players developed them in parallel.

- **Stolen Suits:** The players are ex-members of a military or corporate outfit that developed prototype hardsuits (such as the Genom Powered Suit on p.135 of *BGC*). Now they've stolen the suits and decided to go freelance. This is how Sylvie got her battlemover, but what if she (or someone like her) had stolen an entire crate of experimental hardsuits, instead of a single mecha? She'd need to recruit a team



• **Friends in High Places:** One of the group's founders has close ties to a corporation that makes combat suits, so they can either copy or borrow prototypes, or the plans to make them. This is how Vision got her battlemover.

• **Junkyard Knights:** This is anime! It's perfectly possible to imagine an obsessed "street tech" genius kitbashing together hardsuits from old military surplus, salvaged boomers, and so on. They'd have that "Millennium Falcon" junkyard look, but could be workable—the Cybermonster Griffon is an example of what can be done with a welder's torch, a few illegal components, and mad inspiration.

▼ TEAM ORGANIZATION

In the Knight Sabers, each member has a speciality—close combat, assault, electronic warfare and leadership. A player team will also be more fun—and effective—if each member has a chance to shine in a particular role.

The most important speciality is leadership. Referees should discuss how this will be handled with the players before starting the game. The Knight Sabers are commanded by Sylia, but she is a very careful leader—in essence, her role is mainly to choose the jobs the other Knight Sabers will take, and to provide some tactical judgment. She is careful to discuss other decisions with the Knight Sabers, and she follows a basic rule of command: She almost never gives an order that she knows won't be obeyed.

Not all players are comfortable with a leader—instead, they could vote on which jobs to take, for example, and work out in advance who does what when they go into combat. Another possibility is an NPC leader. This should be someone who assigns them missions, leaving strategy and tactics to the PC's. A good choice is a financier or inventor too old or too badly injured to actually don a hardsuit. It might also be someone who wishes to remain completely behind the scenes, perhaps relaying orders to the characters only via a communicator (like Largo's relationship with Lando), or through a single player who knows his secret (like Fargo). It's quite possible an NPC leader may have a secret agenda that the players won't find out about until later in the campaign. For example, the leader could actually be a Genom exec working out the bugs in a new hardsuit design, sending the players on missions to make her rivals in the boomer design department look bad—and someday she'll betray the players!

• **Team Tactics:** Carefully planned situational tactics like ambushes, traps, and surprise attacks can give a team an advantage. However, a group won't always have the chance to plan everything in advance, so a well organized team should work out a few basic moves ahead of time. While we never see the Sabers discussing formal tactics, they sometimes split into a "combat" element (Priss and Linna) that distracts and engages the enemy, with Nene and Sylia forming a "command" element in reserve. Often Sylia will fall back, either to attack the leader (as she did in *BGC 3*) or to take the enemy from behind (as she disposed of Lando).

• **Support and Cheerleading:** Referees should not stint on including one or two NPC's in a team. The game plays best if the members who go out on missions are players (so the Referee doesn't have to fight against himself), but a few well drawn NPCs in support roles will free the PC's from having to worry about boring non-combat jobs (mechanic, truck driver, medic, etc.) and will increase the possibilities for romance and other relationships within the team. If the Knight Sabers were player characters, Mackie would probably be an NPC. How about having a labor or waiter/waitress boomer as the team's butler or mechanic?

• **Recruiting:** Think about how the team recruited its members! When Sylia was setting up the Knight Sabers, she went looking for people to join her organization, even to the extent of "taking out an ad" (the puzzle program that Nene solved) in order to locate a computer hacker suitable for the team. However, it's also possible for an organization to come together in different ways:

The team may have worked for another organization (Genom, the military, etc.) before they "went freelance" as vigilantes.

The team may be a group of siblings. If Sylia had three other siblings about the same age (instead of the younger Mackie), they would have made a fine team.

The team's members could have started out as solo vigilantes, only to meet by chance (or while fighting the same menace) and decide to work together.

• **Making the Rules:** The existence of the "11 Rules of the Knight Sabers" suggests that Sylia wasn't sure she could trust everyone without a rigid code (punishable by death!). After the first few months, the new members earned her trust (and became friends), and the rules were relaxed. It could be a roleplaying challenge to play members of a newly forged team with a code that *is* taken seriously. This works best if most of the team agrees to enforce the rules among themselves, and has a mechanism (mutual vote or leader's fiat?). A punishment less than death (such as a dock in pay, etc.) for breaking the rules might also be more playable!

▼ TRAINING

"Leave it to Sylia to sacrifice Nene."

—Priss S. Asagiri, 2032

In the fast-paced world of the Knight Sabers, there's often no time to train for a specific mission—instead, a team keeps in shape by playing their own "war games" against one another. The best way to set up a training session is to divide the team into two groups and play "Survival." With computer sensors, it's possible to train in hardsuits: Low-power targeting lasers simulate actual weapons, telling a suit's computer whether or not it has been "hit" or "damaged" (so it will shut down systems). Of course, physical kicks and punches are "real" damage, so it's quite possible to be injured while training ...

Practice in hardsuits requires a relatively large area, like a big empty warehouse. Doing it outside could be more realistic, but then there's the risk that someone might notice and call the police, or

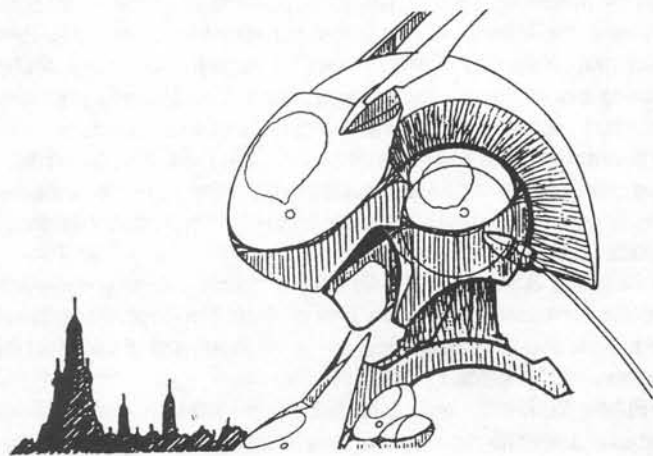

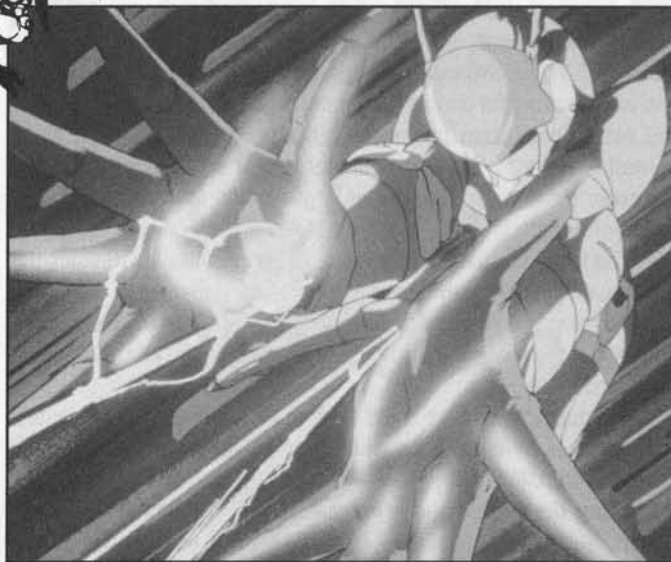

record the exercise and learn the suit's capabilities. For this reason, the Knight Sabers often trained without their suits: *BGC 4* opens with the Knight Sabers playing a paintball-style game, with the losing team paying for lunch, while in *BGC 8* an individual holographic simulator is used to test their speed and agility for purposes of fitting new suits.

Referees may want to encourage the players to try *roleplaying* a few "training" sessions—this shouldn't be worth many experience points (because there isn't much danger), but it's a fun way to learn the combat system, and a few experience points could be awarded if the players roleplay well and try out innovative tactics against each other.

▼ THE NEED FOR SECRECY

By definition, vigilantes operate outside the law. Even if they strive to do good, their hardsuits mount illegal weaponry and are packed with technology that governments and corporations would love to steal or copy. These are good reasons to maintain a secret identity!

However, players familiar with the Knight Sabers may take secrecy lightly. After all, senior members of AD Police and Genom know who the Knight Sabers are, and it hasn't hurt them. As long as they act like heroes, they've nothing to worry about, right?

Sure—if the city's top cops are decent people like Leon and Chief Todo. In the PC's town, that doesn't have to be the case. What if the local Advanced Police are bought-and-paid-for minions of Genom? A police chief can retire or resign, and the new one may want to make his rep by hunting down vigilantes! However, the Referee should bear in mind that if the police are already hunting the team, there's less incentive for them to act like heroes! The referee can mitigate this by having several "good cops" recognize what the vigilantes stand for, and buck their superiors by warning the PC's of police operations.

- **Arranging Jobs:** Secrecy is all well and good, but if the team keeps too low a profile, no one will be able to go to them for help. If they're mercenaries, there needs to be some way that customers can get in touch with them!

- **Contacts & Informers:** Sylia prefers to work this way, accepting "under the table" commissions from contacts like Fargo. Player characters who intend to work this way are well advised to take several points worth of Contact perks.

- **Public Notice:** Someone who wants to hire the vigilantes takes out an ad in a newsfax, on TV, on a notice board at a mall (anyone remem-

ber the classic anime show *City Hunter?*), or whatever. Maybe there's a certain BBS that the team regularly examines for messages. They leave a number to contact, a meeting is arranged (maybe from a public phone), and payment is made in cash or to numbered Swiss bank accounts.

There's always the danger that an employer will be setting a trap, or just fishing for more information. In *BGC 1*, *Tinsel City*, the USSD used a hidden scanner to try to determine the workings of Knight Saber hardsuits during a job interview. An informer can also be bribed or threatened into setting up a "job" that is actually a trap.

▼ NEW TECHNOLOGY

The first thing a lot of *Bubblegum Crossfire* players will ask is "How can we get this cool 2034-era technology?"

Answer: It's up to the Referee whether to allow it. Regular technology upgrades are perfectly in genre. On the other hand, they probably shouldn't happen every other adventure—even the Knight Sabers wait about three to five episodes! In game terms, all that's required is enough saved experience points to pay for the new technology's Construction Points ("cashing in" the value of old vehicles or suits is perfectly reasonable—assume they were cannibalized for parts!). Or the Referee can simply let them have the technology "free." The important thing isn't the point cost but rather rationalizing it as part of the story. So how can the Referee and players justify a technological upgrade?

Fast-Forward to Tomorrow: We never see Sylia using a welding torch. She and Mackie disappear for a month or two, then return with new vehicles, hardsuits and headquarters. We can assume she's spent many late hours working on computerized hardsuit design simulations while Mackie and Dr. Raven, and a good CAD/CAM autofactory did the actual work. If one or more players has Tech skills and resources like Sylia's, a similar "fast forward" is perfectly in genre—if so, the Referee should require experience points to be spent on buying the suits, as there was no actual game effort involved in acquiring them. The Referee could also decide the upgrade will cost several million yen *beyond* the team's current resources: They must successfully complete a few high-paying jobs either before or after (to pay back a big loan) to finance it.

Roleplaying Tech: The Referee can have the team roleplay the effort of making new suits, spending time away from jobs or adventures. They'll need to make several Tech skill rolls (Superheroic or higher difficulty!) to perform each upgrade, while spending buckets of money on parts (wasted if the rolls fail badly). If they aren't skilled enough to design their own, the Referee can reduce the target number if they use "found" parts such as salvaged hyper-boomer wreckage. If they "just barely" succeed, the upgrades may have undetected bugs. Maybe the new electrified wire daggers work fine, but the insulation is faulty: For a 1 in 6 chance they'll also short out the suit's computer whenever they're used! After this shows up in battle, it can be fixed, but if each suit has 1D6-1 "tiny flaws", PC's may be less eager to trade in what works for what's new!

The Geary Institute: If solo upgrades are beyond the Player-Characters' means, maybe Doctor Geary's lab in Germany (where Mackie went) is accepting new students? One of the Tech-oriented Players or NPC's could take a "sabbatical" there, returning after a few months. That way, in exchange for helping Sylia and Mackie on the new hardsuits, they've been rewarded with a new set of updated vehicle plans.



CREATING A HEADQUARTERS

Whether it's a high-fashion boutique with an attached aircraft hangar and garage or a mansion with a network of underground caves, a key part of the anime superhero setting is a secret headquarters! The Referee can simply assign the group an HQ. Alternatively, a headquarters can be purchased by the players using Campaign Points, in the same manner as hardsuits are.

Decide on the base's size and how tough the walls are:

BASE SIZE TABLE

CP	Size (m ²)	Example	CP	Size (m ²)	Example
5	56	Room	47	4,970	Hangar
6	81	Small Apt	60	8,100	Sm. Building
7	110	Apartment	75	12,656	
9	182	Large Apt	95	20,306	
12	324	Small House	120	32,400	
15	506	House	150	50,625	
19	812	Large House	188	79,524	Lg. Mall
24	1,296	Sm. Mansion	240	129,600	20-story bldg.
30	2,025	Mansion	300	202,500	30-story bldg.
38	3,249	Warehouse	366	301,401	45-story bldg.

CP: The base Construction Point cost of the building. It also represents the number of Kills the entire base has—these Kills may be spread among multiple buildings. For example, a 30-Kill (2,025m²) base could be one 14-Kill (441m²) building with two additional 8-Kill (144m²) buildings.

Size: This is the total area of floor space in square meters. For your information, the exact formula is ((CP or Kills x1.5) x (CP or Kills x1.5)) equals meters.

Armor: How resistant to damage are the walls? A typical brick or glass and steel wall has 15KD and 30SDP per square meter, but walls can be stronger. Every 50KD (that is, 1 Kill) of armor costs half the base's CP cost. So, to add 25KD to a 110m² base would cost +1.75CP; adding 2 Kills of armor to an 812m² base would cost +19CP.

Floor plans: The headquarters' area may be spread among several floors or basements, or even among multiple buildings. For example, a 3,200 square meter HQ might consist of five floors and a basement at 400 square meters each (say, 20m x 20m) and an additional 200 square meter (10m x 20m) detached garage. Space can then be allocated to living rooms, bedrooms, dining rooms, kitchens, hangars, equipment lockers, training rooms, labs, shops and so on. Doors, windows, garage space, interior walls (half strength), stairs, elevators, and utilities are free.

Grounds: An HQ comes with a yard-like zone whose area is equal to the HQ's area. This can represent parking space, garden, fields, etc., and can be doubled for +1 CP.

Next, buy the base has any special features or abilities, such as:

Backup Generator: For +1 CP it can have a backup generator for when power from the external power grid (or the main generator, if in space or underwater) is cut.

Computers: What's a secret base without an all-knowing computer system? A POW-3 computer costs 2CP, a POW-6 computer costs 5CP, and a POW-9 computer costs 11CP.

Workshop: A fully equipped workshop, giving a bonus with Tech or Science skills—remember to allocate enough room for the largest

object that can be repaired or worked on there! 2CP adds +1 to all TECH skills, 5CP adds +2, 11CP adds +3 to all TECH skills.

Communication Center: Fully equipped with scrambled communicator, satellite TV links, holographic vid screen, etc. Sensor range is 50km, and communications range is orbital. Cost is 5CP.

Mecha Facilities: This is an automated hangar-like area with launch devices (like secret elevators or steam catapults), cranelike waldo-arms, Gerry Chutes (named after Gerry Anderson, whose *Thunderbirds* series pioneered these contrivances—a slide, elevator chair, or other device that conveys the character from a room in the headquarters to his mecha's cockpit; these only work for boarding vehicles or battlemovers, not hardsuits), and/or other fancy moving parts. 1CP per vehicle that has access to all this equipment.

Secret Access: Add +1 CP for a secret door that leads into a normally hidden area or level, or for a secret entrance/exit that leads out through a hidden tunnel to some distant point, like the street, sewers, or a nearby ocean. If it is going to be big enough for a vehicle, use up several square meters drawing the tunnel.

Special Location: An urban HQ costs no extra points. Add +5 CP for a suburb or +10 for a more distant location. Special options increase the cost: +5 CP if deep wilderness, +20 if more than half the base's area is underground or +25 if aboveground part of base can actually *retract* underground (takes 10 seconds), +23 if more than half of base is underwater, or +38 if the base is located in orbit (this requires Referee approval!). Aquatic and space HQ's include life support.

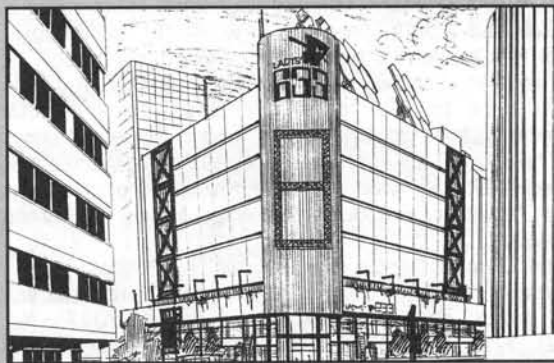

EXAMPLE HQs

LADYS633: Looks to be approximately 711 square meters; has 7 floors, plus garage and rooftop penthouse; 711 x9 = 6400; that's about 53CP (and Kills). There doesn't seem to be any extra armor on the building. Communication suite add 5CP. A few secret accessways adds 3CP, a POW-9 computer adds 11CP, and Mecha Facilities for the Knight Wing add 1CP. Total: 75CP.

RAVEN'S GARAGE: Looks to be approximately 15 meters on a side, for 225 square meters, and it definitely has a secret basement; that's about 450 square meters, or 14CP (and Kills). The building looks pretty solid, so we add 25KD to 15KD to get 40KD: That's 3.5CP. A few secret accessways add 3CP, a POW-6 computer adds 5 CP, and it has one regular mechanic's shop (+1 TECH, 2CP) and one amazing shop below for the Knight Sabers' use (+3 TECH, 11CP). Its location (Timex City, in the fault zone) is similar to being in the 'burbs, so that adds +5CP as well. Total: 43.5CP.

EXPANDED CHARACTER TEMPLATES

AD POLICE CHARACTER TEMPLATES

This and the next page each offer six templates providing guidelines for creating additional characters in both the 2020's and 2030's. Feel free to combine templates together!



AD Police Frontline Officer

Description: You're out there in tactical armor, shielding the citizens from the worst craziness the 21st century can vomit up.

Rioters, terrorists, cyberdroids, mercenaries, boomeroids—the rules keep changing and the boomers keep getting tougher and madder. The only thing you can rely on is your squad mates. Look out for them and they'll do the same for you.

Skills: Athletics, Autofire Weapons, Driving, Firearms, Hand-to-Hand, Heavy Weapons, Melee Weapons. Officers transferred from Normal Police may have Detective skill.

Options: Combat Sense, Membership (AD Police).

Equipment: ADP armor (by period) or Fatigues (KD 15), ADP Combat Handgun, M-42A1 Short MG (or 12-Gauge Pump Shotgun), Radio (10 km), Gasmask (8 minutes air), Dogtags, Boomer Deactivator, Police Baton (or Knife). See p. 32 for 2027 equipment; and see *BGC* p.121 for 2032-3 equipment, and p. 90 for 2034 equipment. Average lifestyle (Wealth 1) with tiny apartment in Residential Zone.



AD Police Pilot

Description: You pilot a state-of-the-art tactical chopper and see more air-to-ground action in a month than the Army does in a

year. Combat maneuvers in the city demand steel nerves and exceptional reflexes, as you weave around skyscrapers and power lines and fly under overpasses. You're the eyes and claws of the AD Police, but it's 20mm tag in the urban jungle—can you spot the boomer before he slags you?

Skills: Athletics, Electronic Warfare, Firearms, Gunnery, Navigation, Perception, Pilot (Helicopter).

Options: Combat Sense, License (Pilot), Membership (AD Police)

Equipment: Pilot's helmet (KD20, equipped with low-light, telescopic and targeting optics), dogtags, flight suit (KD 10), ADP issue handgun, Radio (10 km). Assigned to either Firebee, Combat Chopper, Hornet, Heavy Chopper or ADP Transporter. Average lifestyle (Wealth 1) with tiny apartment in Residential Zone.



AD Police Mecha Pilot

Description: You're one of the elite of the Frontline Officers, assigned to operate the ADP's precious few Kumo battlemovers and/or K-suits. As the police don't have many mecha, you often work on your own or with a single partner. You're the cavalry sent to face down the unstoppable—military boomers, stolen battlemovers or worse. All too often you won't have any backup, because everything else has been reduced to burning wreckage by the time you parachute in!

Skills: Athletics, Gunnery, Firearms, Heavy Equipment, Mechapilot.

Options: Combat Sense, Membership (AD Police).

Equipment: Skintight mecha pilot bodysuit (KD 10) worn under armor; dogtags. Assigned to Kumo (2027), K-11 (2032), K-12 (2033) or K-17 (2034). Average lifestyle (Wealth 1) with tiny apartment in Residential Zone.



AD Police Operator

Description: Your main job is to act as a police dispatcher; you also perform data searches and handle paperwork like arrest

reports. However, the ADP is short on people-power, so you may find yourself rerouting angry commuters around a boomer incident, borrowed by an inspector as his assistant during a field investigation, asked to assist in cracking into secret databases to hunt down vital information, or acting as a chaperon for visiting VIP's and members of the press.

Skills: Computers, Driving, Electronic Warfare, Hacking, Firearms (at low level), Language (Computer Code), Local Knowledge (MegaTokyo), Persuasion, Research, Writing.

Options: Membership (AD Police).

Equipment: Police uniform, pocket computer (POW-1), average lifestyle (Wealth 1) with tiny apartment, minicar or scooter.



Normal Police Detective

Description: Whether it's stopping Yakuza gun trafficking or hunting for a serial killer, it's time someone showed the guys at AD

Police there are other ways to solve crimes than with automatic weapons and armored vehicles. Even a boomer on the rampage is only a symptom—half the time, it's the people making or owning it who are the criminals. Normal Police may be short on manpower and starved for resources, but there are still some good detectives there, and you're one of the best.

Skills: Computers, Detective, Driving, Firearms, Law, Local Knowledge (MegaTokyo), Perception, Persuasion, Photography.

Options: Contact, and maybe Intuition.

Equipment: Police uniform with bulletproof vest (KD 10), normal police handgun, one reload in belt, nightstick, pocket computer (POW-1), car. Sometimes camera (for surveillance). Average lifestyle (Wealth 1) with small apartment.



K-9 Officer

Description: You're assigned to the Normal Police's K-9 section. Your partner (and maybe your best friend) is a bloodhound, Doberman

or a German shepherd, but a lot of police dogs are genengineered for near-human intelligence, and some of 'em are even cyborgs or boomers. You and your faithful hound will assist in arrests, drug and weapons busts, and hunts for fugitives. Your furry friend can sniff out drugs, criminals, explosives, disguised boomers, and buried bodies—it's your job to show him where to sniff, follow his lead, and keep him safe.

Skills: Animal Handling, Driving, Firearms, Local Knowledge (MegaTokyo), Perception, Persuasion.

Options: Membership (AD Police), Animal Empathy.

Equipment: Police dog (typically INT 0, PRE 2, TECH 0, MOVE 9, REF 5, DEX 5, STR 3, CON 4, BOD 2, Perception +10, Tracking+10, Athletics+4, Hand-to-Hand +4; bite 3D6). Some dogs are issued with a light kevlar vest (KD 8).

Your other gear is as Normal Police Officer. You have average wealth with a small apartment.



EXPANDED CHARACTER TEMPLATES CONTINUED



Outlaw Biker

Description: You're a teenage biker, *bosozoku*, one of the "reckless driving tribes" of motorcycle outlaws. You live for the rev of engines, your fierce pride in your gang, and the rush of adrenaline as you outrun the howling klaxons of the Highway Patrol and make rival gangs eat your dust. But the burning highways are getting deadlier every night—rampaging boomers, AD Police, even cybermonsters! Do you still run with the pack, or are you their last survivor, a lone wolf thirsting for revenge?

Skills: Basic Tech, Driving (Motorcycle), Hand-to-Hand, Melee Weapons, Survival (City).

Options: Knack (Driving); Membership (gang); Contact (with a street tech); Rapid Healing.

Equipment: Motorcycle, motorcycling leathers (KD 10), knife or chain. Poor lifestyle (slums, old trailer, etc.).



Confidential Courier

Description: You specialize in high-speed package deliveries, security and confidentiality guaranteed, often using your own specially souped-up and well-armed vehicle. Whether the cargo's ransom money, secret boomer parts, a memory upload unit, human organs, a powered suit, a new drug, a prized scientist, or even a garlic pizza, you'll make the run—for a price.

Skills: Basic Tech, Business, Driving (or maybe Piloting, Mechapilot or Shiphandling), Firearms, Navigation, Stealth.

Options: Renown; High Pain Threshold; Knack (Driving or Piloting); Contacts (potential employers, like corps or criminal organizations).

Equipment: Some kind of souped-up vehicle for the urban environment—often a car, truck, helicopter, or aerodyne, with concealed smuggling compartment. Combat magnum, KD 15 armored clothes. Good lifestyle (Wealth 3) with big garage.



Private Eye

Description: When people have problems they don't want to tell the police about, or have cases the cops dropped because of corporate pressure, they talk to you instead. Divorce cases where one partner's dating a sexaroid, execs worried their second-in-command's plotting against them, corps trying to find the secret identity of vigilantes, parents whose kid has run away to Paradise Loop—it's a crazy town, but at least you aren't short of work.

Skills: Computers, Detective, Driving, Firearms, Hacking, Local Knowledge (MegaTokyo), Perception, Persuasion, Photography, Stealth.

Options: Contacts, Intuition, PI's License.

Equipment: Trenchcoat, bugging devices, handgun, sedan, computer (POW 3-4), video camera. Average lifestyle (Wealth 1) with small apartment.



Civilian ADP Scientist

Description: You've persuaded the government to give you funding to field-test your newest inventions under real-life combat conditions. Now you've got a neat lab on the ADP HQ's fourteenth floor, where you develop or modify mecha, cybernetics or weapons for Frontline Officer service. Of course, sometimes there are a few bugs, but that's what beta-testing's for, right?

Skills: Education, Science (specify), High Tech, Basic Tech, MilSpec Tech.

Options: Membership (corporation or university), Reputation.

Equipment: White labcoat, pocket computer (POW-2). High lifestyle with state-of-the-art lab in ADP HQ.



Radical

Description: You may be an environmental activist, or opposed to animal experiments, capitalism, government corruption, or losing jobs to boomers. Maybe you want an end to weapons research, or freedom for artificial intelligences. Whatever the cause, you know your enemy: Genom! Perhaps you started out with peaceful demonstrations, but police and corporate harassment have driven you underground, turning your movement more radical. Some may call you a terrorist, but you know your cause is just, and that you only punish the guilty!

Skills: Demolitions, Education, Hacking, Persuasion, Stealth.

Options: Contacts (media, universities).

Equipment: Wealth 0 (slum apartment).



Boomer Psychologist

Description: As a "cyber-psychologist" specializing in artificial intelligences, you've devoted your life to studying the mental behavior of boomers. You might be a professor at a university, a researcher at Genom, or maybe even a grad student—perhaps the AD Police hired you to help them predict the behavior of runaway boomers. With boomer rampages becoming increasingly common in society, it's obvious that something's gone wrong—but is it with boomers themselves, or is it the way humans treat them? Clearly more study is needed, and you're just the person to do it! Of course, doing interviews with "wild" boomers is a little risky. Don't forget to bring that railgun, just in case—maybe you can apply for a Purple Heart along with your Nobel Prize? And Genom might not like you publishing some of your findings

Skills: Basic Tech, Computers, Education, High Tech, Psychology, Perception, Research, Superscience.

Options: Membership (university or corporation).

Equipment: Casual clothes, scooter or car, pocket mini-computer (POW-1). Wealth varies from poor (struggling student on summer job) to good (Wealth 2, tenured professor or corporate consultant).

MEGACRISIS

"Megacrisis" is a multi part, trans decade adventure, provided here for those referees who'd like a bridge between the eras of *AD Police*, *Bubblegum Crisis*, and *Bubblegum Crash!*. The adventure's parts are connected somewhat loosely, so that they can be used even if the players switch from being an AD Police team to becoming a Hi-Tech Vigilante group.

▼EPISODE 1: THIRTY PIECES OF SILVER

The Megacrisis begins in 2027, during the events of *ADP 2: The Ripper*. Players are assumed to be an AD Police squad (inspectors or frontline officers) in MegaTokyo; if the referee already has an AD Police campaign in another city, they should have been temporarily assigned to MegaTokyo as part of an officer-exchange program to learn the latest in ADP techniques.

This episode explores loose ends in the *ADP 2: The Ripper*: What was the purpose of the Salariman Boomer the ADP encountered, and why was someone as influential as the president of Green Food Corporation (Caroline Evers) unable to persuade the Cybernetics Bank to help her?

THE PLOT: In 2027, Caroline Evers was suffering from severe boomer syndrome. In a moment of lucidity, she realized the seriousness of her problem and made an appointment to visit the Cybernetics Bank of MegaTokyo to discuss getting her cybernetics removed. However, not everyone was as concerned for her health as she was. Kenichi Aramaki, vice president in charge of Green Security, coveted her position as president. Aramaki had been content to simply observe Ms. Evers' downward slide, but once she became intent on seeking help, he decided to accelerate it. Knowing Evers' appointment was scheduled for later in the week, Aramaki sent one of his top security agents ("Mr. Greenshades") to the Cybernetics Bank, intending to bribe and/or intimidate the doctors assigned to Ms. Evers' case into recommending against treatment. One of them, Ivan West, gave in. The other, Takashi Koga, was tempted, then suffered an attack of conscience.

Fearing refusal would put his own life (or his daughter's) into danger, Koga went looking for a boomer bodyguard. Unfortunately, he first made the mistake of trying to talk Dr. West out of dealing with Greenshades. West pretended to agree, then secretly informed Mr. Greenshades of Koga's plans. Alerted, the agent had Dr. Koga followed; upon discovering the underground shop he intended to buy the boomer at, he paid the street tech a visit. By greasing his palm, Greenshades persuaded the tech to make sure Koga would buy a particular combat boomer which Greenshades had provided. When Koga came to pick up his bodyguard, the tech sold him Greenshades' boomer, which had a remote-activated device that would shock the boomer's brain upon radio command, driving it berserk, then burning it out.

Mr. Greenshades made sure that Koga would buy the sabotaged boomer by paying the tech the boomer's full price and insisting that he sell it to Koga for an incredible bargain. The street technician was happy to accommodate both his customers' requests: It was when the sabotaged Salariman Boomer inevitably went berserk that the AD Police—and the players—took notice.

▼BOOMER RAMPAGE! HOOK: MURDER (OR MONSTER)

7.20 PM, the ADP squadroom. The players are on duty when a quiet Thursday night is shattered by an alert: "Boomer incident in progress, Yuna Building, District 3!"

On the way, they can listen to the data operator's live tape of the emergency call; loud music plays in the background:

Caller (girl's voice): "Hello? Hello?"

Dispatcher: "AD Police."

Caller: "Our boomer's hurting daddy!" (Crash!)

Data Operator: "Okay—what's your address?"

Caller: "The Yuna Building, Apartment 12-G—I'm in the bedroom and it's hurting him! Oh, Daddy! Hurry!"

Data Operator: "On the way, honey. Hide under the bed, okay? Now what type of boomer is—"

Caller: "It's breaking down the door—eek!"

ARRIVAL: The Yuna Building is a few minutes from ADP Headquarters. It's a high-rise condominium on a busy street surrounded by other buildings. The players are the only squad available, but an ADP combat chopper is hovering outside.

The building superintendent will notice the ADP vehicles and run to meet them—he called Normal Police when tenants reported sounds of a fight on the 12th floor. If the players reveal the incident's in 12-G, he knows it's a two-bedroom apartment inhabited by a Dr. Takashi Koga and his eleven-year old daughter Arcadia. They have a boomer? He smiles. "Yep. Sexy little domestic android. Green hair, elfin face—you're telling me she's gone crazy?"

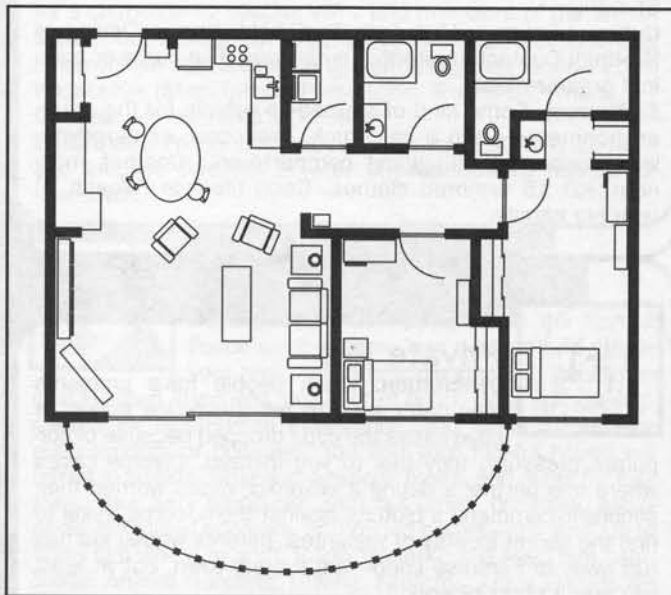

There are 4 ways to enter the apartment: The front door, balcony and two windows. The super knows the plan of the apartment: Both of 12-G's windows and the balcony are on the building's south wall.

If the players ask the helicopter to check, the balcony is clear, while the blinds on the balcony door and the balcony window are closed. The other window's blinds are open. From the 12th floor corridor (or the bal-



cony) listeners can hear smashing glass and wood, stomping feet, and loud pop music—the latest hit, "Cyberwolf", by the Howlers.

BATTLE: The living room's lush white carpet is splattered with blood and the dinner table's overturned. A CD player is blaring on a shelf. A man with brown hair, wearing a gray business suit, is boogieing to the CD player's beat, a weakly struggling girl held tight in his crushing embrace. She's gasping for breath, her face battered, one eye swollen shut. In the larger bedroom a man wearing a bathrobe has been shoved head-first into a television set tube—it's still sparking.

The man is the Salariman Boomer (p.40). His captive is the eleven-year old Arcadia. The boomer's totally insane, suffering from conflicting impulses to "protect" and "kill." When it sees armed opponents, it will revert to berserk rage, but in a wild rather than intelligent fashion, e.g., tucking Arcadia under his arm to bash with the CD player, or grabbing someone to toss him out the window (a last minute Athletics roll to grab the balcony if this happens). If the boomer loses a third or more of its SDP, it will flee—right into the guns of the chopper. PC's should try to grab Arcadia, or make it drop her; if the PC's are careless with "friendly fire", the Referee shouldn't kill Arcadia (she's important later on), but she could be wounded.

REFEREE NOTE: If the Referee cares about continuity, the players' actions (or the boomer's madness) should lead to it dropping Arcadia and leaping through the window onto the balcony to escape, then bouncing up to a nearby roof. Thus exposed, the ADP combat chopper can open fire, shredding it, where it will fall onto the car of the arriving Leon and Jeena and be finished off by a shot from Leon's pistol. While the players won't have made the kill, they'll have done the hard work of flushing out the boomer and saving Arcadia's life.

AFTERMATH: The boomer is scrap, but the players should have driven it out without severe casualties. Ideally, it will fly away, to be engaged by Leon and Jeena as seen in *ADP2*. Arcadia has cracked ribs and internal injuries (plus any damage they inflicted) and needs immediate hospitalization—she'll pass out right after being rescued. The man stuffed into the TV is dead. He can be identified by the superintendent as Dr. Takashi Koga.

▼ INVESTIGATING KOGA

DEVELOPMENT: CLUE/PUZZLE

Much of the AD Police's resources are tied up in high-profile investigation to track down "The Ripper." The players have a different assignment: find out why a combat boomer was in an upscale condo in downtown MegaTokyo.

Records show the deceased was 33, a widower, with one daughter. He worked at the Cybernetics Bank of MegaTokyo. Two years ago he registered the purchase of a B-type *domestic* boomer—but that was a female model, and it wasn't armed.

KOGA'S APARTMENT: Now mostly kindling, but nothing unusual. A search will find a *kawaii* plush panda and a framed photo of Arcadia, in a gymnastics uniform, looking very serious as she prepares to execute a difficult maneuver.

VISITING ARCADIA: She's at MegaTokyo General Hospital, on life support. She's a pitiful sight: lying still in bed, with an IV drip, bandages around her chest and a patch over one eye. The boomer's manhandling cracked two vertebrae and three ribs; she may also lose an eye or be paralyzed. She has no living relatives: Mother died in the Tokyo Quake, so they're trying to reach some grandparents, but they're living in another country. Arcadia's comatose, and may or may not wake up.



FORENSICS: The boomer's remains are in the ADP forensic lab. An "autopsy" can be attended (or performed) by the players. It's a Genom-produced male secretarial android, but upgraded with power boosters and illegal weapons. Most puzzling, though: The boomer has a small burn spot in its brain. It looks like some implanted device functioned at high power, then melted.

CYBERNETICS BANK: Players may want to talk with Koga's co-workers. Players may visit the Cybernetics Bank and question the other staff members; they've all heard of his tragic death. But was there anything strange about Takashi Koga?

The portly, 40-ish Dr. Ivan West is chief physician at Cybernetics Bank of MegaTokyo, and Koga's immediate superior. He's busy: Koga's death has meant taking on his fellow doctor's patient load. However, he'll take time to talk to the officers; what he'll say is pretty much the same as they get from everyone else:

- Takashi Koga was a pleasant individual, well liked by all, but a bit of an outsider. While a firm believer in the medical benefits of cybernetics, he was conservative when it came to prescribing cybernetics for minor problems or fashion.
- In the four or five days before his death, he'd been moody, skipping the golf games he usually played.
- Two days before he died, Koga replaced Lydia, his luscious green-haired female secretary android, with an ordinary brown-haired male android he named Percy. Asked why, he'd joked that Lydia had been distracting him. But his smile didn't reach his eyes. He took Percy home after work.
- Players may think to check Koga's appointment schedule. It's the usual mix of wannabee cyberpunks, with one exception: The well known president of Green Corporation, Ms. Caroline Evers, was scheduled to see him the day after he was killed. (If the players want to investigate Evers, they'll run into Leon and Iris Cara's surveillance operation—she's a suspect in the "Ripper" murder. If the players talk to Leon or Jeena, they'll get one opinion: "Evers sounds unstable—if I'd been her doctor, I might want an upgraded boomer around just in case. Anyway, we're handling this end. Why don't you figure out where Koga got that damn combat boomer?"

Two days after Koga's death, the players will learn that some of Dieork's 2nd AD Police Detachment have gone to Paradise Loop to terminate Caroline Evers and rescue a Normal Police detective she'd taken hostage. Afterward, they can share a few beers with Leon, Jeena, and co., toasting a successful case; the squadroom sentiment is, "For once, even a corporate president wasn't above the law." If the players waited that long before visiting the Cybernetics Bank, Caroline's identity will be public knowledge, and West will refer to



"that tragic incident with his former patient—no wonder Dr. Koga was frightened."

THE BOOMER UNDERGROUND: Koga seems to have traded a sexy domestic unit for a disguised combat boomer. The logical place to look for more leads are boomer recycling shops or cyberpunk hangouts, checking for places where the parts and skills for illegal combat upgrades are available. The referee can roleplay encounters with regular informers or contacts, if the players have any. Alternatively, every hour, roll an unopposed Local Knowledge or Detective + PRE roll for each group searching (unless the players split up, use only the best skill+stat total). Apply a -4 penalty if they aren't in plainclothes, or are otherwise making themselves conspicuous as cops. On a 12+, the players hear a rumor that "Adam's Links," in Shinjuku may be a place to check out for *serious* hardware. If the roll is 16+, they also hear that the owner, Jeremy Scarab, is a very bad boy, connected with a vicious gang of cyberpunks.

▼ ADAM LINKS

CLIFFHANGER: CONFRONTATION

The address is a multilevel parking lot in a seedy part of Shinjuku—six levels up, five down. In fact, 'Links is on the dimly lit fourth underground level (there's another ramp leading down). Amid the rusting cars, six parking spaces are occupied by a surplus Neo-NATO-issue modular barracks (looks like a mobile home, but 25 KD armor) covered in peeling camouflage paint. There's a front door, and it's unlocked. Snaking cables connect the trailer to a big gasohol generator. (Cutting the power would really annoy the owner.)

The interior is crammed with work tables, parts bins, and computer monitors. It smells of boomer lubricant and disinfectant. An overactive air conditioner throbs like a bad headache, lowering the temperature inside several degrees. A pair of bare electric bulbs hang from the ceiling. Chocolate cookie crumbs and broken glass crunch underfoot, but the work tables are immaculate. At the far end of the shop, a beetle-browed man wearing welder's goggles, heavy boots, baggy camo pants, and a flak jacket is slicing the legs off a labor boomer with a laser cutter, holding it down with one beefy hand. On a metal shelf, the nude torso and head of a sexy android girl with green hair and pointy ears is perched. In back of the place, there's a door marked "Toilet" with a biohazard sticker over it. (Inside is indeed the toilet, but also a combination-lock armored fridge containing ¥220,000, his beer supply, and illegal combat boomer components such as power-boosting systems and a disassembled mouth laser.)

JEREMY SCARAB (age 32)

Stats & Skills: INT 4, TECH 6, PRE 5, WILL 4, REF 4, DEX 5, STR 6, CON 4, BOD 6, MV 4. Athletics+4, Business+5, Tech+5, Firearms+5, Hand-to-Hand+4. Connection: cyberpunk gangs.

Cybernetics: Interface plugs (in forehead), Cyberaudio with Commlink, Pain Editor, right Cyberarm with realistic skin covering and concealed built-in combat magnum.

Equipment: KD 10 body armor, laser cutter.

Scarab has a thick Cockney accent. A former British soldier turned mercenary, he has now found his vocation as a street tech in MegaTokyo. He's done time in Abashiri Prison (six months, for looting cybernetics from bodies after the quake).

He has a C-class boomer license; he illegally recycles A- and B-class boomers, but his main business is recycling androids into combat models, which he sells to anyone who wants a bodyguard or

assassin. He has one source in Genom, a crooked Kawasaki plant manager who sells him rejected "factory second" combat boomer components that failed Genom's quality assurance tests. They work—sort of—but they aren't super-reliable.

Two days before Koga died, he visited Scarab and made a deal. Koga gave him Lydia (the cute boomer now on the shelf) in exchange for a promise to get him a combat boomer bodyguard disguised as a male secretary android. Scarab said it would take a day; Koga promised to return with ¥100,000. While Koga was away, Scarab was approached by a "Suit"—a man in green sunglasses and a business suit, whom he nicknamed Greenshades, who paid him ¥200,000 to sell Koga a sabotaged boomer.

▼ LYDIA

DEVELOPMENT: CLUE (that could turn into a Fight if the Neon Fists are involved)

Scarab is touchy and far too tough to easily intimidate. Faced with cops trying to intimidate or bust him, he'll hint he has major connections, and if they know what's good for them, they'll back off. If he's pushed, he'll use his commlink to call his allies (see below). He'll say the minimum necessary to save his life, but only after he's played all his cards.

However, he has one weak spot: Lydia.

LYDIA: The boomer has the same statistics as the Phantom Lady boomer (p.38), but her arms and legs are detached (Scarab removed them as stage one in his recycling effort; they're in a parts bin). Scarab also wiped her memory data when he purchased her—but he was testing her circuits when Mr. Greenshades dropped in. Here's her memory transcript:

Scarab: "So you want me to stick this little toy in Mr. Koga's boomer, huh? I wonder if you're the person he's so scared of. Oh—just a giggling thought, Mr. Greenshades—don't go trying something like this on me."

Mystery Man: "As long as you stay bought, you've got nothing to worry about. Your not planning on developing a conscience, are you?"

Scarab: "A what?"

Mystery Man: "Good. Glad we understand each other."

Lydia's useful memories are mostly audio-only; she was looking in a different direction, and couldn't move, so she only had occasional glances at the mystery man—although it is clear from the blurry glimpses of him crossing her vision that he wears green-tinted glasses. If the players start talking to her in the shop, she'll start to answer honestly, but Scarab will flip her "off" switch and tell the PC's to mind their own business. Of course, this could easily clue them in to Lydia's importance. Lydia doesn't care who owns her—but she *would* like her limbs back.

THE NEON FISTS: One reason Scarab is fairly confident is that on the next floor down in the garage is the clubhouse of the Neon Fists, a teenage cyberpunk gang. 5-15 (Ref's option) cyberpunks are hanging out one level down, in their own graffiti-splashed Army Surplus modular unit. Jeremy Scarab has a treaty with them—he gives them cheap cybertech, they offer him backup if he calls on his commlink. They can swarm up the ramp and surround his shop in five Phases, a nasty surprise to any street tech-intimidating cops!

The Neon Fists hate the police—especially the AD Police—for its anti-gang operations. If the events of "The Ripper" have concluded by this point, they'll want to avenge their brothers killed in Paradise Loop by ADP's train wreck. If they catch a cop, they'd be more interested in mutilation than murder.



NEON FIST CYBERPUNKS (age 16-19)

Stats & Skills: INT 2, TECH 3, PRE 3, WILL 3, REF 4, DEX 4, STR 3, CON 3, BOD 2, MV 4. Perception+3, Athletics+3, Hand-to-Hand+4, Melee Weapons+5.

Cybernetics: All have cyberoptics with infrared option (eyes are eerie red lenses). Half have finger blades or punch daggers; one has a cyberoptic video camera, which he'll use to film the fight scene for their video library.

Equipment: The Referee should decide. If heavy combat is called for, give 1/3 submachine guns, 1/3 combat revolvers and 1/3 swords. For more restrained mayhem, they'll use nunchuks and rippers, with 1/3 of them having concealed combat revolvers.

▼ARCADIA AWAKENS

CLIFFHANGER: CHASE/PURSUIT

The PC's receive a pager call from their ADP dispatcher. Arcadia Koga has recovered from her coma. She's still weak and her legs are paralyzed, but she is conscious, and she said she needs to talk to the AD Police officers.

In Arcadia's hospital room, the players encounter a man in a labcoat with short brown hair, a beard, and green-tinted glasses! He'll say to the players in a low voice: "I'm Dr. Giles. I'm afraid Arcadia's had a relapse, and needs to sleep quietly. Could you come back in a few hours?" Behind him, Arcadia is heavily bandaged, but her color looks better, and she is no longer attached to a life support machine. The doctor seemed to have been preparing a hypodermic needle when the players came in.

If the players aren't already suspicious, give them a Perception roll to recognize the "doctor's" voice from Lydia's memory data—it's "Mr. Greenshades" with a false beard! Whether the players are taken in or not, Arcadia will hear the conversation and wake up. Will the players be willing to start a tussle right there in the traumatized girl's hospital room, or will they try to maneuver "Dr. Giles" out into a safer area? Of course, this is a hospital—potential victims are *everywhere*...

However the players handle it, Greenshades will try to escape (the referee can have him tear off the false beard if he likes), bursting through the hospital ward. He has a sports car in the parking lot. He plans to head for the airport, leave Japan, and double back later. This is a good time for a dramatic chase, since players may want to refrain from gunplay in a hospital (and if not, whenever they miss the referee can have some innocent patient or staffer get shot). If cornered, he'll fight. The real Dr. Giles is drugged, in the closet.

MR GREENSHADES (an alias: real name unknown).

Stats & Skills: INT 6, TECH 5, PRE 7, WILL 8, REF 6, DEX 7, STR 4, CON 5, BODY 5, MV 7. Connections: Security operative. Athletics+5, Driving+4, Hand-to-Hand +3, Perception +5, Persuasion +7, Firearms +4, Stealth +5, Melee +4.

Equipment: Combat handgun (in cyberleg holster), hypo, disguise; sports car outside.

Cybernetics: Subdermal Armor • Pain Editor • Two Cyberlegs (one has a Hidden Holster) • right Cyberarm with Punch Daggers and Grapple Hand • Cyberaudio with CommLink & Scrambler • Fingerprints and retina prints altered by laser surgery; no entry in national database. • Implanted bomb in cortex. If captured (or injured and about to pass out) he'll smile, spit out some blood, and say, "Time to earn my pay." His head blows apart, doing 4D6 damage in a 2m radius.

▼ARCADIA'S STORY

CLIMAX: REVELATION.

Afterward, the players can resume their talk with Arcadia. She knows her dad is dead and the *real* doctors have said she may never walk again.

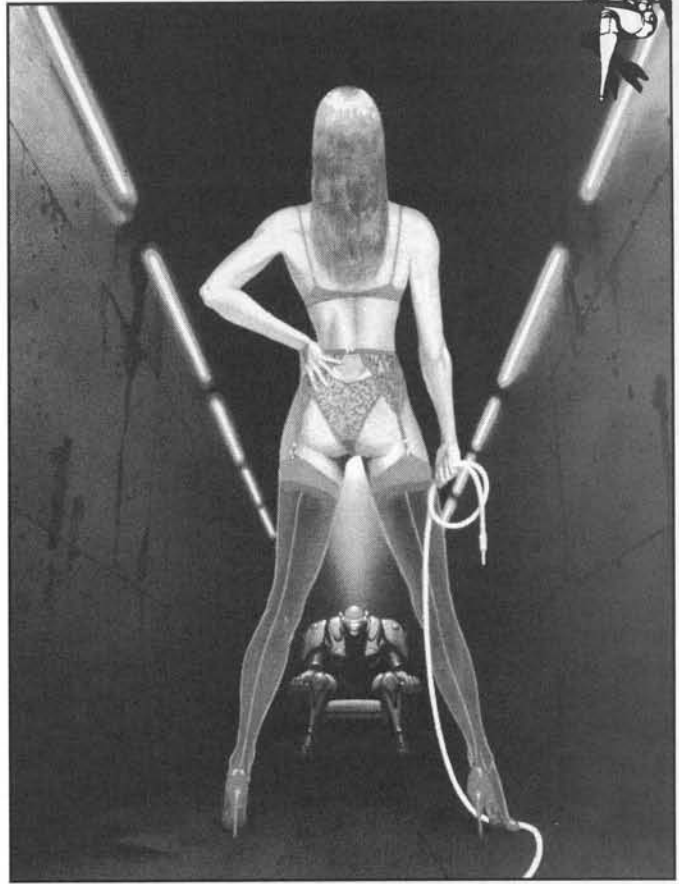

She's tearful, but angry—and she has something to tell them. This wasn't the first time she'd woken up to hear "Mr. Greenshades" voice.

Two days before her father died, he and another man were arguing, and the other spoke words she's engraved in her memory: "Please, Dr. Koga, humor me. When Caroline Evers comes to see you, tell her not to worry—there's no reason to remove her cybernetics. Go along with your boss, Dr. West. He's already aboard. In a few days, Evers' problems will solve themselves. Trust me." Arcadia smiles sweetly at the players. "My father said no. I was so proud. Next morning, he decided to get a new boomer—a stronger one, so anyone who tried to hurt us would get a surprise." Arcadia fixes the officers with her one remaining eye. "In school, on TV, they used to say boomers were our friends." She stares at them. "They never said they'd steal your dreams."

DR. WEST: Arcadia's hearsay evidence may not be enough to convict Dr. West alone, but it's enough to drag him down to the station. Already guilty at what happened to Arcadia and her father, a few days will probably see him confess to conspiracy to commit medical malpractice. But all he knows is that the man in green shades hired him...

▼THE DAY FRESH

RESOLUTION

Depending on events, the Ref could wrap up with this news story:

"Welcome to *The Day Fresh*. In our top story, Dr. Ivan West of the Cybernetics Bank of MegaTokyo was taken into custody, on charges relating to medical malpractice in the death of Caroline Evers aka. "The Ripper." In a related story, Green Food's board of directors elected vice president Kenichi Aramaki, head of Green Security, as the new president. Mr. Aramaki guaranteed he would do whatever it takes to restore the wholesome image of Green Food." ... "In the sky, or by the ocean, it's delicious everywhere you go"—Green Cereal!"



▼ EPISODE 2: VIRTUAL VENGEANCE

This chapter of “Megacrisis” is a *Bubblegum Crossfire* adventure set in 2033, perhaps in the last month of the year. It assumes that the PC’s have some contacts with the Knight Sabers. If the Ref used the *Bubblegum Crossfire* adventure in *BGC*, on p.167, they’ll know Nene, which is perfect.

▼ VIRTUAL FRIENDS

HOOK: KIDNAPING

The team is contacted by Nene—she’d like to hire them for some personal business. Since 2030, she’s been exchanging Netmail with a fellow computer hacker, Arcadia Koga, who lives in the players’ home city.

Arcadia was paralyzed and orphaned when her family boomer went berserk in 2027. Adopted by her grandmother, she moved to (the players’ home city). With her childhood dream of becoming an Olympic gymnast dashed, Nene says she become obsessed with discovering data that might lead to the people behind the “accident”, whom she suspects were executives in a power struggle at Green Food corporation. With six years of practice, Arcadia is very skilled in penetrating corporate databases; she and Nene regularly trade “icebreaker” programs, passwords, and so on. Arcadia hinted she sometimes sold data to various unnamed radical underground and anti-corporate groups, and used the funds to upgrade her computer systems to excellent hardware.

Three days ago, Arcadia sent Nene a gleeful message: She’d found something *big* that would hurt Green Corporation *and* Genom, in the right hands. (If the players know Nene is a Knight Saber, Nene says Arcadia doesn’t.) Worried Arcadia might get in over her head in dealing with Genom, Nene wrote back to be very careful—but Arcadia didn’t reply. It’s been nearly a week, and Nene is now worried—what if she hacked into Genom, and they traced her? As Arcadia lives in the players’ back yard, Nene would like them to check on her. Aside from having the world’s greatest computer hacker owe you a favor, any information Arcadia has usable against Genom would probably be very useful.

WHERE TO START? Arcadia never told Nene her street address, but that sort of thing is easy for Nene to find out. She lives in (street name in players’ city), in the suburbs. Unfortunately, her phone now seems to be disconnected.

RECORDS? Record searches the players may do on Arcadia reveal her grandmother, Yoko Koga, died a month ago, age 89, natural causes. Arcadia and her father Takashi may figure in a few MegaTokyo news items from 2027 (see previous adventure.) She has no other relatives.

▼ MOVING DAY

CLIFFHANGER: CONFRONTATION with Richter Sanction, which may turn into a Development: Alliance or Clue.

The address is on a quiet residential street. It’s a small two-story house, with a wheelchair ramp instead of stairs leading up to the porch. The front door is locked and no one answers. The windows are curtained; the back yard is empty and unkempt.

ARCADIA’S APARTMENT: The front door’s locked, but the back door’s unlocked; if the players check, they may notice the lock’s been picked (INT + Perception roll, difficulty 8).

The first floor (kitchen, dining room) is empty except for furniture and five big cardboard boxes filled with stuff—music CDs, stereo equipment, clothes, a plush panda, and, in the kitchen, a wired-togeth-

er stack of hardfax computer magazines. The second floor has two empty bedrooms, an old wheelchair with a broken axle... and also a burglar!

Dressed in black turtleneck and slacks, it’s tall, blond, and very Germanic UN spy Richter Sanction (*BGC* p.167). Ideally, he’ll be upstairs when the players enter, and come down the stairway, gun drawn, and surprise them, leading to a tense confrontation—Richter’s looking for terrorists, and is pretty jumpy. He has a combat Magnum (and Firearms +5) and his Special Police badge.

Richter was investigating a break-in at Mirmecoleon Chemical Industries, a subsidiary of Green Foods. Mirmecoleon is a leading supplier of pesticides, fungicides, and so on. Less publicly, it also makes chemical weapons for Neo-NATO stockpiles, although it isn’t supposed to in this country. However, a few days back Richter received a tipoff from an anonymous email source that the local Mirmecoleon Labs was engaged in illegal chemical weapons research on a “pseudo-organic micromachine chemical weapons agent” codenamed Leontophonus.

He investigated, but ran into a brick wall of security. Then, the next day, a truck from Mirmecoleon Labs was hijacked while it was on the way to the port. Richter figured that after he’d come nosing around, Mirmecoleon had tried to hide whatever they were working on—and someone had been waiting for the labs to do exactly that. Figuring both he and Mirmecoleon had been duped, he bent his efforts to tracking down the anonymous informant’s account, and discovered it originated at this address.

If the players get the drop on him and convince him they’re not the bad guys, he’ll talk. If they accidentally kill or maim him, he’ll gasp out his story and ask for their help anyway. If he gets the drop on *them* he’ll want to interrogate them: In the process, he’ll reveal what he’s looking for.

So, do the players want to know what a crippled girl with a mania for computer hacking might want with a secret biochemical weapon system?

NEXT-DOOR NEIGHBORS: Helen Winkler (age 52, retired stock broker) lives next door. Helen knew Arcadia and used to play mah jong with her grandmother. Yoko Koga passed away a few weeks ago; yesterday Arcadia moved away. Her “Uncle Brian” (whom Helen had never heard of) sent a car and driver to pick her up. When a curious Helen asked about him, Arcadia just sat in her powerchair and smiled, then told Helen to mind her own business. “She’s a moody, very private girl, poor thing. She’s like a hedgehog—you want to cuddle her, but she’s prickly if you got too close.” All Mrs. Winkler knows is that movers are supposed to return this evening to pick up Arcadia’s remaining things.

▼ MOVING VIOLATIONS

CLIFFHANGER: CONFRONTATION OR FIGHT, depending on the player’s actions.

The “moving van” arrives just after dusk. The driver, a big man with a ponytail and a beige suit, will park outside, then go to Arcadia’s apartment, and if unmolested, open the door with a key and begin loading her stuff. He’s strong enough to carry big boxes one-handed. If confronted, he’ll grunt that they should get of his way; if not, he’ll get rough.

He’s a BU-55C boomer working for “Uncle Brian.” He’s not very bright, and he’s not looking for a fight—but he’s ready to rough up anyone who gets in his way. If the players get too nosy, he’ll use brute force to beat them unconscious. He’ll only rip out of his skin if he’s faced with



hardsuits or heavy weaponry. If the boomer wins, he'll stuff a prisoner in the back of the van, tie him up, and take him back with him.

The smart thing to do is to hang back, then follow the van (he's not good at spotting tails) or try something clever like hiding inside the moving boxes. If so, the van will drive out of the suburbs to the city limits, where the (City Name) Hyperdome Stadium is located. On the other hand, if the players get into a fight and trash the boomer, they can't follow him. However, a search of the van's glove compartment turns up a wallet and driver's license (picture matches the boomer) in the name of John Hancock, and an ID pass that says he's a janitor at the stadium.

▼ THE HYPERDOME

DEVELOPMENT: RESCUE as the players pursue the boomer's van or rescue their friends (if captured). It can turn into a **CLIFFHANGER: BATTLE** if they attack the boomers.

This is a large city stadium. It's presently closed, pending renovations needed (damaged a few years ago in an anti-Genom riot). The players will know there are plans to build a fold-open dome for it next year, but construction hasn't begun. There's a billboard by the parking lot: "Genom Construction: The (players' city) Hyperdome, Future Site of the 2036 Olympics."

Entrances: The stadium has six entrances: Five lead to the bleachers; one is a vehicle entrance. All are locked, with "Closed: No Admittance" signs. If the players are following, the van will stop, the entrance door will slide open, and the boomer will drive through.

The Stadium: A football-field sized sports arena. A large electronic scoreboard overlooks the bleachers. Things to notice:

- On the bleachers, just below the scoreboard, there's a person in a security guard's outfit.
- A black tilt-rotor aircraft is parked on the playing field, its outline broken up by camouflage netting. There are a man and a woman in dark blue overalls unloading two canisters marked with a red "bio-hazard" symbol from a packing crate.
- Inside the stadium are four stairways marked "Authorized Personnel Only" and that lead into the area under the bleachers and beneath the stadium itself.

NOTES: The security guard and two workers are all boomers—they're all part of a cell of terrorists with whom Arcadia conspired to steal Leontophonus! Use the stats for "old model combat boomers" (*BGC* p.101) for the guard and the male worker, and a female combat boomer for the woman. They'll challenge any intruders—if the players look dangerous, they'll attack. Should stray shots hit them, don't worry—the canisters are armored and are quite sturdy. They have a small-print label on top, which says "Mirmecoleon Labs - Anti-Boomer BioWeapon - Leontophonus"! Well well well...

WHAT'S GOING ON: A few weeks ago, Arcadia discovered the secret of Leontophonus while she was hacking into a high-security Green Foods Corporation's database. Realizing that the bioweapon would be a useful bargaining chip, she went shopping for a radical anti-corporate group that would aid her in exchange for her information, and soon she found one...

What Arcadia doesn't know is that the boomers and "Uncle Brian" are a remnant cell of boomer terrorists created by Largo! On a mission overseas, they survived his "death" on the Genom tower in 2033 and are preparing for his resurrection (in 2034) by gathering intelligence and recruiting allies. Arcadia encountered their leader "Uncle Brian" on the Net. They realized that such a weapon could pose a serious threat to their "messiah's second coming", and agreed to join forces.



WHAT'S LEONTOPHONUS?

BACKGROUND:

In 2026, Mirmecoleon Labs, finding less and less demand for chemical weapons in a battlefield increasingly dominated by boomers, decided to try something new. After seven years and a hundred billion yen, they developed the "anti-boomer bioweapon" codenamed Leontophonus ("Lionsbane"). Having learned about this threat to their kind, the terrorists launched a massive hacking campaign and eventually succeeded in erasing all data on it. Now, they've just stolen the only samples in existence.

FUNCTIONING:

Leontophonus is a pseudo-organic nanomachine that mimics the action of mold spores, but much faster. Capable of infiltrating a boomer's body through air vents (used for cooling, not breathing) joints, and other weak points, it germinates within the body, eating away at optical cables, resin-based systems, and biological components. A boomer needs a TECH roll of 18+ for its internal diagnostic systems to resist the effects and counter it. Otherwise, the result is a loss of 1D6 DEX, REF, and INT. If DEX or REF go below 0, the boomer is paralyzed. If INT drops to 0, the boomer goes berserk. A canister of Leontophonus will spread over a 10m radius (more if carefully placed, as in a ventilation system, or in a strong wind); the spores die within five minutes of exposure to air—until then, boomers in the area must roll every minute to avoid exposure.

CURRENT STATUS:

Unfortunately for Green Corporation, Leontophonus' existence has been effectively erased by the terrorists' huge computer hacking operations (Arcadia played no small part in this herself). All that remains of the very *idea* are the two canisters that the terrorists now possess—they intend to fly them to a secure installation where they can dispose of the deadly (to them) biomaterials in a safe (to them) manner.



▼ UNDER THE STADIUM

DEVELOPMENT: REVELATION

There's a maze of concrete tunnels leading to various rooms. However, bright green directional arrows point to "Maintenance", "Storage", "Locker Rooms A-D", "Press Room," and "First Aid Center." Most of the rooms are empty, with nothing more than unused benches or stacks of folding chairs; many of the light bulbs in the corridors are burned out, so the tunnels are dimly lit. The exceptions are the Press Room, Locker Room D, and the adjoining storage area.

The Press Room contains Arcadia's personal kit—this amounts to a futon, a dresser, a computer, a picture of her father and her (at age 11), and even an old AD Police recruiting poster (for cops, they aren't so bad).

Locker Room D is dominated by two transparent tanks. In one, the body of Arcadia Koga floats, eyes open, within a bubbling solution of pink fluid. A medusa crown of cables snakes out from her skull to the roof of the tank, connecting to an impressive bank of computers and monitors and to a second tank next to it. That tank stands open and empty, its drained fluid only a pink stain on the floor, mute testament to whatever occupied it not too long ago. There's a side door at the back that leads into another room.

As the players are investigating, Arcadia's eyes will open, and she'll slowly look around. One of the monitors will come alive, revealing her face in close up, and Arcadia—voice coming from the monitor—will ask who they are. If they admit to working for Nene, she'll be friendly.

"This body is my new life," she'll tell them. "My devil's bargain—transferred into a boomer's body and the chance for revenge against my father's murderers." Then she'll try to move—and look puzzled. "I'm still paralyzed!" She wails piteously, "What's going on?"

A few moments later, the back door of the room opens. From the storeroom emerges a well groomed man in a tailored business suit. None of the players recognize him, but he has that classic "corporate shark" air about him...

▼ FUSION BOOMER!

CLIMAX: FINAL BATTLE

"Greetings, vigilantes. I am Arcadia's Uncle Brian." He glances malevolently at Arcadia. "A little stiff, Arcadia-chan? What a shame ... you see, it was easier to copy your mind than transfer it. Why should I let such a talented hacker as you go?" He gloats at the heartbroken girl. "Don't worry: Your new boomer body is doing fine—she's already gone, leaving you behind like so much trash. As for you vigilantes, it seems you're just a little too late—except to DIE!"

Unless the players want to chat some more, it's showtime! The "Uncle Brian" boomer is indeed the mastermind behind this terrorist cell: He's one of Largo's many " sleeper agents", a partial Brian J. Mason download inhabiting a fusion boomer body. Use the statistics of the Fusion Boomer (found in *BGC* on p. 110)—when combat is about to occur, it can burst out of its skin and begin fusing with whatever's nearby!

It will start by absorbing any of its boomer compatriots, then start growing hideously as it takes over the hyperdome! Cables will peel from the wall to attack the players, construction equipment will be absorbed into the seething mass ...

Referee Note: The idea here is that the players will be forced to use Leontophonus to stop the frightful boomer before it smothers them. Hopefully they'll be able to get back to the playing field and figure out how to open the canisters in time (INT + Tech roll vs 16) and

destroy the fusion-mass' brain! It's also important that the players use the bioweapon to destroy the fusion boomer because it would be unwise to let your players *keep* Leontophonus! After all, none of us really want the players to have the equivalent of "Raid" for boomers, do we? No, that'd be no fun at all ...

▼ TRANSITION

RESOLUTION

The players found Arcadia—but they've also lost her. She's dying—there was no way that poor Arcadia, paralyzed and trapped in a life-support tank, would have been able to escape the fusion boomer's destruction of the stadium. The Referee is advised to make sure that Arcadia gets mortally wounded somehow even if the players do their best to save her. If she survives, she'll be able to tell the players what she planned to do (that is, what Arcadia II is now planning to do), and that would ruin the third part of the adventure!

On top of the tragedy of Arcadia's death, there's also one canister of Leontophonus missing! The players will get a chance to realize this once they've defeated the fusion boomer—while they originally saw *two* canisters in the playing field, there was only *one* when they used Leontophonus to fight the fusion boomer.

So where is "Arcadia II" and the second canister? Well, the answer to that will come to light in the new year ...

▼ EPISODE 3: SINS OF THE FATHER

This is a high-tech vigilante adventure designed as a direct sequel to "Virtual Vengeance", taking place some months later. The players may have tried to track the Arcadia boomer down, but she seems to have gone underground. Green Foods and the UN have covered up Leontophonus. Their city seems peaceful, which means they're out of work ...

▼ HIT AND RUN

HOOK: CHASE/PURSUIT

One or two of the players are driving home late at night on a quiet stretch of highway, when about 100m ahead on an overpass, they see a high speed chase—a motorcycle doing about 120 kph, with two people trying to evade a big sedan that's playing "chicken" with it. Suddenly the sedan swerves sideways, sideswiping the cycle. The cycle tumbles out of control, the two riders thrown from it onto the asphalt. The sedan steps on the gas, accelerating away from the scene of the accident.

Both riders have Kevlar riding suits and helmets, so they're alive. One, a young man, is badly hurt. The other, a woman, is trying to get up—she takes her off her cracked riding helmet, tosses her green-streaked brown hair, and gives them a look at her famous face: It's Vision! She thanks the players, then notices her injured friend. "Bastards!" she curses, shaking her fist at the departing car. The players probably won't be able to catch the car, but if they try, the driver is a corporate thug with stats of 3, and Driving, Hand-to-Hand and Athletics at +4. He was sent to "deliver a message" to John Wu (the injured man).

The players should have stopped to help Vision. If so, after getting John to the hospital, Vision declines further medical attention (it's just bruises) and invites the players to her hotel, or, if they're in a hurry, arranges to contact them later.



▼ ANGRY VISION

DEVELOPMENT: ALLIANCE

Vision, Reika Chang, is angry. Eyes flashing, she says John Wu, a childhood friend, is an ecological activist and journalist. Wu's newspaper *SeaWatch* was trying to expose illegal driftnet fishing by Genom Corporation—the thugs that just ran them off the road were supposed to intimidate him into dropping the issue.

Wu had invited Vision to town to discuss the Revengers making a music video to publicize the cause. Vision was reluctant—until now. She isn't much into environmental activism, but she won't see a friend being pushed around. She'll cut to the point: She has "reason to believe" the players may "know" some vigilantes (the Chang Group has contacts with the Knight Sabers, who keep tabs on similar groups). Having dropped out of the vigilante business herself, she'd like to hire the players to teach Genom a lesson.

John Wu's been frustrated in his attempts to expose Genom because they crew their ships almost exclusively with labor boomers, who keep their mouths shut and also provide security. Now that Reika's met the players, she has an idea. The *Kikka Maru* is a Genom fishing vessel responsible (John says) for illegal driftnet tuna fishing that kills many sea turtles and dolphins. Reika would like to hire the players to board the ship, disable the boomer crew, then haul up the drift nets, and get dramatic video footage of the carnage wreaked at sea for use in news and her music video scene. If the players lack a boat or aircraft, Reika will provide a tilt-rotor. (She isn't using Hou Bang's resources—this is a personal grudge. If she involved her grandfather, it might escalate into a corporate war between the Chang Group and Genom.)

▼ ECO-MERCS

CLIFFHANGER: FIGHT

The *Kikka Maru* is a large fishing trawler, capable of 20 knots, designed to be operated by a crew of 6-12. Its deck has just enough room to land a small 'copter like Reika's. The players can discover these specs ahead of time if they do some computer research, or talk to John (recovering in the hospital). Reika and a bandaged John are willing to accompany them to fly the 'copter and take movies, but won't insist on doing so.

The day the players set out, it's misty, with light rain, moderate to low visibility, but calm seas. The low visibility will make it easier to avoid the Coast Guard or other vessels. With sensors, the *Kikka Maru* is located easily enough—its nets are deployed, and the players can see three boomers on deck.

Opposition: Four Ebisu-model Generic labor Boomers and two Construction Boomers. Half the boomers are on deck, operating nets and performing maintenance; the others are below decks. However, Genom has been worried about eco-activists nosing around their ships in port, and added additional security: a team of three armed boomers (use the statistics for Dr. Yuri's assassins) with assault rifles.

The players should be able to dispatch the boomers easily. When they haul up the nets, they get a surprise. Caught in the huge drift net, along with tuna, sea turtles, and a dolphin, is a young man! He's wearing a naval uniform, and has "Neo-NATO Combined Fleet" and "SASN *Silas Duncan*" patches.

▼ THE CATCH

DEVELOPMENT: PUZZLE/CLUE

The sailor's body is twitching, as if he's epileptic, and he's mumbling to himself. If the players get close, he says: "Help us—Neural nets



degrading—optic systems failure—pain/dysfunction—Captain Aramaki—losing control!"

Agonized, he suddenly clutches at his face, his fingers digging into his face! He rips his skull open, exposing his electronic brain—it's covered with blue-gray mold! He twitches once more, then collapses, completely dysfunctional.

Players may recognize the spores: Leontophonus! The victim is obviously an android; a Tech + High Tech skill roll of 8+ identifies him as a Genom-manufactured male equivalent of a "Boomer Woman" model.

Local players who make a Social + INT roll may remember seeing the christening ceremony of the *Silas Duncan* on the news last year. It was also notable because its captain, Toshimichi Aramaki, is the son of world-famous Green Food president Kenichi Aramaki. Players with military interests (or an online database) can identify the *Silas Duncan* as a 2,000 ton nuclear-powered Submersible Assault Ship. A new class, the radar and sonar-invisible SASN's mission is to covertly deploy SEALs, marines, and boomers for special ops.

If Reika is with the players, she'll suggest there might have been a shipwreck. Scanning the horizon with hardsuit sensors or high powered binoculars shows a flash of light to starboard. It's a morse code signal lamp. "MAYDAY... MAYDAY... MAYDAY..." Near-invisible in the sea and rain is a sleek gray submarine!

▼ THE SILAS DUNCAN

CLIFFHANGER: MONSTER

Once they get within about 200m, they'll see a dozen figures in orange life jackets swimming away from the submarine, shouting for help. Suddenly a deck hatch on the submarine opens, and a sailor staggers out drunkenly, then turns to face them and rips out of his skin! A laser beam arcs from his mouth to the life raft, blasting it to bits. The boomer's firing down into the sea, shooting the sailors!



Shouts turn into screams. This is a BU-55C, but with only half its REF, INT, and DEX.

▼TERROR AT SEA

DEVELOPMENT: WARNING/CLUE

After dealing with the boomer, the players can talk to the sailors. Many are wounded; all are chattering with cold and are frantic. There are men trapped in the submarine! And the ship's complement of boomers went berserk!! And the radios are wrecked!!!

"How could this happen?" the mortified sailors ask each other.

Last week, at port, some of the mechanics smuggled aboard a love doll they'd picked up second-hand at a junk shop. They'd done it before, you know? This time, Captain Aramaki discovered it during a surprise inspection. That's when things went weird—the 'doll made a break for it, and while they were hunting her, there was this weird smell in the air. Then the boomers in the assault bays started going crazy or dropping! The captain ordered the boat to surface, and they began abandoning ship. Did the 'doll have a name? "She wanted to be called Arcadia."

▼ARCADIAN MELTDOWN

CLIMAX: FIGHT

Most of the boomers aboard have collapsed, killed each other, or abandoned ship. There are bodies everywhere, wrecked equipment and half-dead, twitching boomers. Everything is covered by foam from fire extinguishers, and blood. As they perform a search of the ship, the players will find a young lieutenant in the control room. He's trapped under a console (STR roll vs 9 to lift) which is covered with blinking danger lights. Despite needing first aid, he begs them to leave him—the reactor is going critical!! It's in the bow of the ship, and Captain Aramaki himself went to activate the manual override. If it melts down, the entire ocean coastline could be contaminated!

Racing through the sub to reach the reactor, the players will encounter an assortment of boomers in various stages of madness and/or damage. There are several mannequin models and a few labor models—some will be wandering around the sub, wrecking things and clawing at their heads, or lying around in heaps, having either suffered total brain malfunction or been wrecked by other boomers. Once the players clear the last of the hatches and reach the bow, they'll find an Advanced Battle Boomer (see p.85) blocking their path. As soon as they come in, it'll attack them, but after a phase of combat, it will blow up—a second one has come behind it and destroyed it, and is now advancing on the PC's! Both boomers are damaged (half SDP, -15 KD armor, 1/2 REF, DEX, INT).

Once the players defeat the Battle Boomers, they're faced with a hatch which leads to the Outer Reactor Room. As they crawl through the hatches, they'll hear voices coming from ahead:

Desperate-sounding man: "Let me get to the reactor, you little fool! It'll blow in 50 seconds! Do you want to die?"

Arcadia: "Oh yes. When I was eleven, your father killed my father, Captain Aramaki. Now I'll return the favor, by taking his only son." She allows herself a slightly mad laugh. "It seems I went a little overboard, though. The messiah's influence, I suppose."

Entering the reactor room, the players find Captain Aramaki (a young, handsome fellow) and Arcadia. He's bruised, pinned against the control panel—she's behind him, wearing a black t-shirt and underwear (what she had on when discovered) and a respirator. She has a Member II pistol held at Aramaki's head. Behind them is the

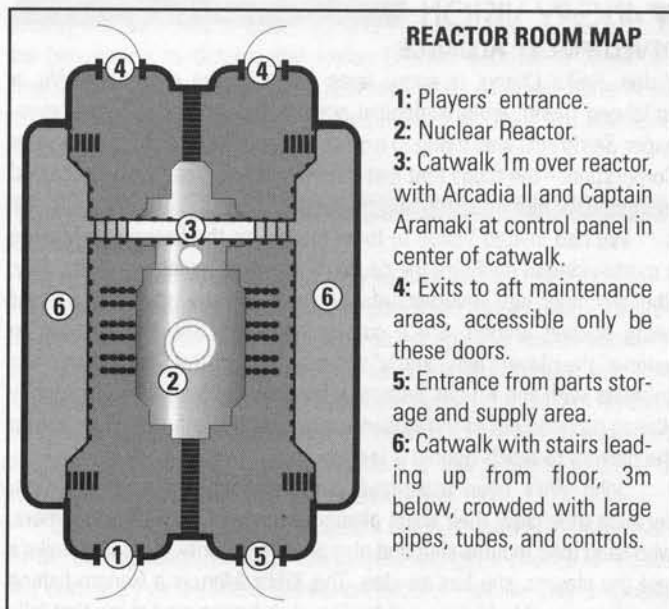

reactor override panel, clearly marked with "countdown to meltdown" indicators. Prudence (or Captain Aramaki) may suggest that using heavy weaponry will wreck the panel! There are "Danger - Reactor Room" signs everywhere, and a big hatch leading to another room, labeled "Reactor Coolant System - Radiation Hazard."

The Arcadia boomer is bitter, lonely, and obsessed with vengeance. Remember, she doesn't know the players: She left the stadium before they arrived, and is unaware that the Brian fusion boomer betrayed her original. The players can attempt to kill her (one option), but if she learns Nene and the players cared enough to try to "rescue" her, she'll be stunned and emotionally vulnerable. This is a good time to rescue the hostage; especially eloquent players may be able to persuade her to give up, and shut down the reactor.

Referee Note: Arcadia's sexaroid body has no open gaps through which she can be infected by Leontophonus except that, as a biomimetic android, she breathes and is thus vulnerable to inhaling the spores (hence the respirator, from the sub's firefighting locker). If it's removed, roll to see if the spores affect her.

For Aramaki, use JB Gibson's stats (*BGC* p.132), but replace his Driving skill with Leadership. For Arcadia, use the stats for Anri (*BGC* p.113) except that she has no Space Pilot skill, instead having Hacking at +9. The players can try to take Arcadia in hand-to-hand combat and then disarm the reactor (Milspec Tech roll of 16+); if that fails, or if the players use heavy weapons that also damage the console, it's jammed. Then the only way to stop a meltdown is to enter the radiation-flooded reactor core itself, risking 2D6 killing damage per phase (1D6/2 if hardsuited) to shut it off manually by pushing coolant rods into the core. This requires three STR rolls of 16+ (one allowed every phase). If the players fail to stop the meltdown, the reactor will blow in 20 phases, cracking the submarine in half, doing 10K to everyone inside, and contaminating beaches and sealife over hundreds of miles.

▼RESOLUTION

Provided the players succeed, they will have saved an incalculable number of lives, and on top of that Vision's environmental video will be a stunning success. They may also have an important new contact (Captain Aramaki) in Neo-NATO.

MECHA CONSTRUCTION IN MEKTON Z+

Since the release of the *Bubblegum Crisis* role-playing game, we here at R. Talsorian have been swamped with a virtual avalanche of requests for a mecha construction system for *BGC*. If one system were able to create all of the mecha in *BGC*—as well as new ones cooked up by our players' demented minds—it would fill an entire 144-page book by itself! As it turns out, R. Talsorian Games *does* have such a system, and it *does* take up an entire 144-page book. It's the mecha-construction system for our critically acclaimed anime mecha role-playing game *Mekton Zeta*, and it's called ...

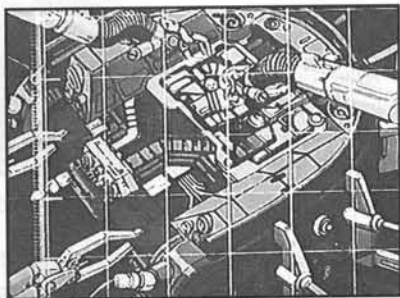

▼ MEKTON ZETA PLUS

"... the Laws of Mekton Physics ... were carefully chosen to strike the best balance between efficient system mechanics, emulation of Anime, believability, and satisfying game play."

—*Mekton Zeta Plus*, page 97.

Mekton Zeta Plus was published as the first supplement for our anime-style RPG, *Mekton Zeta*. Its rules set, the Mekton Technical System (or MTS) was created so that you could replicate absolutely any mecha from any anime you've ever seen—which means that it can also be used for any non-anime machines, from Hollywood spaceships to modern-day tanks. In addition, with MTS you can build any new machine you might dream up, from a hand-held switchblade to a planet-sized dreadnought.

In the next few pages, we'll show you how to build *BGC* mecha using *Mekton Zeta Plus* the same way we did. But before we do, let's get things in perspective: *BGC* has a lot of mecha. There are high-mobility units like Hardsuits, Powered Suits, and Battlemovers; vehicles covering the range from VTOL's to helicopters to sports cars; transformable machines such as Motorslaves ... not to mention a mind-boggling variety of Boomers, from nigh-undetectable androids to huge robotic monsters! For those who are familiar with both *BGC* and *Mekton Z*, it should come as no surprise that all of *BGC*'s mecha were built using MTS. After all, for a system such as MTS, building transforming motorcycles and sexy androids is no sweat! There are, however, a few catches:

1) *Mekton Zeta* isn't a Fuzion™-powered game like *BGC* is, so a few changes must be made to MTS in order to use it with *BGC*. Luckily, *MZ*'s system (the Interlock system) and Fuzion™ are so similar that the changes are quite minor.

2) In order to simulate *BGC*'s mecha as faithfully and accurately as possible, some rules needed to be tweaked—but fear not! One of MTS's rules is that you *can* change the rules, as long as you're consistent.

So, if you want a complete mecha construction system for the *Bubblegum Crisis* RPG, get yourself a copy of *Mekton Zeta Plus* (stock # MK 1402, \$18 SRP). Read the assorted changes discussed in the next pages, apply them when and where appropriate, and you're set!

▼ GENERAL SYSTEM NOTES

To begin with, let's look at the most basic principle of MTS's "operating system": **Construction Points**. In MTS, these are the cash with which you buy and build your mecha. The same is true in *BGC*, and their use in Fuzion™ is explained on p.32 of *BGC*. Next, let's look at Kills.

KILLS: This is a concept with which Fuzion™ players are already familiar, and the idea is the same in MTS. However, in MTS, one Kill represents 25 points of damage rather than 50. So remember to double the number of Hits (or SDP) your MTS design will have when using it in a Fuzion™ game like *BGC*. All damage is assumed to be Killing unless otherwise noted.

MOVEMENT: MTS uses 50-meter Hexes as its basic unit for measuring distance, and all mecha have an MA (Movement Allowance) Stat which tells them how many Hexes they can travel in a 10-second *Mekton Z* turn. Since a Fuzion™ turn (actually a Phase) is only 3 seconds, reduce the size of the Hexes to 15m. This means that 1 Hex of Land MA converts to 3 MOVE in Fuzion™ ... but only for MAs of 10 or less.

Why is this? Well, as *Mekton Z* says: "Movement Allowance is a game device; it is not a literal measure of speed. If anything, it is closer to a measure of acceleration, but as the only rating for speed in the game, we offer a formula to help players figure out how fast their mecha actually go" That formula is called the **Speedline formula**, and is as follows:

$$(((MA \div 10) \times 2) - 1) \times MA \times 11.2 = \text{speed in mph}$$

$$\text{-or- } (((MA \div 10) \times 2) - 1) \times MA \times 18 = \text{speed in kph}$$

This formula only applies to MAs of 11 or more. From 0-10, the formula is simply MA x18kph or x11.2mph. Here's an example of the Speedline formula: Starting with an MA of 16, we divide by 10 to get 1.6; 1.6 times 2 is 3.2; 3.2 minus 1 is 2.2; 2.2 times 16 is 35.2; 35.2 times 11.2 is 394.2 miles per hour. Presto! Okay, maybe not presto, but at least there aren't any square roots

Considering that your *BGC* mecha design will begin as an MTS mecha design, build it normally. Determine its MA, then use the Speedline to determine its actual speed.

Then, to find your mecha's **MOVE Stat** in Fuzion™, divide the MPH speed by 2 (or divide its KPH speed by 3). If you want to use the alternate MOVE rates listed on page 37, #5 of *BGC*, you may. Conveniently, 1 Surface Move = 16kph = 15m/yd (that is, 1 Hex) per Phase; 1 Flight Move = 160kph, 1 Space Move = 1600kph, etc.). For instance, an MA of 16 is 394kph; as per the table on p37 #5, that's a Surface Move of 25 in *BGC* (or a Flying Move of 3, if you prefer).

SCALING: This issue is particularly important to *BGC* because of the many different sizes and shapes of mecha seen in the videos—handguns, human-size Hardsuits, heavy Powered Suits, various sizes of Battlemovers, and vehicles as large as the





MANEUVER VALUE: Much like their special weight rules, the superior technology used in Hardsuits allows their MV to be raised above zero purely through Over- or Super-Charged Powerplants.

MOVE BONUS: A Hardsuit's bonus to its wearer's Move is based on the same number as the mecha design's Unscaled MA rating. Simply add the unscaled MA to the wearer's MOVE stat.

LASER GUN DAMAGE: The output of all Hardsuits' forearm laser guns is automatically adjustable from 1D6 of damage all the way up to the maximum, at no CP cost.

HARDSUIT IMPROVEMENTS: Each new group of Hardsuits is designed to be +33% stronger (and weigh 12% less through Weight Efficiency) than the previous group.

MOTORSLAVE TRANSFORMATION: All Motorslaves have three Transformation forms: Motorcycle (duh), Humanoid (motoroid), and Mecharider (for the motorslave form).

The best way to replicate the front wheel splitting into two hoverfans is to give the mecha two Wheels (one front, one back), and also apply the "Modular Metaform" Transformable Option: This will allow the front Wheel to become two Wing Servos, each with half the Kills of the Wheel. Place the Thrusters into the spaces provided by the Metaform wings, and you're set. If the front Wheel is destroyed, you lose the Wings and all Thrusters, and vice-versa: If a Wing is destroyed, so is the front Wheel.

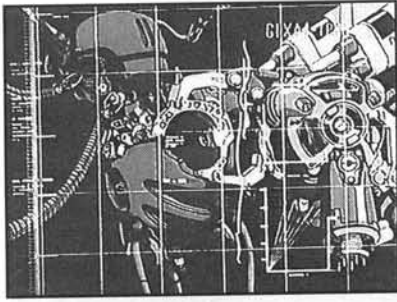

▼ MTS NOTES: POWERED SUITS

Powered Suits such as the K-11, K-12S, K-17, the Illegal Army's suits, and Mackie's Battlesuit are all 1/10th-Scale designs which (obviously) do not use Stingray technology. Therefore they do not use the Knight Sabers' special rules regarding Weight, Maneuver, etc.

PILOT SPACE: Powered Suits use the same rule as 1/5th-Scale mecha for the space taken up by the pilot (i.e., 1 BOD takes 1 Space).

MOVE STAT: While Hardsuits get to add their unscaled MA to the wearer's MOVE Stat (due to their superior technology), Powered Suits are more clunky and thus simply multiply their unscaled MA by 1.5 to determine their MOVE Stat.

▼ BOOMER NOTES

Boomers are a complicated kettle of fish. They often have organic components, can change their shape, and even display self-awareness. But that's OK, MTS can handle it. Just realize that while Boomers are built as mecha, they are treated more like characters. When you build a Boomer, Techno-Organics, Internal Automation and Thought Control are all bought, but their numerical values actually are not applied; self-repair rate is superseded by REC (below), and a Boomer's Stats are calculated from the Internal Automation rating. Read on:

BOOMER STATS (NON-PHYSICAL):

Most of a Boomer's stats are set by its AI rating, which is equal to the IA Level you purchase. Multiply the IA rating by 6—this gets you a pool of points which you can distribute among INT, TECH, PRE, WILL, REF, and DEX. All Boomer skills are equal to the IA level as well.

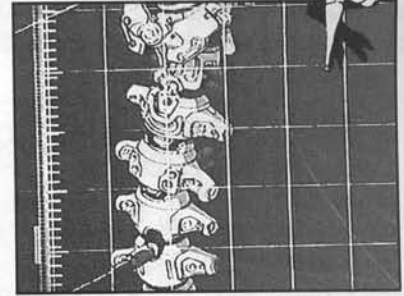

BOOMER STATS (PHYSICAL):

As we all know, Boomers are strong, fast and tough. A Boomer's **MOVE Stat** is the same as its unscaled 1:1 MA in Hexes, so if your 1:1-Scale mecha has an MA of 4, the 1:10-Scale Boomer's MOVE is 12 (MA x3, as discussed earlier). A Boomer's **STR** is based on servo ratings in the same way as per Hardsuits, but Boomers often have Heavy or Superheavy Hydraulics, which multiplies STR by 1.5 or 2.0. A Boomer's **BODY Stat** is equal to the number of unscaled Kills in its torso, with hits equalling scaled hits (50 per Kill, divided by 10) in the Torso servo. Boomers have no CON stat, so a Boomer's **RECOVERY** is calculated from STRx2; the number represents Hits (not stun, which Boomers don't have) which can be regained from a turn of rest/recovery (gotta love that regeneration system!) but not all Boomers can self-repair so fast. Thus, REC is listed as Hits/Turn OR Hits/Day; REC for Boomers is "per day" if the unit is a simple Techno-Organic, and REC is "per turn" for a Regenerating Techno-Organic design (i.e., a Combat-type, or any other with a "cloning" system).

SCALES:

Most Boomers are 1/10th Scale, but some Boomers are so large as to be actually 1/5th Scale; the Superboomer, Old Combat Boomer, BU-12B, Boomer Giant, and others are weight-inefficient 1/5th-Scale designs.

ANDROIDS:

Sexaroids and other Android-type Boomers use the 'Old Stupid Mekton Trick and thus are almost exactly the same as normal characters. They weigh 1kg per 1:1 ton, and they do have a CON Stat (equal to unmodified servo level) and Stun points; their REC is determined normally and regains Stun, not Hit points.

FUSION:

Boomer Fusion is bought using the Stupid Mekton Trick of Material Absorption, and it's expensive! Limited Fusion is as per the normal cost (x0.5), while Advanced costs ten times as much (x5.0); Unlimited costs one hundred times as much (x50.0)!!

A NOTE ON BOOMER FUSION: In the *BGC* RPG, it is assumed that some modicum of Fusion ability is an inherent part of Boomer nature and is especially prominent among Combat Boomers. Therefore, several Boomers that did not specifically display Fusion powers in the OVAs have Fusion ability in the RPG.

The only Boomers that actually *did* display Fusion ability on-screen (beyond disguise and self-repair functions) were the BU-55c, Miriam's Assault and Computer Boomers, the Fusion Boomer, Largo (in *Crash!* and *Crisis*, so the SuperBoomer probably had it too), the Viral Fusion Boomer, the cyborg Lando, and the three Largo Boomers.

If you don't want Fusion powers to be as common in your game, feel free to limit the ability to these boomers and any other purpose-built boomers you desire.



BOOMER DISGUISES: The “human skin” disguise which BU-55Cs are so eager to rip out of is simulated with MTS’s “Concealment” Transformable Option.

▼ BUILD EXAMPLE: HARDSUIT PRISS

In order to clarify the use of MTS in Fuzion™, here’s an example of the construction procedure using Priss’ Hardsuit from p.74 of the *BGC* RPG. We’ll follow the Design Flowchart from pp.16-17 of *Zeta Plus*.

1: Concept: Easy enough—Priss’ Hardsuit.

2: Frame: Body form will be humanoid. For Servo Level? Well, we know that Hardsuit Priss has an average strength amplification factor of x9.46, and Priss can lift 144kg. 144×9.46 is 1362kg, which is around the Lift value for a Fuzion™ STR of 9. Armored Heavy is the 9th Servo Level (STR Value is 9), so I chose Armored Heavy Servos: An AH Head, AH Torso, 2 AH Arms and 2 AH Legs comes out to 67CP and 33.5 tons. The suit has no wheels or treads, but it does have armor. I gave it armor equivalent to its Servo Level (a common and appropriate choice); that’s 6 locations with AH (SP9) Armor—but it has to be Gamma armor, since Hardsuits are fusion-proof, so that’s +108CP and +27 tons.

3: Weapons: Well, Priss’ suit has a Laser, a triple-Railgun array, and a powered manipulator (that is, a Hand). The damages done by these weapons was based on careful observation of the *BGC* videos; the Laser Beam was built as a Portfolio-2 Energy Pool (crammed into 5 Spaces through Space Efficiency) with a 15K Beam Weapon (Range 15) and a 8K Beam Weapon (Range 11) with a BV of 3 (because I wanted an ROF of 10). The Railgun was made as a single 10K Projectile Weapon (Range 10, Space 3 after Efficiency) with a BV of 2 to simulate the three serial-firing barrels, loaded with AP ammo (Space 0 after

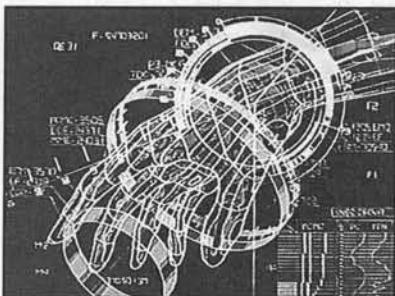

Efficiency). Since the hand has to do 9D6 after it is scaled (to match the suit’s STR of 9), it was built at 1:1 scale as a 6.5K Melee Weapon (Space 2 after Efficiency); 6.5K will scale down to 0.65K, and $0.65 \times 14D6$ (1 Kill) is roughly 9D6. After Space Efficiency, the total cost was +111.8CP and the total weight was +14.1 tons.

4: Shields: Nope.

5: Crew and Sensors: Since a Hardsuit is a 1/10th-Scale design, the crew takes no space (see p.108 of *Z+*). However, I chose a basic sensor suite, Lightweight class. That’s +1CP and +0.5 tons.

6: Other Additive Systems: An “Ejection Seat” system to blow off the armor (1CP, no spaces), Rank-6 ECCM in the helmet (12CP, +2 points of Space Efficiency for a total of 14CP and 8 Spaces), a Micromanipulator as the left hand’s glove (1 CP, 1 Space), a Quick-Change Mount for the right powerglove (1CP), and +1 Cool—or PREsence in Fuzion™—Stat Enhancement (0.5CP). That comes to +17.5CP and +0 tons.

7: Base Weight: Adding up all the tons, we get a grand total of 75.1 tons. Fuel rules aren’t used in *BGC*, so ignore that part.

8: Weight Efficiency: The base weight will eventually scale down to 75.1 kilograms, but Priss’ Hardsuit weighs a little less—74.35kg. This means 0.75 tons must be dropped, which will add +1.5C. We’ll hang on to this number until step 12. In the meantime, our final weight is 74.35 tons.

9: Flight System: Well, Priss’ Hardsuit can’t fly, but it does have jumpjets, and in MTS Jumpjets are defined as Thrusters with an MA of

less than 8. Priss seems to be able to pull off short flights of about 100 meters or so—that’s an MA of 2. Priss’ rocket verniers are in her back and hips, so we put the Thrusters in her Torso: That’s 5.6CP, no Space Efficiency needed.

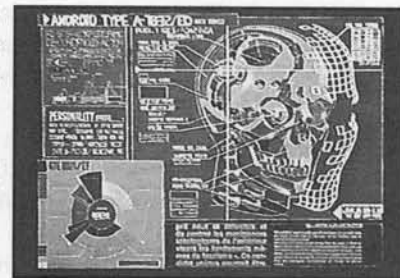

10: Base Cost: Adding up all of the costs so far (except for the Weight Efficiency) we get 310.9CP.

11: Multiplier Systems: Well, we know that the Hardsuits use 50-hour batteries, so the Powerplant’s Source is a Power Cell (-x0.15), but I wanted to Overcharge it (+x0.15) to increase the Land MA by +1, so the Powerplant comes out to x0.0 (since Hardsuits don’t seem to explode, we keep the ‘plant Cool). Next, Reflex-type Cockpit Controls, which costs x0.1. The Hydraulics are Standard. Now for Maneuver Verniers: The suit’s base MV is -7, +1 for the Overcharged Powerplant is -6. I want the MV to be -1, so that will be +5MV Maneuver Verniers, which will costs x0.5 and take 25 Spaces. I put 5 Spaces in the Torso and 10 in each Leg.

12: Multiplied Cost: As we know from Step 10, the Base Cost is 310.9CP. Adding all Multipliers together, I get x0.6; added to the base cost of the suit (x1.0), that’s a total Cost Multiplier of x1.6. 310.9×1.6 is 497.44CP. Adding in the Weight Efficiency cost from Step 8 (1.5CP), we get a total of 498.94CP.

13: Overview Mecha: Looks good to me.

14: Figure Stats: MV is -1; Land MA is 3 for the weight, +1 for the Overcharged Powerplant is 4; Flight MA is 2. Maneuver Pool for the Hardsuit is +67% (an optional device in *Bubblegum Crisis*).

15: Command Here: None.

16: Scaling: OK, we want this suit to be 1/10th-Scale. First, the weight scales from 74.35 tons to 74.35 kilograms. Next, we divide all Kills by 10: The 9SP of armor becomes 0.9K, the Helmet’s 9K becomes 0.9K, the Torso’s 18K becomes 1.8K, and each Limb’s 10K becomes 1.0K. The Laser Gun scales down to do 1.5K on Beam and 0.8K on Burst. The Railgun scales down to 1.0K. The Manipulator scales down to 0.65K. The Sensor Range gets cut in half, to 1km, and Communication Range gets cut by 50km, to 10km. Flight MA stays constant at 2-Hex jumps. Finally, the Cost is divided by 5, granting us a total of 99.8CP.

17: Remotes: None.

18: Wrap-Up: Now to convert the design to Fuzion™: The weight stays at 74.35 kilograms (although if this were *not* a Stingray design, it would be 743.5kg). Next, we convert all Kills to Damage Points, remembering that a Kill in Fuzion™ is 50 points and/or 14D6: The 0.9K of armor becomes 45 KD and is used as an all-over rating. Next, all of the Servos’ Kills are averaged: 0.9K (Helmet) +1.8K (Torso) +4.0K (1.0K for each limb) is 6.7K, and 6.7K divided by 6 (the number of Servos present) is 1.1K, or 55SDP. The Laser Gun’s 1.5K Beam becomes 21D6 and its 0.8K Burst becomes 11D6+1. The 1.0K Railgun becomes 14D6. The 0.65K Manipulator becomes 9D6, as appropriate to a STR 9 Hardsuit. Finally, the Cost is rounded to 100 Points, so that it’s easy to balance your character’s campaign expenditures. *Voila!*

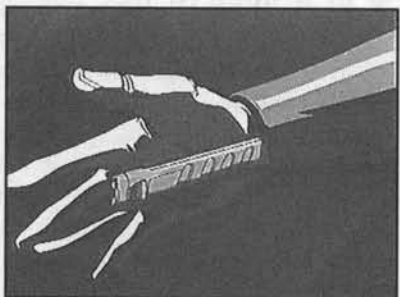

CONVERSIONS

Several people have asked how one converts characters back and forth between Fuzion™, the Hero system, and RTG's Interlock system (which is used for *Cyberpunk*, *CyberGeneration*, *Mekton Z*, and *Teenagers From Outer Space*). These were not put into BGC because it's a stand-alone game. Naturally, the 3rd edition of *Cyberpunk* will have conversion rules for 2.0.2.0., and *Champions: The New Millennium* has conversion rules for *Champions 4th Edition*, but BGC, being a stand-alone game, did not really demand such conversions—although we've certainly gotten enough demands for such!

One of the beautiful things about Fuzion™ is that it really is a "fusion" of Hero and Interlock. Therefore, almost all of the systems in either of those games will work in Fuzion™, and vice versa. In addition, you could use Fuzion™ as a "filter" for translating Interlock characters and game materials into the Hero system, and likewise for translating Hero characters and game materials into the Interlock system!

▼ CONVERSION NOTES

Well it seems that everyone wants to know about what changed between HERO 4th Edition and Fuzion™. We think most of you may be rather surprised at how similar the systems feel and operate. But in case you're wondering, here's a fast rundown of system changes between HERO 4th and FUZION. Note that * = *Cyberpunk* and *CyberGeneration*, while † = *Mekton Z* specific.



Fuzion™ points	Hero system	Interlock system
Character Points	Points ÷5	Character Points x1.0
Construction Points	Points ÷5	Construction Points x1.0†
Option Points (aka Campaign Points)	Points ÷2.5	Skill Points x1.0
Power Points	Points ÷5	(na)

Notes: We broke the total number of points into three smaller pools to eliminate character abuse. Now you have to ask to swap points from powers to Characteristics or other stuff.

Fuzion™ stats	Hero system	Interlock system
INTElligence	INTElligence ÷3	INTElligence x0.7 (round up)
WILLpower	EGO ÷3	COOL x0.7 (round up)
PREsence	PREsence ÷3	EMPathy x0.7 (round up)
TECHnique	(DEXterity +INTElligence) ÷6	TECHnique x0.7 (round up)
REFlexes	OCV x1.0	(pool of REFlexes x1.4; round up)
DEXterity	DEXterity ÷3	(pool of REFlexes x1.4; round up)
CONstitution	(PD+ED) ÷4 or CON/3 (whichever is higher)	{pool of BODY type x2.1; round up}
STRength	STRength ÷3 (÷5 for Supers)	{pool of BODY type x2.1; round up}
BODY	STUN ÷5	{pool of BODY type x2.1; round up}
MOVEment	Inches ÷1.5	Movement Allowance x0.7 (round up)

HERO Notes: Characteristics are the same as in HERO, except the following: Comeliness, Will, Tech, and Reflex. These are new, or replace older terms. Normals are now defined as 1-8 Characteristics which are ranged at roughly one third of Hero normal. They are all purchased at the same point-to-level ratio. The change in spread and the new classification allows "realistic humans" to span a far greater extent than before, because every point counts.

INTERLOCK Notes: Stats are the same as in INTERLOCK, except the following: Attractiveness, Will, Strength, Con and Reflex. Although a normal character was defined as 5-6 range in *Cyberpunk*, people interpreted "normal" as being a guy working in a 7-11 store rather than an adventurer! That meant too many people had 9's and 10's—entire parties were equivalent to the strongest and smartest people on Earth. Thus the new stat range. We broke REF into an Offensive component (REF) and a Defensive component (DEX), because having everything in one stat was leading to horrendous "combat monster" abuses. Trolling all combat and physical skills, players were just slamming points into two stats and making them idiotically high. Strength and Con were broken out of Body because characters with a high Body Type were strong, tough, and resistant all in one; a real game unbalancer. We dumped Attractiveness; it was a free point sump used to boost other stats to ridiculous levels. We changed Cool to Will and Empathy to Presence—not only for the HERO players to recognize, but because they were more applicable to more genres. Finally, Luck became a derived stat because too many players bought Luck up to substitute for their lack of points in INT, COOL, or EMP—it was a variable point pool, in effect.



Fuzion™ options & system

Hero system

Interlock system

Perk: Beautiful/Handsome	Each 7 levels of Comeliness over 10 = +1	Attractiveness -6 (if positive) = Level
Complication: Distinctive Features	Distinctive Features (Disadvantage)	Attractiveness -6 (if negative) x4 = Intensity
Skill Level	Familiarity = Level 1, base skill = Level 3, each extra level = +1 level.	Skill Level x1.0

HERO Notes: Fuzion™ allows you to use any skills you want. The current Generic List is a merger of Hero and Interlock lists. Also, the addition of Tech gives some of the skills a better related Characteristic. Old Hero Skills were rather compressed; three points was a huge jump. In Fuzion™, the range is wider, and more gradual, but each increase is roughly 10%. Skills are also more varied, which means that they will mean a lot more, especially in Heroic-Level campaigns.

Roll resolution is the biggest change of all. First, OCV in Fuzion™ is your REF (or DEX)+Combat Skill Level+Modifiers, just as in HERO. DCV is your DEX+Combat Skill levels+Modifiers, just as in HERO. So far so good. The big change is the position of the numbers. In Fuzion™, you add the die roll to your OCV. The defender adds 10 to his DCV (we tried to make it work with 11, but no dice). You subtract the total DCV from the total OCV and the highest total wins. If the totals are tied, the attacker wins. So why did we do this? Simple: 1) Less complex math. Just add and roll; 2) It allows you to use different skills and even Characteristics to determine your OCV; 3) It can also be used for any other resolution, including Perception and skill rolls, thus standardizing all resolution in HERO to one system instead of three.

Now here's the good part. To the player (you) the change in actual game play really is a lot less than you'd think. You still roll 3D6, add your OCV [made up of your Characteristic and Combat skill level] and try to beat 10+ your target's DCV. The only real change is that you try to roll over that number instead of under and the number changes to 10. That's it.

INTERLOCK Notes: Skills remain the same as in Interlock. The current Generic List is a merger of the Hero and Interlock lists. The lists vary depending on the genre, but they work exactly the same. We've also included the ability to create specialized offensive/defensive versions of some hand-to-hand skills. This makes aikido-ists more realistic, for example—you don't have to use these but they're there if you want them. Skill range is pretty much the same as before too. In general, we consider 10 to be the very best skill level Humanity can achieve. But if you're dealing with big-brained aliens from Alpha Centauri, they could theoretically have Physics Skills of 15 or 20.

For Interlock players, the mechanics of roll resolution is a no-brainer. The Universal Difficulty Table is an extended version of the Interlock Difficulty table; the values go up by 4's rather than 5's to accommodate the HERO side of the table, and go up ten more ranks to deal with super-powered characters. The matrix is based out of *Mekton*, not *Cyberpunk*; this is because with a Stat+Skill+Die Roll vs Stat+Skill+Die Roll equation, you can keep the playing field between two opposing players level. Don't be confused by the HERO option; you don't have to use it unless you want to.

Fuzion™ weapons & equipment

Hero system

Interlock system

Personal Armor KD	KD 1-50: KD = Resistant PD; KD51+: ((KD-50):15)+50 = Resistant PD.	SP x1.0
Other KD	As above, but = Resistant PD x2.5	SP x1.0*/x2.0†
SDP	Body x5	SDP x1.0*/x2.0†
KILLS	(na)	Kills x1.0†
Weapon Damage	DC x1.0	Damage +1D6*/Damage x1.5†
Rate of Fire	(na)	ROF x1.5*/see p.122 col.2 of this book†
WA (Weapon Accuracy)	OCV Mod x1.0	Weapon Accuracy x1.0
EV (Encumbrance Value)	(na)	Encumbrance Value x1.0
Vehicle Speed	(na)	MA of Mektons; See p.121 col.2 of this book†

HERO Notes: The big change regarding damage is that Killing Damage is now on the same scale as "Normal" damage. We compensated by raising your overall "Hit points" to match (see below). This makes it easier to track damage and allows Heroes to use weapons from other systems more easily. The other big change is that STR now is 1 to 1 with your punching DC. In the old system, you gained DC for every 5 points of STR. Compressing STR by 5 to fit into the Fuzion™ system meant that DC compressed as well. Besides, it's easy to remember one Point of STR=1 die of damage.

Since we brought Killing damage onto the same scale as "Normal" damage, we had to increase BODY—this was done by creating HITS—equal to 5x your BODY, which made up the needed BODY ratio to the new Killing damage. You no longer take BODY damage; you take HITS instead. Think of Hits as being a derived number just like STUN.

Also, collateral Stun from Killing used to be the stun lottery! In HERO, you multiplied BODY done by 1D6-1 (average is 2.5). In Fuzion™, Killing Attacks are on the same basic scale as other attacks. The amount of Killing Damage (Hits) you can take has been increased (see below). You still take 1 Stun for each Hit that gets past your defenses.

INTERLOCK Notes: The biggest difference in damage is that we carried over the idea of Damage Classes from both HERO and *Dream Park*. This is because we needed a generic measure of damage to get guns, blasters, fireballs and so on on the same scale. We also eliminated D10-based weapon damage for consistency's sake. Lastly, we factored in Kills and the idea of "Super Damage"; chances are, in most *Cyberpunk* games, you will never encounter these at all, since you never need to throw around damages higher than 14 dice.

The idea of Hits is like first-Edition *FNFF*, or the points of *Mekton*. The problem is, the current *FNFF* chart system only works for humans of a specific size range. It won't work well for aliens, giants, monsters or really tough humans, because the 4-point increments would have to be changed and we'd need a totally new table for each new type. Stun was also added—this reintroduction of what was formerly known as bludgeoning damage in first-edition *FNFF* allows us to have long fistfights that don't ALWAYS end in death. If you're gonna do kung fu action or brawls, you need this.

BGC ERRATA

As might be expected, there are a few errors in the *BGC RPG*—and we'd like to address them. Most are relatively straightforward cases of confusion over phrasing and can be clarified pretty easily. There are, however, some typos, omissions, or holes in the rules, which we are making a point of addressing. Here's what's come up so far:

▼ OVERALL ISSUES

ARTWORK: All but one picture is official Japanese artwork—we tried to provide as much artwork as possible, since we know how hard it is to find *BGC* books! The only picture done by us is the detail of Linna's New Hardsuit's Knuckle Bomber on pg.79. Everything else is Japanese.

CHARACTERS: In many cases, a character has a "COOL" Stat—this is actually supposed to be "WILLpower". Similarly, listings flip-flop between PREsence and PERSONality. The correct term is *PREsence*.

POWER LEVEL: Some say the abilities and point levels of the KS and Leon seem awfully high. This was done to accurately represent their abilities in the OVA's, rather than to use them as representations of balanced character creation. They're *not* balanced—as the heroes of the OVA's, the KS and Leon are nigh-superhuman. Such debates occur over most any licensed product—the Stats listed for the characters were based on the opinions of the authors of the *BGC* game, and if your opinion differs, feel free to make any changes you feel are appropriate.

FUZION™: Superpowers, psionics, advanced martial arts, and/or magic are not standard *BGC* fare, but are available in *Fuzion™* with *Champions: The New Millennium* (available now). Advanced "build-your-own" psionics, magic, and martial arts will be covered in upcoming *Fuzion™* books, and of course all of these rules will work for all *Fuzion™* games: *Champions: The New Millennium*, *Armored Trooper VOTOMS*, *Gold Rush Games' Sengoku* and *Usagi Yojimbo*, the 3rd edition of *Cyberpunk* (coming soon), and the *Fuzion™* version of *Mekton Z* (also coming soon).

P.22: FAMILY STATUS: If your character gets a high status in the lifepath, must he pay points for that Wealth? No no. That wealth was in your *childhood* situation—unless you pay for the Wealth Perk, your character was only rich when he was a kid.

P.24: STAT POINTS: 5 Campaign Points equals 1 Stat Point, but we forgot to mention that you may convert Stat Points to Campaign Points too.

P.27: HUMANITY: The optional Derived Stat of Humanity is listed as EMP x10. This should have read WILLpower x10. Our mistake.

P.27 & P.168: RECOVERY: P.27 says REcovery is determined by STrength + CONstitution, while on p.168, it says it's CONstitution x2. Oops; well, the correct value is in fact STR + CON.

P.30: EXPERIENCE: Experience points do not buy Skills up at a 1-to-1 level as CP do in character creation. Instead, it costs as many points as the level of skill to which you're increasing. For example, going from Firearms +3 to Firearms +4 would cost 4 points.

P.31: MARTIAL ARTIST: Some are confused by the "Martial Artist" Talent—note that it is clearly stated under the Talent on p.31 and under the "Hand to Hand" skill on p.30 that Martial Artist allows you to use Martial Throw and Martial Strike (listed on p.41). As for the mention of creating new Martial Arts Maneuvers, that is covered in *Champions: The New Millennium*.

P.32: FAVOR: Note that a Favors is a one-shot Perk—once it's used, it's gone and you don't get the points back for it. If you want more than one Favor, *buy* more than one.

P.43: EXTREME RANGE: If listed range is >50m/yds, -4 applies to distances between *close* and *listed* range (*not* listed and extreme).

P.43: MODIFIERS: The modifier for a Moving Target should be -1 per 10m/yds moved, not -1 per MOVE of target (this scales up to -1 per 100m/yds moved for vehicles).

P.44: ARCHERY: The listing should say that you do one DC (1D6)—*not* "one point"—for each point of STR (up to 7 or 10, depending on the bow).

P.45: COLLATERAL DAMAGE: This is a big error: You take *two Stun per every one Hit* you take, and *PD does not protect* against this!

P.49: KILLS: #4 says that all Kill-rated weapons have a blast radius of 2m per Kill, but not *all* Kill-rated weapons have an Area of Effect. Syla's Laser Sword (for example) certainly doesn't! The idea is that any weapon which *would* have a blast radius will have one measuring 2m per Kill, but plenty of weapons *won't* have any blast radius at all. Note also that "Kills" means *big* Killing damage—50 points of Killing damage equals 1 Kill—"Kills" and "Killing Damage" are *not* synonymous.

As we know, 1K is 14D6. Thus, when dealing with values of less than 1.0K, each 0.1K is 1D6+2 or so. However, since each additional kill over 1K adds only 1D6, each 0.1K over 1.0K adds about +0.5 points; thus 0.5K would add 1/2D6, or 1D3 if you prefer. As an example, 1.7K is 14D6+4. Yes, this does mean that the example on page 49, #4 is *wrong*; 1.2K is 14D6+1, *not* 14D6+5. Sorry 'bout that.

P.49: STAGED PENETRATION: Some worry that 1.0K armor, when hit by an attack of greater than 1K, will stage down to zero. No, don't worry, 1.0K will stage down to 0.9K, then 0.8K, etc.

P.60: HACKING: If you want more detailed cyberspace rules, check out our near-future science-fiction game *Cyberpunk*.

P.69: NENE: In Nene's profile, it says she prefers scrambling a Boomer's neural net to taking him straight on: The hacking rules on page 60 say that computer combat uses ((Computer POW x2) + Die) vs ((INT + Hacking + 1/3POW + Die), so you use the Boomer's INT (usually 4-8) times 2, plus a die, versus Nene's INT of 9, her Hacking of 10, her Hardsuit's computer POW of 3 or 6 (depending upon the model) and a die; all in all, Nene has a value 20 or 21 (plus dice) versus the Boomer's 8-16 (plus dice). Clearly, Nene can easily hack a Boomer's brain, but the problem is that she'll need PHYSICAL ACCESS to the brain to do it (after all, she's gotta plug her computer into the brain)! While it was difficult to do this in combat with her older Hardsuits, her 2034 Hardsuit is designed with this in mind.

P.75: NEW HARDSUIT PRISM: Prism's New Hardsuit (both versions) should have twin Railguns in the right gauntlet! This array has the same stats as the railgun array in the original suit, adding +20 CP to the cost.

P.118-9: AD POLICE: Chief Todo has ADP Authority +10, Leon has ADP Authority +8, and Daley has ADP Authority +7.

P.130: VISION: Vision's Stats (on p.130) list Combat Sense +X and Martial Artist level 3. Whoops—that should read Combat Sense +3 and, as we all know, Martial Artist doesn't have a level.

P.142: ARMOR EVs: We forgot the EV's for the various Armor types! Armored Clothes are EV-0, a Mecha Combat Suit is EV-1, Riot Armor is EV-2, Milspec Flak Armor is EV-3, and Biker Leathers are EV-0.

P.167: CUSTOMIZED MECHA: The bit on Laser Guns should be: "5 +1D10 = Cost; divide the D10's result by 10 & add to 1.0K for damage."

P.168: THROWING RANGE: We admit it, the value listed for throwing objects is messed up. There are better rules for throwing in *Champions: The New Millennium*, but for now assume that for "throwable" objects (grenades, knives, baseballs, etc.) the range is STR x10.

BEFORE THE SABERS. AFTER THE CRISIS.

AD • POLICE
and
BUBBLEGUM • CRASH!



2027: BEFORE THE KNIGHT SABERS, ONLY THE *AD POLICE* STOOD BETWEEN MAN AND MACHINE ... AD IN THE CYBER-PUNK STREETS OF MEGATOKYO, IT'S ALL TOO EASY TO CROSS THAT LINE ...

2034: AMIDST A SEA OF ROBOTS AND ANDROIDS, THE ULTIMATE EVIL IS BACK—AND ONLY THE KNIGHT SABERS STAND BETWEEN MEGATOKYO AND THE TOTAL DESTRUCTION OF *BUBBLEGUM CRASH!*

NOW: THE WORLD OF *BUBBLEGUM CRISIS* IS BACK WITH A VENGEANCE, IN A HOT NEW SUPPLEMENT PACKED WITH DATA FROM BGC'S PREQUEL SERIES *AD POLICE* AND IT'S SEQUEL, *BUBBLEGUM CRASH!* IN *BUBBLEGUM CRISIS: BEFORE AND AFTER*, YOU'LL GET: 2 NEW POWERED SUITS, 4 NEW HARDSUITS, 9 NEW VEHICLES, 12 NEW CHARACTER TEMPLATES, 16 NEW CHARACTERS, 22 NEW BOOMERS, PLUS ADVENTURE HOOKS, CYBERNETICS RULES, AND GUIDELINES FOR CONSTRUCTING YOUR OWN HARDSUITS, BOOMERS, AND OTHER MECHA WITH OUR ANIME TECHBOOK, *MEKTON Z PLUS!*



AM 08011 ISBN# 0-937279-92-7

ANIMECHANIX

BUBBLEGUM CRISIS: BEFORE & AFTER



Animechanix is a division of R. Talsorian Games, Inc. Bubblegum Crisis: Before & After Copyright © R. Talsorian Games, Inc., 1997, All Rights Reserved under International Copyright Conventions. Fuzion™ is the FUZION Labs Group's Trademark for its multi-genre game system. "Bubblegum Crisis"; Copyright Artmic, Inc., and Youmex, Inc. 1987-1990; "Bubblegum Crash!"; Copyright Artmic, Inc., 1991 and/or "AD Police"; Copyright Artmic, Inc. and Youmex, Inc. 1990. All Rights Reserved, English subtitled/dubbed versions Copyright, AnimEigo, Inc., 1991-1995, All Rights Reserved. All situations, incidents and persons portrayed within are fictional and any similarity without satiric intent to individuals living or dead is strictly coincidental.

