

Suitable for use with
ADVANCED
DUNGEONS & DRAGONS*

DEADLY

The key lies in a riddle

POWER

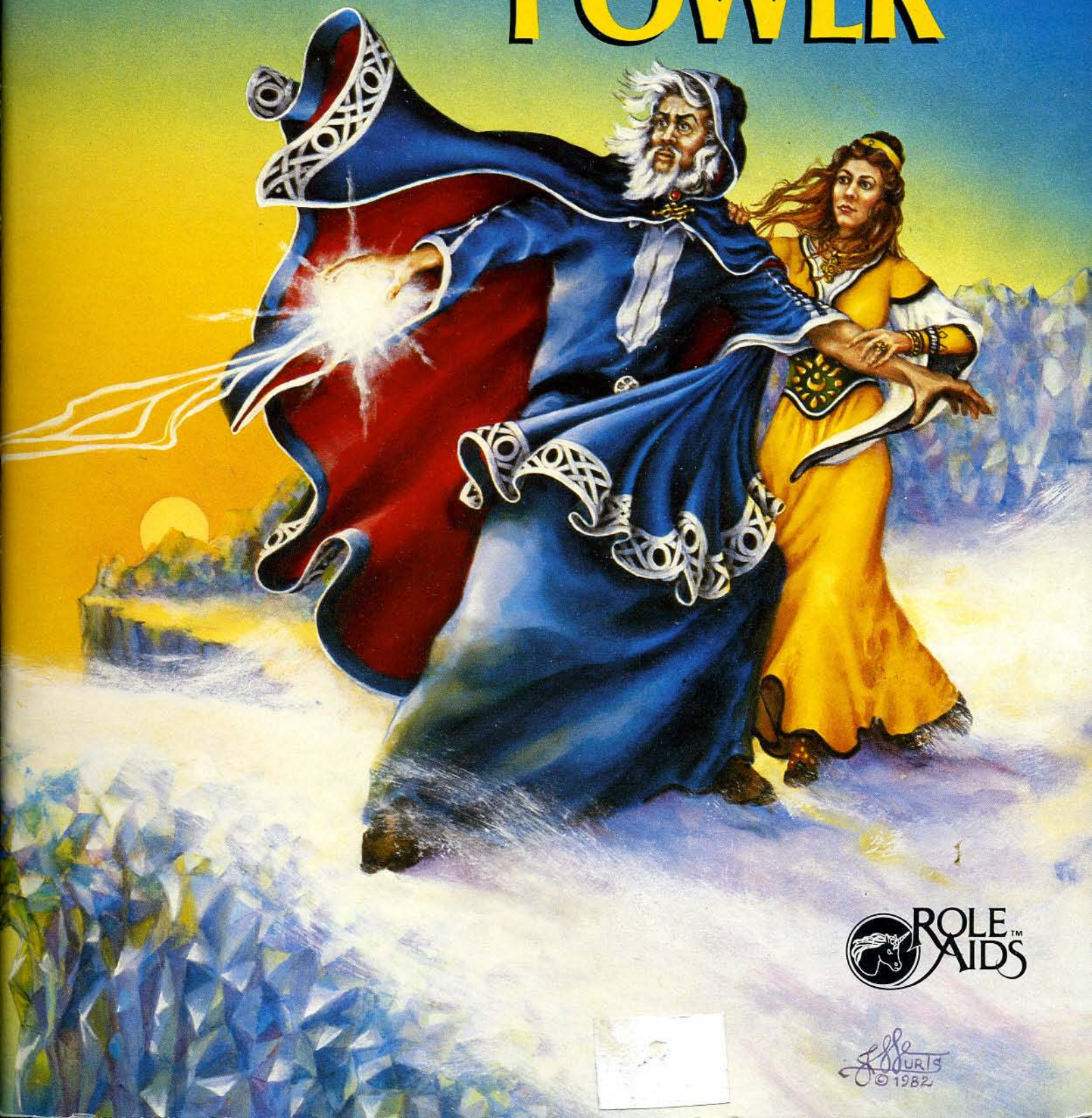

 **ROLE-AIDS™**

Edwards
© 1982

DEADLY POWER

Written by Laurel Nicholson, John Keefe,
and Donald Nicholson

TABLE OF CONTENTS

Gamemaster's Notes	3
An Afternoon Encounter	4
Shallotville	7
Minter's Tower	13
The Rat Caverns	16
Mausoleum	25
The Opalesce Forest	30
The Wrap Up	36

DEADLY POWER

Written by Laurel Nicholson, John Keefe,
and Donald Nicholson

Edited by P. Bromley

© 1984 Mayfair Games Inc.

Cover Illustration: "Icebridge" ©1982 by Janny Wurts

Interior Illustrations by Teanna Byerts

Maps by James Clouse and Gerald O'Malley

Playtested by Cecil, Danny, & Irene Clark,
Lynn Walters, and Dan Pallman

ALL RIGHTS RESERVED. *No part of this book may be reproduced in any form or by any means, except for the inclusion of brief quotations in a review, without permission in writing from the publisher. Permission is granted to the purchaser of this book to copy the maps and players' histories for personal use provided that none of the copies are sold or traded.*



and Role Aids are trademarks for roleplaying aids and adventures published by Mayfair Games Inc.

All characters in this book are fictitious. Any resemblance to actual person, living or dead is purely coincidental.

ISBN: 0-912771-17-8

Manufactured in the United States
Published simultaneously in Canada

Mayfair Games Inc.

Chicago, IL

GAMEMASTER'S NOTES

This module was designed for players of moderate levels, 6-9. A group of six players is recommended, including one magic user, one cleric, one strong fighter, and one thief. The Gamemaster should first thoroughly read the module before using it.

HHISTORICAL BACKGROUND

This adventure takes place in Shallotville, a rich mining town built near the sea. It has wooden huts on the outskirts and is surrounded by dirt hills and partially constructed masonry walls. Most of the buildings in the city are constructed of stone.

In past days, the town was the scene of constant strife and warfare because of the great wealth generated by its gold mines. Many rulers came to power, only to lose the town and their lives to outside invaders. Only four rulers recorded in the town's history are known to have ruled longer than two years. They are buried in the mausoleum to the southeast of town. None ruled longer than ten years until Yelad came to power.

Yelad's great reign was marked by 30 years of uninterrupted peace. However, this was not a peace by chance, for the ruling King Yelad was actually a Fleshmorph, a devil in human form.

Before coming to the material plane, Yelad served Dispater. He helped collect souls for Dispater's palace in Hell. Yelad was deluded by a rival into letting one of Dispater's human prisoners go free. After learning of this, Dispater banished Yelad to the Prime Material Plane for an indefinite period of time.

Out of the depths of Hell, Yelad brought with him a magical seed which he planted and harvested. In the spring, it produced leaves, which when smoked, gave Yelad a voice so enchanting that almost all humans fell immediately under a Charm spell, believing whatever Yelad told them.

Yelad won the hand of the beautiful Lady Cynthia and the friendship of the powerful sorcerer, Grinmare. Together they moved to Shallotville, renown for its gold mines. With his magical voice, Yelad soon took control.

Although the town was productive and wealthy, Yelad let the buildings deteriorate through neglect. However, his golden voice convinced the town dwellers that the enormous taxes they paid were going for the town's upkeep. They still believed . . . even as the buildings fell into disrepair and Yelad grew rich and fat on the gold from the mines. The outside invasions were quelled, for enemies soon fell under Yelad's spell.

During those years King Yelad was not idle. Early in his reign, his wife Cynthia bore him a son named Mynor Yelad. Although the child was not a devil, he was gifted with certain of his father's abilities. The King also gained the friendship and loyalty of the town's rats and their wererat leader, Greasel Greedigutt. He allowed them to rule the underground caverns if they would serve as guardians of the mines.

Yet, Yelad was not totally without adversaries, for not everyone followed him blindly. To the north of Shallotville was the stronghold of the Lady Enaj, a highly intelligent illusionist who once served Yelad as an advisor. Enaj was as ambitious as she was clever. Using great skill and

cunning, she lured Grinmare the Sorcerer over to her side. Disenchanted with his lack of authority under Yelad, Grinmare secretly plotted with Enaj to take control of Shallotville.

One day, to the King's distress, his son Mynor Yelad announced that he was leaving home on his 18th birthday to explore the lands beyond the city and seek renown. Two weeks later on the morning of his birthday, he left. The King never heard from him again.

Hoping his son would one day return, the King had his slaves build an elaborate complex beneath the town's mausoleum to protect the King's magic tobacco leaves. The slaves were later killed to protect the secrets of the crypt. To help his son, King Yelad wrote a scroll which gave clues how to retrieve the leaves and entrusted the scroll to Greasel.

The King had tired of the material plane and longed to return to his home in Hell. Many years he prayed to Dispater for forgiveness. Then, ten years after his son's disappearance, Dispater sent word that if Yelad wanted to return, he should show his good faith by sacrificing the Lady Cynthia. Only then would Dispater consider the request. Yelad's longing for Hell overpowered any feelings for his wife, so in accordance with the rites of Dispater, Cynthia was sacrificed in a secret ceremony.

Despondent over his wife's sacrifice and uncertain of Dispater's decision, Yelad came to his advisor Grinmare for a sleeping potion. Taking this opportunity, Grinmare stole into the King's room as he lay drugged and cast a Flesh to Stone spell, decapitated the King, and then used a Scroll of Stone to Flesh. The Fleshmorph returned to Hell—in order to serve 250 years of penance as a Lemure.

The minute the King was killed, the townsfolk awoke from their spell in horror—their town was falling to ruins! And then a sudden earth tremor shook the very foundations of the town, causing even greater damage and sealing the entrance to the mines.

The Lady Enaj came quickly to power with promises of rebuilding the town and re-opening the mines buried under mounds of earth and rock during the tremor. All the while, she blamed the town's deteriorating condition on the deceitful reign of Yelad.

Two years after the King was killed, Grinmare sent a hurried message to Enaj: Yelad's son had suddenly reappeared and was gaining strength and powerful friends. Something must be done—and fast! That was Grinmare's last message. He was captured by the town's rats when he returned through the Opalesce Forest.

Mynor Yelad soon thereafter returned to Shallotville. He received his father's scroll from a Wererat, but has not sought out Greasel. He wants to first regain power before negotiating with Greasel.

SECRET OF THE MAGICAL LEAVES

It is possible for a character to smoke the leaves without dying, and characters may discover this by deciphering the following words written on the balusters surrounding Yelad's skeleton and in the book of his teachings:

DEATH DOES NOT TAKE ALL, THE STRUCTURE OF MAN HOLDS THE POWER.

Here, the structure of man represents the skeleton of Yelad's human form. For, in order for a character to smoke the leaves without dying (no save allowed) and gain Yelad's mass charming powers, a piece of Yelad's skeleton must be ground to powder and ingested. In the three days before the bone is naturally eliminated from the character's body, the leaves may be smoked and the power gained. Anytime a character smokes the leaves without having a piece of Yelad's bones within his system, he will die.

The power will only be effective as long as some of Yelad's skeleton remains within the character's system. Once the bones are eliminated from the character's body, the powers vanish. In order to regain that power, Yelad's bones must be ingested and the leaves smoked again.

If the bones are ingested within the system without a lapse, there will be no need to continue smoking the leaves, for the charm will last as long as some Yelad's bones remain in the character's body. If more than one character ingests the bones and smokes the magical leaves, confusion will result, breaking the spell. Only one person at a time may hold the power.

Each ounce of bone ingested will prolong the power to mass charm by one hour. The skeleton weighs 40 pounds; the skull, 3 pounds; and the rib bone found in the Relic Room (CRYPT, AREA 5B), 8 oz.

All humans charmed can save with a roll of a natural 20. Half-elves and Half-orcs save with a roll of a natural 19-20. Elves, Dwarves and Gnomes save with a roll of a natural 18-20. Monsters (including the rats) are not affected by the charm, nor is Mynor Yelad. If the town is successfully

won, the gold mines (once the rats have been cleared out) will yield 150,000 g.p. total per year.

WHAT THE PLAYERS MUST DO

The object is for the players to recover the box of seeds (which includes some mature leaves). If they refuse, then Mynor Yelad will be forced to go himself and will discover that he will have to ingest Yelad's bones for the spell to take effect—although once in effect, the spell will not lose its power after three days. If Mynor smokes the leaves without ingesting the bones, he will die (his human half will die of system shock without the aid of Yelad's bones). By doing Mynor's quest for him, the party will be depriving him the information he needs to smoke the leaves and live.

After first setting up the political situation with their encounters with Mynor Yelad and Queen Enaj (or Cassandra), the players have to do the following:

1. Go to the Tower and use the mirror Teleport to go to the Rat Caverns.
2. In the Rat Caverns, they should go to Kerrigan's Chapel to learn from Yelad's skull on how to defeat the Glass Golem and possibly how to safely smoke the leaves. Mynor was to learn here that he had to eat Yelad's skeleton to safely smoke the leaves. (The skull will reveal this only to Mynor.)
3. Recover the key from the Captain's picture. It allows them to enter and pass through the Naga's chamber without damage or hindrance.
4. Go to the Mausoleum and recover the box of seeds and leaves.

ABBREVIATIONS USED & STATS

Statistics will be given in this order: Strength, Intellect, Insight, Dexterity, Stamina, Appeal

AC:	Armor Class	HTK:	Hits to Kill
Align:	Alignment	M:	Movement
Att:	Number of Attacks	Dm:	Damage
Stats:	Character Ability Statistics		

AN AFTERNOON ENCOUNTER

Their last adventure over, the characters have decided to rest up in the nearest town. By noon, they have wandered into a busy town. All the buildings seem to be in disrepair, but here and there workmen can be seen repairing and refurbishing the stores and buildings. Tired and weary, the adventuring group sees a sign, Swill and Warm Ale Tavern. They wander in and order food and drinks.

Regardless of the tavern's name, the food looks hearty and tastes good. But suddenly, in the midst of discussion, they begin to feel weak and dizzy. If they try to stand, they will fall to the ground. Within seconds, they are all unconscious. There are no saving throws.

When they awaken, they find themselves dressed in peasant clothes in a back room of the tavern. Several feet in front of them is a long, rectangular table upon which all of their armor, weapons, and magic items are neatly arranged in separate piles. Standing around the table are 20 large, ugly thugs. Magic Users and Clerics will find that they are still too drugged to cast spells.

Just then, the door swings open and two guards enter and stand with their weapons in salute. Behind them enters a man dressed in chain mail, partly concealed with a long blue robe. Mynor Yelad appears about 30 years old, of average height, and has short brown hair and brown eyes.

(20) **Skill 3 Human & Half-Orc Fighters**

AC: 7, HTK: 21 each (3D10)

Stats: Average except Strength: 14+

Align: Neutral to Lawful Evil, *Equipment:* Leather, Shield, Longsword

(2) **Guards, Skill 4 Human Fighters**

AC: 4, HTK: 30, 25 (4D10)

Stats: Average save Strength: 17 (+1 to hit/+1 to damage)
Align: Lawful Evil, *Equipment:* Chain, Large Shield, Longsword

Mynor Yelad, Skill 8 Half-Devil Fighter

AC: 6, *HTK:* 64 (8D10)

Stats: 15, 17, 13, 06 (+1 to AC), 12, 16

Spells (once per day): Read Magic, Detect Magic, Detect Invisibility, Wall of Fire, Fear

Align: Lawful Evil, *Equipment:* Chain, +1 Dagger,

Special: Immune to heat, takes half damage from magical fire.

Proud and confident, he walks up to the group and tells them they're in no danger. Then he makes an offer. He tells the group he is Mynor Yelad, the rightful heir of the town. He seeks to regain an item that is so well guarded, only hardened adventurers could hope to retrieve it. The item was left to him by his father, the former King Yelad. As proof, he reveals a scroll kept in safe keeping by the King's followers. The scroll offers many clues on how to obtain the item he needs to regain his rightful kingship.

If the players return the item to him safely, he will pay them each 7,000 g.p. plus a magic item for each adventurer, suited to his particular needs. (This is left to the GM's discretion). In addition, he will give them two large Potions of Healing (3 drinks each, each drink restoring 1-8 HTK). Of course, any extra treasure they find along the way is theirs to keep. He asks if they will accept his offer, but they must decide quickly. The thugs draw their swords.

IF THE PLAYERS DO NOT ACCEPT THE OFFER, all the items on the table, including supplies, are thrown into several canvas sacks and carried out of the room. The offer is repeated. If it is again turned down, the thugs move forward, but Mynor Yelad halts them. The characters will be escorted into the forest without any of their original belongings. The party will then encounter Cassandra (Forest, Random Encounter 18).

IF THE PLAYERS ACCEPT HIS OFFER, Mynor Yelad will read them the scroll and then hand it over to the leader, along with the two bottles of red liquid. (The party's equipment, if taken away, will also be brought back in and placed on the table.)

THE SCROLL

*I saw my enemies gaining ground,
And feared my magic would be found.
A golden box with seeds and leaves,
Will soon be sought by cutthroat thieves.
Every day the dangers mount.
Every hour and minute count.
You must be wary of cunning spies.
Avoid the lurking blue jay eyes.
Traitors lurk in sea and tower,
In caverns deep and halls of power.
Yet, these dangers you must face,
Or lose the glory of our race.*

*Four clues will help you in your quest.
Four clues will tell you all the rest:*

*Reach the mirror within the Tower.
Step below at the seventh hour.*

*Cavern paths take many ways.
Seek the track where Yelad lays.*

*A ship of treasure sank in the sea.
The captain's portrait holds the key.*

*But in tomb, at last you'll find,
The power and glory that once were mine.*

*Find all four clues for if you fail,
Your men will fight to no avail.
Listen loyalists to these commands,
Or the power may fall to unclean hands.
Arise my followers! The time is nigh!
The traitorous lady of the north must die!*

(At this time, a slight fluttering is heard at the window and players see a large blue jay sitting on the sill. When a thug rushes toward it, it flies away.)

After handing players the scroll and the two bottles, Mynor Yelad walks toward the door, but stops and turns. He tells the players, "If you retrieve the golden box of seeds, you should bring it to this tavern. And one more thing:" he advises, "Anyone attempting to use the weeds other than the rightful heir will die." The two guards depart immediately behind Mynor Yelad and then, one by one, the thugs leave the room.

OUTSIDE THE TAVERN

Assuming players accept the offer, upon leaving the tavern, they see a large blue jay fly overhead, squawk and drop a folded piece of paper. If a player retrieves the paper and opens it, they will read the following:

*For the good of the town and the sake of your
own lives, please be my guests at the Halls of
Power as soon as possible. The blue jay will
lead you there*

Queen Enaj

*P.S. present this letter to the guards at the
entrance.*



IF THE PLAYERS CHOOSE NOT TO VISIT THE QUEEN, the blue jay will follow the players (keeping out of firing range) and will report to the Queen on the players' whereabouts. If players enter the tomb and live to exit it, they will be greeted by a host of city guards (see stats. in Building E), and escorted to the Halls of Power. Here, they will be searched and sent out of town. Only items of value found in the crypt will be confiscated.

IF THE PLAYERS AGREE TO SEE THE QUEEN, the blue jay will lead them across town to the western entrance of the vast and beautiful Halls of Power (Building E).

Once the note is presented to any of the guards, it will be passed to a thin but powerful looking guard who introduces himself as Sweble and leads the party through the northwestern entrance to the first room on the left (E3). This is a 15x15 foot room lit with two torches on each wall. In the center of the eastern wall is a closed door, where Sweble stands guard. Next to the door is a mural of the Queen (as a younger woman) with a wizard (Grinmare), combining their talents to form an ice bridge. The Queen's eyes seem to follow the party wherever they go. Against the northern wall sits Queen Enaj on an elaborate throne studded with rubies and emeralds. Surrounding her are four men-at-arms, two on each side. Sitting on Enaj's shoulder is the blue jay, its mouth wide open. During the conversation, it occasionally whispers in her ear.

Enaj is tall and stern, yet strangely charismatic. Approximately 45 years old, she has blonde hair tied behind her head in a bun, wound around a silver dagger. She is dressed in long robes outlined in purple stars (Cloak of Displacement).

Calling the leader's name, she welcomes you to her town. Then she proceeds to discuss the scroll that she knows you have in your possession. She tells you that Mynor Yelad is evil and his father was a devil from Hell. If Mynor Yelad is able to acquire the golden box mentioned in the scroll, he will use its powers to regain the throne and the city. If this happens, he will continue his father's tradition and steal from the town and its citizens.

She asks your group to please help her retrieve the box so it can be held in safe keeping against Yelad, and if possible, destroyed. No other townspeople are strong enough. She also asks players to kill as many of the rats in the caverns as possible. They are terrorizing the town and preventing the mines from being re-opened.

IF THE PLAYERS ACCEPT, she offers 7,000 gold pieces to each one and promises to resurrect any slain member of their party if the golden box is successfully returned to her. Of course, any other treasure found during the adventure will be theirs to keep. If the players indicate a need to enter the Tower, she will also give them each a griffon badge and tell them how to enter the Tower safely.

IF THE PLAYERS TRY TO FIGHT THE QUEEN, she will take no damage because the woman on the throne is a Projected Image and the real Queen is watching from behind the oil painting in Room E2. Guards will insure that her view is never obstructed. At the first sign of attack, Enaj will cast Confusion on players and then use Rope Trick to reach her Griffon and escape (through the ceiling in Room E2). The guards will attempt to capture players and imprison them in Building W. Any players leaving



the Hall of Power through the east or west entrance unescorted will be stopped by guards and held for questioning. For statistics, see Building E.

IF THE PLAYERS REFUSE HER OFFER, they will be allowed to leave. The blue jay will follow them (out of firing range) and report to the Queen on their whereabouts. The blue jay will also deliver a note to the town's Assassins Guild (Building CC). The note will recruit the help of expert assassin Yvonne the Terrible, requesting her to find and assassinate the leader of the adventuring group (and if circumstances permit, other group members) for refusing to help the Queen. Yvonne will follow the players into any building they enter.

Yvonne the Terrible, Skill 10 Assassin

AC: 8, HTK: 40 (10D6)

Stats: 13, 17, 12, 14, 09, 07

Align: Chaotic Evil, Equipment: Leather, Poisoned Dagger. Poison will only be effective on the first victim, who must save vs. poison or die.

SHALLOTVILLE

All unlabeled buildings on the city map are the houses of townsfolk. Unless otherwise specified, all townspeople are Skill 0, AC: 10, 1-4 HTK. A strong flavor of uncertainty taints all encounters with the townsfolk: They are also aware of Yelad's return.

A SWILL AND WARM ALE TAVERN

Owned by Louis Trix, a long-time Yelad loyalist. Trix lost one eye defending Yelad's name in a bar fight at Traveler's Tavern across town. As a sign of gratitude, King Yelad purchased the Swill and Warm Ale Tavern from the previous proprietor (for remarkably little money but a chance to escape town alive). The Swill and Warm Ale Tavern now serves as a headquarters for Yelad followers, although it still does a bustling business, serving strong (cold) ale and hot beef stew. Many of the apparent drifters and drinkers are recruits of the Yelad camp.

B HALE'S DRY GOODS

George Hale has a well stocked store and sells bolts of material, women's hats, dry food stocks, paper, quills, pots and pans, even candy.

C EAT'N RUN TAVERN

If the characters stop here on the days when Samuel is cooking (Tuesday, Wednesday, or Saturday), they each have a 60% chance of getting ill within 30 minutes after eating. The tavern is closed on Sundays.

D PRECIOUS GEMS AND JEWELRY

This fancy jewelry store is run by "honest" Irving Hasselbum, who assumes every customer is a thief unless proven otherwise.

E HALLS OF POWER

The Halls of Power, office of Shallotville's ruler, is the only building in town kept in perfect condition. Each outside entrance has six guards and one captain.

If there is a major disturbance, the captain will blow a silver whistle calling for the men-at-arms stationed in underground barracks below the porticos. Within two to three rounds after the whistle is sounded, 15 soldiers from each side of the building will arrive up through the white pillars, second row from the entrance. Guards from one side will never leave their post to help guards on the other side.

(12) *Guards, Skill 4 Human Fighters*

AC: 5, HTK: 22 each (4D10)

Stats: Average

Equipment: Chain, Longsword

(2) *Captains, Skill 5 Human Fighters*

AC: 3, HTK: 30, 35 (5D10)

Stats: Average except Strength 16 (+1 to damage)

Align: Lawful Neutral, Equipment: Plate, Bastard Sword

(15) *Soldiers, Skill 2 Human Fighters*

AC: 7, HTK: 12 each (2D10)

Stats: Average, Equipment: Leather, Large Shield, Longsword

Sweble and four guards form the personal bodyguard of Queen Enaj and will be with her at all times while she is in town.

(4) *Guards and Sweble, Skill 6 Human Fighters*

AC: 3, HTK: 44, 38, 42, 46, 53 (Sweble) (6D10)

Stats: Average, except Strength: 17 (Guards: +1 to hit/+1

to damage), 18/60 (Sweble: +2 to hit/+3 to damage)

Align: Lawful Neutral

Equipment: +1 Chain, Large Shield, Bastard Sword

Enaj, Skill 11 Illusionist

AC: 5, HTK: 33 (10D4+1)

Stats: 08, 18, 11, 18, 07, 13

Spells: (5/4/3/3/2) Detect Invisibility, Change Self, Wall of Fog, Blur, Misdirection, Invisibility, Fear, Non-Detection, Rope Trick, Confusion, Phantasmal Killer, Projected Image

Align: Chaotic Neutral

Equipment: Cloak of Displacement, +1 dagger.

E1 ENAJ'S SLEEPING QUARTERS This 15x15 foot room has a 15 foot high ceiling and a door on the southern and western wall. Against the eastern wall is a canopied bed with satin sheets and down blankets and pillows. On the north wall is a 9-drawer dresser and against the southern wall is a large armoire. In the dresser are fine clothes (worth 400 g.p.). In the armoire are robes and boots (worth 150 g.p.)

E2 ENAJ'S PRIVATE OFFICE Approximately 15x25 feet with a 10 foot high ceiling, this room has a door on the eastern, southern and western wall. A white bust of the Queen is built on a marble stand in the southeastern corner. On the northwestern wall hangs a large oil portrait of Enaj, but the eye sockets are empty, allowing a person to look into Room E3. In the center of the room is a large dark oak desk with seven drawers, three on each side and a long center drawer. On top of the desk are two sheets of empty paper, an ink well, and a small silver bell.

Inside the Queen's bust are 4 diamonds (each worth 5,000 g.p.). The top left drawer of the desk is filled with birdseed. The middle left drawer has only empty files. The bottom left drawer has files on the cities projects and funds. The center drawer is filled with bills, lists of renewal projects, a list of known dissenters, tax statements, and 1 s.p.

The top right drawer has a stack of white paper, ink wells, quills, and blank scroll paper. The middle right drawer is decorated with a carved griffon's head. It is locked and only Enaj carries the key on a necklace around her neck. The key fits into the griffon's beak, which has a Magic Mouth cast upon it. When the key is placed in the beak, the beak closes around the key and is able to tell whether it is the real key or a pick. If it is a pick, the Magic Mouth shouts, "Intruders! Robbers! Thieves!" loud enough for Sweble and the four guards to come running, as well as Enaj if she is anywhere within the Halls of Power. The call will also alert all guards at the entrances of the building. The Magic Mouth will repeat itself for one whole turn, but can be dispelled by magic.

Inside this drawer are six Illusionist scrolls encased in fine platinum cases (each worth 50 g.p.), and a round Crystal Ball (ESP). The six scrolls are: Ventriloquism; Change Self; Wall of Fog; Fear; Misdirection; and Rope

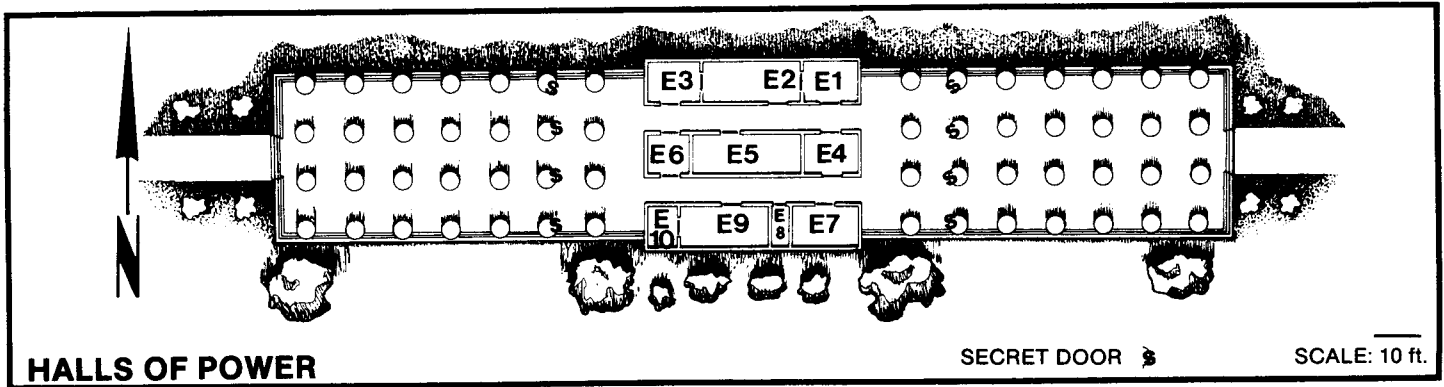

HALLS OF POWER

SECRET DOOR

SCALE: 10 ft.

Trick. Whoever gazes into the Crystal Ball must have a Stamina of 16 or better in order to wrestle it away from Enaj's control. If a player has Stamina below 16, it will not work for him and Queen Enaj will come instantly into view.

The ceiling in her office is an illusion. If anyone tries to touch it, they will put their hand right through what they thought to be the ceiling. The illusion can only be detected through True Seeing.

Once above the ceiling illusion, a player will notice there is a glass enclosed case bolted to the northern wall and a six foot long rope ladder suspended from the real ceiling, five feet higher. The glass case has several bottles, most of which are empty, but three are filled.

One filled bottle is gray (Protection from Lycanthropes) and works as the scroll of that name; one bottle is silver (Oil of Etherealness); one bottle is orange (poison; any player imbibing this liquid will drop dead within 5 turns. If just sipped, a player will become comatose for 12 hours. (Save Allowed).

The rope ladder leads to a trap door in the real ceiling. Through this trap door, players enter the stable of Enaj's pet Griffon (who will attack unless Enaj is with them). The entire ceiling of the Griffon's room opens with the turning of a small crank on the southern wall. When the ceiling is completely opened (2 rounds), the Griffon, nicknamed Djim, can fly Enaj to wherever she commands.

Griffon

AC: 3, HTK: 45 (7D8), M: 12"/30"

Att: 3, Dm: 1-4, 1-4, 2-16

E3 QUEEN'S AUDIENCE CHAMBER This is a 15x15 foot room with a 15 foot high ceiling and doors on the eastern and southern walls. Against the northern wall is a large golden throne studded with rubies and emeralds (worth 10,000 g.p.). However, the throne is built into the floor and would take two men several hours to free it from the floor. On the eastern wall is a mural of the Queen with Grinmare, combining powers to form an ice bridge. Enaj commissioned this mural to commemorate the meeting where she was able to convince Grinmare to turn against King Yelad.

When the Queen has visitors, she casts a Project Illusion of herself on the throne, while she safely remains in room E2, viewing the guests through the mural's empty eye sockets. Guests will notice that the eyes appear to follow them around the room, but they cannot detect that the eyes are not part of the mural.

E4 GRINMARE'S SLEEPING QUARTERS This is a 15x15 foot room with a 15 foot high ceiling. On the southern and northern walls are doors. On the far eastern wall is a day bed covered with fat, down pillows. On the western

wall is a five drawer dresser filled with fine clothes (worth 200 g.p.). On the southern wall are five pegs covered with hanging robes (worth 80 g.p.).

E5 BATHROOM The only entrance into this room is on the northern wall. This is a 15x25 foot bathroom, elegantly furnished. There is a large tub on the eastern wall draped with thick purple towels. On the southern wall are two washstands. On the western wall area a chamber pot and bidet.

E6 LIBRARY This is a 15x15 foot room filled with bookshelves. A small oil painting of Queen Enaj hangs on the eastern wall and due to the skill of the artist, its eyes seem to follow people around the room. To the center of the room is a circular oak table with a gold candelabra (worth 200 g.p.). There are six wooden chairs around the table.

E7 TROPHY ROOM On the eastern wall is a large portrait of Queen Enaj, slightly different from the others. In this portrait, she is smiling. Due to the skill of the artist, her eyes seem to follow people around the room. The southern and western walls are filled with shelves of stuffed heads, some animal and some human. There is a mountain lion, bull, deer, as well as one green dragon head, giant ram, and troglodyte head. There are 150 orc, bugbear, and minotaur heads. However, most of the heads are human.

Many of these heads were Enaj's political enemies; the rest are mementos of her adventuring days. If any player is killed while in the Halls of Power, his head will appear in the Trophy Room.

E8 BROOM CLOSET

E9 OFFICE This is a 15x25 foot room with a door on the northern and western wall. On the southern wall is a portrait of the Queen and due to the skill of the artist, her eyes seem to follow you around the room. In the center of the room are two small desks and chairs. During working hours, characters will find a bald man and a young woman here.

E10 BATHROOM There is only one entrance into this unkempt washroom. At the southern end is an old, broken washstand and on top of the stand is a chipped china bowl and pitcher. Next to the washstand is a rusty bucket.

FBERT'S BLACK SMITHY

Known for reliable horse shoeing at reasonable prices.

Smith: *Bert*, Skill 4 *Human Fighter*

AC: 6, HTK: 32 (4D10)

Stats: 18 (+1 to hit/+2 to damage), 10, 11, 18 (-4 to AC), 14, 07

Align: Lawful Good, Equipment: Hammer

G SLEEPY HOLLOW BOARDING HOUSE

SHALLOTVILLE RESALE

Everything from royal vestments to used underwear. Prices are low and you know what you're getting.

BARSTAR STABLES

The stables are well built and next to a large, fenced pasture. All horses are pampered here, no matter how long they're boarded. Horses are washed, brushed, and fed for only 10 copper pieces a day.

THE LEATHER SHOP

BOTTOMS UP TAVERN

Owned by "Mama" McCoy a boisterous fat woman who employs only the classiest looking women with the sleaziest morals to serve drinks and keep the men happy. The singer is "Star" West, whose striking beauty keeps the tavern in the black. Behind the bar working nights is Clate Harlin, bartender.

Mama McCoy, Skill 8 Human Thief

AC: 9, HTK: 42 (8D6), Stats: Average

Align: Neutral, Equipment: Dagger

Clate Harlin, Skill 5 Human Fighter

AC: 9, HTK: 30 (5D10), Stats: Average

Align: Neutral, Equipment: Dagger, Longsword under the bar

K1 CLOSET Opening the door on the eastern side of the stage, players will see a small 10x10 foot walk-in closet. Hanging on the clothes rack are stage costumes for entertainer Star West. There are red, silver, gold, purple and black lace panties with matching beaded tops and silky tassels. Each costume has a matching pair of high leather boots. On the shelf in the closet are piles of feather hats, lace stockings, and a small black beaded money belt (empty).

K2 DRESSING ROOM Entering the room on the west side of the stage, players will see a 10x10 foot dressing

room. On the far western wall is a dressing table and chair. On the dressing table are four bottles of perfume, a silver brush, comb and mirror sitting on a glass tray, 2 s.p., and an address scribbled on a piece of scratch paper, 25 Market Street.

The silver brush, comb and mirror set are worth 85 g.p. Underneath the dressing table is a small drawer hidden from view but not secret. Inside the drawer are another 14 s.p., a small sapphire pinky ring (200 g.p.) and an extra pair of red panties. The address, 25 Market Street, is the home of Quick Edward, owner of Quick Edward's Building Supplies.

K3 CORRIDOR

K4 OFFICE The door on the west opens to a 15x10 foot room. Against the far northern wall is a three drawer desk with two brass sconces on the wall flanking the desk. Against the southern wall is a brown velvet armchair and on the wall above it is a 3x3 foot painting.

The doorknob on the inside of the room operates like a lock. While it feels and appears like a normal knob, two complete turns to the right followed by one complete turn to the left opens a small compartment inside the knob, which holds a small golden key (to the ale barrel in K6).

On the eastern wall is a small 4x4 foot secret door, activated by pulling down on the sconce east of the desk. This secret door leads to AREA K6.

K5 BASEMENT STORAGE

K6 TREASURE ROOM Through the secret door in AREA K4, players will enter this 6x10 foot room with two ale barrels against the northern wall. If a player turns the tap on either barrel, nothing will come out, but he will have to actually lie on the floor and look up to see a small keyhole on the underside of each tap.

On any night the inside of each barrel will hold between 500-5,000 g.p., 200-800 s.p. and 10-40 c.p. The barrels can be opened by the key hidden upstairs in the doorknob

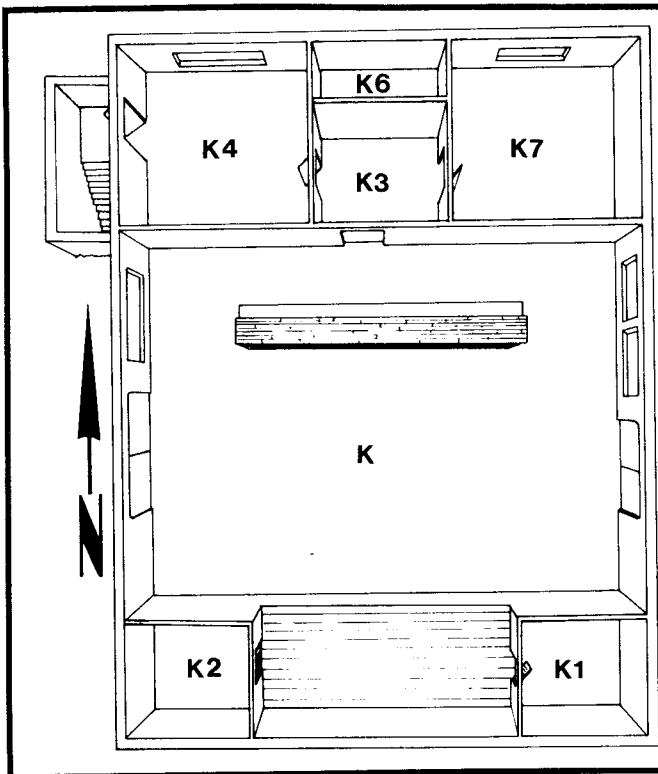

BOTTOMS UP TAVERN

SCALE: 5 ft.

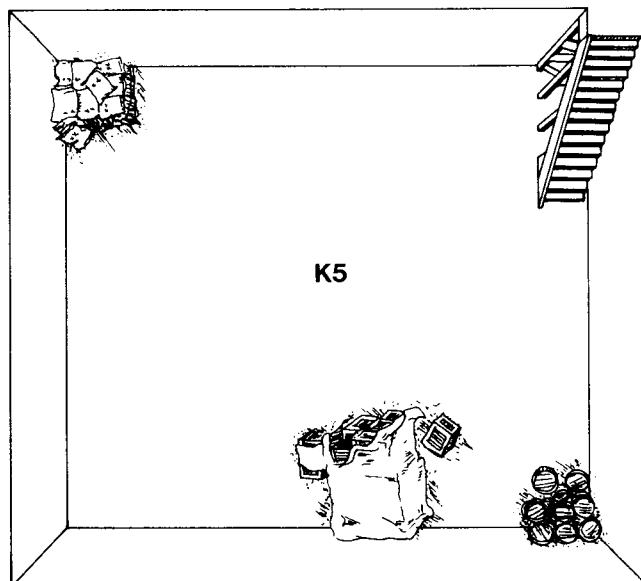

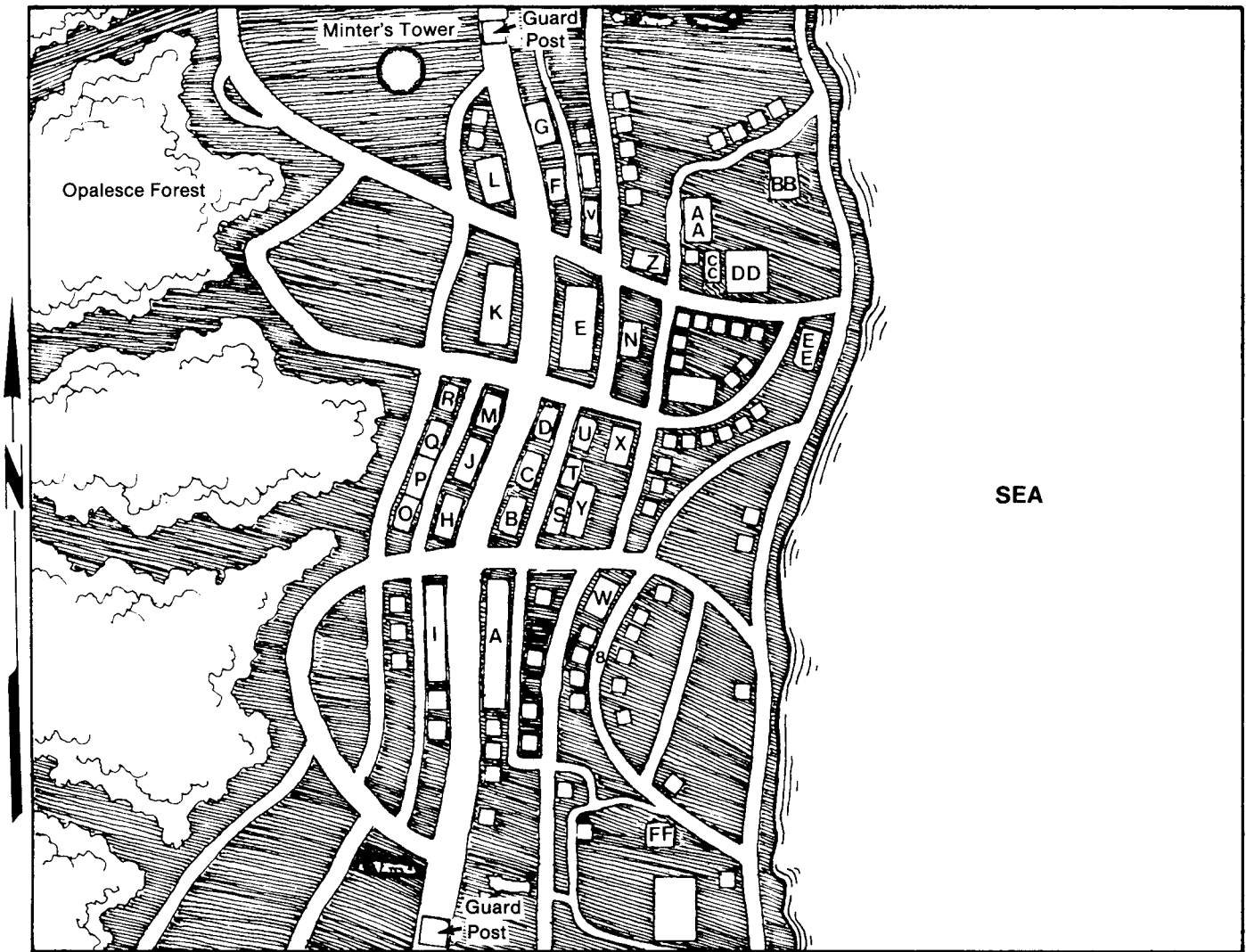

(AREA K4) or by a knock spell, or two successful open lock rolls.

K7 GAMBLING ROOM This is a 15x15 foot room with bare walls and no windows. There is a large round table in the center of the room and 8 wooden chairs around it. If the room is empty, there will be a deck of playing cards on the center of the table.

This is a gambling room and will always be guarded inside and out after 7 p.m., 7 days a week. There will be two guards inside and one guard outside the door every night. Players may receive permission to join the game from the bartender if each can show proof of 1,000 g.p. or its equivalent in treasure or possessions.

Each night there will be a game in progress with 4-9 gamblers. Two men will be 6th-level fighters, one a 7th-level assassin and the rest level 0 fighters. Each gambler will have between 1,000-2,000 in gold or its equivalent. Ten percent of all winnings will go to the house (collected every hour), and the guards' purpose is to ensure the game is not interrupted by intruders and that the house gets its fair share. None of these gamblers will run from a battle or their money.

To play the game, each player rolls percentage dice and the player with the highest roll wins. The DM rolls for each gambler. Ante is 10 g.p.. Players must raise the bet before their die roll, which is then kept secret until their

hands are called. At that time, each player must show their die roll.

Guard (outside door), Skill 4 Human Fighter

AC: 6, HTK: 25 (4D10), Stats: Average, Equipment: Ring Mail, Longsword

(2) **Guards, Skill 6 Fighters**

AC: 4, HTK: 30, 24 (6D10), Stats: Average except Strength: 13+

Equipment: Chain, Shield, Longsword

Gamblers

(2) **Skill 6 Human Fighters**

AC: 5, HTK: 25, 32 (6D10), Stats: Average, Equipment: Chain, Longsword

(1) **Skill 7 Human Assassin**

AC: 2, HTK: 28 (7D6), Stats: Average except Dexterity: 18 (-4 to AC)

Equipment: Leather, Shield, Longsword, +1 Ring of Protection

THE ALCHEMIST

This shop appears as a small and rather simple white wooden shop. Three steps lead from the street to the shop and sitting on one step is a blind beggar with a tin cup. The beggar will answer questions (GM's choice). The beggar is actually a fighter.

This beggar was hired by Maret as protection from Greasel Greedigutt who is very much in need of a talented

alchemist. If the beggar is robbed, he will not fight. He will only fight if Maret calls for help or he is personally attacked.

The Alchemist is owned by two lawful-good brothers, Maret the alchemist and Wrythe, an Skill 11 non-combative wizard. Both men are very old, well over 100 years, and have learned much in their lifetime about potions and magical items. If attacked, they will try to escape through the use of potions (Maret) or by teleporting (Wrythe) to the Halls of Power (Building E) or the Guard House.

Wrythe has a 90% chance of being able to identify any magical item and its powers. Maret has a 90% chance of being able to identify any potion by its smell, color, and viscosity. The ability of being able to identify items is not well known in town, and that's the way the brothers want it.

Beggar, Skill 5 Human Fighter

AC: 6, HTK: 36 (5D10), Stats: Average

Align: Lawful Good, Equipment: Scale Mail (under rags), +2 Longsword hidden beneath a step. The sword is easily available if the beggar or Maret is attacked.

L1 LABORATORY A section of the back wall in the shop is actually a hidden doorway and will swing around in a complete circle. Both sides of the door are identical. Behind this door is a 20x20 foot laboratory that the brothers share.

On the north wall are shelves on which completed potions are stored. On it, in addition to several (3D4) of the standard potions and a wide variety of herbs and spices (GM's choice), are two phials of Cure Serious Wounds, 3 drinks per bottle. Each drink will restore 12 HTK.

There is also a phial of Phenomenal Phantasmal Force, 2 drinks per bottle. Whoever drinks one-half the bottle will be able to project himself or his image as a Phantasmal Force in a 30 foot radius in all directions he moves. The first animal or image that the person mentions after drinking this potion will instantly become the Phantasmal Force. For everyone who believes this vision, the Phantasmal Force will appear in place of the imbiber. This potion will not interfere with normal speech or movement, and the person will not have to concentrate to main-

THE ALCHEMIST'S

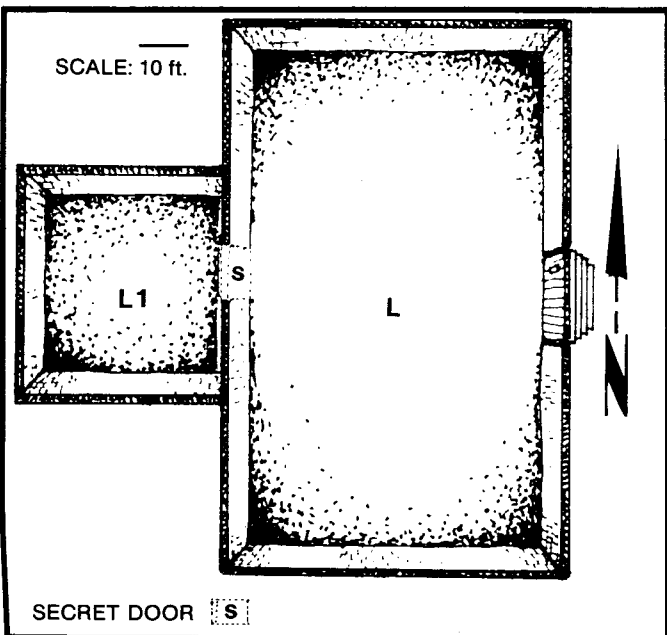

tain the vision. It will remain one round per level of the individual who drank it.

On a table is a Potion of Lawful Good (one use). Whoever drinks this potion will become lawful good, regardless of current alignment, for 6-8 turns.

Maret and Wrythe would not normally sell these potions, as it took them some time to develop and purify the liquids. However, if either brother could be convinced of a lawful good need, he would readily sell these potions for a minimum cost of 1,000 g.p. each.

If an adventurer appears of an alignment other than good, the brothers will refuse to sell or prepare them anything. While they cannot always tell alignment, they are 75% accurate.

M BUTCHER SHOP

N PERRAT'S PAWN SHOP

Owned by Peter Perrat, a tall, skinny man with a hacking cough. He dresses in ragged pauper clothes bought second hand at the resale shop and goes barefoot even in the dead of the winter.

Perrat buys items at 50% of their value and then re-sells the item at a 100% markup. He always appears so poor and underfed that most Shallotville residents hesitate to argue about his outrageous rates. Perrat keeps a steel safe in the back room filled with 36,000 g.p.

O SPOT O'WINE

P TAILOR

Q FURRIER

R DOCTOR

An excellent physician, Rubas Gloin, cures most diseases with local herbs that he has studied and researched

for many years. He and Maret are close friends—most of Maret's herbs are gathered by Rubas.

SRELIABLE ARMOR

This shop is owned by Holter Linx, an old and bristly ex-adventurer. If players can withstand his constant reminiscing, they'll be fitted with top-notch armor and learn useful information about the local area (up to the GM's discretion).

Holter Linx, Skill 5 Dwarven Fighter

AC: 10, *HTK:* 25 (5D10), *Stats:* Average, *Equipment:* Shortsword

TRELIABLE WEAPONS

Linx's nephew, Debasso Slims owns this shop. Slims charges as much as he thinks a person will be willing to pay for a particular item.

Debasso Slims, Skill 4 Dwarven Fighter

AC: 8, *HTK:* 28 (4D10), *Stats:* Average *Equipment:* Dagger, or if he has time, he'll grab his +2 Battleaxe from under the counter.

UFRUIT AND VEGETABLES MARKET

VGUARD HOUSE

This is the office of Enaj's top city police officer, Crane Kiffer, charged with keeping the town's peace and order (and arresting anyone whom Enaj happens to want put behind bars). This office houses three large cells, occasionally filled with local thieves or drunks. Political enemies are rarely imprisoned, as they are almost always exterminated swiftly and secretly. Kiffer also has a city guard of 50 men whom he can summon with a bell.

For quicker action, he has 4 Guardsmen with him in the office at all times, who are faithfully loyal to Kiffer—unless offered a minimum of 500 g.p. each. Kiffer cannot be bought and is extremely vengeful. If he feels someone has wronged him, he will never forget it.

Crane Kiffer, Skill 7 Human Fighter

AC: 1, *HTK:* 46 (7D10)

Stats: 18/25 (+1 to hit/+3 to damage), 13, 10, 15 (-1 to AC), 13, 09

Align: Lawful Neutral, *Equipment:* +1 Plate, Two-Handed Sword

(4) **Guardsmen, Skill 3 Human Fighters**

AC: 5, *HTK:* 18, 17, 21, 15(3D10)

Stats: Average, *Equipment:* Chain, Bastard Sword

WSHALLOTVILLE STABLES

Run by Jack Longrove, the stable is old and run down. Jack charges 1 s.p. to board a horse overnight. While the horses are not abused, they are ignored.

XCHURCH OF THE DIVINE SPIRIT

Pastor John preaches undying in the almighty Pastor John (with occasional mention of the deity Dagda). Inside the church at the front is a platform for sermons. In the center of the platform is a glass table with two gold candelabra (100 g.p. each), a silver cup (150 g.p.), a silver bowl with holy water (300 g.p.), and during Sunday morning services, a large tin box filled with anywhere from 50-150 g.p., 50-150 s.p. which is emptied into a golden bucket (1,000 g.p.).

Pastor John, Skill 5 Cleric

AC: 8, *HTK:* 35, *Stats:* Average

Spells: Command, Cure Light Wounds, Sanctuary,

Hold Person, Silence, Know Alignment, Prayer.

Align: Chaotic Neutral, *Equipment:* Leather, Silver Flail

YSHALLOTVILLE SCHOOLHOUSE

A converted barn, the entire school is in disrepair.

ZPOOR MAN'S MAGIC SHOP

Rented by Lester Laslow, an old with a white beard to his knees. Lester has a small laboratory on the counter and prides himself on being able to make any kind of potion "while you wait." There is a large wooden sign over the counter that says, NO REFUNDS.

Lester never formally studied as an alchemist apprentice, so his potions are unreliable at best (each potion has a 70% chance of either not working or backfiring). Lester moves from town to town selling his magic potions, always one step ahead of the last town's guard.

One potion that does work was purchased by Lester elsewhere—A Potion of Invisibility, which he keeps in his pockets at all times in the event that an irate customer returns. Lester's prices are cut-rate (-35%) and if you're in a hurry, he'll make you any potion to order within 30 minutes, or in an emergency, 15 minutes.

AASHALLOTVILLE ASSASSINS GUILD

Leader of the Guild, Ralph Stelths, has respect for any ruler of the town, and if asked, will do their bidding for a price. If attacked, Stelths will rapidly slip away and there will be no one else in the building, but the party will be quickly and efficiently eliminated.

BBTRAVELER'S TAVERN

Hangout for orcs, half-orcs, and criminals with no alliances except to themselves.

CCHOME OF QUICK EDWARD

A man who owns most of the town. Picks up bricks from crumbling buildings and resells them for refurbishing projects to the city. Has political ties to anyone in power. Quick Edward is immune to the leaves' spell. He used his immunity, however, to profit from Yelad's Illusion of a sound city. A sharp, cutthroat businessman, he has his own small army protecting himself and his business.

Four of the fighters protect his home, which is an elaborately furnished 11 room mansion with 4 bedrooms, a large kitchen, dining room, parlor, library, smoking room and pantry. The other fighters and the assassin guard his warehouse, but will come immediately at the sound of a fight.

The main treasure is in a secret door beneath the carpet in the smoking room. The door is trapped. If any attempt is made to open it without the correct key, a Magic Mouth will be triggered, screaming "Thieves! Looters! Peasants!", repeating for 6 rounds.

Inside the door is a small compartment containing 3,000 g.p., 1,500 s.p., and 100 c.p., two sets of accounting books, and 2 golden boxes, one outlined in pearls (400 g.p.) and the other engraved with the name EDWARD in silver (300 g.p.). Inside the pearl studded box are ownership papers to most of the town's real estate. In the other box are 8 gems worth a total of 2,000 g.p., and two scrolls (Invisibility and Knock).

(8) **Skill 3 Human/Half-Orc Fighters**

AC: 5, *HTK:* 16 each (3D10), *Stats:* Average

Equipment: Chain, Longsword

(1) **Skill 4 Human Assassin**

AC: 4, HTK: 22 (4D6), Stats: Average except Dexterity: 17 (-3 to AC)

Equipment: Leather, Small Shield, Longsword

DD EDWARD'S BUILDING SUPPLIES

The business is a large brick warehouse filled with bricks, cement and scattered debris. At the back of the warehouse is an officer with a small safe in the southeastern corner. The safe contains 1,000 g.p., and 400 platinum and has 30 holes easily visible around the outside.

This safe is also trapped. Any attempt to open it without the correct key (both keys are always in Quick Edward's

possession), will cause 30 razor-sharp spikes to shoot out from the center of the safe, each spike causing 6 HTK damage. Anyone standing in a 10 foot radius of the safe will be hit with 3-18 spikes. The business is guarded at all times by four of the fighters and the assassin. For statistics, see Building CC.

EE FISH MARKET

FF UNDERTAKER

MINTER'S TOWER

The Tower sits on a small hill on the north side of town. Lush grass and wild flowers grow up to a point ten feet around the Tower, where the grass abruptly ends and the ground is burnt and barren. The Tower is 50 feet high and 45 feet around, built of stone blocks. A round black door is on the south side, constructed of petrified wood. Two black statues of men-at-arms flank the door. They are ten feet high and chiseled out of rock.

The Tower was built years before by the original town founders for minting the tons of gold bullion hauled from the mines. The first two floors of the Tower were filled with guards to prevent raiders from invading the mint. Only the town's trusted minters knew the secret of the mirrors on the topmost floor, and how the gold was teleported from the mines, (See AREA 4A, the Mirror Room). The Mirrors were to be used in the case of a siege.

When Yelad came to power, he took the Tower as his personal stronghold and strengthened the brick face. In this way, he supervised the minting operation.

When Enaj took control of Shalloville, she filled the first two floors with guards to deter Yelad's followers from maintaining open contact with the rats, and to keep townspeople from exploring the Tower and learning the secret of the mirrors. She has transported the town's treasury of gold and minting equipment to her stronghold in the north as a safety precaution, for her castle is heavily guarded and difficult to reach. She also knows she cannot re-open the mines until a way is devised to destroy the rats in the underground caverns, who are still loyal to Yelad.

As soon as anyone opens the front door into the Minter's Tower, the two rock figures flanking the door will begin to turn. After two rounds, streams of liquid fire shoot from each statue's eyes, burning an area 10-feet around the front half of the Tower. The liquid continues spreading until a circular area surrounding the Tower burns with fire for one turn. Then it extinguishes itself.

Players who have not entered the Tower within two rounds after opening the door will be shot with liquid fire, causing 6D6 damage unless protected from fire by magical means, (roll under dexterity to save for half damage).

1 LOBBY

The door opens into a 20 foot circular lobby. The walls, ceiling and floor are covered with smooth stones. To the east of the room is a wooden staircase leading up along the side of the Tower wall. Against the northern wall is a large brass bell, four-feet high, and along the wall next to it is a long brass hammer.

Whenever guards come or leave the Tower, they ring the brass bell twice, alerting all the guards that one of their own people have come or gone. If the fire surrounds the Tower and no bell is rung, guards know that an intruder has entered.

Both Bugbears and Hobgoblins will let characters safely pass through the Tower if they are wearing griffon badges from the Queen.

2 FIRST FLOOR CORRIDOR

Behind the wooden door is a corridor with another doorway at the end of the corridor and two doors halfway down the corridor, one facing east and one facing west.

2A & 2B BUGBEAR BUNK ROOMS Whichever door players enter, Bugbears will be waiting to attack (unless players have rung the lobby bell twice). Each 10x15 foot bunkroom will be filled with four Bugbears. The other Bugbears on the level will attack the party from behind in the next round.

If players hesitate in the corridor for longer than one round, all doors will open and the Bugbears will attack. From the doorway at the far end of the corridor (AREA 2C) will charge two Bugbears holding half eaten chicken legs. Each Bugbear carries 3-18 s.p.

(10) **Bugbears**

AC: 5, HTK: 14 each (3D8+1), M: 9"

Att: 1, Dm: 2-8 or with Longswords (1-8)

2C BUGBEAR KITCHEN Using the sink is an old woman, dressed in rags. On the western wall is a narrow doorway. The old woman tells you she was captured from the neighboring city of Detro one year ago to serve as slave to the bugbears. She knows nothing else about the Tower except that there is a secret door in the pantry where the Bugbears occasionally exit and return.

2D PANTRY Inside the narrow doorway is a small 4x4 foot pantry filled with several dead chickens, swarming with large maggots. A thorough search of the pantry reveals a door on the northern wall leads to another staircase which winds along the Tower wall ending in a land-

ing and a large black door. Listening at the door, muffled whispers can be heard in hobgoblin, although the exact words cannot be understood.

3 HOBGOBLIN'S KITCHEN

The door is not locked and five Hobgoblins have stopped their card game and are prepared to anyone entering the room. One Hobgoblin will be stealing the wagers still left on the table (100 s.p.). Underneath one Hobgoblin's chair are two hidden aces. After one round of combat, the Hobgoblins described in 3A will join the fight.

(5) Hobgoblins

AC: 5, *HTK:* 5, 5, 4, 2, 3 (1D8+1), *M:* 9"

Att: 1, *Dm:* 1-8 or with Morningstars (2-8)

3A HOBGOBLIN'S BUNKROOM Through the double doorway are nine Hobgoblins and two drunk Hobgoblins carrying bottles of wine as well as Short Swords. These 11 Hobgoblins will come charging into the kitchen in one round after players have entered. Each Hobgoblin carries 1-8 s.p. Each dresser is filled with old, ragged clothes. In three drawers, players will find 3 g.p. stuffed under clothes.

(11) Hobgoblins

AC: 5, *HTK:* 5 each (1D8+1), *M:* 9"

Att: 1, *Dm:* 1-8 or with Short Swords (1-6)

Special: Two are drunk: -2 to hit probability and -1 to damage.

3B SERGEANT'S BUNKROOM Inside is a 5x12 foot room with a straw mattress against the northern wall and two wooden chairs in the northwest corner. One small area in the ceiling which appears as dark mortar is actually a black leather handle. If pulled a door will open downward.

3C LANDING The secret door leads to a landing and a flight of 12 stairs leading up. Waiting in the hidden room is the Sergeant Hobgoblin. In the handle of his sword is a small compartment containing a key (to the treasure chest hidden behind the staircase).

Sergeant Hobgoblin

AC: 3, *HTK:* 9 (1D8+1), *M:* 9"

Att: 1, *Dm:* 1-8 or with +1 Longsword (2-9)

Equipment: Leather Armor, +1 Cloak of Protection, +1 Longsword

Under the staircase hidden in the shadows is a locked metal chest and small pouch. Inside the pouch is a bottle filled with a milky liquid with a large white label on it that says, "Poor Man's Magic" and beneath that, UNDEAD CONTROL. Drinking the potion will have no affect on the undead; however, it will cause the imbibers hair to immediately fall out.

Inside the chest are 300 g.p., 600 s.p., and 20 c.p. as well as three more pouches: one blue, one purple and one red. The blue pouch contains 3 azurites (worth 75 g.p.); the purple pouch contains one violet garnet (worth 500 g.p.); and the red pouch contains a opal-studded necklace and matching bracelet (worth 200 g.p.).

The stairs lead to another landing with a large wooden door with the face of a gargoyle carved into the center of the door. The gargoyle's protruding tongue serves as the door handle.

4 RESTING ROOM

This 20x10 foot room has a bed against the eastern wall, and a door against the southern wall. The door is locked. A small window is located 10 feet high on the northern wall.

MINTER'S TOWER

LEVEL 1

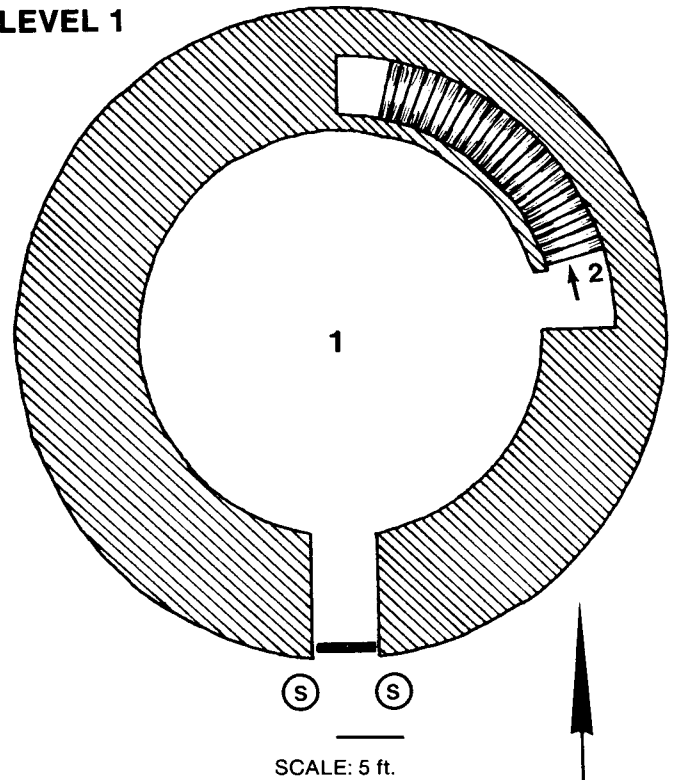

LEVEL 2

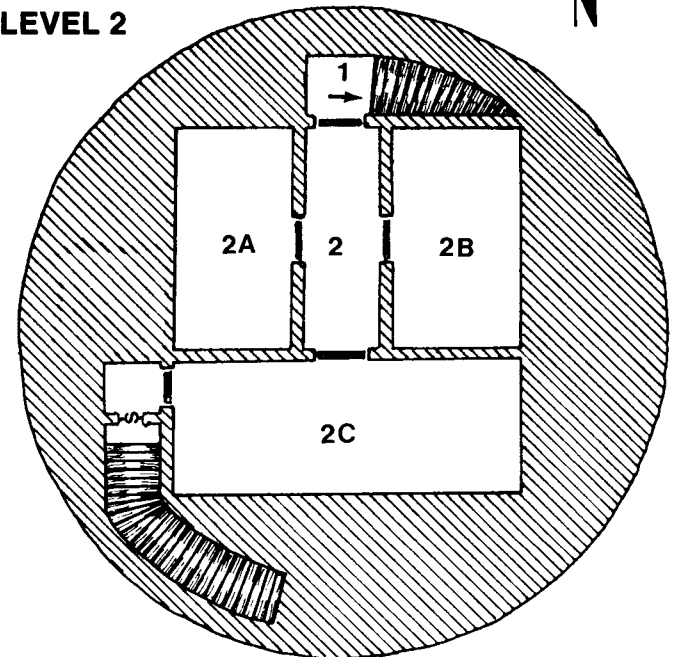

DOOR
SECRET DOOR



STAIRWAY
STATUE



4A MIRROR ROOM The floors and walls and ceiling are covered with smooth bricks and three windows peek out over the countryside. They are 10 feet up on the eastern, western and southern walls. Beneath the window on

MINTER'S TOWER

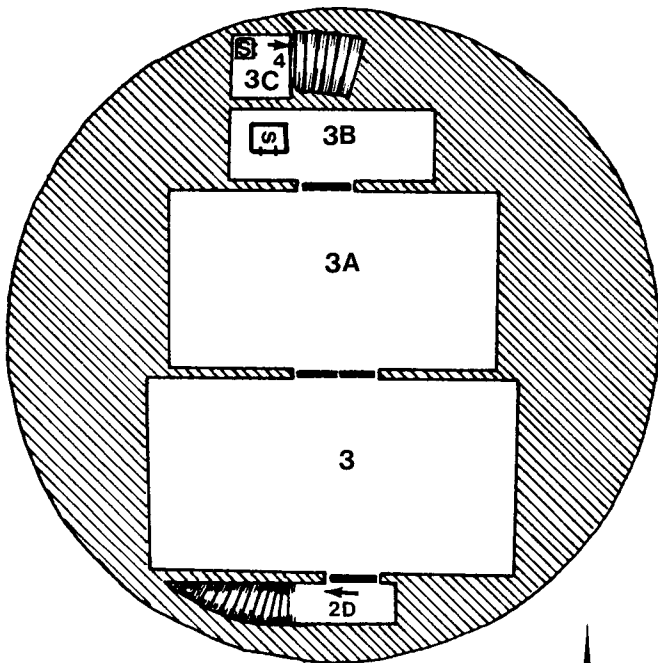

LEVEL 3

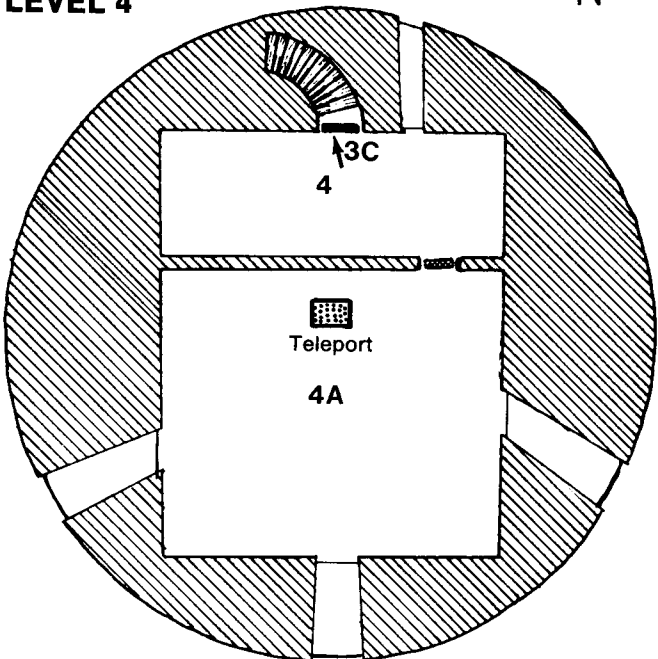

SCALE: 5 ft.

LEVEL 4



DOOR 
STAIRWAY 

SECRET DOOR 
WINDOWS 

the southern wall are five large circular objects, all covered with black cloths. The northern wall is painted white. The paint is magical, but otherwise unidentifiable.

Only the Minters knew that Mirror III was the mirror

which activates a teleport platform at dawn and sunset (which is at 7:00 a.m. and 7:00 p.m., local time). When Yelad came into power, he used the mirror room to enter the mines and the rat caverns below the city and negotiated a pact with the rats.

Unveiling Mirror I, characters will see their reflection as fat. Mirror II gives no reflection at all. Mirror III appears to reflect normally with no distortion. Mirror IV gives no reflection but looks deep into a forest. Mirror V reveals scenes of hideous torture, writhing humanoid bodies and screaming victims.

If Mirror I is broken, it will shatter into 100 glass pieces, all turning into miniature cakes within 2 rounds. The cakes are delicious but eating more than 10 will cause the character's movement to slow by 3" for six turns.

If Mirror II is broken, a hidden trap door immediately above it will dump 500 shiny minted gold pieces on the player's head, causing 1-4 HTK damage. The trap may be refilled with weight up to 1500 g.p., but will not reopen until the mirror is renewed and broken again.

Mirror III will not break.

Mirror IV will shatter into 100 glass pieces, each turning into a bush seedling, growing at such a rapid rate that unless the seedlings are removed, tossed out the windows or burned, they will grow to full-sized trees in 8 rounds, completely filling the room and blocking any reflection from any of the mirrors.

If Mirror V is shattered, the character who delivers the smashing blow will become permanently insane unless a Remove Curse or Dispel Magic is cast. Types of insanity will be: 1-25, hallucinatory insanity; 26-50, pathological liar; 51-75, monomania; and 76-100, megalomania.

When the light of the sunrise or sunset is reflected off the magically painted north wall onto Mirror III, characters will be able to look into Mirror III, the Wheel of Reflection (which rotates in a circle at the same speed as the small hand of a clock) and see the reflection of a shadowy box behind them, 5x5x7 feet high. Characters stepping into the box will be teleported within 1 round to the RAT CAVERNS, AREA 1.

Any character remaining on the teleport platform in the rat caverns will be teleported back to the tower on the next round. This transportation system works for two hours, both a.m. and p.m. If the reflected light does not strike the Mirror III, the teleport system does not work. Thus, Mirror III is covered to prevent anyone in the Caverns from teleporting to the Tower.

All the shattered Mirrors are restored when the reflected light of a sunrise or sunset hits their frames. The Mirrors were to be used during a siege. When broken, Mirror I provided sustenance, Mirror II a place to keep especially valuable treasures, Mirror III, an easily closable secret passage for entering and exiting the Tower, and Mirror IV a source of fuel.

Mirror V was used as a method of torture. Prisoners were thrown into the mirror, breaking it. The prisoners answered every question thereafter for two hours. The mirror over the decades has become overcharged, putting too much energy into the torture. It has presently ten charges too many. The charges can be dispelled either through additional breakage (after being restored) or by the use of a like number of Dispel Magics. The mirror can be safely broken with no harm to the breaker by throwing gold pieces made of pure gold at it—a method the minters used to test the suspected assayers in their midst.

THE RAT CAVERNS

For time indeterminate, there have been rat caverns beneath Shallotville. Yelad gave the rats free run of the caverns and the necessary tools to expand the caverns. The rats served as guardians of the mines. Political enemies and stragglers through town were sometimes detained and sent to the mines as slaves. Other townsfolk were miners for several generations and lived below ground with their families in the small underground town of Hidden Gold. Other miners lived in Shallotville and entered and exited the mines through the forest (CAVERNS AREA 14).

DESCRIPTION OF THE CAVERNS

The main passageways in the rat caverns are 20 feet wide, 15 feet high and somewhat oval. Three men could easily walk through it, although only three would be able to fight. Seven Giant Rats or Wererats could walk through and fight. The curved edges will be used by Giant Rats in a fight, but they are too slippery for adventurers unless they have an 18 dexterity or some magical means of standing or support (DM's discretion). The side passages are ten feet wide and eight feet high. There is room for two men to walk side by side, but only one may fight (due to the curvature of the floor). Here, four Giant Rats may walk and fight. Wererats in human form will use character rules for fighting and walking in passages.

All the caverns are slick with debris strewn about amid numerous puddles. Anytime a character runs, there is a 10% chance of slipping per 100 foot run. In melee, there is a 10% chance of slipping every round (-1% chance for every point of dexterity above 16 and +1% for every point of dexterity below 12). If an injured character falls into the slop during melee, there is a 4% chance of contracting a chronic, mild skin disease.

All the rooms in the complex are 15 feet above the caverns, assuring they are dry. The inclines are very steep (rising at a 45 degree angle). Anytime a character on them is hit in combat, there is a 30% chance of falling. Dwarves, gnomes and thieves will have a 5% chance of falling.

Throughout the caverns are various, small holes where normal rats live as well as numerous passages closed off by rocks and earth from the tremor two years ago.

MONSTERS IN THE RAT CAVERNS

Random Encounters occur on a roll of 1 on a D6 once every turn. AREAS 25, 25A, and 25B have no wandering monsters.

1-3	2-12 Giant Rats
4-5	2-8 Giant Rats and one Elite Giant Rat
6	2 Huge Spiders
7	1 Green Slime
8	1 Ochre Jelly
9	Wererat Kerrigan, an Elite Giant Rat, and 6 Giant Rats
10	Wererat Elisi
11	(01-75) Wererat Cyrus
	(76-00) Wererat Ralph and 3 Giant Rats
12	(01-50) Greasel, and 4 Elite Giant Rats
	(51-00) Greasel, Kerrigan, 6 Elite Giant Rats and 12 Giant Rats

If a dead character is rolled, reroll for a new encounter. If there is a multiple character appearance, eliminate the character that previously appeared.

There can be any number of Slime, Jelly, or Spider appearances. Giant Rats and Elite Rat encounters may need to be adjusted if there are not enough animals left alive, since these monsters are in limited supply: 200 Giant Rats and 50 Elite Giant Rats (GM: Be sure to keep track).

Green Slime

AC: 9, HTK: 10, 9, 14, 12 (2D8), M: 0"

Att: 0, Dm: Feeds on living and metallic material

Special: Cure Disease spell kills Green Slime. It can also be scraped off.

Huge Spiders

AC: 6, HTK: 16, 12, 18, 15 (2D8+2), M: 18"

Att: 1, Dm: 1-6 plus poison

Special: Can jump 3" on prey; surprises on 1-5 of a D6.

Ochre Jelly

AC: 8, HTK: 30, 24, 40, 29 (6D8), M: 3"

Att: 1, Dm: 3-12

Special: Lightning divides Jelly into one or more smaller creatures and causes half damage.

(200) Male Giant Rats

AC: 7, HTK: 3 each (½D8), M: 12"

Att: 1, Dm: 1-3 plus 5% chance of disease

(50) Elite Giant Rats

AC: 6, HTK: 17 each (3D8+3), M: 12"

Att: 3, Dm: 2-5, 2-5, & bite: 2-7 plus 10% chance of disease.

(5) WERERATS—as rats

AC: 6, HTK: see below (3D8+1), M: 12"

Att: 1, Dm: 1-8, Align: Lawful Evil

Special: Surprise on 1-4 of a D6; may only be hit by silver or +1 or better magic weapons; 50% or more damage causes lycanthropy

GREASEL GREEDIGUTT, Skill 9 Wererat Magic User

AC: 3, HTK: 30 (9D4)

Spells: Charm Person, Magic Missile, Detect Invisibility, Wizard Lock, Fireball, Invisibility 10-foot radius, Haste, Fire Trap, Ice Storm, Conjure Water Elemental
Equipment: Dagger, Key (to Room 23A)

Background: The unquestioned leader of the rats is Greasel Greedigutt. Greasel used to be a lawful good magic user. No task was ever too great for him to attempt—until he attempted to rid the city of Enid-Argyll of the dreaded Wererat Obediah.

In his attempt, his band of adventurers were slain and he was badly injured and taken captive. As the effects of lycanthropy tortured and warped his mind, Nigel renounced his past life and dreamt only of revenge. Taking the name of Greasel Greedigutt, he began to make his own plans. Greasel knew that if he could get to his magic books, he would once again be able to use magic. He had no trouble convincing Obediah to let him retrieve the books, so eager was Obediah for more power. With his spellbooks back in hand, Greasel found a home in the caverns underneath Shallotville. With the aid of Yelad, he planned a return to Enid-Argyll to overthrow Obediah.

The two made a pact, which allowed both of them to concentrate on their main goals. It was an advantageous

pact for both parties, and the rats became devoted followers of Yelad, converted by Yelad's Wererat cleric, Kerrigan.

Unfortunately, Greasel's spellbook (as well as his treasure and a key given to him by King Yelad for safekeeping) are under the guard of the Ghouls in AREA 24. Ever since his alchemist was killed by falling rocks during the earth tremor, Greasel has been unable to safely enter the Ghoul's lair because he'd used up his Potions of Undead Control. Since that time he's been looking to hire or capture an alchemist for the manufacture of Undead Control potions. He doesn't want Lester Laslow from Poor Man's Magic Shop and he unsuccessfully attempted to kidnap Maret from the Alchemist, who escaped in the nick of time by drinking a Gaseous Form potion. Greasel will pay a fine price to retain the service of an alchemist.

KERRIGAN, Skill 7 Wererat Cleric

AC: 3, *HTK:* 42 (7D8)

SPELLS: Protection from Good, Sanctuary, Cure Light Wounds (2), Silence (15-foot radius), Hold Person, Resist Fire, Spiritual Hammer, Animate Dead, Dispel Magic, Detect Lie

Equipment: Hammer, Staff

Background: Before Kerrigan's birth, his pregnant mother was bitten by a Wererat with no apparent reaction. However, the baby was born with the face of a rat. Distraught, the parents brought the baby to Yelad for sacrificing. But instead of killing the infant, Yelad substituted a human baby at the last moment, saving the young Wererat.

ELISI, Skill 3 Wererat Thief

AC: 8, *HTK:* 12 (3D6)

Equipment: 4 Daggers, *Special:* Elisi will be encountered in human form (unless there is a full moon).

Background: Elisi is a beautiful human whom Greasel Greedigutt found among the prisoners and took to be his mate. He bit her severely enough to remain alive but become a lycanthrope. Elisi was angry and depressed, finding herself hideously ugly as a Wererat. Because she has not been a Wererat for long, she cannot shape change at will.

If she is encountered alone, there is an 85% chance that she will aid adventurers and attempt escape. If she is with other Wererats and they are attacked, there is a 55% chance that Elisi will turn on the Wererats.

RALPH OBDERN, Skill 2 Wererat Fighter

AC: 6, *HTK:* 15 (2D10)

Equipment: +1 Shortsword, Damage: 4-9 against humanoid creatures, 1-6 against other creatures

Special: Ralph will only be found in Wererat form.

Background: Ralph wants to forget his earlier human life and can't believe he ever found enjoyment working as an errand boy. To help himself forget, Ralph keeps nothing in his room, except his straw bed. He doesn't even want treasure! Ralph will resent the presence of any humans in the caverns.

His sword is also able to detect invisibility up to 20-feet away. The holder must concentrate in order for the invisible person or object to come into view. In the hilt of the sword is a compartment where Ralph keeps the key to his room.

CYRUS MASHPEE, Skill 3 Wererat Fighter

AC: 6, *HTK:* 20 (3D10)

Equipment: +1 silver dagger (*Dm:* 2-5) and Longsword

Special: Cyrus enjoys his human form and will almost always be found as such (85% chance).

Background: Cyrus always wears a gold chain (50 g.p.) and two rings on each hand. One ring on his left hand is magical (Ring of Free Action). The other is a diamond ring (1,500 g.p.).

Cyrus is very talkative, and if the adventurers are friendly, he will tell them the history of the caverns and the pact between Greasel and Yelad. He is also the Wererat chosen by Greasel to accompany the adventurers to the ghoul lair.

1 YELAD'S TEMPLE

The teleport in the Tower transports you to a large raised platform on the eastern end of an elaborate 20x30-foot temple. Next to the platform is a 2½ foot high blood-stained stone slab used as an altar, and to the side of the altar is a bronze one-door cabinet, 2½ feet high. On the far southern end of the room is a portion of the wall which has been blocked off by fallen rocks. On the western end of the room is an open cavern exit.

There will always be a rat guard with 8-24 Giant Rats in this room, and a 20% chance of an Elite Giant Rat leading or supervising. If there are no Elite Giant Rats in the room when the adventurers appear, there is a 25% chance that the Giant Rats will decide that one stately looking character is Yelad and the others are his servants. If this is so, the rats will be at his command. If the rats do not think Yelad has returned or an Elite Giant Rat has told the foolish rats that Yelad is dead, the rats will immediately attack. One rat will disappear out the exit and warn Kerrigan the Cleric.

Rats who believe one of the adventurers is Yelad will follow him until an Elite Giant Rat tells them they're wrong, at which point, the rats will all attack.

If Kerrigan is summoned, he will appear within 1-4 rounds and will immediately attempt to halt combat with the rats long enough to find out why the adventurers have come to the caverns. If the players state that they are on a mission for Yelad, Kerrigan will use his Detect Lie spell. If players have agreed to help Yelad at the tavern, Kerrigan will see they are telling the truth and will aid them. However, if players have agreed to help both Enaj and Yelad, Kerrigan's reading will be slightly cloudy. While he will still aid adventurers, he will be highly suspicious. In either case, he will escort players to AREA 1A, and then to AREA 1B along with several Giant Rat guards.

If players are only helping Enaj or if they still wear the griffon badges Kerrigan will order an immediate attack. He then will attempt to leave to warn the other Wererats and Greasel. Kerrigan, Greasel and 10 Elite Giant Rats will assemble just east of AREA 19. Both Kerrigan and Greasel will be in human form in order to cast spells, especially to conjure a Water Elemental.

Within 2 turns, Wererats Elisi, Ralph, and Cyrus along with 20 Elite Giant Rats, 40 Giant Rats, and the thieves from AREA 10 will have assembled on the main passage outside of AREA 13, and will begin searching for intruders.

The rest of the rats will only appear if a battle is in progress at a rate of 1-6 every 2 rounds.

The 10 foot stone statue of Yelad in devil form has a 1,000 g.p. jacinth for each eye. If removed without casting a Dispel Magic, the mouth of the statue will open and breathe fire, causing 11-20 HTK damage to anyone standing within a 20 foot radius of the statue; half damage if the character saves against a breath weapon. The mouth opens and breathes fire only once.

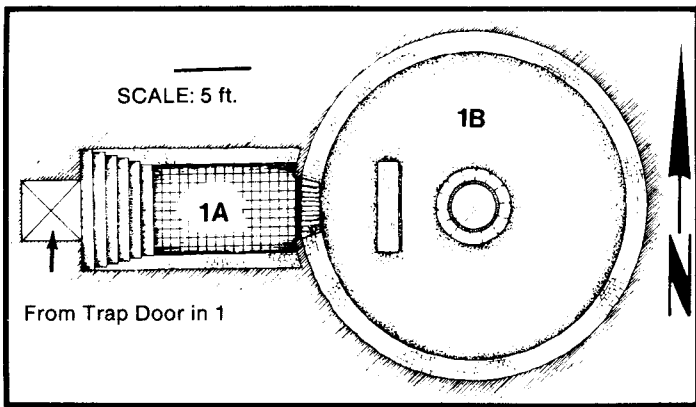

At the foot of the altar, is a locked trap door. Only Kerrigan has the key.

1A TRAP DOOR TO CORRIDOR At the foot of the altar, the trap door can be opened with Kerrigan's key, a Knock spell or a successful open locks roll by a thief. Inside, it leads down a staircase to a 10 foot wide corridor made of one foot square marble tiles. The corridor is 10 feet high and leads to a large oak door.

This door, marked with a Glyph of Warding, is locked and only Kerrigan has the key. The Glyph will cause 22 pts. electrical damage, or save for half.

1B KERRIGAN'S CHAPEL Behind the oak door is a 15 foot diameter room. In the center of the room is a three foot high platform upon which rests a 6½ foot long, three foot wide block of solid pink quartz. Inside the quartz is a skeleton with a missing head and missing rib bone. Resting on top of the quartz is a purple velvet pillow, and on top of that is a skull. Built into the platform is an ornate, silver scroll case, obviously empty. Around the platform is a circular kneeling bench and the balusters of the railing appear to be letters or runes. There is a small, bloodstained altar west of the platform. The chapel walls are painted with 3 frescoes of Yelad.

If this room was entered without using Kerrigan's key, an erinyes will be gated-in to collect a character's soul (prefers Evil alignment).

Erinyes

AC: 2, *HTK:* 30 (6D8+6), *M:* 6"/21"

Att: 1, *Dm:* 2-8 with dagger, save vs. poison or faint for 1-6 rounds

Special: Has Rope of Entanglement; May cast Detect Invisible, Locate Object, Invisibility, Polymorph Self, Produce Flame, or Summon a Erinyes (25% chance); May Cause Fear in all who look at them.

The skull on the purple pillow is King Yelad's, and Kerrigan keeps this as a sacred relic. Once a month, he holds services with the Wererats attending.

The magic runes on the balusters of the railing spell:

DEATH DOES NOT TAKE ALL

THE STRUCTURE OF MAN HOLDS THE POWER

Characters may use this clue to learn the secret of how the magic leaves will work for them. This is more fully explained in the Introduction. These words are found only on the balusters and in the book of Yelad's Teachings.

If Kerrigan is helping characters, he will take to this room and instruct them to place the scroll into the empty

scroll case built into the platform, and then for characters to kneel on the circular kneeling bench. (If characters enter this room on their own, they must do both actions—placing the scroll in the scroll case and kneeling on the bench to activate the skull). Once these instructions have been followed, the skull on the pillow will activate and speak. Slowly and clearly, the King's voice will say:

*Those who study language know
of magic spells from long ago.
Words that banish good or evil,
make soldiers strong and kings grow feeble.*

*EMETH comes from such a time.
The word means truth for all mankind.
Erase the E, the word spells METH,
The meaning changes from life to death.*

*Use this riddle, remember well;
the Yelad's future it may foretell.
Be brave, be strong, complete the quest.
Your destiny is manifest.*

Kerrigan will now escort players to AREA 22 (Greeditgutt's Audience Chamber), along with rat guards. If anyone should attempt to remove the skull from the pillow, several actions will happen simultaneously. The platform will begin to sink into the floor until the top of the pink quartz is flush with the floor; the doors will slam shut and cannot be opened with any force of magical means. The room's two side walls will begin closing in. If nothing is done, the players will be squashed and killed within 4 rounds. Then, at once the walls will move apart and the room will right itself.

However, as soon as the skull or any object of the same weight is replaced onto the purple pillow, the situation will immediately reverse.

Any player directly involved in removing Yelad's skull will be immediately blinded for 2 rounds and will develop a mild but chronic gastro-intestinal disease which will cause a corresponding body odor, making each affected character lose four charisma points until they can be cured.

(If magical means are used to lift the skull, i.e. with an unseen servant while characters wait outside, the room will crush the skull and players will be able to scoop up the pieces of bone once the room has returned to its normal position).

2 KERRIGAN'S ROOM

On the north is a small, round oak table and chair. The table has a book resting on top, titled the TEACHINGS OF YELAD, which Kerrigan printed himself. Inside the front cover of this book, the following words are written:

**DEATH DOES NOT TAKE ALL
THE STRUCTURE OF MAN HOLDS THE POWER.**

On the southeast floor is a mattress. Piled under the table are various bones, and several small rats are gnawing the last remains of flesh off a body. On pegs on the north wall are various robes, a hammer, two large pouches, pieces of studded leather armor. Two pairs of black boots are on the floor. There are quills on the table, but no ink because Kerrigan writes only in blood.

The hammer, pouches, armor, boots, etc. will only be hanging on the pegs if Kerrigan is in Wererat form. The pouches contain a silver mirror; a small, straight piece of iron; and phials of human blood, mercury, brass dust, bone powder, and strips of human flesh.

Under the mattress is a trap door, which can only be lifted by pulling a leather strap. The strap is poisoned with a strong contact poison which will cause persons failing their saving throw to faint in one turn, taking 2-8 HTK damage per turn, unless a Neutralize Poison spell is used, which will stop further damage. If nothing is done, the character will die.

2A TREASURE ROOM There is a ladder going down into a 10x10 foot room which has an iron chest in the middle of the room. The entire room is six inches deep in bones.

The iron chest is locked and the chest is protected by a Subterranean Lizard. The Lizard will obey anything Kerrigan says to him. Inside the chest are 600 g.p., a small pouch of emeralds worth 2,800 g.p., a Potion of Human Control (which Kerrigan will use if he has advance notice of intruders), and a scroll of two (2) Neutralize Poison spells.

Subterranean Lizard

AC: 5, HTK: 29 (6D8), M: 12"

Att: 1, Dm: 2-12, double damage on a natural 20

Special: This Lizard is especially small with a length of only 5 feet. However, it is just as strong as its larger brothers.

3 ELISI'S ROOM

This 15x15 foot room resembles a human's room. There is a bed in the northeast corner, a dresser with a large attached mirror on the eastern wall, and a large hope chest along the southern wall. On top of the dresser is an ivory comb with turquoise inlaid E.J.N., a make-up box, a floppy hat, and a beaded coin purse.

Inside the six-drawer dresser are human clothes. The hope chest is locked and the key is always with Elisi. Inside the chest are many personal items, including her jewelry box, which contains a ruby ring (500 g.p.), two golden earrings (70 g.p. each), a jade ring with an aquamarine stone (250 g.p.), a pearl necklace (400 g.p.), and an oriental amethyst amulet (500 g.p.).





There is a 40% chance of encountering Elisi in her room, if she has not already been killed.

4 GIANT RAT GUARD LAIR

This room is a total mess with filth and debris covering the floor. There will always be between 6-18 Giant Rats in this 15x15-foot room.

5 ENTRANCE INTO THE TOWN OF HIDDEN GOLD

This was apparently a large entrance into another area, but it is now blocked by dirt and rocks, except for a small

DOOR		STALACTITES & STALAGMITES		TRAP DOOR	
SECRET DOOR		UNDERGROUND PASSAGE		PORTCULLIS	

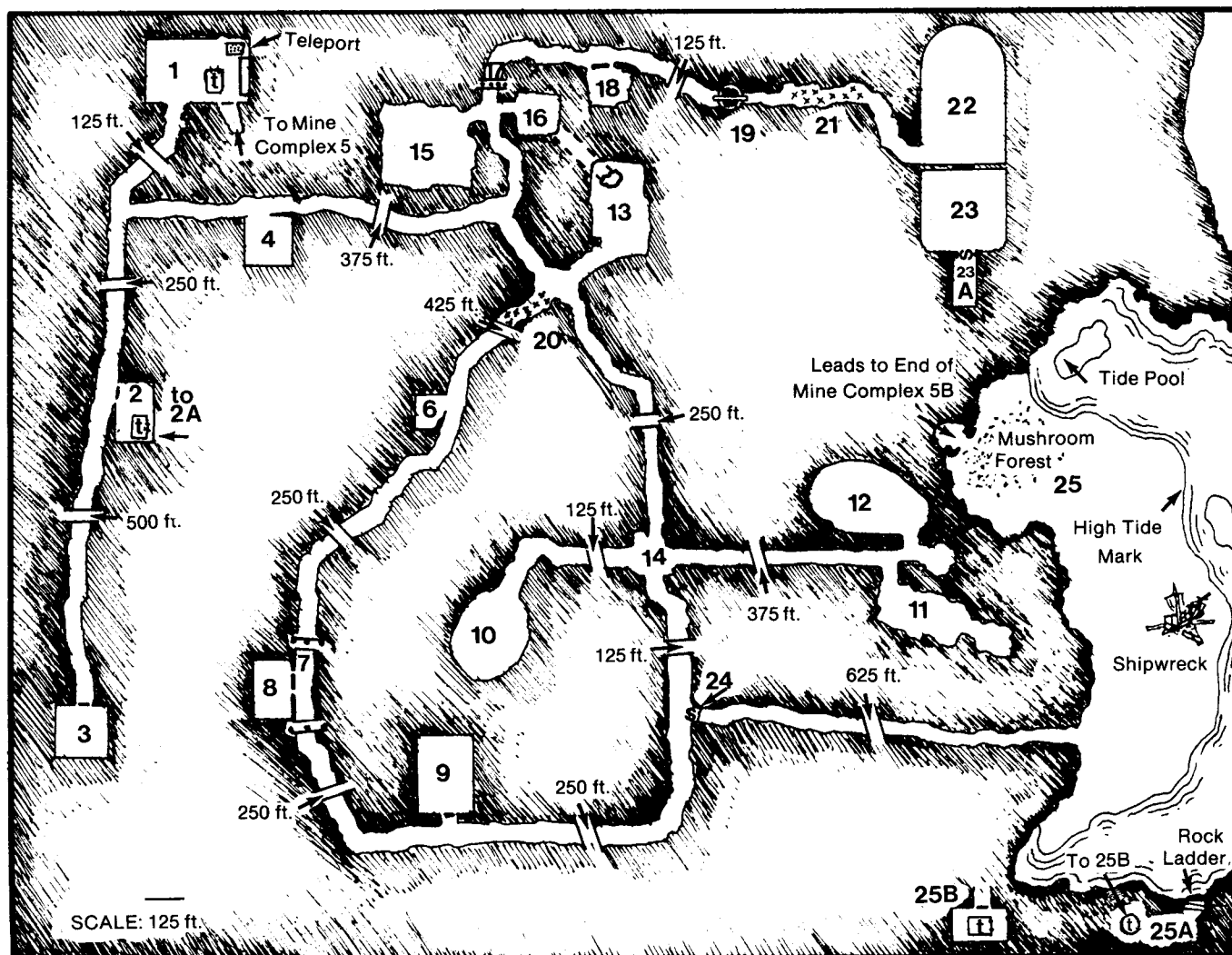

opening that is approximately the size of Giant Rat hole. If a character tries to crawl through the opening, he would see a winding, uneven area about 2½ feet high by 3 feet wide, obviously damaged by a cave-in.

Each time that a character (or a party) attempts to crawl through this 55 foot long tunnel, there is a 25% chance of a cave-in. There is a 40% chance that the cave-in occurs in front of the character or party, a 40% chance in back of the character or party, and a 20% chance that the character or party is buried.

If a character or party is buried, there will be enough air for 40 minutes. It will take 10 minutes to dig five feet down the passage. A cave-in will cover 20 feet.

To determine how far into the tunnel the character or party has wandered before the cave-in, roll a 12-sided die and multiply rolls of 1-10 by 5-feet to get the distance travelled. A roll of 11 means a total cave-in for the entire length of the tunnel as someone sticks their head through the entrance (not harming the character). A roll of 12 indicates a total cave-in immediately after exiting.

After passing through to the end of the tunnel, characters find themselves in a regular passageway 10 feet wide and 8 feet high, which has not been damaged. A passageway leads northwest and southeast.

If characters turn northwest, the passageway will slowly rise for 100 feet, leading to a pillared archway of gold. (Any attempt to take the archways without providing a means of supporting the tunnel will cause an immediate collapse of the passageway between 5A and 5 causing 10-100 HTK damage). The golden archway is worth 5,000 g.p.

Beyond the archway, the passage opens up to a 75 foot wide x 20 foot high cavern area which appears to have once been an underground humanoid town.

5A HIDDEN GOLD MINING TOWN A central street is the only passageway through the town and rubble. On either side of the street are broken and collapsed buildings. Portions of the rock walls surrounding the town appear to have fallen loose and crashed into the town's buildings and homes. Skeletons are strewn throughout the debris. The earth tremor totally destroyed the town and its inhabitants, 2 years ago.

If an adventurer enters any building, it has a 50% chance of collapsing, causing 2-20 HTK damage. If characters continue down the street for approximately 500 feet they will come to what appears to have been a temple area. The northern wall of the temple still stands, the others have crumbled into dust. In front of the standing wall is a broken altar.

A search of the altar area will reveal an intact decanter of oil, a small gold gong (50 g.p.), and wooden pipes wrapped in golden strands of rope (Pipes of the Sewer, 8,500 g.p. value).

Beyond the altar is a rotting and unhinged door. Behind the door are stairs leading down a short distance into a passageway 5 feet wide and 8 feet high leading to a solid wall of fallen rock. (This used to be an entrance from the surface, but was blocked during the tremor).

5B GOLD MINE TUNNEL Empty sconces are spiked into the rock wall every five feet. After a short distance, the passageway begins to sharply descend. After approximately 750 feet, characters begin to pass small, dirt tunnels spaced about 100 feet apart, leading away from the main cavern passageway. These shafts are 4 feet wide and 5 feet high, supported by wooden beams.

MINE COMPLEX

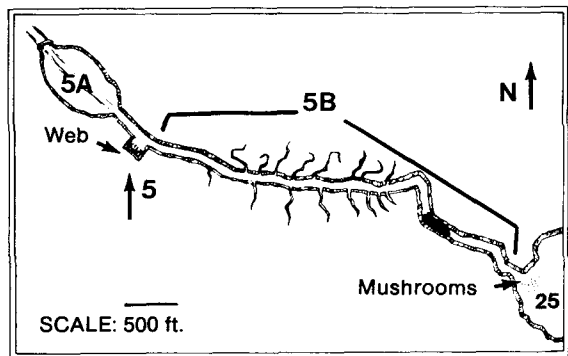

At the far end of each dirt tunnel are walls of gleaming rock, speckled with gold. On the ground lay various mining tools.

After another 1300 feet, the passageway will begin to turn northeast and will level off. After 450 feet, the passageway will sharply turn southeast once more and continue for 300 feet, during which time the cavern walls have become noticeably wet and mossy. The moisture steadily increases until the floor of the cavern is covered with 12-inches of slimy, filthy water.

Every round in this water each character has a 5% chance of contacting a severe muscle infection from the bacteria in the water.

The passageway begins to slope upwards. The walls are still wet, but there is no more standing water on the cavern floor. Turning a rounded corner, characters see six steps leading up. The passageway continues, still on an incline, and is quite humid.

After 300 feet, the cavern walls begin to become jagged and the floor, rocky. The cavern narrows to only 3 feet wide and 5 feet high. After another 50 feet, the cavern ceiling drops to only 2½ feet high. After another 50 feet, fresh air and muted light appear from a narrow rock opening above. Characters can squeeze through this narrow opening on the edge of a large field of enormous mushrooms (AREA 25).

6 RALPH OBDERN'S ROOM

This is a very small 7x9 foot room with only a straw bed in the center. Loose straw is scattered across the floor. There is a 30% chance of encountering Ralph in his room, and if he is in his room, three Giant Rats will be guarding his door.

7 CORRIDOR

There is a portcullis on each end of the 30 foot corridor and inside each portcullis are two Elite Giant Rat guards.

This is the corridor leading to the prisoner hold. The mechanism for opening each portcullis is on the inside of the corridor, 5 feet from each gate. Entrance to the corridor will be denied to anyone not knowing the password: **FOOD STORAGE**.

8 PRISONER HOLD (FOOD STORAGE)

This 15x20 foot room is where the Wererats take their prisoners. There are three sets of wrist and ankle shackles on each wall. Presently there are three prisoners in the room.

One of the prisoners is a thief who failed to pay the Thieves Guild its share.

Another prisoner is the Queen's sorcerer and the King's assassin, Grinmare. Torture and hunger have left Grin-

mare shaken and weary, and he has forgotten even simple spells that he once had memorized. After two days complete rest, he would be able to fight again, but not before that. **NOTE:** Freeing and returning Grinmare to Enaj will earn the party her trust, a pardon for any past actions, 4,000 g.p. for each party member, and a safe conduct out of the area if the party doesn't want to find the box of seeds.

The last prisoner is a cleric dressed in torn orange robes and very near death from abuse. He is Henry of the Willows, a rash and lusty cleric, who now mourns his sinful life and spends all waking hours praying and repenting to his deity. (Henry has the same deity as one of the clerics in the party, if any.)

If Henry is rescued, he will beseech the characters to cast an Atonement spell on him before he dies in order to soothe the anger of his deity.

Skill 4 Human Thief

AC: 10, HTK: 14 (4D6)

Stats: 08, 09, 07, 12, 07, 10

Align: Neutral

Grinmare, Skill 12 Human Magic User

AC: 10, HTK: 39 — reduced by torture to 14 (11D4+1)

Stats: 09, 18, 12, 15 (reduced to 07), 12 (reduced to 05), 10

Align: Neutral

Henry of the Willows, Skill 5 Elf Cleric

AC: 10, HTK: 23 — now at 1 (5D8)

Stats: 10, 12, 15, 07, 10 (reduced to 03), 13

9 CYRUS MASHPEE'S ROOM

This 15x25 foot room is furnished with a canopied four poster bed at the far eastern end of the room. A large feather-filled mattress is covered with fine linen sheets, two woolen blankets and two eiderdown pillows.

In the center of the room is a round reading table with an oil lamp on top. Near the bed is a bookshelf. Against

the southern wall is a four-drawer dresser. In a windowed cabinet on the northern wall are ten fine crystal glasses and five brandy snifters. On the bottom shelf of the cabinet are two large decanters of brandy.

On the far eastern wall is a door. Also, inside the windowed cabinet on the northern wall of the room is a bottle which looks like wine. The bottle is almost empty. This is really a Potion of Gaseous Form, which Cyrus will drink if threatened.

On the eastern end of the room is a locked door leading to a walk-in closet. Cyrus always has the keys with him. Inside the closet are various cloaks and robes, boots and shoes, walking canes, hats and belts. There is also a locked chest in the corner. Inside the chest are 175 g.p., 54 s.p., and 110 c.p.

There is only a 20% chance of encountering Cyrus in his room. Cyrus loves creature comforts, and is the only Wererat in the caverns who will capture a person for ransom. He uses the ransom money to furnish his room.

10 THIEVES REFUGE

This is a 30x30 foot oval room with a large doorway, but no door. Inside are eight cots, a barrel of dried fish and a barrel of slightly bad water. Clothes are scattered over the cots and floor, and a pair of boots are in the southeast corner behind a broom. This room is a refuge for thieves and other low-lives.

If they enter the room, players will encounter Chance Centenary, who defected from the city guard when he learned that Enaj was investigating his references (he double-crossed employers more than once). Players will also encounter two thieves, Arno Prikin and Horst Tritzer, who recently robbed Bottoms Up Tavern in Shallotville.

In order to receive entrance into the caverns, Chance had to pay dearly and only has 25 g.p. left. Arno and Horst still have a canvas sack filled with 500 g.p. and two 500 g.p. Jacinths.

Chance Centenary, Skill 5 Human Thief

AC: 6, HTK: 22 (5D6)

Stats: 12, 10, 08, 16 (-2 to AC), 07, 09

Align: Neutral Evil, Equipment: Leather, Longsword, Dagger

Arno Prikin, Skill 3 Human Thief

AC: 7, HTK: 10 (3D6)

Stats: 07, 11, 12, 15 (-1 to AC), 12, 08

Align: Neutral, Equipment: Leather, Longsword

Horst Tritzer, Skill 3 Half-Orc Thief

AC: 7, HTK: 12 (3D6)

Stats: 09, 12, 11, 14, 11, 11

Align: Chaotic Evil, Equipment: Leather, +1 Ring of Protection, Longsword, Throwing Dagger

11 GIANT RAT LAIR

This Giant Rat lair is full of old bones, rags, straw and rat pellets. The room is 15x30 with a small tunnel that leads to another 10x15 foot portion of the lair. The lair is very damp and slimy wet (debris cannot burn), and only two-feet high.

In front of the room will be 4-48 (4D12) Male Giant Rats. Through the narrow tunnel in the back of the room are 10 Female Giant Rats with 30 baby rats. These females will be equal in ability to the males, but when protecting their young, will fight with +2 and show no fear.

In this area, adventurers must fight on their hands and knees (-6 to hit and half damage from large weapons; normal to hit and damage with small weapons, such as daggers and shortswords).



(10) **Female Giant Rats**

AC: 7, HTK: 3 each (½D8), M: 12"

Att: 1, Dm: 1-3 plus 5% chance of disease

(30) **Baby Giant Rats**

AC: 7, HTK: 1 each (½D8), M: 09"

Att: 1, Dm: 1 plus 5% chance of disease

12 RAT LAIR

This room is exactly the same as Area 11.

13 RAT LAIR

This 15x30 foot lair is filled with debris, including straw, rags, bones, etc., also wet and slimy. This Giant Rat lair is a female guard post. Like rooms 11 and 12, the debris will not burn. In the room will be 32 Giant Rat Females. Searching the debris in this room will produce 15 c.p. per turn, up to a total of 600 c.p. Also, on the fourth turn of searching, the group will find a door to a 2x2 tunnel which leads to a secret door in the Training Room for Elite Giant Rats. (AREA 16).

(32) **Female Giant Rats**

AC: 7, HTK: 2 each (½D8), M: 12"

Att: 1, Dm: 1-3 plus 5% chance of disease

14 ENTRANCES

These entrances are 4x3 foot circular tunnels with metal rungs spaced evenly for climbing. The tunnels lead up 60-feet and exit in the forest, where they appear as old tree stumps, (FOREST AREA U). At all times, one Elite Giant Rat and eight regular Giant Rats guard the bottom of these entrances out of the caverns.

15 ELITE GIANT RAT QUARTERS

This 30x35 foot room contains 25 beds of straw. It is quite clean because the Elite Giant Rats take all other refuse out of the cavern. At the back of the room is a six-foot long wooden chest. There will always be 8 Elite Giant Rats in this room. All will immediately attack any intruder. There are four males and four females.

The chest is locked and the key is hidden beneath one of the beds of straw. Inside the chest is treasure containing 400 g.p., 3 sapphires (300 g.p. each), a large golden crown studded with four emeralds (2,000 g.p.), a pearl necklace (400 g.p.), a silver ring with a malachite setting (Ring of Feather Falling), and a plain platinum ring (Ring of Weakness).

16 TRAINING ROOM

This 15x15 foot room is where Greasel trains young Elite Giant Rats how to fight.

17 GUARDED PORTCULLIS

Behind this 15 foot high portcullis stand two Elite Giant Rats. The portcullis is iron with 10 half inch square openings, making the door extremely heavy. On the guarded side of the portcullis is a gong. Next to the gong is a pulley system.

The Elite Giant Rats will only open the portcullis for a Wererat or Elite Giant Rat who says the password: GREED. Because of the small openings in the iron portcullis, there is only a 5% chance of a missile getting through. The gong will be sounded in case of attack, and will draw anyone in AREAS 14, 15, 17, 21, and 22 to battle. The pulley system opens the portcullis.

18 ALCHEMIST LAB

The 15x15 foot room is filled with fallen rocks and debris. If players move through the rubble, they will see a table in the center of the room, covered with many broken

burners, tubes and other apparatus for growing molds. Across the floor are broken glassware and various volumes on alchemy. To the east of this table are a few small crates filled with apparatus that survived the earth tremor. In one crate is a small tube with an orange mold with black specks. (This mold will cure a wound completely if spread upon the area of injury. There is only enough for one application.)

19 WATER HOLE

This is a water hole extending 30 feet across the entire passage and 90 feet deep. A three-foot wide bridge crosses over the water. The only purpose of this foul water is for Greasel to have a large source of water in order to conjure a water elemental in case of attack.

20 & 21 STALAGMITE AND STALACTITE FORMATIONS

These stalagmite and stalactite formations impede the movement of humans and Elite Giant Rats, alike, who will move at quarter movement.

22 AUDIENCE CHAMBER

Greasel's Audience Chamber is 50x30 and has three spiraled stone pillars on each side of a large, silver throne at the northern end of the room. Covering the floor are all types of human bones, all spotless having been picked clean by rats.

If the adventurers informed Kerrigan that they are on a mission for Yelad (and Kerrigan did not detect a lie), Greasel will meet the party in this room. When Greasel meets the adventurers, he will be flanked on his left by Kerrigan and on his right by Elisi. Adventurers will be led in the room up to the first set of pillars, where they will be told to send a spokesman to the throne.

Once the characters are inside the Audience Chamber, two Elite Giant Rats will protect the entrance into Greasel's room, and two will guard the passage out of the chamber.

Greasel will offer characters safe passage through the rat caverns and a guide to the entrance of the ghoul's cavern if they agree to return his spellbook from the ghoul's lair, (wherein also, of course, lies the key mentioned in Yelad's scroll).

IF THE CHARACTERS AGREE, Greasel will instruct Cyrus Mashpee to be their guide, along with six Giant Rat guards, to AREA 24. Greasel will tell the characters to seek the high ledge in the ghoul's cavern.

IF THE PLAYERS ATTEMPT A DOUBLE-CROSS, Greasel will cast an Ice Storm on the main group of characters, while Kerrigan and Elisi (55% chance of Elisi turning on Greasel and siding with characters) will take care of the spokesman.

Once players get out of the Ice Storm, they will be fireballed. Then Greasel will turn invisible and attempt escape, leaving Kerrigan, Elisi, and the Elite Giant Rats to finish off the party. If the battle turns against the Rats, Kerrigan and Elisi will attempt to escape. Attempts to surrender from the character's side will be accepted.

23 GREASEL GREEDIGUTT'S PRIVATE ROOM

The 30x30 foot room is divided in half. The northern half is beautifully furnished and carpeted with a four-poster canopied bed against the eastern wall. On the northwestern wall is a four-drawer dresser. On top of the dresser are colognes, a comb and hour glass. Next to the

bed is a one-drawer nightstand with a hooded lantern on top. Leaning against the nightstand is a staff with the head of a rat.

The southern half of the room is filthy, bug-infested with heaps of bones and straw. On the far southern wall is a secret door.

The room is divided like this because Greasel prefers the northern side when he is in human form using magic. In rat form, he prefers the southern, filthy side.

Inside the four-drawer dresser are the finest clothes money can buy. Inside the nightstand are two phials. Each one is labelled according to its contents: Human Control and Gaseous Form. Both of these potions will be used by Greasel if he feels endangered. The staff is not magical.

23A CLOSET On the center of the southern wall in the closet is another secret door. On the western side of the wall next to the secret door is a loose stone. If the stone is removed, a spike can be seen sticking into the secret door. Removing the spike will cause the secret door to slide open; however, Greasel has cast a Fire Trap spell on the spike. Touching the spike will trigger the spell. (The trap will not harm the caster).

Behind this secret door is a locked chest, but not trapped. Greasel has the key. Inside are two star sapphires (3,000 g.p.), also 80 p.p., 640 g.p., and 55 s.p.

GHOUL'S TREASURE CAVERN

If characters accept Greasel Greedigutt's offer—safe passage through the caverns and a guide to the entrance of the Ghoul's lair in return for his spellbook—the characters will be led by Cyrus Mashpee and six Elite Giant Rats to AREA 24. During this travel time, Cyrus will be quite willing to talk to friendly adventurers about the history of the caverns, including Greasel, Kerrigan, and Yelad and his son Mynor Yelad.

24 ENTRANCE TO THE GHOUL'S CAVERN Cyrus stops at what appears to be only another section of cavern wall; however, when a round, protruding rock is turned and pushed inward, a secret door is revealed and Cyrus, still talking, will enter the secret 10x10 foot corridor.

However, upon his entering, he will be surprised by two Ghouls who have escaped their locked lair. Cyrus must save against paralysis or fall to the ground unconscious for 2-8 turns. Two rat guards will take Cyrus to Kerrigan if he is hurt. The other four guards will help defeat the Ghouls.

(2) Ghouls

AC: 6, HTK: 11, 8 (2D8), M: 9"

Att: 3, Dm: 1-3, 1-3, 1-6 plus paralysis

Special: Immune to Sleep and Charm spells.

If Cyrus is brought to Kerrigan, Kerrigan will immediately send 6 Giant Rat guards to AREA 24 to let him know how the other guards have fared and if the characters continued into the lair or left to further explore the rat caverns. If the other guards are dead and the characters cannot be seen, two Giant Rats will remain at the entrance and four Giant Rats will begin to scout around the rat caverns. If the Ghouls are defeated and Cyrus is still leading, he will guide characters down a 1700 foot corridor that gradually declines (meeting no more ghouls) until he comes to a locked portcullis. A section of earth has been dug beneath the portcullis with thin, bony fingermarks, leaving enough space for a Ghoul to easily slip through. Cyrus Mashpee has the key to the locked portcullis.

If characters are on their own and decide to continue, they will find enough space beneath the portcullis to easily enter the Ghoul's cavern.

The rat guards will not enter beyond this point and neither will Cyrus. The guards and/or Cyrus will wait at Area 24, insuring no more Ghouls escape.

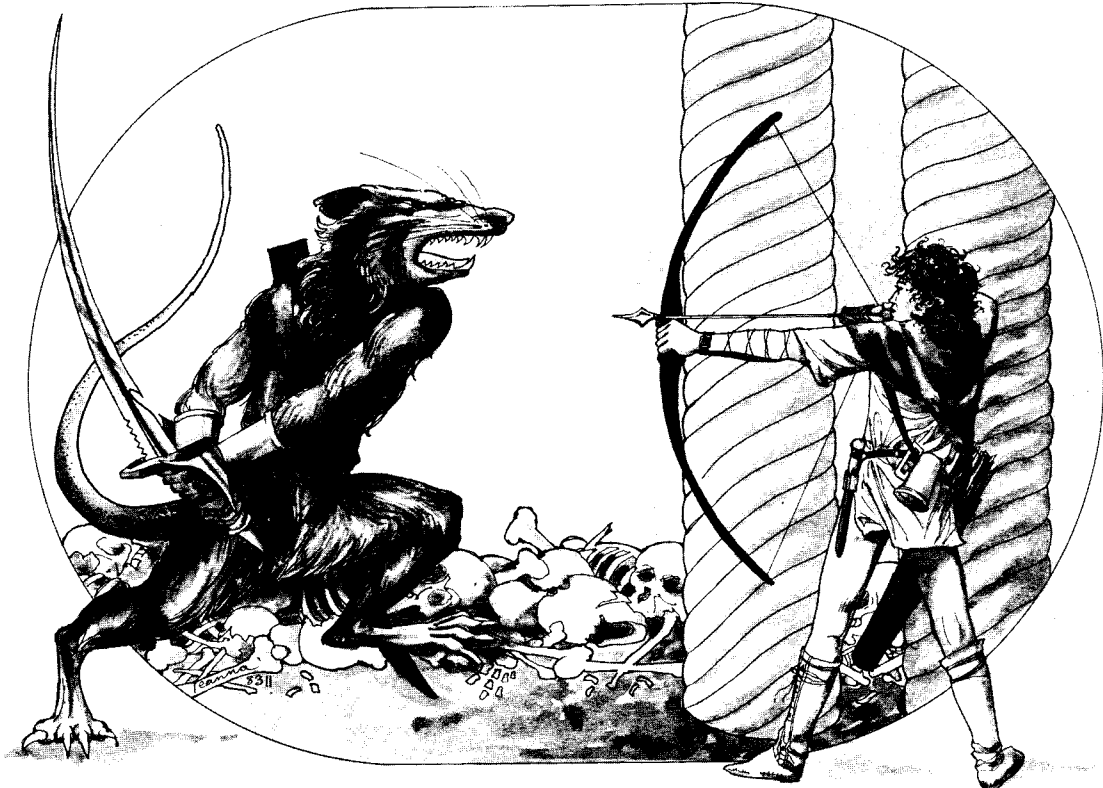

25 GHOUL'S CAVERN

A damp cavern about 190 feet from north to south and 60 feet from east to west. To the north is a small forest of giant red mushrooms. Most of the mushrooms have had their tops torn off leaving just the tall (4 feet high) thin stems standing. To the south a rock ladder is carved in the cavern wall. This ladder leads to a ledge 70 feet above the surface. In the center of the cavern lies the wreckage of a long galley. The deck is riddled with large holes and its mast is broken in half. Further east, the cavern leads to a rocky shoreline.

Areas 25 and 25A are the haunts of 21 Ghouls and 4 Ghasts. They have been locked in here ever since Greasel Wizard Locked the entrance to the burial vault (25B) and cast Permanent Walls of Illusion and Force across the eastern exit (to the sea) of the cavern. The Wall of Illusion prevents any vessel passing this area from seeing that there is a cavern opening and the Wall of Force keeps anyone from entering from the sea or leaving towards the sea.

The undead in the cavern now serve as unwilling guards of Greasel's spellbook and treasure which is stored inside their lair. They have not been fed well since Greasel's alchemist died and they are ravenously hungry.

The locations of these undead depend on the tide. If the tide is out, the cavern will be covered with damp sand, except for pools of water in the northwest corner and just northeast of the shipwreck. Three Ghouls and one Ghast will be eating mushrooms in the north end. They will be +1 on rolls to hit and +3 on damage rolls since they have ingested the magic mushrooms. Another seven Ghouls will be devouring the meat of shellfish they have found in the pool by the northwest corner. At the pool by the shipwreck, four more Ghouls will be feasting on shellfish. If the tide is in, all the undead will be in their lair (Room 25A). The tide will be considered at its high points at 3 a.m. and 3 p.m. and it is at its low mark at 9 a.m. and 9 p.m. The high tide line almost reaches the galley and covers up the point where the undead climb the rock ladder.

(21) Ghouls

AC: 6, *HTK:* 9 each (2D8), *M:* 9"

Att: 3, *Dm:* 1-3, 1-3, 1-6 plus paralysis

Special: Undead. Immune to Sleep and Charm spells

(4) Ghasts

AC: 4, *HTK:* 20, 16, 24, 13 (4D8), *M:* 15"

Att: , *Dm:* 1-4, 1-4, 1-8 plus paralysis

Special: Undead. Immune to Sleep and Charm spells; cold iron causes double damage.

The mushrooms are magical, but most of the thin edible tops have been eaten leaving only 14 of any value. The thin tops are one foot in diameter and any character ingesting the complete top will, in 3 rounds, add 5 to their strength scores, 18 being the top score possible. The effect of these fungi lasts only for 10 minutes. If more than 3 tops are consumed in any 24 hour period the character will vomit and lose all bonuses. The fungi will keep for 3 days after picking. Nothing may help them keep longer and no spawn will have magical effects unless grown in this cavern.

If the adventurers enter the ship, they will only find the skeletons of long dead crew members.

The rock ladder requires a dexterity of 14 or better to climb without magical aid or help from a fellow adventurer. The undead climb the ladder very well.

25A GHOUL'S LAIR Upon reaching the ledge, characters will see a small cave which emanates a nauseating odor. Inside, characters will need a torch to see through the darkness. Using a torch, they will see that the cave is approximately 10 feet wide, 7 feet high and 35 feet long. Piled at the back of the cave are seven iron bound wooden chests, four paintings, a 42x20 inch leatherbound book and two cotton sacks. Standing in front of this treasure are many undead. See area 25, the tide section, for the correct number.

Each treasure chest contains 3,000 g.p. This money was being used by Greasel to buy an army to invade Enid-Argyll. This treasure was on board the ship when it sank.

One of the paintings is by the world famous Wainwright Cousins (recognized by any knowledgeable art student). It is called "The Death of Tural" and depicts a sea captain holding the severed head of a sea lion while standing on its body.

The other three pictures are farming scenes, painted by Rolling Wentworth.

The Cousins painting is worth 1,000 g.p. and contains a key between the backing and the canvas. (This is the key mentioned in Yelad's scroll). The Wentworth paintings are worth 35 g.p. each.

The small sacks contain scrolls and potions that Greasel put in the cave for safekeeping. One sack contains three scrolls: Rope Trick, Find Familiar, and Suggestion. The other cotton sack has two potions. One potion is purple and is of Giant Strength. The other potion is green with two drinks left. It is a Potion of Healing.

The large, leatherbound book is Greasel's spellbook. It has 11 first-level spells, 10 second-level spells, 9 third-level spells, 5 fourth-level spells, 2 fifth-level spells, and 1 sixth-level spell.

AREA 25B: BURIAL VAULT Above the treasure is a trap door which is difficult to notice unless someone is looking directly at the ceiling. This trap door opens into the center of a one-room burial vault.

The 20x10x10 foot burial vault has marble walls and a marble ceiling. On the room's southern end is a rectangular table covered with a fine linen cloth. On top of the table are three large pouches, a silver spear and an ornate golden chalice. One granite sarcophagus leans against each of the east, south and west walls. As players enter, they will be immediately attacked by three Shadows.

(3) Shadows

AC: 7, *HTK:* 16, 18, 20 (3D8+3), *M:* 12"

Att: 1, *Dm:* 2-5 plus Strength drain

Special: Unaffected by Sleep, Charm, and Hold spells or cold-based attacks; +1 or better magic weapons needed to hit; 90% undetectable, except under very bright or magical light.

The silver spear is +2 to hit. Inside each of the three pouches are four gleaming red fire opals (worth 350 g.p. each). The chalice can be sold for 1,000 g.p. However, if a cleric or druid drinks a liquid from the chalice, they will acquire the power to identify any one magic item. This can be used only once a day. If any person other than a cleric or druid drinks from the chalice, they will permanently lose two stamina points.

The sarcophaguses contain the skeletal remains of the three persons who once owned all these items. The three Shadows are the spirits of the dead men—Prevyn, Xydain and Eord the Bold.

MAUSOLEUM

Amidst the Shallotville graveyard is an area 240x240 feet bounded by a 7 foot spiked iron fence. Inside of the this area, a large, stone mausoleum is surrounded by a well manicured garden-like area. The fence entrance is centered on the northern fence and is locked at night, but unlocked during daylight hours. Leading up to the mausoleum are six stone steps. All doors are locked. Mynor originally meant to tell the party about the details of how to find his father's tomb, but decided not to when he saw the blue jay on the window cell.

1 CORRIDOR

It is dark inside the 5 foot wide by 40 foot long corridor. The walls are stone, and every 10 feet, sconces are cemented into the wall. Many candles are missing. There are four doorways leading from the corridor.

2 EMBALMING ROOM

The door to this 25x20 foot room is locked and bolted. Inside, it is very dark, and the odor of decay is present. In the center of the room are two 7 foot long preparation table. Against the northern wall is a large cabinet filled with dirty bottles. Beneath the large tables are two stone sarcophaguses, both empty.

3 CHAPEL

Continuing down the corridor, characters come to the second doorway against the western wall. This door is not locked and inside this darkened 25x20 foot room is a large altar against the western wall. In front of the altar is a kneeling bench made of marble. In the center of the floor, a large pentagram is painted, surrounded by painted runes and symbols.

4 BURIAL ROOM FOR PAST RULERS

This is a 20x40 foot room that serves as a burial room for all past rulers of Shallotville. Lined up against the southern wall are eight stone sarcophaguses containing each of the ruler's family remains.

5 BURIAL ROOM FOR KING YELAD'S FAMILY

This is a 30x20 foot room with two stone sarcophaguses against the southern wall. Hanging on the northern wall are two tapestries. One shows Yelad the King speaking to the masses, with the people shouting praise. The other tapestry shows the King, Cynthia, and Mynor Yelad, standing in the Halls of Power. Against the eastern wall is an empty sarcophagi, and on the wall behind it are paintings of spring and huge roses that intertwine and lead at last to the face of a young Mynor Yelad. In the southwestern corner is a small altar and in front of that is a stone kneeling bench, covered with down pillows. There are two secret doors in this room.

This section of the mausoleum was built by Yelad as a pretense of housing his remains after his and his family's death. However all the sarcophaguses are empty.

5A GUARDIAN OF THE RELICS This 15x10 foot room is comfortably furnished with a large sofa against the eastern wall and a kneeling prayer bench on the southern wall which faces a six-foot gold-plated statue of a devil (Yelad). All walls are covered in purple draperies.

On the sofa sits a human male in brown robes, who stands as soon as anyone enters the room. "Leave now!" he commands, "or become a living dead like we all are!" As soon as he finishes speaking, 10 Spectres appear from behind the purple drapes on the southern wall, and begin walking toward the characters with their arms outstretched and index fingers pointed at the intruder(s).

MAUSOLEUM

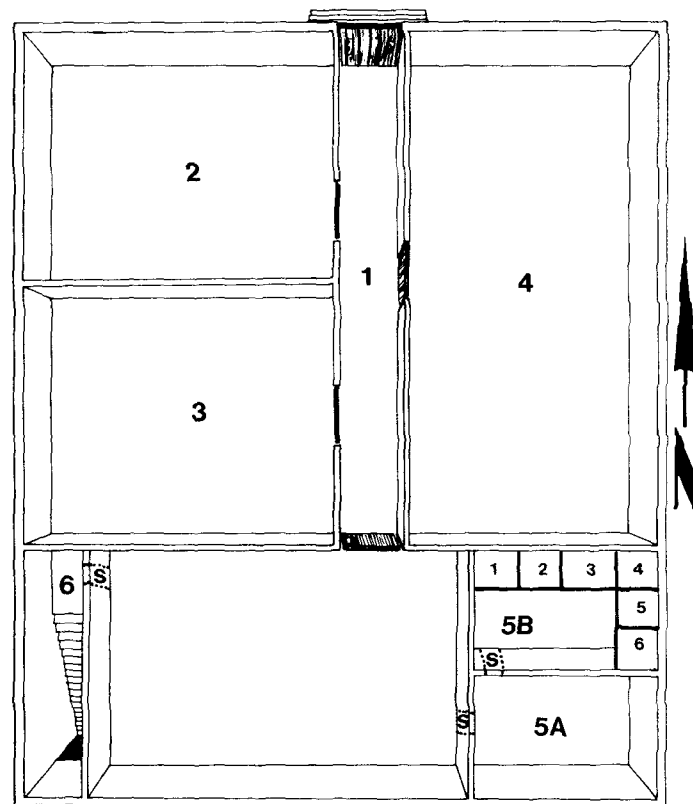

SECRET DOOR (S)

SCALE: 5 ft.

Skill 8 Human Cleric (illusion)

AC: 8, HTK: 48 (8D8)

Stats: average

Special: Cannot throw spells

(10) Spectres (illusions)

AC: 2, HTK: 26 (7D8+3), M: 15"/30"

Att: 1, Dm: 1-8 plus 2 level energy drain

Special: Unaffected by Sleep, Charm, and Hold spells or cold-based attack; +1 or better magic weapons needed to hit.

The figures are a programmed Permanent Illusion and can be rendered inactive by shouting, "Yelad the King!" at which time all Spectres will return to their position behind the drapes and the Cleric will return to the sofa. This allows true Yelad followers who know the passwords, to view the relics in 5B.

The spell acts as a Phantasmal Force, but when an illusion is hit, it feels as an actual hit and the character who scored feels as though he scored a successful blow. If the illusion of the Cleric is killed, the Spectres will disappear.

If characters leave the room, the Cleric will say, "And close the door when you leave." This will return the illusion to its state before the room was entered.

5B RELIC ROOM If characters enter through the secret door, they will find a 15x10 foot room containing six glass cases of relics of the King Yelad.

Case I has the original treaty signed in blood by King Yelad and Greasel Greedigutt.

Case II contains five rings: one ring is platinum; one ring is silver with a green chrysoberyl stone; one ring is brass with an aquamarine stone; one ring is jade with a diamond setting; one ring is gold. The ring case is lined in velvet and the stones of all the rings face the front of the glass case and look into the room itself.

Case III has a large book with the words engraved into its cover, "Teachings of Yelad." Case IV contains a large rib bone.; Case V, a mace and chain; and Case VI contains an oaken staff with the top carved into a devil face.

The first case, which contains the treaty, has no g.p. value.

The second case contains the five rings that Yelad always wore while in material form. The solid platinum ring is worth 500 g.p., the silver ring with the green chrysoberyl stone, worth 500 g.p.; the jade ring with the diamond, 4,000 g.p.; and the plain gold ring, the wedding band of King Yelad, is worth 100 g.p.

The third and middle ring is the only magical ring of the group. If the glass case holding the rings is broken, the sound of a triangle is heard instead of the sound of shattering glass. The triangle sound causes the aquamarine stone in the brass ring to fire a fan of flames equivalent to a Burning Hands spell of a Skill 12 magic user. This fan of flames shoots out three feet in front of the case and covers a horizontal arc of 120 degrees. The ring (worth 5,000 g.p.) can work only 11 more times before the stone drops out and cracks, rendering it worthless.

The ring fires at whatever the aquamarine stone faces and it will only fire when the sound of a triangle is heard. This can mean that it may fire when the possessor does not want it to and it also may fire at the owner.

The third case contains the original teachings of King Yelad that Yelad wrote himself, describing the quickest and most effective means of reaching eternal happiness in Hell. On the inside cover of the book, the following words are engraved in gold:

**DEATH DOES NOT TAKE ALL
THE STRUCTURE OF MAN HOLDS THE POWER**

The fourth case contains the third back rib of Yelad. The inscription says it will give the rib's possessor immunity from all fire and the highest constitution possible (both untrue).

The fifth case contains the mace and chain of the King. Taken from his bedside at death, this mace is +3 to hit and damage, and also poisons its victims. The weapon is lawful evil aligned, causing 20 HTK of damage to any good character each time it is touched. It causes 15 HTK damage to any neutral character and 10 HTK damage to a chaotic evil.

The sixth case contains the talisman of King Yelad. The mere act of touching the oaken staff with the top carved in Yelad's devil face will cause alignment to automatically change to lawful evil and the character to age 30 years.

Carved in lawful evil alignment language on the side of the talisman are the words: YELAD'S INFERNO. Study-

ing this has a 10% chance of summoning Yelad, who is now a Lemure. Speaking the inscription has a 20% chance of summoning the dead King.

Lemure Yelad

AC: 7, HTK: 19 (3D8), M: 3"

Att: 1, Dm: 1-3

Special: Immune to Sleep, Charm, and Hold spells; regenerates 1 HTK/round. Slaying Yelad will return him to hell and will force him to serve an extra fifty years as a Lemure.

6 SECRET STAIRWAY

It leads into the entrance to the crypt that King Yelad built immediately following his son's leaving. Yelad built it to protect the leaves in the hope that his son would one day return to claim the throne. But King Yelad was not willing to wait until that day, for he longed to return to Hell and prayed often for Dispater's forgiveness. Therefore, the crypt was built in the event that Dispater allowed the King to return to Hell before Mynor Yelad had returned to Shallotville.

All magic items in the Skull Room (AREA 20) were carefully selected and left by King Yelad to help his son regain the city, should he ever return.

7 GOLEM GUARDED LOBBY

At the foot of the stairs, characters stand at the entrance into a 20x25 foot room with a 15 foot high ceiling. Against the northern and southern walls spaced 5 feet apart are large white pillars, each with a carved face of a weeping human. If a character passes within 5' of a pillar, the face will begin to moan. Wax candles give off substantial light; they are magically lit. Purple draperies line all walls.

In the very center of the room stands a Glass Golem as a guard. His entire body is made of glass and objects can be seen inside his head, heart, stomach, arms and legs, but the objects cannot be clearly distinguished. On top of his head is a large glass crown with the glass letters E-M-E-T-H hanging loosely from strings over his forehead.

The Golem will immediately attack any character entering the room, but will not leave the crypt lobby.

Glass Golem

AC: -2, HTK: 50 (12D8), M: 12"

Att: 2, Dm: 2-16, 2-16, Size: Large (9 feet tall)

Intelligence: None, Align: Neutral

Special: May only be hit with +1 or better magic weapons; if the Glass Golem takes more than 5 HTK damage from a single blow, glass form its body will shatter hitting everyone for 2-5 (but the Golem will be intact). 70% Magic resistant to spells causing damage.

SECRET CRYPT

SECRET DOOR [S]

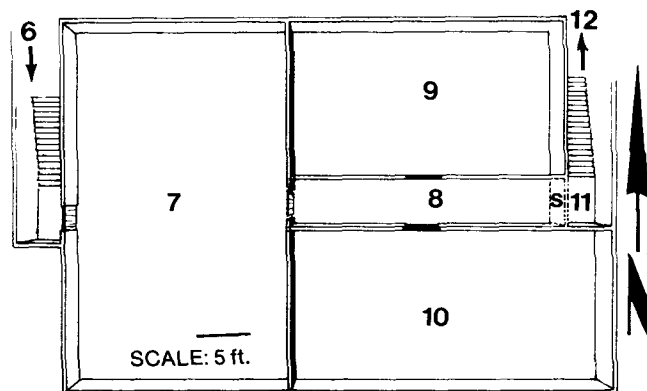

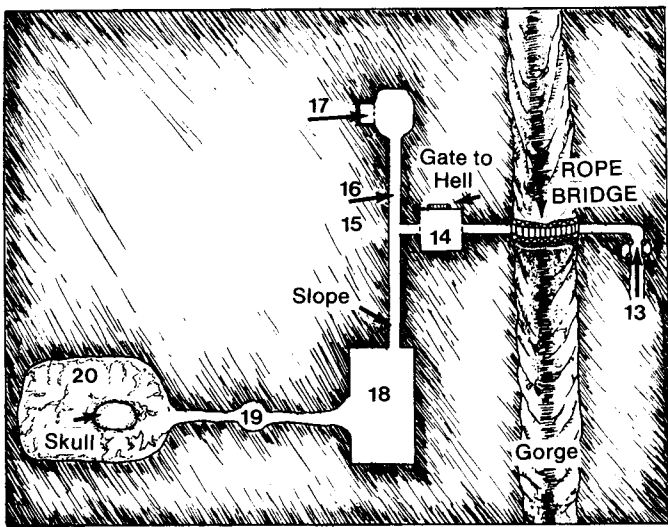

Fireplace 4 Door --- SCALE: 10 ft.

The Glass Golem's extremely sharp knuckles will cause double damage against opponents wearing no armor or just leather armor. Ring, scale or chain mail clad opponents take normal damage, but after three hits, the armor will be useless. Splint, banded or plate armor clad opponents take normal damage, but six hits renders the armor useless. Magical armor will not be affected.

If the first 'E' is removed from the word EMETH (this can be done several ways from shooting an arrow to flying (DM's discretion), the Golem will shatter. Anyone within 10 feet of the shattering Golem must roll under his dexterity or take 3-30 HTK damage from the flying pieces of shattering glass.

Once the E is removed and the Golem shatters, all the treasure inside the glass body will be scattered across the lobby floor. Magic items in the Golem were included to help lead to the skull room, AREA 20.

Inside the brain is a manual on making Glass Golems. Inside the heart is a silver necklace with a convex glass globe (Amulet of Life Protection). Inside the stomach is a 12-inch long triangular candle. Inside the legs are one Fly scroll and one Knock scroll.

8 MARBLE HALLWAY

The door on the eastern wall leads into a marble corridor, 5 feet wide and 20 feet long with two doors. The hall is magically lit with flickering candles on silver sconces (which will continue to burn until a dispel magic is cast on them). At the far eastern end of the hallway is an elaborate, but empty, gold triangular sconce.

The door on the northern wall is made of heavy oak and is locked. Carved on the outside of the door are strange runes. A Read Magic spell reveals the sentence, "May the fires of hell engulf the body and soul of any intruder fool enough to pass this door."

The door on the southern wall is a plain oak door.

If the triangular candle found in the Golem is placed in the triangular sconce and lit, characters will see that the dark veins of the marble against the eastern wall will begin to glow with a soft red color which gradually increases in intensity. The eastern wall now reveals an intricately sculpted marble door with the demonic face of King Yelad

carved into it. (No other light will reveal this door. An elf has a 1 in 12 chance of spotting the door with regular light).

9 ROOM OF FIRE

If characters are able to unlock the door on the northern wall with the runes inscribed into the wood, they will enter a 20x10 foot room. There are three stone sarcophagi along the western wall and in front of each sarcophagus is a 3 foot brass urn.

This room was planned to be the true final resting place for King Yelad's wife and son, and is guarded by a fire resistant Mummy.

If the stone lids of the sarcophagi are removed, characters will find that the body in the middle sarcophagus wears a necklace of braided gold (2,000 g.p.). Intertwined with the wrappings are strands of gold (500 g.p.) wound around the entire body. This is Cynthia's body, and she will not animate or attack.

The southernmost sarcophagus is empty.

The northernmost sarcophagus holds a Mummy. The Mummy has a golden Amulet around its neck. When the lid on the sarcophagus is opened the Mummy will immediately arise and attack. The Amulet around its neck makes it fire resistant.

If the fire resistant Mummy is attacked with fire, the flames will cover his entire body without causing damage. Then the Mummy's eyes and mouth will begin to glow orange and he will suck in any fire covering his body, following that with a hideous laugh. After this, he will attack as a Mummy except that every third round, he will attack by throwing flames on his opponents, causing 3-12 HTK damage, unless the character saves against fire. (This fire round is an automatic hit and characters must save each time).

The fire resistant Amulet will allow only Mummies to absorb any fire encountered on the material plane (other than a fire elemental, when it can only absorb half damage). The Amulet will work 7 more times. On the 8th attempt, the Amulet itself will explode, acting as a Fireball from a Skill 9 magic user.

Mummy

AC: 3, HTK: 27 (6D8+3), M: 6"

Att: 1, Dm: 1-12 plus disease

Special: The sight of a Mummy within 6" causes fear; immune to Sleep, Charm, Hold, and cold-based spells; may only be hit with magical weapons at half damage.

10 SACRIFICIAL CHAPEL

This is a 25x10 foot room. Along the northern wall is a painted mural showing scenes of a demonic ritual: Yelad, in devil form overseeing the sacrifice of a maiden who is being thrown into a firepit by two barbed devils. A group of erinyes, zombies and hooded humans look on in the background. (This is the room in which Cynthia was sacrificed.)

Towards the western end of the room is a marble altar. North of the altar is a gong, and east of the altar is a sacrificial pit. The eastern end of the room has five finely carved mahogany pews. Lying next to the altar is a red-handed human man who has been torn apart. Long claw marks cover his body. Next to him lies a glowing 2-handed sword which has fallen out of his hand. (This sword is +1, +2 vs. magic using and enchanted creatures). Attached to his belt are two torches, a hatchet, and small pouch. (Inside the pouch are 5 g.p. and overdue tax notices.)

Around his neck is a badge with the sign of the griffon and the name Lt. H. Washtin engraved on it.

In the back of the altar is an easily visible compartment which has already been opened. Inside is a three gallon barrel of oil, a decanter of brandy, a decanter of human blood, and a two-foot golden idol of Yelad's devil form with diamond eyes (2,000 g.p.).

As soon as the altar is touched (or anything in or on the altar), the player's hands will be stained blood red. The color will not wipe or wash off and can only be removed with Holy Water or a Dispel Curse. The first character to touch the altar or any of its possessions will cause the gong to slowly rumble, followed by two flashes of light which shoot out of the eyes of the devil on the mural. Reaching the door, the flashes will have formed into human-like figures which then depart. Two turns later, a Barbed Devil will climb out of the mural and search for anyone with blood red hands. Finding that person, he will attempt to kill them. All other characters will not be touched, even if they attack it.

Barbed Devil

AC: 0, *HTK:* 42 (8D8), *M:* 12"

Att: 3, *Dm:* 2-8, 2-8, 3-12

Special: May cast Pyrotechnics, Produce Flame, Hold Person, or Summon Barbed Devil (30% chance) per round

11 BEYOND THE HIDDEN MARBLE DOOR

There are 25 stairs going down to a corridor heading north.

12 CORRIDOR OF THE FUTURE

The walls of this corridor are made of earth as if in a mine, but the floor is made of green, one inch square tiles. This corridor is 10 feet wide and 15 feet high and very dark. If there is any light source which gives off heat, small areas on the corridor walls will appear to suddenly ignite as though a match were lit and the sound of a match lighting can be heard. These small areas burn for only 2 seconds before they disappear. Touching them has no effect.

After 40 feet of travel, players begin to feel a source of heat.

After another 10 feet, the players will notice that small fireplaces have been built into the east and west walls opposite each other. Each fireplace has a woodless, smokeless fire burning within.

Any player who looks into the flames will see a still scene in his or her immediate future regarding this module. If the group is having trouble, the DM may wish to show them the Erinyes (Area 14) about to be encountered.

13 ROPE BRIDGE

After the fireplaces, the corridor turns west, and immediately the air becomes extremely warm and humid. A mist is evident in the corridor and the walls no longer flicker. Visibility is only 15 feet in front of players or 25 feet if Continual Light is used.

After 25 feet, players come to a 40 foot gorge, causing the corridor to abruptly end. Flowing through the gorge is a river of boiling water. Steam is rising up from the river along with occasional bubbles. The river flows 30 feet below and a rope bridge leads across.

This rope bridge consists of two ropes, one for feet and one for hands. The top rope is taut, but the foot rope is somewhat loose, making travel difficult.

Once a character travels 20 feet across the bridge (half way), he must roll under his dexterity or lose his footing.



Elves, thieves, and monks are -2 to this roll because of their superior agility, while dwarves, gnomes and halflings are +1 to the roll because the ropes are spaced for humans. (These rolls must be adjusted twice for dwarf thieves, etc.).

Any character who fails his dexterity roll must roll again, under his strength in order to get his feet back on the ropes. If he fails this roll, he falls into the river and must roll under his system shock or die.

If the character is still alive, he will receive 22 HTK damage - 11 if saved. The character can then swim to a ledge on either side.

After successfully crossing the rope bridge, the group will come to a landing 5 feet wide and 15 feet long. The landing faces a large 10x10 foot bronze door with a large bronze knocker, but no door handle. It is noticeably warmer on this side of the bridge, and sweat begins to flow down the characters' faces.

The door may be opened by magical means, or the characters may use the door knocker.

14 ERINYES ROOM

This is a 30x30 foot marble walled room. Against the northern wall is a gate to Hell and beyond that are hideous-looking Lemures reaching toward the gate. (The gate can only be used to enter Hell so the Lemures will be unable to enter the room for encounters.) On the center of the far wall is another 10x10 foot bronze door with no knocker or door handle.

IF CHARACTERS USE THE DOOR KNOCKER: The door will open and an Erinyes will be standing in front of the northern wall. Another Erinyes will be against the southern wall. Both will have their Ropes of Entanglement ready to throw and will immediately attack. These two Erinyes will also have summoned one additional Erinyes.

(3) Erinyes

AC: 2, *HTK:* 45, 43, 36 (6D8+6), *M:* 6"/21"

Att: 1, *Dm:* 2-8 plus poison

Special: Can Cause Fear at will at those looking at them; carries Rope of Entanglement; may cast once per round: Detect Invisible, Locate Object, Invisibility, Polymorph Self, Produce Flame, or Summon Erinyes (25% chance)

The two Erinyes will try to entangle characters in this order: Lawful evil, chaotic evil, and neutral evil. Neutrals and then good characters will follow in the same order. Each Erinyes will only be able to entangle one character.

If both Erinyes have successfully entangled a body, the summoned Erinyes will attempt to help pull the bodies into the gate. However, if they are overwhelmed, All Erinyes will leap into Hell without any bodies.

IF THE PLAYERS OPEN THE DOOR BY MAGICAL MEANS: They will have the advantage of surprise. Both Erinyes will be in front of the northern wall and will not have their Ropes of Entanglement ready to use.

If anyone sticks something (sword, hand) into the gate to Hell, it may not be removed. Only the part of the object not put through the gate will remain. If a hand or body part is put through the gate, a sharp hot searing pain will be felt and then the appendage will be missing (unless the whole person continues through the gate of Hell.)

The double door on the western wall opens only if pushed by a combined strength total of 26 or by magical means.

15 CORRIDOR OF LOST STRENGTH

Here is a 10x10 foot corridor in which the heat has now become almost intolerable. Ten feet down the corridor is a massive stone wall and the corridor turns east and west.

All characters must now subtract 5 points from their strength because of the heat. (Thieves, magic users or any player either without armor or who removes his armor loses only 2 points of strength).

16 CORRIDOR OF ILLUSION

Looking down both the north and south corridor, characters sense that the northern corridor seems slightly cooler. If they head north and continue down the corridor for 50 feet, they will enter a 20x30 foot cavern, where the temperature is much cooler. At the far eastern end of this cavern is a stone door.

The reduction in temperature is an illusion which is so powerful that all lost strength is temporarily regained. However, if a character disbelieves the coolness, he will once again lose 5 strength points. Adventurers witnessing the disbelieving character will have to save against magic at -2 or also begin to feel the intense heat.

17 ROOM OF ZOMBIES

If characters open the door at the eastern end of the cavern, they find a 15x15 foot room with 12 frozen Zombies. Once the door is opened, the ice on the Zombies begins to melt. In 4 rounds, the zombies will begin to move and follow characters until they are turned, killed, or kill characters. Characters who close the door but do not lock it by magical means will continue to be pursued.

(12) Zombies

AC: 8, *HTK:* 11 (2D8), *M:* 6"

Att: 1, *Dm:* 1-8

Special: Immune to Sleep, Charm, Hold and cold-based spells

18 CORRIDOR OF CANDLES

If characters turn south down the corridor, the heat will slowly but steadily increase. After 30 feet the passageway will begin to slope downward, continuing for another 60 feet, before a 40x60 foot cavern is entered.

The cavern is barren rock. On the western end of the cavern is a steep 8 foot incline, lined by flickering blue/-green candles, 4 inches in diameter and 1½ feet long, resting in brass sconces. Carved into each candle is a face of an old man.

The incline leads west to a 10x15 foot black metal door. Molded into the door is the same face of an old man that was carved into the candles except his mouth is opened as if to speak. Between his lips is a keyhole. On the southern-side of the door is a three foot black metal lever, connected to the rock floor.

The candles lining the incline are permanently lit unless lifted out of their holder, at which point they immediately turn into Giant Centipedes and strike with surprise.

(16) Giant Centipedes

AC: 9, *HTK:* 1 each (¼D8), *M:* 15"

Att: 1, *Dm:* poison

If the key, found in the captain's portrait is placed into the keyhole, the door will automatically open.

If characters do not use the key, the lever must be used to open the door. The lever is heavy and a character must

have a minimum of 17 strength to pull it, or have help from another character.

Once the door begins to open, the old man's face on the door will turn a blazing orange/red and a flaming wind will rush up the incline, causing 1-8 HTK damage to anyone on the incline who fails to save against a breath weapon. As the flames pass the candles, they melt and disappear completely.

19 ROOM OF THE NAGA

Characters enter a five foot wide passage of black stone. The passage continues for 60 feet until it widens into a circular room of black stone, 10 feet in diameter. On the other side of the room, the corridor narrows to five feet once again and continues for another 60 feet.

IF CHARACTERS USE THE KEY TO ENTER: The 10 foot circular room is empty. They will easily be able to pass the circular room and continue down the five-foot narrow black stone passageway for another 60 feet where they will enter a massive 75x100 foot stone cavern, 65 feet high, surrounded by flames.

IF CHARACTERS DID NOT USE THE KEY, AND USED THE LEVER TO ENTER: They will immediately awaken a Spirit Naga, hidden 12 feet beneath the circular room. The Naga is raised to the circular room in one round.

Spirit Naga

AC: 4, *HTK:* 58 (10D8), *M:* 12"

Att: 1, *Dm:* 1-3

Spells: Clerical: Protection from Good, Command, Silence (15-foot radius). Magic User: Magic Missile, Push, Stinking Cloud, Detect Invisibility, Lightning Bolt

Special: May permanently Charm anyone meeting its gaze, save vs. paralysis allowed

20 THE SKULL ROOM

This is a massive 75x100 foot stone cavern with a ceiling 65 feet high. 35 feet beyond the entrance is a 50 foot tall stone skull with green gemlike eyes. A passage 5 feet wide leads up to the mouth of the skull. The passage to the skull, and the skull itself are surrounded by a blazing fire. Inside the mouth a golden glow can be seen. Both the mouth and nostrils are large enough to enter. Only the 16 lower teeth are intact, the left front tooth appearing to be solid gold (500 g.p.).

The skull has a magic mouth cast on it. When first entered, it will say, "ARISE MINIONS OF YELAD, FOR HIS RETURN IS IMMINENT."

Entering the mouth requires climbing through an opening where the upper teeth used to be. Entering the

nostrils will require squeezing through. The nostrils are 28 feet above the ground level.

The teeth appear normal, except for the back two wisdom teeth, which are capped. The caps can be noticed by a player searching for a secret door.

Uncapping the left wisdom tooth reveals a pool of sparkling blue liquid. This liquid is similar to a Potion of Healing, except that if all the liquid is drunk by one person, that individual regains all lost hit points. If two people consume equal amounts, or one person consumes half, half of all lost hit points would be restored. This works the same way for drinking by three people or drinking one third of the liquid. There are 32 ounces of liquid inside the tooth.

Uncapping the right wisdom tooth reveals a portable hole spread over the top of the uncapped portion. Inside the hole is a small ebony box containing a leather helmet.

It is a Helm of Brilliance. Its command is "Yelad, servant of Dispater." Additionally, the user is immediately turned lawful evil (roll for system shock for non-lawful evil characters) and Dispater becomes his god.

The eyes of the skull are 40 feet above the ground. To the untrained eye, they appear as huge emeralds; however, a dwarf or gnome has a 75% chance of seeing that they are glass.

The eyes can be removed, but this must be done carefully. They can only be popped out towards the outside of the skull and they each weigh 250 pounds. If they are popped out without precautions, there is an 80% chance that they will immediately fall into the fire surrounding the room releasing the chlorine gas they contain. Save vs. poison or receive 3-20 HTK damage.

Anyone climbing through the left nostril can easily see a golden box stuck into the stone. The smooth box is 1-foot long, 6-inches wide and 2-inches deep. Inside are four leaves and 50 seeds. The golden box itself is worth 200 g.p.

Anyone climbing into the right nostril will find a pearl box, 18 inches square. Inside this box is an iron flask decorated with mystic symbols and magic runes. Inside the flask is a Salamander named Grenyte, who was forced inside by the King to be a servant for Mynor. However, the Salamander didn't appreciate the captivity and will immediately attack anyone who opens the flask.

Grenyte the Salamander

AC: 5/3, *HTK:* 42 (7D8+7), *M:* 9"

Att: 2, *Dm:* 2-12, 2-12 plus body heat

Special: +1 or better magic weapons needed to hit; immune to Sleep, Charm, Hold, and fire-based spells; causes 1-6 damage by body heat.

OPALESCE FOREST

The Opalesce Forest was named by the early inhabitants of the Shallotville area for the many rainbows that shone above the trees. Their folklore constantly mentions sightings of leprechauns dancing through the clouds above a forest. Other notable legends are of silver-haired dryads, and many wee folk, some winged and some not, who could be heard playfully singing around flickering campfires in the magical groves.

This is one of the many enchanted forests that the god Silvanus created as a home for Dagda's sylvan creatures. Silvanus placed a strong aura of good around the entire forest, and during daylight hours, this aura lets any neu-

tral or good creature or person have an 80% chance of seeing a sickly yellow outline around any evil creature.

With the coming of Yelad, evil took a firm hold of the Shallotville area. The good aura began fading. Evil men

PIXIE'S LAIR

This pond is the home of a small band of Pixies who are staying in the forest as long as they think possible before the oak tree dies. There are 17 Pixies left, but only six of them are left at the pond. Since they are invisible, the characters will not see them unless the Pixies make their presence known. Anyone who causes harm to their pond or brook will be dealt with to the Pixies' upmost abilities.

(6) *Pixies*

AC: 5, *HTK*: 1, 3, 3, 2 (½D8), *M*: 6"/12"

Att: 1, *Dm*: By weapon type: daggers (1-4) and arrows (2-5 & fall asleep)

Special: Naturally invisible; may become visible and polymorph themselves at will.

H PINE GROVE

The forest seems to be changing; there are less and less hardwoods and towering pines seem to be taking over in an abrupt manner. Soon, the characters step into a section that is entirely pine trees. Old brown pine needles carpet the ground and the trees are planted in long, neat rows making deep columns of shaded paths. Once inside the pine forest, characters feel suddenly relaxed, as if all their worries are behind them. Birds softly chirp in the trees, making for an atmosphere of great peace.

Many pine cones are scattered under the trees and along the paths, some of them are coated with what appears to be tiny red speckles. The speckled cones, although magical, give off no sensation when held or touched. When characters hold or carry one of these cones close to their body, they will save once vs. spells at +2 to their rolls. Carrying more than one cone will not have a cumulative effect, but only one cone will be discharged per save.

This is the lair of a band of 11 Brownies. The Brownies will be gathering sacks full of speckled pine cones. There is an 80% chance that the Brownies will guide the characters through the forest if most of the characters are of good alignment. If the Brownies serve as guides, the characters will have no dangerous encounters on the way out of the forest—but they will meet Cassandra (random encounter 18).

(11) *Brownies*

AC: 3, *HTK*: 3 each (½D8), *M*: 12"

Att: 1, *Dm*: 1-3

Special: May use spells. There is a 50% chance that the Brownies will cure with strange herbs the wounds of any lawful good characters in the group. The Brownies will disappear if any of the characters appear evil.

CHERRY ORCHARD

The characters come to an orchard of wild cherry trees. Each tree is filled with large, plump, dark purple cherries. Each cherry eaten will restore one hit point up to a total of 15. However, after the 11th cherry eaten, the character will suffer from nausea, even though he will still gain a hit point back. If more than 15 are eaten (but less than 25), the imbibor will suffer from ceaseless vomiting, causing the loss of all hit points restored, plus five hit points additional damage. Eating more than 25 cherries will cause severe cramping and dizziness, followed by death in three rounds. All the above rules apply to characters eating cherries within a 24 hour period.

RAINBOW

Characters stumble across what appears to be a magnificent four foot wide rainbow stretching from the ground in

front them through the clouds. If characters touch the rainbow, they discover it is water. They cannot pass through the rainbow without falling into it. However, they can easily climb out again. If they swallow any rainbow water, they will be rainbow colored for six hours. At its peak are found 10,000 g.p. of rainbow colored gems.

This is the only surviving rainbow in the forest. It is fading and can only be seen if a character is within 50 feet of either end. The rainbow is the home of Eamon Finley, a Rainbow Leprechaun. The difference between rainbow and normal leprechauns is that rainbow leprechauns live alone inside magnificent forest rainbows. They may levitate at will and are said to have been seen frolicking and dancing through the clouds. Some have even said to be seen on top of clouds under the afternoon sun molding gems in their own hands by scooping out water from rainbows.

Eamon Finley, Rainbow Leprechaun

AC: 8, *HTK*: 32 (4D8), *M*: 15"

Special: He will not attack

Eamon is having trouble accepting the fact that his rainbow is near death, and that soon he will become a normal leprechaun.

He will tell this story: "Me heart is wounded badly and I must thank ye for lettin' me bend yer ears. Ya see, me people have been livin' in this forest since the beginnin' o' time, when rainbows lit the skies with prismatic luster. For years none but the elves, sprites, pixies, dryads, tinkers and me good friend the brownies lived in a paradise unknown to the whole other world. Then curious men found out about our paradise, which then stretched for miles past its present borders. They came to look at the beautiful rainbows.

"At first we had no trouble with them for they caused us no harm, but then gold was discovered. Men came from all over and built mines to harvest their gold. A large town nearby spring up over night, built with the precious oaks of our lovely dryads. And the men, some so evil that they kidnapped the poor tree sprites for their own dubious pleasures, would begin to swim our rainbows and steal the most prized possession of our existence, the rainbow gems.

"Well, this was only the beginnin', and soon this creature Yelad came to power. They caused the dryads to become reclusive in their trees, they tortured the poor brownies and murdered me brothers for their gems."

"It weren't til the tinkers drove Yelad's people from the wood with their sorceries that we could live in relative peace, but the damage was done. The tinkers had dwindled to but a few and the forest was dying. Its magic was fading fast and we're now all doomed to leave for another world where we have been assured by Silvanus of peace. But there are no rainbows in the new world, an no magical trees or streams."

If the characters are neutral or evil and just want rainbow gems, the Leprechaun will try to outwit them, but if he's overpowered, he'll say, "Take them, for losing my gems and life's work is but a small loss compared to the loss of my worldly existence." If Eamon is killed, his treasure turns to sand and whoever delivers the killing blow will telepathically hear a curse, "Let every jewel or gem that touches your hand forever turn to sand." (This curse cannot be removed by any magical means short of a Wish, and that at a 85% chance of failure.)

KMISTLETOE FIELD

A large field of thick mistletoe is encountered. If the field is thoroughly searched, characters will find a bowl and a silver sickle beside it.

LHIDDEN TREASURE

Characters find two sacks poorly hidden under bushes. One is a small canvas sack and the other is a large cloth sack. Inside the small sack are 78 c.p. and a Ring of Delusion. The large is actually a Bag of Tricks.

The bags were left by one of the Rainbow Leprechauns who already left through the gate to the alternate world. He left it for greedy humanoids to stumble upon.

RANDOM ENCOUNTERS

Chances of encounter in the forest depend upon whether or not the characters are on the paths. On the paths, encounters will occur on rolls of 1 on a 4-sided die. If the group is not on a path, chances of an encounter are on rolls of 1 on a 6-sided die. Encounter rolls are made once every two turns. Adventurers may move diagonally along the squares. Any square marked by a letter will automatically have an encounter when the characters move there. For each random encounter roll a 20-sided die.

For details, see the appropriate letter on the fixed encounter key. Any creature encountered which has been killed will not be encountered again unless specified. Only random encounters 5, 10, and 14-17 will occur more than once.

1UNICORN

A Unicorn is on her way to the gate at the center of the forest.

Unicorn

AC: 2, HTK: 28 (4D8+4), M: 24"

Att: 3, Dm: 1-6, 1-6, 1-12

Special: May Dimension Door (up to 36") once per day; surprise on 1-5 of a six-sided die; cannot be charmed or held; immune to death spells; make saving throws vs. spells as a Skill 11 Mage; horn has a +2 to hit; charges strike with horn only for double damage (2-24).

2SPRITES

Secretly watching the adventurers pass by are 25 Sprites. If the characters are not in danger or causing any harm to the forest or non-evil life, the Sprites will let the characters alone. If it can be determined that the characters are being attacked, the Sprites will help characters in their fight. No help will be given if any characters are evil. If a non-evil character is attacking something evil, the Sprites will lend a hand. After the danger is removed, the Sprites will help neutral and good characters to the cherry orchard, and tell them of its secret. (It used to be their home.) The Sprites will kill any evil creatures they can.

(25) Sprites

AC: 6, HTK: 5 each (1D8), M: 9"/18"

Att: 1, Dm: With bow (1-4 plus Sleep for 1-6 hours)

Special: 75% chance of being unnoticed; may become Invisible at will; Detects Good/Evil at 5" range; and move silently.

3WOOD ELVES

The Wood Elves of the forest have packed up and are on their way to the new world. There are 28 males, 10 females, and 7 children. All of the males are fighters. Of the females, nine are fighters and one is a magic user. The seven children will hide in the forest at the sign of fighting. The

Elves have already moved their treasure to the new world, so each adult carries only 3-24 g.p. and the magic user carries 3 Healing potions. She will use them to help an adventurer who is in real need of healing.

(28) Skill 3 Male Elven Fighters

AC: 7, HTK: 15 each (3D10)

Stats: Average, Equipment: Leather, Shield, Bow, Longsword

(9) Skill 2 Female Elven Fighters

AC: 8, HTK: 12 each (2D10)

Stats: Average, Equipment: Leather, Bow, Shortsword

Skill 5 Female Elven Magic User

AC: 9, HTK: 12 (5D4)

Stats: Average, Equipment: Dagger, 3 Healing Potions

Spells: Protection From Evil, Web, Sleep

4DRYAD

A silver-haired Dryad named Cecilia will appear from behind her oak tree. In the presence of a group of good characters, she will begin to cry and ask someone to help her forest. If no help will come from the characters, she may try to charm one or more of them.

Cecilia the Dryad

AC: 9, HTK: 11 (2D8), M: 12"

Att: 1, Dm: With Dagger (1-4)

Special: May Dimension Door to her tree; may cast a Charm thrice daily with -3 to the saving throw.

5GRASPING VINES

Suddenly from above, 15 vines (AC: 10, HD 1, HTK: 5, D 1-4) drop from the trees and attempt to strangle the characters. If the vines hit, they do 1-4 damage. Burning will cause them to let go for one turn and do 1-6 damage to the vine. The vines were planted all about the forest by King Yelad's loyal followers.

(15) Vines

AC: 10, HTK: 5 each (1D8), M: 3"

Att: 1, Dm: 1-4 plus strangulation

6ARBORENT

An Arborent (animated tree) will be seen slowly walking through the forest. He's angry because the forest is dying and his friends have left, and he will try to kill anything evil he finds.

Arborent (animated trees)

AC: 0, HTK: 52 (12D8), M: 12"

Att: 2, Dm: 4-24, 4-24

Special: Vulnerable to fire attacks: +4 to hit, -4 to save, +1/damage die to damage.

7GIANT POISONOUS SNAKE

A Snake can be heard slithering nearby through the forest. He is minding his own business looking for dinner. If bothered he will choose one of them as dinner.

Giant Poisonous Snake

AC: 5, HTK: 27 (4D8+2), M: 15"

Att: 1, Dm: 1-3 plus poison (save or die)

8PIXIES

Suddenly, five Pixies leap out of the underbrush and laughingly touch five characters, then immediately turn invisible. The Pixies will for the next four turns (once per turn) keep harassing the characters by touch or spell. After four turns, they will head towards the gate and leave the forest forever. This was their last hurrah.

(6) **Pixies**

AC: 5, HTK: 2, 3, 3, 4, 2 (½D8), M: 6"/12"

Att: 1, Dm: By weapon type: daggers (1-4) and arrows (2-5 & fall asleep)

Special: Naturally invisible; may become visible and polymorph themselves at will.

9 LEPRECHAUN

Charlie Gilfly will attempt to steal the most valuable item he can see on a character. After the theft (of he succeeds) he will turn invisible and run to his lair.

His lair contains 1,220 SP, 380 EP, 240 GP, 22 PP, a round silver cloak brooch (brooch of shielding); one golden brooch with a small center emerald surrounded by four very small diamonds (500 GP); eight arrows, two pairs of socks and two pairs of boots. The only way his lair can be found is to follow him.

Charlie Gilfly, the Leprechaun

AC: 8, HTK: 4 (2D8), M: 15"

Special: Can become invisible at will; may Polymorph Non-living Objects, Create Illusions, and use Ventriloquism spells.

10 POISON IVY

This 500 square foot area of the woodland is filled with poison ivy. Anyone familiar with poison ivy will notice the plants. The ivy will cause 1 HTK damage due to itching and misery. In order not to take this damage, characters must walk around the plants.

11 BROWNIES

Six Brownies are on their way to the new world. Two of them carry sacks of speckled pine cones. See encounter AREA G for a description of how the Brownies will react.

(6) **Brownies**

AC: 3, HTK: 2, 1, 3, 1, 2, 4 each (½D8), M: 12"

Att: 1, Dm: 1-6 (Shortsword)

Special: May use spells. There is a 50% chance that the Brownies will cure with strange herbs the wounds of any lawful good characters in the group. The Brownies will disappear if any of the characters appear evil.

12 CRIOSPHINX

The Criosphinx Imprial greets the characters. See fixed encounter E.

13 CARDINAL

A large red cardinal flies down from a maple tree and asks characters in the common tongue if they will help him fight the Giant Snake in fixed encounter D. The cardinal is upset over the snake making dinners out of the eggs of all the birds in the forest.

If the characters refuse, the cardinal will be angered and will alert Enaj's guards in the forest to the location of the characters. If the characters are not attempting to escape with the magical leaves from the crypt or haven't double-crossed Enaj, her guards will be uninterested in the news (for stats on guards, see 14-17).

If the offer is accepted and the characters kill the Shake the cardinal will guide the characters out of the forest. This means that any potentially dangerous encounters should be ignored.

14-17 ENAJ'S GUARDS

Enaj's guards will be in the forest even if the characters have not double-crossed Enaj. If Enaj has sent out word that the characters have not accepted her offer, the guards will have orders to kill the group.

The guards are ordered to pursue any of Enaj's enemies, so it is possible to be chased and encounter another squad of guards. Once out of the forest, the guards will stop their pursuit.

14 (6) Skill 2 Human Fighters

AC: 4, HTK: 8, 11, 17, 18, 14, 12 (2D10)

Stats: Average, Equipment: Chain, Shield, Longsword

15 (6) Skill 3 Human Fighters

AC: 3, HTK: 13, 16, 19, 24, 27, 29 (3D10)

Stats: Average, Equipment: Splint mail, Longsword, Shield

16 (4) Skill 4 Human Fighters

AC: 2, HTK: 26, 31, 33, 38 (4D10)

Stats: Average, Equipment: Plate, Shield, Longsword

17 (4) Skill 5 Human Fighters

AC: 2, HTK: 26, 31, 33, 47 (5D10)

Stats: Average, Equipment: Plate, Shield, Longsword

18 GYPSY WOMAN, CASSANDRA

As the characters walk through the forest, they come across a tall, thin woman sitting on a tree stump. She is a priestess of the wandering forest tinkers.

Cassandra, Skill 4 Magic User/Skill 8 Druid

AC: 8, HTK: 31 (8D4) Stats: Average, Equipment: +1 Dagger, +1 Ring of Protection

Spells: Charm Person, Web, Darkness, Invisibility, Magic Missile, Entangle, Pass Without Trace, Speak With Animals, Predict Weather, Locate Plants, Barkskin, Summon Insects, Call Lightning, and Know Alignment.

She tells a character of good alignment that she will read his palm for 2 g.p. If that character refuses, she will ask the others in the following order: good, neutral, and evil. (DM: As Cassandra is a creature of this forest, her ability to read the future has been impaired as the forest has declined. All the same, she can foresee a path to be chosen or denied. The path she sees may not be the best one.) Should a character want a reading:

a. If the character has just begun and has refused any offers from Mynor Yelad or Enaj and are predominantly good (no evil persons in the party):

I see you are an honest man (or woman) not wanting to deal with the forces of evil. You have just lost all you own. Now, I see a hollow tree trunk and a ladder . . . you are fighting rats . . . you are in a tomb with strange writings and a skeleton encased in quartz. You take the skeleton very warily . . . Now you enter a mausoleum and go below. I see a large glass monster attacking . . . from his forehead an E falls to the ground . . . I see a bridge of rope and you feel very warm . . . now a giant stone skull comes into view. I see a golden box with leaves and seeds. You eat some white powder . . . you smoke some golden leaves . . . you control a city next to a forest ornamented with beautiful rainbows above it. You will be in grave danger, be extremely cautious, for all is not as it appears.

She does not know what most of the reading means; however, she does know where the hollow tree trunk is, and she knows that Mynor Yelad is lawful evil and Enaj is chaotic neutral.

If the adventurers want to go down the hollow tree trunk, she will lead them there and if asked, her people



will supply basic weapons and leather armor. She will also give any spell components asked for.

b. If the characters have returned the magical leaves to Mynor Yelad or Enaj and are escaping the other's guards:

Cassandra will take the character's palm, gasp, jump back and shout, "Oomar! Oomar!" (Death! Death!) She'll turn invisible and run back into the forest.

c. If the characters are mostly neutral or evil and made no deal with either Mynor Yelad or Enaj, or just gave up attempting to find the magical leaves:

Cassandra will say that she sees you taking on tasks of great difficulty for money. She will also tell of two random forest encounters which the DM should decide upon. These will automatically be the next two encounters the characters have.

d. If the characters have the magical leaves and are predominantly Neutral or Evil:

Cassandra will take the character's palm, gasp, jump back and shout, "Oomar! Oomar!" (Death! Death!) She'll turn invisible and run back into the forest.

e. If the characters have the magical leaves with them and are predominantly good:

Cassandra will say:

I see you are an honest man (or woman) not wanting to deal with the forces of evil. I see a golden box with leaves and seeds. You eat some white powder . . . you smoke some golden leaves...you control a city next to a forest ornamented with beautiful rainbows above it. You will be in grave danger, be extremely cautious, for all is not as it appears.

If characters question what this all means, she will explain that the forest is dying and will not regain its beauty until a good person takes over the Shallotville area.

If no character allows Cassandra to do a reading, she will smile, and wave for them to continue on their journey. She will respond to all questions but will give no helpful answers other than answers to historical questions about the forest.

If the characters attack Cassandra, she will immediately turn invisible and flee. If the characters insist on continuing the attack, two Tinkers of her tribe will come to her defense (they were hiding in the underbrush). Each Tinker carries 1-10 g.p. and one gem worth from 100-600 g.p.

(2) Tinkers

AC: 6, HTK: 26, 15 (4D8), M: 12"

Att: 1, Dm: Long Bow (2-7) or Longsword (1-8)

Once Cassandra leaves or the characters leave her, they will be unable to locate any additional Tinkers.

19-20^A Warm Breeze.

THE WRAP UP

Once the characters exit the mausoleum with the magic seeds and leaves, they will have four main options:

1. Destroy the leaves;
2. Give the leaves to Enaj;
3. Give the leaves to Mynor Yelad;
4. Keep the leaves and attempt to use them.

Keep in mind that after the characters make a deal with Mynor Yelad, Enaj, or both, guards from both sides will be carefully watching the town. In order to achieve smoother play, the judge should not have any encounters between the characters and guards of either faction before the magic leaves are found.

If characters have refused Enaj's offer, the blue jay will act as guard outside the mausoleum. If characters are seen entering, the blue jay will notify Enaj, who will send out a force of guards to surround the mausoleum and capture (or kill) characters as they exit the mausoleum. All treasure is to be brought back to her at the Halls of Power.

There will be 20 guards waiting outside the mausoleum to surprise characters. They will have the same statistics as Enaj's Opalesce Forest Guards.

If characters have accepted offers from both Mynor Yelad and Enaj, they will have two encounters with the guards of each faction.

For following encounters with Enaj's guards, there will be the Skill 4 fighters and one of the Skill 6 fighters (for statistics, see the Opalesce Forest Random Encounters).

For each encounter with Yelad's henchmen, there will be two Skill 4 fighters (AC 6, HTK 19,20,21,25,26,27, D 1-4 daggers and 1-6 shortsword); and one Skill 3 Magic User (AC 7, HTK 10, Spells: Charm Person, Ventriloquism, Web).

Enaj's guards, seeing the characters head for the Swill and Warm Ale Tavern might assume (possibly correctly) that the magical leaves are going to Mynor Yelad.

If characters split up into two groups, each group should have an encounter, but if a group of six splits into a single person and five others, with the single person having the box of seeds leaves and being invisible, the single person would probably escape. In cases where the characters are keeping the leaves and trying to escape, Enaj's guards or Mynor Yelad's henchmen will not help each other or attack each other.

No guards or henchmen will pursue into the forest, although once inside the forest (as described in the forest section), the characters may have a random encounter with Enaj's guards. Both Mynor Yelad and Enaj will not go back on their word if they are brought the magic seeds and leaves. If the characters have destroyed the magic, hopefully they can convince Mynor Yelad and Enaj that they never found the treasure (GM's discretion).

If the characters have discovered the secret of the leaves and attempt to take over Shallotville, both Enaj and Mynor Yelad will leave town to see how the characters fare. At any future time, they may rally their respective forces and try to take the town back.

If the party has recovered the box which contains both leaves and seeds, and turned them over to Enaj, Yelad will

then immediately attack the Halls of Power, ignoring the party for the moment. In the confusion of the defense, the box falls into Yelad's hands.

When Yelad finally gets the box, whether from the players or by attacking the Halls of Power, he immediately smokes the leaves—and dies!! He did not undertake his quest himself and thus suffered the consequences—he didn't find out that he had to partake the bones to survive the initial system shock of the magic spell.

Enaj will immediately after Mynor Yelad's death, attack his followers and will recapture the box of seeds and leaves. Having seen Yelad's body, she decides not to risk smoking them herself and destroys them. Celebrating her victory, Enaj will declare a general pardon for those who participated for Mynor Yelad, saying that they had been suffering the aftereffects of King Yelad's original spell.

The characters who have already been paid off by the respective side to whom they gave the box, are able to slip off in the resulting confusion.

NEW MONSTERS

FLESHMORPH (Yelad)

Greater Devil

ARMOR CLASS:	4
MOVEMENT:	9"/18" (flying)
HTK:	10D8
ATTACKS:	2
DAMAGE:	1-10 (Mace), 1-4 (claws)
MAGIC RESISTANCE:	60%
INTELLIGENCE:	Genius
ALIGNMENT:	Lawful Evil
SIZE:	Large 10 feet tall

Yelad was one of the most renown Fleshmorphs and served as Dispater's favored aid, charged with collecting human slaves for Dispater's palace on the second plane of Hell.

Fleshmorphs are bat-winged creatures with tiny, hairy ears, a bald head, and a flattened mound with two holes for a nose. Fleshmorphs carry a poisoned mace (43 to hit) that causes death within two hours of contact.

They can perform once per turn or melee round: Detect Invisibility, Cause Fear, Produce Flame, Read Magic, Wall of Fire, Polymorph to Human Form, Dispel Magic, Detect Magic, Summon Monsters (50% chance of summoning 1-2 Erinyes).

GLASS GOLEM

ARMOR CLASS:	-2
MOVEMENT:	12"
HTK:	50 (12D8)
NUMBER OF ATTACKS:	2
DAMAGE:	2-16, 2-16
MAGIC RESISTANCE:	See Below
INTELLIGENCE:	None
ALIGNMENT:	Neutral
SIZE:	Nine feet tall

The Glass Golem has extremely sharp knuckles which will cause double damage per hit against opponents wearing no armor or leather-type armor. Ring, scale, or chain mail clad opponents take normal damage, but after three hits, the armor will be useless. Splint, banded, or plate armor clad opponents take normal damage but six successful hits will render the armor useless.

If the Glass Golem takes more than 5 HTK damage from a single attack, glass from its body will shatter, hitting everyone for D 2-5.

Glass Golems can be hit with only a +1 or better magical weapon. They are 70% resistant to all spells which cause damage.

ELITE GIANT RATS

ARMOR CLASS:	6
MOVEMENT:	12"/6" (swimming)
HTK:	3D8+3
NUMBER OF ATTACKS:	3
DAMAGE:	2-5, 2-5, 2-7
SPECIAL ATTACKS:	Disease
MAGIC RESISTANCE:	Standard
INTELLIGENCE:	Semi-
ALIGNMENT:	Neutral
SIZE:	Six feet, standing

Elite Giant Rats are actually a crossbreed between a Giant Rat and a Brown Bear. These creatures are specifically bred by Greasel Greedigutt in order to have a guard which has an ability to fight like a bear and also have the love for the sewers that is characteristic of a rat.



Elite Giant Rats look just like rats except they are six feet long. They are able to swim like rats and fight on their hind legs (if trained) as do bears. The bite of an Elite Giant Rat has a 10% chance per wound inflicted of contracting a serious disease. Unlike Giant Rats, Elite Giant Rats have absolutely no fear of normal fire, and if they are in the presence of Giant Rats, there is a 70% chance that the Giant Rat will show no fear of fire.

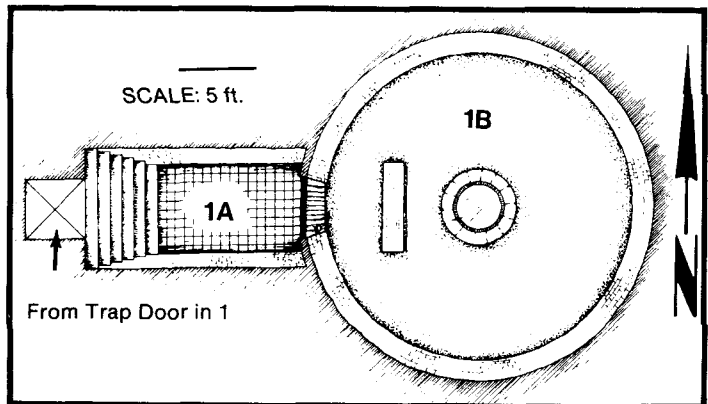
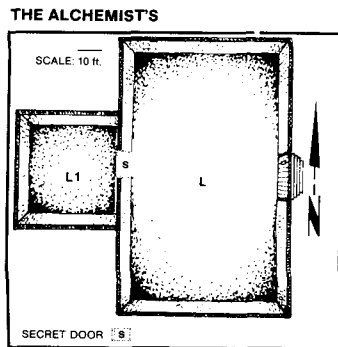
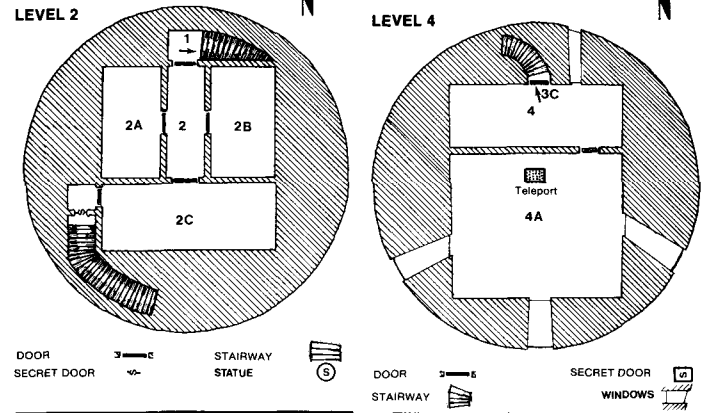
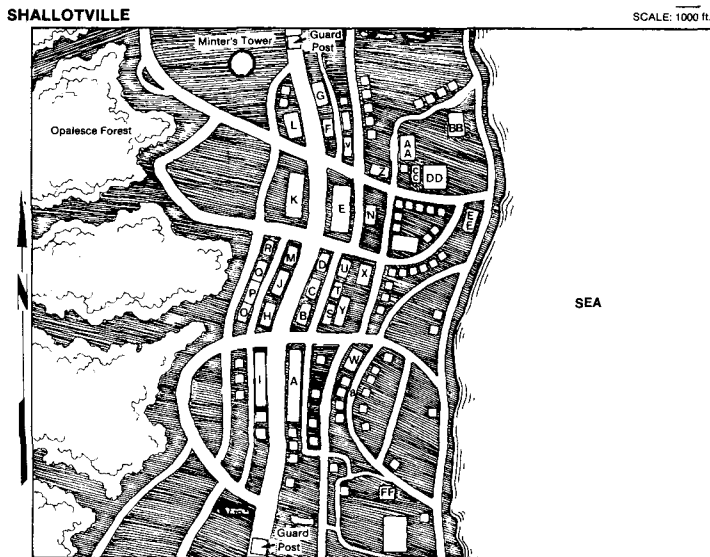
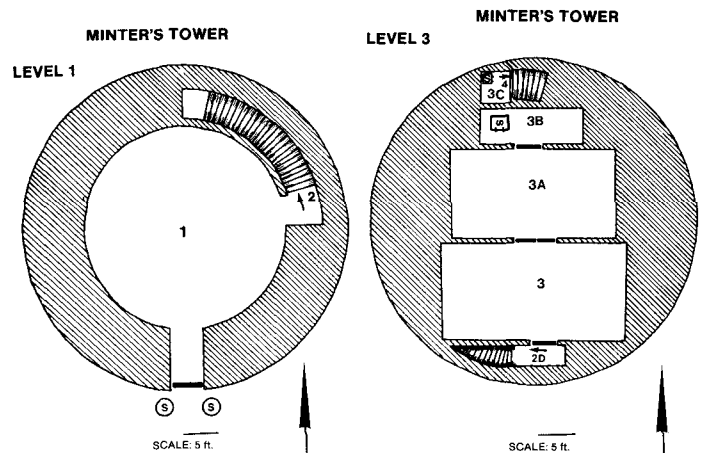
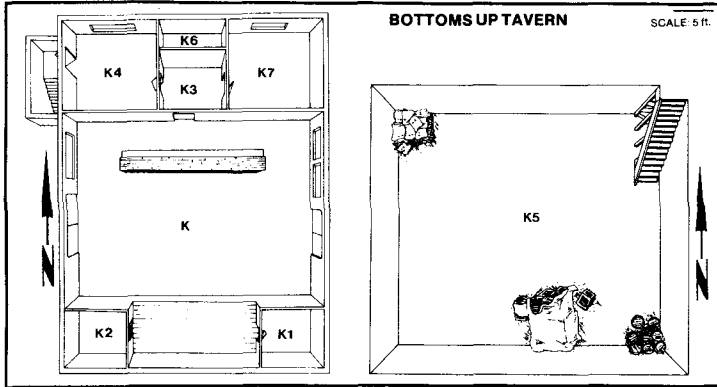
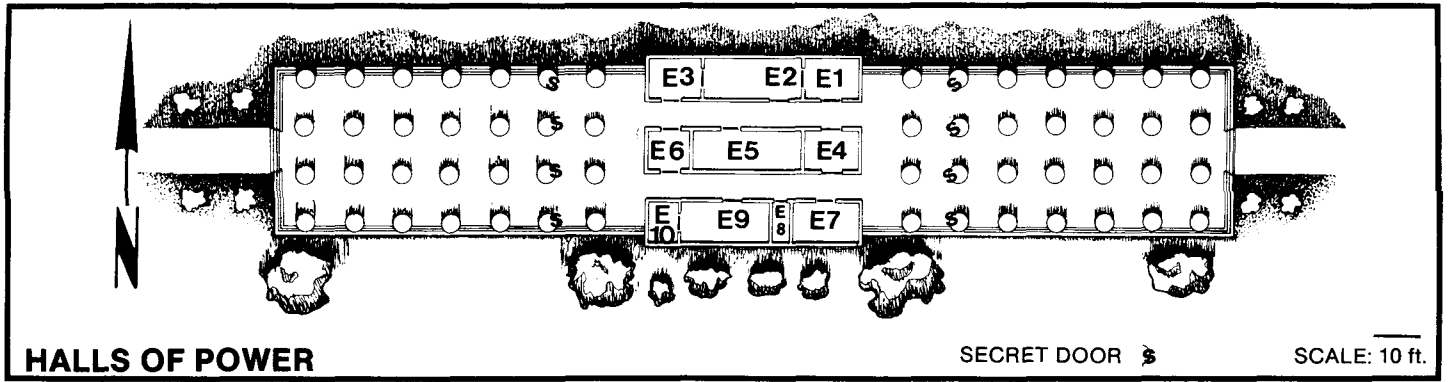

Elite Giant Rats are collectors of many items, but they are selective. They seem to have some knowledge of what trinkets they find are worth keeping.





DOOR 
 SECRET DOOR 

STALACTITES & STALAGMITES 
 UNDERGROUND PASSAGE 

TRAP DOOR 
 PORTCULLIS 

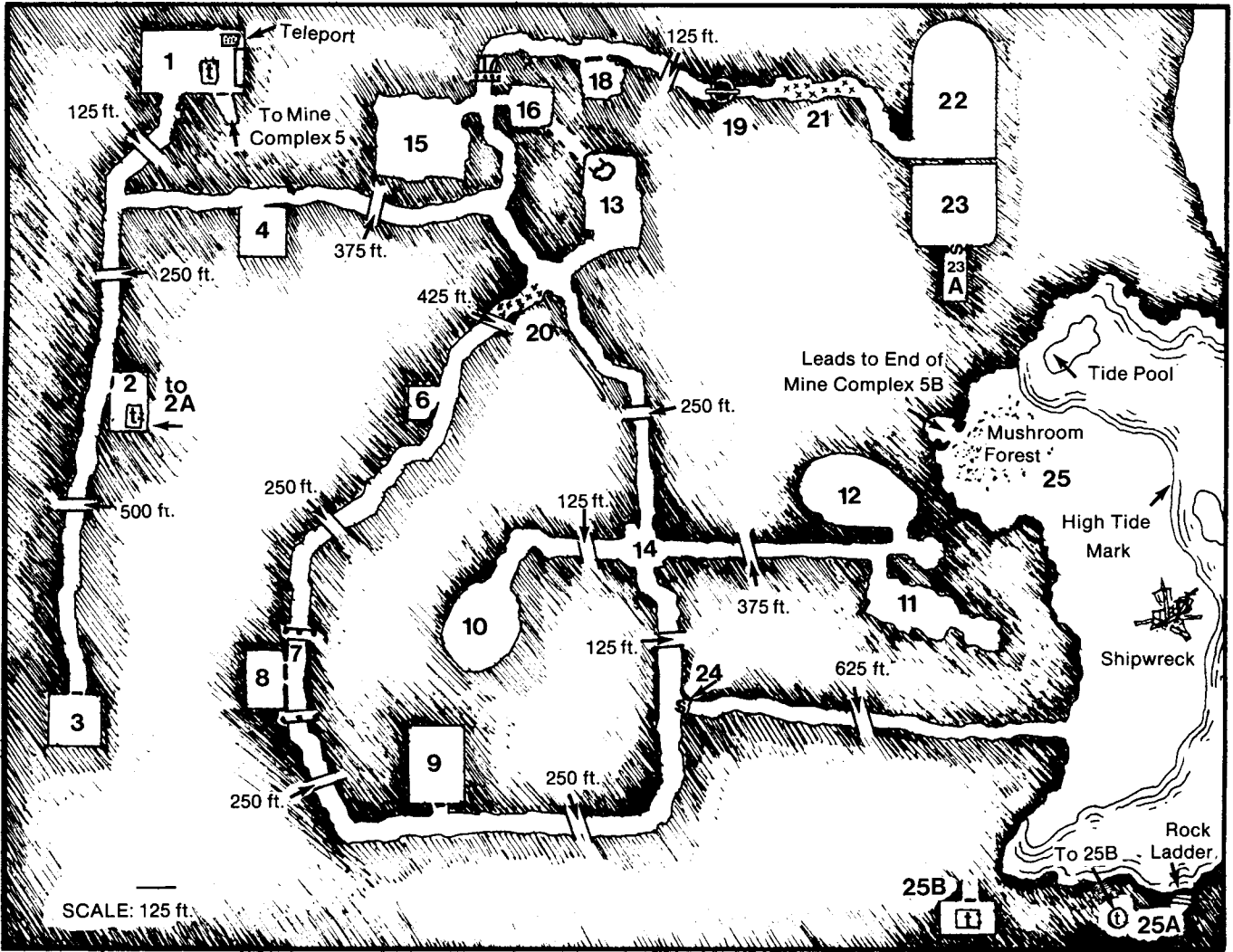

MINE COMPLEX

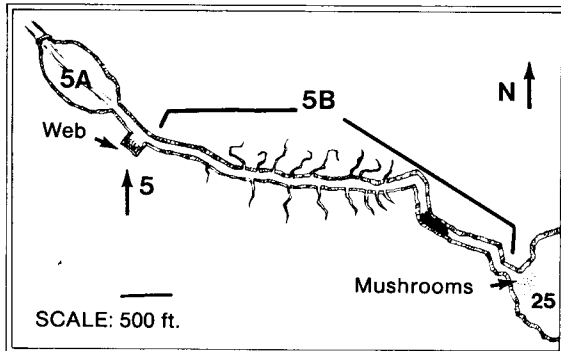

SECRET CRYPT

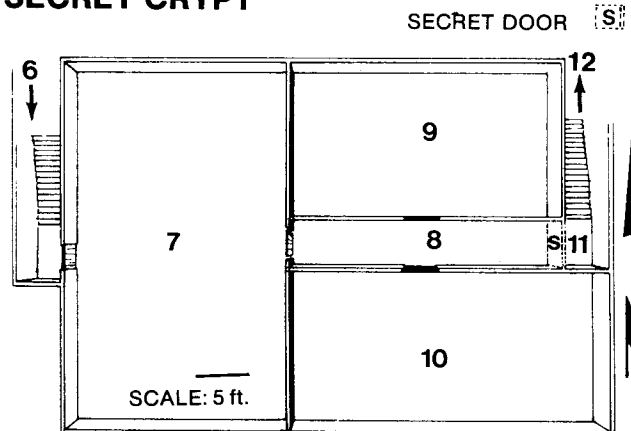

MAUSOLEUM

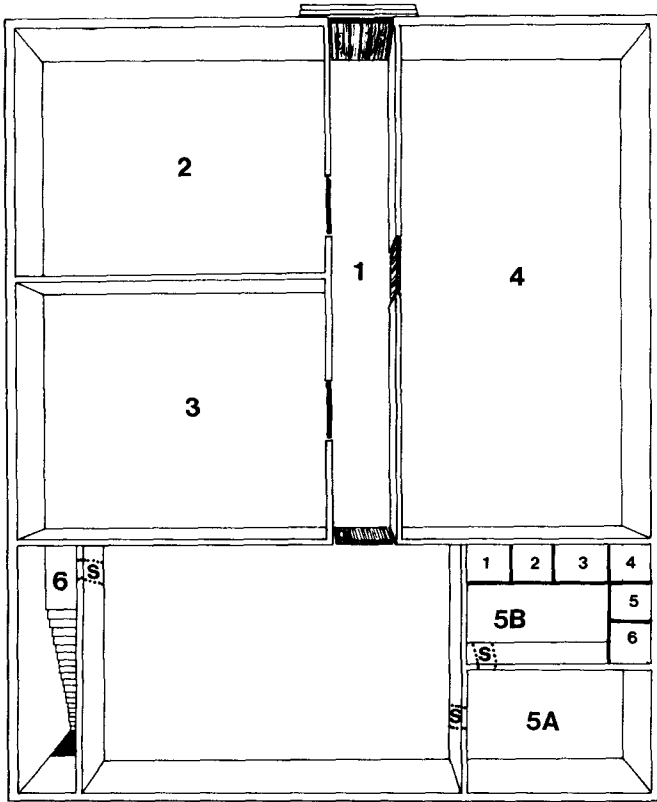

SECRET DOOR (S)

SCALE: 5 ft.

OPALESCE FOREST

SCALE: 1000 ft.

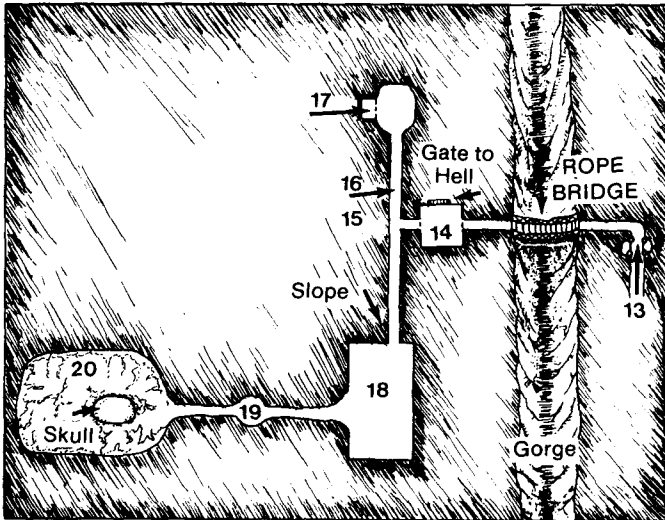
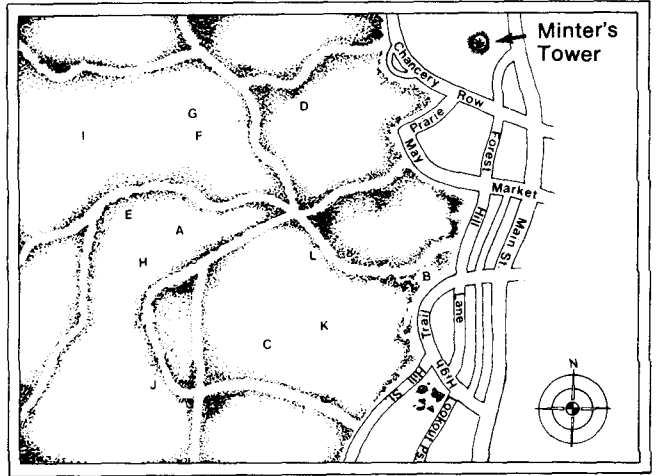

Fireplace 17 Door ---

SCALE: 10 ft.

From a small golden box of seeds grows . . .

DEADLY POWER

Enaj needs the seeds to maintain her hold on the city. Yelad craves them to avenge his murdered father. Both offer you wealth and fame to retrieve the seeds, but, neither can guarantee your safety. Within the lines of an ancient riddle is the key to it all.

DEADLY POWER is a fantasy roleplaying module for four to eight players from sixth to ninth level. Suitable for use with all popular roleplaying systems including Advanced Dungeons and Dragons*



*Advanced Dungeons & Dragons is a trademark of TSR Hobbies, Inc. Use of this trademark is NOT sanctioned by the holder.