

FEZ I™

Wizard's Wale

By James Robert
and Len Bland

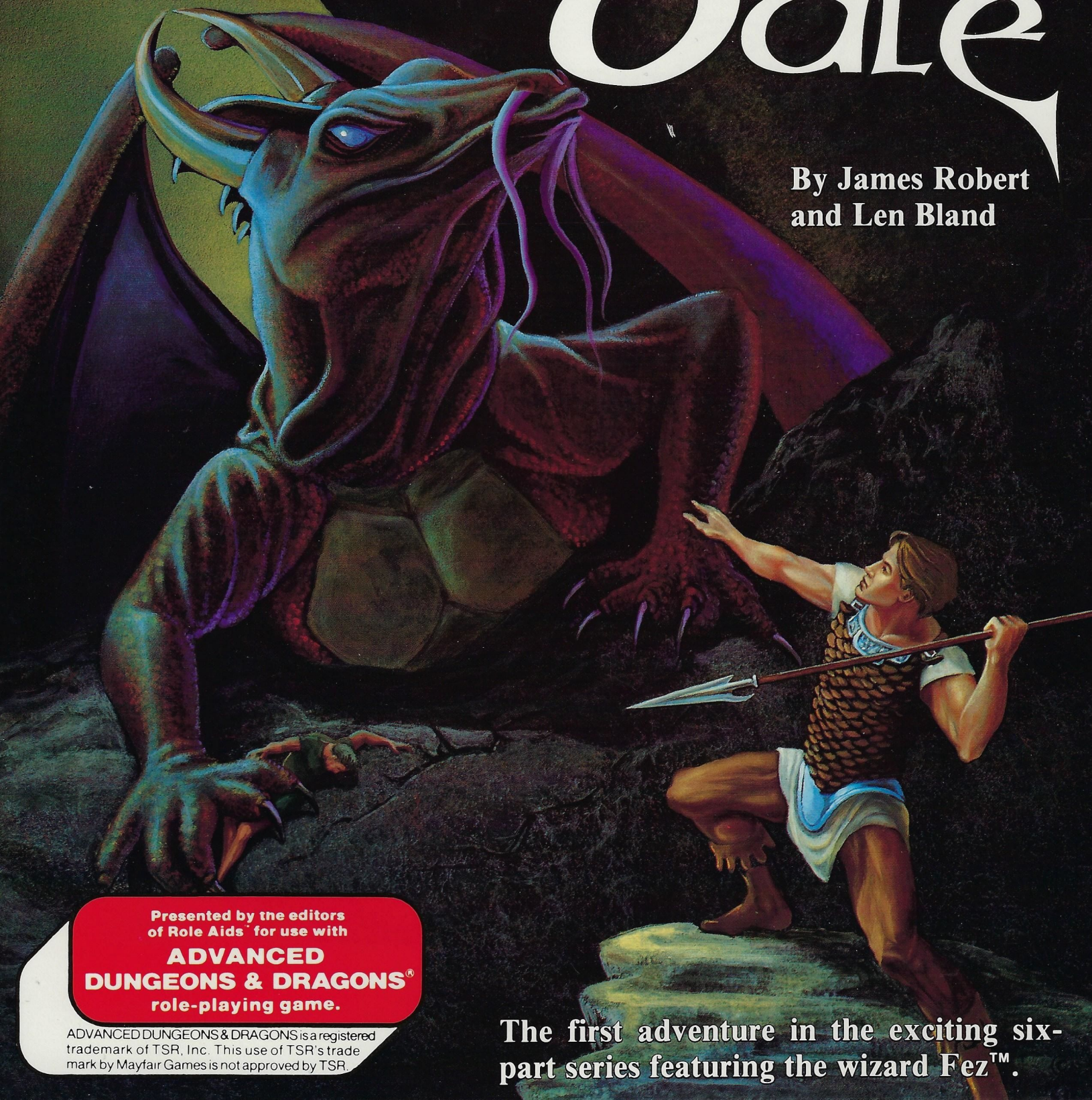

Presented by the editors
of Role Aids™ for use with

**ADVANCED
DUNGEONS & DRAGONS®**
role-playing game.

ADVANCED DUNGEONS & DRAGONS is a registered
trademark of TSR, Inc. This use of TSR's trade
mark by Mayfair Games is not approved by TSR.

The first adventure in the exciting six-
part series featuring the wizard Fez™.

HOW TO USE THIS BOOK

Standard terms/abbreviations 'D' is used as an abbreviation for "die" or "dice". 1D20 means roll one 20-sided die; 1D100 (or D%) means roll two 10-sided dice sequentially, generating a percentage or number between 01 and 00 (read 00 as 100); 3D6 means roll three 6-sided dice and add the results for the sum, etc..

Value assumes that the value of one gold piece is about \$20 in current U.S. dollars. An income of 10 gold pieces (or gp) would be a very profitable day for a merchant, but 1-5 gold pieces is a more likely sum for a day's effort. Henchmen's wages are usually 2 gp per day per 2 skill levels, with a dramatic increase for jobs that are perceived to be dangerous.

Armor Class works on a scale in which a lower number is better. A Character with no armor has AC: 10 (unless otherwise stated within a Character's race statistics). A shield subtracts one to make it AC: 9; chain mail is AC: 5; and plate and shield is AC: 2. (See the standard rule book for details).

HTK means Hits To Kill. This is the number of points of damage that a Character or monster may sustain before being killed. Player Characters and Non-Player Characters determine how many HTK they have by rolling one die for every skill level they have (unless otherwise stated); the number of sides the die has depends on the Character's class (see standard rule book for more information on determining how many HTK PCs and NPCs have).

Monsters always use 8-sided dice to determine how many HTK they have. The number of dice used is indicated in parenthesis for monsters.

Movement (MV) is the speed of a Character or monster on a constant basis. It can be adjusted to whatever scale is needed by adjusting ground scale accordingly (the most common is 1 square or hex = 10 feet).

There may be two or more numbers given. This indicates that the Character or monster can travel in more than one mode (see standard rule book).

THACO is a convenient statistic meaning "To Hit Armor Class 0." When you know a Character's or monster's THACO, you will know the number required to score a successful hit on 1D20 (or multiply that number by 5 to get the percentage chance of success). A target's Armor Class is subtracted from the attacker's THACO to obtain the required die roll on 1D20.

For example, if a Character's THACO is 16 and his target is wearing chain mail with no shield (AC: 5), the Character needs to roll 11 or less on 1D20 (16-5 = 11) or roll 55% or less on a D% (11 x 5% = 55%).

Characteristics (or attributes, ability scores, or statistics) are derived from 3D6. The

lowest score for a human is 3 and the highest score is an 18/00 (see standard rule book for more information).

Spells: A series of numbers given in a Character's statistics indicates the number of spells per skill level that the Character has. For example, 3/3/2 means that the Character has three skill 1 spells, three skill 2 spells, and two skill 3 spells. (See the standard rule book.)

Saving Throws (save vs.): Saving throw values are listed for each Character class in the standard rule book. To make a successful saving throw, a Player must roll the saving throw value or higher on 1D20. A successful saving throw often reduces or negates certain types of damage.

Saving throw bonuses are added to the number the Character rolls on 1D20. For instance, the save vs. Breath Weapon for a skill 4 cleric is 15. He must normally roll a 15 or higher to save vs. Breath Weapon; if wearing armor which gives a +2 vs. Breath Weapons, however, he need only roll a 13 or higher to make a successful saving throw (13+2=15).

Saving throw penalties are subtracted from the number a Character rolls on 1D20. For example, the same skill 4 cleric suffering a -2 penalty vs. Breath Weapons would have to roll a 17 or higher to make a successful saving throw (17-2=15).

Ability Rolls on a Character's statistics work much like saving throws. On certain occasions, your Character will be directed to "save against" a basic statistic.

For example, if a Player wants his Character to detect a lie or get information, he may have to save on a die roll against his Insight (INS).

Roll 1D20 for all ability rolls. If the resulting number is *equal to or lower than* the statistic, the save is successful. With such a roll, a Character is able to tell if a person is lying, for example.

Ability rolls are often modified. If instructed to make an INS ability roll (roll against a Character's INS) at +3, add 3 to the die roll. For example, if a Character's INS is 12 and rolls a 10, he fails to make the save (10+3 = 13).

Reading the Entries

Each entry in this book has two sections. What the GM reads to the Players is printed in *italic type*. This section is followed by three asterisks, as follows:

The portion of the text that tells what the GM should know is printed in regular (Roman) type.

Any information that is of special interest to the GM in conducting the adventure will be indicated by the words: **GM NOTE** or simply **NOTE**.

Example:

11 CASCADE Entrance to Cavern Level II

A small waterfall flows from a hole in the center of the ceiling. It feeds a stream that cuts through the cave and flows down the passageway to the east.

The hole in the ceiling is about 8' in diameter and it leads up vertically. The rush of falling water is not sufficient to impede a climbing attempt.

NOTE: This hole in the ceiling is the only access to Cavern Level II.

In some cases, the party will confront more than one opponent in a cave or room. When this happens, the number of attacking opponents will be shown in parenthesis before the opponents' name or monster type, as in this example:

(6) *Dire Wolves*

HTK: 12x2, 18, 21, 27x2 (3D8+3), AC: 6

AT: 1, DM: 2-8

MV: 18", AL: Neutral

INT: Semi-

Size: M (L)

THACO: 16

ABBREVIATIONS

STR	Strength
INT	Intellect
INS	Insight
DEX	Dexterity
STA	Stamina
APL	Appeal
HTK	Hits To Kill
AC	Armor Class
MV	Movement
AL	Alignment
AT	Attacks
DM	Damage
THACO	To Hit Armor Class 0
L. Good	Lawful Good
L. Neutral	Lawful Neutral
L. Evil	Lawful Evil
N. Good	Neutral Good
N. Evil	Neutral Evil
C. Good	Chaotic Good
C. Neutral	Chaotic Neutral
C. Evil	Chaotic Evil
PC	Player Character
NPC	Non-Player Character
cp	copper piece(s)
sp	silver piece(s)
ep	electrum piece(s)
gp	gold piece(s)
pp	platinum piece(s)
GM	Game Master
S	Smaller than man-size
M	Man-size
L	Larger than man-size

Wizard's Vale

TABLE OF CONTENTS

<i>Wizard's Vale Map</i>	Inside Front Cover
Gamemaster's Introduction	page 3
The Code (sidebar)	page 3
Players' Handout: The Awakening	page 4
<i>Lisa's Hut Map</i>	page 4
Players' Introduction: Lisa's Hut	page 5
Player Characters	page 6
<i>Wizard's Vale Drawing</i>	page 7
<i>Secret Entry Drawing</i>	page 7
Wilderness Encounters	page 8
Kassaka's Keep	page 9
<i>Kassaka's Keep Map</i>	page 11
Village of Normal	page 11
Mite's Castle	page 12
<i>Mite's Castle Map</i>	page 13
<i>Sand's Transplacer Kit Drawing</i>	page 15
Shomon's Keep	page 16
<i>Shomon's Keep Map</i>	page 16
Tal's Chapel	page 18
<i>Tal's Chapel Map</i>	page 19
Castle Fez	page 20
<i>Castle Fez Map/Drawing</i>	page 20
Objectives (sidebar)	page 21
The Prophecies (sidebar)	page 22
<i>Castle Towers Maps</i>	page 28-31
Battle with Scarsnout	page 32
Epilogue	page 32

Fez I: Wizard's Vale

© 1987 Mayfair Games Inc.
All Rights Reserved.

Authors: James Robert and Len Bland
Editor: Jacqueline Leeper

Interior Art: Tim Bradstreet, Gerald O'Malley

Maps: David Bromley, Gerald O'Malley

Cover Art: David Cherry

Special Thanks: to Steve and Debbie Funck, Paul Karczag, Kevin Kinnell, Alan Nudelman, and Robert Moore for suggestions and revisions in playtesting.



and **Role Aids** are trademarks for roleplaying aids and adventures published by Mayfair Games Inc.

Fez, Fez I: Wizard's Vale, Fez II: The Contract, Fez III: Angry Wizard, Fez IV: Wizard's Revenge, Fez V: Wizard's Betrayal, and Fez VI are trademarks of James Robert and Leonard Bland, are used by the publisher with the permission of James Robert and Leonard Bland, and may not be used without their permission.

No part of this book may be reproduced in any form or by any means except for the inclusion of brief quotations in a review, without permission in writing from the publisher. Permission is granted to the purchaser of this book to copy the maps and histories for personal use, provided that none of the copies are sold or traded.

All characters in this book are fictitious. Any resemblance to actual persons, living or dead, is purely coincidental.

Manufactured in the United States.

ISBN: 0-912771-02-X

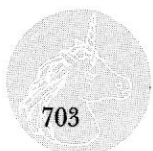

Gamemaster's Introduction

THE FEZ ADVENTURES

Imagination, puzzle-solving, and thinking are elements which make the Fez adventures popular. This story is the first in a series of six fantasy role-playing adventures featuring the Chaotic Good Fez, the Wizard of Time Travel. In each adventure, Player Characters must fulfill ancient prophecies, overcome heavy-duty villains, and solve challenging riddles and puzzles. These modules may be played in sequence, or each can be played on its own.

Fez's main role in these adventures is to travel through time and secure prophecies and artifacts to aid the party. The wizard stakes his reputation, and even his life, on the ability of stouthearted adventurers to reason out any riddle, out-think any monster, and find an imaginative solution to the most difficult puzzles.

When Fez was a baby, the evil dragon, Scarsnout, ravaged Fez's beautiful valley. Fez's parents died, but he escaped with his four older brothers. His brothers were raised by Warrior, a mysterious black robot.

At the age of 22, Fez discovered the secret of time travel. He used this knowledge to travel through time to study at the finest universities. To increase his prowess as a magic-user, he studied ancient languages. To learn more about Scarsnout, he studied dragon lore. To better understand prophets and hermits, he studied heretics. With this combined knowledge, he hoped to overcome Scarsnout.

After Fez completed his education, he uncovered prophecies predicting that a "band raised from the dead" will aid a sleeping wizard in overcoming a powerful dragon. Fez realized that the prophecies explained how to defeat Scarsnout: to defeat the dragon, the wizard must have a special gem. This gem would have to be large enough to encase Scarsnout's head so that the dragon could not talk, cast spells, or use his breath weapon.

The story of how the adventurers helped Fez obtain the required gem, a huge blue diamond, is told in *Fez III: Angry Wizard*. To obtain the gem, Fez needed the powers of a great demon. The story of Fez's capture of the demon Mephistopheles is told in *Fez II: The Contract*. Thus, these adventures do not occur in chronological order, and Fez has already obtained the gem by the time this adventure takes place.

WIZARD'S VALE

Our story takes place in the Valley of Trees, the location of the castles of Fez and his four brothers, the village of Normal, the healer Lisa's hut, and Scarsnout's lair.

The prophecies which Fez discovered say that the "band raised from the dead" must

secure several items (the gem, a cloak, a globe, and the robot, Warrior, among other things) for a sleeping wizard. Fez sets in motion a plan to assure that these prophecies take place.

Fez stashes the required items at his own and his brothers' castles. The wizard then collects a band of eight adventurers to fulfill the prophecies. Lisa (the fiancée of Fez's oldest brother, Kassaka) agrees to use her powers as a healer to raise the band from the dead. The bard, Robbe, and each of Fez's brothers also agree to lend their aid to the quest.

The party trains at Fez's castle: they are told all they need to know to secure the items. Fez then goes to his dungeon and takes a powerful sleeping potion. In six months, the quest begins.

It is a good plan, but everything goes wrong.

Werewolves attack the Valley of Trees, and Kassaka (the eldest brother) is gravely wounded in the ensuing battle. He becomes infected, and, in werewolf form, tries to kill Lisa. However, Lisa escapes and warns Fez's other three brothers.

The brothers tighten the defenses of their strongholds. Mite, a scientist, programs robots to fight off intruders. Shomon, a druid, guards his keep with fierce monsters. Tal, a cleric, protects his castle with undead. Nonetheless, Kassaka murders them one-by-one.

Lisa and Robbe take the party to Lisa's hut in the forest. There, Lisa casts her spell to kill the party. But, before the spell is completed, Delyn, the magic-user of the party, panics and casts a spell at Lisa. Lisa resists Delyn's spell, but, in the process, a conflict occurs which almost totally wipes out the party's memories.

When the party members are resurrected, they have only a partial memory of their mission. Worse yet, they do not have total recall of their classes and abilities. The one thing each of them remembers is that Kassaka must be found and killed. However, they do not know who Kassaka is.

As the adventurers begin to gain consciousness, Lisa goes outside to get water from the well. But, Kassaka finds Lisa and kills her. Robbe goes to Lisa's defense and wounds the werewolf with a silver-tipped arrow. Kassaka flees to his castle.

The prophecies forbid anyone from directly aiding the band after they have been resurrected. However, Robbe relays a poem to the party; the poem indirectly helps them to fulfill the prophecies. Moreover, the jumbled thoughts the Characters experience as they awaken are filled with clues about their classes and skills.

In the hut, the party learns of Kassaka's misdeeds from Lisa's diary. Shane, the

ranger of the party, can follow Kassaka's tracks to his castle.

After the band kills Kassaka, the Characters are helped by the God with No Name. Lisa's ghost appears before them and recites a poem which explains that they must secure different items from each of Tal's, Shomon's, and Mite's castles.

After the required items have been gathered, the party goes to Fez's castle. There, a beggar recites a third poem telling them that a copy of the prophecies is hidden in Fez's castle. Only when the Characters have done all that is foretold in the prophecies will Fez's servants allow them to see the sleeping wizard. The adventure ends with Fez and the party entering Scarsnout's lair to confront the dragon.

Before play begins, the GM should give the Players a copy of the *Players' Handout* section. After the Players have read and discussed the handout, play begins with the section entitled, *Lisa's Hut*.

THE CODE

Anything in this adventure that is written in code translates to three letters back in the alphabet. So, D, E, F translates as A, B, C. Note that A, B, C translates as X, Y, Z.

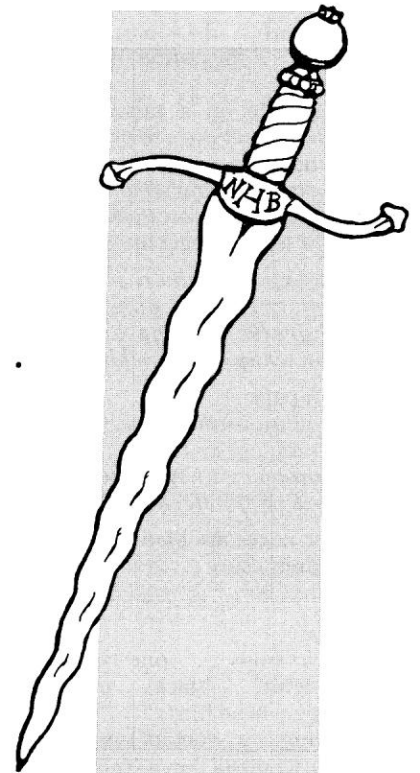

Players' Handout: The Awakening

It is a moonlit night. You are in a hut in a forest clearing. You have been raised from the dead by a beautiful woman. A bard helps the woman administer a potion to each of you. You see her place a small amount of the potion on the lips of each of your companions. As each of you awaken, she gives you a sip of the same liquid.

While you are recovering, the woman goes outside to fetch water from the well. A wolf attacks her, and the bard rushes to her defense and shoots the wolf with silver-tipped arrows. The bard wounds the wolf, but not before the woman is killed. You are too weak to stand, let alone help. The wolf escapes, running north into the woods. The bard weeps at the death of his friend.

Characters' identifying features:

Delyn: female, human, robes, spell book

Heathertoos: female, shireling, two bows, twenty-three arrows, dagger

Mondae: male, elf, leather armor, sword, short bow, twelve arrows, silver ring

Radan: male, human, three-piece suit, tool kit, can of mace

Shane: male, human, great sword, cross-bow, leather armor

Sir Laetuumakki: male, human head, wings, body of a lion

Sol: male, human, robes, scroll, wand, five gems

Sourpatch: male, dwarf, great sword, plate mail, eye-patch

THE BEGINNING:

Delyn:

Pain... it hurts... dress: a fine silk robe. "Kill Kassaka"... the potion, it's doing its job.

"Never gamble on a mission," your mentor said... you have a book... you do not recall what is written in its pages... to read it is to gamble... but what else are you to do?... trembling, you open the book. The first and second pages are the same:

*hvvhqjh ri voxpehu, srzhu ri vohhs,
gr pb elgglqj, rxu sdfw gr nhhs.
hqjxoi pb hqhplhv, rqh dqg doo,
wloo l dzdnh wkhþ, zkhuh wkhh idoo.*

On the third page:

*srzhuv ri elgglqj, irufhv ri zhe,
rehb pb frppdqg, gr dv l elg.
elqg pb rrsrqhqwv, rqh dqg doo,
hdfk vkdoo eh vkdfnohg, hdfk vkdoo idoo.*

The other pages are blank... what it means you aren't sure... you are sure you wrote it.

Heathertoos:

Concentric rings... one ring within another... white... black... more rings. Red... blue... head hurts... "Open your eyes, shireling," a woman says... she forces the bitter drink down your throat...

not like the sweet wine of your homeland. A wolf cries in the darkness, a hunting cry.

"The dagger is the key"... the woman goes outside... "Kill Kassaka"... you have a dagger, two bows, twenty-three arrows, a left glove... glove fits to your elbow... light chain mail.

Mondae:

You are taller than the others, an elven prince... "Kill Kassaka"... what does it mean?... in your pack: a dagger, ten silver pieces, eight metal strips — some bent at right angles at the end — about three inches long and all in a leather case, beef jerky, a tinder box, and flint... you reach into your pocket... there is a silver ring with an inscription, "Zruq l gr nloo."

Radan:

The woman gives you a drink from a flask... no anesthesia and no scalpel... you ask, "Did you cure me?"... she replies, "If it looks like a rock, is rough and smooth like a rock, sinks in water like a rock, then it's probably a rock."... you have a tool kit and a can of mace.

"Kassaka must be killed!"

The clock is pounding, pounding, pounding... something blocks the main-spring. You stagger over to the clock and push aside the parchment blocking the spring.

Shane:

The woman gives you a bit more fluid... pleasant odors... you are in a hut in the forest... she moves to the next cot... her tracks reveal that she has a hole in the sole of her left sandal.

A wolf howls in the woods... a hunting call... "First, you must kill Kassaka"... but who is Kassaka?

Sir Laetuumakki:

The healer is a truly good person... she can heal more than you are capable of...

the others in the room are also good people, but they could not compare with her kindness and concern for others... she and the man move on to the next body... You extend the claws of your front paws... long, sharp, fighting claws... not like the claws of your rear paws... These are paws meant to help you walk and land... Land?... Of course! With two strong feathered wings you can fly. You can even carry a passenger if you want to... Your hide is light gold, your mane is darker gold, your face is that of a human.

The woman goes outside... evil enters the clearing... the woman is attacked... too dizzy, too late to help her... "Kassaka must be found and killed."

Sol:

You are alive again... memory is weak. You will do your best to remember... the woman passes to the next body... a room of fools... "Kill Kassaka"... let's see... the usual stuff... a scroll, Bless, a Cure Light Wounds, a war hammer, five gems, foodstuff, a silver wand in a felt pouch.

Sourpatch:

The woman gives you a bitter-tasting fluid. "Sourpatch, I can restore health and life. I would restore your sight if I could." Once before you felt this way: the time you lost your left eye... but it had been worth it... Storm's Sword: your good eye focuses on the sword at your feet... its scabbard is encrusted with gems and with the inscription: "Gudz rqob wr nloo, Vwrup'v Vzrug"

A wizard told you the inscription means, "Draw only to kill, Storm's Sword"... kill... there's something you must do... "Kill Kassaka, or all will be lost."

A fight takes place in the yard... you rise to help, but fall back on the couch, dizzy... none of you have recovered enough to help... the man chases the monster away, then he cries out, "The healer is dead."

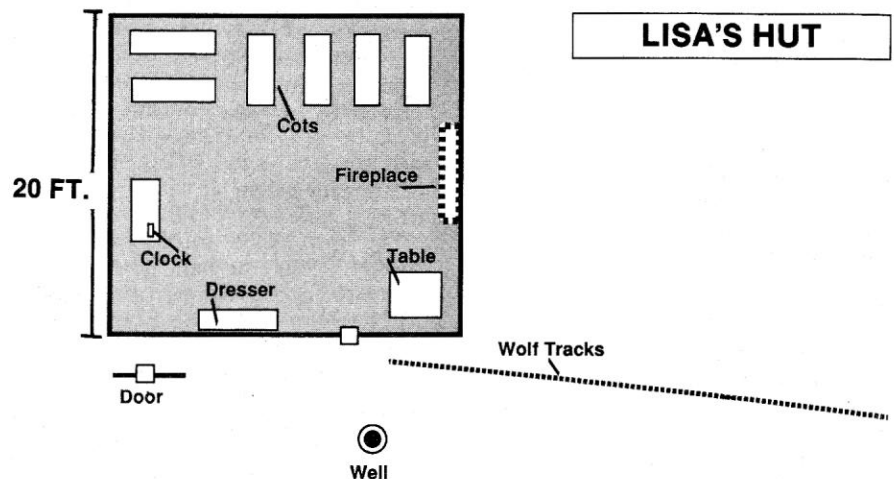

Players' Introduction: Lisa's Hut

After the Players have read their hand-out, read the following aloud:

When you have the strength to get up and go outside, the bard asks both Sol and Sir Laetuamakki to say prayers for their friend, Lisa. After the prayers, the bard digs a grave. As he digs, he recites a poem:

*Eight awaken, quest is taken,
healer raised thief and lord.
Soldiers bribe, trolls hide,
coded magic on the sword.*

*Brothers five, two alive,
death has taken all the rest.
Castles stand, this land,
order is important to your quest.*

*Castle towers, clock hours,
a map lies within.
Entry grave, escape cave,
Kassaka sleeps in sin.*

Your party returns to the hut to collect your belongings. The hut contains two cots, a table and chair, a dresser, a wall clock, and a fireplace. Three two-foot-long sausages hang on the wall beside the fireplace. An ink bottle, a writing quill, a stack of papers, and a silver vial are on the table.

GM NOTE: Tell the Players to refer to the *Lisa's Hut* map, which is on the *Players' Handout* page.

Items in the hut are described below. Items 7 and 8 refer to Kassaka's tracks and to the bard, Robbe.

1) Lisa's Papers

Most of the papers are anatomical notes and drawings. Each sheet is signed, "Lisa the Healer."

One parchment tells how to make a life-restoring potion that is first applied to the lips of the Character to be raised, then administered to that Character when s/he begins to awaken. The potion must be kept in a sealed container or it will dissipate. The ingredients can only be obtained in an apothecary in a far away land.

Another paper is an unfinished letter to Lisa's father. It tells of her recent troubles. Lisa wrote that once she and Kassaka were engaged, but that their marriage is now impossible. Lisa wished that she did not have to kill Kassaka herself. She also hoped that the band she was training could have the means to overcome the evil dragon, Scarsnout.

Another paper mentions five names in cryptic notes:

Kassaka, the oldest brother, Lawful, fighter, hero, gravely wounded in the Battle of the Wolf People five full moons ago.

Tal, second oldest brother, Neutral, religious. Tal (fearing Kassaka's wrath) filled his chapel with undead. Even so, Tal was murdered in his chapel three full moons ago. The body is nearly unrecognizable.

Shomon, the middle brother, Neutral, a man of the woods. Shomon guards his keep with fierce monsters. Peasants witnessed a large wolf kill Shomon near his keep two full moons ago.

Mite, the second youngest, Chaotic scientist. Metal machines guard Mite's castle. The morning following the last full moon, Mite's body, torn to shreds, was found floating in the Blue River.

Fez, the youngest, Chaotic, Wizard of Time Travel. Six months ago Fez sealed himself in his dungeon.

2) The Clock

This clock rings up to twenty-four times each hour, depending on the hour. A piece of parchment is lodged in the clockwork.

GM NOTE: If the Player playing Randan mentions the piece of paper lodged in the clockwork, or if any other Player Characters investigate the clock, give the Players a copy of the drawing entitled, *The Secret Entry*.

3) The Dresser

The dresser contains clothing appropriate for an adult woman. A map is hidden beneath a washcloth in the bottom drawer.

GM NOTE: When the Player Characters investigate the dresser, give them a copy of the drawing entitled, *Wizard's Vale*.

4) The Silver Vial

The silver vial is sealed with an ivory stopper. It contains a pungent-smelling fluid; there is enough for two uses.

The fluid acts as a **Raise Dead Fully** spell (skill 6 cleric spell). This spell is the same as a **Raise Dead** except for the following:

- No saving throw (Resurrection Survival) is needed to survive the ordeal of being raised.
- Character raised will be able to function normally in 1D4 turns.
- This spell can raise a Character who has been dead for up to five weeks.

5) Sausages

The sausages are very tasty. PCs can use them to bribe the troll in Kassaka's Keep.

6) Other Items

Other items in the hut are normal.

7) (Outside) Kassaka's Tracks

Wolf tracks lead north into the woods. Shane can follow them easily.

8) (Outside) The Bard

If Robbe is asked about raising Lisa, he tells the party that Lisa's body is damaged too extensively. After burying the healer, the bard goes his own way.

Robbe will give Heathertoos three silver-headed arrows (DM: 1D6; does triple damage to lycanthropes).

GM NOTE: For all overland travel, the GM should refer to the section entitled *Wilderness Encounters*.



Player Characters

When the Player Characters awaken at the beginning of the adventure, they only remember as much as the Players are told in the *Players' Handout*. There are clues throughout the Players' information which can facilitate the gradual return of the PCs memories. The GM may reveal additional information about each Player Character's class at his/her discretion. Also, the GM may tell a Player what his/her Character's class is when the Character does something appropriate to his/her class.

NOTE: All bonuses are included. Statistics in brackets [] will apply after the party receives the gift from the God with No Name.

DELYN

Human, Skill 3 [5] Magic-user

STR: 12, INT: 17, INS: 10

STA: 15, DEX: 16 (+1, -2), APL: 13

HTK: 11 [16] (3D4 [5D4]), AC: 9

AT: 1, DM: by weapon type

MV: 12", AL: N. Good

THACO: 20 [20]

Weapon Proficiencies: dagger

Weapons: dagger

Magic Items: spell book (*Sleep, Web*)

Spells: 2/1 [4/2/1]

Specials: When play begins, Delyn can use her spells as soon as she decodes them.

DELYN'S SPELLS

First spell (Sleep):

Essence of slumber, power of sleep,

do my bidding, our pact do keep.

Engulf my enemies, one and all,
till I awake them, where they fall.

Second spell (Web):

Powers of binding, forces of web,

obey my command, do as I bid.

Bind my opponents, one and all,
each shall be shackled, each shall fall.

HEATHERTOES

Shireling, Skill 4 [6] Fighter

STR: 11, INT: 14, INS: 8

STA: 9, DEX: 16 (+1, -2), APL: 15

HTK: 19 [28] (4D10 [6D10]), AC: 4

AT: 1, DM: by weapon type

MV: 12", AL: N. Good

THACO: 18 [16]

Weapon Proficiencies: crossbow, dagger, short sword, sling, [darts]

Weapons: two crossbows, twenty-three bolts, and +2 magic dagger

Armor: +2 leather

Specials: None

HEATHERTOE'S DAGGER

The inscription "NHB" (translates to "KEY") is engraved in the hilt of Heather-toe's dagger. This magical dagger is the physical key required to leave one of the rooms in Shomon's Keep.

MONDAE

Elf, Skill 4 [6] Thief

STR: 16 (0, +1), INT: 14, INS: 14

STA: 9, DEX: 17 (+2, -3), APL: 13

HTK: 15 [22] (4D6 [6D6]), AC: 4

AT: 1, DM: by weapon type

MV: 12", AL: N. Good

THACO: 20 [19]

Weapon Proficiencies: short sword, short bow, dagger

Weapons: short sword, short bow, two daggers

Armor: +2 leather

Magic Items: Killing Ring (see *Special Items*), +1 short bow, magic lockpicks

Specials: Mondae does double damage when attacking with surprise; Thief Abilities: Pick Pockets: 45% [55%], Open Locks: (special: see *Mondae's Tools* below), Find/Remove Traps: 35% [45%], Move Silently: 33% [47%], Hide in Shadows: 25% [37%], Hear Noise: 15% [20%], Climb Walls: 88% [92%], Read Languages: 20% [30%]; although he is a thief, he can use a short bow.

MONDAE'S RING

This ring is a Killing Ring. Its inscription translates to "Worn I do kill." If any Character places the Killing Ring on his/her finger, it numbs the wearer in one round and kills the wearer in two rounds (occurs automatically).

MONDAE'S TOOLS

Mondae's tools are magic lockpicking tools. They open all non-enchanted locks.

RADAN

*Human, Skill 4 [6] Engineer**

STR: 7 (-1, 0), INT: 18, INS: 8

STA: 9, DEX: 17 (+2, -3), APL: 11

HTK: 10 [17] (4D4 [6D4]), AC: 10

AT: 1, DM: by weapon type

MV: 12", AL: Neutral

THACO: 20 [19]

Weapon Proficiencies: can of mace, [dagger]

Weapons: can of mace

Specials: Radan can repair/operate any of the technological devices in Mite's Castle.

* Treat as a magic-user when using charts in the standard rule book.

RADAN'S TOOL KIT

Radan's tool kit contains a portable soldering rod, solder, and assorted tools: pliers, screwdrivers, and small wrenches. With the kit, Radan can repair any electronic device in Mite's castle.

RADAN'S CAN OF MACE

The can of mace has four uses. Each use is equivalent to a Stinking Cloud spell, but only affects one creature.

SHANE

Human, Skill 4 [6] Ranger

STR: 15, INT: 15, INS: 13

STA: 16 (+2), DEX: 16 (+1, -2), APL: 11

HTK: 20 [31] (4D10 [6D10]), AC: 4

AT: 1, DM: 2D8+1 (Sword of Lycanthrope Bane)

MV: 12", AL: N. Good

THACO: 18 [16]

Weapon Proficiencies: broad sword, short sword, dagger, crossbow, [long bow]

Weapons: Sword of Lycanthrope Bane

Armor: +3 leather

Specials: 98% at tracking

SHANE'S SWORD

Shane's great sword is named, "Lycanthrope Bane." This broad sword is +1 to hit and +1 on damage. Moreover, it automatically kills any lycanthrope on a successful hit.

SIR LAETUAMAKKI

*Lammasu, Skill 4 [6] Lammasu**

STR: 16 (0, +1), INT: 9, INS: 15

STA: 15 (+1), DEX: 16 (+1, -2), APL: 9

HTK: 18 [27] (4D8 [6D8]), AC: 5

AT: 2, DM: 1D8x2 (claws)

MV: 12"/24", AL: N. Good

THACO: 18 [16]

Weapon Proficiencies: staff, club, bo stick

Weapons: None

Armor: None (natural)

Spells: Know Alignment (at will), two [four] Cure Light Wounds spells (cures 1D8+1 HTK each)

Specials: Can carry one passenger while flying. Saves as skill 4 [6] cleric. [After Laetuamakki receives Lisa's blessing in Kassaka's Keep, he can Turn Invisible at will and can cast up to four Dimension Door spells daily.]

* Treat as a cleric when using the charts in the standard rule book.

SOL

Human, Skill 3 [5] Cleric

STR: 14, INT: 12, INS: 17

STA: 11, DEX: 9, APL: 14

HTK: 14 [23] (3D8 [5D8]), AC: 9

AT: 1, DM: 1D4+2 (war hammer) or by spell

MV: 12", AL: N. Good

THACO: 20 [18]

Weapon Proficiencies: war hammer, staff, [footman's flail]

Weapons: +1 war hammer

Armor: robes

Magic Items: wand: turns undead, scroll (contains two spells: Cure Light Wounds and Bless).

Spells: 2/1 [3/3/1]

Specials: Sol's wand will turn undead of six HTK dice or less if he holds the wand in front of the undead he is turning.

SOL'S WAND

If a cleric holds this wand before undead, he can automatically turn undead of six or less HTK dice. The wand has 85 charges; it expends one charge per use.

At the time he is resurrected, Sol does not know what the wand does. However, he will recognize it's holy symbol if he investigates the wand.

SOURPATCH

Dwarf, Skill 5 [7] Fighter

STR: 17 (+1, +1), INT: 9, INS: 16

STA: 16 (+2), DEX: 17 (+2, -3), APL: 8

HTK: 28 [36], AC: 2

AT: 1, DM: death or 1D10 (Storm's Sword)

MV: 12", AL: C. Good

THACO: 16 [14]

Weapon Proficiencies: short sword, crossbow, short bow, dagger, sling, [halberd]

Weapons: Storm's Sword

Armor: +1 plate mail

Magic Items: +1 plate mail

SOURPATCH'S SWORD

Sourpatch carries Storm's Sword. This

short sword automatically kills on its first hit in melee. Thereafter, it is +5 to hit and does 1D10 HTK of damage. Once it is drawn, it must be resheathed to automatically kill again. If a Character draws the sword without entering melee, it will overpower that Character and kill a random being in the area.

The inscription on the scabbard translates to: "Draw only to kill, Storm's Sword."

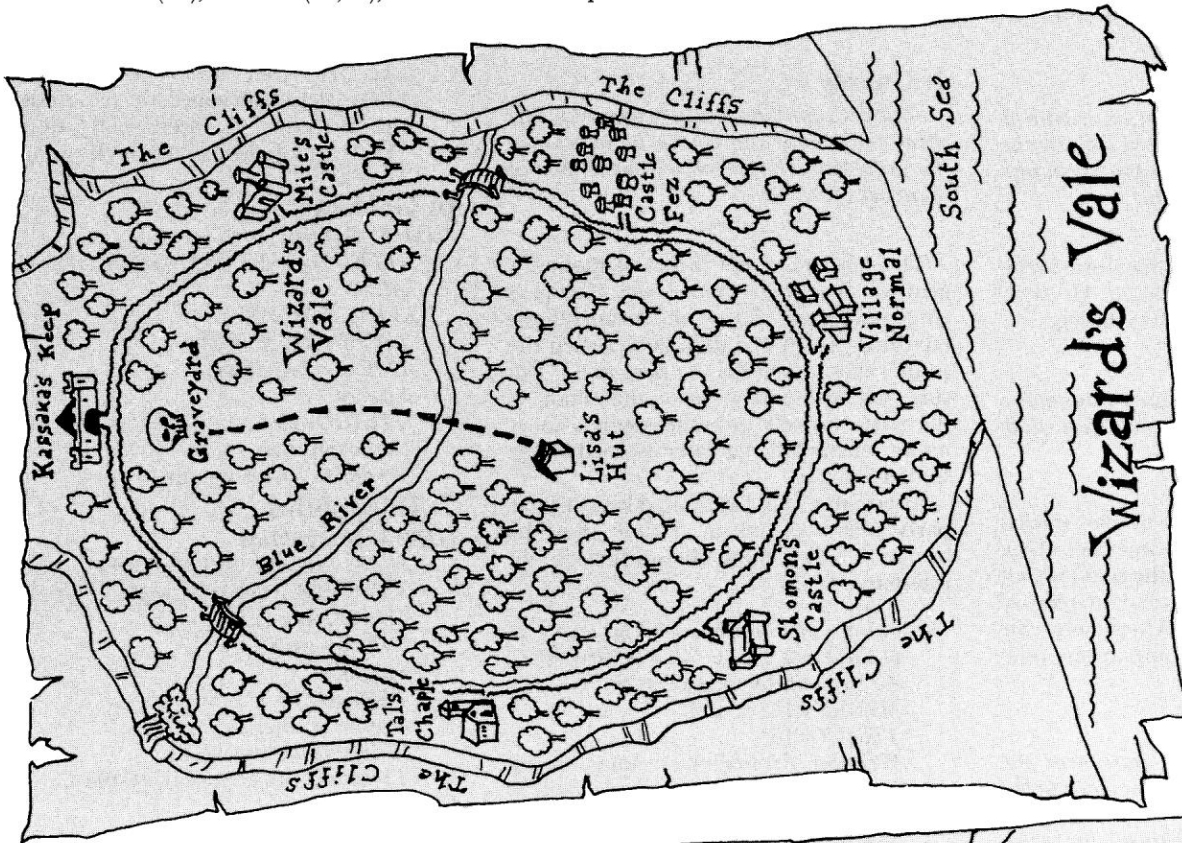

Wizard's Vale Drawing

Secret Entry Drawing

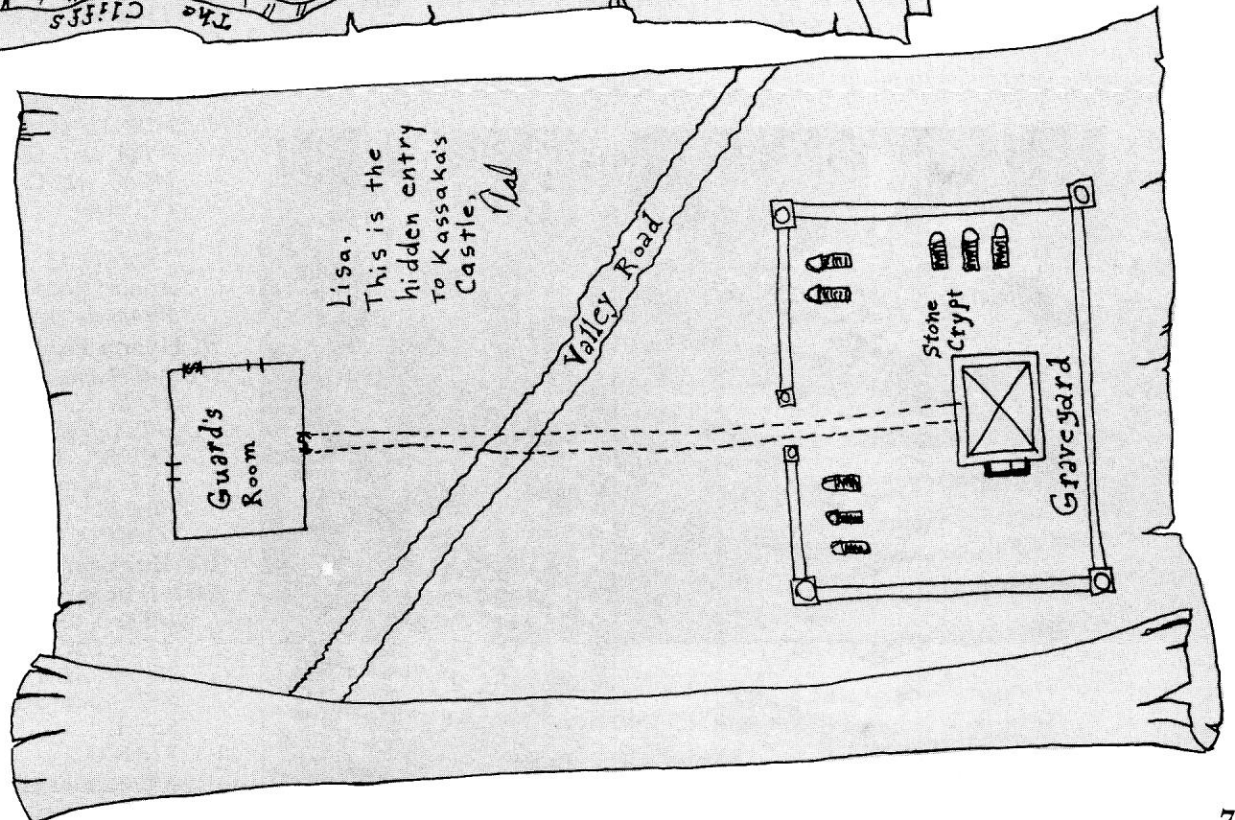

Wilderness Encounters

Use the *Wizard's Vale* map for the wilderness encounters. If the party traverses through or enters a numbered hex, the encounter corresponding to that number will occur. **Encounters 5 through 10** are standard monster encounters. For these encounters, the monsters' names and statistics are given for each number listing.

1: A Broken Arrow

There is a bloodied, broken, silver-tipped arrow lying in the trail. A set of wolf tracks leads north; at one point the tracks change to those of a barefoot human.

Kassaka changed into human form at the place where the tracks change. He then removed the arrow from his right leg.

2: The Blue River

There is a set of tracks which stops at the riverbank. The river is seventy feet wide and flows from west to east.

Kassaka's trail (barefoot human tracks) continues due north on the other side of the river. The party can swim the river, which is twenty feet deep, but they have to remove their armor to do so. Alternately, Sir Laetuumakki can fly his companions, one-by-one, across the river.

3: Castle Ruins

There are tracks which pass near the ruins of a castle. Only the outer walls of the castle are still standing. The stones of what remains of the inner walls are pockmarked.

This was the location of Fez's father's castle. One hundred years ago, Scarsnout (whose breath weapon is a powerful acid) completely destroyed the castle after killing Fez's parents.

4: Guards

Soldiers guard the bridge; each one wears shiny chain mail and a violet band bearing the gold letter K on his left arm. One of them asks for a pass.

The soldiers accept bribes of money, a gem, or any magic item (even Mondae's ring) as a "pass." If the soldiers are offered anything worth less than 20 gp, then the soldier who asked for the pass says, "I'm sure you have more with you than that." If the party doesn't give the soldiers more money or an item of greater value, then the soldiers attack.

Alternately, Sir Laetuumakki can ferry party members one at a time past the bridge. If this is done, the soldiers do not interfere.

(6) Soldiers, Human, Skill 5 Fighters

HTK: 25x2, 26, 30, 32x2 (5D10), AC: 4

AT: 1, DM: by weapon type

MV: 12", AL: L. Evil

THACO: 16

Weapon Proficiencies: long sword, short sword, halberd, dagger, crossbow

Armor: +1 chain mail

Weapons: halberd, short sword

5: Kobolds

(1D100+100) Kobolds

HTK: 1D8-4, AC: 7

AT: 1, DM: 1D4

MV: 6", AL: L. Evil

THACO: 20

Weapons: short swords

Armor: studded leather

Specials: After twenty kobolds are killed, slept, or webbed, the remainder flee in terror. A Sleep spell affects 1D10+10 kobolds; a Web spell ties up 1D8+8.

6: Goblins

(2D4+3) Goblins

HTK: 3x3, 4x2, 5x3, 6x2, 7 (1D8-1),

AC: 6

AT: 1, DM: 1D6

MV: 6", AL: L. Evil

INT: average (low)

Size: S

THACO: 18

Armor: leather

Weapons: short swords

7: Hobgoblins

(1D4+3) Hobgoblins

HTK: 3x2, 5x2, 8x2, 9 (1D8+1), AC: 7

AT: 1, DM: 1D8 or by weapon type

MV: 9", AL: L. Evil

INT: average

Size: M

THACO: 18

Armor: leather

Weapons: short swords

Treasure: 30% chance of 1D100 sp.

8: Ogres

(1D4+4) Ogres

HTK: 14, 15, 16, 17, 18, 20, 21, 24 (4D8+1), AC: 5

AT: 1, DM: 1D6 or by weapon type

MV: 9", AL: C. Evil

INT: low

Size: L

THACO: 15

Armor: None

Weapons: clubs

9: Hyena Pack

(1D4+4) Hyenas

HTK: 12x2, 13x3, 15x2, 16 (3D8), AC: 5

AT: 1, DM: 1D8 (bite)

MV: 12", AL: Neutral

INT: animal

Size: M

THACO: 16

10: Bugbears

(1D4+1) Bugbears

HTK: 9, 11x2, 15, 17 (3D8+1), AC: 5

AT: 1, DM: 1D4

MV: 9", AL: C. Evil

INT: low to average

Size: L

THACO: 17

Armor: studded leather

Weapons: daggers



Kassaka's Keep

Kassaka's Keep is located in the northern part of the Valley of Trees, just north of the road which circles the valley.

The party needs to find and kill Kassaka, who is sleeping in his bedroom (Area 7).

There are two ways for the party to make its way to Kassaka's bedroom: 1) follow the secret tunnel which leads into the castle from the mausoleum in the graveyard, or 2) enter the castle through the courtyard (the last choice involves fighting the orcs who guard the castle).

NOTE: After Kassaka is killed, Lisa's ghost appears and aids the party (see Area 7). The ghost recites a poem telling the adventurers they must gather a separate item from Mite's, Tal's, and Shomon's castles.

1: Graveyard

The local forest consists of pine and fir trees. A castle is located north of an east-west road. South of the road is a graveyard. A ten-foot tall, 20' x 20' gray stone building stands in the middle of the graveyard.

Kassaka's tracks lead directly to the stone building (mausoleum) in the graveyard. If the door to the tomb is opened, six skeletons pour out of the doorway and attack.

(6) Skeletons

HTK: 2x2, 3x2, 4x2 (1D8), AC: 7

AT: 1, DM: 1D6

MV: 12", AL: Neutral

INT: non-

Size: M

THACO: 20

Weapons: short swords

NOTE: Sol has a 30% chance to turn the skeletons without his wand. He can automatically turn them if he uses his silver wand. Sir Laetuumakki has a 40% chance to turn skeletons.

2: The Hidden Entry

There are ten sliding metallic drawers (five on either side) inside the tomb. The drawers serve as caskets for the deceased. Six of the drawers are open and empty; four are closed.

Two of the closed drawers are empty. One contains a skeleton; the fourth closed drawer conceals the entry to a tunnel. The tunnel drops to a depth of ten feet and extends northward for 300 feet to Area 3.

Skeleton

HTK: 3 (1D8), AC: 7

AT: 1, DM: 1D6

MV: 12", AL: Neutral

INT: non-

Size: M

THACO: 20

Weapons: None

3: Troll's Bribe

This 20' x 20' cellar room has doors centered in the east and north walls. A gray troll is standing guard by the northern section of the east wall.

If a Player Character opens the door, continue reading to the Players:

The troll says, "Hey! Who are you? Trouble, I suppose. As if Slobber doesn't have enough grief! Six months Slobber stands guard, and what do the orcs feed me? Gruel, that's all! What Slobber wouldn't give for a decent sausage!"

The troll accepts any bribe (coins, food, or any remotely interesting item) to let the party pass; if he is bribed, he does not bother the party. Should the troll be offered a piece of sausage (or any other food item), he exclaims: "For months Slobber guards the two secret doors. Not once does Slobber get anything good eat! Thanks!" He then sits in the northwest corner of the room and noisily eats his treat.

There are two secret doors in this room. The secret door in the south wall opens onto the escape tunnel leading to the mausoleum in the graveyard (Area 2). The secret door in the north part of the east wall opens onto Area 6.

Slobber, Skill 7 Troll*

STR: 17, INT: 5, INS: 5

STA: 16, DEX: 10, APL: 5

HTK: 40 (7D10), AC: 0

AT: 3, DM: 1D4+4x2 (claws), 2D6 (bite)

MV: 15", AL: L. Evil

THACO: 16

Weapon Proficiencies: N/A

Treasure: Has the key to the jail cell (Area 4).

Special: Regenerates 3 HTK per melee round, beginning with the third round; only acid or fire permanently kills a troll.

* Treat as as a skill 7 fighter for THACO and HTK.

4: Jail

This 30' x 10' hallway is the jail. Three 10' x 10' cells are behind barred doors on each side of the hallway.

The troll, Slobber (Area 3), has keys to these locked cells. In the northeast cell are two human skeletons. If the troll is present when the party peers into this cell, he says, "They made Kassaka mad."

5: Stairwell

A stairwell rises ten feet from the basement to ground level.



The stairs join **Area 3** and **Area 11**.

6: The Secret Passage

Each section of this L-shaped passage is twenty feet long and five feet wide. It continues north for another twenty feet along the east wall.

This passageway extends from the troll's room (**Area 3**) to a stairway leading up to a triangular landing. The secret door in the landing opens onto Kassaka's bedroom (**Area 7**). Anyone who looks, even a non-thief Character, finds this secret door.

7: Kassaka Sleeps in Sin

This bedroom is 25' x 30'. Asleep on the large bed is a gray-furred humanoid. His claws and long yellow teeth are blood-stained. An ink bottle, a writing quill, and a bloodstained piece of parchment are on the nightstand beside the bed.

If the party kills Kassaka, read the following to the Players:

A ghost of the furred humanoid rises from the body and says, "Fools! You have killed the wrong villain. Scarsnout is the true evil, and he cannot be killed while Fez is imprisoned." The ghost then fades.

In a few moments a second ghost appears. It is the ghost of Lisa, the woman who resurrected you at the hut. She says:

"The gods have granted me two wishes. The first is that I would not have to slay Kassaka myself. The second is that your party have the means to complete the prophecies.

"Only when the prophecies have all been fulfilled should you go to Fez's castle. Together with the wizard, you will be able to defeat Scarsnout."

Lisa's ghost touches Sir Laetumakki on the forehead, "Accept the full powers of a Lammasu. You may Turn Invisible at will. Four times per day you may cast a Dimension Door up to forty feet away."

The ghost then addresses the entire party: "Listen, all of you:

"In Wizard's Vale, the prophets said, in time of peril, from the dead, A band will rise, their quest unknown, within three rhymes, their path is shown. "At two o'clock 'Warrior' found, at five o'clock there is a town. To midnight points Kassaka's Keep, at the center Scarsnout lies asleep.

"At 20 bells a ball that glows, at quarter 'til a set of clothes. And four is last and twelve is one, or else you've lost, and worm has won."

The ghost continues, "Remain here for the rest of the evening. I'll inform the castle cook to prepare a great banquet for you. Goodbye, old friends. You will not see me again."

Kassaka does not awaken unless he is attacked.

The parchment contains a list of five names: Tal, Shomon, Mite, Lisa, and Fez. There are check marks beside each of the first four names. (Kassaka checked each name on his list after killing the person named.)

If party members have been killed and/or have sustained damage in their battle to kill Kassaka, Lisa raises or heals them.

Lisa's poem refers to the valley as if it were the face of a clock (see the *Wizard's Vale* map). Scarsnout's cave is in the center. The party is now at Kassaka's Keep (at 'midnight'). They should not visit Fez's castle (at '4:00 o'clock') until after they have visited the other castles.

The three items the party needs are located at Mite's Castle, at Tal's Chapel, and in Shomon's Keep. Mite's Castle is located at two o'clock. There, the robot named Warrior waits for the party. The "set of clothes" is Fez's robe. The robe is found in Tal's Chapel, located at 9:00 o'clock. The "ball that glows" is Fez's crystal ball. It is at Shomon's Keep, located at 8:00 o'clock on the map (i.e., "at 20 bells" on a twenty-four hour clock).

Lisa's ghost disappears before the PCs can ask any questions.

The castle cook is an old female orc (see **Area 15**). She invites the party to the dining room (**Area 13**) for a meal of superb roast, mouth-watering biscuits, corn-on-the-cob, and apple pie.

Kassaka, Skill 5 Werewolf*

STR: 18, INT: 17, INS: 13

STA: 17, DEX: 14, APL: 7

HTK: 24 (5D6), AC: 10 (while sleeping), 3 (awake)

AT: 1, DM: 2D4

MV: 14", AL: L. Evil

THACO: 18

Weapon Proficiencies: N/A

Specials: Magic or silver-tipped weapons are required to damage werewolves. Both Shane's sword and Sourpatch's sword automatically kill Kassaka on a successful hit.

* Treat as a skill 5 cleric for when referring to HTK and THACO.

8: Hallway

This hallway is ten feet wide and extends east-west for thirty feet. Two doors are equally spaced along the southern wall. A single door is centered in the north wall. Another door is located in the west end of the hallway.

A tapestry with a coat-of-arms hangs on the wall at the east end of the hallway; the coat-of-arms depicts a worm swallowing its tail encircling the letter 'K.'

The design on the coat-of-arms is Kassaka's crest.

9: Study

This 20' x 15' room is a study and library. A rack of seven pipes and a sealed glass bottle containing tobacco are on the table. The bookcase shelves have been stripped of

books. Charred remains of book bindings are in the fireplace.

The orcs burned all the volumes of what was once Kassaka's fine library.

10: Servant's Quarters

This 10' x 15' room contains a cot, a dresser, a small table, and two chairs. An orc snores noisily on the cot. Beside the cot are three empty wine bottles.

The orc is defenseless and only has 4 HTK. His treasure consists of 15 sp.

Orc

HTK: 4 (1D8), AC: 10

AT: None, DM: None

MV: 10", AL: L. Evil

INT: low

Size: M

THACO: None

Special: None

11: Foyer

The foyer is 20' x 10'. A crest of a worm swallowing its tail encircling the letter 'K' is embroidered onto the carpet.

The west wall has two doors. Each of the other walls has a single door. The door in the south wall has a sliding copper viewing window.

The southernmost door in the west wall opens to a stairwell (**Area 5**). The door in the south wall opens onto the courtyard outside.

12: Cloakroom

Pegs, spaced a foot apart and five feet above the floor, protrude from the walls of this 10' x 15' closet.

The cloakroom is empty.

13: Banquet Room

This 20' x 40' room is the dining area. A door is located at each end of the south wall. There is a single door in the north wall, and another door in the southern half of the east wall.

The table is set for a party of twelve, although there is no one else in the room. The tablecloth, silverware, dishes, and napkins all bear the same seal: a worm swallowing its tail, encircling a 'K.'

The crest is Kassaka's crest.

14: Guest Bedroom

A delicately carved bedroom set, complete with a dresser and canopy, is in this 20' x 15' room. Each piece of furniture has a crest depicting a worm swallowing its tail encircling a 'K.'

This room would have been Lisa's bedroom — if she and Kassaka had married. An ivory-handled, silver comb set (worth 80 gp) is in the chest of drawers. Otherwise, the room is empty.

15: Kitchen

This 15' x 25' room is a kitchen. There are doors in the north, south, and west walls. The area is filled with the marvelous aroma of freshly baked biscuits, hot apple pie, corn, and prime roast beef. The cook is an elderly female orc. She looks up briefly, then returns to tending the fire in the oven.

The cook will not interfere with the party unless she is attacked. Lisa's ghost has asked the cook to prepare a banquet for the party. If the party questions the cook, she waves a broom threateningly and says, "I'm boss in this kitchen, and I've got work to do. Now GET!"

The food is perfectly normal. The Player Characters thoroughly enjoy the meal if they decide to stay and eat.

*Sowmam, Skill 3 Orc**

STR: 8, INT: 10, INS: 11

STA: 13, DEX: 13, APL: 6

HTK: 10 (3D6), AC: 8

AT: 1, DM: 1 HTK

MV: 10", AL: L. Neutral

Armor: leather apron

THACO: 20

*Treat this Character as a thief when using HTK and THACO values.

16: Pantry

This 15' x 15' pantry contains two wine racks (with a total of twelve bottles), sacks of sugar and flour, a small pile of firewood, and bins of beets, carrots, and potatoes. The room seems unnaturally chilly.

The room is magically kept at 35 degrees Fahrenheit. It serves as both pantry and cold room.

17: Orc Guards

Twelve orcs dressed in leather armor guard the courtyard.

Before Kassaka retired for the evening, he went into the courtyard and told the orcs to be extra alert. The orcs were told that, should they fall asleep on guard duty, they would be killed where they slept.

If the party openly approaches the castle, the orcs challenge them and say, "Leave, the master is in an ugly mood."

(12) Orcs

HTK: 3, 4, 6x4, 7x3, 8x3 (1D8), AC: 7

AT: 1, DM: 1D6

MV: 9", AL: L. Evil

INT: average (low)

Size: M

Weapons: short swords

THACO: 16

Village of Normal

The village consists of ten huts, four stores, and a bar. Most of the villagers have fled the valley. All the shops in the village are closed except for the bar.

If the PCs go into the bar, continue reading to the Players:

In the bar, the barkeep is listening to a shepherd complain about the price of mutton. "I'll tell you one thing," the shepherd announces to all within earshot,

"stay outta the woods. There's creatures in there that can eat a lamb in one bite."

Neither the shepherd nor the barkeep know anything about the party's quest.

If the Player Characters ask for details about the dangers of the woods, or if they mention Kassaka, the bartender tells the party the story of how the once-noble

Kassaka became infected with a terrible disease. "Even his fiance couldn't help him. If you ask me, I'd say it's Kassaka who is the cause of the valley's troubles. And that Fez! Who would think a wizard would hole up and hide at a time like this? He's a coward if you ask me."

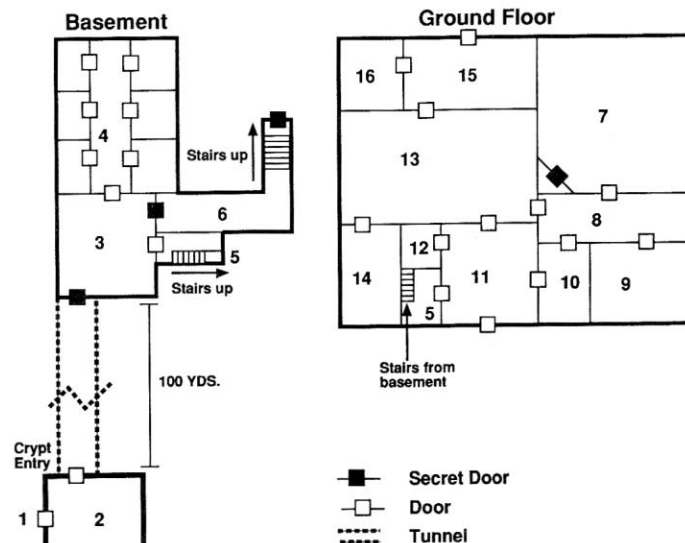
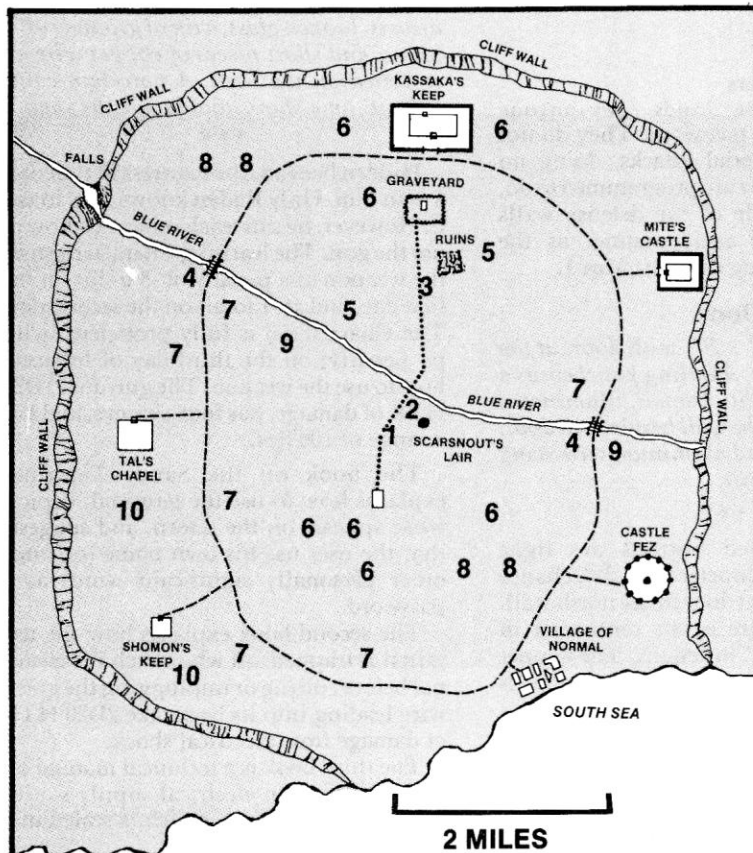

KASSAKA'S KEEP

Mite's Castle

Droids guard the castle of Fez's brother Mite. These droids treat anyone who knows the password as their master. (The current password is 'Mite.')

The party must get past the droids, find the short range teleport machine (in Area 5), and use it to locate Warrior, the black metallic robot.

After installing the teleport machine in his castle, Mite removed the interior doors. Some of the doorways were walled up; others were replaced by electronic doors that open automatically when anyone approaches within two feet of their sensors.

From the outside, the (old) main entrance looks to be a normal door, but the door is actually sealed on the inside. However, the southern door along the west wall is unlocked.

The ceiling panel lights in all rooms are controlled by switches near the doors. (The light switches are indicated by dots on the *Mite's Castle* map.)

NOTE: The text gives modern-day descriptions (i.e., 'refrigerator') of the castle's contents. If Radan isn't present, the GM should give detailed physical descriptions of the modern objects instead (e.g., 'a six-foot-tall white metal box with a silver metal handle; its interior is cold and has chilled food stacked on trays.')

1: The Defective Droid

Mite's castle stands in a clearing of maple trees. The defense wall is twenty feet high; the interior structure is twelve feet high. The building is made of concrete and measures 60' x 60'. There is a twenty-foot-wide iron gate in the west defense wall.

In front of the castle entrance, a two-foot-tall droid is moving around in a circle and muttering: "Mite, Mite, Mite . . ." over and over. Its tractor treads have worn a three-inch-deep trench into the ground.

If Radan inspects the droid, he knows that it fires lasers through the red crystal atop its casing when the droid is working properly. Radan also knows that the droid's technology is beyond his knowledge.

The droid will continue to circle and mutter "Mite, Mite . . ." no matter what the PCs do.

NOTE: Droids inside the castle do not have the red crystals and cannot attack.

2: Guardians of the Castle

There are two doors in the west of the interior concrete structure. A six-foot-high, oak door is centered in the west wall. A six-foot-high door is in the southern part of the wall.

Droids patrol the courtyard, which is just outside the castle. They resemble the

droid that was moving around in circles, only these droids seem to be functioning properly. Each of these droids has a red crystal atop its casing.

The iron gate in the west wall is locked. Whenever a visible party member enters the courtyard, the nearest droid approaches the Character and says, "I am programmed to fire lasers at you unless you leave now! I would not give this warning, but my master has agreed to protect youths like yourself. Please leave immediately, or I will attack."

The droids are programmed to attack anyone standing in the courtyard who does not retreat within ten seconds of receiving the warning. However, the droids will only attack visible intruders who ignore the warning and remain in the courtyard. The droids cannot detect invisible intruders.

The droids are not programmed to respond to attacks from the air. Characters could fly in on Sir Laetumakki, land in front of the southern door, receive their warning, and safely leave the courtyard by entering the building. The center door (the larger of the two doors) does not open.

(10) Droids

HTK: 15x2, 16x2, 17x2, 18x2, 19x2 (4D8), AC: 4

AT: 1, DM: 2D6 (laser)

MV: 16", AL: Neutral

INT: Special

Size: M

THACO: 15

Weapons: lasers

Special: These droids obey anyone who uses the password. They do not respond to aerial attacks, doing no more than they are programmed to do. Droids outside of the defense walls circle in the same manner as the malfunctioning droid in Area 1.

3: The Secret Door

This room is 10' x 20', with doors at the east and west ends. A ceiling panel emits a pleasant white light. A small, illuminated button is set into the wall beside each door. Coils of copper and aluminum wire hang on the southern wall.

The illuminated buttons are light switches. Each Character has a 25% chance of finding the secret door in the north wall.

Each coil of wire is one centimeter in diameter, and 200' in length. The copper wire is worth 350 gp; the aluminum wire is worth 1230 gp.

4: Warning! Warning!

This room is 10' x 10'; there is a door in the north wall. A silver tray floats in midair in the center of the room. There is a human

head with a red beard and red bushy eyebrows on the tray.

For each turn any visible Player Character is in the room, the head shouts warnings like, "Get out of here! Go back! It's a trap!"

The tray will remain in the air; it cannot be brought down by any means.

5: The Transplacer Machine

This 20' x 20' room has two doors in the south wall. The doorway in the west wall is bolted shut with four oak beams. A cot is against the west wall.

*A six-foot-high, three-foot-square metal box is in the northeast corner of the room. A side panel on the box has eight rows of eight lights each. The lights flicker on and off in seemingly random patterns. Wires lead from the box to a narrow shelf fastened to the north wall. A large beaker, a keyboard, and three books labeled **Care and Maintenance of the Sands' Displacer Terminal, How to Effectively Trap any Terminal, and Electricity from Radiation** are on this shelf. The keyboard looks like a normal keyboard except that it has four buttons with up, down, right, and left arrows on them. The **ON/OFF** toggle switch on the keyboard is turned to the **OFF** position. An amber video screen is set into the wall above the keyboard.*

Some miscellaneous tools, pliers, screwdrivers, broken glass, a tin of ground coffee beans, and short pieces of copper wire are scattered on the shelf. A porcelain coffee cup sits on a short stool beside the shelf.

Hidden beneath the mattress of the cot is a stun gun. Only Radan knows how to use it. However, he can teach other PCs how to use the gun. The learning Character(s) uses the weapon at a penalty of -3 to hit on the first day, and at -1 to hit on the second day. The Character(s) is fully proficient (with no penalty) on the third day of learning how to use the weapon. The gun does 1D20 HTK of damage, has four charges, and has a range of 100 feet.

The book on the Sands Terminal explains how to use the terminal, depicts what appears on the screen, and suggests that the user use his own name (or some other personally significant word) as a password.

The second book explains how the terminal is trapped: all who touch the terminal before cutting or unplugging the green wire leading into its back take 2D20 HTK of damage from electrical shock.

The third book is a technical manual on how to set up an electrical supply source from radioactive fuel, which is sealed in a lead box.

When a Character turns on the terminal, the GM should show the Players the *Sands' Transplacer Kit* illustration. Note that the Transplacer Machine functions as a short-range teleport machine exactly as indicated on the display screen. The terminal will not function until a Character enters the correct password. (The current password is *Mite*.)

When the PCs enter the correct password, the screen displays a map of the interior of

Mite's castle. A flashing cursor appears in the upper left of the screen. By moving the cursor with the arrows, Player Characters can look into or enter the room where the cursor is blinking. This can be done by showing the Players the *Mite's Castle Map* and having them specify which direction the cursor is being moved.

This machine is not the deluxe model the salesman in **Area 11** tries to sell to the party. The main flaw with this model is

that the command '-TP' brings every loose item in the room back to **Area 5**. The command 'TU' does not share this flaw.

GM NOTE: Defense droids always respond to the current password, no matter where they are. If the password is changed, the defective droid outside the castle (**Area 1**) begins muttering the new password instead of "Mite, Mite, Mite . . ."

MITE'S CASTLE

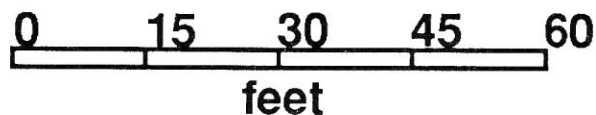

- ◆ Light Switch
- Door

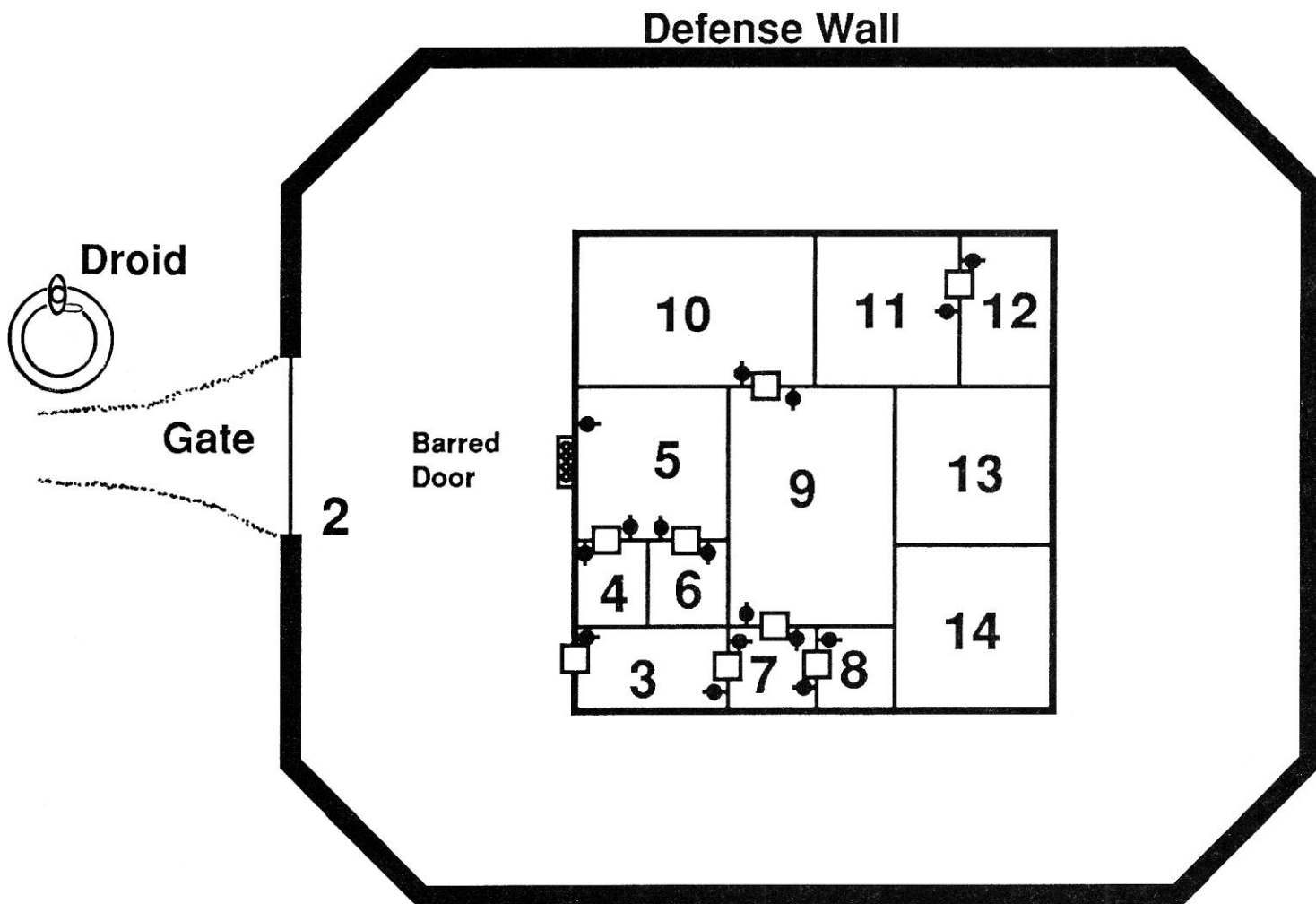

6: The Power Source

In the middle of this 10' x 10' room sits a lead box; it measures three feet on each side. Several large wires run from the sides of the box into the floor. An etching is on the top of the box which reads *Qxfohdu Uhdwru*.

The etching says, *Nuclear Reactor*. Anyone who opens the box takes 5D10 HTK of damage from radiation, and anyone else in the room takes 1D10 HTK of damage. The lid automatically closes the instant whoever opens it is killed. When the lid is reopened, the lights momentarily dim.

7: A Broken Cup

A broken coffee cup lies on the floor of this 10' x 10' room. Otherwise, the room is empty. Doors are in the north, west, and east walls.

A small pool of dried blood and two small tufts of grey fur are on the floor near the cup.

Kassaka found and killed Mite in this room.

8: The Persistent Droid

Pegs protrude from the walls at one-foot intervals throughout this 10'-x-10' room. A droid is in the center of the room.

The droid tries to remove the outer garments of anyone who enters the closet. This droid does not have a crystal on top of its casing and is, therefore, harmless.

(1) Servant Droid

HTK: 10 (2D8), AC: 4

AT: None, DM: None

MV: 12", AL: Neutral

INT: Special

Size: M

THACO: None

Specials: only programmed to remove the outer garments of anyone entering the closet

9: Dining Room

A long table floats in the middle of this 30' x 20' room. At either of the long sides of the table are four floating metal chairs. The chairs have backs but no legs. A large gold chair floats at the head (the northern end) of the table.

One door is located in the northern wall; a single door is in the southern wall.

The chairs cannot be brought down; they will always remain aloft.

Hidden in the table, at the end with the golden chair, are two banks of switches. One bank has four switches, all pointing to the OFF position. The other bank has eight switches, all pointing to the ON position.

The switches in the bank of four have the following functions:

1. Summon the cooking droid from Area 10. The droid asks for the "dinner menu."
2. Teleport the user to Area 5.

3. Produce an electric discharge: This does 1D10 HTK of damage to PCs sitting at chairs where the eight switches in the other bank are ON.

4. Summon three defense droids from the courtyard: They attack everyone who is not seated.

10: A Modern Kitchen

This 20' x 30' room is a modern kitchen. An L-shaped counter runs along the west and north walls. A microwave oven, a food processor, and a coffee pot are on the counter. A refrigerator and freezer stand against the east wall. A droid is busy rolling bread dough at the counter.

The cooking droid cannot attack. It is programmed to prepare any meal the party requests from synthetic and powdered foodstuff stored in the cabinets beneath the counter. If the party eats the droid's cooking, everyone but Heathertoes loves the food; she finds the food bland and tasteless.

A headless, frozen body of a male, red-haired human is in the freezer. The body belongs to the head in Area 4.

(1) Cooking Droid

HTK: 10 (2D8), AC: 4

AT: None, DM: None

MV: 12", AL: Neutral

INT: Special

Size: M

THACO: None

Specials: only programmed for food preparation

11: The Sand's Salesman

This 20' x 20' room is the master bedroom. A door is set into the northern half of the east wall. A digital-display clock is on the nightstand by a double bed. An electric razor and shaving kit sit on the dresser along the northern wall.

A confused-looking human male wearing a wrinkled three-piece suit (similar to Radan's own clothing) sits on the bed.

The dresser contains normal men's clothing. The human male, a Mr. Elmo Goldtree (*Skill 0 Human*), is a sales representative of Sand's Inc. He has been held prisoner in this room for two years.

If the party enters the room, Elmo tries to sell them a Deluxe Transplacer Machine (read the following aloud to the Players): "Now just suppose you had misplaced an item in your home. You could use the Deluxe Transplacer 1000 to find it again. I promise you delivery within one year for a mere one million gold pieces."

12: A Modern Bathroom

This 20' x 10' area is a modern bathroom with a tub, a mirror, and electrical outlets. An electric toothbrush and a razor are on the counter. A droid is folding towels near the bathtub.

The droid takes care of the Sand's Computer salesman in Area 11. It insists on

giving a healing shower to anyone who is wounded; the shower cures 1D8 HTK of damage.

(1) Valet Droid

HTK: 4 (1D8), AC: 4

AT: None, DM: None

MV: 10", AL: Neutral

INT: Special

Size: M

THACO: None

Weapons: None

Specials: programmed to perform personal services for anyone who says the current password

13: Warrior

A black metallic humanoid stands in this 20' x 20' room. Six oak doors are piled against the east wall.

When the party enters the room, read the following to the Players:

The robot speaks, "I am Warrior, servant of Fez the Wizard. I answer only to he or she who wears Fez's robe and carries Fez's crystal ball."

GM NOTE: When the PCs give the required items (the robe and the globe) to Warrior, read the following to the Players:

The robot takes the robe and globe and says it will be right back. It fades from view, then returns in a matter of seconds. "Fez and I have had a long talk. He is weakened from his long isolation. Fulfill the prophecies. If you do not, Scarsnout will bring a great evil to this valley. If Fez is not released quickly, he will surely go mad. I go now to guard Fez."

At that, the robot fades from view.

The doors were removed when Mite remodeled his castle.

The party needs the robe (found in Tal's Chapel) and the globe (found in Shomon's Keep) in order to obtain Warrior's help. If they don't have these items, Warrior says, "I can do nothing for you until you bring the required items." Warrior does not speak with the party again until the PCs return with Fez's items.

14: Treasury

Three large chests are on the floor of this 20' x 20' room. Several loops of plastic-coated wire hang on a peg on the south wall.

All of the chests are trapped. Any Character who tries to open a chest without first removing the trap sustains 1D12 HTK of damage from electrical shock.

The first chest cannot be opened magically, even after the trap has been removed. It sustains 55 HTK of damage before it can be opened by force. This chest contains only 100 cp. The second and third chests can be opened by any means, however. The second chest contains 100 gems worth 100 gp each; the third chest contains 15,000 copper cubes.

The plastic-coated gold wire is 100' long and is worth 3000 gp.

SAND'S TRANSPACER

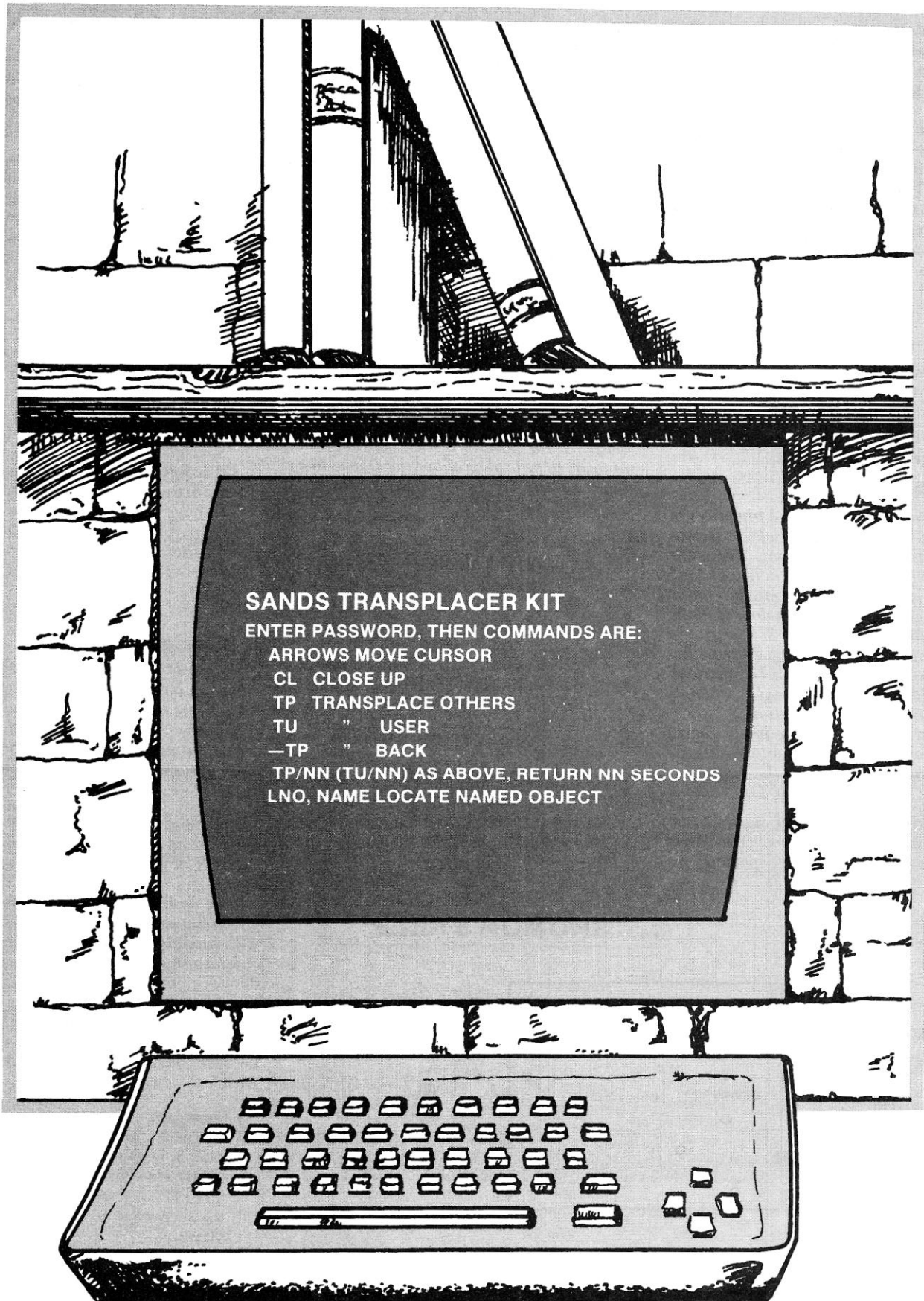

Shomon's Keep

Shomon's Keep is in a clearing located at eight o'clock ("20 bells") on the *Wizard's Vale* map. The party's objectives at Shomon's Keep are to find Fez's crystal ball in **Area 7**, and then to solve a riddle to escape that room.

Shomon was a druid. His pride and joy was his courtyard, where he grew a variety of trees. The roof above the courtyard arboretum (**Area 6**) is illusory; the illusion was cast by Ekardnam (a friend Fez met in happier times at Peking University). Player Characters who attempt to walk on this portion of the rooftop will fall into the courtyard and land in the treetops. Each Character must then save against his/her DEX or fall to the ground and sustain 1D8 HTK of damage.

NOTE: **Area 7** cannot be entered or exited by use of the Dimension Door spell.

When the party approaches the keep, turn to **Area 1** of this section.

1: Any Rations?

There are birch, aspen, and pine trees in this forest. In a clearing ahead is a rectangular keep made of laid stone. The walls are twenty-five feet tall and notched along the top. The base of the keep measures 80' x 60'. An eight-foot-tall oaken door is in the center of the north wall.

Upon entering the clearing, a parrot flies from a treetop and lands on Heathertoos' left shoulder. The parrot says, "Squawk, squawk, any rations, any rations?"

The keep is sealed by a finely carved oaken door; pitiful moans and cries issue forth from the other side of the keep.

If the parrot is given food, it says, "Follow the tears, follow the tears." The parrot flies away immediately after speaking the

second time if it is fed, or thirty seconds after the first time it speaks if it is not fed. The parrot's verse is a clue that the party should follow the weeping willows in the courtyard arboretum (**Area 6**).

The north entry to the keep is bolted from within.

If the party enters the keep through the north door, refer to **Area 3**.

If the party circles around the building, continue with **Area 2**.

2: Dream Monster

South of the keep wall, near the edge of the clearing, is a pit. The mouth of the pit is fifteen feet wide. A feminine voice cries for help from that direction.

If the party goes over to the pit, read the following to the Players:

The pit is twenty feet deep. There are several large rocks in the pit's loose dirt walls. At the bottom is Lisa; her left arm appears to be broken above the elbow. She looks up, and, trying to hold back her tears, she pleads for help.

If Shane investigates the area for tracks, he finds no human tracks leading into the pit. Also, he notices a faintly worn path leading to the middle of the keep's south wall.

A dream monster dwells in the pit. It reads the minds of the party members and try to lure them within its grasp. Knowing that the party is fond of Lisa, the monster disguises itself in her form.

Damage from the dream monster seems to originate from natural occurrences; PCs who come in contact with the dream monster sustain 1D6 HTK of damage from what seems to be falling rock. In such cases, the "falling rock" hits the victim's head or

chest area, and each Player whose Character is affected must roll 1D20 to see if his/her Character remains conscious. (This is actually a "save vs. Poison" to determine if the monster's poison puts the Character to sleep. Characters who fail the save remain asleep for one hour.)

If the Players get suspicious and say that their Characters believe that this is an illusion, then the PC with the highest INS should "save against his/her INS". On a successful roll, the illusion fades and the party sees the actual form of the dream monster: a two-foot-tall gray spider.

(1) Dream Monster

HTK: 3 (1D8), AC: 10

AT: 1 (touch), DM: 1D6 (bite) + save vs. Poison

MV: 1", AL: Neutral

INT: Very

THACO: 20

Specials: Dream monsters can cast illusions. They also have ESP and can read their intended victims' minds. Damage from them seems to be caused by natural occurrences. Their bite is an anesthetic poison; the victim must save vs. Poison or fall asleep for one hour.

3: Weretigers

The foyer is 20' x 20'. The west and north doors are barred with six-inch-thick pine bars. There is a door in the east wall which is unlocked. Paintings on all four walls depict animals and humans working and playing together in pastoral settings.

The north door of Shomon's Keep is bolted from within. The door can sustain 12 HTK of damage before it is opened by force.

Two weretigers are in the foyer. They guard Shomon's Keep and attack anyone who forcibly enters the keep. If the party enters the foyer without breaking down the door (i.e., by Dimension Door), the weretigers demand that the intruders leave immediately through the north door.

The weretigers bolted the west door because they despise the troll who lives in **Area 5**.

(2) Weretigers

HTK: 25, 24 (6D8+2), AC: 3

AT: 3, DM: 1D4/1D4/1D12 (claw/claw/bite)

MV: 12", AL: N. Good

INT: average

Size: L

THACO: 13

Specials: Can only be damaged by magical or silver weapons

SHOMON'S KEEP

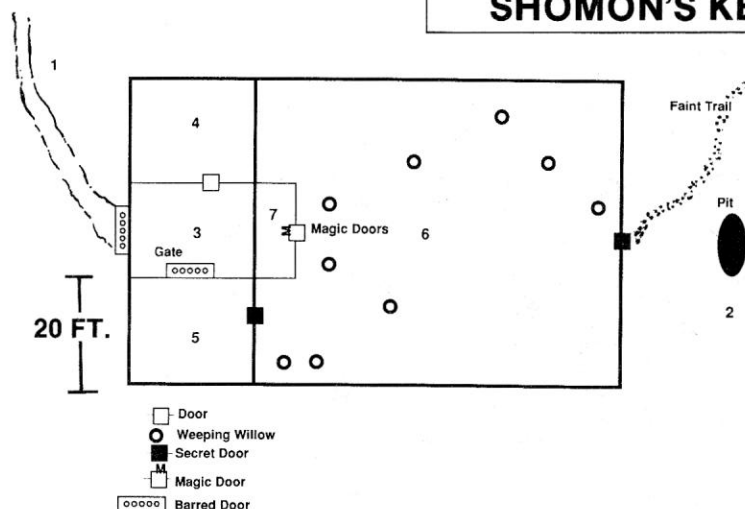

4: Rabbit Stew

This room is a 20' x 20' kitchen. Onions, garlic, and several bunches of herbs hang from pegs along the north wall. A large black kettle hangs in the fireplace. The aroma of rabbit stew fills the room.

Three yellow cats are sleeping on a small rug in front of the fireplace.

There is nothing in the kitchen that the party needs, other than perhaps a bowl of hot rabbit stew from the kettle.

(3) Cats

HTK: 2 (1D8), AC: 7
AT: 1, DM: 1 HTK
MV: 15", AL: Neutral
INT: animal
Size: S
THACO: 20
Specials: will flee if attacked

5: Troll's Bribe

A nine-foot-tall humanoid is in this 30' x 30' room. His hide is composed of a nauseating, green, moss-like substance. Gray, writhing, hair-like growths sprout from his head. He is sitting on a wooden chest in the northwest corner of the room, gnawing on a two-foot-long bone.

If the party attacks this troll or stays in the room for three rounds without offering him a bribe, he attacks.

The chest is magical and opens to the phrase: "Follow the tears." However, the lock may be picked. The lock is trapped with three darts (each dart does 1D4 HTK of damage). The chest contains three sacks which hold (respectively) 230 sp, 120 cp, and 342 gp. A scrap of parchment inside the sack of copper coins reads:

*"In the keep of wise Shomon,
follow the path of tears.
Or prey you shall become,
food for huge owlbears."*

The secret door in the south wall leads to the courtyard (Area 6).

Troll

HTK: 27 (6D8+6), AC: 4
AT: 3, DM: 1D4+4/1D4+4/2D6
(claw/claw/bite)
MV: 12", AL: Neutral
INT: low
Size: L
THACO: 13
Special: Regenerates 3 HTK per round

6: Courtyard Arboretum

A dense forest of closely-planted trees is beyond the doorway. The trees are white pine, birch, aspen, weeping willows, elm, maple, and walnut. Sunlight shines through the leaves above. Songbirds and sparrows flutter overhead and chatter continuously.

A metallic barrel with a florescent orange stripe around it sits in the lower right corner of the arboretum. A gas mask and two pairs of rubber gloves are on top of the barrel. A sign on top of the barrel reads, **USE SPARINGLY!**

Sir Laetuumakki finds the trees too dense for flight. The party cannot see more than ten feet into the forest because the forest is so dense.

NOTE: The party should find their way to Area 7 by following the path of weeping willows. Locations of weeping willows are indicated on the Shomon's Keep map by asterisks ("*"). If the Players don't think of doing this, have the parrot from Area 1 reappear.

Owlbears roam the arboretum. They are allergic to weeping willow leaves. So, if the party follows the path of weeping willows, they do not encounter the owlbears. Those leaving the path encounter 1D6 owlbears.

There is fertilizer and a glass measuring cup inside the barrel. The fertilizer causes double growth in plants when one cup for every 100 square feet is used. Concentrations of more than one cup for 100 square feet are poisonous to plant life. The fertilizer is poisonous to humans if ingested.

(1D6) Owlbears

HTK: 20x2, 21, 23x2, 25 (5D8+2), AC: 5
AT: 3, DM: 1D6/1D6/1D6
(claw/claw/bite)
MV: 12", AL: Neutral
INT: low
Size: L
THACO: 15
Special: Allergic to weeping willow leaves.

7: Exit Room

This 10' x 20' room is lit with a soft red glow. The source of the light is a sphere, one foot in diameter, which sits on a cushion on a small table against the west wall. An open unabridged dictionary sits on an oaken pedestal in the middle of the room.

A small bookcase is set into the stone of the east wall. A large, well-worn, leather chair is next to the bookcase.

The globe is Fez's crystal ball. When anyone enters the room, the door shuts automatically. To open the door, Heather-toes' dagger, which is marked "NHB" (which translates to "KEY"), must be placed into the dagger-shaped depression in the bookcase behind the chess book. A riddle containing a message explaining how to open the magic door is in the book entitled *Exits*. A second dagger (key), also marked "NHB", is taped to the underside of the leather chair.

Presently, the dictionary is open to a D-page, which includes the words "Duke, Dune, Dungeon, Dunk, and Duo."

The bookcase contains 17 titles: *Animals of the World, Berries, Chess, Crystal Balls, Exits, Fairies, Germination of Seeds, Herbs, Insects, Jackals, Lammasu, No . . . , Spells, Swords, Tigers, War of the Wolves, and Zebras*. Dagger-shaped depressions are in the stone wall behind each book.

The contents of the books are as follows:

Crystal Balls explains different types of crystal balls. It says that those crystal balls which emit a soft red glow can only be controlled by their rightful owners.

Exits contains nothing but this poem:

*In a book of words
lingers a secret code,
by Shomon written
of alpha-beta mode.
In the wall's depressions,
you must learn why.
Place the key correctly,
or sparks will fly.*

*But where should you put it,
where does it go?
In five words it's given,
the answer lies below.
In each that follows,
the answer is shown,
Kex, Fistulous, Behight,
Chert, and Bone.*

Lammasu tells of the abilities of lammasu. They can Know Alignment, turn undead, Turn Invisible (this includes the rider), Cure Wounds, Bless, and cast Dimension Door spells. In the back of the book (in Shomon's writing) is an additional note: "True, but lammasu acquire these abilities only as they gain experience."

No . . . (Only the first two letters of the title are legible.) The title page shows the book's title as *No Exits*. The book's contents are of no interest to the party.

All other books: The contents of the remainder of the books are as indicated by their titles.

The dictionary pages containing the five words given in the last line of the poem contain (respectively) the words:

Kex: kettle, kex, key, keyhole, keynote
Fistulous: fist, fistulous, fits, firch, fitful
Behight: behavior, behead, behight, behind, behold
Chert: cheroot, cherry, chert, chess, chestnut
Bone: bone, book, bookwork, boom, boon

The riddle instructs the PCs to look in the dictionary at the words which follow the five words given in the last line of the poem. Thus, the hidden message in the riddle is: "key fits behind chess book."

To open the door, the "NHB" dagger must be placed in the depression behind the chess book. If the dagger is placed in an incorrect depression, then sparks fly; the Character holding the dagger sustains 1D12 HTK of damage.

Tal's Chapel

Tal's Chapel is at the 9 o'clock point on the Wizard's Vale map. The party's objective here is to get Fez's robe. The robe is in the cloakroom (Area 5).

1: The Ghost of Tal

The forest near the path consists of birch and pine. Through the trees to the west is a chapel in a small clearing. A ghost, dressed in robes and carrying a staff and a holy book, appears.

The ghost speaks, "In life, I controlled undead. It is fitting that, as a ghost, I protect my chapel. No one may enter my chapel until Kassaka has been killed. Leave!"

The ghost fades from view if the party tells it that Kassaka is dead. The ghost cannot be turned, even by Sol's wand.

If Sol or Sir Laetaumakki tries to turn the ghost, it laughs at them.

If the party attacks or tries to bypass the ghost, it attacks.

(1) Ghost of Tal, Skill 9 Fighter

STR: 14, INT: 18, INS: 16

STA: 14, DEX: 14, APL: 12

HTK: 47 (9D10), AC: -6

AT: 1, DM: 1D6 (staff)

MV: 12", AL: Neutral (see NOTE)

THACO: 12

Weapon Proficiencies: N/A

Weapons: Staff

Specials: Can only be damaged by magical weapons; cannot be turned

NOTE: Since Tal was Neutral Good during his life, his ghost only attacks as a fighter. Tal's ghost has none of the special attacks which ghosts normally have. Also, Characters who are killed by his ghost may be Raised or Resurrected.

2: Main Gate

The chapel is 70' x 90'. A 30' x 20' courtyard is behind a wrought-iron gate located in the center of the northern wall. The gate is rusted shut.

The only entry to the chapel is the rusted gate. Pouring oil onto the hinges makes it easier to open the gate by force.

3: The Courtyard

Weeds grow between the flagstones of this 30' x 20' courtyard. Across from the gate, a door leads into the chapel.

A stone bench sits along the east wall of the courtyard. A lead statue of Loki stands on a pedestal in the center of the west wall. Two sparrows chatter near the courtyard; they have made a nest on the statue's head.

4: Foyer

The foyer is a 20' x 10' room with three exits. To the east, an open doorway leads to a 10' x 10' room with hooks on the walls. There is a door in the south wall of the foyer. Dual carved oaken doors are centered in the west wall. Above the doors is a plaque which reads, "Chapel of the God With No Name."

The room to the east of the foyer is the coat room (Area 5), where Fez's cloak is.

5: Fez's Cloak

Five cloaks and three leather helmets hang on pegs in this 10' x 10' room. Two cloaks are blue, two are purple, and one is brown. The three helmets look well-worn.

The party needs the brown cloak, which has a label on the inside which says 'FEZ.' The other cloaks and the helmets are normal. Fez's cloak gives its wearer an AC of 1.

6: The Chapel

The doors open to a 40' x 50' chapel. The twin doors are in the back of the chapel, near the pews. A wooden door is set into the north wall of the room, behind the pew area.

A railing partitions the pew area from the altar. The altar is covered with green silk; a leather-bound book lies atop the altar. Four insubstantial human-like forms are next to the altar.

The forms guarding the altar are spectres. They only attack if someone enters the altar area. Sol can use his wand to turn the spectres.

The leather-bound book is a non-magical prayer book, which is of no help to the party.

(4) Spectres

HTK: 45, 47, 51, 53 (7D8+3), AC: 2

AT: 1, DM: 1D8 + energy drain

MV: 15"/30", AL: L. Evil

INT: high

Size: M

THACO: 13

Specials: Can only be damaged by magical weapons; energy drain: two skill levels per successful attack.

7: Fez's Letter

Three books rest on top of a table in this 20' x 30' cleric's study. Three vestments hang on pegs on the wall. A rolling chair is next to a roll top desk along the west wall.

A fuschia-and-canary-yellow rug, rolled up and tied with twine, stands on end in the northwest corner of the room. A tag is attached to the rug. The tag reads,

"Removal of this tag is forbidden by the laws of the city under penalty of fines or imprisonment."

The books are non-magical prayer books and are of no use to the party.

The locked desk contains a bill for four lambs, a bill for six casks of altar wine, and a letter from Fez to Tal. The letter reads:

Dear Brother,

I know you do not believe in the prophesies, but it will do no harm if you keep my cloak anyway. Please place it in an obvious place so it can be easily found.

(signed) Fez.

A second letter, written in a different hand and unsigned, reads:

Dear Slyham,

Three times you have promised to supply a rug for my chapel. Three times you have failed. First you sent a rug of inferior quality. In less than a month it wore through. The second rug was too short. The third rug arrived today — in glowing colors!

I assure you that you will send me a light brown rug of your best weave, measuring exactly 8' x 50'. If I do not receive such a rug by the summer solstice, then I will put this curse upon your business:

Daily a thousand pigeons from the Sphinx Monument will seek out your marketplace displays to use for their toilet.

8: Hallway

This 10' x 50' hallway has three doors. Two of the doors are in the north wall — one at either end of the hall. The third door is in the center of the south wall.

A well-worn, light-brown carpet runs the length of the hallway. At three different spots, the rug is so worn that it has been tacked to the floor.

There is nothing of interest here.

9: Tal's Bedroom

The large bed in this 40' x 25' bedroom has a hand-carved wood headboard. The carvings depict minor gods at play. A seaman's chest sits at the foot of the bed. A wooden dresser stands against the west wall. A small matching table with two chairs is in the eastern part of the room.

If anyone enters the room, five wraiths attack with surprise (Sol can turn them with his wand).

The locked chest contains four gems (worth 1,000 gp each) and four sets of cleric's robes (worth 300 gp/set), one for each season.

(5) *Wraiths*

HTK: 22, 24, 26, 30, 31 (5D8+3), *AC:* 4
AT: 1, *DM:* 1D6+1 + skill drain
MV: 12"/24", *AL:* L. Evil
INT: very
Size: M
THACO: 15
Specials: Can only be damaged by silver or magical weapons; energy drain: one skill level per successful attack.

10: *Green Acid*

Two perfume bottles lie on the marble floor by a glassy-smooth, stone tub in this 10' x 10' bathroom. The tub contains an odorless, green, opaque fluid.

This is where Tal put undead that showed signs of breaking his control. The green fluid is an acid which automatically dissolves everything it touches, except the glassy stone which lines the tub.

11: *The Bridge Game*

The door to this room is locked.

There is a Wizard Lock on this door. If anyone tries to open the door by force, a Magic Mouth appears on the door and says: "Go away! We are four liches and we don't want to be disturbed." The Magic Mouth then disappears, and four flashes of lightning burn a diamond-shaped figure into the wood of the door.
Four liches are playing bridge in Tal's

kitchen (which is 45' x 20'). If the party disturbs the liches they attack, using progressively stronger spells each time:
1) Wall of Water (DM: 4D6+4)
2) Wall of Ice (DM: 5D6+5)
3) Wall of Fire (DM: 6D6+6), and
4) Wall of Stone (DM: 8D8+8).

(4) *Liches*

HTK: 47, 55, 59, 51 (12D8), *AC:* -2
AT: 1, *DM:* by spell
MV: 6", *AL:* Neutral (Evil)
INT: supra-genius
Size: M
THACO: 9
Special: Only magical weapons damage these liches (Sol's wand does not turn liches); they know all magic spells up to skill 6

TAL'S CHAPEL

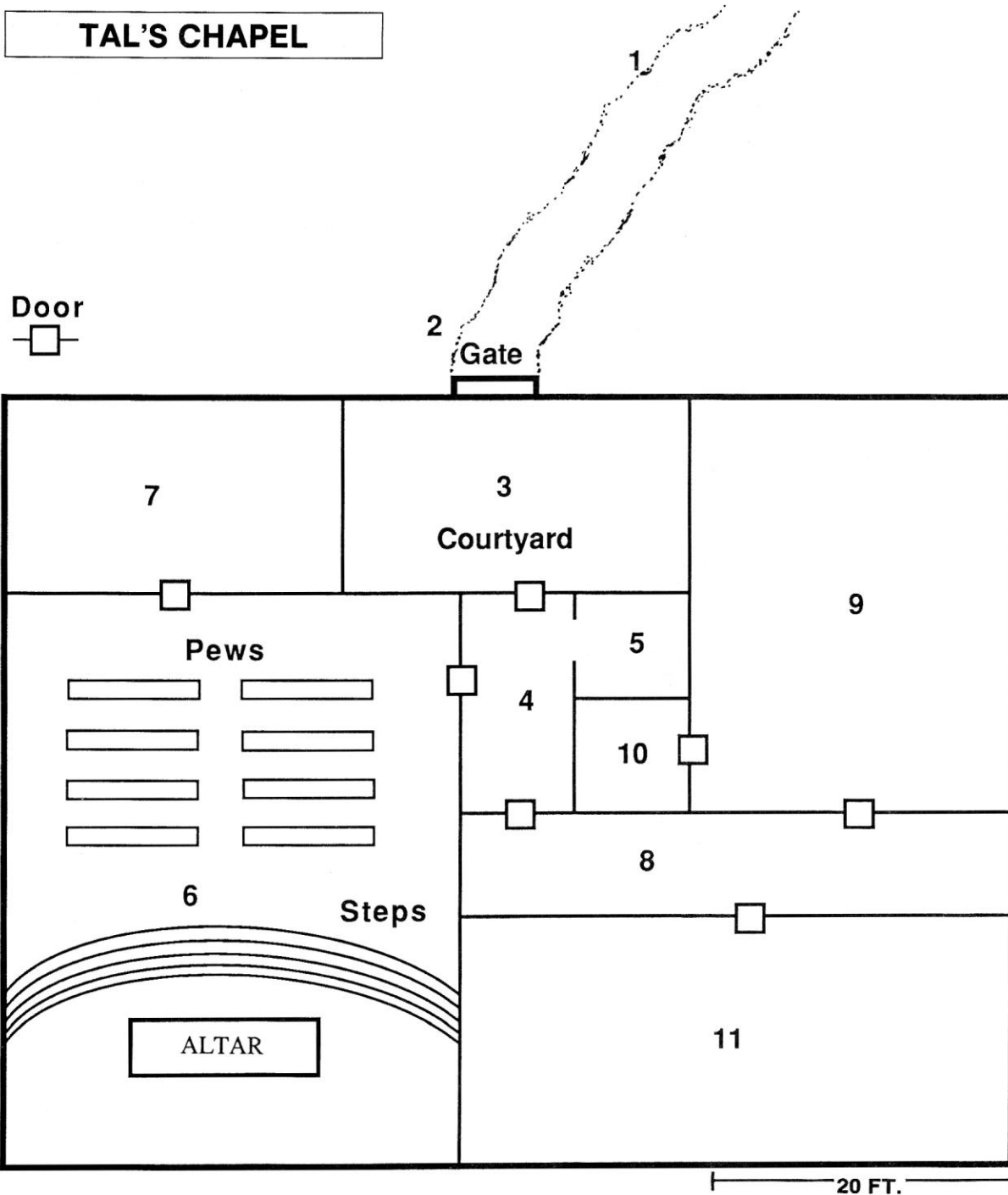

Castle Fez

The perimeter of Fez's castle is a circle of eleven defense towers linked by stone defense walls, which are eighteen feet high. At the center of the circle is a twelfth tower. Each tower is twenty-four feet high and twenty feet in diameter. The defense walls and tower tops are crenelated.

Fez makes his home in the twelfth tower (Central Tower).

The area surrounding Fez's castle:

* The walls of Tower 6 have a spell cast upon them which negates the Dimension Door spell.

* Squirrel tracks lead up and down from a window in the second level of Tower 7. The tracks lead to a nest in the forest nearby. In the nest is a perfect blue diamond, one of the items the party wants. (See **Area 29**.)

* A beggar sits in front of the castle gate.

1: The Beggar's Poem

The local forest consists of oak and walnut trees. The castle is the largest castle in the Valley of Trees. Eleven towers, arranged in a circle and linked together by defense walls, complete the outside wall of the castle. The keystone above the main

entrance bears the word 'FEZ'. The entry gate is closed and locked.

A beggar with a wooden bowl sits beside the gate. He holds a hand-carved lyre and asks for alms.

Give the Players a copy of the Castle Fez map and drawing at this time.

If the party gives the beggar some coins, he sings the following song:

*At eleven points the hands meet,
as the short goes once around.*

*Twelve towers the Wizard built,
and left there things he'd found.*

*At the center hidden prophecies
explaining partly why.*

*At the beginning he put his ring,
protected by an evil eye.*

*At the first crossing he left a staff,
with an ogre chained nearby.*

*At the third a dangerous trap,
with a Wizard's Sword on high.*

*At the seventh crossing he hid a gem,
a gem fit for a queen.*

*In focus strongly — holders all,
in case the gods were mean.*

*Fulfill ye all the prophecies,
not just two or three.*

Then dare free Fez beyond the door where the dagger is the key.

When the beggar finishes his song, he says, *The prophecies forbid me to aid you further. However, I bring you news of a gift from the God with no Name. Each of you will increase in skill.*

GM NOTE: Hereafter, use the PCs' statistics given in brackets [] on the Player Characters' page. Ask Sol (now 3/3/1) and Delyn (now 4/2/1) to give you their list of researched spells. Also, Sir Laetuamakki now has four Cure Light Wounds spells.

Robbe's poem refers to the eleven defense towers as the points where the hands meet (or pass) on a clock. The 'beginning' refers to the North Tower (Tower 0). The 'first crossing' refers to Tower 1, etc. The phrase 'in focus strongly' refers to the television-like screens in Fez's study. The final phrase, 'the door where the dagger is the key,' refers to the keystone over the door of **Area 10** in the basement of the Central Tower.

The prophecies are hidden in Fez's study, **Area 6** of the Central Tower. They explain what the Player Characters must do to complete their quest.

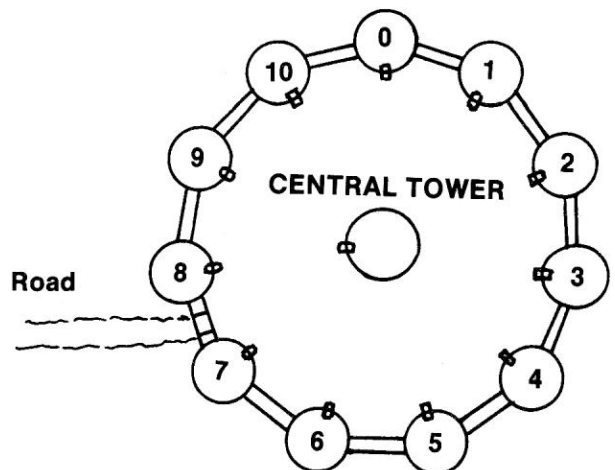
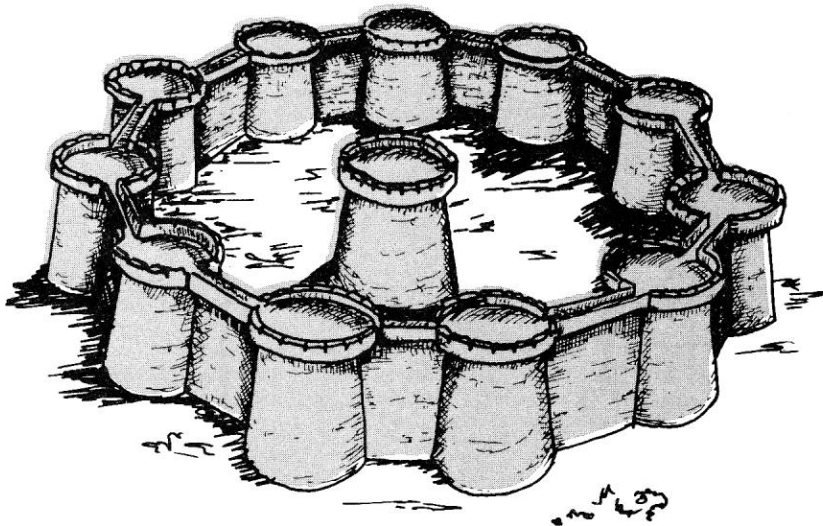

CASTLE FEZ

Central Tower: Fez's Home

Fez is in **Area 10** in the basement of the Central Tower. While Fez sleeps, the robot Warrior watches over him. Warrior will not allow the party to disturb Fez until they have found and fulfilled all the prophecies. The prophecies are hidden in the rolltop desk in Fez's study (**Area 6**).

In the Central Tower, the party will experience a feeling of *deja-vu*: it was here that Lisa and the bard trained them for their mission.

2: Lammasu Guardians

The entryway is 20' x 10'. Two stone statues of lammasu guard the hall. There is a door in the center of the east wall, directly across from the outside entrance. Stairs lead upwards from an open doorway in the south wall. Stairs lead down through the open doorway in the north wall.

The stairwell in the south leads up to **Area 5** on the second floor. The northern stairwell leads to **Area 9** in the basement.

The statues attacks those of Evil alignment who enter the tower.

(2) Lammasu Statues

HTK: 36, 42 (7D8+7), AC: 3

AT: 2, DM: 1D8x2 (claws)

MV: 13"/100", AL: L. Good

INT: Genius

Size: L

THACO: 13

Special: will animate and attack Evil beings

3: Deja-vu

This dining room is 20' x 20'. There are doors in the east and west walls. The table has ten matching chairs.

The closed cupboard contains stoneware place settings and a silverware chest with space for twelve place settings. One fork is missing from the set.

The PCs remember having eaten in this room while they were training for their mission.

4: Candy

This 10' x 20' kitchen has a sink, a cupboard, and a wood-burning stove.

The crock usually contains pieces of delicious hard candy.

Everything is the same as it was when the party was last here. The PCs remember having been in this room before.

5: Diplomas

This five-foot-wide hallway runs north-south for forty feet. A stairway leads down from the open doorway in the southern end of the west wall. Two doors are set into the west wall. A single doorway is located in the center of the east wall.

Three diplomas hang on the east wall:

*PhD. Ancient Languages,
University of Illinois, 2009.*

*PhD. Heretics,
Notre Dame, France, 1531.*

*PhD. Serpent Studies,
Peking University, 1032.*

6: Hidden Prophecies

This room is a study. It is ten feet wide along the east wall and tapers to five feet wide at the west wall; it is ten feet long from east to west.

Four of what look like picture frames with dark-green glass screens hang on the walls. Against the north wall is a maple rolltop desk. The top shelf is slightly warped. A skull sits on top of the desk.

The following items are in this room:

Skull

The skull on the rolltop desk causes 1D4 HTK of damage to whoever touches it the first seven times. After the seventh time, the skull is harmless.

Rolltop Desk

The rolltop desk is unlocked. It contains: paper clips, sheets of parchment, a used ticket stub to the 2008 University of Illinois vs. University of Oregon Rose Bowl game, a small box of matches, a gold pocket-watch, a picture of a woman (signed, "All my love, Mertia"), two writing quills, and a bottle of black ink.

An engraving on the back of the watch reads, "A picture is worth a thousand words." Four nickel-plated disks, 4 mm high and 1 cm in diameter, are set into the back of the watch. If Radan sees the disks, he realizes they are batteries. The batteries fit into the television screens (picture frames) hanging in the study.

The top shelf of the desk can be lifted up. Hidden in the back of the rolltop section are two bottles of fine cognac and a letter. When the PCs find the letter, show Players the sidebar entitled *The Prophecies*.

Picture Frames/Screens

Each of the four frames has a hole in its base under a sliding piece of brass. Radan recognizes these "frames" as television screens. Radan knows that the devices should work once batteries are inserted into the brass-covered holes. (The batteries in the watch fit the screens.)

When the batteries are inserted, the pictures shows whoever presently possesses Fez's four items. So, after the party gets one (or more) of the items, whoever/whatever has the item appears in the corresponding picture. At the start, the pictures show: a squirrel (has the gem), an ogre (has the staff), an eye sphere (has the ring), and a blank picture (even though there is a cat near the sword, no one has possession of the sword).

7: Storeroom

This semi-circular room is twenty-five feet wide at the west wall and ten feet long from east to west.

This section of the tower is a storeroom. There are over a hundred different types of clocks on one shelf. All the clocks are running, and all of them show exactly the same time! Two shelves contain many bottles and sacks. Each bottle and sack is carefully labeled.

No two clocks are alike. Each one is kept at the correct time by magical means.

The labeled bottles and sacks contain spell components. Magic-users recognize the components for every spell they know. In addition, there are four potions: Fly, See Invisible, Haste, and Slow. Each potion has 1D4 uses remaining.

8: Bedroom

A chest of drawers and a small night stand are against the outer wall of this bedroom. There is no bedding on the bed, nor is there anything on the night stand.

The chest of drawers is empty. Fez's servants took his garments to the basement room, where he now sleeps.

There is nothing here of any use.

9: A Riddle

A basement floor area is divided into two semi-circles by a thirty-foot east-west wall. A wine rack with twenty wine bottles stands against the northern wall. A wheelbarrow and two twenty-pound sacks of potatoes are piled against the windlass of a well in the southern part of the room.

A door with a circular archway is in the center of the east-west wall. The keystone above the door depicts a relief of a dagger. Directly in front of this door is a rotund, golden statue, seated cross-legged.

The statue rises, bows, and says, "I am Secant, Servant of Fez. I know 'nothing,' and I know a riddle: 'What has two wings, fifteen eyes, and eighteen legs?'"

GM NOTE: Adjust the above riddle to the number of PCs in your group.

OBJECTIVES AT CASTLE FEZ

The six things the party must do before waking Fez are:

- 1) Obtain Fez's ring in Tower 0.
- 2) Drink the fluid of the evil eye that guards the ring. (The fluid restores life to those the eye kills. Note that the lips of each dead Character must be moistened with the fluid to initially revive him/her before the Character can actually drink.)
- 3) Overcome the ogre in Tower 1 to obtain Fez's staff.
- 4) Avoid the "gambling hall" trap in Tower 3 and find Fez's sword hidden on top of that tower.
- 5) Discover that a squirrel has taken the blue diamond from Tower 7 and retrieve the diamond from the squirrel's nest in the nearby forest.
- 6) Answer the golden buddha's riddle. The buddha guards the basement of the Central Tower (**Area 9**).

The answer to the riddle is "Us" or "Our Party." The buddha will not let the party pass until they answer his riddle. When the correct answer is given, the buddha gives the party a small, unlocked, silver box.

Inside the unlocked chest is an onyx dog.

(1) *Secant, Gold Buddha Statue,*
Skill 10 Monk

STR: 17 (+1, +1), INT: 14, INS: 18

STA: 16 (+2), DEX: 13, APL: 10

HTK: 37 (10D8), AC: -2

MV: 14", AL: L. Neutral

AT: 3, DM: 1D8x3

THACO: 10

Weapon Proficiencies: N/A

Weapons: None

Special: Immune to mind-control spells; only has a 16% chance of being surprised; Special Ability H; Thief Abilities: Open Locks: 67%, Find/Remove Traps: 65%, Move Silently: 78%, Hide in Shadows: 63%, Hear Noise: 30%, Climb Walls: 99%

Treasure: onyx dog

Onyx Dog

Once a week, the onyx dog will seek and find any item it is commanded to find. The dog is one-inch long and one-half inch high. Note that the dog does not change size while seeking out an item. Thus, the party has to carry it up and down stairs and the like. The dog always chooses the shortest route possible from its current location to the item being sought.

10: The Sleeping Wizard

The robot, Warrior, stands guard between the door and a man sleeping on a cot. Warrior asks, "Have you done all that the prophecies of Aaron and Sourbeard foretold? Have they been fulfilled?"

If the party has fulfilled all the prophecies, (i.e., collected Fez's four items, answered the golden statue's riddle, and drunk the fluid of the Evil Eye), turn to the section entitled, *Battle with Scarsnout*.

If the prophecies are not fulfilled, Warrior says, "I was instructed to kill if Fez was disturbed before what the prophets foretold came to pass. However, the Masters who made me gave me wisdom. I will not kill all of you." At that, the party is teleported to Fez's study, **Area 6**. A random party member must then save vs. Death Magic or die.

THE PROPHECIES

Dear Fez, Wizard of the Valley of Trees,
A computer search of the library's records reveals the following references to a "band rising from the dead."

A band shall rise from the dead in a valley of trees. They shall avenge she who restored them. The gods shall grant unto her two wishes.

The band shall search for a warrior, a servant of a wizard. They shall give this servant his master's robe and sphere. One who is to remain nameless will aid their quest.

GM NOTE: The Masters are explained in detail in *Fez V: Wizard's Betrayal*.

Tower 0: The Evil Eye

Tower 0 has only one room. The keystone above the entry from the courtyard depicts a ring. The entry door is locked.

11: The Summoning Gong

A four-foot-tall brass gong supported by an oak stand is in the center of this dusty circular room. A wooden hammer hangs next to it. An etching on the gong depicts a floating eye with two long tentacles; a ring is fastened to the eye by a small chain.

Striking the gong with the hammer summons a Galafaxian Warsting (also known as "the evil eye"). When this occurs, the eye materializes and attacks whoever rang the gong. That Character dies immediately. Note that the eye must kill at least one party member so that the prophecy about "drinking the fluid of the evil eye" can take place.

The eye remains in the room and fights until it is killed. When the eye is killed, its fluid spills to the floor.

The eye is two feet in diameter, and its tentacles are eight feet in length. A silver ring is attached to a small silver chain supported by the monster's tentacles.

Galafaxian Warsting (Evil Eye)

HTK: 35 (8D8), AC: 4

AT: 2 (same opponent only),

DM: 1D8x2 (tentacles) + save vs. Death Magic

MV: 8", AL: Neutral

INT: low

Size: M

THACO: 12

Treasure: silver ring on chain (see *Fez's Silver Ring*)

Specials: When the eye is killed, it releases a pool of fluid. Surviving Characters see what appears to be bright specks of white light (life forces) floating in the fluid; there is one life force for each party member the eye killed. Giving a sip of this fluid to those the eye kills restores the Character(s) to life. (Each dead Character revives as soon as the fluid touches his/her lips, enabling that Character to drink the fluid.) Others who drink or taste the fluid are unaffected.

*Three times others will aid the quest, but only in verse, not by deeds. Only the band from the dead can kill the scarred dragon.
Aaron, Rabbi of the Poor,
Sphinx, Land Anew*

They shall free a great wizard, returning to his servant his robe and sphere as Aaron has forseen. In addition, they shall gather the wizard's sword, gem, staff, and ring. One of these items must they steal from the den of a rodent.

They must drink of the Eye of Death,

Fez's Silver Ring

The inside of the ring is engraved with the inscription, *Time solves all problems*.

If Delyn puts the ring on, she will automatically know that it contains three spells, which she may cast at will: Fly, Web, and Shield.

The ring is worth 1,500 gp.

12: Gong Below

A trap door is centered in the top of this tower. Otherwise, this area is empty.

If the Player Characters open the trap door, continue reading to the Players:

A large gong is on the dirt floor twenty feet below.

The gong below summons the evil eye in **Area 11** when it is struck. Note that if the PCs do not open the trap door and they have not been in **Area 11** yet, they will not fulfill the prophecy concerning drinking of the fluid of the evil eye.

Tower 1: A Wizard's Staff

The keystone above the courtyard entry door depicts a staff.

There are two levels connected by a winding central stairwell in Tower 1.

The ogre in **Area 14** has Fez's staff. PCs may be fooled into thinking the staff they want is held by the lesser ogres in **Area 13**, but the ogres' staves are not magical.

13: Two Staves

A winding stairwell is in the center of this circular room. Large oak beams support the wooden ceiling ten feet overhead. Three human corpses lie near the stairwell. There is a small trunk near the stairwell's open doorway.

Two ogres come through the doorway. They raise their staves to attack.

The bodies have been looted.

The stairwell leads up to **Area 14** on the second floor.

The trunk is locked, but it is not trapped. It contains three sacks: one sack with dried onions, one sack containing sixteen shireling fingers, and a smaller sack with 16 cp.

but this liquid will give forth not what one might think. Finally, they shall answer a riddle posed by a powerful servant. These things must the band from the dead accomplish, or the scarred dragon will destroy the wizard's vale.

*Sourbeard, Seer,
Gold Piece Bay*

I hope these quotations will be of some use to you.

Sincerely,

Maurice Zolotow

Director, Library of Congress

Washington, D.C. 20550

(2) Ogres

HTK: 17, 21 (4D8+1), AC: 5
AT: 1, DM: 1D6
MV: 9", AL: C. Evil
INT: low
Size: L
THACO: 15
Weapons: staves

14: Fez's Magic Staff

A large ogre sits on a bench against the outer wall of this room. Sparks fly from his oak staff; he rants and raves as he swings the staff menacingly.

The ogre's left leg is bound by a leg-iron attached to a short iron chain which is anchored into the wall behind the bench. The chain prevents the ogre from moving more than two feet from the wall.

The ogre speaks common. If the Player Characters try to speak to him, he calms down. The ogre then tells the party that he has been imprisoned for a long time, and that he will give the party the staff if he is set free.

The ogre gives the staff to the party as promised if he is released. In the ogre's pouch are identification papers for three young warriors from the Village of Normal, 50 sp, and a blue marble (non-magical).

(1) Ogre

HTK: 27 (4D8+1), AC: 5
AT: 1, DM: 1D10+1
MV: 9", AL: C. Evil
INT: low
Size: L
THACO: 15
Weapons: Fez's +2 magic staff
Treasure: 59 sp, 1 blue marble (worth 2 cp)

Fez's Staff

Fez's staff, when wielded as a weapon, is +2 to hit and delivers 1D10+1 HTK of damage. The staff contains three spells (which are usable once a day): Encase, Reduce Armor Class, and Speak/Read Languages. Only Fez can use its spell-casting powers.

Encase: enables Fez to enclose a being (or part of a being) in a crystal-like substance.

A gemstone the size of the target (or portion of the target) to be encased is required; the stone must first be pulverized before the spell is cast.

Any target of less than 12 HTK dice will suffocate 2D6 rounds after being encased.

Reduce Armor Class: enables Fez to reduce his opponent's Armor Class by one.

Speak/Read Languages: enables Fez to speak and read any language for as long as he concentrates on doing so.

Tower 2: Nine Lives

The relief on the keystone over the courtyard door depicts an axe.

There are two floors connected by a winding stairway.

The party must fight the magical creature that lives in the top floor of this tower if they enter its lair.

15: Three Warnings

The ground floor of this tower is a single room. A winding stairway leads upward in the center of the room.

Three corpses lie on the floor. One is a male elf dressed in leather armor. The elf's neck is badly bruised. He has a garrote in his hand.

The second corpse is a human female. The charred remains of a book are clutched in her hand. The woman's body and robes are badly burned.

The third corpse is that of a male dwarven fighter dressed in leather armor and a helmet. A bloodied two-handed sword lies in a pool of blood near the dwarf's feet. The dwarf's body appears to have been almost cut in half.

The three dead adventurers were killed by the niner in Area 16. They have no treasure. The dwarf's armor is too damaged to be useful. The sword is non-magical, but it is in good condition.

16: The Niner

The stairs open onto a dimly-lit circular room. A purple cat perches atop a chest against the outer wall. The cat screeches, then fades from view.

As soon as the party enters the room, a copy of each party member who enters appears beside the chest. The copies just stand there unless the party tries to open the chest.

The cat is a niner. It disperses 8 HTK into each copy. Each copy fights its "original" at one skill level less than the opponent being copied. If less than nine copies enter melee, the first few copies are replaced when they are killed.

Niner

HTK: 72 (12D8), AC: Special
AT: Special, DM: Special
MV: 13", AL: Special
INT: low
Size: S
THACO: Special

Special: uses its own HTK to produce copies of opponents; the niner attacks by projecting up to nine copies of its opponents into melee. Each copy has 8 HTK, is man-sized, and fights at one skill level less than the opponent being copied. When a copy dies, it is replaced as long as the niner has another 8 hits remaining. (Killing all nine copies created by the niner kills the niner.)

Treasure: The chest contains 3 gems (1000 gp each), a Potion of Silence, 412 gp, 303 sp, and a dwarven war hammer (worth 800 gp). The hammer is +3 to hit and returns to its wielder's hand if it is wielded by a dwarf. It does 3D8 HTK of damage on a hit.

Tower 3: Snake Eyes

The relief on the keystone above the courtyard doorway depicts two dice with one dot on each. An enclosed winding stairway encircles the outer wall.

This tower has two floors. The stairway goes from the ground level to a trap door on top of the tower.

Delyn recognizes the dice on the relief as 'snake eyes.'

The party must find Fez's sword, which is hidden on top of the tower beneath a loose stone.

17: Boxes and Boxes

A stairway encircles the perimeter of this circular room. There are some boxes and crates piled against the far wall.

The boxes and crates contained the gambling equipment now in use in Area 18 on the second floor. There are ten boxes and crates on the floor of the room. The boxes and crates are all empty.

One box has 'Roulette Wheel' printed on its side. Each box and crate has a shipment label from 'Gambling Supplies, Mission Avenue, Las Vegas, Nevada.' The boxes are addressed to 'Lucky Stan, E.H.P., care of Castle Fez, Wizard's Vale, Tera.'

If Shane enters the stairwell, he notices drops of dried blood on the bottom two steps. The blood leads up the stairs and stops outside the door to Area 18.

18: Never Gamble on a Mission

The stairwell continues both up and down. The stairway door has a sign which says: "Lucky Stan's Gambling Casino."

If the party opens the door, continue reading to the Players:

This room is a plush gambling hall, complete with two blackjack tables, a craps table, and a roulette wheel.

A comely woman in her late teens comes to the door and says, "Hi! My name is Starr. May I invite you to try a game of chance. If you play your cards right, you might even win a Commune spell."

Two men are at each blackjack table. Another man, who introduces himself as Lucky Stan, is running the craps table.

This is a vicious trap. If the party is foolish enough to "Gamble on this Mission," then the signal for those in the room to attack is the first time any of the Player Characters in the room actually gambles. At that point, the people in the room attack the PCs in the room.

(1) Lucky Stan, Human, Skill 10 Cleric

STR: 13, INT: 15, INS: 14
STA: 13, DEX: 12, APL: 13
HTK: 36 (10D6), AC: 8
AT: 1, DM: by spell or weapon type
MV: 9, AL: N. Evil
THACO: 14
Weapon Proficiencies: club, flail, mace, staff

Weapons: club
Armor: leather
Spells: 4/4/3/3/2

Specials: These spells are in addition to the normal allotment for a skill 10 cleric: Finger of Death, (1 use), Cause Serious Wounds (3 uses)
Treasure: 234 gp, magic dice (will roll whatever number the owner desires once per day; worth 150 gp.)

(1) **Starr, Human, Skill 7 Magic-user**

STR: 10, *INT:* 15, *INS:* 16
STA: 15 (+1), *DEX:* 14, *APL:* 17
HTK: 18 (7D4), *AC:* 8
AT: 1, *DM:* 1D4 (dagger) or by spell or weapon type
MV: 12", *AL:* N. Evil
THACO: 19
Weapon Proficiencies: dagger, staff
Weapons: dagger
Armor: leather
Spells: 4/3/2/1
Specials: Magic Missile (3 uses) — each does 1D6+4 HTK of damage
Treasure: +1 robe (+1 to saves, *AC:* 8, worth 500 gp), silver brooch (worth 72 gp)

(4) **Human, Skill 5 Thieves**

HTK: 13, 21, 23, 19 (5D6), *AC:* 8
AT: 1, *DM:* 1D8 (short sword) or by weapon type
MV: 13", *AL:* L. Evil
THACO: 19
Weapon Proficiencies: dagger, sling, short sword
Weapons: short sword
Special: Thieving Abilities: Pick Pockets: 50%, Open Locks: 42%, Find/Remove Traps: 40%, Move Silently: 40%, Hide in Shadows: 31%, Hear Noise: 20%, Climb Walls: 90%, Read Languages: 25%
Treasure: 215 gp, magic robes (*AC:* 8, worth 550 gp each)

19: A Wizard's Sword

A small cat is sunning himself near the outer edge of the tower. The cat is yellow, except for the black fur around his eyes. This makes him look like a racoon. The cat looks up momentarily, stretches and yawns, then curls back up.

A stone trap door is located near the courtyard wall of the tower. A brass handle is set into the door.

The cat is normal. The trap door opens to the stairwell that encircles the tower. Fez's sword (the item the party wants) is in a narrow cavity beneath a loose stone at the spot where the cat lies.

Cat

HTK: 2 (1D8-4), *AC:* 7
AT: None *DM:* None
MV: 15", *AL:* Neutral
INT: animal
Size: S
THACO: None
Specials: None

Fez's Sword

Fez's sword is a Wizard's Sword, which is a sword usable by magic-users with the same proficiency as a fighter of that Character's skill level.

This sword has been forged for a special purpose: if it ever cuts a dragon, then the blade bursts into an extremely hot flame, causing 10D10 HTK of damage to the dragon. The blade is made of graphite; the hilt and grip are coated with asbestos. The asbestos protects the wielder of the sword when it ignites. When the blade ignites, the sword is destroyed.

Tower 4: Solid Rock

This tower is made of solid rock. It has no interior rooms, no doorways, and no keystone. The top of the tower is barren.

Tower 5: The False Prophet

The relief on the keystone above the door to the courtyard depicts an old man with a waist-length beard.

The tower has only one floor. Inside the tower is a false prophet. He is harmless, but he solicits money for useless advice.

20: The False Prophet

The inside of this tower consists of a single room.

An emaciated old man is sitting in the center of the room, drinking wine. He wears a dirty burlap garment. The man looks up and whines, "I suppose you are like all the rest. You want my advice, but you aren't willing to pay. Forget it. I don't give advice without payment in advance."

The "prophet" will offer three pieces of advice. He demands 100 gp in advance for each piece of advice:

Cleanliness is next to impossible.

He who hesitates is last.

To err is human, to forget divine.

(1) **False Prophet/Hermit, Human, Skill 3 Thief**

STR: 7 (0, -1), *INT:* 14, *INS:* 12
STA: 6 (-1), *DEX:* 17 (+2, -3), *APL:* 9
HTK: 6 (3D6), *AC:* 7
AT: 1, *DM:* 1D4 (dagger) or by weapon type
MV: 13", *AL:* L. Evil
Weapon Proficiencies: dagger, sling
Weapons: two daggers
THACO: 20

Specials: Passes nonsense sayings along to unsuspecting Characters for profit; thief abilities: Pick Pockets: 45%, Open Locks: 43%, Find/Remove Traps: 30%, Move Silently: 32%, Hide in Shadows: 25%, Hear Noise: 15%, Climb Walls: 87%

21: Three Questions

In the southern portion of the tower wall is a bust of a bearded man. The stand bears the inscription "Aristotle."

When anyone approaches the bust, it says, "I will answer three questions."

The answers are always one question behind. No matter what it is asked first, it replies: "Of course I will remain here until someone moves me." In response to the second question, the bust correctly answers the first question it was asked. In answer to the third, the bust answers the second.

The answer to the third question will be given as a response to the first question asked by the next party that questions the bust. The bust will remain silent if the same party goes through a second time; the answer to the third question will never be given to the same party.

Tower 6: The Maze

There is a relief on the keystone above the door to the courtyard depicting a small silver chest.

There is a magical spell on the tower which negates the Dimension Door spell.

Fez built this tower in happier days so that his students could learn the value of riddles and hermit sayings.

NOTE: The inside of the tower is a maze. If the PCs enter the tower, the GM should sketch the floor plan for them as they move through the tower.

22: Going Up

There is an 80% chance that anyone who walks forward through this hallway is teleported to Area 23. If this occurs, there is a 30% chance that dwarves in the party immediately realize that they have been teleported upward ten feet.

23: Going Down

If the PCs double back through this section of the hallway, they are teleported to Area 22.

24: Stone Statues

Inside this circular room are two statues: one is of a human fighter, and the other is of a shireling thief. There are sounds of movement behind the statues.

Unless the PCs turns away immediately, they are attacked by a basilisk. Those who gaze upon the basilisk must save vs. Petrification or be turned to stone. Note that the basilisk will only attack one opponent per round.

Upon leaving this room, Player Characters are teleported to Area 23.

(1) **Basilisk**

HTK: 36 (6D8+1), *AC:* 4
AT: 1, *DM:* 1D10 (bite)
MV: 6", *AL:* Neutral
INT: animal
Size: M
THACO: 13
Special: Gaze turns victim to stone

25: The Hermit's Clue

A small silver chest sits in the middle of this circular room.

Inside the unlocked chest is a note which reads: *Every hermit knows that he who exactly retraces his steps will only retreat.*

The chest is worth 1000 gp.

Tower 7: Demons

The keystone above the door to the courtyard is blank.

Fez left the blue diamond the PCs are looking for in a chest on the second floor. However, a squirrel took the diamond from here. The party can follow his tracks (Area 29) to his nest in the forest nearby.

26: Drawn and Quartered

The door opens onto a circular ten-foot-high room. A stairwell is located in the center of the room. On the table lie the remains of a half-butchered brown-skinned humanoid. Flies swarm over the carcass.

Three sharp knives and a butcher's saw lie on the floor near the blood-stained table. The knives are soiled and bloody.

The three demons who presently live in this tower have a liking for kobold flesh.

Occasionally, they capture and slaughter one of the kobolds who live in Tower 10.

27: Curses

The top floor is divided into two halves by a north-south wall. A door is located in the southern portion of this wall.

A cot and a small table with three chairs stand against the eastern wall. An open bottle of wine and a loaf of dark bread are on the table. Flies swarm over a small piece of blue meat on the floor under the table.

Someone in the adjacent room is cursing in a deep nasal voice.

The voice comes from Area 28. Characters who listen at the door learn that whoever is shouting is most upset that his helpers have allowed a gem entrusted to their care to be stolen.

28: The Missing Gem

Three demons are in this room. Two of them are cringing on the floor with their claws over their heads. The third, the largest demon, towers over them.

The large demon has his back to the door. He is cursing profusely as blue smoke pours from his mouth. As he continues his

tirade, he frantically waves his claws. He occasionally stops to kick one of the prostrate demons, then he begins anew.

Near the door is an open wooden chest.

From the door, the PCs can see that the chest is empty and that a hole, approximately four inches in diameter, has been gnawed into the back of the chest. Small animal tracks lead from the chest to a narrow window on the outside wall (Shane knows that these are squirrel tracks).

The party can leave without being noticed, or they can attack the demons with the advantage of surprise.

(1) Demon Leader, Skill 6 Fighter

HTK: 33 (6D10), AC: 8

AT: 2, DM: 1D10/1D10 (claw/claw) +

save vs. Paralyzation

MV: 13", AL: L. Evil

THACO: 18

Weapon Proficiencies: None

Weapons: None

Specials: claws have a paralyzing poison; victim must save vs. Paralyzation or be paralyzed for 1D10 rounds

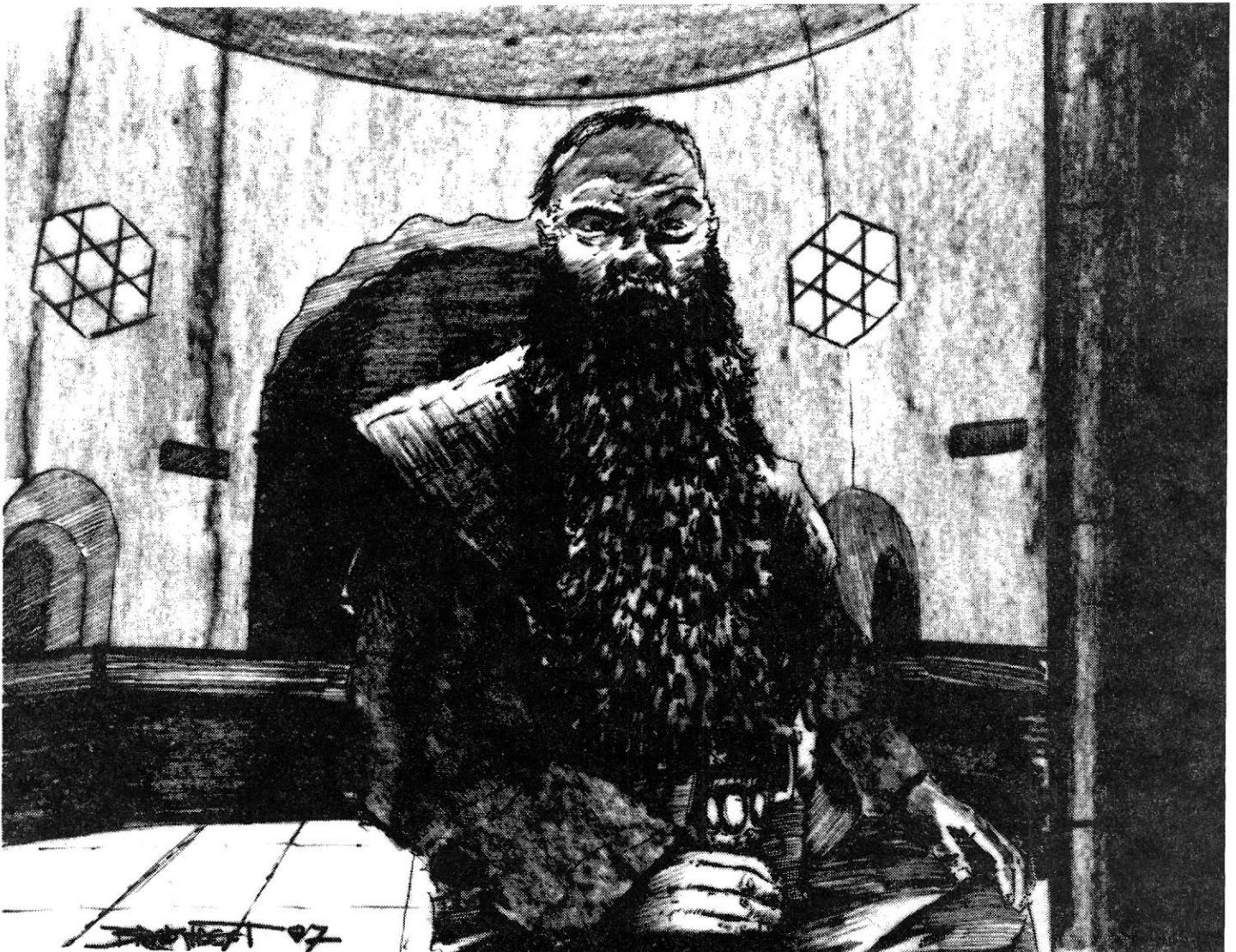

(2) *Minor Demons, Skill 4 Fighters*

HTK: 17, 20 (4D10), AC: 8
AT: 2, DM: 1D8/1D8 (claw/claw)
MV: 10", AL: L. Evil
THACO: 18
Weapon Proficiencies: None
Weapons: None
Specials: None

29: Tracks

Squirrel tracks lead from a small window in the second floor of this tower to an oak tree located a hundred yards into the forest.

Inside the squirrel's nest is a perfect, blue diamond. The gem is six inches long and tapers from a diameter of four inches to slightly more than an inch at its narrow end.

NOTE: If the PCs don't look for the tracks, or if Shane is not with the party, then tell the Players that the squirrel is running toward his nest.

Tower 8: Three Questions

The keystone above the courtyard door depicts a chest with three question marks engraved on its side.

This tower has two floors connected by a hole through the floor of the upper level.

30: Ogre Statues

The door opens to a ten-foot-high circular room. In the center of the room is a huge silver chest. Surrounding the chest, with weapons positioned as if to strike, are six statues of ogres.

Near the wall across from the courtyard door a ladder extends from the dirt floor up and through a hole in the ceiling.

The stone statues animate and attack anyone who opens the chest.

The chest is three feet long, two feet high, and two feet deep; it is worth 4,000 gp; it is empty.

(6) *Ogre Statues*

HTK: 19, 20, 21, 22, 23, 24 (5D8),
AC: 5
AT: 1, DM: 1D6 (club)
MV: 10", AL: Neutral
INT: non
Size: L
Weapons: clubs
THACO: 15
Specials: attack those who open the silver chest
Treasure: Inside the chest are three scrolls:
1) Fly (two uses),
2) Invisibility (four uses), and
3) Cure Serious Wounds (3D8+3)

31: The Riddle Box

The second story of this tower is composed of a single circular room. A ladder protrudes from a 3' x 3' hole in the floor along the west wall. The room looks to be empty.

If the PCs investigate the north portion of the room they discover an invisible chest, which becomes visible when it is touched or bumped into.

Three question marks are engraved on the side of the chest. When the chest appears, a Magic Mouth also appears; it says, "Let's play a game . . . I'll ask three riddles, and you'll answer as well as you can. For each of my riddles you answer correctly, I'll answer a question of yours. My three riddles are:

*Fly through the air,
See through me to the stars,
Escape from a prison,
With no leaden bars.
What am I?*

*I am death at first blow,
Not shown on a whim,
If One-Eye displayed me,
I'd kill even him.
What am I?*

*I begin as I end, 'CHAOTIC.'
What am I?*

Respectively, the answers are:
Sir Laetumakki (or a Lammasu),
Storm's Sword, and
the letter 'C'

GM NOTE: The box acts as a Commune spell and correctly answers any question asked, up to the number of riddles correctly answered by the party.

Tower 9: Kobolds

The keystone above the courtyard door depicts a rook (chess piece). A narrow stairwell runs along the exterior wall from the ground level to the top of the tower.

The tower is presently controlled by kobolds. They have bolted the trap door in the ceiling of the tower and have set traps at both landings of the tower's stairwell.

32: A Trap

This 10' x 5' room is the landing of a stairwell which winds upwards along the exterior wall. Opposite the courtyard door is a closed oak door. A small silver chess piece, a rook, sits in a corner of the landing.

The chess piece is trapped. If touched, it explodes with a loud noise, causing 1D4 HTK of damage to whoever picks it up. Thieves who carefully investigate have a 10% chance per skill level of finding and removing the trap.

The door leading into **Area 33** is unlocked. Anyone who listens at this door hears a many high-pitched voices debating on what the best method of cooking fresh rabbit over an open fire is.

33: Kobolds

This circular smoky room is full of small, brown-skinned humanoids. Straw mats are strewn about on the floor. The

area is in great disarray. They are carrying long knives and are wearing blue-dyed leather armor. Several of them are cooking rabbits on a spit.

One of the humanoids approaches and says, "I am Zaddie, king of the kobolds. This tower is our home. We have taken refuge from those who would do us harm. I ask that you leave. There is nothing here that is worthy of great warriors such as you."

The kobolds do not want to fight, but they will defend themselves if necessary.

(40) *Kobolds*

HTK: 1x6, 2x12, 3x10, 4x12 (1D8-4),
AC: 7
AT: 1, DM: 1D4
MV: 6", AL: L. Evil
Weapons: daggers
INT: average (low)
Size: S
THACO: 20
Specials: Excellent night vision

34: Stairway Landing

This 10' x 5' room is a stairway landing. The stairwell along the exterior wall winds upward and downward from here.

There is nothing of interest here.

35: Kobold Quarters

Straw mats are scattered about in this room. Otherwise, this room is empty.

About half of the kobolds who live in this tower sleep in this room. At this time, they are all in **Area 33** eating dinner.

36: A Trapped Scroll

This 10' by 5' area is a stairway landing. Iron rungs in the outer wall of the tower extend to a trap door in the ceiling. The trap door is bolted from the underside. A scroll lies in one corner of the landing.

The scroll is trapped. If it is read, it explodes with a loud bang, causing 1D4 HTK of damage to the reader.

37: The Locked Trapdoor

The top of this tower contains a trap door on the side nearest to the courtyard.

The trap door is bolted on its underside. The door can take 6 HTK of damage before it can be opened by force. (See **Area 36**.)

Tower 10: Imps

The keystone above the courtyard door depicts a small reptilian skull. A sign on the door says ENTER AT YOUR OWN RISK.

38: Skullduggery

The door opens to a ten-foot-high circular room. Twenty snake skulls are



stacked together in a small pile in the center of the floor.

Two small creatures are seated next to the skulls. The creatures are orange, with violet wings and fluorescent green eyes. They are juggling the snake skulls five at a time. One of them laughs, "Come join the fun. We dare you!"

The imps' idea of fun is to hurl two skulls per turn at those who enter the room. Each skull causes an immediate disabling nausea to any Character who fails to save

vs. Paralyzation. The effect lasts for ten minutes.

(2) Imps

HTK: 17, 21 (2D8+2), *AC:* 2
AT: 2 (snake skulls), 1 (tail),
DM: 1D4 + save vs. Paralyzation (skulls), 1D4 + save vs. Poison (tail)
MV: 6"/18", *AL:* L. Evil
INT: Average
Size: S (2' tall)
THACO: 16
Magic Items: snake skulls
Specials: Only silver or magical weapons will damage them; can Detect

Good and Detect Magic; regenerate at 1 HTK per round; can Turn Invisible at will; can use Suggestion once per day; can Polymorph into a large spider, giant rat, raven, or goat at will; attacks with tail can only be made in unpolymorphed state — victim must save vs. Poison or die.

If one of the imps is killed, the other leaves immediately. If either one sustains more than 8 HTK of damage, they both Turn Invisible and leave the party alone.

CASTLE FEZ Tower Maps



TOWER ZERO

CENTRAL TOWER

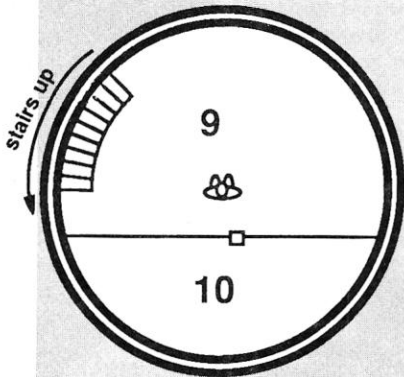

Basement

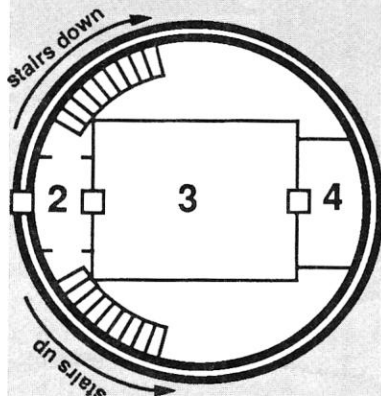

First Floor

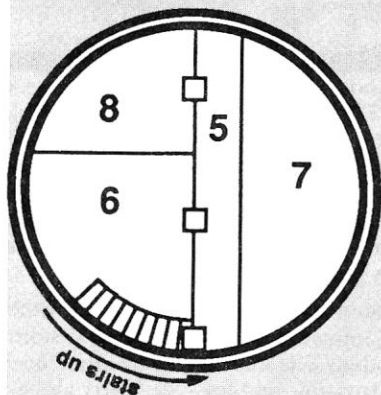

Second Floor

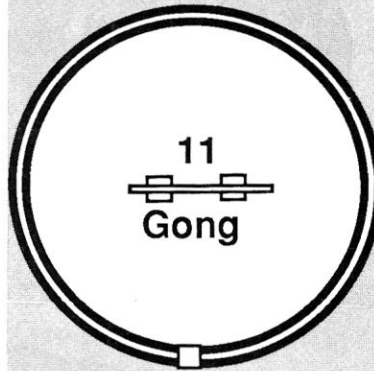

First Floor

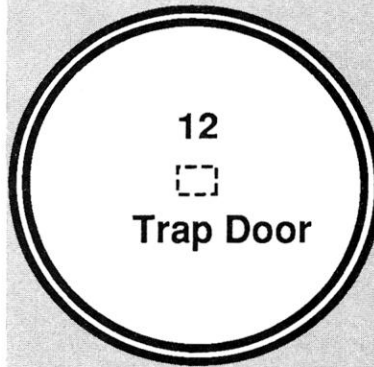

Second Floor

— 30 FT. —

TOWER ONE

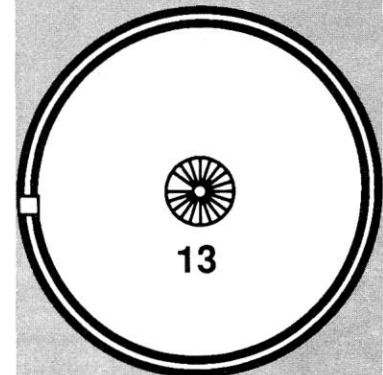

First Floor

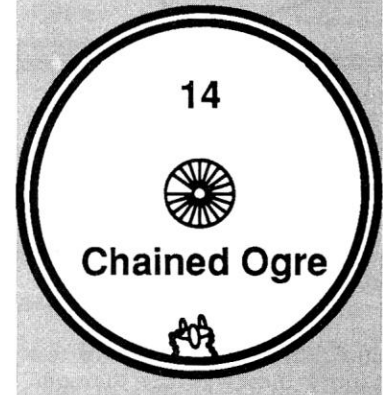

Second Floor

TOWER TWO

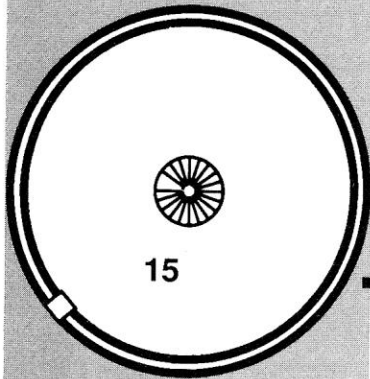

First Floor

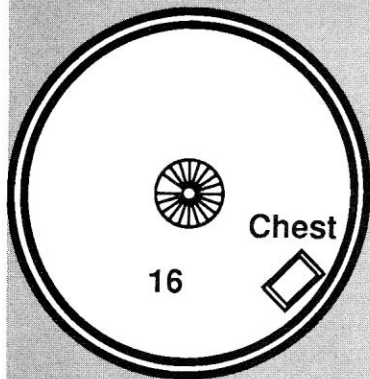

Second Floor

TOWER THREE

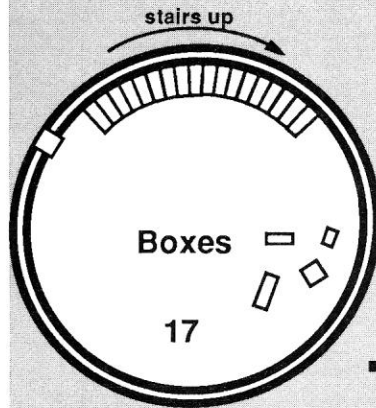

First Floor

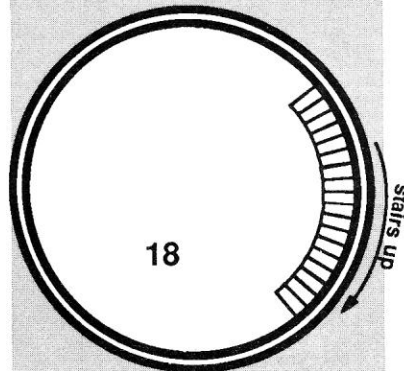

Second Floor

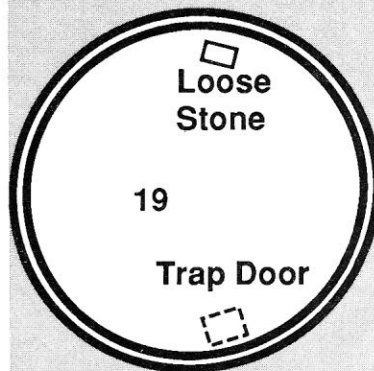

Third Floor

TOWER FOUR

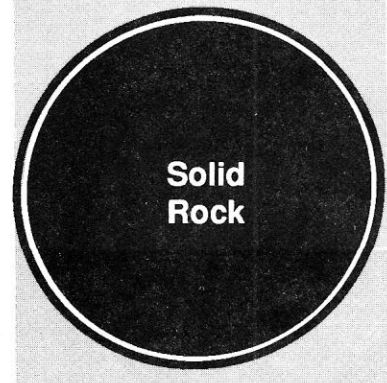

Tower Maps

TOWER SEVEN

TOWER FIVE

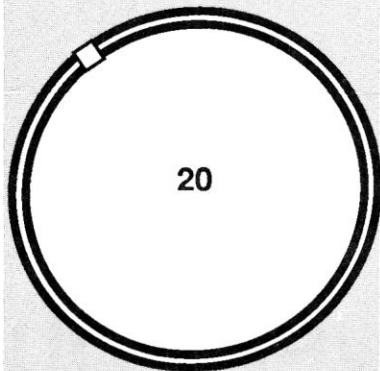

Floor Floor

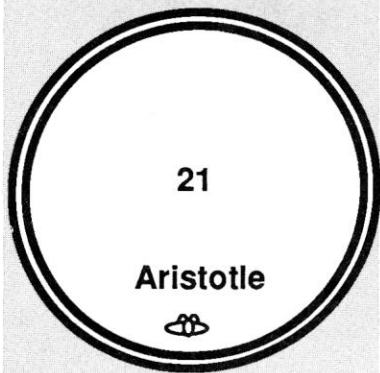

Second Floor

TOWER SIX

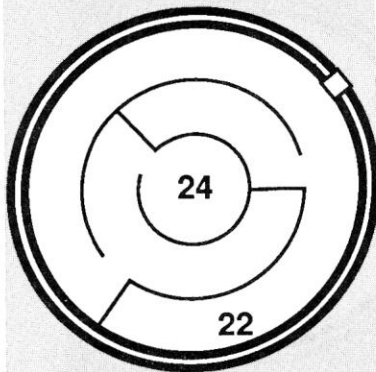

First Floor

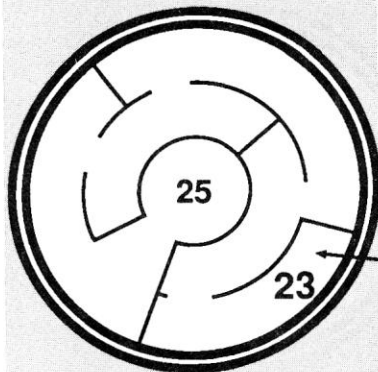

Second Floor

Party will be teleported here.

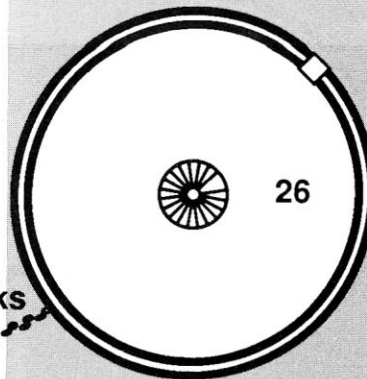

First Floor

Squirrel Tracks

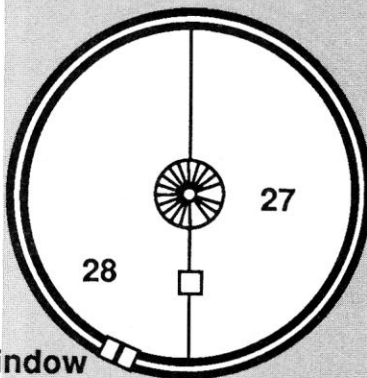
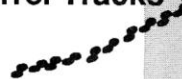

Second Floor

Window

30 FT.

TOWER NINE

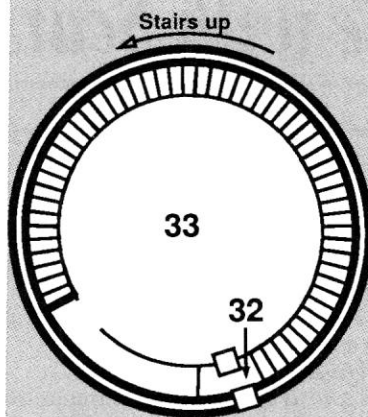

First Floor

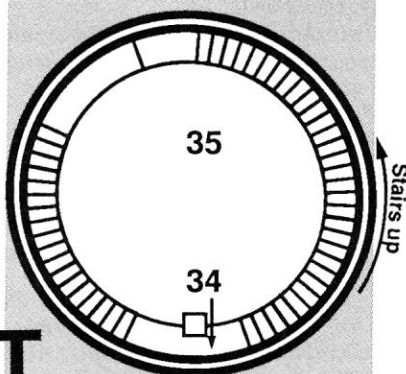

Second Floor

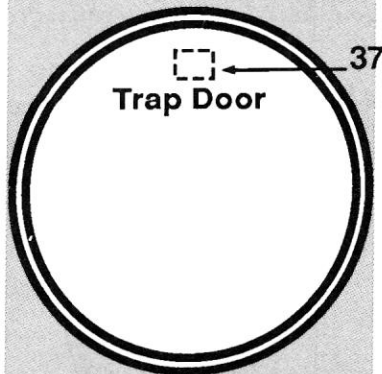

Thrid Floor

Tower Maps

TOWER EIGHT

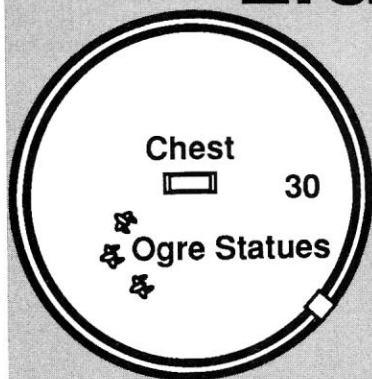

First Floor

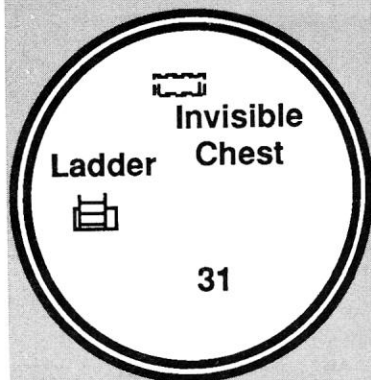

Second Floor

TOWER TEN

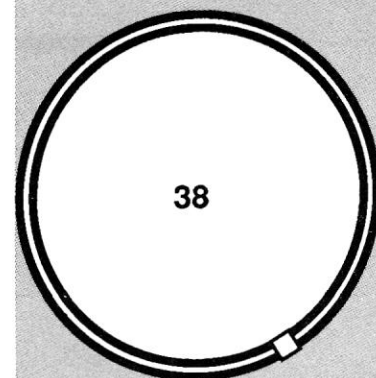

First Floor

Battle with Scarsnout

When all the prophecies have been completed and the party goes to **Area 10** of the Central Tower, Warrior wakes Fez.

Read the following aloud to the Players:

An old man is sleeping on a cot. The robot takes the four items (the ring, staff, gem and sword) and walks over to the old man. "Fez, it is time," he says.

In a few moments, the old man wakes up, stretches his limbs, and stands up. He is wearing faded red long-johns. There is a tiny hole just above the left knee.

"Gads! You should have told me we have company," the wizard exclaims, snatching up his robe. After he is dressed, the wizard says, "My friends, you have done well. You have succeeded where many would have failed. Surely you are Scarsnout's bane."

Fez then looks deeply into his crystal ball. His expression becomes grave, and he says, "It is time to kill a dragon."

There is a terrible grinding noise. The gem the robot once held in his hands is now a fine blue powder.

"Only the power of such a gem can hold one as powerful as Scarsnout," the wizard explains. "Come. We must go to the cave."

As the party reaches the stairs, a huge demon smirks and says, "Foolish little wizard." Then he smiles at Heathertoed and says, "Don't dawdle, imp. You have a dragon to kill."

GM NOTE: If Heathertoed asks Fez about the demon, he tells her not to worry; he ignores any further questions. The demon is Mephistopheles, one of Fez's servants. His presence is explained in the second adventure, *Fez II: The Contract*.

The wizard explains his plan: "My spell will encase the dragon's head in a facsimile of the diamond. This would destroy a

normal beast, but not one as powerful as Scarsnout. When I cast the spell, you will have three minutes to slay the monster.

"If you fail, we will be saturated with acid and nothing will save us. Nothing!"

Fez leads you to a cave in the center of the valley. The entrance is a circular shaft, thirty yards wide. It slopes down at a forty-five degree angle to the west.

"Quiet," the wizard whispers.

A wall is blocking the entrance. Runes are engraved on the wall. "Blast," the wizard says, "he knows we are here."

Fez gives his sword to Delyn and says, "This sword was made for only one purpose. Use it well."

Only the wizard and his robot are able to approach the wall. Fez places his hands on his chest, then he pushes outward. The wall is no longer there.

Standing in the entryway is an immense dragon. Its head is six feet across. The body extends as far as you can see into the darkness. A yellow scar runs from its left eye, across its snout, and into its right nostril.

The dragon speaks, "I know you, whelp. The robot will not save you this time."

Several things happen at once. Acid jets from Scarsnout's mouth. Warrior tosses the diamond dust at the dragon's head and "blinks" between Fez and the acid. Fez raises his staff; there is a thunderclap. The diamond swirls and crystallizes around the dragon's head. Fez then raises his staff once again.

All movement in the entry ceases, as if time has stopped.

The party has three melee rounds to kill the dragon.

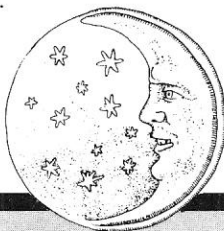

EPILOGUE

Deep in the cave, the party found Scarsnout's treasure. It is estimated that each party member carried out items and gems valued at over a quarter of a million gold pieces. Of special note is that Sourpatch found a shield engraved with: "Vwrup'v Vklog" (Storm's Shield).

Before the party left the valley, Fez gave each adventurer a special gift. What the gifts were is unknown, except that in the fourth adventure we learn that Mondae and Sourpatch each received half of a magical

coin. The coin was made by Fez's demon slave, Mephistopheles.

The story of how the demon Mephistopheles becomes Fez's servant is told in the second adventure, *The Contract*. The history of the gem used to overcome Scarsnout is told in the third adventure, *Angry Wizard*.

The final three adventures, *Wizard's Revenge*, *Wizard's Betrayal*, and *Wizard's Dilemma*, chronicle Fez's struggles with the paradoxes caused by time travels.

Scarsnout is dead, but, the adventure has just begun . . .

Aside from casting the spells necessary to aid the party, Fez will not participate in the battle.

If Scarsnout is so much as cut with Fez's sword, the blade of the sword bursts into an extremely hot flame, and Scarsnout takes 10D10 HTK of damage. The sword then become useless and melts.

NOTE: Fez uses his staff to cast two spells. The first spell, *Encase*, causes a crystal enclosure to form around the dragon's head from the diamond dust. The second spell, *Reduce Armor Class*, lowers Scarsnout's AC to 7 (8 vs. arrows) for three melee rounds.

Scarsnout, Skill 20 Black True Dragon

HTK: 72 (20D8), AC: 5 (6 vs. arrows)

AT: 1 (breath) or 3 (claw, claw, bite),

DM: 2D20 (breath); save vs. Breath

Weapon for half damage 1D8 (claw) 1D10 (bite)

MV: 15"/30", AL: N. Evil

INT: very

THACO: 6

Specials: Each "true dragon" has his/her own special ability. Scarsnout is the oldest known true dragon and the only one of his race to have two special abilities, which are:

1) Scarsnout may use his breath weapon at will (i.e., once each melee round).

2) Scarsnout can only be harmed by beings who have died (either resurrected Characters or undead). This explains the prophecy that "only the band from the dead can kill the scarred dragon."

WIZARD'S VALE

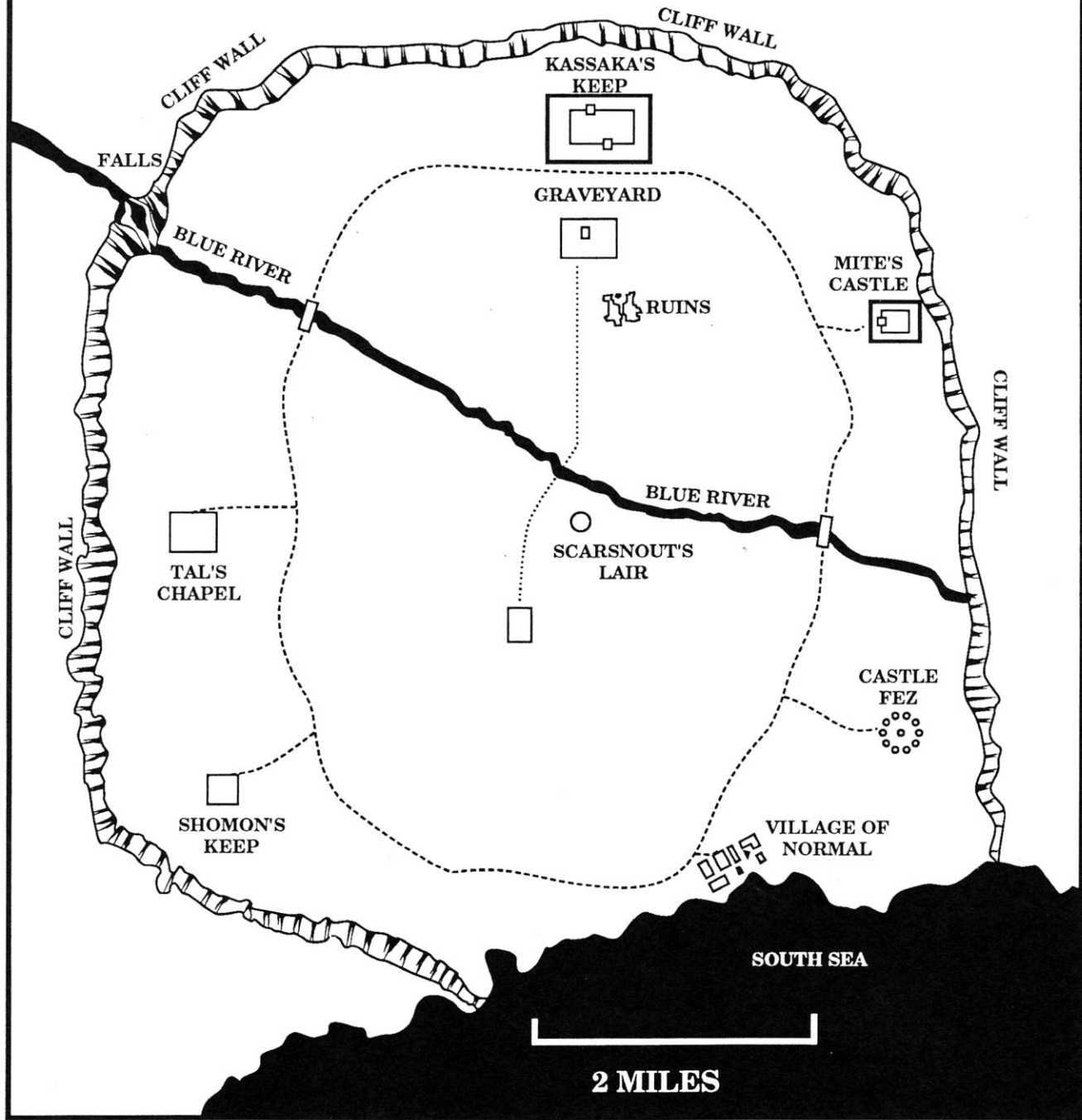

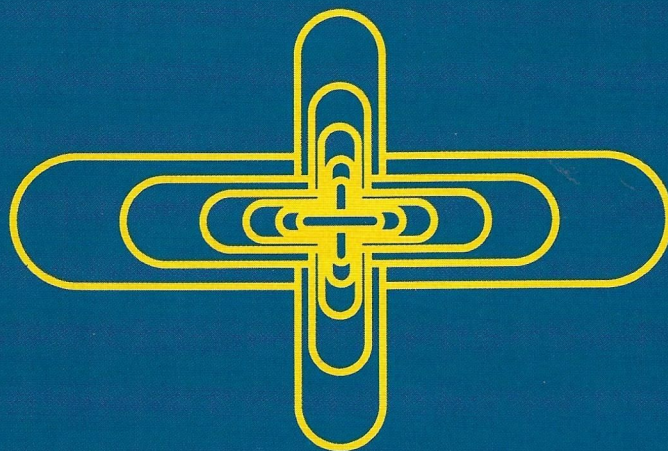

*Werewolf terrorizes Wizard's Vale,
Fez™ discovers fateful prophecies,
Liches play killer bridge game!*

Fez, the Wizard of Time Travel, has stumbled upon predictions which will have a profound impact on his future (whatever that means to a time-travelling wizard). The prophecies state that a "band raised from the dead" will help a wizard defeat a dragon. Fez can now overcome his lifelong enemy, the evil dragon Scarsnout! Unfortunately, the band's members have little memory of who they were before they were raised. Also, a werewolf has killed the only person who knew the Player Characters' identities. Now, the adventurers must regain their memories and obtain the items necessary to fulfill the prophecies (while trying not to disturb the liches' bridge game)!

In this adventure, the Player Characters must solve riddles and think their way out of sticky messes to survive and successfully aid the wizard Fez.

Wizard's Vale includes maps of Fez's castle. Among the resurrected Player Characters are a lammasu and a twentieth-century human.

Wizard's Vale can be played as the first adventure in the popular six-part series that includes *The Contract*, *Angry Wizard*, *Wizard's Revenge*, and *Wizard's Betrayal*; it can also be played by itself.



1087-703MFG7.00



Made in USA