

# DWARVES



**A Complete Kingdom:  
2 Cities  
3 Towns  
New Magic and  
an Epic Adventure**

Presented by the editors  
of Role Aids<sup>™</sup> for use with  
**ADVANCED  
DUNGEONS & DRAGONS<sup>®</sup>**  
role-playing game.

ADVANCED DUNGEONS & DRAGONS is a registered trademark of TSR, Inc. This use of TSR's trademark by Mayfair Games is not approved by TSR.

deWitt ©84



# DWARVES

## A Kingdom and Adventure

by Paul Karczag



*Here is the Dwarven Kingdom of Ostohar, one of the oldest and perhaps the most isolated of all the Dwarven Realms. While unusual in several ways, Ostohar serves well as a prime example of Dwarven life and adventure. Much of the material which follows derives from a Treatise written over several decades by a half elven Sage. By extending her life with magical potions, the Sage was able to observe or research much of Ostohar's history and culture.*

*Also dealt with is the question as to whether or not Dwarven women have beards. As the adventure progresses, the players will discover not only the original bearded nature of the women in Ostohar, but also understand how they permanently shed their facial hair.*

# DWARVES

By Paul Karczag

*Edited by: Bill Fawcett*

*Art by: Gerald O'Malley, Ellie Mooney, and James Clouse*

*Cover by: Bob deWitt*

---

© Mayfair Games Inc. 1982

All Rights Reserved

*Permission is granted to the purchaser of this book to copy the maps and players' histories for personal use provided that none of the copies are sold or traded.*

*This book is dedicated to my editor, proofreader, chief typesetter, loving critic, and favorite beardless female, my wife Darrelyn.*

*I would like to acknowledge that ideas originally conceived by Irwin Goldstein, Sue Khas, Les Kay, John Murray, James Griffin, and Steve Morrison appear in this booklet.*



and RoleAids are trademarks for roleplaying aids and adventures published by Mayfair Games Inc.

---

All characters in this book are fictitious.

Any resemblance to actual person, living or dead, is purely coincidental.

---

Mayfair Games Inc. • P.O. Box 48539 • Niles, IL • 60648

## TABLE OF CONTENTS

Forward .....	.5
Chronology .....	.6
Life in Ostohar .....	.10
Magic .....	.17
Artifacts .....	.18
Religion .....	.20
Generating Dwarven Characters .....	.23
Ostohar	
New City .....	.26
Old City .....	.29
Underground City .....	.31
City Adventures .....	.36
Fin .....	.39
Anor .....	.43
The Dwarven Rite	
A Short History of the Barren Ridge Dwarves .....	.45
Encounters .....	.49
Castle Crag .....	.57
Emerald Valley .....	.66
The Citadel .....	.71
Appendixes	
The Adventure .....	.84
Characters .....	.84
The Monsters .....	.90
The Emerald Valley Dwarves .....	.91
Special Magics .....	.92

## MAPS

Ostohar	
Outer City .....	.28
Side View .....	.30
Front View .....	.31
Level 1 .....	.32
Level 2 .....	.33
Level 3 .....	.35
Fin .....	.38
Anor .....	.42
Kingdom of Ostohar .....	.44
Knorr's Map .....	.48
Castle Crag .....	.59
Below Castle Crag .....	.62
Emerald Valley Citadel .....	.68
Players Map of Citadel .....	.70
Citadel	
Building 1 .....	.72
Building 2 .....	.75
Building 3 .....	.76
Building 4 .....	.76
Building 5 .....	.77
Building 6 .....	.80
Building 7 .....	.80
Building 8 .....	.81
Players Maps .....	.95, 96





## A TREATISE ON THE NATURE OF DWARVES

*(Published posthumously from the notes of Tania Silver Brow, Sage, Baroness of Vac and First Historian of the Court of Thoria, edited by Tarsh, Scribe to the Court of his Most Royal Majesty Ael Hoarfrost.)*

# FORWARD

*(Compiled from the personal notes of Tania Silver Brow)*

The task before me is an arduous one, I fear, and one which may well take more lifetimes than magic can give me, for they (the Dwarves) are a close knit community, slow to accept outsiders, though once given the honor of becoming Dwarf-Cousin, one is accepted fully. I have spent four years now in the kingdom, yet I am still much an outsider. The young ones are freer in my presence, and I have learned from them many of my facts. They impart them to me as they learn them in the schools. I am hopeful that I shall soon be accepted.

\* \* \* \* \*

One of the youngsters has whispered to me that the Council of Wise Ones is meeting to decide whether I may continue living in the kingdom. I am hopeful that they will decide that my demeanor has been worthy and declare me Dwarf-Cousin. I have been here for 13 years now, and, while I have learned much, I must have the trust of, and interaction with, the elders.

The Council of Wise Ones have informed me that I may continue to live in the kingdom. There is no word of being accepted however. It is a bitter disappointment.

\* \* \* \* \*

In the past years, I have noticed that my notes have been disturbed from time to time and have suspected my writings were being read by some court officials. I have not made an issue of this, fearing that should I do so, I would be expelled from the kingdom. Now I am glad that I chose to keep silent. Yesterday, I was summoned to the Council of the Wise Ones, and in fact was honored by being introduced to his Most August Majesty Fyrn Hoarfrost.

He spoke highly of my work, praising my diligence and determination, then chuckled with glee at some of the misinformation that the children had, in a spirit of mischief (rather than viciousness), imparted to me.

His Majesty decreed that henceforth I might have access to the Archives and assistance from the Royal Scribe at such times when he (the Scribe) was not otherwise occupied with other work. I am most grateful for this development and hope that my work will now move more swiftly.

\* \* \* \* \*

Last night at the Feast of Happiness and Sorrow, his Royal Majesty proclaimed me Dwarf-Cousin. He spoke highly of my work and my fair representation of his people, my exemplary conduct since my arrival in the kingdom, and his desire that the august race of Dwarves be better understood by the outside world. I am personally convinced that my rescuing a high-placed official from a Rock Worm recently has as much to do with the honor bestowed on me than all the rest that went before. Regardless of the reason, I am indeed grateful and very pleased. Overnight, my life has drastically changed. I am deluged with invitations and am now greeted with smiles, everyone eager to call me by name and speak with me. I hope, for the sake of my work, that this is only temporary, though I must confess that I have longed for adult conversation these past 123 years.

\* \* \* \* \*

I have lived in the kingdom for 179 years, and have had access to the Archives and have spoken with many learned elders. I have taken several apprentices in recent years, yet I still fear that I will not have time to complete my work, for the years weigh heavily on me and I know that soon I shall be called to my rebirth. I shall be sad to leave, for I have learned to love these warm, generous, and hardy people as much as I love my own, and have even learned to accept the mountain as my home, though I still long at times for the graceful beauty of my native forests. I shall instruct my assistant Tarsh to take on more apprentices to do the more mundane recording and research so that he can spend more of his time working with me.

\* \* \* \* \*

*(From the hand of Tarsh, Silver Beard, Scribe, Journeyman to Tania Silver Brow, Sage, Baroness of Vac, First Historian of the Court of Thoria, Dwarf-Cousin, Beloved Friend of his Most August Majesty Fyrn Hoarfrost.)*

Our beloved Mistress passed to "her rebirth" last night. Under my direction, her work will be completed, as it was her wish and the wish of His Royal Majesty Ael Hoarfrost that this be so. Our beloved Mistress will be greatly missed and long grieved, and our nation is much diminished by her passing.



# CHRONOLOGY

## HISTORY AND CHRONOLOGY OF BARREN RIDGE

FORMERLY KNOWN AS OAK RIDGE

It is currently the year 223 in the reign of Ael Hoarfrost, King of Ostohar. For these chronicles, the start of his reign will be year 1, and all earlier data will be chronicled as BP (Before Present).

### CHRONOLOGY OF BARREN RIDGE

30,000 BP

Dwarves from the now lost city of Goldenforge discovered a vein of mithril at the south end of Oak Ridge. Mining camp of Fairstone established. Early mithril technology begun by mixing it with other metals.

29,500 BP

Wandering Elves, passing through Fairstone purchased mining equipment and supplies. Word spread of the settlement.

29,400 BP

Orcs, Trolls, and Ogres invaded Fairstone. Town is looted and razed.

29,395 – 28,500 BP

War of Retribution: Dwarves, Gnomes, Halflings, Centaurs, and the people of the forests (Pixies and Leprechauns), and some humans fought invading hordes of Orcs, Hobgoblins, Goblins, Trolls, Gnolls, Minotaurs. Elves withdraw from the area.



28,450 – 28,000 BP

Fairstone rebuilt. Mithril technology progresses as Dwarves learn to stiffen it using powdered carbon and garnet. It no longer must be melded to other metals.

28,000 – 17,000 BP

Golden Age of Mithril: Veins of mithril exhausted and expeditions search for new veins.

17,437 BP

Orcs hold Fairstone under seige while an army approaches Goldenforge. A sudden earthquake destroys Fairstone and collapses the wall protecting Goldenforge. Orcs overrun Goldenforge and loot most of the city. A second earthquake destroys the entire valley where Goldenforge is located and many Orcs.

17,435 BP

Dwarves appeal to the Elves for help, but the Elves refuse to send assistance. Dwarves force northward. Orcs, fearing Elven complicity, burn the great oak forest covering the Ridge.

17,435 – 17,421 BP

Fairstone Dwarves tunnel northward and strike another mithril vein. Hero of this period was Anor Ostohar, the mining expert who convinced the Dwarves to tunnel and not retreat northward. Ostohar founded as a subterranean mining village.

17,364 BP

Anor founded as a Dwarven trading post with a highly defensible position. Location of Ostohar is kept secret.

17,000 – 9,400 BP

Age of Expansion: Dwarves spread out from Anor to found settlements in Misty Peak (North Station), the Rosy Crags (Sundown), and the hills on the northern edge of Yellow Grass Swamp (Greymarsh).

Sporadic clashes with Orcs and men. Great oak forest again covers the Ridge. Elven Druids move in. Peace reigned for many thousands of years.

9,397 – 9,391 BP

Druids assist Orcs to build an army. Arborents (animated trees) rebel and are held hostage. Greymarsh and Sundown destroyed and Dwarves enslaved.

May 16, 9131 BP

One Day War: Army seiges Anor and demands surrender of town. That night, as Druid and Orc leaders meet to plan the final assault, a solitary mithril boulder is fired from a catapult and lands in the command tent. The shattering of the boulder and the delayed fireball cast upon it killed all the leaders. Simultaneously, Dwarven armies from Ostohar, North Station, and Anor surrounded the Orcs and slaughtered them all.

Heroes of the One Day War were Balkan Bloodstone, the Dwarven smith who built the boulder, honored as the greatest smith of all, Grim Firmaxe, the General of Ostohar who devised and co-ordinated the plan of attack, Rynn Farseer, a lieutenant in the militia who fired the catapult shot, and Alain the Red, the human magic user and sage responsible for the Fireball spell.



9,390 BP

Destruction of the great forest on Oak Ridge by the Dwarves. All Arborents and forest creatures moved to other territory. Alain used magical fire to kill all plant life on the ridge and spells were used to check the growth of trees and bushes. To this day, only the hardiest of grasses grow in sparse patches on the ridge. Area renamed Barren Ridge.

9,390 – 9,300 BP

Sundown and Greymarsh rebuilt and strengthened. Yellow Grass Swamp drained and a new forest planted for displaced creatures. No oak trees or mistletoe are allowed.

9,287 BP

Ostohar established as a fortified town for guild training of Dwarves. Also serves as chief military training base. Anor continues to serve as Dwarven capital.

9,280 – 2,835 BP

Period of peaceful co-existence in Barren Ridge and surrounding territories. By the end of this period, most guilds had relocated their main offices to Ostohar. Entrance level designed and completed. Outer city expanded; second wall built.

2,835 – 2,832 BP

Nomads from the western steppes and Frozen Waste attacked through the Frigid Pass. Choosing to conquer by the sword rather than opting for a peaceful

co-existence, they forged steadily southward. One unexpected benefit was that the Orcs in the Northern Marches were crushed, as the nomads spared no one.

2,831 BP

North Station, Greymarsh, and Anor fall to the nomads. King Rudo Dreadnought was forced to relocate his capital to Ostohar, and was chased by nomads the entire way.

2,831 – 2,777 BP

Siege of Ostohar: Nomads claim all the Dwarven cities in the area. Wintercone Forest not attacked since a group of human druids led by Sigrid Furfeather moved in and repelled the invaders.

The siege only enforced the Dwarven resolve to develop Ostohar into a completely defensible city. Work started on what is now the third level.

During this period, many Orcs began to appear, recruited mainly for the army laying seige to Ostohar.

2,776 BP

The Hammer, the Anvil, and the Flame: The Ostohar army, led by Manfo Axehaft broke into the seiging army one spring evening. Simultaneously, a force of Druids, Arborents, and other forest folk under the leadership of Georg Fullmane, a Centaur, attacked from the Yellow Grass Forest. In a battle that lasted three days, the Dwarven army held their advanced positions as the trapped enemy of Orcs and nomads attempted to smash their way through to freedom. The defenders held fast despite suffering heavy losses and were later nicknamed the "Anvil."

The Centaurs were everywhere, inflicting great damage upon the invading army, and thus earned for themselves the name of "Hammer" for the pounding delivered to the enemy.

Greatly disheartened and demoralized after the massive losses they had sustained, the nomads dispersed. The Dwarven army moved north through nomad lands, again enacting a pincer movement with the Gnome armies moving down from the Rampart Mountains to the north. The Gnomes would suddenly appear, attack, and vanish when the enemy tried to counterattack. They earned the nickname "Flame."

In the meantime, the Dwarven "Anvil" kept pressing northward supported by the forest army. All nomads who had started farming the land and would swear loyalty to the King were allowed to remain. All others were forced northward out of Dwarven lands. Within ten months, all invaders had been driven out. (Nomad villages still exist today in Dwarven lands; Fin and Oasis are remnants of older villages established after the nomad retreat.)

2,775 – 2,692 BP

Cities of North Station, Anor, and Grey Marsh rebuilt. New veins of mithril discovered under Ostohar; adamantine discovered under North Station.

2,691 BP

Guild of Miners, Stoneworkers, and Underground



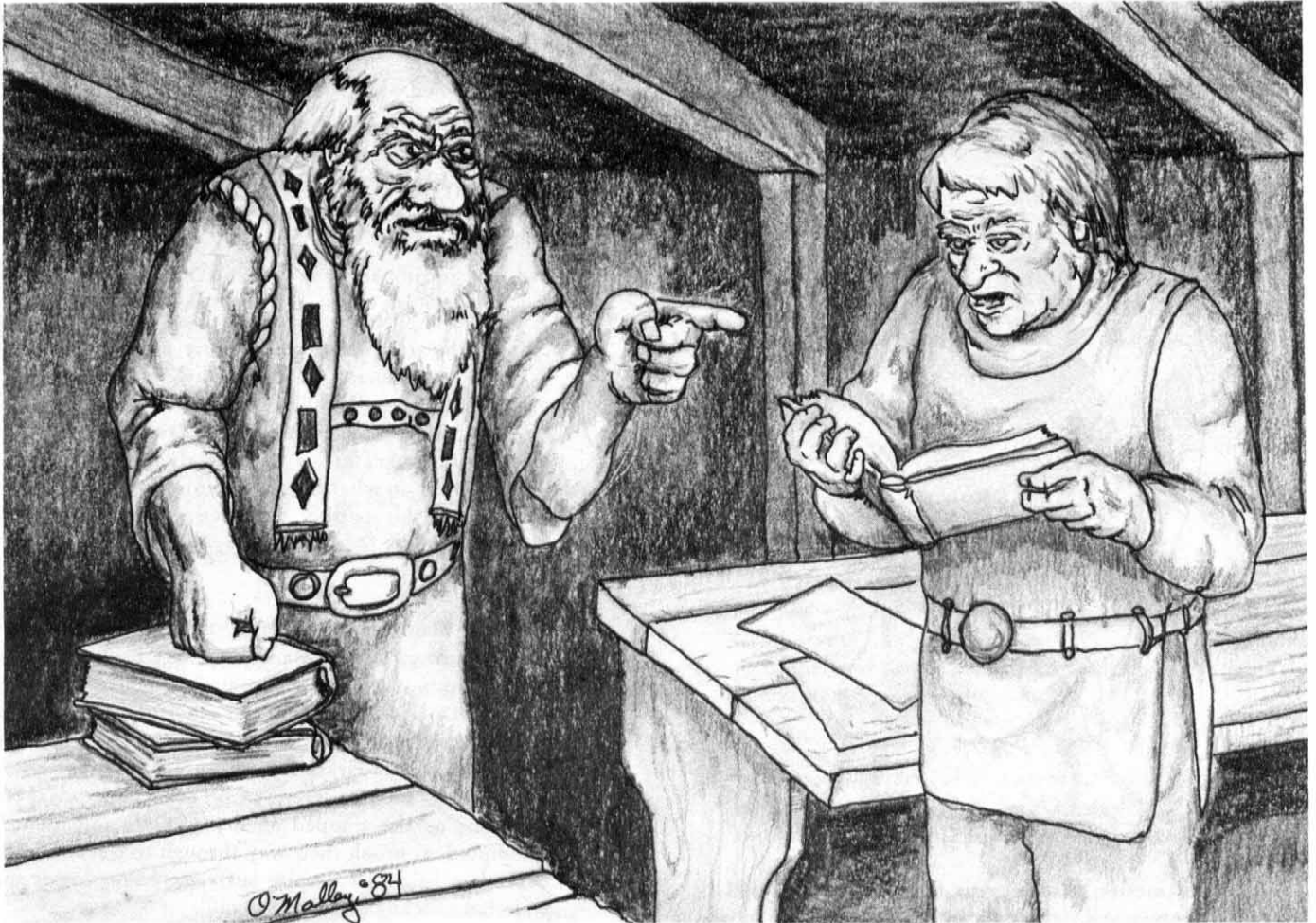

Construction Workers opened a school and offered a structured series of courses to teach stoneworking (mining) to any Dwarf who was interested. Interest was the main requirement for the free education. Students were expected to work the mines to assist in paying the cost of their education.

2,690 – 2,143 BP

Rising Star of Education: With peace seemingly assured, the other Dwarven Guilds followed the lead of the Construction Guild and founded schools for general training. The smiths, jewelers, weavers, butchers, brewmasters, armorers, musicians, and even, eventually, the military all opened educational institutions.

2,142 BP

King Hengo Stoutarm ordered the formation of the first general educational institution in Anor. All the guilds would provide teachers and Dwarves could get a complete, unbiased education.

At this time, Anor was a second-rate trading center. King Hengo hoped to raise its importance and level of wealth by turning it into an educational center. It took ten years to get the school built and almost seventy years to get all the guilds to agree to the new system of education.

2,101 BP

Invasion of Frozen Waste: Orcs and nomads from the Frozen Waste laid siege to North Station. King Hengo led an army north to smash the invaders and, as they closed in, the invaders retreated into the wasteland. Eager to finish his foes, Hengo led his forces into a trap. Over 80% of the Dwarven force, including Hengo, were slaughtered.

The invaders returned to North Station but were routed by a second army, this under the command of Luis Rockstrider, Duke of Sundown. The Dwarves were supported by men from the towns of Fin and Oasis, who also feared destruction if the invaders were successful.

2,090 – 2,050 BP

Level 3 of Ostohar completed. Blast furnaces start operation. Large-scale production of armor, weapons, and implements begins.

2,047 – 1,982 BP

Local schools founded in Sundown and Ostohar. Education continues to play a more important part in the development of Dwarven way of life.

1,947 BP

Following an ancient manuscript, a party of

adventurers located what they believed to be the lost city of Goldenforge in the depths of the Lake of Tears. The depth of the lake did not allow them to recover any great treasure, only what they could reach with dragnets.

King Luis Rockstrider declared the area sacred and forbade any further scavenging. A military post was established on the shore to insure that treasure hunters were kept away.

1,633 BP

Dwarven Patriarch Oovra Droom slain in his sleep by a renegade band of Dwarven assassins posing as holy men. Church of All Gods was stripped of all valuables.

King Robane Grimhand summoned the Dwarven nobility and their children and told them it was their duty to avenge the death of Oovra Droom. The King led the troops after the murderers and, after a three month chase, captured them. All the goods were recovered and the assassins tried, found guilty, and executed.

1,476 BP

King Michal Brownbeard ordered an expedition into the Lake of Tears for evidence of Goldenforge. Explorers found only a few small statues, obviously of Dwarven manufacture. The expedition failed when a sudden storm capsized the boat, drowning all aboard. This occurrence was seen as a bad omen and the project was abandoned.

1,200 BP

First recorded instance of a non-Dwarf being trained in smithing at Anor. Though the man was a close friend of many Dwarves, it caused so many disagreements that the practice was stopped. Georg Pattery, the pupil, went on to become one of the greatest human smiths.

989 BP

Orcs, Trolls, and Hobgoblins invade from the southeast and attack the village of Oasis. Led by the Death Moon and Splintered Finger Orc tribes, the army sacked the town and headed for Grey Marsh and Ostohar.

A hastily assembled army under the leadership of Count Erno Treesplitter clashed with the Orcs on a plain outside Greymarsh. Suffering only light casualties, they routed the larger force and pursued them north past the town of Fin. There, the Orcs disappeared into the mountains and pursuit was called off.

645 – 589 BP

Elf King Legorian the Lawgiver demands tolls and fees for allowing the Dwarves passage on the roads they maintained through the forest. Human and other Elven caravans were already paying tolls. Dwarves refuse on the basis that the roads had originally been built by them.

Sporadic clashes between Dwarves and Elves continued as Elves would attempt to close the roads to Dwarven traffic. Conflict finally ended when King Oleg Firmfast sent an army comprised of woodcutters and smiths to the forest to cut a new road. The Dwarves built about 12 miles of road when the Elves finally relented their demands. Having the upper hand, King Firmfast demanded an annual tribute from the Elves in the form of timber. The Elves agreed, but requested a favored status in the trading for gold and jewels. The Dwarves approved of this plan and Elves were invited to Ostohar to oversee the Elven end of the bargain. Elves have lived in Ostohar ever since – though only in the outer city.

462 BP

Last recorded incident of dragons attacking Ostohar: A pair of Blue Dragon heads can be seen mounted near the King's throne in Ostohar.

250 BP

Fyrn Hoarfrost, father of Ael and Gran, crowned King of Ostohar on April 24th.

134 BP

Tania Silver Brow, Half-Elven Sage, visitor in the outer city Ostohar, foils assassination attempt on the life of the Master Cutter of the Jeweler's Guild, a member of the Dwarven Nobility. In appreciation, her request to reside within the mountain city of Ostohar is granted. She begins her work on the compilation of information on Dwarven life.

40 BP

Gran, brother of Ael, disappears.

0

Ael Hoarfrost crowned King of Ostohar on July 12th.

45

Tania Silver Brow, now "Dwarf-Cousin," dies, leaving the completion of her life's work to her Dwarven assistant.

73

Kirie Axehaft made Duke of Anor, Lord of the Murkey Mountains.

115

Firespitter erupts violently, causing earth to tremble and crack. Clouds cover the sun for four months.

223 (Today)

Dwarven Rite of Oovra Droom called for what may be the last time.



# LIFE IN OSTOHAR

## DWARVEN HOMES IN THE MOUNTAIN

When the Dwarves first moved into the mountains following the great wars, living conditions were poor at the very best. Much of the population died in the first few years for lack of nourishment and proper living conditions, but the Dwarven spirit could not be extinguished. The survivors toiled on to create a home within the mining tunnels they had moved into.

At first, the homes were located along abandoned mining shafts. As conditions improved, the people concentrated on planning for a city which could accommodate population growth and the newly flourishing guilds.

Today, the homes are carefully planned well in advance to utilize space to the fullest while remaining pleasing to the Dwarven sense of order. The practice of extended families living together still exists, and most homes house at least three generations.

All the pre-adolescent children sleep together in a small bedchamber, with larger areas allotted to each older child. Each couple or single adult has a private bedchamber; the adult Dwarves each oversee the activities of the adolescent children each night on a rotational basis.

Though Dwarves spend much time preparing food in the kitchen at the back of the house, the most important area in the home is the large front chamber, the common area in which much of the family activity takes place. Here company is greeted, the children play and are taught, and recreational activities are conducted. It is a cheery, comfortable room, in a perpetual state of disarray which is never viewed as slovenliness, rather as a sign of a happy, active, and loving family that enjoys each other's company.

Commonly, furniture is carved from rock, and covered with whatever decoration the family's wealth can provide. It may be covered with woven cloths, furs, skins, tapestries, or inlaid with elaborate designs made of wood, ceramics, gold, silver, platinum, or jewels. Since giant mushrooms have been successfully raised, more modern furnishings have been carved from the dried flesh of the great fungi, and many homes now have tables, chairs, stools, and various other items of furniture from this lightweight wood substitute.

Wealthier families and the families of wood carvers often import wood from the outside and cover the rock floor with wood over a hard packed dirt floor. Some furniture may also be carved and built from wood, but due to its scarcity, it is not commonly seen. Woodcarvings and furniture are extremely expensive.

## COURTSHIP AND MARRIAGE CUSTOMS

Courtship among the Dwarven people is taken very seriously, and is never a subject of humor as it is in other lands. Courtship is usually, though not exclusively, initiated by the male with the sending of small gifts by way of a messenger to the lass of his affections. If the gifts are

accepted, he then calls at her home and extends an invitation to some recreational event, often held in one of the parks or local inns. If after a suitable period, the courtship appears to be progressing well, the young couple dine at each other's homes so that they might meet the other's family. If all goes well, their engagement is announced by the posting of banns. Preparations begin for the upcoming nuptials. First, clerics of both individuals' patron gods are advised of the upcoming marriage, and a suitable hall is reserved for the celebration. Both families begin baking and cooking a great feast soon before the wedding, preparing for the several hundred relatives and close family friends who were asked to attend.



On the wedding day, the young couple appear before the guests and pronounce oaths of marriage in the old tongue, begging their patron deities to intervene on their behalf with all the gods for a happy and fortuitous married life. Upon the completion of the ritual words, the couple holds hands while the clerics tie a silk cloth about their hands, the breaking of which signifies the completion of the marriage ceremony.

After the ceremony, a great feast begins, with food and drink aplenty. Entertainers of all types, games, contests, and general merrymaking occupy the crowd until both bride and groom are wearied to exhaustion, and attempt to sneak away. Here begins the merry chase of the couple by all their assembled friends and relations. The young couple is chased throughout the city until they are caught, and carted off to their individual family homes, with mock warnings that life is long, and there is no need to rush.

Sometime late in the night, the bride and groom make their respective escapes and meet each other in their new home (often this will be in the home of one of their parents unless both families are so large that there is no room and they must start their own home).

There are no restrictions among adults regarding marriage, though marriage outside the tribe is frowned upon. Inter-tribe marriages are usually arranged by wealthy merchants who have dealings with one another and who wish to bind the spirit of goodwill between themselves, or to form political alliances.

## THE EQUALITY OF THE SEXES

The consensus among historians is that the independence shown by Dwarven women stems from the intense competition for students by the various guilds during the years 2,690 - 2,143 BP. Women were freely accepted in order to fill the schools and, as enrolled students, were allowed advanced educations. Once educated, they were accorded the same rights and privileges as any adult male Dwarf. Dwarves today think it is natural for males and females to be accorded equal privileges, rights, and obligations.

## DWARVEN FAMILIES

Dwarven families live in extended family groups of three generations or more, if possible, splitting up only when further home expansion becomes impossible. Each home is presided over by the eldest female. This matriarch oversees the needs of the family, arbitrates family disagreements, and acts as advisor, teacher, and final family authority. This would provide the matriarch with great power should she choose to wield it. However, contrary to what one could expect from this type of situation, it is found that the matriarch will seldom interfere or give advice unless asked. This restraint appears attributable to the great respect that Dwarves have for individual privacy — a concept without which any people living in close quarters would soon perish.

Child rearing is a joint family occupation, not the sole responsibility of the individual parents. Within the framework of an extended family, there are usually several married couples living in the home. Their children are cared for by all of the adult family members in a rotation. In this way, each child has several mothers and as many fathers and calls each by that name, reserving the titles (literally translated from the Dwarven language) Birth Mother and Birth Father for his own parents. In this manner, the family begins to teach the child respect for authority, elders, family, tribe, clan, and kingdom.

The early years of a child's life are spent in the home learning their language, family relationships, proper behavior toward family and non-family members, family history, and, naturally, spending a great deal of time playing with his/her siblings. Throughout this period, and throughout life, children learn that they are equal whether male or female and are expected to learn the same things. Although the society is primarily matriarchal, females enjoy no special privileges, nor do males learn to treat them in any other manner than as an equal.

When children are proficient in language and have learned basic behavior patterns, they are cared for in large communal schools that allow them to interact with older and younger children who are not related to them. It is here that the histories of clan and kingdom are taught through song and poems by the older children. By bearing much of the responsibility for taking care of the young ones, the older children learn more of childcare than they were exposed to at home.

At about age 30, the child serves a ten year Pre-Apprenticeship in the family's guild, thereby promoting the continuity of the family profession. After the Pre-Apprenticeship, the next twenty years are spent in shorter stays in all the other guilds so that a child not suited by temperament, talent, or desire to the family guild can search for a rewarding occupation. At about age 60, the individual makes his decision to enter a certain guild, and begins his formal education.

During the Pre-Apprenticeship training, the youth are also required to participate in battle training, and serve numerous, brief tours of duty in the barracks and on guard duty. Individuals desiring to enter the military may not do so until they have completed the two Pre-Apprenticeships. At that point, they may choose military instead of guild training.

## FOOD

The main source of food in the mountains is derived from edible fungi and animals indigenous to the surroundings, although a wide variety of surface animals have been successfully bred underground. Giant mushrooms, standing 6-12 feet tall, are grown in great caverns and supply a large portion of the Dwarven diet. The mushrooms, when allowed to grow to their full 12 foot height, are also utilized as a substitute for wood, and their outer skins can be cured into a thin leather.

The main source of meat is from cavern crawlers, a domesticated tentacle-less cousin of the carrion crawler which often reach a length of 10 - 12 feet. In addition to providing large quantities of tasty meat, they are also used to haul up the miners and their finds from the many deep shafts that are being worked.

Underground rivers and lakes provide a limited supply of an eyeless fish which, though bony, provides a delicious festive meal. Fish skeletons provide fertilizer for the small root cellars of horseradish and other roots that are the favorite side dishes of all meats. Ever increasing numbers of fish are being bred, and within a few years, fish will become a staple rather than a holiday meal.

Rabbits, squirrels, hens, ducks, and pigs have also been bred successfully within the mountain, and now supply a goodly portion of the daily fare at dinner tables. Most recently, goats have been introduced, and are proving quite adaptable as well.

No meal would be complete without a liberal helping of Dwarven ale. Their common ale is rough and potent. A second form of ale is the throat-wrenching Csarg, a byproduct of a common rock moss, which is served only at special occasions.



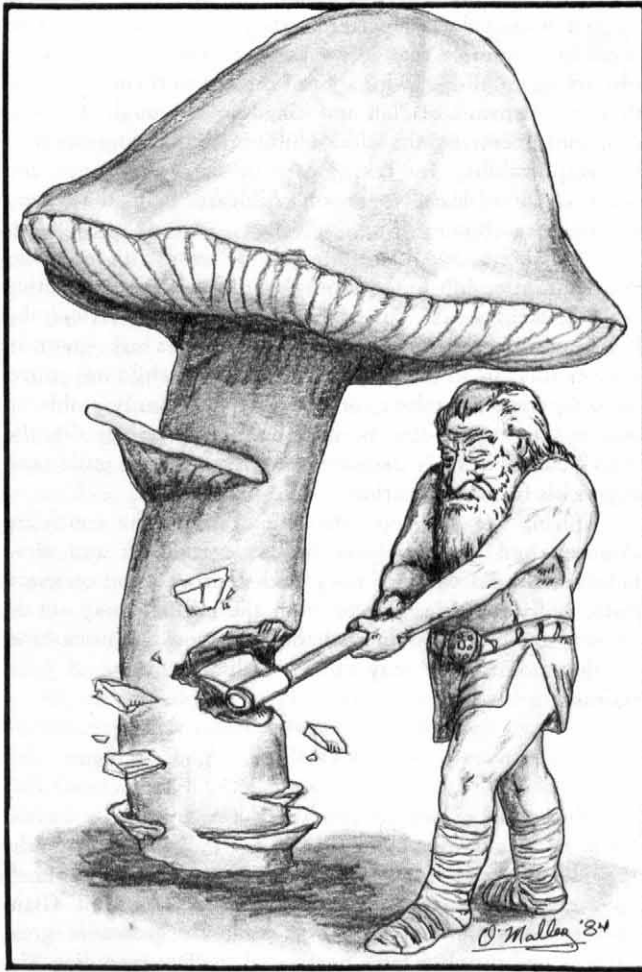

### ILLNESS AND HEALING

Common ailments are treated with a wide variety of herbal and alchemical remedies in the forms of salves, unguents, potions, poultices, and infusions. If the more mundane cures are not adequate, Dwarven clerics are called in.

A closely guarded secret is the manufacture of superior healing potions using Dwarven Moss as one of the main ingredients. Potions distilled from this moss yield the same effects, but the yields are doubled. Properly treated, dried moss will cure 1-3 hits immediately for every 2 ounces eaten. If placed on an open wound in a poultice, it will clot the blood and promote a quicker rate of healing (half the time required).

### LAW, JUSTICE, AND GOVERNMENT

The government of the kingdom is in the hands of an elected king. Upon the death of a king, the nobles debate, listen to the council of the Wise Ones, then choose a new successor from among the eligible nobles. In order to convene for a vote, 2/3 of all the nobility must be present, and in order to pass a vote, a 2/3 majority is needed. The new ruler may be either male or female, related to the former ruler or not. Of greatest importance is that he or she be competent to take on the burden of ruling the land wisely.

Low Justice is handled by the individual who feels he has been wronged by publicly posting a notice of injury for three days. If during those three days, the accused wishes to deny his guilt, he may convene a Tribunal of 30 citizens chosen by lottery to hear his case and the accusers testimony. If the Tribunal finds in favor of the accused, the matter is thus ended. If the Tribunal finds in the favor of the accuser, or if the accused has failed to call a Tribunal to plead his innocence, the accuser may then exact his justice in type and kind keeping with the crime. For instance, if the injury was theft, the punishment is confiscation or payment in the amount of stolen property (or recovery of the property), and cutting off the thief's hand. Care must be taken, for should the thief die as a result of the removal of his hand, the accuser stands guilty of murder.

If punishment is exacted, and is seen to be too severe, or if there is doubt as to the truth of the injury as stated, the punished individual or his family may yet call a Tribunal. If the Tribunal finds in favor of the accuser, there ends the matter. If however, the Tribunal decides that the accused is innocent of the original charges or that the punishment exacted from him was too severe, then the accuser must suffer the punishment he meted out twice-fold.



A second or third offense is a matter for High Justice, as are all cases of child neglect or abuse, murder, arson, rape, or treason. A second offense is dealt with by exacting justice twice. Both expulsion from any Guild to which the accused belongs and banishment are common. A third offense (an almost unheard of occurrence) is also taken to

High Justice where upon being found guilty, a sentence of death is mandatory and a public execution is ordered.

In matters of Low Justice, the accused may appeal for High Justice only if he had requested a Tribunal during the three day grace period.

High Justice is decided by the Wise Ones, composed of the Elder of each tribe (Guildsmen and Nobility alike). Ultimate appeal is to the King, for only he has the power to overturn the decision of the Wise Ones.

While justice appears harsh, it is a system that works quite well for the Dwarven people. Perhaps this is because these people are not by nature law breakers and have great respect for one another. Or this may be because the law is so harsh that one doesn't contemplate crime for fear of the penalty. While an offender may be banished or even executed, no stigma touches his family. Each individual is responsible for his own fate and the family reputation is in no way marred by his act.

### DWARVEN CREEDS

Four major creeds are held inviolate by the Dwarves and over-ride all other laws and considerations. First, "Dwarven life is respected above all else." Second, "Justice for all, in all aspects of life." Third, "Work in a spirit of service is worship." Fourth, "Respect the privacy of another as you would your own."

Based on the above, one can see why Dwarven society is little troubled by thieving, for no Dwarf would steal from another. To do so would be a violation of their basic creeds. Further, the taking of a Dwarven life without cause, infringing on the rights of another, or intruding on another's privacy are also violations of the creeds and are more strictly enforced than the written laws. A radically different standard applies to the treatment of Dwarven enemies.

Finally, Dwarves are not regularly to be found worshipping gods except on their holy days, or at times of special need or thanksgiving. This is a custom not shared by other peoples, but one which is understandable in view of their third creed "Work in the spirit of service is worship." This creed also explains the very painstaking custom of the two Pre-Apprenticeships that all adolescents undergo before they may choose a profession, for while a child is encouraged to perpetuate the family trade, he must have the freedom to choose another trade if it is more pleasing to him. The satisfaction achieved by being able to do one's job well and in a spirit of service is of prime importance to Dwarves.

### DWARVEN THIEVES

Dwarves who steal, break into homes, and backstab victims have no place in Dwarven society. However, the natural affinity of Dwarves for gold, jewels, and other valuables lead some toward the path of evil. Many of the skills developed by thieves have been found to be commercially valuable resulting in the Thieves Guild operating openly in the cities of Anor and Ostohar. While the Dwarven Thieves Guild will acknowledge that ordinary, pocket-picking thieves exist, they refuse to allow themselves to be held responsible for the actions of others.

Normal thieves learn early in their training that it is very, very unwise for Dwarves to steal from Dwarves. Any thief caught in the act with the stolen goods (and failing a Detect Lie spell) does not have much of a future. Recurrent thieves are immediately tried by High Justice and those convicted are sentenced to death or long periods of hard labor. The sentences handed down vary depending on the item stolen and the number of previous offenses, but all are harsh. The usual tactic used by city thieves is to pull a job and then rapidly depart from the city; too many Locate Object spells have resulted in the permanent removal of thieves.

Many Dwarves have openly marketed skills or products resulting from skills learned in the Thieves Guild. Dwarves are reknown as trap removers and solvers of intricate puzzles. Many Dwarven thieves from Ostohar are hired for trap removal by adventuring parties. Similarly, anyone wishing to place traps in his wine cellar, dungeon, etc. must consider the advantages of hiring the best expert available. Dwarves charge dearly for their work, but they deliver custom traps that are almost impossible to spot and difficult to remove. Also, once a Dwarf has completed a job, he guarantees that no one will be told the details of the traps set. Traps constructed range from pits to sliding sections of walls; from intricate locking mechanisms in chests, doors, or storage boxes to trapped jewelry boxes that explode if not opened correctly.

Scouting is another valuable skill possessed by Dwarves. Their ability to find a hiding or observation position by blending into the countryside more than compensates for their slower movement. Also, the ability to assess the fortifications of the enemy and assist in planning their penetration in the most efficient way makes Dwarves scouts a very valuable commodity. Dwarves will train scouts, including those of other races who can afford the stiff entrance fee, in their guild halls in Anor and Ostohar. Many scouts are available on short notice, but payment up front is essential.

### DWARVEN SMITHS

**UTILITARIAN SMITHS** make normal implements: plows, spikes, grappling hooks, pots and pans, kettles, etc.

**PRECIOUS METAL SMITHS** fashion small items of precious metals, cast jewelry, rings, brooches, etc., and perform precious metal inlay work.

**JEWEL SMITHS** cut stones to increase their value and set jewels in jewelry and other items for decoration.

**MAGICAL SMITHS** are trained as clerics as well as smiths. Elaborate rituals are involved in the forging of magical items, and the devoutness and humility of the smith has a great bearing on the potency of the weapon, armor, or other item being manufactured.

An individual desiring to become a Magical Smith begins as a **Graduate Smith**. For this, he does not as yet need clerical training, though he is encouraged to begin as he cannot progress further until he obtains this training. At this point, he can make only normal weapons or armor.

When he has completed clerical training and has served



his time as a Graduate Smith, he may move on to become a **Senior Smith**. At this stage, he is assisted by an Alchemist and a Cleric, and he can now manufacture the equivalent of a +1 armor or weapon. The item, in fact, is not magical, but is tuned to Dwarves so strongly that it is the equivalent of a +1 item. These items will not give bonuses to other than

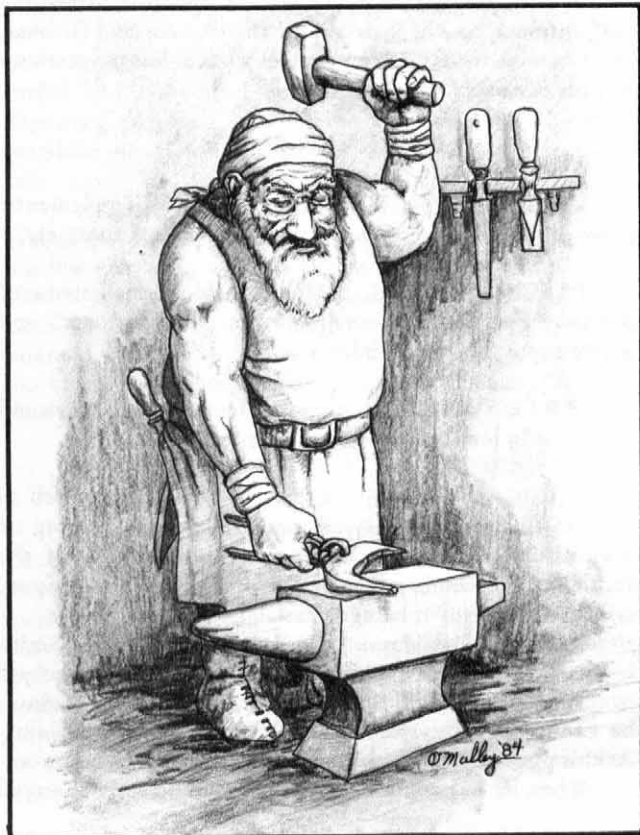

Dwarven users or wielders.

Upon completing Senior Smith training, and having reached skill 3 in clerical training, the individual must petition both King and Church to be allowed to advance to **Training Smith** level. If approved, he then is assisted by an Alchemist and a Cleric, but now he is able to create magical +1 items.

Advancement to **Master Smith** level is again possible only by permission of King and Church. At this level, he is assisted by two Alchemists and three Clerics (while he himself has reached skill 5 as a Cleric), and can manufacture +2 items.

Upon completing training as a skill 6 Cleric, he may once again petition King and Church for promotion to **Senior Master Smith**, in which position, he would be assisted by four Alchemists and four Clerics, and can manufacture up to +3 items.

The final stage is **Smith**, again only attainable by appointment of King and Church. If approved, he will be assisted by 6-10 Alchemists, 6-8 Clerics, and 2-5 Magic Users (non-Dwarven). The Smith can now manufacture minor artifacts (only one or two Smiths per century reach this level of skill), and weapons and armor with special abilities.

The typical composition of the Magical Smith Guild is approximately as listed below:

50%	Graduate Smiths
30%	Senior Smiths
10%	Training Smiths
4%	Master Smiths
4%	Senior Master Smiths
3%	Smiths

## JEWELS, GEMS, AND JEWELSMITHS

All Dwarves are enamored of precious stones and metals. Skilled jewelers can vastly increase the value of these raw materials by transforming them into items of breathtaking beauty.

Most Dwarven jewelry is distinguished by its massive size and elaborate design. Bracelets, rings, and armbands are carved from a solid block of gold or platinum, inlaid with jewels, and carefully fitted to the purchaser. All jewelry worn by Dwarves is custom designed; the mass-produced jewelry is sold to outsiders. Even these items are in great demand, for no other jewelers can match their quality.

Since Dwarves love large, impressive pieces of jewelry, one is impressed by the finesse developed by some goldsmiths and armorers. Their necklaces and chainmail are very flexible and are constructed of tiny links that are almost invisible to see and impossible to break.

Dwarven jewelersmithing is epitomized in the Royal Crown, Septre, and Orb. Dwarven smiths labor for years to create the ultimate expression of devotion to each new king. Each item is exquisite, brilliantly reflecting light of many colors from the hundreds of gems that are imbedded in a fine, nearly invisible filagree of mithril.

Between the gems, threadlike spires of gold and platinum emerge to encase the whole in a fine spiderweb of precious metal. They are indeed the finest examples of the jeweler's art.



## DWARVEN TRAPS

Dwarves seldom use traps as they consider them a cowardly way of dealing with intruders. Many Dwarven stonemasons and sappers are quite skilled in the construction of traps, and their services are quite in demand by other races.

The most common form of trap is the pit. Dwarven pits may or may not have a cover, are usually 15-25' deep and have upper walls that slant upward toward the opening, making egress very difficult. In some cases, the overhanging walls are designed to collapse into the pit, crushing the victim, if an escape is attempted.

Probably the finest Dwarven trap is the multiple rock fall. Several chambers are drilled into the ceiling, filled with rocks and then sealed again on the bottom. Each chamber, and there may be many of them, holds almost 500 pounds of rock. Each set of rocks cascades down upon an intruder when a concealed trip mechanism is activated.

Dwarves also construct sliding and rotating walls, spear traps, arrow or bolt traps, and net traps. They are also quite adept at making locking boxes and chests with extremely intricate locking mechanisms.

A small percentage (3-5%) of all Dwarven traps are magical in nature. The assistance of a Magic User is required to prepare exploding boxes, cursed weapons and armor, and anti-gravity traps. Gnome Illusionists often assist in the fabrication of traps that will conceal or disguise the true nature of an item or an area. Dwarves dislike using clerical spells for traps and will use this magic only if it is the only alternative or if the payment offered is extremely high.

## RACE RELATIONS

Dwarves, as previously mentioned, live in large extended families and have special feelings and attitudes toward their blood and married relations. All other Dwarves are treated with respect and dignity, since it is assumed that all Dwarves follow the same creeds. As might be expected, Dwarves of an evil nature do exist, but if they perpetrate crimes against other Dwarves, justice will be swift. It is said that Dwarves judge others less harshly than they do other Dwarves.

Humans are viewed as large capricious Dwarves who, while professing to follow many different creeds, can generally be counted on for support in times of need. Many fast friendships have sprung up between individual Dwarves and humans.

Elves are viewed with circumspection. Too often in the past, when the Dwarves found themselves in need of assistance, Elves declined to send aid. This attitude of non-cooperation is seen as needlessly selfish and all current interactions with Elves are treated as short-term agreements that may be abruptly terminated. Thus, it is not surprising that very few firm friendships have developed between these two races.

Gnomes and Halflings, on the other hand, are automatically granted the status of Dwarf-Cousin and are readily accepted into Dwarven society. A thriving commerce exists between these races, to the mutual benefit of all. Gnomes and Halflings will be found living in all Dwarven towns and cities. Even the normally peaceful Halflings will rise to assist their friends in times of need.



Orcs, Hobgoblins, Trolls, Goblins, and all other innately evil forms of life are deeply hated and despised by the Dwarves. Chaotic Evil beings, with their diametrically opposed styles of life, are the most hated opponents. If an evil force moves into Dwarven lands, it can be sure that all Dwarves will immediately put aside all lesser tasks and move to expel or destroy this unwelcome intrusion.

## DWARVEN ARMIES AND FIGHTING TACTICS

While the Dwarves are a peace-loving people, more intent upon the execution of their trades, the company of their families, and the entertainment to be had, periods of peace in Dwarven lands have been generally short. Dwarven armies were established to battle the invading hoards who encroached on their lands.

Because of their small (though strong and tough) nature, Dwarven tactics have relied heavily on the elements of surprise, stealth, and the division of an opponent's forces rather than relying on speed or massive frontal attacks. Dwarven generals spend the peacetime years planning for specific situations and, when on the battlefield, they attempt to create the planned-for conditions to make victory possible. While this may take some time to accomplish, the Dwarven people are very, very patient and will always wait until conditions are right.

Dwarves are masters of disguise and camouflage (as well as diggers and tunnelers par excellence), and exasperate their opponents by appearing on a battlefield (seemingly out of thin air) when they are least expected; then melting back into the ground as though they had never existed.

The Dwarven tenacity, as seen elsewhere in their lives, makes them ferocious enemies. Once they have decided on a unified course of action, they will never retreat from that decision. Many an army, knowing of this tenacity, has surrendered rather than try and fight its way through the determined Dwarven fighting forces. Such tenacity makes them doubly formidable on the defensive, as was shown when they formed "The Anvil" in 2776 BP.

Dwarven fighting forces favor certain types of armor and weaponry:

40% - Axe and Shield	35% - Splint Armor
30% - Hammer and Shield	30% - Chain Armor
25% - Sword and Shield	20% - Ring Armor
05% - Archers	15% - Plate Armor

Though seldom seen in open country, Dwarven archers, using composite bows or crossbows, will attack from chariots, disliking fighting from horseback. Dwarves also seldom like to fight alone, preferring to fight in masses. This fact has often been the undoing of their opponents. When thirty or forty Dwarves would appear together on a battlefield, often the troops facing them would retreat, fearing a large Dwarven force was at hand. Most of the time they were correct, but Dwarves have been known to bluff occasionally.

## DWARVEN PAINTING, SCULPTURE, POETRY, MUSIC, AND DANCE

Dwarves use all their art forms to surround themselves with beautiful representations of the rights, privileges, and

obligations possessed by each Dwarf.

Painting is usually exhibited in the form of huge wall murals, though smaller paintings are known to exist. Dwarven artists use paints fashioned from ground roots, lichen, or rare earths that are mixed with cavern crawler fat, eggs, and other natural ingredients.

Brushes are fashioned from the fine fur of squirrels and are used to apply paint to canvas made of cured and stretched skins. Dwarven murals depict victories in battle, scenes of everyday life around the home and events of a historical nature.

While the favorite subject of Dwarven sculptors is the Dwarves themselves, statues depicting dragons and other fantastic monsters can be found. These statues, generally carved in stone due to the scarcity of wood, are so lifelike that visitors have been known to ask if they were once alive. In addition, all columns and exposed public walls are covered with pleasing geometric patterns and designs copied from nature. It is from ancient sculpture that scholars learn about past life styles, costumes, weapons, and occupations.

If a Dwarven sculptor sees an outcrop of rock that interests him, he probably will carve something into it, regardless of the outcrop's location. Many a hardy soul has been taken unaware by a Dwarven head peering out of a bush with a sword held ready to strike, only to discover it to be a statue, long forgotten and overgrown.

Dwarves use poetry in the epic, bardic tradition to relate heroic deeds, great events, and family traditions. Many poems are used in the schools to teach history, behavior patterns, and language. One of the longest epics, composed of several hundred individual poems, relates the fantastic successes and bravery of The Anvil, The Hammer, and The Flame.

The instrumental music of Dwarves is never accompanied by song. Singers perform a cappella. Dwarves explain that each type of music is a separate art form, to be enjoyed by itself. Dwarven instruments include horns, cast by the smiths, drums, built by the tanners, and a unique 40 - stringed instrument called a Fej, that is manufactured from giant mushroom caps which are strung with fine wire. The Fej is played by two or three Dwarves armed with small hammers. The pulsating rhythms produced by these instruments are unaccountably pleasing and perfect accompaniment for the Dwarven style of dancing.

Dwarven dance is less a social pleasure than a reenactment of memorable moments for the past. These dances are fast-paced and require acrobatic skill, great precision, and concise movements. The Dance of the Blue Dragons, an ancient favorite, commemorates the slaying of two renegade Blue Dragons as they attacked Ostohar. It is an awesome spectacle with over 100 Dwarves dancing in perfect unison to mimic the actions of the dragons. The dragons twist and turn in a lifelike manner until finally they are killed and crash to the ground. The dance, accompanied by the blast of horns and the rhythmic throb of drums, is truly a magnificent sight.

Recently, a few Dwarves have been seen performing a new non-representational form of dance from the Gnomes. Its function is not clearly understood and has not gained wide acceptance.

# MAGIC

Among the scholars of Ostohar, there has long been a debate on the nature of magic and how it manifests itself in Dwarves. One school maintains magic is a constant force whose nature is determined by the creature who has it. Based upon this theory, any creature could become a Wizard. This argument is weakened by the fact there has never, in the recorded history of Ostohar, been a Dwarven Magic User. Proponents of the theory argue the Dwarven prejudice is so strong that any Dwarven Magic User would keep his powers secret in fear of his life.

There is no argument about one magical ability, the making of enchanted weapons. This power has been evident in Dwarven Smiths from before the founding of Anor. Most, if not all, of the enchanted weapons found today can be traced to a Dwarven Smith or a Human Smith taught by Dwarves. Dwarves generally distrust magic, but value magical items for their powers. Several magic users will be present in Ostohar at any time, employed as specialists and closely watched to prevent unauthorized use of their powers. Any magic using character entering the Dwarven cities would be wise to keep any displays of magical ability to a minimum.

## DWARVEN MAGIC ITEMS

In their millenia of existence, there have been many magic items created either by the great Dwarven Smiths or for the use of Dwarves. With their strong sense of property, many of these have survived into the current era. The strongwilled, possessive nature of the Dwarves have also led to many enemies whose presence is reflected by the many cursed items designed particularly to punish Dwarves.

### Dwarven Cloak

Usable only by a Dwarf, Gnome, or Halfling, this cloak will allow the wearer to become virtually invisible against any surface of rock or stone. This cloak is 99% effective underground and 80% effective if used in daylight. Any movement, however, destroys the protection given by the cloak and makes the wearer visible. These cloaks are not very rare, but seem to be very ancient in origin. They may reflect back to an era of friendlier cooperation between the Elves and the Dwarves as there is little record of Dwarves working with magical cloth.

### Smith's Forge

Only one Smith's Forge is known to exist, but rumor of a second have caused Dwarven Smiths to travel thousands of miles in the hope of procuring another. This forge instantly heats to any temperature desired and maintains that level for up to three days. The known forge is the property of the Smiths Guild and its use is rare and limited to the production of +3 (or better) weapons.

### Joross' Bellows

Several of these extremely useful magic items are known to be the proud possession of Master Dwarven Smiths. Appearing to be a normal bellows, these function without any exertion by their user. An apprentice need only hold the bottom handle to ensure a steady stream of fresh air pouring from the nozzle. This blast is equal to a "gust of wind" that could be created by a magician. While strong enough to disperse drifting gas, this air has no effect on whirlwinds, dragon's breaths, and the like.

### Ring of Protection Against Bites

This ring gives no magical bonus to prevent a Dwarf from being harmed by any biting creature. It does render the flesh of a Dwarf distasteful and mildly poisonous to the taster. Once bitten, the Dwarf will be actively avoided by the creature who will retreat with literally a bad taste in its mouth. The Teething Ring, as these are called in jest, provides no protection against being consumed whole by a dragon or purple worm. Several of these rings are known to be worn by Dwarves in Ostohar.

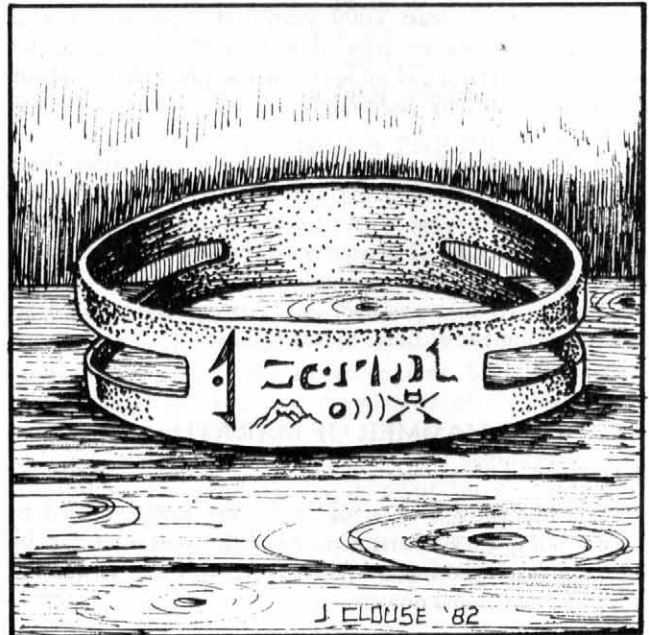

### Ring of Giving

This Ring, when worn, appears to be the type of ring most desired by the wearer (similar to a Ring of Delusion), but it is, in effect, a trap for the greedy. Once placed upon the finger of a Dwarf, this ring causes the character to have overwhelming fits of generosity. There is a 15% chance each day that the wearer will give away half of all the gold and jewels he possesses. This ring has no noticeable effect on races other than Dwarves.



## Ring of Receiving

Originally created for a Dwarven merchant, this ring adds +3 to the reaction roll of any non-Dwarf when dealing with the wearer. If a reaction of 12+ (on 2D6) is rolled, the character being influenced by this ring will agree to any deal offered and feel later that he was fairly treated.

## Helm of Air

Poison gas, released from rock during mining, is the most serious problem Dwarven miners face. Many of these are transparent and odorless, but still deadly. To combat this threat, the Helms of Air were created. These Helms glow redly whenever impure air is detected. Furthermore, it will purify the air going into the lungs of its wearer for up to one hour to allow for rescues. No more than one Helm is ever taken with a crew and the total number existing is less than three dozen. All were created by the same Smith over two centuries earlier and rumors of Helms of Air failing have been common over the last decade.

## Light Sticks

The single most common magic item used by Dwarves is a light stick created in the normal manner by Dwarven clerics. These six to eight inch rods have been enchanted with a Continual Light spell and are used in most Dwarven cities and mines in place of the oxygen consuming torches. Most Dwarven miners carry at least one light stick at all times inside a leather case on their belt.

## Chisel of Clefing

This chisel enables a skilled stone mason to cut through stone at the rate of four square feet per blow. These chisels are used primarily by Master Masons to create the great blocks used in the city walls and the palace. In the hands of an unskilled user, the chisel is 50% likely to crumble the stone being cleft into dust. The chisel functions only on previously unworked stone.

---

# ARTIFACTS

All artifacts currently present in the cities of Ostohar and Anor are at least 2000 years old. The smiths who forged these items are reputed to have been clerics in the service of Mithra, a god no longer worshipped. As details of this god are sketchy and widely differing, many doubt his existence.

The artifacts described below appear to achieve their great abilities by reversing the normal Dwarven magic resistance and turning it into a plus for the artifact. These items work at 50% of capacity for the less magic resistant Gnomes, and deliver a terrible shock (5D12 damage) to any other race. If not specified, any power may be used an unlimited number of times by the wielder.

## HAMMER OF MARATH

*Int: 10*

*Ego: 20*

This hammer is reputed to be the hammer used to create many ancient artifacts. As their creator, it can be used to destroy other artifacts. A +5 weapon, it has the following additional powers:

- ESP at 60' range
- Know Alignment
- Detect Veins (of metal and gems)
- X-Ray Vision
- Lightning Bolt (14D6 damage)
- Control Temperature around wielder (10' radius, +/- 200° F)
- Summon Fire Elemental - once per day
- Create a magical device up to +4 - once per year
- Any evil creature of less than Greater Demon, Greater Devil, or Diety status will be imprisoned (as Imprisonment spell, but save at -4) for 2-16 weeks.

Non-Dwarves of Neutral or Good alignments will receive 20 points of damage each time they attempt to use the hammer. This damage may not be cured magically and heals slowly at the rate of one hit every two days.

## THE ARMOR OF DUNNOR HALDER

*Int: 20*

*Ego: 15*

This finely crafted suit of plate mail was worn by the leader of a renegade band of mine Dwarves. This +5 armor has a magical cloth jerkin which, when worn gives the wearer complete immunity to fire above the waist and a +4 save below the waist.

Rumors say that a great evil power took control of this item, causing its wearer (the leader) to rebel against normal Dwarven standards. A symbol of this force is thought to be engraved on the armor.

This weightless armor reputedly has the following properties:

- Cure Light Wounds, equal to wearer's stamina - two times/day
- Water Repulsion upon command, up to 5' from wearer
- Fire Shield for up to 10 dice of damage; half damage thereafter
- Wearer goes berserk in battle (20% chance per round) lasting 2-24 rounds with no saving throw
- Summon Demon into 24 hour service - once per week\*
- Commune with any evil god, demon, or devil - once per month\*
- Wearer has a consuming hatred of all Gnomes and Dwarves of Good alignment.

\*a sacrifice of an enemy (or friend) is necessary before invoking either of these two powers

## THE SWORD OF TANORTH GAMBAL

Int: 14

Ego: 11

Bards still sing of the destruction of the invading nomads brought about by this marvelous blade. Leading his men into battle, Duke Luis Rockstrider is said to have discovered this weapon at his side, his own weapon missing.



The battle that followed was the most successful in Dwarven memories; morale was never higher, strategy never better, and victory never easier.

This 4' two-handed sword has grips of enchanted ironwood and a blade forged of an unknown mithril-adamantine alloy. Runes are deeply etched in the blade, which flames when it is drawn.

Known powers of the +3 to hit blade are:

Wielder's appeal and military ability are raised to maximum.

Wielder is completely immune to Fear, Charm, and Hold spells.

Disintegration Ray (as a skill 10 Magic User) every other round versus evil creatures only

Damage from weapon is 4-40 (no strength bonus)

Magic Resistance granted to wielder equal to combined intellect, insight, and appeal.

Whenever the user of this item takes fatal damage, the weapon will sustain him long enough for a final blow to be struck. This final blow always hits and delivers maximum damage. This final strike is indeed final, for the character is afterwards permanently dead. The sword then teleports away, seemingly to be found when needed.

## THE MIGHTY AXE "SEJM"

Int: 15

Ego: 19

This axe was created by Balkan Bloodstone during the Age of Expansion. To this day, it has remained the property of the Dwarven King and has served the Dwarves well. The major powers for this weapon remain constant, but the side effects are different for each owner. This axe is very Chaotic Good and may only be used by characters of the same alignment; all other non-chaotic or non-good characters take 40 points damage (no save); others take 20 points (no save).

Powers of this +3 weapon are:

Blade acts as a double-edged vorpal weapon; it acts as a +3 Returning Axe if thrown. It will return 30' to its wielder.

Wielder has all natural Dwarven abilities; abilities are doubled if the wielder is a Dwarf.

Clairaudience (unlimited use)

Clairvoyance (unlimited use)

Teleportation (of up to 300 people) twice a day with no error

Casting a spell while in possession of the axe will cause a voice loss for 2-8 days.

Death Ray (one creature; no save allowed), once per day

Disintegration Ray (save allowed) once per day

Time Stop (twice normal duration), once per week

Possessor loses all interest in sex

Possessor has a poisoned touch; all who touch (or are touched by him/her), must save vs. poison or die.

## THE MACE OF SUTHBULA THE RIGHTEOUS

Int: 15

Ego: 15

Suthbula, Dwarven Patriarch of Anor, was one of the leaders of the heroic "Anvil" forces following the siege of Ostohar. During their retreat, the nomads summoned a Demon to stop the advancing Dwarven forces. Suthbula led the attack on the Demon and his minions and succeeded in returning his soul to the nether regions. Suthbula died in camp later that night, and the manner of his passing still remains open to conjecture.

The mace is made of silver and adamantine with sharply pointed gems serving as point for the spikes. Of unknown origin, none of the gems has ever broken or shown signs of wear. The mace is 42" long and the head measures 6" in diameter. The powers of this Lawful Good mace are:

Cure/Cause Crippling Wounds by touch (4-32 points and heal/cripple a limb) - four times a day

Exorcise spell - twice a week

Resurrection - twice a week

Immunity to all psionic attacks

+2 to hit only; 4-20 normal damage, tripled against all demons and devils

Bless at double strength and duration

If a person of Evil alignment attempts to use the mace, he will take 30 points damage (no save). If still alive, a system shock roll is needed to see if he survived having his alignment shifted one step closer to Lawful Good.

# RELIGION

There has been much conjecture about the contrary nature of the Dwarven people, which can perhaps be more readily understood by studying their religion and gods.

Upon completion of Guild Training, each individual is awarded an adult name by the Guild. At this time, he also chooses a patron diety. This does not mean that he worships only that diety. It merely means this is his special diety who will oversee his life, and intercede for him in times of need with the other gods. Thus, worship is not restricted to one god alone, but rather to an entire pantheon. Prayer and sacrifice are offered up to the god who can help in a certain situation. In time of war, Sharmal Ironfist, God of War and Peace is beseeched for victory, while in time of peace, he is offered thanksgiving for the continued peace.

As Sharmal Ironfist is God of both War and Peace, the other gods also encompass both contrasting attitudes. It is through this religious belief and way of worship that the Dwarven people have learned to accept both natures within themselves and the world about them.

## SHENDON, ALL-GIVER *God of Fire, Water, Air, and Earth*

AC: -6  
HTK: 400  
Stats: 25, 23, 22, 19, 25, 22

Born of emptyness, Shendon, All-Giver, is the grand creator and nominal head of the pantheon. He appears in the guise of a red bearded venerable elder, wielding a Mithril Axe and mounted on a great prairie cat. He commands the elements, toppling mountains, burning down forests, and flooding lands within the twinkling of an eye, and rebuilding them again as he desires. Shendon, All-Giver, is the patron of all Smiths and Builders.

## THE DWARVEN GODS



SHARMAL, IRONFIST  
*God of War and Peace*

AC: -10  
HTK: 350  
Stats: 25, 19, 18, 22, 24, 25

Sharmal, Ironfist, appears as a warrior youth astride a grey pony with a pack of war dogs named Victory, Defeat, Ambush, and Surrender. He is clad in mithril/adamantine armor. He wields a two-handed Battle Axe, and a Singing Sword. Those he touches with his sword become leaders of men in battle: Their men never lose morale or lack faith.

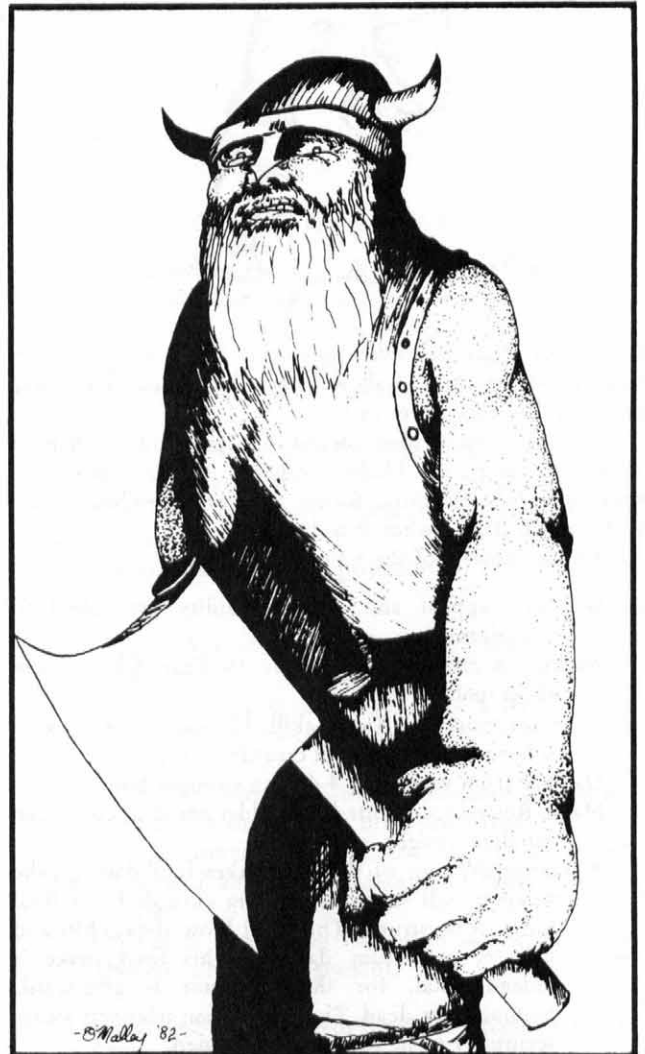



## LISHADI, ACORN BRINGER

*Goddess of Love and Hate*

AC: 5  
HTK: 250  
Stats: 18, 20, 19, 23, 21, 25

Lishadi, Acorn Bringer, sister of Sharmal, Ironfist, appears as a maiden of tender years, unarmored and weaponless. About her neck hangs an amulet which gives her immunity from all physical attack from edged weapons and which also acts as a shield against magical attacks, reflecting spells back upon their caster. In a small pouch she carries acorns which she scatters about the land, sewing discord and harmony. She often works with her brother Sharmal to sway the events of battle one way or the other and has often helped him bring about victory for one side by sewing discord to the other.

## MADAR, SURE HAND

*God of Luck and Misfortune, Vice and Purity,  
and Wealth and Poverty*

AC: -4  
HTK: 280  
Stats: 19, 18, 18, 25, 20, 25

Madar, Sure Hand, patron of thieves, bankers, and gamblers, is by far the most mischievous of the pantheon of Dwarven gods. He delights in spinning his wheel of precious stones and changing the destiny of others.

Though youngest of the gods, he is one of the most powerful, for no day goes past that the people do not beseech to him, pray to him, and worship him, fearing his displeasure. Though capricious and truly contrary, he is not without love for his people, and will award great wealth and fortune to those who have suffered his caprice without rancor.

He is particularly fond of games of chance and skill, and will often watch such activity (3% chance that he is watching), often taking a hand in matters directly by spinning his wheel to change the fortunes of the participants.

## LITHRIANA, THE BINDER

*God/Goddess of Mercy and Justice*

AC: -2  
HTK: 325  
Stats: 19, 25, 25, 16, 20, 20

Lithriana appears in either male or female guise wielding an Axe and a Hammer. The hammer, when struck against a rock allows Lithriana to tell truth from lie, and thus enables him/her to adjudicate. Justice is harsh, and there is little mercy for one who knowingly chooses the wrong path. Lithriana also has two spirits in the form of ravens named Truth and Deceit, who travel the lands of the earth and report to Lithriana. No Dwarf will, therefore, knowingly kill a raven, and often their care for these birds has been misunderstood as worship.

## JORLEG, WHITE BEARD

*God of Fertility and Blight*

AC: -3  
HTK: 380  
Stats: 18, 25, 25, 17, 23, 18

Jorleg, White Beard, appears as a cantankerous elder with a snow white beard some 14 feet long that is wound about his shoulders and arms. He continually strokes his beard and perpetually mutters and grumbles about how much work he has to do, the lack of cooperation from his assistants, and the never-ending of dissension in the world.

Jorleg enjoys flattery and will listen favorably to anyone who beseeches him in the proper manner, offering sacrifices of emeralds, rubies, and topaz which he converts into sunshine, green leaves, healthy plants and seeds of fertility. He is quickly angered if he feels slighted, and will often bring blight if those who till the land grumble about their work or fail to pay proper homage.

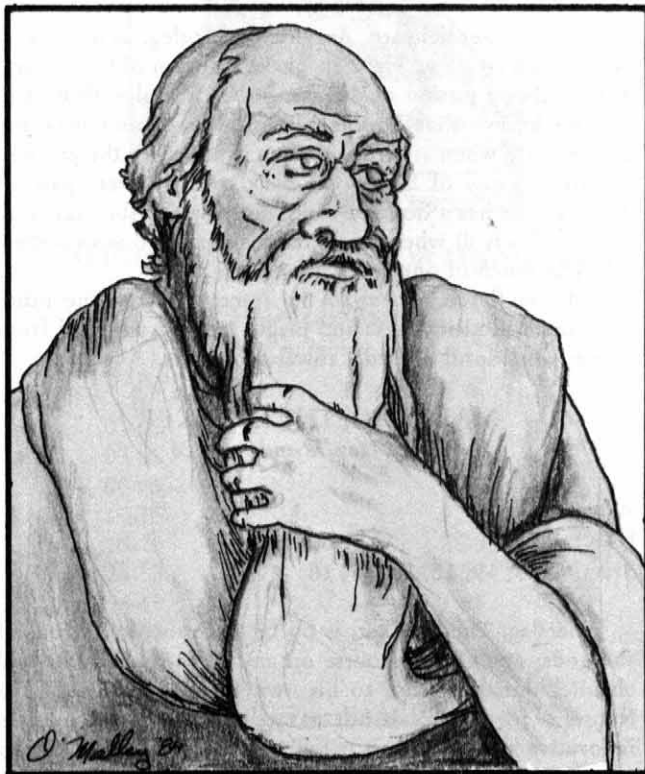

## TRASTRA, MAIDEN OF ICE

*Goddess of Light and Day, Heat and Cold*

AC: -1  
HTK: 300  
Stats: 18, 19, 17, 18, 19, 25

Trastra, Maiden of Ice, wife of Toreg, known as Order Bringer, regulates the length of days and nights and the seasons of warmth and cold.

VARRIK, THE INQUISITIVE  
*God of Knowledge and Ignorance*

AC: -2  
HTK: 335  
Stats: 17, 25, 20, 19, 22, 20

Varrik, The Inquisitive, is patron of all scholars and teachers. Son of Martlag and Lishadi, he shuns his mother's emotionality and his father's lengthy, endless discourses and constant lechery. He is an aesthetic, delighting in pure knowledge, and will spend centuries riddling the nature of something unknown. For this reason, he is also the patron of clerics who work with the smiths in the production of magic.

RIBIZA, GENTLEHEART  
*Goddess of Health and Sickness*

AC: -1  
HTK: 325  
Stats: 20, 23, 21, 24, 24, 19

Ribiza, Gentleheart, daughter of Jorleg, appears as a matron carrying two vials. In one is a potion of health, and in the other a potion of disease. She is liberal with health, for she knows that her people work hard and uses the disease only when angered or when it will serve the purpose of bringing one of her people back to the correct path of worship. She has a flock of white doves which she may send to one who is ill when she herself is unable to answer their call. The touch of one cures any disease.

She is fiercely loyal to the interests of all the other gods and will visit illness and plague on any who fall from proper worshipful attitudes toward the gods.

MARTLAG, THE SPEAKER  
*God of Nature and Artifice*

AC: -2  
HTK: 350  
Stats: 25, 19, 18, 25, 17, 16

Martlag, The Speaker, is by far the most vociferous of the gods, enjoying discourse on any topic. Usually he will channel the discussion to his own favorite debate: All is Nature - for artifice is but nature converted and used in innovative ways. He is a patient, silver bearded elder with a passion for strong tobacco and a pipe, and a fondness for Dwarven ale and women, commodities he samples frequently. It only through the vigilance of Jorleg that the land has not exploded in a preponderance of demigods.

He delights in new inventions, especially if they are pleasing to the eye. He collects one of each new item that he likes, and if it is extremely clever and pleasing to him, he will present its inventor with a silver walnut. Upon opening, the walnut produced a random, useful item (to be determined by the DM). The walnut may be used once a year.



TOREG, ROCK CARVER  
*God of Life and Death*

AC: -6  
HTK: 390  
Stats: 20, 24, 22, 25, 19, 19

Toreg, Rock Carver, is the son of Shendon, All-Giver the adjudicator over matters of life and death, and the patron of all woodcutters and carvers.

It is said that in the years when the land was empty of people, he populated the world with statues in the image of the gods, which were so lifelike that he longed to make them real. After much preparation, he was able to breathe his essence into two of his favorite statues, one male and one female. At first, the gods were angered, but also much amused by the antics of the two living statues and convinced Jorleg, God of Fertility and Blight, to make them fertile. The living statues, the first Dwarves, begat offspring and the gods were well pleased, often conversing with them, teaching them and their children the secrets of the world. Time passed and the folk grew numerous and they worshipped the gods: Unexpectedly, the gods became stronger and were gladdened. Toreg was given a place of honor in the pantheon, and no other god will anger him as he has the power to take all life and return the people to statues from whence they came, thus depriving the gods of the power they now wield.

# GENERATING DWARVEN CHARACTERS

A Dwarfven Character will be one of the following types of Dwarf:

%	Type	Description	Alignment
01-65	Mountain	Most civilized – Not open to outsiders	LN - LG
66-95	Hill	Most friendly - small villages	CG - CN
96-00	Mine	Individualist: generally hostile	CN (may tend to evil)

**MOUNTAIN DWARVES** are seldom encountered outside of Ostohar, for they live their lives within the confines of their mountain kingdom. They are leery of strangers, and they appear to outsiders as surly, withdrawn, and morose. They are the most fiercely loyal of the three types and once they have given their friendship, they will honor that commitment even to death. They are highly lawful in nature and find chaos and disorganization intolerable.

Mountain Dwarves regard education as a necessity and pursue their studies diligently.

In appearance, they are pale complected from lack of sunlight, their beards are worn long, often extending for many feet. Their clothing is rough woven and of dark colors, though their holiday clothing is quite the opposite, carefully woven of the finest of silks, dyed to pale colors, and decorated with feathers, garnets, small gems, and gold thread.

**HILL DWARVES** are much friendlier than their mountain brothers, for they live in towns and villages on the face of the land and come in contact with others far more frequently. Though they appear to have much of the withdrawn and morose quality of their mountain-dwelling brothers, it is more subdued, and they readily accept the friendship of outsiders.

By nature, they lean toward good, some preferring law, while others accept chaos quite readily, not needing the strongly structured life-style of Mountain Dwarves. Education is as highly valued, though not all Hill Dwarves obtain it, some preferring the freer adventuring life.

Hill Dwarves have darker complexions than Mountain Dwarves, though much paler than humans, for while they live in towns and cities above ground, much of their work is in mines and quarries nearby. Their towns and villages are well fortified and walled, and a small fighting force is maintained at all times for home defense.

**MINE DWARVES** are highly individualistic, finding comfort in neither lawful or chaotic lifestyles, preferring a solitary existence, occasionally with tendencies towards evil. Mine Dwarves are considered as rogues or black sheep by both Mountain and Hill Dwarves, and are viewed with as much suspicion as are outsiders of other races.



## HEIGHT AND WEIGHT FOR DWARVES

### Height of Males in inches

%	Height	%	Height
01-02	43	74-81	52
03-05	44	82-87	53
06-09	45	88-91	54
10-15	46	92-94	55
16-23	47	95-96	56
24-33	48	97	57
34-48	49	98	58
49-63	50	99	59
64-73	51	00	60

### Height of Females roll on Male Height Table, then on table below

%	
01-45	reduce height by 2"
46-80	reduce height by 1"
81-00	no height reduction

### Weight lbs per inch of height

	%	Males	%	Females
Light	01-30	2.0 lbs	01-40	1.5 lbs
Average	31-80	2.5 lbs	41-85	2.0 lbs
Heavy	81-00	3.0 lbs	86-00	2.5 lbs



## ORDER OF BIRTH TABLE

%	
01-10	Bastard*
11-30	5th son/daughter**
31-50	4th son/daughter**
51-70	3rd son/daughter**
71-90	2nd son/daughter
91-00	Inheritor

\* One quarter gold only of base inheritance for bastard.

\*\* Half gold only of base inheritance for 3rd to 5th son.

## SOCIAL CLASS OF FAMILY

Type	GUILD	NOBLE*
Mountain	01-90	91-00
Hill	01-95	96-00
Mine	01-85	86-00

\*All Dwarven nobles are trained smiths and military officers with a 30% chance of having a third skill.

## FATHER'S GUILD RANK

*If Social Class is Guild*

%	
01-40	Journeyman (worker)
41-65	Master (independent contractor)
66-90	Master (business owner)
91-99	Councillor
00	Guild Master

## BASE INHERITANCE

*If Father of Guild Rank*

Journeyman: . . . . .	5D20 gp.
Independent Contractor: . . . . .	10D20 gp and one armor and one weapon.
Business Owner: . . . . .	10D20 gp and one armor and one weapon.
Councillor: . . . . .	20D20 gp and two armor and two weapons; 20% chance one is magical.
Guild Master: . . . . .	20D20 gp and two armor and two weapons; 80% chance for one to be magical; 20% chance that the second is magical.

## FATHER'S NOBLE RANK

*If Social Class is Noble*

%	
01-49	Baronette
50-79	Baron
80-87	Count
88-95	Duke
96-00	Royalty*

\* If Royalty, go to Royal Rank to determine how related.

## BASE INHERITANCE

*If Father of Noble Rank*

Baronette: . . . . .	5D20 gp, one armor, one weapon, and one horse.
Baron: . . . . .	7D20 gp, +1 armor, one weapon, and one horse.

Count: . . . . . 10D20 gp, +1 armor, +1 weapon, and one horse.

Duke: . . . . . 15D20 gp, +1 armor, +2 weapon, and horse and barding.

Royalty: . . . . . 25D20 gp, +1 armor, +2 weapon, horse, barding, and choice of one additional +1 weapon or +1 armor.

## ROYAL RANK

*If Noble Rank is Royal*

%	
01-49	<b>BLOOD RELATION*</b>
01-29	brother/sister of King
30-74	uncle/aunt of King
75-00	cousin of King
50-84	<b>MARRIED RELATION*</b>
01-50	brother/sister-in-law
51-00	father/mother-in-law
85-99	<b>PRINCE</b>
01-35	5th Prince
36-59	4th Prince
60-79	3rd Prince
80-95	2nd Prince
96-00	Crown Prince
00	<b>KING</b>

\* Roll on Father's Noble Rank Table again for actual rank: If Royalty is rolled again, father is king of neighboring kingdom.



## FATHER'S GUILD

- 01-05 ARCHITECT**
- 06-13 ARTIST**  
01-25 Painter  
26-00 Sculptor
- 14-15 BANKER**  
01-20 Auctioneer  
21-80 Banker  
81-00 Barterer
- 16-22 CLOTHING MANUFACTURER**  
01-05 Designer  
06-15 Ink and Dye Maker  
16-35 Tailor  
36-73 Tanner  
74-00 Weaver
- 23-32 CURATES AND CLERICS**  
01-30 Apothecary  
31-45 Herbalist  
46-80 Clerical  
81-00 Weapon Specialist  
(see Smith's description)
- 33-40 ENTERTAINMENT**  
01-20 Dancer  
21-50 Juggler  
51-90 Musician  
91-00 Poet/Bard
- 41-46 FURNITURE MAKERS**  
01-35 Cabinet Maker  
36-55 Joiner  
56-00 Materials Preparer  
(tree/mushroom cutter)
- 47-54 MERCHANTS**  
01-45 Merchant/Trader  
46-70 Storage/Distribution  
71-00 Security (includes caravan guards)
- 55-64 MILITARY**  
01-50 Man-at-Arms  
51-65 Sergeant  
66-75 Officer  
01-65 Lieutenant  
66-95 Captain  
96-00 (roll on Noble Table ignoring  
Royalty)  
76-00 Construction Engineer
- 65-69 PROVISIONERS**  
01-20 Chef  
21-60 Farmer  
61-00 Livestock Breeder

- 70-73 SCHOLAR**  
01-09 Teacher/Guild School  
(roll again on guild table for type)  
10-19 Teacher/Public School  
(roll again on guild table for type)  
20-29 Research Scholar  
30-32 Astronomer  
33-35 Astrologer  
36-45 Historian  
46-51 Linguistics  
52-77 Botany  
78-88 Zoology  
89-93 Accountant  
94-00 Alchemist
- 74-83 SMITH**  
01-25 Utilitarian  
26-50 Precious Metals  
51-75 Gems  
76-00 Magical  
01-50 Graduate Smith  
51-80 Senior Smith  
81-90 Training Smith  
91-94 Master Smith  
95-98 Senior Master Smith  
99-00 Smith
- 84-93 STONEMASON**  
01-50 Mine Construction  
51-00 House Construction
- 94-96 THIEVES**  
01-35 Thief  
36-60 Military Scout  
61-00 Trap Construction/Removal
- 97-99 Two Skills: Roll twice on this table,  
ignoring 97-00.**
- 00 Three Skills: Roll three times on this table,  
ignoring 97-00**

## PERSONAL HISTORY

AGE: 40 plus 5D6

If under 50, has completed public school training and both Pre-Apprenticeships: has no skill, but knows a bit about the various guild trades.

If under 60, has had some apprenticeship training; roll on table or choose a profession; has basic knowledge of craft.

If over 60, has completed apprenticeship training. Roll on table or choose a profession; can set up and run a business.

# OSTOHAR : NEW CITY

## OUTER OSTOHAR THE NEW CITY

The new city, the most recently built addition to Ostohar, is the portion of the city wherein visitors and wandering adventurers may buy goods of Dwarven manufacture. To accommodate these visitors, there are inns for men and Elves, separate lodgings for spell users, as well as stables, inns and taverns. It is here that the Elven delegation sent by King Legorian dwells in relative tranquility in a forested corner next to a blacksmith's shop.

The city is well patrolled and guarded at all times and any disturbances are dealt with promptly.

### KEY TO THE NEW OUTER CITY OF OSTOHAR

- A - Housing for Dwarven custom inspectors and guards who patrol the outer walls and exterior guard posts.  
Captain of the Guards: Alaric Overstrider  
Fighter, AC: -2, HTK: 98 (10D10)  
Stats: 17, 14, 13, 13, 16, 10  
Special Items: +2 Plate, +3 Short Sword, +1 Light Crossbow
- B - Customs offices where all cargo is checked for contraband, inventoried, and marked for storage (in building G) or for direct shipment into Ostohar proper.  
Customs Officer: Flana Whelstar (female)  
Fighter, AC: 2, HTK: 31 (6D10)  
Stats: 17, 16, 15, 11, 13, 10  
Special Items: Gem of True Sight, +4 Dagger  
Customs Officer: Prato Niblefingers  
Fighter, AC: 2, HTK: 53 (7D10)  
Stats: 15, 11, 12, 11, 13, 10  
Special Items: Amulet of Telepathy
- C - Storage for confiscated goods or items. These are either destroyed or returned when the visitors leave the city. There are two guards in each building at all times.  
Guard: Forst Hurlaxe  
Fighter, AC: 2, HTK: 70 (8D10)  
Stats: 16, 12, 10, 18, 17, 15  
Special Item: +2 Shield  
Guard: Merrik Ironfist  
Fighter, AC: 2, HTK: 50 (7D10)  
Stats: 15, 10, 13, 10, 13, 10  
Guard: Frin Fairweather  
Fighter, AC: 2, HTK: 42 (6D10)  
Stats: 18, 9, 12, 15, 17, 12  
Special Item: +5 Scimitar  
Guard: Wlora Treetop (female)  
Fighter, AC: 2, HTK: 59 (7D10)  
Stats: 18, 9, 10, 16, 17, 12
- D - Housing for guards who patrol in outer city and stand watch on the inner wall.
- E - THE NEW HARVEST - a store supplying animal feed and all sorts of supplies for caravans (wheel parts, barrels, harnesses, etc.)  
Owner/Manager: Marska Marshcut  
Fighter, AC: 10, HTK: 22 (4D10)  
Stats: 15, 11, 12, 14, 12, 11
- F - HARVEST STABLES - Stables for horses oxen, mules, etc. Also storage for materials sold in the New Harvest and feed for animals. A small smithy tends to animals requiring shoeing.  
Owner/Manager: Anton the Obese  
Fighter, AC: 10, HTK: 16 (3D10)  
Stats: 17, 10, 12, 11, 12, 14
- G - THE VAULT - Storage for imported goods not yet sold to Dwarves. This is a very secure area. Guards live on the premises. There is a dock for loading and unloading cargo.  
Manager: Boulter Strongfist  
Fighter, AC: 10, HTK: 30 (4D10)  
Stats: 7, 16, 14, 15, 16, 11  
Special Item: Belt of Hill Giant Strength
- H - THE MERCHANT'S REST - Largest and most comfortable inn in the outer city. Designed to keep wealthy merchants and their helpers very comfortable. Better rooms are in the eastern wing. The Platinum Piece, a tavern is located at the western end of the building. Prices are high here, but Dwarven hospitality is seen here at its best.  
Manager of Merchant's Rest:  
Willa Hartzel (half Elf female)  
Fighter, AC: 9, HTK: 42 (6D10)  
Stats: 15, 10, 12, 10, 9, 9  
Manager of Platinum Piece: Winton Gaylord  
Fighter, AC: 8, HTK: 66 (9D10)  
Stats: 18, 10, 10, 14, 18, 10  
Special Item: Enchanted Goblet of Neutralize Poison
- I - CONTRACTS BUILDING - All negotiations over goods not specifically ordered by the Dwarves are handled here. Representatives from the Dwarven bankers are also present during negotiations to handle payments.  
Manager: Elrand Goodwin  
Fighter, AC: 8, HTK: 39 (5D10)  
Stats: 15, 11, 12, 16, 9, 14
- J - THE CRYSTAL BOWL - A large comfortable tavern/inn where all spell casters are asked to do their carousing. Most of the building and its furnishings have been fireproofed. No one is allowed into the inner city after dark - especially inebriated spell casters.  
Owner: Liana Blackthorn (human female)  
Thief, AC: 10, HTK: 8 (2D6)  
Stats: 18, 13, 15, 16, 12, 10



K - THE EAGLE AND GRYPHON - An inn specializing in exotic dishes and fine wines. Run by Irwin Goldstone, a human, as a quality inn for humans; other races are also welcome.

Owner: Irwin Goldstone (human)  
Fighter, AC: 0, HTK: 113 (14D10)  
Stats: 18, 13, 11, 14, 15, 12  
Special Items: Amulet, AC: 4, +3 Vorpal Battle Axe, +4 Ring of Protection

L - BUILDING FOR RENT - See Darek Fiercetalker in the "Brilliant Opal" to rent it.

M - JUSTICE BUILDING - Court to oversee all transgressions discovered in the Outer City. Dwarven Justice is swift and fair. Court presided over by Jamie Fairspeaker, a Dwarven scholar of great repute. Most sentences involve working at hard labor in distant mines.

Chief Magistrate: Vokos Alderdome  
Fighter/Cleric, AC: 10, HTK: 17 (3D8)  
Stats: 15, 13, 16, 10, 13, 10

N - THE SHELTERED BOUGH - An Elven inn run by Kurtis Silverblaze for Elves. Other races will be shown guarded hospitality.

Manager: Kurtis Silverblaze (Elf)  
Fighter, Skill 5, AC: 10, HTK: 40 (5D10)  
Stats: 15, 13, 17, 13, 13, 9  
Special Items: +4 Elven Chain, +2 Longsword, +4 Mithril Shield.

Buildings O, P, and Q - Each building has four shops in it, each displaying a different Dwarven product. These items are marketed by independent master craftsmen who no longer toil in guild workshops. Overall quality is higher here, as are the prices. Inferior goods can also be found here - so the buyer must be wary.

O1 - RUGS AND TAPESTRY SHOP

Owner: Janna Sharpneedle (female)  
Fighter, AC: 10, HTK: 14 (2D10)  
Stats: 16, 10, 9, 11, 13, 9

O2 - HOME FURNISHINGS (made of wood and dried mushrooms)

Owner: Elda Lastgram (female)  
Fighter, AC: 10, HTK: 10 (2D10)  
Stats: 16, 10, 14, 14, 13, 12

O3 - PET SHOP (cats, ravens, hawks, potential familiars)

Owner: Kevan Ostridge (Human)  
Fighter, AC 10, HTK: 12 (2D10)  
Stats: 15, 9, 9, 16, 14, 12

O4 - INK AND DYE SHOP

Owner: Talwin Spotless  
Thief, AC: 10, HTK: 18 (3D6)  
Stats: 16, 12, 12, 16, 16, 7  
Special Item: Everfull Inkpot

P1 - SCULPTURE AND PAINTER'S SHOP

Owner: Dugal Colorglow  
Fighter, AC: 10, HTK: 9 (1D10)  
Stats: 17, 14, 16, 9, 11, 12

P2 - APOTHECARY AND HERBALIST SHOP

Owner: Govard Stedman  
Fighter, AC: 9, HTK: 10 (1D10)  
Stats: 12, 17, 16, 13, 14, 12

P3 - ASTROLOGY AND FORTUNE TELLING SHOP

Owner: Glovar Farseer  
Cleric, AC: 10, HTK: 19 (6D8)  
Stats: 11, 12, 15, 11, 11, 14  
Special Item: Crystal Ball of Divination

P4 - SECURITY SHOP (traps, puzzle boxes, trapped containers, etc., to protect valuables)

Owner: Korlinth Delver  
Fighter, AC: 9, HTK: 18 (2D10)  
Stats: 16, 12, 11, 10, 13, 12  
Special Ability: Natural ESP

Q1 - TANNED HIDES AND LEATHER GOODS

Owner: Scarl Silkenbeard  
Fighter, AC: 9, HTK: 8 (1D10)  
Stats: 15, 12, 10, 11, 11, 13

Q2 - HOUSEHOLD IMPLEMENTS (knives, spoons, needles, threads)

Owner: Zeltar Shareyes  
Fighter, AC: 9, HTK: 8 (1D10)  
Stats: 17, 13, 10, 9, 13, 13

Q3 - CLOTH AND TAILOR SHOP

Owner: Beryl Silversabre (female)  
Fighter, AC: 10, HTK: 12 (2D10)  
Stats: 15, 10, 9, 14, 10, 16

Q4 - DRAGON HIDEAWAY INN (Serves Dwarven Specialities)

Owner/Manager: Corwin Redfinger  
Bard, AC: 10, HTK: 31 (5D8)  
Stats: 16, 11, 14, 17, 14, 18



R - THE RINGING ANVIL - Weapons Shop: Both mundane and magical items are available here.

Normal Weapons: . . . . .1-12 in stock  
Magical Weapons: . . . . .5% chance of any specific item being in stock.  
Other Magical Implements: . . .2% chance of any specific item being in stock.

Owner: Ferenc Fisheater  
Fighter, AC: 10, HTK: 65 (7D10)  
Stats: 16, 14, 11, 16, 15, 13  
Special Item: Magical Anvil, which can enchant up to +1 weapons, once a week.

S - THE BRILLIANT OPAL - This large shop houses a Goldsmith, a Silversmith, and a Jewelsmith: They are brothers. Prices are high, but so is the quality of the

workmanship.

Goldsmith: Jarl One Eye

Fighter, AC: 4, HTK: 32 (4D10)

Stats: 18/86, 13, 12, 16, 14, 6

Special Item: Magical tools - will never shatter a gem

Silversmith: Larak Rock Climber

Fighter, AC: 3, HTK: 12 (3D10)

Stats: 11, 18, 17, 12, 12, 6

Jewelsmith: Darek Fiercetalker

Fighter, AC: 2, HTK: 24 (3D10)

Stats: 11, 13, 17, 18, 11, 6

T - TEMPLE HOUSE - Housing for clerics who work in temple. Clerics who worship many different gods live here peacefully together under one roof. Any trouble occurring is dealt with severely - the transgressor, along with any other clerics serving the same god, is expelled from the city, leaving no cleric to represent the god he worshipped. The period of absence varies with the severity of the transgression.

Manager of Clerical Housing: Sart the Fairminded

Cleric, AC: 5, HTK: 20 (5D8)

Stats: 13, 13, 16, 12, 13, 16

Special Items: +3 Leather, +1 Hammer

U - TEMPLE OF MANY GODS - This temple is divided into many chambers for the worship of different gods. All chambers are roughly equivalent in magnificence.

Temple Security Chief: Olarf the Weary

Cleric/Fighter, AC: 0, HTK 35 (7D8)

Stats: 18/11, 11, 12, 12, 14, 9

Special Items: Bracers AC: 0, +1 Short Sword

V - THE CHESTNUT SMITHY - This smith will repair broken items and make utilitarian items (shovels, hoes, plows, etc.). Will custom fit any weapon purchased at the Ringing Anvil. (This smithy was built to annoy the "exclusive" Elves who chose to live in the inn next door.)

Owner: Barsk No Hair (hairless Dwarf - does not take kindly to kidding or even friendly and concerned questions about his condition.)

Fighter/Thief, AC: 10, HTK: 37 (6D8)

Stats: 18/58, 11, 13, 12, 16, 9











W - THE ROCKY RETREAT - An inn for Elves only. They raised the trees around the inn and the church. Most of these Elves are scholars or teachers who prefer to have some private time with members of their own race.

Owner: Eilifi Greanleaf (Elf)

Fighter, AC: 6, HTK 65 (7D10)

Stats: 12, 11, 17, 16, 13, 14

### LEGEND OSTOHAR OUTER CITY

Trees		Tower	
Stairs		Wall	
Gate		Fence	
Fountain		Fence Gate	
Road		Amphitheater	

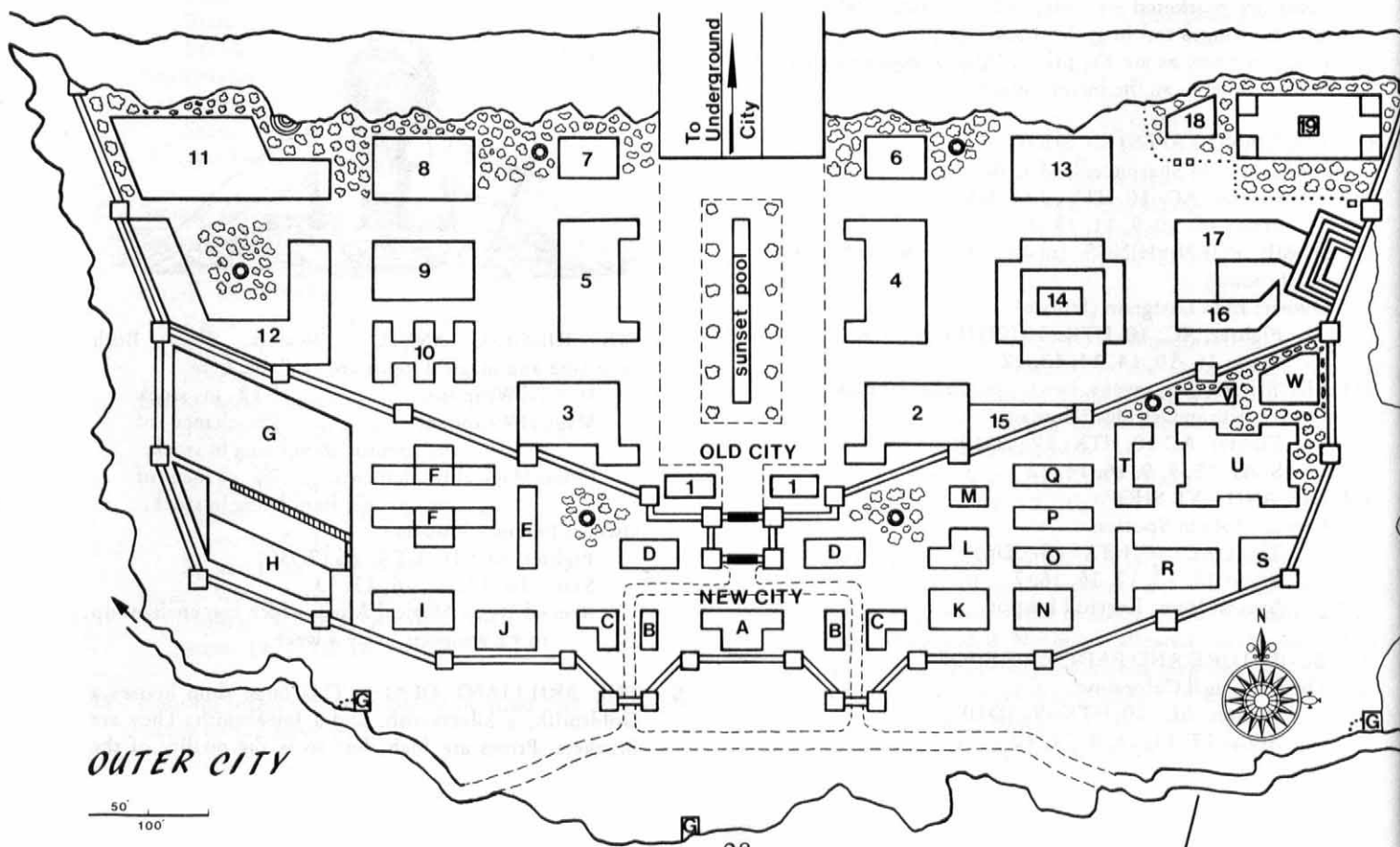

# OSTOHAR : OLD CITY

## OUTER OSTOHAR THE OLD CITY

The old outer city now houses the guild halls where negotiations are held for large commercial sales. It is also the location for the Dwarven showcase, the Sunset Pool, and inns for Halflings and Gnomes who prefer not to stay underground in the mountain city.

## THE SUNSET POOL

The edge and walls of the pool are made of white gold inscribed with Dwarven Runes. Large gems line the base of the pool; they are faceted to reflect light in all directions. This effect is especially magnificent at sunset, hence the name. As each Dwarven King is crowned, he places a gem into the pool to mark the end of the official ceremony and the commencement of the festivities. In the park surrounding the pool are found the finest examples of Dwarven sculpture. Every fifty years, a contest is held, and the best works are displayed in the park. At the following contest, the old statues are taken into the mountain city and are placed in the parks, and along the boulevards to provide beauty throughout the city.

1 – GUARD HOUSE - houses Dwarven patrol guards. It is also the checkpoint station which verifies the business of all who enter.

Guard Captain: Bror Fairspeaker

Fighter, AC: 0, HTK: 64 (8D10)

Stats: 18/35, 14, 12, 9, 11, 8

Special Items: +2 Sword, +2 Shield



2 – MILITARY GUILD HALL

Councillor: Boska Carnok

Fighter, AC: 0, HTK: 69 (7D10)

Stats: 18/30, 15, 13, 16, 18, 13

Special Item: +3 Hammer

3 – SMITHS GUILD HALL

Councillor: Griswold Ironhelm

Fighter, AC: 10, HTK: 24 (3D10)

Stats: 18/75, 11, 17, 17, 16, 12

4 – BANKERS GUILD HALL

Councillor: Feargus Hallard

Thief (retired), AC: 0, HTK: 35 (11D6)

Stats: 13, 15, 14, 18, 14, 16

Special Items: Bracers AC: 4, +2 Dagger

5 – MERCHANTS GUILD HALL

Councillor: Goldwin Hoarder

Fighter, AC: 2, HTK: 40 (4D10)

Stats: 17, 12, 13, 13, 11, 12

Special Items: +1 Axe, Bracers AC: 2



6 – THE MOSSY HILLOCK, an inn for Halflings

Proprietor: Feike Baldfoot (Halfling)

Thief (retired), AC: 8, HTK: 60 (11D6)

Stats: 13, 9, 17, 15, 12, 13

Special Item: Ring of Invisibility

7 – THE CARDINAL INN, an inn for Gnomes

Proprietor: Flygare Ironhearted (Gnome)

Illusionist, AC: 10, HTK: 9 (3D4)

Stats: 15, 10, 9, 14, 10, 16

8 – CLOTHING MANUFACTURERS GUILD HALL

Councillor: Kurt Schumaker

Cleric, AC: 10, HTK: 17 (3D8)

Stats: 17, 15, 16, 12, 15, 13

9 – FURNITURE MANUFACTURERS GUILD HALL

Councillor: Angal Woodvine

Fighter, AC: 10, HTK: 22, (3D10)

Stats: 14, 13, 12, 13, 12, 12

10 - ARCHITECTS AND STONEMASONS GUILD HALL

Councillor of Architects Guild: Hartzel Granitop

Cleric, AC: 10, HTK: 18 (3D8)

Stats: 12, 15, 16, 14, 12, 11

Councillor of Stonemasons Guild:

Duke Tubork Hammerfist

Fighter, AC: 10, HTK: 32 (8D10)

Stats: 15, 11, 12, 10, 12, 14



11 - RESEARCH LIBRARY AND LABS  
 Master Librarian: Graf Crystalwand (human)  
 Sage, AC: 10, HTK: 30 (6D8)  
 Stats: 12, 17, 18, 12, 11, 14

12 - HOUSING FOR SCHOLARS  
 Housing Manager: Belga Tarngate  
 Fighter, AC: 10, HTK: 15 (3D10)  
 Stats: 14, 12, 15, 12, 13, 16

13 - PROVISIONERS GUILD  
 Councillor: Woldmar Goskin  
 Fighter (retired), AC: 8, HTK: 27 (6D10)  
 Stats: 12, 13, 10, 14, 15, 8  
 Special Item: +2 Ring of Protection

14 - CURATES AND CLERICS GUILD HALL  
 Councillor: Luffa Winterwind (female)  
 Cleric, AC: 6, HTK: 28 (7D8)  
 Stats: 14, 10, 17, 8, 15, 14  
 Special Items: +2 Mace, +2 Leather Armor

15 - THIEVES GUILD HALL  
 Councillor: Biietri Nimblefast  
 Thief, AC: 7, HTK: 69 (13D6)  
 Stats: 15, 9, 14, 17, 8, 12  
 Special Item: Chime of Opening

16 - ARTISTS GUILD HALL  
 Councillor: Asbarr Earthenfast  
 Fighter, AC: 10, HTK: 7 (1D10)  
 Stats: 17, 12, 13, 9, 13, 10  
 Special Item: Beaker of Many Colors

17 - ENTERTAINERS GUILD HALL  
 AND ATTACHED AMPITHEATER  
 Councillor: Lysselda Crowther (female)  
 Bard, AC: 6, HTK: 23 (5D8)  
 Stats: 14, 14, 16, 18, 15, 17  
 Special Item: Magic Lute (Charms twice daily)

18 - APOTHECARY SHOP  
 Owner/Manager: Jevan Marchand (human)  
 Cleric, AC: 8, HTK 30 (6D8)  
 Stats: 11, 15, 16, 16, 15, 14  
 Special Item: Pet Basilisk (kept in back room)

19 - A FAMILIAR SPOT, an inn for hired magic users  
 employed by Dwarves.  
 Manager: Selena the Clever (human female)  
 Magic User, AC: 3, HTK: 7 (4D4)  
 Stats: 14, 16, 11, 10, 9, 18  
 Special Item: Bracers AC: 3

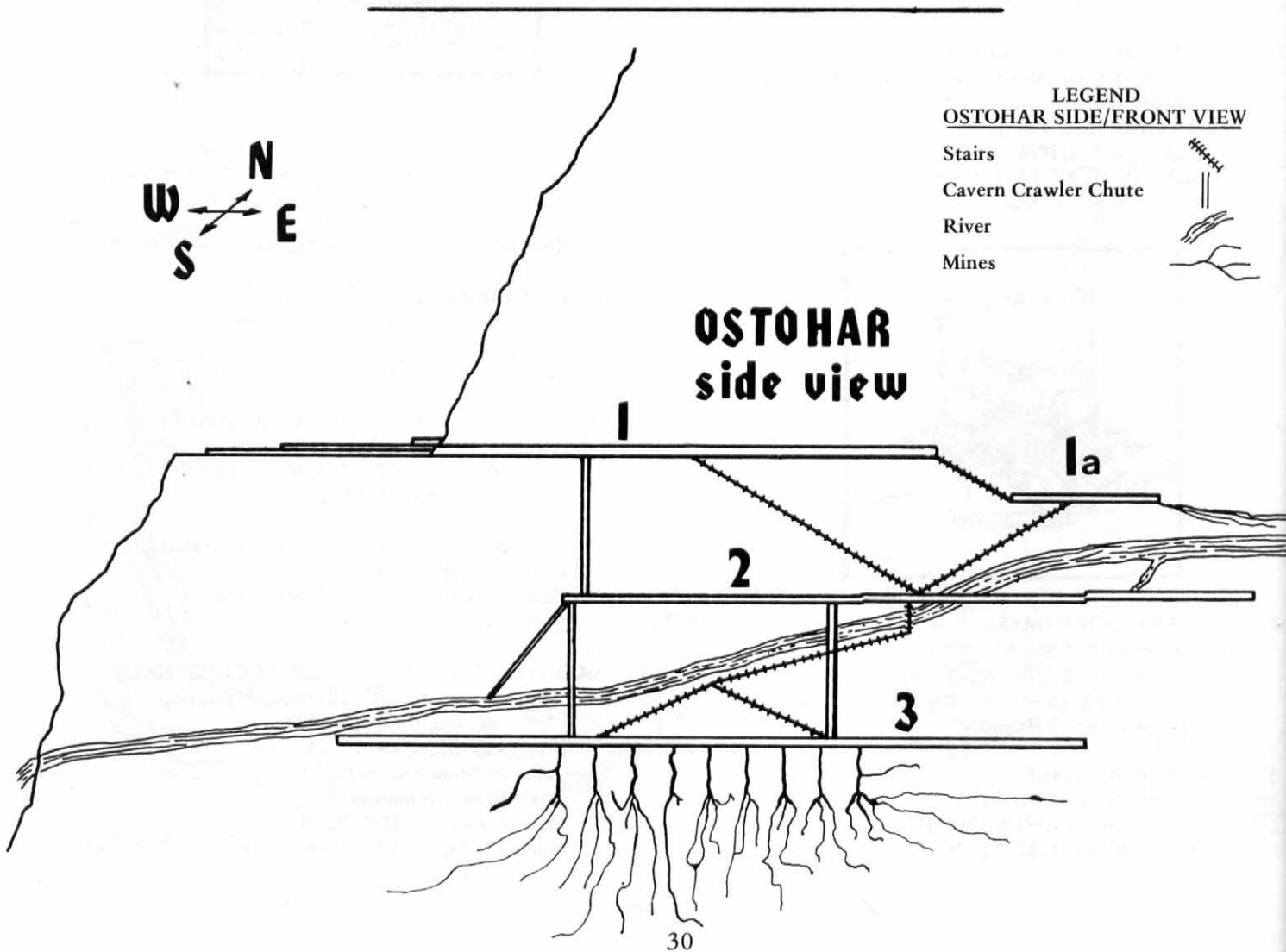

# OSTOHAR : UNDERGROUND CITY

## ARCHITECTURE WITHIN THE MOUNTAIN

Ostohar, the city within the mountain, is a marvel of engineering and excavation. The entry level contains a large boulevard of pillars. Along this boulevard can be found the majority of homes, a number of shops, and a park. The design of well-lit streets and carefully planned construction is both functional and aesthetically pleasing. Unlike surface cities, the Dwarven city is clean and vermin free. Street sweepers keep the streets scrupulously clean while individual home owners and shopkeepers maintain their private property in a similar fashion.

At the rear of this entry level are flights of stairs leading down to a sub-level of mines, store-houses, and offices for precious metal workers.

Level 2, another gigantic feat of engineering and excavation is the showplace of the city. Running through this level of the city is an underground river, in which giant blind cave fish are bred. At the point where the river enters this level is a magnificent waterfall behind which lies the splendor of the castle. Entrance to the castle, in fact, is gained by walking around and behind the waterfall, a most exhilarating experience in itself. Clustered about the castle are the Guild Offices and Schools.

The lowest level of the city complex typifies the Dwarven talent for planning and utilization of space to its ultimate. At the center of this level are four quadrants divided by two intersecting boulevards, and each quadrant contains more homes. Encircling this square is an outer perimeter of forges, and at four points of the outer square are the four great blast furnaces. On two sides of the square, extending beyond the forges are a multitude of

mine shafts, while on the other two sides of the outer square, the boulevards continue to the large caverns in which fungi are raised. Because of their proximity to the furnaces, these fungi caverns are kept at an ideal temperature for growth. The Dwarves are thus able to reap harvests of incredible size and quantity. At the end of the boulevard on either end beyond the fungi caverns is a park containing a large fountain and swimming pool.

One might expect that such a combination of diverse activities would leave the area looking dreary and unfit for occupation, but this is not the case. On the contrary, the entire level is as clean as the upper levels and is as carefully thought out as the castle and its surroundings.

## AIR AND WATER WITHIN THE MOUNTAIN

The primary problem that had to be solved before settling the people into the mountain was the establishment of an air supply. This was accomplished by drilling airshafts to the surface which twisted and turned, disguising their true nature. Tunnels were also excavated to areas of porous rock near the surface. Rivers were diverted underground in tunnels and channels large enough to allow the entry of air. Steep vertical drops were designed to discourage entry by outsiders, and great metal porticullises were placed beneath the water to keep out even those to whom water is home and air unnecessary.

This underground river has been channelled into reservoirs and pumped to the many wells throughout the city. From these wells, water is carried in containers to homes. Bath houses, the Guilds, and the royal court are the only exceptions to this, for their water supplies are routed directly via an exhaustive series of irrigation channels.

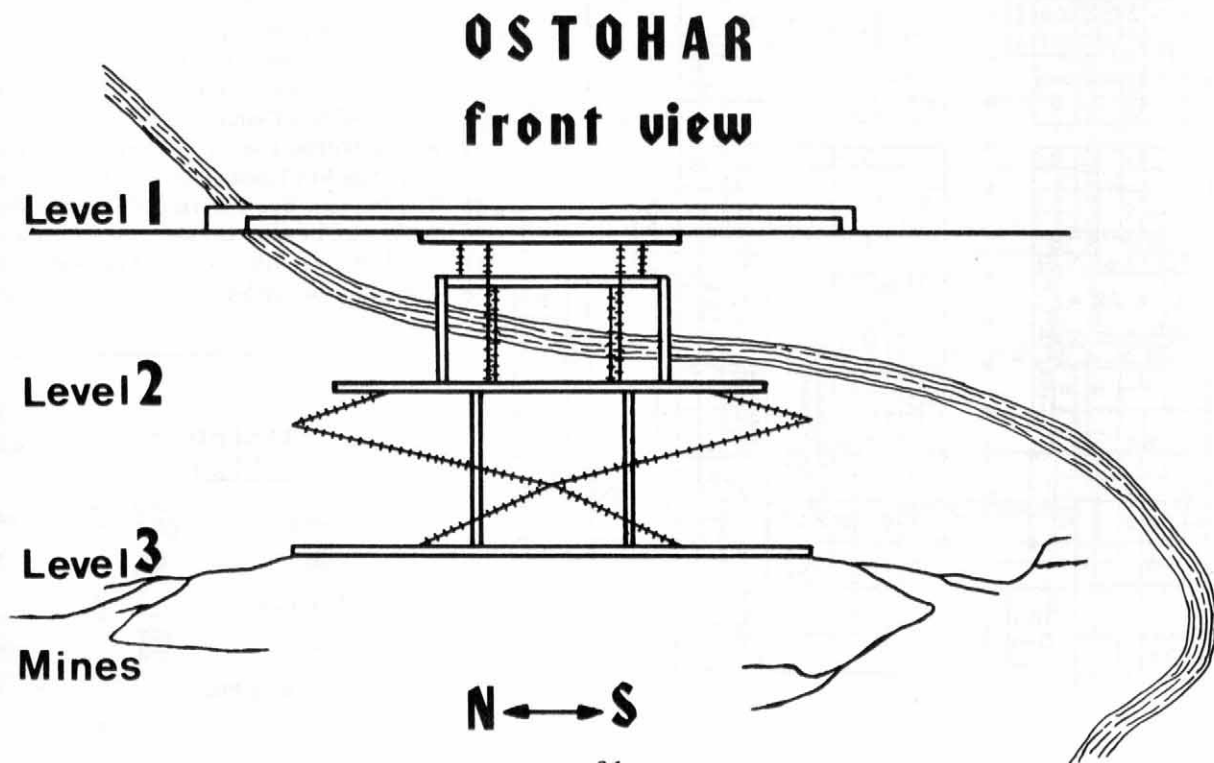



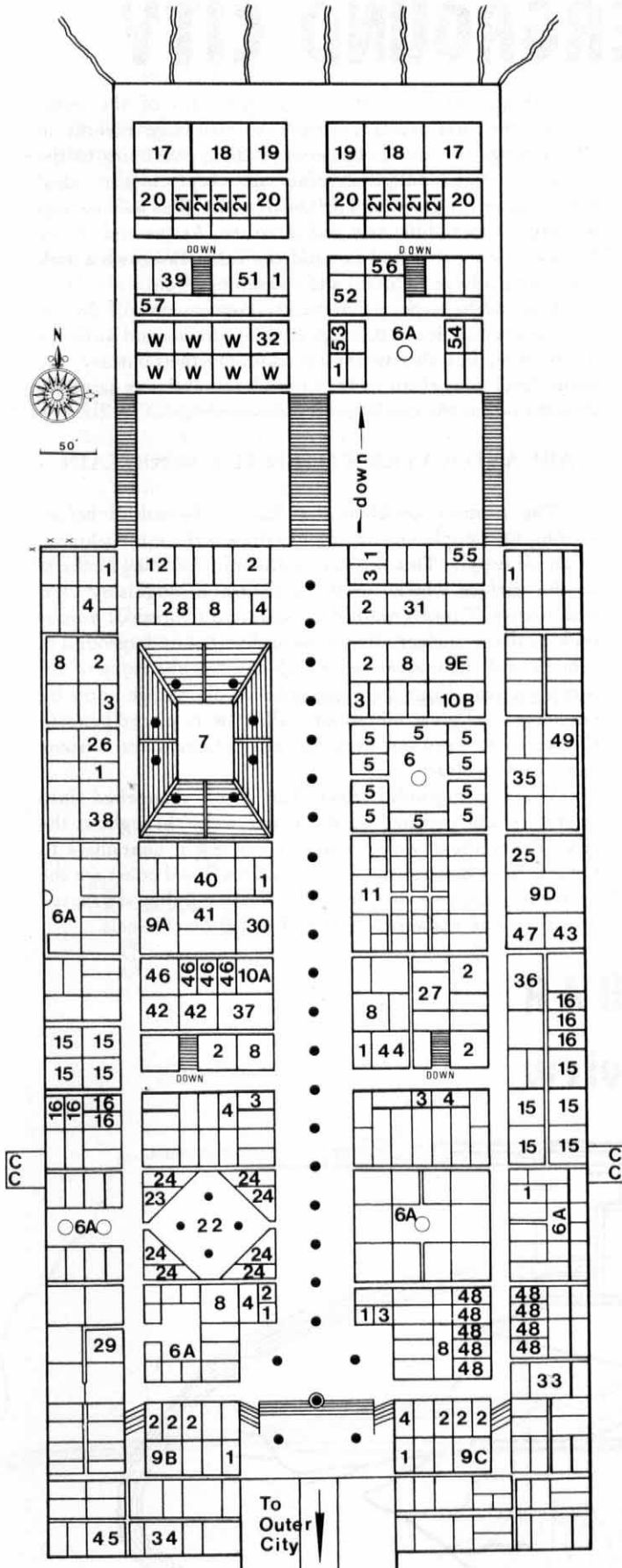

Key to Level 1  
blank spaces are public housing



- 1 Guard Posts
- 2 Guard Barracks
- 3 Guard Officers Quarters
- 4 Guard Armories
- 5 Wealthy Nobles Apartments
- 6 Parks - Private (Nobles only)
- 6a Commoners Park
- 7 Arena
- 8 Guards Mess
- 9 Suttler (Grocery Store)
  - A Morwins Suttler I
  - B Morwins Suttler II
  - C Kraskins Fine Foods
  - D Morwins Suttler III
  - E Bolars Suttler
- 10 Butcher Shops
  - A Maligwines Meats & Fish
  - B Brodal Meats
- 11 The Weapons Rack "Finest in all Ostohar"
- 12 The Crossed Swords Weapons Shop
- 13 Guards Practice Yard
- 14 Foundry
- 15 Public Schools
- 16 School Offices
- 17 Assay Office
- 18 Mine Office
- 19 Miners Supply Room
- 20 Miners Cafeteria
- 21 First Aid Station
- 22 Temple to All Gods
- 23 Temple Office
- 24 Temple Staffs Quarters
- 25 Shaganars Clothing Emporium
- 26 Willits Custom Cloaks
- 27 The Turquoise Goblet Tavern
- 28 The Deep Delver Tavern
- 29 The Round Table Saloon
- 30 The Beard Dunker Tavern
- 31 The Blue Beetle Tavern
- 32 The Anvil Inn Tavern
- 33 Racing Willibs Tavern
- 34 The Moss Inn Tavern
- 35 The Dragons Eye Tavern
- 36 Beekovars Leather Goods
- 37 Leeds Blacksmithy - General Repairs
- 38 Carpentry by Gaileb

LEGEND  
LEVEL 1

- Ramp 
- Pillar 
- Fountain 
- Stairs 
- Dumping Pits 



LEVEL 2

- 39 Mrithar the Armor Master
- 40 Babalars Bakery
- 41 Turniri's Fish Market
- 42 Barnnumms House of Amusements
- 43 Malagolin Casino
- 44 Captain of the Guards Quarters
- 45 Nici's Ceramics Shop
- 46 Mandi's Red Lantern Shop
- 47 Beala's House of Statuary
- 48 Public Library
- 49 True Shot Crossbows
- 50 The Smelting Pot Inn (Dwarves)
- 51 Precious Gems by Mali
- 52 Basrats Gold Smithy
- 53 Collits Silver Smithy
- 54 Fine Jewelry by Kon
- 55 House of Gems
- 56 The Gold Bowl (gold)
- 57 Mithril Market (mithril ingots wholesale)
- W Warehouse
- C Cavern Crawler Chutes to Second Level

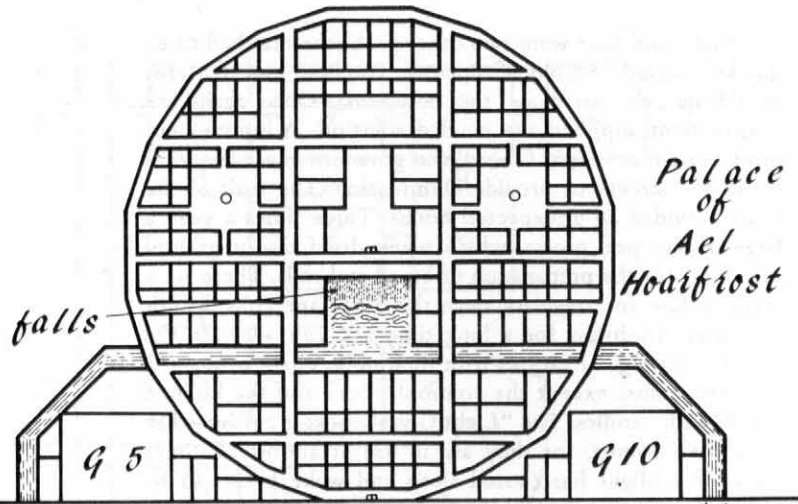

Key to Level 2  
blank spaces are public housing

- C Cavern Crawler Shafts to Third Level
- F Blind Cave Fish Pools
- Fp Areas for processing and stocking fish
- G1 Artists Guild
- G2 Bankers Guild
- G3 Clothiers Guild
- G4 Curates & Clerics Guild
- G5 Entertainers Guild
- G6 Furniture Makers Guild
- G7 Merchants Guild
- G8 Military Guild
- G9 Provisioners Guild
- G10 Scholars Guild
- G11 Smiths Guild
- G12 Stonemasons Guild
- G13 Thieves Guild
- G14 Architects Guild
- H Housing and care of Cavern Crawlers
- N Rich Nobles Homes
- P Bathing Pools
- S Public Schools
- W Warehouse or work space for the guilds

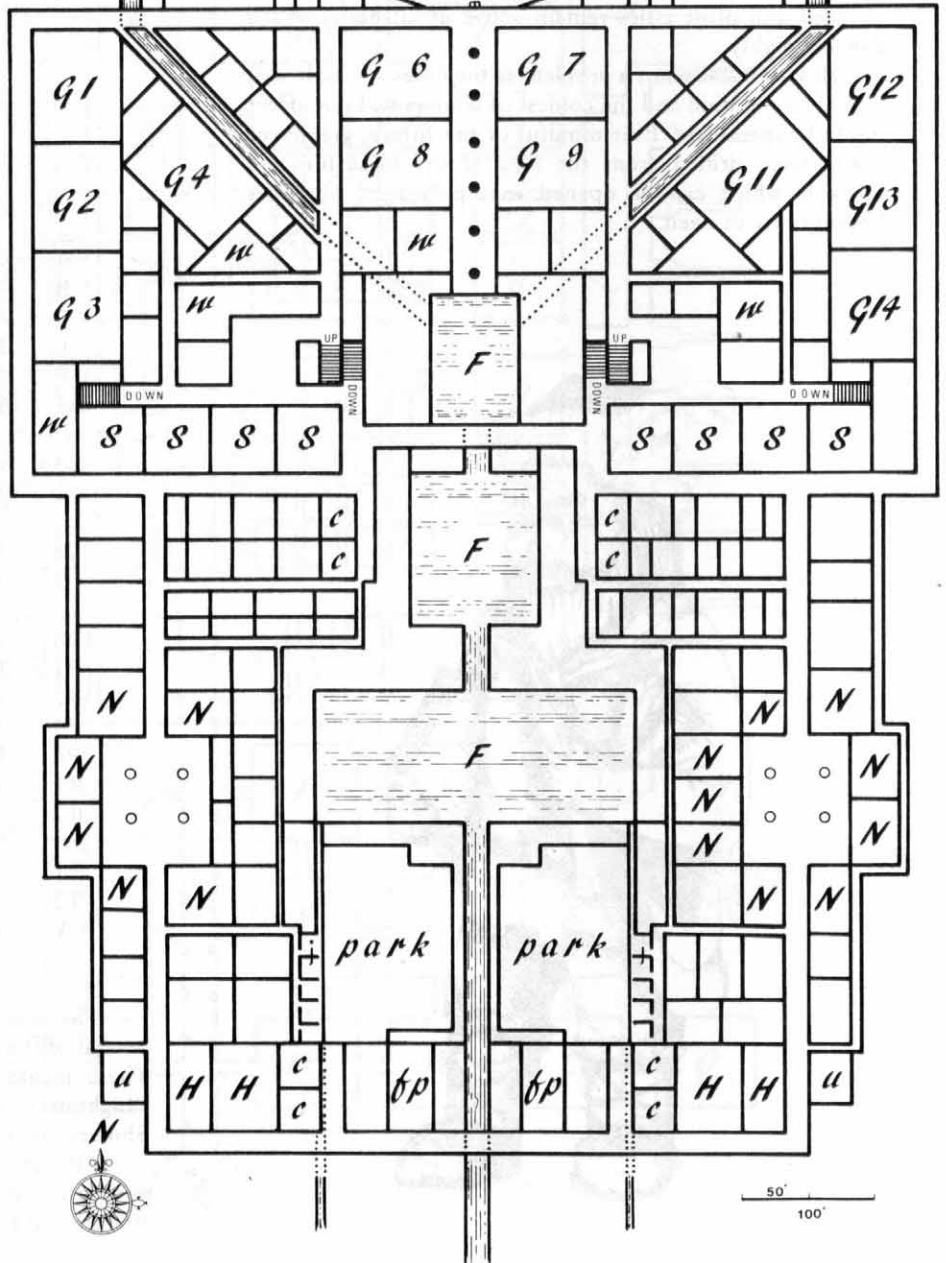

LEGEND  
LEVEL 2

- Door
- Waterway
- Conduit
- Stairs
- Fountain

Cavern Crawler Chutes to First Level



## LIGHT AND HEAT

Light and heat were two other problems that had to be quickly solved. Smoky fireplaces, torches, and lanterns would quickly suffocate the occupants. Once again the environment supplied the needed solution. A luminescent moss known as "Light Giver," was grown to cover the walls of all the streets to provide illumination. The fruit of the moss provided an unexpected bonus. Three times a year, a large, fleshy pod grows, which when dried can be ground into flour for the preparation of bread and rolls. These are a favorite fare for travelers since the bread and rolls do not lose their freshness for a long time and can alleviate the boredom of regular rations with their mild, nutty taste.

All rooms, except the common room and the kitchen are lit with candles. The "Light Giver" moss is cultivated in these two rooms, for they are in use at almost all times (lack of sunlight has caused sleep and wake cycles to be changed and most cities remain active at all hours of the day and night).

Heat is usually not a problem as the cities are built well into the mountain and the coldest of winters will not affect inside temperatures. Ever mindful of the future, great vent shafts were drilled from the area of the blast furnaces upwards which can be opened to supply heat to upper levels in case of need.



### Key to Level 3

*blank spaces are public housing*



- A Entrance to Mine
- B Pedestrian starways up
- C Cavern Crawler shafts to Second Level
- E Rooms for the cultivation of edible fungus
- F Foundry
- G1 Baragars General Store (General Merchandise and Food)
- G2 Gambini's General Store
- L Rooms for the cultivation of the "Lightgiver" Moss
- M Mold Pouring Room
- O Rooms for the cultivation of oxygen producing fungus
  - o Public Well
- P1 Park with crystal formations
- P2 Park with multicolored fungus
- P3 Park with sports facilities
- P4 Park with stage for entertainment
- R1 Recreation area with swimming pool
- R2 Recreation area with swimming pool
- S Smithy
- T1 The Slag Pit Tavern
- T2 The Hammer & Tongs Tavern
- W Rooms for the cultivation of Woody Giant Mushrooms used for construction

The walls of Rooms O, L, E, and W are covered with several different types of mosses (1-3 types per room). These include Dwarven Moss (cures up to 1-3 hits), the "Lightgiver" Moss (also grown along all the corridors), and Shmars (used as seasoning).

All of the rooms are also interconnected with ventilation shafts (not shown on map) leading from the the surface and from the rooms marked O on Level 3.

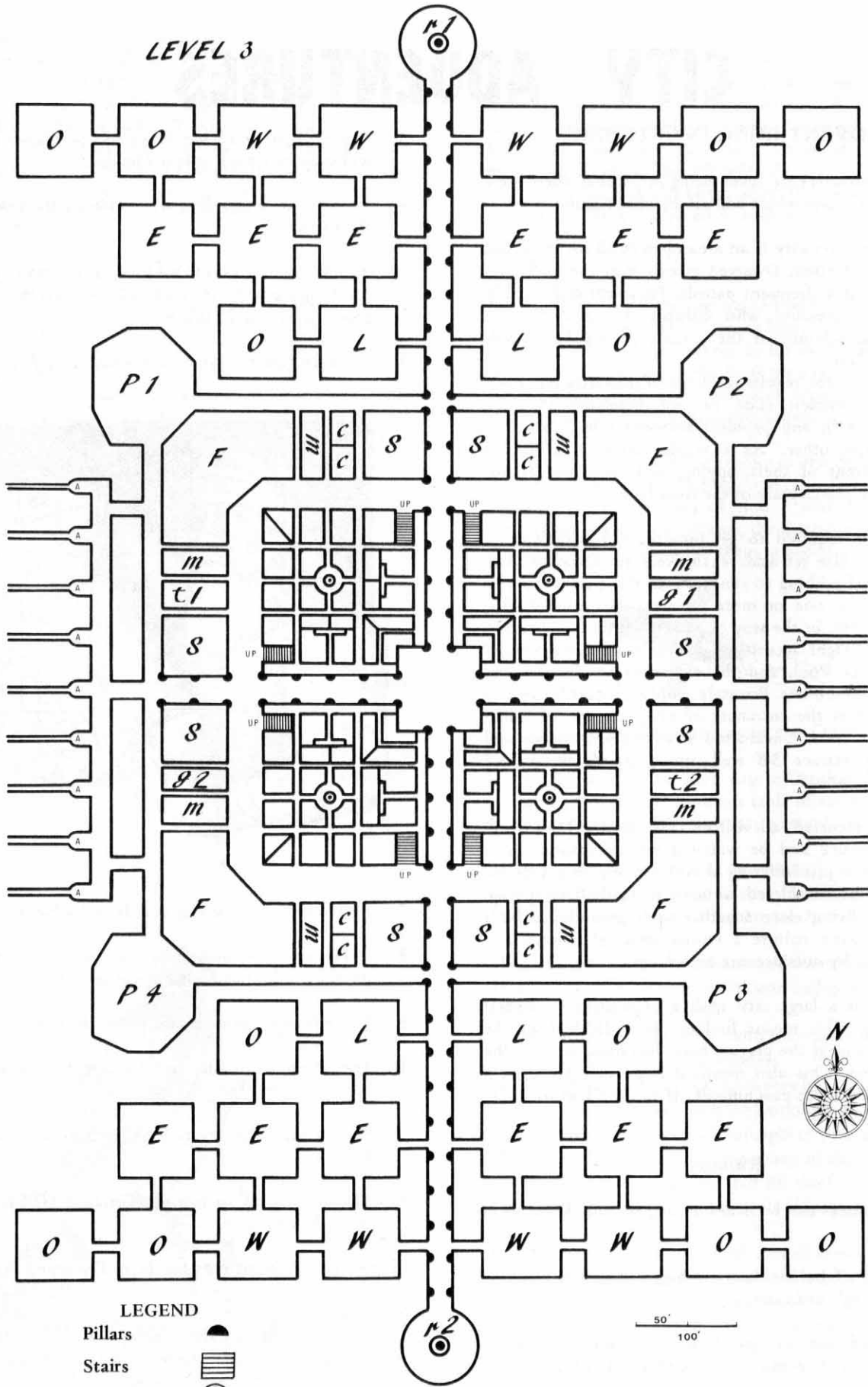
LEVEL 3



- LEGEND
- Pillars 
  - Stairs 
  - Fountains 

50'  
100'



# CITY ADVENTURES

## ADVENTURING IN OSTOHAR

When characters are adventuring in Ostohar, there are a few major guidelines which will affect what occurs:

- 1 - The new outer city is an area open to all for trade and other interaction. Dwarven guards man the walls and are present as frequent patrols. They will deal harshly with any creature who disrupts the area, but are otherwise tolerant of the actions of any humanoids staying there.

Among the regular residents of the outer city itself is an unwritten code of not involving Dwarven authorities in any problem between non-Dwarves or with each other. As a result, there is a hidden undercurrent of theft, spying, and even murder not known to the Captain of the Guards.

- 2 - A pass is required to get into the old outer city or anywhere else set aside exclusively for Dwarves. Any non-Dwarf wishing to venture into these areas must be escorted by one or more Dwarves. Because of this, there is little in the way of patrols within the Dwarven quarters. Tight security is always maintained around the Sunset Pool, and the entrances to the old and underground cities. Privately employed guards can also be found at the entrances of non-state owned mines and businesses. Unescorted strangers or violence will normally attract 3-8 well armed guards within 5-8 rounds.
- 3 - Even if escorted, all visitors taller than a Dwarf will attract notice and be watched with suspicion. Such activities as just loitering or visibly mapping any of the city will be considered tantamount to theft or spying. Further, living close together underground has built into Dwarven culture a strong sense of privacy and intrusions by outsiders are unwelcome.
- 4 - Ostohar is a large city with a population of several thousand. This means finding one individual will be difficult unless the players have the cooperation of the authorities. This also means it is possible for even a visiting Dwarf to pass himself off as a resident for short periods.

### Rumors

These rumors can be heard among the non-Dwarves in Ostohar:

- 1 - There is a fabulous diamond bigger than a fist hidden in the King's bedroom.
- 2 - The third son of the Duke of Anor's brother is recruiting an expedition to reopen a lost mithril mine.

- 3 - The price of gems has fallen in other lands and there will soon be a panic sale in Ostohar.
- 4 - There is an impending war between the Dwarves and the Elves.
- 5 - A rich noble, Kevent, is hiding in the outer city from the King's guards. He embezzled several thousand gold pieces as Treasury Minister.
- 6 - Dwarven miners have been mysteriously disappearing.



- 7 - A merchant is recruiting guards at double wages.
- 8 - A 10 carat emerald was thrown into the northern fish pond by a thief and has not yet been found.
- 9 - There is an Elf plot to assassinate the King.
- 10 - The Dwarven nobles are looking for an assassin to eliminate one of the Elf Lords.
- 11 - One of the fishmongers found a ruby in a carp he was fileting.
- 12 - There is a plan to ban all (Gnomes, Half-Elves, Men) from the city soon.

### Suggested Adventures for Non-Dwarves in Ostohar

#### The Mine

Dwarven miners have recently been disappearing from one of the deeper mines beneath the city. Dwarven Clerics have determined there is a menace and great wealth near

the mineshaft. The players will be recruited to patrol and stay in the mine until the menace is identified and hopefully eliminated. (Why waste Dwarven lives?)

The miners are sure the wealth predicted is a new shaft of mithril (and they're right). The actual menace is a small "family" of three Hulks who have burrowed into the mine shaft in their travels. Disliking Dwarves, they are taking the opportunity to surreptitiously eliminate a few of them. This adventure will also cause the party to be escorted by their employer across much of the city.

### The Escort

The party will be hired to escort Bloume, a rich merchant, who will tell them he is looking to buy gems. In reality, he is a fence who regularly makes contact with those thieves who prey on the residents of Ostohar (mostly non-Dwarves) and sneaks their booty out of the city. He is already under suspicion by the guards. There will be several small instances of sudden searches, suspicious visitors, etc. to alert the party. The merchant, Bloume Nefar, will be smooth, likable, and sneaky. If the players do consider leaving, he will first offer to raise their pay, then threaten to implicate them if he's caught, and finally speak to a few and claim to be a spy for their original kingdoms. Eventually, Bloume will be caught dealing with a known thief and imprisoned. If the party visits, he will offer them all the gems he has hidden to free him. (The cell will be in the new outer city.) A careful search might also turn up 1,137 gps in gems and semiprecious stones sewn into the lining of one of Bloume's cloaks. If the party tries to leave the city, they will notice that a special guard with a wand that detects gems has been posted at the gate in hopes of detecting Bloume's gang members. Once Bloume is imprisoned, the players will be watched by Dwarves on loan to the guards from the Thieves Guild. These will be skill 1 thieves who will view this as also being part of their training.



### The Spies

The players will be approached BEFORE they reach Ostohar by a cloaked figure. By his frailness, it will still be apparent that he is an Elf. The party will be offered a large sum (1,000 gp per level) for a map of each level of Ostohar. These are only for the three levels of the old and underground cities. The Elf will tell them he has watchers along the road and will know when they leave the city and meet them. He will also set a three week time limit on the offer.

### The Theft

The players will be approached by Bryant, a lieutenant in the city guards. The lieutenant knows a merchant who is known to keep a large fortune in his home. He will recruit the party to assist him in the theft for a one half share to be divided among them. He will also supply passes for the players to enter the old outer city where they can meet him unobserved.

The merchant will live in one of the Noble houses on the second level of the underground city. There will be four Dwarven guards (fighters of skill 2 with battle axes) on duty. If there are any problems, the lieutenant will abandon the party or even "capture" them in hopes of a reward.

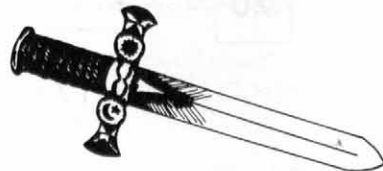

### Random Encounters in the Outer City

Many things occur each day in Ostohar. Most are dull and unworthy notice. Here is a table of some more unusual event which may attract the party's attention.

- 01-10 3-8 Dwarven guards on rounds
- 11-15 Arriving merchant caravan from Anor
- 16-20 Merchant caravan leaving for Anor and looking for guards
- 21-25 Party of revelers, drunk and friendly
- 26-30 Party of revelers, drunk and belligerent
- 31-35 1-6 low level priests
- 36-40 Runaway mule, etc. with rider and cart
- 41-45 Dwarf noble with retainers
- 46-50 Messenger of the King rushes by
- 51-55 Dwarven thief (skill 2-5) attempts to pick pocket
- 56-60 Non-Dwarven thief attempts to pick pocket
- 61-65 Non-Dwarf selling bogus map of the King's palace
- 66-70 Patrol looking for a Half-Elf thief.
- 71-75 Shipment of gold/jewels being escorted to a merchant
- 76-80 Artist or Musician with a small crowd around him
- 81-85 Guards set up barricades looking for a fugitive
- 86-90 Solicited by lady of the street
- 91-95 Violent clash between two merchant's guards
- 96-00 Someone nearby is assassinated with a poison arrow



50'

Icy Moon Lake

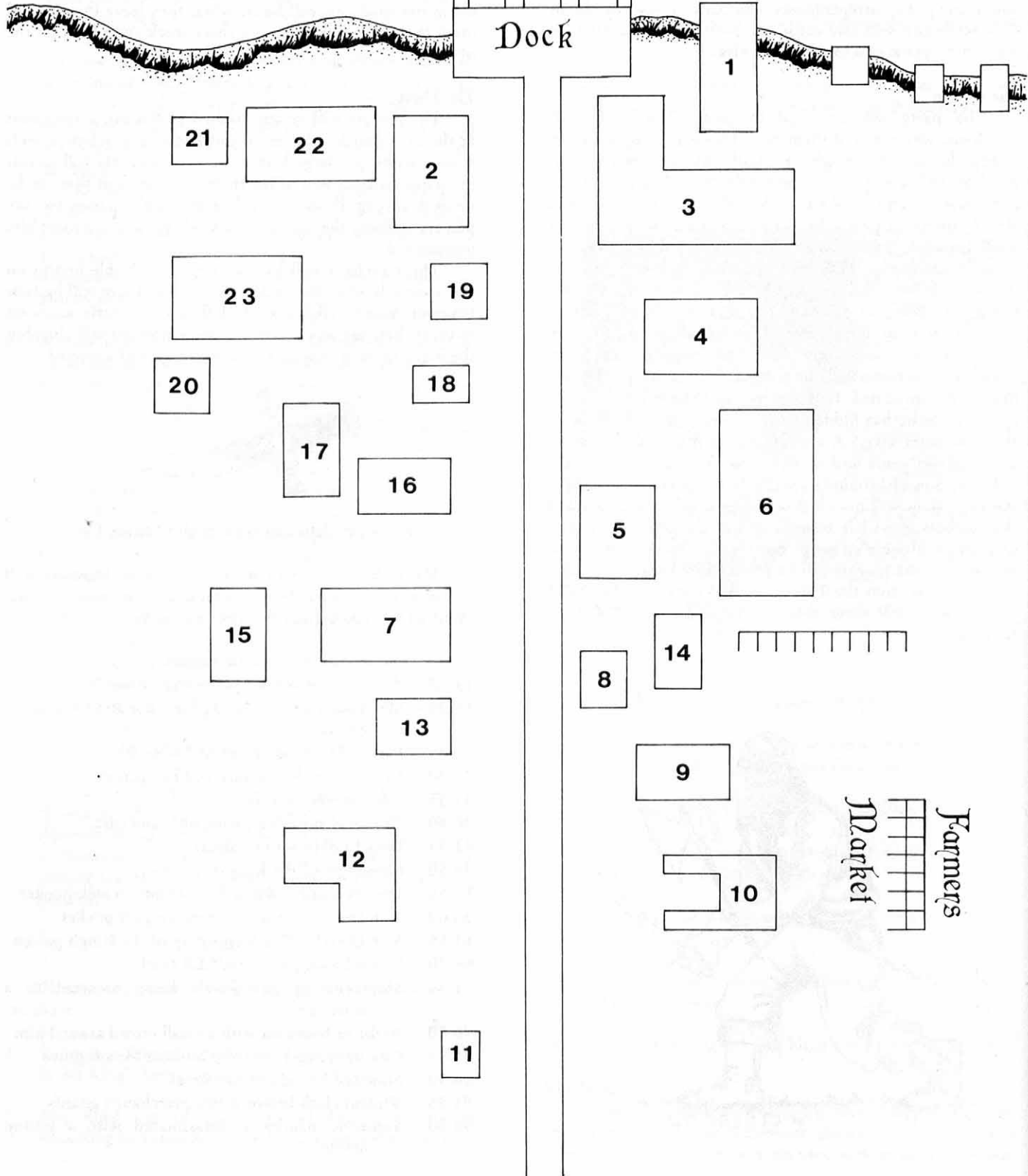

# FIN

Located on the southwestern shore of Icy Moon Lake, Fin is a relatively quiet, nomadic community of some 550 inhabitants. The town was originally settled by nomadic barbarians, but over the years, inter-marriage with the local inhabitants (both Human and Elf) has "civilized" the once warlike people.

Most of the inhabitants of Fin do not live in the city proper, but live on the surrounding farms or in wooden homes built on stilts along the waterfront. From their lakefront homes, fishermen carry on the chief industry of Fin - fishing the Icy Moon Lake. The town serves as a business and social center for the community.

The town is governed by a council of elders, who hold the title of "Speaker." The head of the council (and co-owner of Fish'Inn) is Olaf Morsten. Though in his late nineties, Olaf is as spry and clear-minded as he was in his youth. Olaf usually spends from sunup to noon each day in his small one-man sloop fishing the deeper waters of the lake. During the afternoon, he devotes his time to town business and in the evenings, he takes over the management of the Fish'Inn from his brother, Carr.

Council Head: Olaf Morsten (human)

Fighter, AC: 6, HTK: 42 (6D10)

Stats: 17, 14, 14, 12, 17, 11

Special Item: Magic Boat (will not capsize)

1 - Combination stable/boat house for the patrons of the Fish'Inn (building 3)

## 2 - DAFYDS SUTTLERY

Price: Average Quality: Good - Very Good

This is the town's general store and produce market. Most adventurers will find that their needs can be met here. Dafyd (an Elf) has lived in the town for over 600 years and knows EVERYONE on a first name basis. He is a typical Elf and seems to be perpetually cheerful. Unlike other Elves, he gets along exceedingly well with Dwarves. Dafyd's shop is open sunup to sundown every day.

Proprietor: Dafyd (Elf)

Fighter, AC: 6, HTK: 31 (4D10)

Stats: 16, 15, 11, 9, 15, 14

Special Item: +1 Long Bow

## 3 - THE FISH'INN

Price: Low Quality: Very Good

The Fish'Inn is a well kept two-story building on the lakefront. The first floor of the Inn is taken up by a large dining room and bar, the common sleeping room, and the kitchen. The second floor has semi-private and private rooms. It has a combination stable/boat house (building 1) next to it for the convenience of its patrons.

During the day, the Inn is managed by Carr Morsten, brother of Olaf Morsten. Carr is also a member of the town council.

Manager: Carr Morsten (human)

Fighter, AC: 10, HTK: 8 (2D10)

Stats: 15, 15, 11, 9, 10, 13

Serving Girl: Catania (human female)

AC: 10, HTK: 4 (1D8)

Stats: 11, 13, 14, 11, 13, 17

Serving Girl: Jia (human female)

AC: 10, HTK: 7 (1D8)

Stats: 15, 12, 10, 13, 14, 12

Bartender: Dobbs (human)

Fighter, AC: 7, HTK: 31 (4D10)

Stats: 18/18, 13, 13, 15, 10, 11

Special Item: Staff of Striking

## 4 - THE NETTERY

Price: High Quality: Good

Run by Arlan Thorton, this shop is always cluttered with ropes, nets, buckets, and other odds and ends peculiar to the fishing industry, including a large number of retired fishermen (his staff). If the party is willing to wait 3-4 days and pay 5 gp, Arlan can custom-make a small net for the party to use (a fishing net would be much too large to use as a trapping device in a dungeon). He can also make fighting nets for a cost of 15 gp.

Proprietor: Arlan Thorton (human)

Fighter, AC: 9, HTK: 11 (3D10)

Stats: 13, 14, 11, 12, 16, 14

## 5 - GAILIGS TANNERY & CLIAS DRESS SHOP

Price: Low Quality: Good

Gailig Lanta is a much put upon man. He crafts exceptional quality leather goods from skins he tans himself. However, most of his business takes the form of sporadic groups of adventurers in search of replacement armor. He is forced to export most of his stock to Anor, as the townsfolk do not buy his goods in large enough quantities to support his family. Since exporting is a time-consuming and risky process and if it weren't for his wife's dressmaking business, he would have been forced to close shop long ago. He will be happy to see anyone interested in buying leather goods and armor, and is usually willing to dicker on the price, simply to make a sale.

Clia, his wife and a very good seamstress, makes dresses for the women of Fin. Her clothes are durable and functional. She will make warm, durable cloaks for a reasonable price in only two days.

Owner: Gailig Lanta

Fighter, AC: 9, HTK: 35 (5D10)

Stats: 14, 15, 10, 14, 13, 12

Seamstress: Clea Lanta

Thief, AC: 9, HTK: 18 (4D6)

Stats: 9, 12, 13, 16, 12, 15

## 6 - GRAIN WAREHOUSE

Ernando Cobol runs this storage facility. Farmers store their grain and produce here prior to shipment, for Ernando knows every merchant and caravan leader in the kingdom. As a result, he often gets standing orders for produce and fills the orders as farmers store



their crops. The farmers pay the storage fee willingly, for Ernando often saves them the cost of shipping their products to Anor or Ostohar.

Owner: Ernando Cobol

Thief, AC: -1, HTK: 43 (9D6)

Stats: 14, 13, 10, 11, 18, 13

Special Item: Magical Jug (unending flow of Wine of Inebriation)

#### 7 - SMITHY AND STABLE

Price: Low Quality: Good

This large wooden building is neatly whitewashed and kept in good repair by its owner; Meric the Smith. Meric came to Fin only a few years ago, but was accepted almost immediately by the townsfolk because of his jovial good nature. He is a huge man, as are most smiths, but a very gentle man nonetheless. His work is very good and his prices are low. Stabling rates are the same as at the Fish'Inn. He can repair armor and weapons, but will not accept any orders for new items. Treasure of 283 gp and 500 gp in gems in a secret compartment under the anvil.

Owner: Meric the Smith (human)

Fighter, AC: 7, HTK: 68 (8D10)

Stats: 18/56, 14, 14, 17, 12, 12

Special Item: +2 Hammer

#### 8 - THE GRUB STEAK

Price: High Quality: Exceptional

The town's butcher shop is the only place to buy meat. Fish is a common item in town so the price of meat is rather high. The shop is run by Banock Roseman, a large muscular man in his forties. Along with beef, pork, chicken, and other poultry, Banock also makes some of the finest sausages to be had in the realm, and his reputation is known far and wide. His most closely guarded secret is his recipe for a special sausage that has the lasting quality of hard tack (Beef Jerky) without the toughness or over-spicing of lesser quality sausage. This sausage, called Chercase, costs 5 gp per pound (a pound will last three days - it is quite filling).

Owner: Banock Roseman

Fighter, AC: 10, HTK: 41 (6D10)

Stats: 16, 12, 13, 15, 9, 11

#### 9 - SAIL & NET TAVERN

Price: Average Quality: Good

The Sail & Net is frequented mostly by the fishermen of Fin. While others are not discouraged from visiting, they will receive a somewhat aloof service at best. The fishermen are, as a rule, distrustful of strangers. The owner Barsk Kimweed, is a retired fisherman. The tavern serves wine (5 cp), ale (2 sp), beer (2 sp), hard cider (6 sp), and mead (1 gp). Treasure of 128 gp is kept in a locked box under the bar.

Owner: Barsk Kimweed (human)

Fighter, AC: 8, HTK: 26 (4D10)

Stats: 15, 9, 11, 15, 12, 16

#### 10 - CORN DODGER TAVERN

Price: Average Quality: Average

The Corn Dodger openly welcomes adventurers. Its regular customers are the townsfolk and farmers from around the countryside. The tavern's name comes from the fact that fresh, salty corn dodgers are served free and in unlimited quantities all day and all night long. This tavern also serves food, most commonly a form of fish stew, though occasionally venison stew is available. Fresh sausages are also available on request at

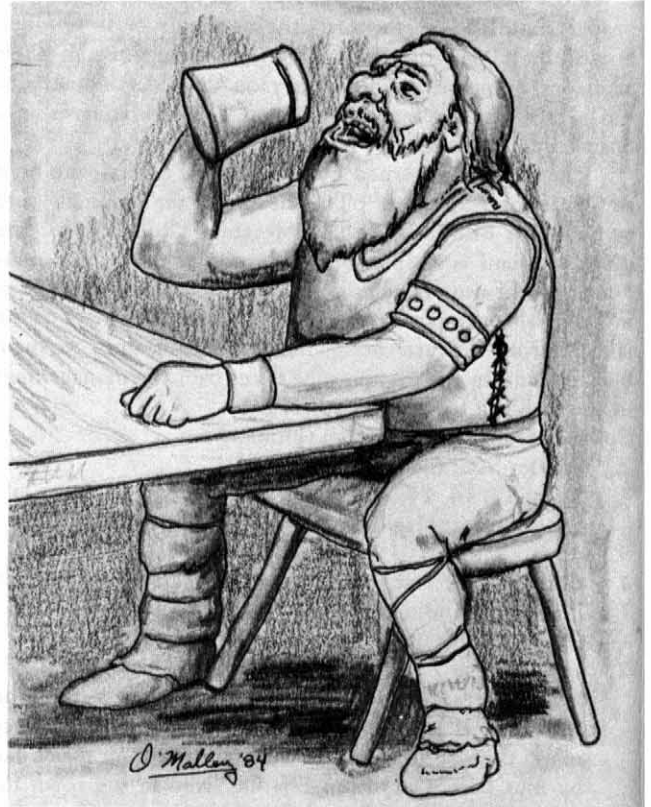

a higher price. The proprietress is a woman named Rosalia, a greying elderly woman whose youngest son tends the bar. Caleb is the only one of her sons who has not gone adventuring, and she disapproves of adventurers discussing their past exploits if he is behind the bar, for she doesn't want him to "get ideas." If the group starts to recount tales of their past adventures, she will politely ask them to stop, explaining her reasons. This tavern serves ale (3 sp), wine (1 sp), whiskey (2 gp), fish stew (1 gp), venison stew (2 gp), fresh sausages (4 gp). Treasure of 231 gp kept in a bowl under the bar.

Proprietress: Rosalinda (human female)

Cleric, AC: 9, HTK: 12 (2D8)

Stats: 9, 13, 16, 11, 13, 15

Bartender: Caleb, Rosalinda's youngest son (human)

Thief, AC: 6, HTK: 5 (1D6)

Stats: 16, 9, 8, 13, 18, 12

12-

## ABARDS CANNERY

Abard Newlton, another member of the town council, is the leading fish processor in Fin. He prepares fish for export by salting and pickling. He also sells fresh fish to the townsfolk at fair prices. Abard will often be looking for caravan drivers and guards to take his shipments of fish to Anor and Ostohar. He will pay 1 gp per day to the drivers and guards, with a bonus of 50 gp going to the guards if there is any actual fighting along the way. Treasure of 4500 gp in gems kept in his apartment in a model of a ship.

Owner: Abard Newlton (human)

Merchant, AC: 3, HTK: 26 (4D8)

Stats: 14, 16, 16, 10, 12, 15

Special Items: Bracers of AC: 3, +1 Ring of Protection

14-

## BARTH THE CORDWAINER

Price: Average Quality: Fair - Good

Barth Gimble makes boots and thus is one of Gailig's best customers for tanned leather. His work is good and his prices are reasonable, despite the fact that Barth is the town drunk. Though he has an apartment in back of his shop, Barth spends most of his sleeping hours in the jail. During the day, Barth usually keeps his drinking to a minimum. Evenings, however, he can be found spending his profits at one of the town's taverns. He has a treasure of 10-20 sp (he spends most of his money on drinks or fines).

Proprietor: Barth Gimble (human)

Fighter, AC: 9, HTK: 12 (2D10)

Stats: 14, 8, 13, 12, 16, 15

15-

## STELOPH'S FISH MARKET

Price: Low Quality: Excellent

Steloph is Abard's chief rival for the local fish business. There has been a price war in progress for more than five years between the two establishments, much to the amusement of the townsfolk. While Steloph does not export; he makes a very good living (despite the competition) and is (along with Abard) one of the richest merchants in town. He has also found a unique solution to the disposal of offal from his shop: He keeps a large pack of cats who are fed the discards. He is also a member of the town council. Treasure of 4300 gp in gems and 232 gp in gold is kept in a secret panel in the shop.

Owner: Steloph Pyttany (human)

Fighter, AC: 10, HTK: 15 (3D10)

Stats: 16, 15, 16, 9, 12, 14

16-

## BREAD WHEEL

Price: Average

Quality: Good

This establishment takes its name from the two businesses that share space in the same building. These are a cartwright (maker of wheels and wagons to put them on) and a bakery. The businesses are run by Laszlo and Zsuzsa Kisgyorgy, brother and sister. She builds the wagons and wheels and he does the baking! Treasure of 116 gp is kept in their apartment behind the shop (building 20).

Cartwright: Zsuzsa Kisgyorgy (human female)

Fighter, AC: 10, HTK: 13 (1D10)

Stats: 16, 11, 12, 8, 17, 11

Baker: Laszlo Kisgyorgy (human)

Fighter, AC: 10, HTK: 4 (1D10)

Stats: 15, 14, 9, 6, 16, 13



23-

## JAIL AND TOWN HALL

The council of elders (Speakers) meet and hold court in the town hall. Records of births and deaths, deeds, and other paper work are taken care of here. The jail is also located in the same building and is run by Tris, the town's sheriff. He is also one of the seven town's "Speakers." Tris also collects fines and taxes. If a person does not have the funds to pay a fine, the amount may be "worked off" at a rate of 5 sp per day in jail. [THE DM IS RECOMMENDED TO SET HIS OWN FINES TO MEET WITH THE STANDARDS OF HIS OWN GAME.] Town Treasury: 580 gp.

Sheriff: Tris (human)

Fighter, AC: 2, HTK: 63 (9D10)

Stats: 18/12, 13, 14, 9, 17, 12

Special Items: Sword of Cold, Broach of Shielding (badge of office)

## Note to DM

The other buildings in town are either residences or may be populated to suit your own particular needs. Remember that this is a small rural fishing/farming community. There is no need for an armorer so there is none, etc.

**ANOR**

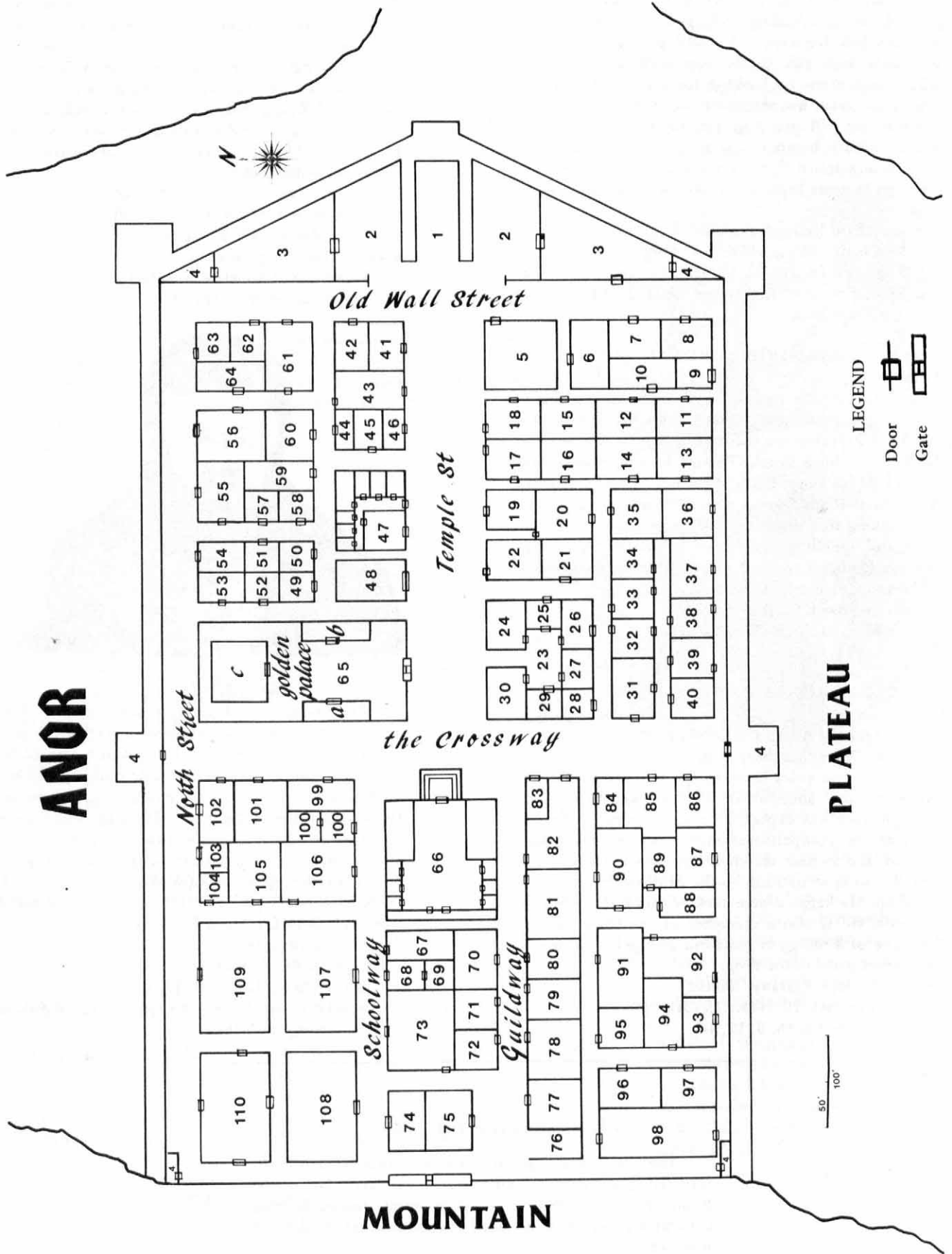

**PLATEAU**

LEGEND

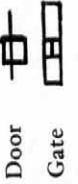

**MOUNTAIN**

# ANOR

Anor's past is one of much bloodshed. Nearly every invading host to reach this region has captured the city. As a result of numerous reconstructions, Anor today is one of the most "modern" cities to be found.

The new walls of the city are 20' wide and 45' tall, built of quarried granite and joined with cement (a new Dwarven product, courtesy of the Builders Guild). Below street level are new water conduits, fed by artesian wells, leading to all the buildings in Anor. There is also an underground sewage system, the first one of its kind anywhere.

All of the buildings are made of stone, and the streets, with the exception of Temple Street, are paved with cobble stones. Temple Street is a true wonder. Instead of traditional cobble stones, it is paved with huge slabs of gold-veined marble. Needless to say, wagons or horses are not allowed to travel down Temple Street, but must go down Old Wall Street and use one of the other streets that lead west.

## KEY TO THE BUILDINGS OF ANOR

- |        |   |         |                                  |
|--------|---|---------|----------------------------------|
| 1.     | The Processional                              | 50.     | Private Home                     |
| 2.     | The Caravanseries                             | 51.     | Crossbows by Whaley              |
| 3.     | Guard Barracks                                | 52-54.  | Private Homes                    |
| 4.     | Stairs to Wall                                | 55.     | Building for Sale                |
| 5.     | Golbard's Stable & Smithy                     | 56.     | Chart the Smith                  |
| 6.     | Tanberts Suttlerly                            | 57.     | Private Home                     |
| 7.     | Waymeet Tavern                                | 58.     | Enorfrue's House of Ale          |
| 8.     | Maron the Cartwright                          | 59.     | Private Home                     |
| 9.     | Tack & Harness Shop                           | 60.     | Weapons by Garth                 |
| 10.    | The Bottomless Mug Tavern                     | 61.     | The Merchants Guild              |
| 11.    | Wianwrights Furs                              | 62.     | The Happy Traveler Tavern        |
| 12.    | The Happy Monk Tavern                         | 63.     | Northwall Leather Shop           |
| 13.    | Bangin Eatery                                 | 64.     | The Oil Well, Oil Shop           |
| 14.    | Tomarts Clothing Shop                         | 65.     | The Golden Palace                |
| 15.    | Armads Archery Shop                           |         | A. Stables                       |
| 16.    | The Rope Works                                |         | B. Guard Barracks                |
| 17.    | Meric & Sons Goldsmiths                       |         | C. Inner Keep                    |
| 18.    | The Gem Shop                                  | 66.     | Temple to All Dwarven Gods       |
| 19.    | Finigan's Bank                                | 67.     | Curates Quarters                 |
| 20.    | Temple Street Bar (Thieves Guild)             | 68.     | Acolytes Quarters                |
| 21.    | Malek the Wine Merchant                       | 69.     | Acolytes Quarters                |
| 22.    | Horace the Alchemist                          | 70.     | Temple Infirmary                 |
| 23-30. | The Temple Street Inn                         | 71.     | Smeeloths Apothecary             |
| 31-40. | Private Homes                                 | 72.     | Randlars Butcher Shop            |
| 41.    | Dusty Throat Tavern                           | 73.     | Clerics Guild                    |
| 42.    | Bit & Bridal Harness Shop                     | 74.     | Smiths Guild                     |
| 43.    | The Shire Inn (Halfings)                      | 75.     | Stonemasons Guild                |
| 44.    | Russo's Bakery                                | 76.     | Guard Post                       |
| 45.    | Starlite Tavern                               | 77.     | Artists Guild/Entertainers Guild |
| 46.    | Amgalar the Silversmith                       | 78.     | Furniture Makers Guild           |
| 47.    | The Palace Inn                                | 79.     | Clothing Manufacturers Guild     |
| 48.    | Residence & Magic Shop of the Arch-mage Trist | 80.     | Bankers Guild                    |
| 49.    | Lambards Laundry                              | 81.     | Architects Guild                 |
|        |   | 82.     | Provisioners Guild               |
|        |   | 83.     | Statues by Armsel                |
|        |   | 84.     | Private Home                     |
|        |   | 85.     | Crosscut Inn                     |
|        |   | 86-89.  | Private Homes                    |
|        |   | 90.     | Warehouse (Military Guilds)      |
|        |   | 91.     | Military Guild Office            |
|        |   | 92.     | Soldiers Meet Tavern             |
|        |   | 93.     | Military Guild Masters Quarters  |
|        |   | 94.     | Guard Armory                     |
|        |   | 95.     | Military Engineers Office        |
|        |   | 96.     | Guards Mess                      |
|        |   | 97.     | Sappers Guild                    |
|        |   | 98.     | Guard Barracks                   |
|        |   | 99.     | Scholars Inn                     |
|        |   | 100.    | Anathar the Scribe               |
|        |   | 101.    | Public Library                   |
|        |   | 102.    | Maleth the Sage                  |
|        |   | 103-4.  | Private Homes                    |
|        |   | 105.    | School Office/Scholars Guild     |
|        |   | 106.    | School Warehouse                 |
|        |   | 107-10. | Public School                    |



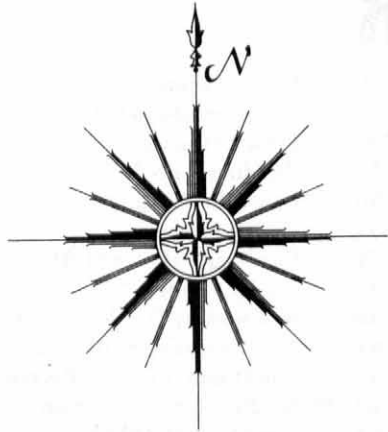

LEGEND	
Mountain	
Non-Forested Hills	
Forest	
Swamp	
Clear/Grassland	
Lava Flow	
Lake	
Village/City	
Road	
Meet Hoosvan	
Encounter	

1" = 20 miles



# THE DWARVEN RITE

## INTRODUCTION TO DWARVEN RITE OF OOVRA DROOM

Oovra Droom is a long adventure. It first took about 41 hours to play. In November 1980, it was used as a tournament at Wintercon held in Detroit, Michigan. There was a concern with the size of the event and I was asked to trim it down. If you also wish to shorten the event, the first segment of Oovra Droom – the journey from Ostohar to Fin – can be eliminated. It was put in originally to give the characters a chance to see each others' capabilities; also to wear them down a bit as the characters are a powerful fighting force. For a shorter adventure, read the Short History and Appendix 1 to the players and start play. Also, please do not pass out the character sheets until after the Short History has been read.

Since the adventure depends on the party proceeding to the Tree of Enlightenment, make sure Knorr and Ivor sit next to each other. If the party wanders the countryside aimlessly, it will be your individual creativity that will be responsible for keeping the players entertained. Even if you wish a shorter adventure, make sure the party has a unified goal before reading them Appendix 1. A suggestion to get them on the right track might be to give Ivor strange dreams of a tree; he could awake with an extreme longing for it.

In any case, please read the entire adventure before trying to play it. The histories are long, and important to the flow of events. Knowing all the backgrounds of the characters will help you understand their motivations, strengths, and weaknesses and will allow you to make the proper decisions when the inevitable conflicts arise. If you are very familiar with the material, Oovra Droom will be easy to run and a pleasure to play.

If you have any specific questions about the adventure, please write me in care of Mayfair Games. Enclose a SSAE (Stamped Self Addressed Envelope).

## A SHORT HISTORY OF THE BARREN RIDGE DWARVES

Dwarves have dwelt in the Barren Ridge as long as anyone can remember. Even the Elves who remember times long forgotten by mere mortals cannot recall a time when the Dwarves were not present in the rocky caverns under the ridge.

About one hundred years ago, the volcano "Firespitter" erupted with much violence and many earthquakes. One particularly nasty tremor caused the earth itself to part and created an 80' wide, fiery chasm which separates the main group of Dwarves from their close neighbors in the Murkey Mountains just to the North. Since any contact between the two groups now involves a long detour and dangerous overland travel, very few individuals voluntarily choose to make the trip.

The current King of the Dwarves, Ael Hoarfrost, is now almost 400 years old. Though he is much admired by all the Dwarves, he has never married or (as far as anyone knows)

sired an heir. About 250 years ago (when he and his brother Gran were in their prime), a disaster struck. One summer night, when Gran was observing the heavens, as was his custom, he disappeared. No trace of him has been found to this day. The King had two second cousins; but both were murdered in the last two years under very mysterious circumstances. Survivors said that many undead of all types suddenly materialized and attacked the King's relatives while they slept. The mere fact that the current King may die without a proper heir has fragmented the Dwarves into many camps, each in favor of one candidate or another.

Two weeks ago, the unthinkable happened! The King's castle was invaded by myriad hoards of undead. Suffering many casualties, the castle guards fought valiantly and managed to preserve the life of the King. Unfortunately, the mighty Dwarven artifact,

The Protector of the Many,  
The symbol of Dwarven Kingship  
throughout time immemorial,  
The Mighty Axe "Sejm"

was lost during the battle. As the invaders vanished from the castle, so did the Ancient Artifact!

Every 75-100 years, or whenever there are enough candidates, the Dwarven Rite of Oovra Droom is held. During this rite the male and female heirs of Dwarven nobles are tested to allow them to prove their value as worthy successors to their family titles. These tests have taken many different paths in the past; from performing services for the royal family to collecting great treasures to be divided among the households represented. In each case, the nature of the service is decided by the current King of the Dwarves.



Shortly after the invasion of the castle, King Hoarfrost declared that the Rite of Oovra Droom was to commence immediately, as soon as all participants could arrive. However, this Rite was to be slightly different from all the others; the Gnomes were sending two candidates to be tested. Also, (and this is even more unusual) King Hoarfrost has agreed to the presence of a human druid as an observer and helper during the course of the Rite. This druid, Ivor Conecap is well known to the Dwarves as he has lived for years in the wooded forest at the foot of the Barren Ridge. The fact that the King would ask for outside help to insure success of the mission is a sure indication of the extreme gravity of the situation.

You, the candidates, have assembled, save for Knorr of the Murkey Mountains. While awaiting his arrival, King Hoarfrost calls you into attendance, revealing he has consulted with the court sorcerer as to the whereabouts of the Great Axe. While in a deep trance, the magician had recited verses which the court scribe has written down. The King is sure that these verses refer to the location of his property and he informs you, as you surely guessed, that the object of this Rite will be the successful recovery of the Great Axe "Sejm."

Haste is of the essence, for the fate of all Dwarves in the Barren Ridge hangs in the balance!

### THE VERSES

Through the valley of the Dragon,  
Where the sleeping Giant lies,  
There, I'm told, lies a valley,  
With orange hills and purple skies.

Within this valley lies a treasure,  
Hidden within a secret lair.  
To find it, locate a floating mountain,  
Hanging in the open air.

Under the mountain is a cavern,  
Filled with many dangerous foes.  
Enter in the normal fashion –  
Climb down to the caverns below.

Once the mountain has been scaled,  
And you've entered the clouds below,  
Then you reach the sacred valley,  
And the entrance . . . Dare you go?

Enter therein to find the Weapon,  
Owned by many Dwarven Kings.  
Return it to the rightful owner,  
For the fame and honor it brings.

This, then, is your one true quest,  
Tarry not along the way.  
Ere the Evil One swiftly strikes,  
And sweeps all Dwarvenkind away.

Having read the verses, the Dwarven participants excitedly whisper to one another. They then explain to the Gnomes and the Druid that an ancient Dwarven drinking song refers to:

*Beardless Dwarven Beauties  
from the mountain in the sky,*

*thee have we long sought,  
but failure has ended every try . . .*

They all thought the song to be the figment of someone's warped imagination, but it appears that there may be some truth in the old rumor that beardless Dwarven women really exist. This Rite may have some interesting benefits after all!

About this time, Knorr appears. You rapidly inform him of the details of the Rite and the verses. Since it is late, you head to bed, preparing to leave at the break of dawn.

Good Luck!

### FOR THE DM: A FURTHER SHORT HISTORY

*or: Who are the Bad Guys  
and How Did They Come About?*

To get the complete picture of the current situation, we must go back about 450 years to the reign of King Fyrn Hoarfrost, father of Ael, (the current king) and his brother Gran:

Fyrn was a jolly fellow who liked to drink vast quantities of whatever was available. One evening, in a drunken stupor, he accepted a bet and took a young Orc serving wench to bed. Unfortunately for him, winning the bet also provided him with a bouncing baby Half-Orc - Half-Dwarf son. He was so aghast at the situation (after all, he was the King of the Dwarves) that he spent a lot of gold to have the incident hushed up and to remove Hrrellda and son, Gnrrsty, to the very outer reaches of the kingdom.

When he grew up, Gnrrsty learned of his true heritage and how he was being denied a chance at the Dwarven throne. He spent his entire adult life perfecting his skills and evil talents, to enable him to capture the symbol of the Dwarven monarchy. Gnrrsty feels that with the Axe in his grasp and sustained by his hoards of undead, the Dwarves will be forced to make him their King.

If Fyrn thought his troubles were over when he made Evail his Queen and settled down to a happy, married life, he was sadly mistaken. A few years after their marriage, Queen Evail presented him with twin boys, first Ael and a few minutes later Gran. Both boys grew up in a happy environment, with everything provided for them. However, Gran knew full well that because of a twist in fate, Ael was destined to be the next Dwarven King while he, Gran, would have no honest opportunity to gain the monarchy. Thus, in his brother's shadow for many years, Gran decided to eliminate the only obstacle that stood between him and the Throne.

With the help of an evil sorcerer, a Demon was summoned to assassinate Ael. However, the court magician discovered the plot and captured all three: Gran, the sorcerer, and the Demon, (before he had completely materialized). The court magician trapped the Demon Bomforth within a pentagram, and King Fyrn was now faced with several unhappy decisions. Most importantly, what to do with the conspirators?

Gran and the sorcerer were immediately sentenced to death. However, the Demon presented a difficult problem: the Demon could not be killed. He had been summoned to do a job and King Fyrn knew he would do his utmost to



complete it. Since the Demon couldn't be killed, he would just retreat to the nether lands and some day return unexpectedly.

Pleading for mercy, the sorcerer agreed to help with the disposal of the Demon. His plan was to force the Demon (knowing his name gave them a great advantage) to change himself into a tree and provide information to all mankind until he could win his release from the people. The Demon agreed to the plan, but altered it slightly. He agreed to remain in thralldom until he had received three Full Wishes and a Polymorph Other spell: he really had no choice, as the sorcerer threatened to dispel him immediately, and spread his name throughout the known worlds (which would effectively eliminate the Demon's power). The Demon agreed to peaceful, cooperative servitude on the condition that his true name would remain unknown to the general populace. King Fyrn agreed and gave his word on the matter. The Demon and the court magician signed the necessary documents and Bomforth was teleported to a lonely spot to begin his service.

Now the genius of King Fyrn manifested itself. He had no intention of allowing the Demon to gather four spells and return to wreck havoc upon his kingdom, so he offered Gran an alternative to immediate death: He was to be polymorphed into a Red Dragon (which it seemed would eminently suit his personality) and geased into serving as

the one true protector of the Demon-Tree. As protector, it would be his prime responsibility to see that the Demon DID NOT (!!!) get his three Wishes and his Polymorph Other spell. He could, of course, exhort whatever he could get from adventuring parties and individuals for the information the Tree would give them. Gran agreed immediately (considering the alternative) to the geas and it was done.

It is now 263 years, 5 months and a few days since the contracts were implemented. The fame of the now-named "Tree of Enlightenment" has spread through certain circles of the kingdom. As usual, the masses could not avail themselves of this "divine" help. In the first case, they were not told that help was available, and in the second, they could not afford the fee required by the greedy, grasping Dragon guarding the tree.

Gran, the Dragon, has amassed a considerable fortune, both from seekers of knowledge and an occasional, unwary adventurer seeking fame and fortune in the wilderness. Though geased so as not to be able to stray more than 10-15 miles from the Tree, Gran has been able to find adequate food and even a mate. Together, they have a satisfactory existence: each other, enough food, and much treasure.

Gnrrsty also has not been inactive. (Remember the illegitimate brother!) Leaving home at an early age, through sheer courage, determination, and awesome evilness, he





rapidly rose to be chief of the Bloody Moon Orc tribe. From this position of power, he was able to deal with and manipulate many other evil beings and creatures. His most important achievement was the recruitment of Kiril, a poor, but brilliant magic-user. Occasionally insane, but completely loyal, Kiril proved invaluable in intimidating anyone with whom Gnrrsty had dealings. Though possessing a warped mind, Kiril had developed a special type of mental control which allowed him to use two wands simultaneously. Kiril usually uses Wands of Lightning and Fear together; a combination he has found to be particularly to his liking.

Gnrrsty has been studying intently to assimilate as much clerical knowledge as he can attain. He has decided that the way to avenge himself on the Dwarves is through the control of the undead, who will fight loyally for him until they are dismembered or dispelled. Having many enemies, he distrusts anyone outside his close circle of friends (and not all of them!).

Through much research (and assistance) he has devised a Cube of Undead control. Similar to a Cube of Force, it allows him to control the actions of an army of undead from a long distance away (see Appendix 5 for specific details on the functioning of the cube).

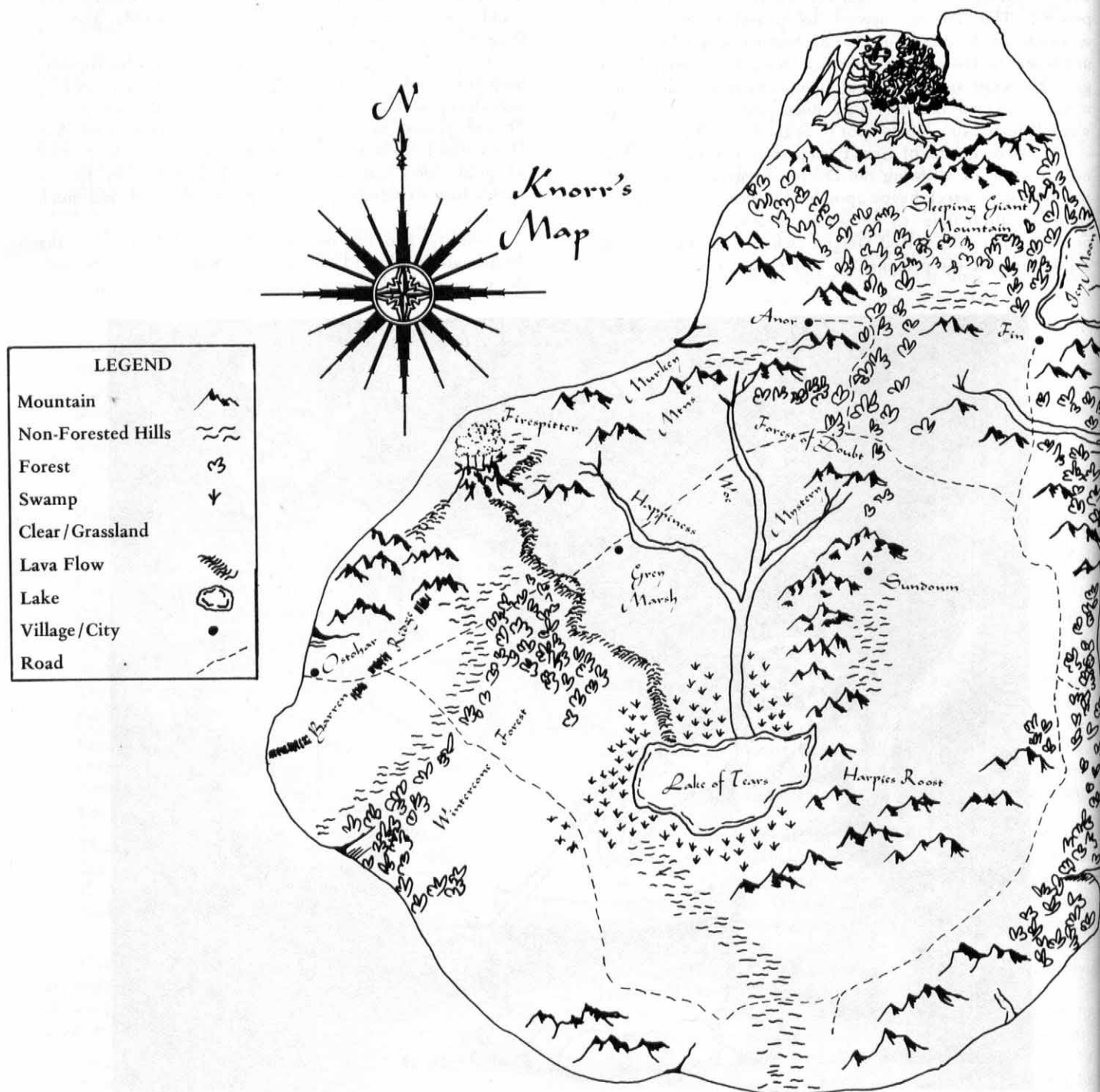

# ENCOUNTERS

Gnrrsty has become quite adept in the handling of his undead army and has used them to pillage several remote villages. Working out all the bugs from his control device, he retested it and successfully eliminated two of King Ael's cousins who had remote claims to the Dwarven Throne. Then came the final test, the invasion of the castle of King Ael himself. Things were going quite well, most of the castle guards had been eliminated when the Vampire leader was killed. Unable to see, Gnrrsty quickly changed cusps, but King Ael had vanished. After searching the castle, Gnrrsty had his troops withdraw, bringing with them the mighty axe Sejm. Using the Cube to return them to his hidden base (via teleportation), Gnrrsty accidentally short-circuited the magic controlling its operation. Capturing the Axe was small consolation for loss of his control center. (By the time the party arrives at his fortress, the Cube will again be operational.)

Also note, King Ael was never told the truth of his brother's disappearance; he still believes Gran was kidnapped by enemies of his father, King Fyrn. Though he has not heard of him in 263 years, he does not really believe him to be dead.

The following encounters are keyed to the maps of the countryside. If the players ignore Knorr's advice and decide not to follow the road, again you are on your own. The wilderness is nasty (see Knorr's history sheet for details).

## DESCRIPTION OF ENCOUNTERS

- 1 - Camping on a dry hillock in a swampy section of road, the camp is invaded by twelve Killer Frogs [AC: 8, HTK: 27, 21, 20, 18, 18, 22, 19, 17, 19, 14, 32, 12 (4D8)].
- 2 - Later that night, a very large poisonous Viper [AC: 4, HTK: 29 (7+2D8)] slithers out of the swamp to attack the party. Its poison is extremely strong, causing 2-12 points damage, even if the saving throw is made.
- 3 - About noon, the party is approached by six Clerics (Alo & Benwa [AC: 4, HTK: 22, 16 (4D8)]; Delm, Drem, & Klar [AC: 4, HTK: 20, 16, 14 (3D8)]; Wynn [AC: 4, HTK: 10 (2D8)]), out collecting donations for the poor. They will not become aggressive unless attacked. They are armed with maces and wearing chain mail. They have already collected 44 gp and a 10 gp gem.
- 4 - As the party is readying their morning meal, 15 Lizardmen (Leader [AC: 4, HTK: 19 (3+3D8)]; 14 Fighters [AC: 4, HTK: 7, 8, 11, 6, 6, 11, 13, 14, 11, 11, 7, 10, 11, 12 (2+1D8)]) attack them.

If the ranger attempts to locate their lair, he has a 35% of so doing. In the lair are 25 more Lizardmen.

Their treasure is concealed under a pile of refuse in one of the huts. It consists of 6150 cp; 6352 ep; 1553 gp; 5 gems.

- 5 - About midnight, three hungry Wyverns [AC: 3, HTK: 42, 46, 41 (7+7D8)] out looking for food discover the campsite and attack the party. Their lair is many miles distant.
- 6 - Just after the evening meal, while the party is settling down for the night (each party member not on watch has a 50% chance to be out of his/her armor) a solitary Land-Shark [AC: 2/4/6, HTK: 35 (9D8)] attacks.
- 7 - In the middle of the afternoon, the party is spotted by a pair of very hungry, hunting Tigers [AC: 6, HTK: 28, 33 (5+5D8)].
- 8 - As they sleep in the forest, the party is attacked about 4 a.m. by nine Giant Ticks [AC: 3, HTK: 21, 23, 19, 13 (4D8); 10, 17, 10 (3D8); 14, 11 (2D8)]. Anyone bitten by a Tick has a 50% chance of contracting a severe blood disease unless a Cure Disease spell is cast within 2-3 days.

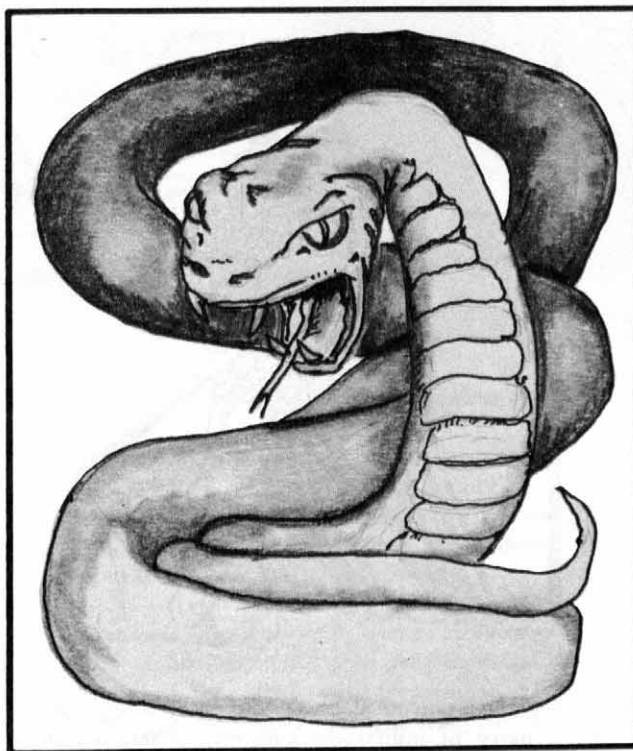

- 9 - About noon, when fording the river, three Giant Lampreys [AC: 6, HTK: 20, 28, 13 (5D8)] attack the horse pulling the cart (65%); or the horse tied behind the cart and anyone fording the river on foot (35% chance). The horses have 22 HTK each; it takes 5 minutes to cross the river.
- 10 - Just after dinner, a Werebear [AC: 2, HTK: 42 (7+3D8)] in human form will wander into camp looking for a meal. He will not attack unless insulted or refused food.

DM Note:

When the players get to Fin, read the following:

Fin is a small fishing and farming community nestled between two mountain ranges and a lake. Entering the town, you find half the townspeople missing and several buildings lying in still-smoking ruins. The local constable explains to you that the damage was caused by a Magic User named Kiril and several dozen undead of assorted types. Kiril had been found the previous evening on the outskirts of Fin, babbling incoherently. He was to be detained in the local jail until morning when Alamandar, the local ranger, would decide what should be done with him. However, late that night, undead materialized near the jail, ripped the walls down, and freed the prisoner. The man then went berserk and, using Wands of Lightning and Fear, destroyed several buildings. Suddenly, he and the undead vanished without a trace.

DM NOTE: For details of this village, see the section describing Fin.



11 - During the noon meal break, the party is approached by a party of military-looking men. There are three sergeants (Ellad [+3 Plate; AC: -2, HTK: 29 (4D10)]; Nort [+2 Plate, ESP Potion; AC: 0, HTK: 22 (4D10)]; Downs [+1 Sword, NSA; AC: 2, HTK: 16 (3D10)]) and fifteen men [swords, chain mail, & shields; AC: 3, HTK: 10, 19, 11, 13, 15 (2D10) 8, 9, 8, 10, 3, 4, 3, 6, 2, 10 (1D10)]. If Fror Ingren is still alive, several of the men will recognize him, especially Nort who served with him on several campaigns. A long party will ensue.

If Fror is not with the party, the patrol will carefully question the party as to their reason for being in the area. They are searching for an insane Magic-User named Kiril. He was broken out of the jail in Fin by an

unstoppable hoard of undead.

If attacked, or stolen from, the men will fight at +2 (for morale and because they thought the party to be friendly). The combined treasure of the men is 102 gp.

12 - The Sleeping Giant Mountain: As the party approaches the mountain, the entrance to a large cavern will be seen. Knorr knows this to be the start of an underground tunnel which leads through the mountain to the other side. The party must decide whether to climb the mountain or to enter the tunnel. If they enter the tunnel, there are three large caverns that the players must pass through to get to the other side (Knorr knows this; they were empty when he last explored them — 15 years ago). It will take them about 6-8 hours to cross over/under the mountain.

13 - If they decide to climb over the mountain, they will encounter two Leucrotta [AC: 4, HTK: 33, 29 (6+1D8)] (not in lair), and then, ten minutes later will be attacked by ten Hippogriffs [AC: 5, HTK: 12, 12, 12, 12, 12, 10, 10, 10, 10, 10 (7+3D8)] (not in lair).

14 - If they decide to enter the tunnel, the party will find the first and third cavern empty. However, four or five hours after the party enters the tunnel, they will come to the second large cavern. It is inhabited by eight Spectres [AC: 2, HTK: 25, 36, 28, 36, 24, 32, 39, 37 (7+3D8)] who have made their lair here and a growth of poisonous Shrieking Fungus [No. 12; AC: 6, HTK: 12 each (2+2D8)]. Their treasure consists of: 784 cp, 2689 sp, 6378 gp, and an Extra-Healing Potion.

15 - Meeting a Red Dragon. When the party arrives at the exit of the tunnel (or climbs over the Sleeping Giant Mountain), they will be able to see an unusually large tree about a half mile away, up in the valley. The tree is several hundred feet tall and has large purple and silver leaves. Also to be seen is a large Red Dragon seemingly asleep in front of the tree.

#### ENCOUNTER INFORMATION FOR THE DM ONLY

This dragon is Gran, the evil brother of King Ael Hoarfrost. He no longer remembers his former life, but he does like Dwarves very much and wants to spend as much time as possible with them (having the Gran/Red Dragon like Dwarves was an afterthought of the Court Magician). He now spends most of his free time thinking about Dwarves and how nice it would be to have them around all the time. Since he is a magic using dragon, Geoffrey Pendragon (what he now calls himself) has acquired a crystal ball and uses it to spy on the activities of the Dwarves in surrounding areas. Use of the crystal ball and long conversations with the Tree of Enlightenment keep Geoffrey well-informed — he knows what the party is after and that they want to talk to the tree!

As might be expected from a Red Dragon, he feels





VERY PROTECTIVE of his source of steady income and will not let anyone approach the tree without first paying a high price. He has even gotten an amulet which allows him to see invisible objects/people and has had it imbedded in his hide, in place of one of his scales. He is not asleep, he is just pretending to be – this will allow him to judge the actions of any approaching beings; if needed, he will call for the assistance from his wife. She is a short distance away in their lair (a large cave) and will be +3 to hit since her mate is being attacked.

If the party elects to have Freca Nimloth (or any other member of the party) approach the Dragon, he will prove to be very friendly. He has a special request to make of them! Before he will allow anyone to approach the Tree, he will tell the party what he wants in payment and states that they must agree first, before any questions can be put to the Tree. His request is simple: He merely wants to be King of the Dwarves!

His logic is this: If he assists the party in recovering the Axe and Ael dies without naming an heir, with the recommendation of ALL the members of the last Rite of Oovra Droom, the Dragon could become King. To prove to the party that his request could be met, he will polymorph himself into a Dwarf (he doesn't look anything like the old Gran).

The party will now find themselves with three choices:

- 1) Fight and kill the two Dragons, or
- 2) Agree to the request of Geoffrey Pendragon and ALL sign a sheet agreeing to recommend him as the next King of the Dwarves, or
- 3) Agree and sign the sheet, never intending to honor their signatures, OR sign the sheet after adding conditions like "We will recommend Geoffrey to be King of the Dwarves only if King Ael dies without an heir." Geoffrey will agree to any reasonable condition.

Once the party has agreed to the conditions and have signed the sheet, Geoffrey will invite them to have a party with him and his wife (he will change her to look like a Dwarf too). They will serve the Dwarves all kinds of goods things to eat. Of course, if the players kill the Dragons, they will find things to eat in the cave, but will not be given a party. Other than allowing the party to speak to the Tree, Geoffrey will not assist or go along with the party (he can't, remember he is geased into protecting the Tree!). If the party really presses for more magical



assistance, Geoffrey has many cursed/negative weapons and magic items he has accumulated over the years – he will be happy to give some of these to the party, after all, he has their signatures on his document – what does it matter if a few of them don't make it home? (DM: You will have to decide what items Geoffrey will give the party. Make them sound very appealing!)

### DRAGON TABLE

Geoffrey Pendragon: Red Dragon, AC: -1, HTK: 80 (10D8)  
Spells: Charm Person, Magic Missile, Mirror Image, Web, Feign Death, Protection from Normal Missiles, Polymorph Self, Polymorph Other.

Crimson Pendragon: Red Dragon, AC: -1, HTK: 60 (10D8)  
Spells: Comprehend Languages, Magic Missiles, Invisibility, Stinking Cloud, Gust of Wind, Blink.

The Dragons' Hoard consists of: 22,606 cp, 41,332 sp, 30,355 ep, 26,977 gp, 28,245 pp, a +3 Spear, +2 Sword of Giant Slaying, +1 Studded Leather Armor, +3 Ring of Protection, Ring of Contrariness (Levitation), Potion of Treasure Finding, Potion of Polymorph Self, Potion of Giant Strength, Potion of Poison, Oil of Etherealness, Potion of Weakness (strength reduced to 4 for 6-12 hours, if save vs. magic is not made), Crystal Ball, and a Scroll of Cure Light Wounds (Druidic). Negative (i.e. "Cursed") magic items are:

When the party gets to talk to the Tree of Enlightenment (remember the tree is really the polymorphed Demon Bomforth), it will tell them it is really Gran, the long-lost brother of the present King of the Dwarves. "Gran" will say he was kidnapped in the middle of the night from his observatory, was polymorphed into a tree, and has remained in his current spot ever since then. Bomforth is quite intelligent (18 + 98%) even as a tree, has the power of speech, and is likely (85%) to know the answer to any question. Bomforth has knowledge of the true identity of the Red Dragon guarding him, and his one burning desire is to be able to eliminate Gran personally. To this end, Bomforth has been able to amass three of the four spells necessary for him to win his release by charging for questions that others put to him. Bomforth has answered many questions during his service as the Tree of Enlightenment and has garnered almost no treasure – only the three spells that were cast upon him. Naturally, Bomforth has a long list of people to visit when he returns to Demon-shape; all those people who promised payment but failed to deliver after answers were given! DM: It is up to you to determine which player or NPC characters in your campaign you wish to have Bomforth visit after he is freed.

To continue with the story: "Gran" will tell the party that he wants to be turned back into a Dwarf and wants to be able to go home! "Gran" will tell the party that he needs a full "Wish" spell to be cast upon him in order for him to return to Dwarf-shape, and will refuse to divulge any information until the party agrees to return with the means (a high-level Magic-User or a scroll inscribed with a Wish spell and a low-level Magic-User) to return him to his normal shape. Since the party does not have any way to bestow a Wish upon the Tree, Bomforth will (have to) accept their promise to return and finish the job. Bomforth also knows that the safest way home for the Dwarves in the party is through the valley and he expects that they will return home past his site. Note: The mountains surrounding

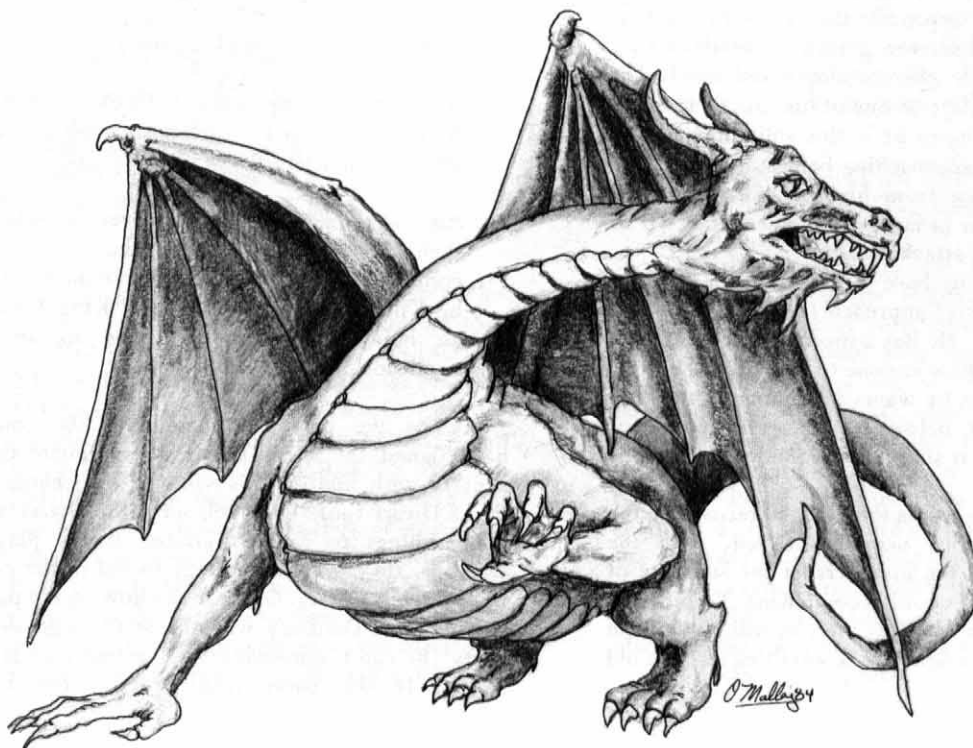



the valley are indeed quite steep, with few trails and many monsters looking for food!

When the party agrees to his request, "Gran" will show the party where to dig among his roots. A small box will be found; upon opening it, eight pairs of violet-colored eye cusps will be seen. Bomforth will tell the party that in order to see the mountain floating upside-down, the cusps must be worn. He does not know which mountain to look at to see if they are indeed upside-down, but will tell the party to find a Satyr named Hoosvan. He lives in the valley to the north of the Sleeping Giant Mountain and has been chasing the myth of the "floating mountain" for most of his life, trying to find its true location. Bomforth will warn the party that Hoosvan will expect payment for his help and that he likes good wine (if the party asks the Dragon, he will supply them with all they can carry).

Also, Bomforth will warn the party not to use the cusps unless they are within sighting distance of the mountain as they distort reality and show most things as they are not. Ugly things seem beautiful (i.e. garbage seems to be wonderful food) and normally beautiful things are irresistible.

DM NOTE: The effects of wearing the cusps (and Bomforth does not know these) are:

- a) The wearer will not want to remove them; a Remove Curse spell must be cast on each cusp in order for it to be removed.
  - b) If both cusps are worn, everything is distorted as described above. If only one cusp is worn and both eyes are used for sight, uncureable insanity for 2-7 days is the result. The player is completely irrational and will perform only random actions until the insanity has run its course; thus, the other players have complete responsibility for the insane player and his actions.
- 16 - Here's where to look. It is now up to the party to find the Satyr, Hoosvan. He is located where the asterisk (\*) is on the map. The wandering monsters will appear only during the days the party is looking for him. If they have not found him by the end of the fifth day of searching, encounter 27 occurs. Encounters 17 to 27 have no set locations.
- 17 - During the evening meal, a family of Giant Skunks [AC: 7, HTK: 23, 22 (5D8) 16 (4D8) 17, 10 (3D8)] wanders into camp. If one of the party members

startles them (10%), they will spray at the party. Unless the party can find wild tomato plants (15% chance per hour searched), they will not be able to completely rid themselves of the smell.

- 18 - In the early afternoon, the party is confronted by a band of seven Centaurs (two leaders [AC: 4, HTK: 29, 26 (4+3D8)]; five troops [AC: 5, HTK: 21, 15, 27, 20, 24 (4D8)]). The two leaders carry shields and all are armed with large clubs (1-8 points damage per hit). Their lair is a few miles away and the ranger has his normal probability of locating it if he wishes. In the lair are 5 more males, 12 females, and 17 young Centaurs. Each of the 7 Centaurs carries 2-8 gp & 1-4 Gems. They can be bribed with a magic item for each leader and 100+ gp for the others.
- 19 - In the early evening, a Chimera [AC: 6/5/2, HTK: 45 (9D8)] out looking for dinner discovers the party. Its lair is nearby, but there are three more Chimera present.
- 20 - Late at night, three Gas Spores [AC: 9, 1 each (1D8)] float into camp to investigate. If not disturbed, they will leave in 5-30 minutes.
- 21 - The party doesn't realize that the hillock they're sleeping on is the home of ten Barrow Wights [AC: 5, HTK: 22, 21, 16, 17, 16, 21, 21, 13, 28, 18 (4+3D8)], who attack about midnight. They are in their lair and their loot consists of: 2883 gp, a +1 Ring of Protection, and two Rings of Delusion.  
When in their lair (if so turned by the Clerics), they cannot be turned and will attack. In their lair is a large rune (indecipherable to the party) placed by Sardas, evil half brother to King Fyrn Hoarfrost; it protects the Wights from being turned.
- 22 - Early in the morning, six Stag Beetles [AC: 3, HTK: 26, 26, 23, 26, 39, 23 (7D8)] march into the camp and attack.
- 23 - In the early afternoon, as the party passes through the woods, they will see a party of five Unicorns [AC: 2, HTK: 16, 20, 21, 19, 26 (4+4D8)]. The Unicorns will not readily approach this party and will fight only if the party attempts to capture them. They will teleport away from the party first. If that doesn't discourage the party, they will attempt to flee, fighting only as a last resort. They have no lair nearby.
- 24 - Early in the morning, a pack of ten common Wolves [AC: 7, HTK: 13, 13, 11, 9, 15, 11, 15, 12, 11, 14 (2+2D8)] chances upon the camp of the party. They have had a successful night's hunting and are not likely to attack first (add +3 to their reaction dice), but will mill about beyond the campfire, howling, and showing their large yellow eyes.
- 25 - Around the noon hour, the party will encounter the perfect camp setting; there is a crystal-clear spring, shade, and fruit trees, comfortable grassy slopes, etc.



It is the home of eight Pixies [AC: 5, HTK: 4, 2, 4, 3, 2, 2, 4, 1 (1-2D8)]. They will allow the party to enjoy their home for 1-2 hours, but no more. They are invisible when the party approaches and unless the party checks for invisible objects, they will not be discovered. After 1-2 hours of free hospitality, the Pixies will begin to steal things from the party. They will tire of this in 1-3 hours and will attack to drive the party off. They live in a hollow oak tree and have no treasure other than normal Pixie items, 1-100 gp, and those items stolen from the party.

- 26 - Very early in the morning, a large beast can be heard crashing about in the underbrush. It will walk into the camp, revealing itself to be a Giant Stag [AC 7, HTK: 29 (5D8)]. It will not attack unless startled or attacked (45% chance of fleeing). If attacked and cornered, it will fight desperately (at +4).
- 27 - If the party has not found him by the end of the fifth day, Hoosvan appears (65% chance to be in the morning, otherwise at midnight) with eight fellow Satyrs.

### MEETING WITH HOOSVAN

He has heard that the party is looking for him and asks what they want. He will be quite willing to help the party, especially if bribed with superior wine and lots of money. Hoosvan LOVES gems and will drop hints about wanting some more; also that he would love a magic weapon. Hoosvan has 27 gp and a 250 gp gem with him; the others have from 1-10 gp each.

For his fee, Hoosvan will direct the party to Spyglass Mountain and will instruct them to look to the southeast at dawn to see the "Unapproachable Mountain."



## SPYGLASS MOUNTAIN

Spyglass Mountain is about 6,000' high; it will take the party most of a day to scale the peak. About 600' below the peak, the party will find a natural hole punched through the mountain. The view is quite magnificent of both the valley and the swamp.

Using the cusps, the party will see the "Unapproachable Mountain" floating peak downward (yes, that's upside down). Thus, people could walk through its space and not run into anything. (Any who try to get close without looking through a Gem of Seeing or the Eye Cusps of Reality Alteration will keep walking toward the mountain, never quite reaching it — treat like a mirage of water on the road; for a while it is in front of you, then suddenly it is off to one side as people walk past it.)

The only way for the party to find the peak is to keep the cusps on while approaching it (conceivably, only one party member could put on the eye cusps and then could guide the party) and if so, the wandering monsters will look much different than what is actually attacking them.

If the party chooses to proceed around the Great Moaning Swamp, it will take them 1½ days to reach the Sky Mountain. If the party decides to proceed through the swamp (shudder! shudder!), it will take them a full two days to reach the Sky Mountain.

DM Note: For encounters 28 - 30, the monster in parenthesis is what those players wearing the eye cusps see and believe it to be.

### 28 - a) Around the Swamp.

As the party nears the western branch of the river, they will hear a rustling and snapping ahead of them. A large group of Army Ants (which appears to be a HUGE Snake) [AC: 2, HTK: 10 each (3+1D8)] is marching from North to South, destroying all in their path. There are 10,625 of them and if left alone, they will proceed on their way (only 5% chance of attack); if the party provokes them, they are most willing to fight!

### b) Through the Swamp.

About noon, the party will stumble upon a party of eleven very hungry Crocodiles (which appear to be Giant Beavers) [AC:5, HTK: 13, 13, 18, 18, 8, 8, 19, 19, 7, 7, 16 (3D8)].

### 29 - a) Around the Swamp.

Early in the evening, after the camp has settled down for the night, three Doppelgangers (which appear to be large Owls) [AC: 5, HTK: 21, 23, 27 (4D8)] imitate the guards and attack them.

### b) Through the Swamp.

Early in the evening, the camp will be invaded by two small, young adult Black Dragons (which appear to be Giant Eagles) [AC: 3, HTK: 24, 24 (6D8)].

1st Dragon's Spells: Detect Magic, Erase, Magic Missile, Shield.

2nd Dragon's Spells: Affect Normal Fires, Jump, Hold Portal, Light.

Their lair is about a half mile away. There is a rocky outcropping with a deep cave under it. In the cave is 41,799 sp, 59,103 ep, two pieces of jewelry, +2 Cursed Berserking Sword, Bag of Holding, Healing Potion, and Scroll of Remove Curse.

30 - As the party is studying the peak of Sky Mountain, some hungry Ankhkegs (which appear to be medium sized Purple Worms) [AC: 2/4, HTK: 25, 30, 26, 20 (5D8)] burrow out of the earth and attack. If any of the party are on Sky Mountain when the Ankhkegs attack, they will not be attacked, as they cannot be seen.

## UP (or is it down) THE UNAPPROACHABLE MOUNTAIN

The proper method of climbing the Sky Mountain is to stand on your head (or be held upside down) and place your feet on a small ledge just below the peak. The peak is floating about five feet above the ground. Once on the peak, a person vanishes from sight unless the viewer is using a Gem of Seeing or the eye cusps. Once on the mountain and using eye cusps, the mountain appears yellow and the sky is purple (also, the eye cusps can now be removed; the mountain and sky will then appear to be normally tinted).

If the party decides to climb up the 11,500' peak, they will readily give up as the slopes are much too steep (a mountain with easy slopes right side up has extremely difficult overhanging slopes when upside down).

If the party ropes themselves together to descend the mountain, all attacks will be at -2 and armor class will be lowered by one due to the lack of maneuverability.

31 - As the party descends the floating mountain (the entire climb will take from 8-10 hours of hard climbing), they will stumble on the lair of 8 huge Spiders [AC: 6, HTK: 10, 9, 13, 9, 7, 10, 11, 12 (2+2D8)]. Their treasure consists of 112 cp, 80 sp, 23 ep, 32 gp, and three gems valued at 50 gp, 85 gp, and 4 gp.







O. Mallery '84

# CASTLE CRAG

## INTRODUCTION

After a day's climb, when the party has reached the bottom (top) of the mountain, they will find only clouds around the base (top of the mountain). The clouds are quite heavy and visibility is only 50 - 100 feet. If the party peers over the edge of the base, they will see a well-travelled path around the upper edge of the mountain.

The path is 15-25 feet wide and extends around the edge of the mountain. Inside the path, the walls are quite steep and rocky; the party cannot, however, see down into the valley in the center. The clouds are quite dense there, and much lightning can be seen flashing about. If anyone decides to lower himself down on a rope, or fly down, immediate lightning damage (2-7 points per bolt) will be meted out. If the player is in no armor or leather armor only, 1-4 bolts will be attracted to him per melee round; chain mail attracts 2-8 bolts per round; plate armor attracts 3-12 bolts per round. Each bolt stays within the confines of the valley. It will not strike those walking on the path or toward the castle (see below).

At one spot, on the eastern side, the path leads out toward the center of the mountain. The path widens out to about 300-350 feet and proceeds for about a half a mile. There, at the end of the promontory, sits a small castle (guarding the way down into the valley). Through the wispy clouds, the party can see armed guards atop the two towers and two large, ugly Trolls guarding large wooden doors. Neither the Trolls nor the Gnoll guards are very attentive, as no party has ever dared attack the castle. Thus, the party can sneak up on the castle with little difficulty.

If the party checks the entire top of the mountain, they will not find a safe path down into the interior valley. The only passage that is protected from the lightning bolts, seems to be the path that leads into the castle.

## GROUND FLOOR

**SOUTHERN DOORS** in the outer wall are each guarded by one Troll [AC: 4, HTK: 31, 39 (6+6D8)]. If one is attacked, the other will sound the alarm and attack the invaders. The Gnolls in the stockyard will be the first to assist them (two melee rounds later) and then the Gnolls in the outer courtyard will arrive (six rounds later).

**WESTERN DOORS** are guarded by two Gnolls [AC: 4, HTK: 8, 10 (2D8)] and a Hyena [AC: 7, HTK: 12 (3D8)] each. If attacked, one Gnoll will sound the alarm with a hunting horn, thus alerting the Gnolls in the courtyard and those in the tower.

**STOCKYARD** has four Gnolls [AC: 4, HTK: 13, 7, 13, 12 (2D8)] sitting on the ledge above the door to the outer courtyard jeering at two captured Elves [AC: 7, HTK: 12, 15 (3D8)] who are being chased by four large Axe Beaks [AC: 6, HTK: 11, 10, 15, 12 (3D8)]. The Elves are armed with short wooden clubs (damage 1-2 HTK

per hit) and so far have managed to evade the Axe Beaks. They are tiring fast and will soon have to fight the ravenous birds. If the Gnolls and the Axe Beaks are killed, and either Elf survives, he will thank the party and immediately leave the castle.

**OUTER COURTYARD** has eight Gnolls [AC: 4, HTK: 7, 15, 9, 10, 9, 6, 12, 11 (2D8)] in the northern section, gambling at the foot of the stairs.

**INNER COURTYARD** contains a small garden. Two steps lead down to a graveled path, four shady trees, and a non-magical pool. There are also two Ogres [AC: 5, HTK: 18, 26 (4+1D8)] and four Hyenas [AC: 7, HTK: 11, 11, 17, 18 (3D8)] sunning themselves in the courtyard. When the alarm is sounded, the Ogres will bar and lock the courtyard doors and they and the Hyenas will rush up the stairs to defend the upper courtyard at the head of the stairs.

- 1 - This is a lounge/bar for the inhabitants of the castle. It allows them to tolerate both the boredom of acting as guards for the valley below, and the incredibly bad food served in the dining room on the other side of the stairs (Room 4). Mounted on the walls are 38 stuffed heads (11 Human, 6 Elven, 13 Dwarven, 8 Gnomish), all victims of the Gnoll's delight in torture. Sleeping in a drunken stupor at one of the tables is a Troll [AC: 4, HTK: 36 (6+6D8)]. If he awakens as a result of the door being opened (20% chance), he will be -4 to hit, but +6 to damage if he connects during the ensuing melee. In his belt pouch are 3 cp and Eyes of Petrification.
- 2 - The doors to this room are very securely locked and bolted on the outside. In the room are kept three adult male Owlbeats [AC: 5, HTK: 30, 34, 26 (5+2D8)] which the Gnolls keep to terrorize their captives into working for them. They can be let into the stockyard via the secret door in the South wall.
- 3 - This is a very foul smelling kitchen. There is a large firepit, an oven, a huge vat of very strong ale, a huge pile of bones in one corner, shelves piled with unrecognizable foodstuffs (awful smelling!), and a sink with a huge pile of greasy unwashed plates and mugs. Four Giant Weasels [AC: 6, HTK: 13, 11, 17, 15 (3+3D8)] live in the pile of bones. The door between Room 3 and Room 4 is always kept open so that they may also get scraps from the dining table. Usually (70%), there is an old Troll female cook [AC: 4, HTK: 29 (6+6D8)] in the kitchen trying to whip up something tasty and edible (success rate = 5%).
- 4 - This is a dining room with large, greasy tables and chairs, smoke-stained walls and blood-stained floors. A huge fireplace on the western wall is giving off thick smoke, making visibility low.

## SECOND FLOOR

**COURTYARD** is an open air area with a low wall in the center allowing those in the area to look down on the Inner Courtyard below. There are stairways leading down to both the Inner and Outer Courtyards.

- 1 – This is the Gnoll's main torture area. It is filled with all manner of torture implements including two racks, a wheel, a brazier of glowing coals, thumbscrews, etc., etc. . . . One of the Gnoll sergeants [AC: 4, HTK: 16 (3+2D8)] and three Gnoll assistants [AC: 4, HTK: 15, 13, 14 (2D8)] are usually (90%) in this room. If not, they are in Room 3/Third Floor getting a victim. The sergeant has a +4 mace.
- 2 – Room of the seven Gnoll sergeants, five of whom are present at this time. The five [AC: 4, HTK: 15, 17, 15, 16, 19 (3+2D8)] are gambling over the loot garnered from their last raid: 55 gp, 10 gems, and three rings (Ring of Swimming, Ring of X-Ray Vision, Ring of Weakness). The sergeants are all armed with +1 Swords. There are also two Hyaenodon pets [AC:7, HTK: 28, 25 (5D8)] in the room. Each of the sergeants has 10-24 gp, 1-12 pp, and 1-5 gems in their chests; all the chests are trapped and locked.
- 3 – This is the room of four Jackalweres [AC: 4, HTK: 16, 22, 17, 24 (4D8)]. All are in human form and are armed with swords. There is a huge pile of gnawed bones in one corner. Some of the time (35%), one of the Jackalweres will be on a scouting patrol with two Ogres from Room 1/Third Floor. If the battle is going badly against them, the Jackalweres will try to escape up the stairs and through the secret door at the top. If they can't escape unseen, they will enlist the aid of the Gnolls in Room 1/Fourth Floor in repulsing the invaders. They will not knowingly reveal the presence of the secret door. They have 125 gp and two gems stashed under the bones.

## THIRD FLOOR

- 1 – The room of the eight Ogre guards. Six are currently in the room [AC: 5, HTK: 14, 15, 18, 19, 22, 19 (4+1D8)] and are armed with very large battle axes that do double damage (2-16) per hit. Some of the time (35%), two of the Ogres will be on patrol with a Jackalwere from Room 3/Second Floor. The treasure of the Ogres is hidden behind a loose block in the North wall (25% chance of noticing it; it is high on the wall). It consists of 5349 cp, 503 ep, two gems and Potions of Levitation and Healing. Each of the Ogres has a belt pouch containing 25-75 gp, some bones, rags, and chewing tobacco.
- 2 – This is a sleeping room for the four Trolls who alternate as main gate guards in 12 hour shifts. Two [AC: 4, HTK: 33, 36 (6+6D8)] are in the room now, sleeping after their shift. They have their pay and looted treasure in a large, brass-bound chest (it is covered with an undetectable contact poison). Their



loot consists of 4041 cp, 4707 sp, a Brooch of Shielding, and a Portable Hole. The entire room is a mess and smells horrible.

- 3 – Both doors leading into this room are securely locked, bolted and barred from the outside (Rooms 1 & 2). Inside the bare room (except for a few straw pallets and toilet facilities) are housed the 15 captives the Gnolls use for slave labor; all are very weak and badly tortured. The 5 humans, 2 Elves, 3 Dwarves, 2 Gnomes, and 3 Hobgoblins have nothing of value, do not know where they are or how to get home, and cannot aid the party in any way. All have been prisoners for 8-18 months.

## FOURTH FLOOR

- 1 – This is the guardroom for the Gnoll Guards that patrol the roof. The door is ajar and the eight guards in the room can be heard quite clearly in the stairwell. The eight [AC: 7, HTK: 11, 10, 15, 11, 13, 15, 11, 16 (2D8)] are shooting with their crossbows at a large target on the north wall and betting loudly on each other. Sleeping under the bunks on the east wall are three Hyenas [AC: 7, HTK: 21, 22, 19 (3D8)]. Each Gnoll is carrying from 5-25 gp and there are 45 gp (the current pot) on a table near the bunks.

# CASTLE CRAG

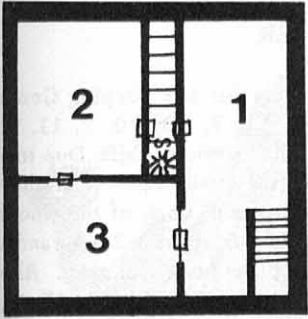



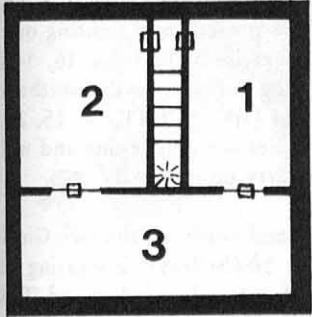
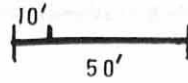



4th Fl.



3rd Fl.

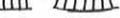

LEGEND

- Circular Staircase 
- Normal Door 
- Secret Door 
- Tree 
- Pool 
- Gravel Path 
- Stairs 

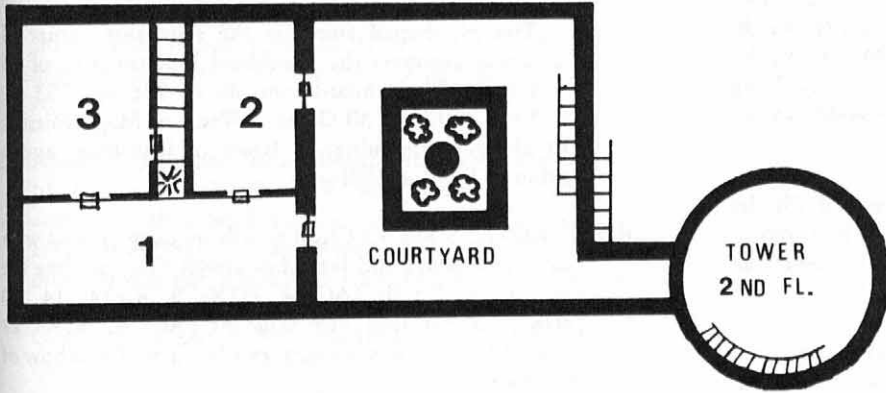
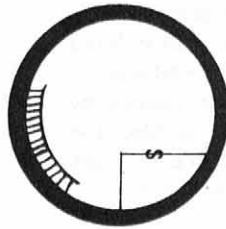

2nd Fl.

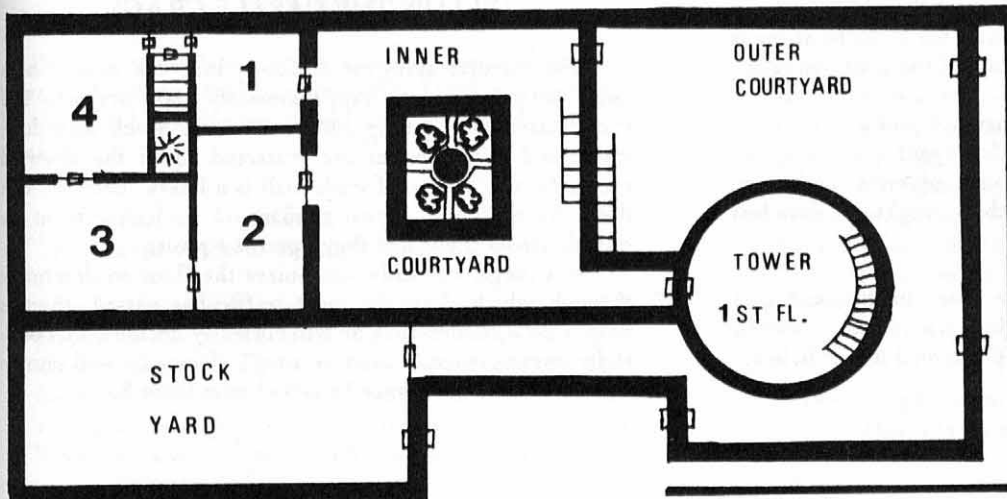

Ground Floor



**ROOF** A stairwell in the southeast corner of the room leads up to a ceiling trap door. The trap door can be locked and bolted from either the inside or outside, but currently is not locked or bolted. On the roof are four Gnolls [AC: 7, HTK: 2, 10, 12, 9 (2D8)] and one Gnoll sergeant [AC: 4, HTK: 22 (3+2D8)]. All are armed with heavy crossbows and swords; the sergeant's sword is +1.

2 - The doors to this room are stoutly barred from the outside (three bars each). Inside, the room is full of smashed furniture, some chewed up vines and fruit and a Paleocincus. It is a small one (only 8' long) [AC: -3, HTK: 38 (6+2D8)] that the Gnolls captured in the valley below. If a door is opened, it will immediately charge to escape! Woe to anyone in his path! The Gnolls felt that it would prove to be invaluable in torturing captives, if they could control it!

3 - In the center of this dusty room (no footprints) is a large crystalline box. It is securely fastened to the floor and nothing can be clearly seen of the inside of the box. From the top protrude four rods with colored crystalline knobs. The rods rest on stops and can be moved in only one direction. The rods cannot be budged if the doors to the room are open. Also, the effects of pulling more than one rod together are cumulative!

**Gold Knob:** Summons an Aerial Servant [AC: 3, HTK: 62 (16D8)] to attack the person pulling the knob; will transport him/her to Gnrrsty. May be found (if lightning damage is survived) in Building 5/Basement 1/Room 1 of the Emerald Valley Citadel.

**Black Knob:** Sets off an alarm to warn the Citadel below. The alarm cannot be heard in the room or the Castle Crag. Also, a small box will fall from the ceiling. It contains a Ring of Delusion.

**Silver Knob:** Sets off an Ice Storm (as per spell) inside the room (no saving throw allowed; 3-30 HTK damage each).

**Blue Knob:** Treat as if a Wand of Wonder had been fired into the room; however, the Flesh to Stone is of only temporary duration. First party member to awake will see the rest as stone statues decorating the Inner Courtyard and a large party going on in the Outer Courtyard (i.e. drinking, roasting an unknown haunch of meat, and other debauchery). After all, they caught the invaders and saved their jobs!

**SECRET DOOR** At the top of the stairs, in the south wall is a secret door. Opening the door will reveal a stairwell that will lead the party to the Octagonal Room below!

## TOWER

**FIRST FLOOR** Sleeping quarters for ten sleeping Gnolls [AC: 4, HTK: 12, 14, 5, 11, 7, 10, 10, 7, 11, 12 (2D8)]; the guards from the previous shift. Due to a lack of fighting recently, they will fight with their customary ferocity when aroused. Each of the Gnolls has a belt pouch containing 1-6 ep and 2-5 gp and a few greasy scraps of meat or bone splinters. Also sleeping are six Hyenas [AC: 7, HTK: 14, 19, 17, 18, 12, 20 (3D8)].

**SECOND FLOOR** Sleeping quarters for another 10 Gnolls, but 14 Gnolls [AC: 4, HTK: 15, 12, 11, 7, 9, 9, 8, 11, 9, 12, 7, 9, 4, 12 (2D8)] are present and fighting over possession of two Elven females (Charisma 16, 14); The two captives are cowering in fear near the northern wall guarded by five Hyenas [AC: 7, HTK: 7, 15, 21, 14, 14 (3D8)]. The two ladies are courtesans and will decline to accompany the party on its quest.

**THIRD FLOOR** Sleeping room and study of the two Gnoll leaders. One [AC: 2, HTK: 30 (5+2D8)] is wearing +2 Splint Mail and armed with a two-handed sword. The other leader [AC: 3, HTK: 38 (5+2D8)] is wearing normal splint mail and carrying a +1 Sword of Wounding. They are arguing over who should get the Helm of Kobold Strength lying on the table. The Helm reduces strength to 4.5 and requires a Wish to remove it.

The pie-shaped room in the southeast corner of the tower contains the combined loot/treasure of all the Gnolls. Their hoard consists of 936 cp, 103 sp, 1872 ep, 3407 gp, 30 Gems, a Wand of Magic Missiles (90 charges remaining), a Rope of Climbing, and a Potion of Invulnerability.

**ROOF ALWAYS** has 3-6 Gnoll guards on duty, armed with heavy crossbows and lots of quarrels! They are like the rest of the Gnolls [AC: 4, HTK: 9, 8, 14, 14, 10 (2D8)] except that one sergeant [AC: 4, HTK: 17 (3+2D8)] is always present and has a +3 Crossbow of Accuracy.

## OCTAGONAL ROOM (BELOW THE CASTLE CRAG)

The circular staircase descends into the center of a large octagonal room (approximately 50' across). The room has a 120' ceiling and is deserted. Much dirt, dust, trash, and a few bones are scattered about the deserted room. In the center of each wall is a heavy, battered oak door. All the doors appear similar and are locked from the outside (from the inside they open at a push).

If a ranger carefully scrutinizes the floor to determine through which door the most traffic has passed, there is only a 25% chance that he will correctly decide on Door 6. If he guesses wrong, there is a 66% chance he will choose Door 3 and a 34% chance he will choose Door 8.



### DOOR 1

*Opens to a passage leading to Room 1.*

- 1 - This room has smooth marble pillars every 10' around the room, except for the southwest corner where the ceiling has collapsed, taking two pillars with it. A Tripus is searching the rubble for several rats he chased there. The Tripus [AC: 0, HTK: 57 (12D8)] will immediately attack at the party's appearance in the room.
- 2 - Appears to be only 20 x 20 with the door in the center of the south wall. The east, west and north walls are covered with a thick coating of Brown Mold [AC: 9, HTK: 0 (0D8)]. In the center of the room (near the mold on the north wall) is a stone block 3' on a side. A crystal dome on the top of the block covers a pair of Golden Lion statues. The dome is secured to the block and cannot be broken; if the stone block is rotated clockwise, the dome will open.

### DOOR 2

Door 2 opens into a short corridor also leading into Room 1. However, the corridor is filled with rubble from the collapsed southwest corner of the room and is impassible.

### DOOR 3

*The corridor behind this door leads to Room 6.*

- 6 - A trap! If any door on the east wall is touched, the person is teleported into the appropriate chamber where a hungry monster is awaiting visitors . . . The north door is a teleport to Room 3; the middle door is a teleport to Room 4; the south door is a teleport to Room 5. Each of the chambers has a small escape tunnel (players find it as they would a secret door), walls covered with phosphorescent moss, giving easy

visibilty, and a small pool of spring water. Any treasure in the caverns is a result of unfortunate adventurers being trapped and killed.

- 3 - Contains a Roper [AC: 0, HTK 48 (12D8)] and 4803 ep, 71 pp, and 32 gems. A badly rusted +3 sword (NSA) can be found in the pool.
- 4 - Contains a Giant Slug [AC: 8, HTK: 69 (12D8)] and a huge pile of coins, armor and some weapons. All are valueless due to the corrosive effects fo the Slug's acid saliva.
- 5 - Contains a small Rakshasa [AC: -4, HTK: 24 (7D8)] who has changed himself to look like an extremely comely female Elf. The Rakshasa has been geased to remain in the room for a period of service in return for a favor Gnrrsty granted him. The Rakshasa has his treasure stashed in a chest buried in the mud of the pool bottom; it consists of 12,500 gp, 15,750 ep, and a Mace of Disruption. She will say she was fleeing from a Titan and wound up in this cavern, unable to find the way out.

### DOOR 4

The corridor beyond this door leads to Room 7 and contains a trap. Whenever anyone steps on the keystone (see map) a block of stone (shaded area) will rise from the floor with a great grinding noise and a huge shower of dust (The block will reset itself into the floor after 12 hours).

- 7 - Set up as a Grecian Forum and contains a 15' Frost Giant [AC: 4, HTK: 56 (10+4D8)] dressed as a Titan. He is fair skinned, with auburn hair and blue eyes - there is only a 5% chance anyone will notice that he is not a true Titan. The players can buy the secret of the sliding stone from him, but at a high price. Behind his seat is a small lever; When pulled, the stone block in the corridor will automatically lower itself.

### DOOR 5

*Leads to the twin Rooms A and B.*

- A & B Each is a 10' by 10' Room with a door on the wall opposite to the door the players enter. This second door will not budge unless the first door is closed; then the floor drops away and the players drop into a 30' pit containing four large spikes (25% chance to hit each player per fall). The fall causes 1-8 points damage. The 10' x 10' space behind the door is treated with a permanent illusion to appear full of gems, jewelry, and weapons (i.e., if Ring of X-Ray Vision or Helm of Telepathy is used to discover the contents of the room beyond).

### DOOR 6

*The passage behind this door leads to Room 8.  
This is the way the party should go.*

- 8 - This large room contains a large 15'x5'x3' high black marble slab in the center of the room. Two sarcophagi

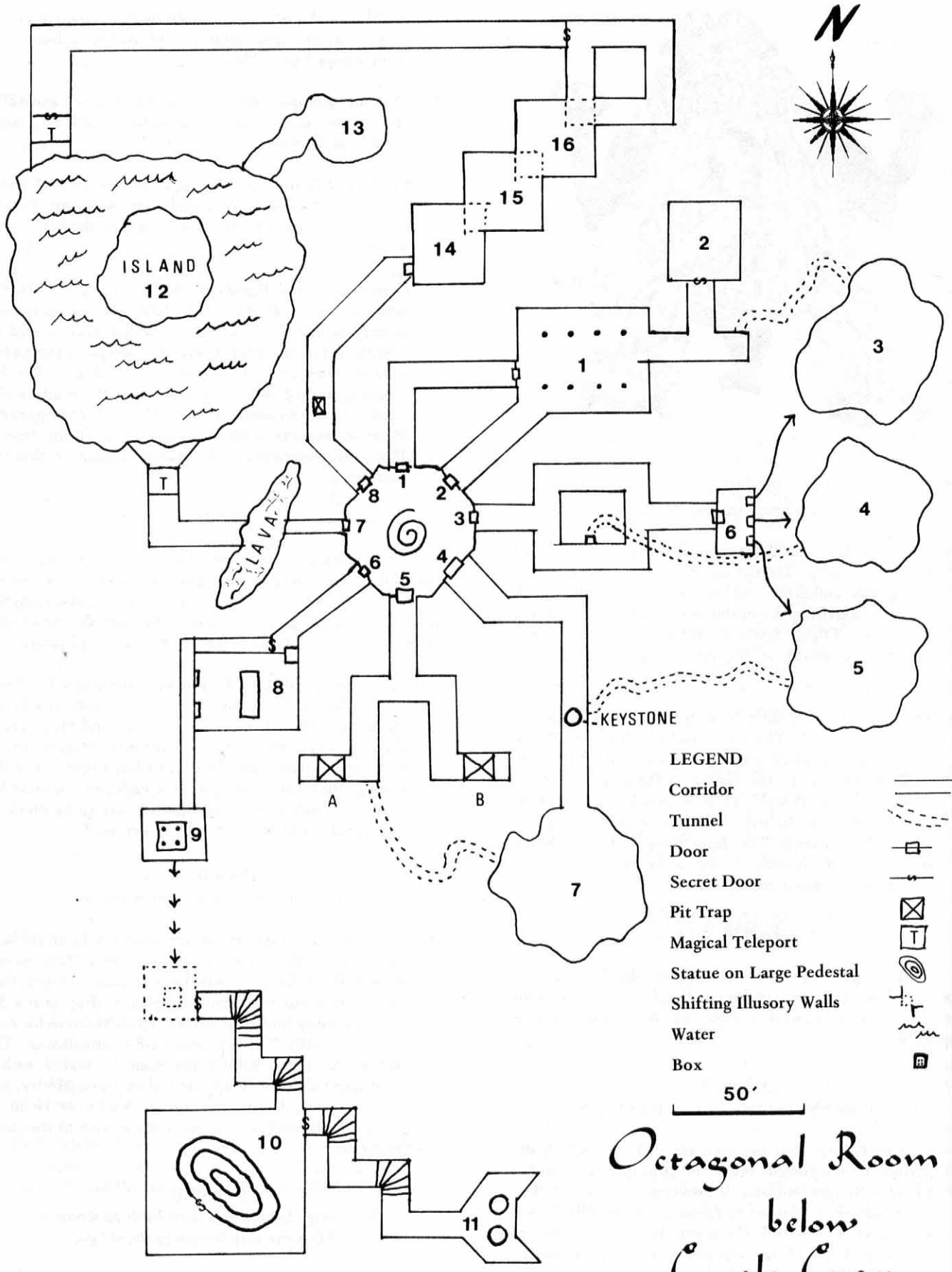

- LEGEND**
- Corridor
  - Tunnel
  - Door
  - Secret Door
  - Pit Trap
  - Magical Teleport
  - Statue on Large Pedestal
  - Shifting Illusory Walls
  - Water
  - Box

50'

*Octagonal Room  
below  
Castle Crag*

stand open on the west wall; a Mummy has just been placed in each [AC: 3, HTK: 37, 25 (6+3D8)]. Seven Zombies [AC: 8, HTK: 7, 9, 10, 5, 6, 4, 7 (2D8)] are preparing a third Mummy from a dead body; another sarcophagus lies open on the floor waiting to receive the finished Mummy. The Zombies and the two finished Mummies will fight any who disturb them.

Both the north and south walls are lined with shelves filled with beakers of chemicals, bandages, knives (and other medical implements). There is a smoking brazier in the northwest corner of the room. There is no treasure in the room. The secret door next to the entrance to this room opens into a passage leading to Room 9.

9 - Is mobile! It travels through a tunnel between the points shown on the map (there is a 65% chance the room will be in the north position). In the north corridor leading to the room, a large gem is set into the wall (it is a 5 gp quartz gem). When touched, it lights and calls the room (if the room is at the northern end of the track, the gem will flash once). The door to the room can be opened once the room is at the north end of the track; if the gem in the northern corridor is glowing, it will go out when the room arrives.

Inside Room 9 is a black crystalline block with four colored handles protruding from the top. There are no tracks for movement; the handles must be pulled straight up for any effect to occur. The handles will not budge unless the north door is closed. The south door cannot be opened until the room has moved to the south end of the track.

Each of the handles has a different color; Gold, Black, Silver, and Blue (same colors as on the block in Castle Crag above) and a different effect:

**Black Handle:** Pulling this handle causes two spells to be simultaneously cast:

- a) A Diminution spell that reduces all humanoids in the room to ¼" tall and,
- b) A Massmorph spell that causes the entire room to appear to be an arid plain.

At this scale, it will be approximately 600' to any of the walls (the walls and the crystalline block cannot be seen, just felt, until the south wall is touched). When the south wall is touched, the illusion is dispelled and the players will grow to normal size. Roll for wandering monsters normally while the players are in this state; they will meet ordinary creatures that are as large or larger than they are.

#### Creature Encountered (Roll D6)

- 1 Giant Ant. . . . . [AC: 3, HTK: 20 (4D8)]
- 2 Giant Spider . . . . [AC: 4, HTK: 18 (4+4D8)]
- 3 Giant Centipede. . . [AC: 8, HTK: 15 (3+2D8)]
- 4 Giant Caterpillar . . [AC: 9, HTK: 33 (5+3D8)]
- 5 Giant Cockroach . . [AC: 4, HTK: 21 (3+3D8)]  
(does 1-4 per bite, plus disease)
- 6 Giant Wasp . . . . . [AC: 4, HTK: 22 (5D8)]  
(does 1-12 per bite, 1-8 per sting, plus poison)

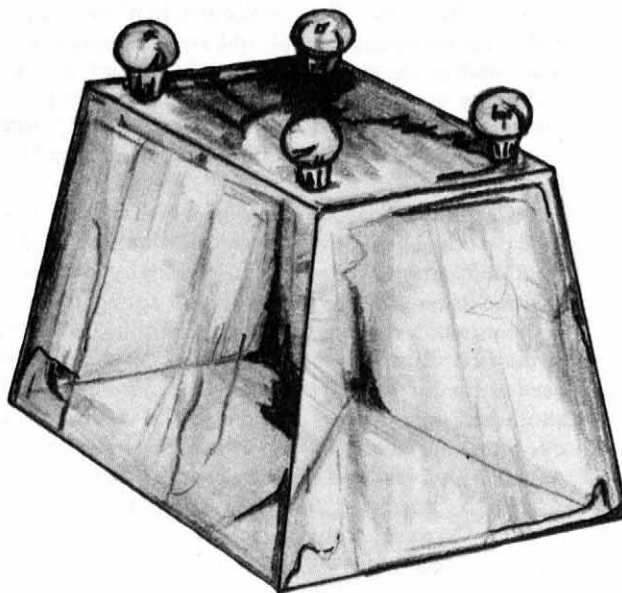

**Gold Handle:** Pulling this handle causes a Levitation spell to be cast on all in the room; save at +2 to roll or float to ceiling regardless of armor worn. The ceiling of the room is composed of a very good lodestone (magnet). The Levitation spell (for those wearing only leather) lasts for 10-60 minutes.

**Silver Handle:** Pulling this handle releases a silver mist from the base of the crystalline block, and causes two spells to be cast:

- a) A Putrify Food and Water (spoiling all the party's supplies), and,
- b) A Cause Light Wounds (2-9 points of damage).

**Blue Handle:** Pulling this handle causes a Continual Light spell to be cast inside the crystalline block (illuminating the room) and sets the room in motion to the other end of the track.

Once the room has moved to the south end of the track (taking 5-9 rounds) the secret door in the east wall, once discovered, can be opened. The corridor beyond the secret door leads to Room 10.

10 - In the center of this large room is a very large statue of a 9' tall humanoid with 50' wide web-like wings (it is supposed to be the Assassinator of the Gods). Also in the room are twelve human clerical types - one third level [AC: 3, HTK: 25 (5+4D8), Spells: Cause Light Wounds, Cause Fear, Bless, Chant, Spiritual Hammer, Feign Death]; four 2nd level [AC: 4, HTK: 8, 14, 10, 14 (2+3D8), Spells: Cause Light Wounds, Cause Fear], seven 1st level [AC: 5, HTK: 7, 6, 9, 3, 4, 3, 7 (1+2D8), Spells: Cause Light Wounds] - preparing for a ceremony.

All of the Clerics are wearing brown robes over their armor, making it difficult to determine armor class (or who the leaders are!).



## DOOR 7

The evil Clerics have opened the secret door in the back of the statue (they will close it when the party makes its presence known) and are removing crimson robes and other ceremonial trappings from the room under the statue. In the room are twelve large gold candlesticks (150 gp each), a large (8'x4'x2' thick) slab of solid mithril mounted on rollers and a sacrificial knife made of a single giant ruby (value 1500 gp).

The mithril slab is VERY heavy and cumbersome and cannot be removed from the dungeon without great difficulty. It also has a curse placed upon it: Anyone attempting to melt down or cut apart the slab will contract a random fatal disease within 1-6 months. If the first disease is cured by a 12th level cleric (level needed for the Cure Disease Spell to have any effect), another disease will be granted to the victim and this one must be cured by a 13th level cleric, the next disease by a 14th level cleric and so on indefinitely.

In the northeast corner of Room 10 (outside the curtain), a secret door in the east wall conceals the passage to Room 11.

*This is the room the party is looking for*

- 11 - This odd-shaped room contains two wells filled with very foul-smelling water. Players must save vs. spells or become extremely nauseous and unwilling to approach the wells. These wells are in reality stairwells to the valley below; the water and the nauseating stench are a Permanent Illusion.



Past this door, the passage has been ruptured by an earthquake and a 20' rift has been opened in the floor. Bubbling lava can be seen about 500' below the floor of the passage. On the other side of the chasm, the passage continues. Shortly after the passage turns northward is another trap, a teleport that transfers only the odd numbered players to the small island in the middle of the hot lake. There is no guaranteed way for the players to get off the island, since the monsters in Room 13 were placed there to eliminate intruders.

- 12 - The island will usually be reached only via the teleports in the floor (if the floor is not walked upon, they do not work). The teleports work, no matter which direction they are entered from. The island is surrounded by VERY HOT water, due to exposure to the volcanic elements far below the surface of the lake. Anyone trying to swim ashore will take 1-12 damage for each turn in the water.
- 13 - The cavern at the northeast corner of the lake contains the lair of two Flying Spirit Nagas [AC: 4, HTK 42 (10D8), 40 (9D8)] who love to attack adventurers trapped on the island. They can be bribed, but VERY substantial sums must be offered. Their hoard consists of: 6,840 cp, 1,362 sp, 2,699 ep, 459 gp, five +1 Swords, a +2 Sword, a +1 War Hammer, a +2 Mace, a Wand of Cold - 3 charges left), a Phylactery of Faithfulness, a Potion of Flying, a Potion of Delusion, and a Potion of Healing. There is much armor lying about. All of it is ruined and completely unusable.

## DOOR 8

*Leads to Room 14.*

There is a trap door in the center of the northward section of the corridor. It opens on 5-6 usually, but on 3-6 for persons in plate armor. It leads to a 40' drop into very hot water 12' deep. No damage is taken from the fall, but 1-12 in heat damage will be taken for every round a player is in the water.

- 14 - Basically empty. It contains a few bones and rubbish scattered about. The northeast corner appears to be normal, but when anyone enters the northeast square, they will find themselves in the southwest corner of another 30'x30' room (Room 15). If the player moves backward through the illusory walls of the southwest corner, he will find himself back in Room 14; otherwise he must move past the northern or eastern boundaries of the 10'x10' and then move back inside the square. Then he will find himself back in Room 14.

Rooms 14-16 do not contain teleports, just shifting illusory walls that make it seem that teleports are involved. Players disappear when in the 10' by 10' area.

15 - Has two such sets of illusory walls in the northeast and southwest corners. In the room are five Minotaurs [AC: 6, HTK: 34, 23, 38, 30, 33 (6+3D8)] roasting a humanoid over the small fire. They are all armed with large double-bladed axes (1-10 points damage) and will fight to the death. Each is carrying only 1-6 pp and perhaps (25%) a gem, These are secreted in a hollow under the brass knob at the handle-end of their large axes.

16 - Similar to Room 15 with illusory walls in the northeast and southwest corners. The walls are a slimy green; no, not green slime, but a moss that closely resembles it! The moss is tasty and, for each ounce eaten, will restore 1-4 HTK. The moss has no treasure and will not attack (unable to move).

There are no wandering monsters in the Octagonal Room section of the adventure. If you must check for them anyway, the following will appear ONLY in the Octagonal Room, remain for 1-12 turns and then proceed up the stairs (65%) or toward Room 6 to get water out of the spring (35%).

**DIE ROLL**

- 1 1-10 Gnolls . . . . [AC:5, HTK: 13, 9, 15, 10, 8, 5, 12, 16, 9, 12 (2D8)]
- 2 1-2 Trolls. . . . . [AC: 4, HTK: 30, 28 (6+6D8)]
- 3 1-8 Evil Clerics . . [AC: 5, HTK: 8, 6, 7, 3, 5, 9, 8, 8, (1+2D8)] armed with maces.



# THE EMERALD VALLEY

## THE EMERALD VALLEY

As the players descend the hidden stairs in Castle Crag (see Octagonal Room), they will discover that they are in a rocky cave (the stairs are about 100 yards long) which contains a large pool and opens into the hidden valley. There are no other exits from the cave. Hiding places abound, for there are many large cracks in the walls and boulders litter the floor.

As to the valley itself, It contains large bodies of open water, large marshy areas, and some open areas (volcanic flows that have not weathered into earth). Growing everywhere are spindly trees with huge odd leaves (ginkgo trees), large (12') ferns, palm trees of all sorts and much bushy shrubbery.

DM NOTE: If you have ever seen the movie, "Valley of the Gwangi" or "The Lost Continent" where prehistoric conditions are encountered, you know what the players have just found!

As the players move out of the cave, the head of a Brachiosaurus will emerge out of a nearby lake with a splash. Eyeing the party momentarily, it will disappear into the weedy depths of the lake!

There is a fairly safe well-beaten path leading into the distance. Through the trees, a partially destroyed castle can be seen about five miles across the valley (show picture). It is on a small hill that rises above the valley floor. The sky above is light, but filled with rolling clouds. Occasional lightning flashes can be seen, but no thunder is heard. The outside world is effectively cut off by the thick banks of clouds.

The players now have a choice. They can travel along the path the castle (and find wandering monsters on both 5 & 6 of a die roll) or can proceed along safe passages (15% chance per turn for the trail breaker to fall into a boggy hole) with movement slowed by 1/3 but with normal wandering monster rolls (one chance in six). See below for wandering monster chart.

If a wandering monster is indicated, roll first on Table One to determine the specific type of monster encountered. If required, roll again on Table Two.

### TABLE ONE

%	
01-25	Troglodyte Patrol of 15 armed with two javelins each. If encountered, 1-3 of them will run to warn the castle. They will follow the path. [AC: 5, HTK: 11, 13, 9, 12, 11, 9, 13, 12, 10, 10, 11, 5, 13, 10, 9 (2D8)]
26-35	Patrol of six Ghosts [AC: 4, HTK: 16, 7, 15, 12, 8, 12 (4D8)] and ten Ghouls [AC: 6, HTK: 10, 3, 11, 13, 12, 10, 13, 13, 6, 15 (2D8)]
36-00	Dinosaur encounter — roll on Table Two

### TABLE TWO: DINOSAUR ENCOUNTER

%	
01-05	Anatosaurus . . . . . [AC: 5, HTK: 72, 69, 58, 77, 61, 55 (12D8)]
06-08	Ankylosaurus . . . . . [AC: 0, HTK: 55, 35 (9D8)]
09-12	Antrodemus . . . . . [AC: 5, HTK: 92 (15D8)]
13-16	Apatosaurus . . . . . [AC: 5, HTK: 162, 113 (30D8)]
17-20	Brachiosaurus . . . . . [AC: 5, HTK: 216, 185, 199 (36D8)]
21-22	Camarasaurus . . . . . [AC: 6, HTK: 122, 110, 89, 135, 117 (20D8)]
23-25	Ceratosaurus . . . . . [AC: 5, HTK: 49, 35, 39 (8D8)]
26-26	Ctiosaurus . . . . . [AC: 6, HTK: 146 (24D8)]
27-27	Crocodile, Giant . . . . . [AC: 4, HTK: 22, 41 (7D8)]
28-28	Diplodocus . . . . . [AC: 6, HTK: 133, 115 (24D8)]
29-30	Elasmosaurus . . . . . [AC: 7, HTK: 88, 63 (15D8)]
31-32	Gorgosaurus . . . . . [AC: 5, HTK: 76 (13D8)]
33-34	Iguanodon . . . . . [AC: 4, HTK: 37, 22, 27, 19, 25, 39, 23 (6D8)]
35-35	Lambeosaurus . . . . . [AC: 6, HTK: 73, 57, 63, 79, 49 (12D8)]
36-36	Megalosaurus . . . . . [AC: 5, HTK: 79 (12D8)]
37-41	Monoclonius . . . . . [AC: 3/4, HTK: 47, 42, 49, 35, 54 (8D8)]
42-48	Basilisk . . . . . [AC: 4, HTK: 42, 35 (8D8)]
49-49	Paleocincus . . . . . [AC: -3, HTK: 52 (9D8)]
50-54	Pentaceratops . . . . . [AC: 2/6, HTK: 75, 64, 60 (12D8)]
55-55	Plateosaurus . . . . . [AC: 5, HTK: 45, 39, 32, 47, 48, 33, 34, 20 (8D8)]
56-56	Plesiosaurus . . . . . [AC: 7, HTK: 112 (7D8)]
57-58	Pterodactyl, Small . . . . . [AC: 5, HTK: 5, 11, 7, 7, 9, 6, 10 (2D8)]
59-65	Pteranodon . . . . . [AC: 7, HTK: 22, 18, 19, 21, 21, 13, 19 (4D8)]
66-69	Giant Constrictor Snake . . [AC: 5, HTK: 43, 28 (7D8)]
70-81	Stegosaurus [AC: -2/5, HTK: 98, 76, 83 (2/4D8)]
82-88	Stryacosaurus [AC: 2/4, HTK: 55, 61, 39 (10D8)]
89-93	Triceratops . . [AC: 2/6, HTK: 97, 78, 83 (16D8)]
94-00	Tyrannosaurus Rex . . [AC: 5, HTK: 103 (18D8)]

During each encounter, it is likely that some of the Dwarves living in the valley will quietly arrive to view the battle scene (60%). After each observed random encounter have all party members roll percentile dice; a roll of 01-06 means that person has spotted a small humanoid. The observing Dwarves will be a group of 1-3 (25%) or a single individual (75%) and will usually (95%) be male. If threatened or attacked, they will run off; since they are quite familiar with the area, they can manage twice the speed of the party. (See Appendix 4 for details on the Emerald Valley Dwarves.)

If the party makes friends with the Dwarven observer(s), and convinces them that their intentions are to assist them in any possible way, the party will be led to a small cavern in the side of the mountain. There, the party



will again be questioned as to their intentions and warned of what is ahead.

The Mountain Dwarves will not help the party, except to give them drinking water from the spring named "Rian." This water, poured from crystal flasks into crystal goblets, will restore all to complete health (full hit points and spell ability). The Dwarves will explain that they dare not assist in the attack, for the "awful Dwarf" (obviously referring to Gnrrsty) has captured the tribal leader Baron Arilan and the High Priestess of the Temple of Rian, Asha the Just.

If the players choose to enter one of the underground entrances, they will soon find where the Troglodyte guards live . . . There are three entrances, one to the northeast of the Citadel, one to the northwest, and one to the south.

#### NORTHEAST ENTRANCE

1 – Ten Troglodytes [AC: 5, HTK: 9, 8, 6, 6, 14, 12, 9, 4, 11, 13 (2D8)] live here. All are armed with two javelins and are led by a subleader [AC: 5, HTK: 19 (3D8)] who also has a sword. Each Troglodyte has 1-20 sp on him; there are no other valuables in the cavern.

2 – Four Troglodyte females [AC: 5, HTK: 10, 6, 7, 11

(2-1D8)] and three young [AC: 6, HEK: 4, 2, 2 (1-1D8)] live here. If the cavern is entered, the unarmed females will be +3 to hit, since they are defending their young. There are no valuables in this cavern.

3 – Four Troglodytes [AC: 5, HTK: 10, 12, 11, 14 (2D8)] are guarding three Mountain Dwarf prisoners [AC: 6, HTK: 8, 6, 8 (2D8)]. The three are what is left of a scouting patrol (give them a reaction roll at -2 if they are asked to join the party).

4 – Seven Troglodytes are sleeping in this cavern. The seven [AC: 5, HTK: 5, 15, 11, 7, 8, 10, 6 (2D8)] each have 1-20 and are unarmed.

5 – This small chamber contains only a spring.

6 – This large cavern serves as a kitchen; it contains a fire (a chimney vented to the outside removes the smoke) and five Troglodyte females [AC: 5, HTK: 7, 5, 5, 9, 6 (2-1D8)] preparing an unidentifiable delicacy. The females are all armed with knives.

7 – Six Troglodyte Chiefs [AC: 5, HTK: 30, 26, 29, 33, 24, 27 (5D8)] and four subleaders [AC: 5, HTK: 15, 15, 11, 12 (3D8)] are having a heated discussion about asking for more money from Gnrrsty. All are armed with a sword and dagger and attack twice per round. The chiefs have 2-8 gp and 3-12 pp each; the subleaders each have 2-8 gp.





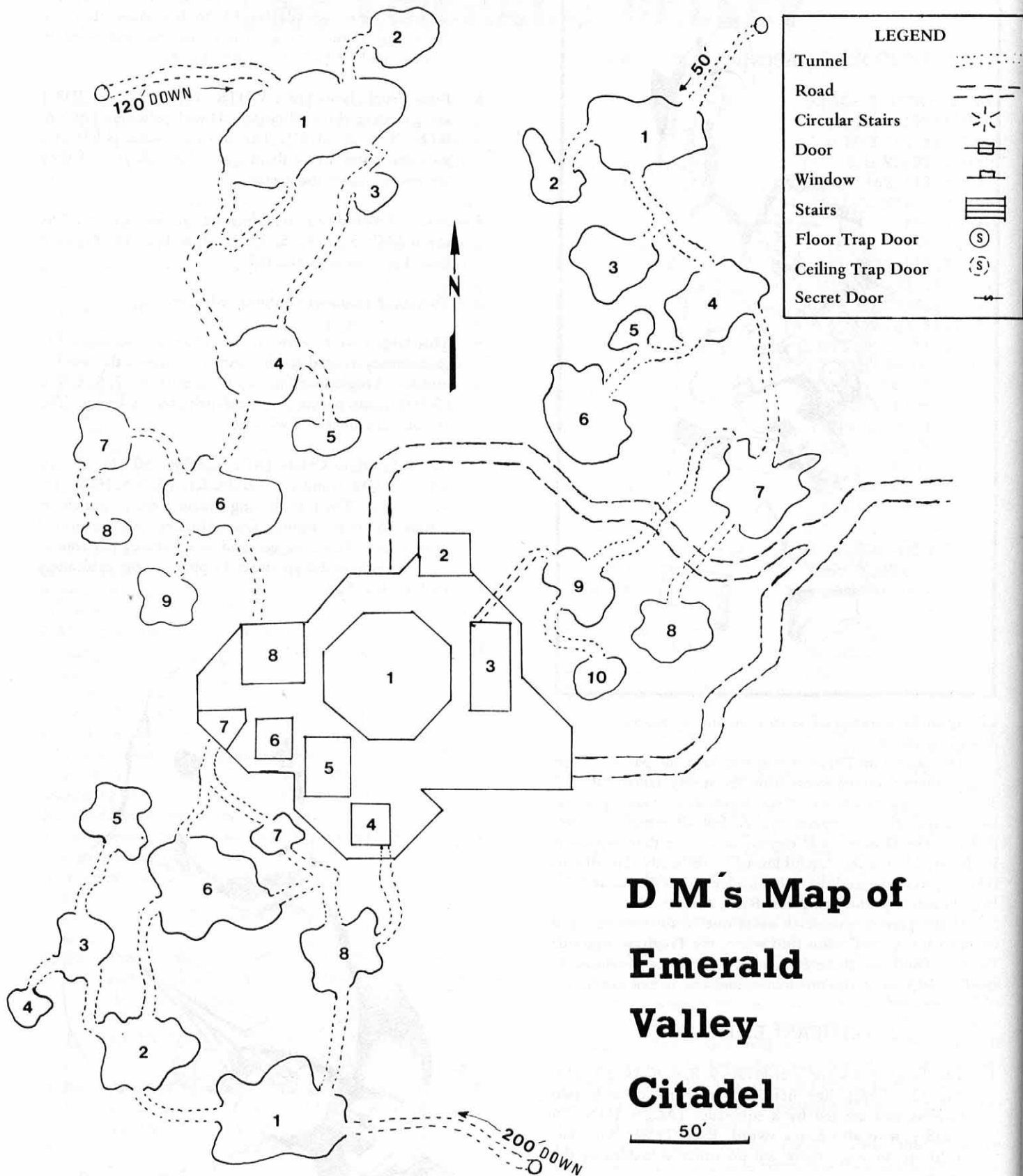

8 – The entrance to this cavern is blocked by a heavy door. In the cavern are six Rust Monsters [AC: 2, HTK: 31, 20, 22, 23, 18, 24 (5D8)]. They have three gems as treasure.

9 – This cavern contains seven Troglydotes [AC: 5, HTK: 9, 4, 6, 7, 7, 9, 11 (2D8)] armed with tridents and daggers. Since they are the rear guard, protecting the treasure room and the entrance to the castle, they will be +2 to hit intruders. They have 1-20 sp each.

10 – The entrance to this cavern is hidden by a large rock (must be found like a secret door). The treasure of these Troglydotes consists of 2020 ep, 160 gp, 83 pp, 3 gems, 6 pieces of jewelry, and a Stone of Weight.

### NORTHWEST ENTRANCE

1 – This large cavern contains 16 Troglydotes [AC: 5, HTK: 14, 10, 6, 10, 5, 11, 10, 10, 7, 9, 8, 5, 8, 4, 5, 8 (2D8)] and two subleaders [AC: 5, HTK: 19, 16 (3D8)] The Troglydotes are all armed with two javelins each; the subleaders also have +1 Swords. The leaders have 2-8 gp each; The others have 1-20 sp.

2 – This is the home of five Troglydote females [AC: 5, HTK: 10, 10, 7, 10, 12 (2-1D8)] and eight young Troglydotes [AC: 6, HTK: 5, 4, 5, 7, 1, 4, 4, 5 (1-1D8)]. If the cavern is entered, the unarmed females will be +3 to hit since they are defending their young. They have no treasure.

3 – This cavern contains only a spring.

4 – Here seven Troglydotes [AC: 5, HTK: 8, 14, 6, 6, 7, 6, 7 (2D8)] are sleeping. They are unarmed, and each has 1-20 sp in his pouch.

5 – This small cavern is set up as a kitchen with a vented fireplace. There are three female Troglydotes [AC: 6, HTK: 2, 4, 5 (1-1D8)] working here. They have no treasure.

6 – Six Troglydotes [AC: 5, HTK: 9, 11, 15, 4, 13, 10 (2D8)] armed with tridents guard the entrance to the castle. Since they are the rear guard, they will be +2 to hit intruders. Three melee rounds after a battle starts, they will be joined by the leader from Cavern 9. Each Troglydote has 1-20 sp in a belt pouch.

7 – In this cavern are two subleaders [AC:5, HTK: 10, 9 (3D8)] and five females [AC:5, HTK: 8, 9, 7, 10, 9 (2-1D8)]. The subleaders each have 1-10 gp each.

8 – The entrance to this cavern is hidden by a large algae covered slab of rock (must be found as a secret door). The treasure of these Troglydotes consists of 2,100 ep, 200 gp, 90 pp, 1 gem, 4 pieces of jewelry, and a +4 Shield.

9 – In this cavern live a Chief [AC: 5, HTK: 32 (6D8)], his three wives [AC: 5, HTK: 8, 8, 6 (2-1D8)] and four

young [AC: 6, HTK: 5, 4, 4, 7 (1-1D8)]. He is armed with a +2 Trident and has 2-20 gp.

### SOUTH ENTRANCE

1 – In this cavern are twelve Troglydotes [AC: 5, HTK: 10, 9, 4, 10, 8, 6, 9, 13, 11, 9 (2D8)] and two subleaders [AC: 5, HTK: 12, 17 (3D8)]. The leaders have +1 Swords, the rest have two javelins each. In their belt pouches, the leaders have 2-8 gp each, the others have 1-20 sp each.

2 – In this cavern are twelve visiting Lizardmen [AC: 4, HTK: 15, 8, 11, 7, 10, 6, 11, 10, 7, 5, 9, 8 (2+1D8)]. They are armed with barbed darts (1-4 damage), clubs and shields. Each has 2-20 gp in his belt pouch.

3 – Here, four Troglydotes [AC: 5, HTK: 9, 11, 12, 9 (2D8)] are sleeping. They are all armed with swords and have 1-20 sp in their belt pouches.

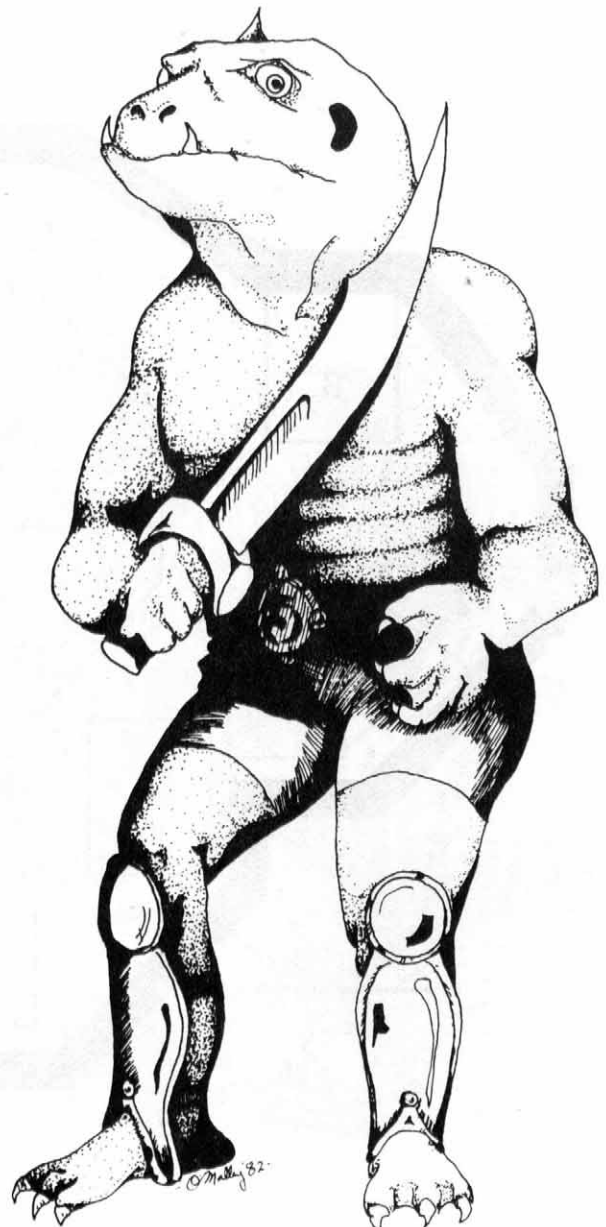

- 4 – The entrance to this cavern is hidden by a sliding rock slab (treat as a secret door). It contains the treasure of these Troglydotes which is 2,070 ep, 300 gp, 90 pp, 1 gem, 5 pieces of jewelry, and a Ring of Shooting Stars.
- 5 – In this cavern live a Chief [AC: 5, HTK: 26 (6D8)], his three wives [AC: 5, HTK: 6, 10, 11 (2-1D8)], and five young [AC: 6, HTK: 2, 5, 5, 4, 3 (1-1D8)]. He is armed with a +3 Sword and has 27 gp.
- 6 – This large cavern contains a spring and is set up as a kitchen (with a fireplace vented to the outside). In this area are six males [AC: 5, HTK: 9, 13, 9, 13, 4, 9 (2D8)], six females [AC: 5, HTK: 11, 11, 8, 9, 5, 9 (2-1D8)], and three young [AC: 6, HTK: 6, 3, 3 (1-1D8)]. All are unarmed, but the males each have 1-20 sp each.
- 7 – This cavern contains a pit trap. The pit is 35' deep and there are 6 poisoned spikes in the bottom (save vs. death to avoid hitting each spike; a person falling in could hit a maximum of 3 spikes). Needless to say, the Troglydotes never use this cavern.
- 8 – Here, nine Troglydotes [AC: 5, HTK: 9, 12, 9, 9, 10, 9, 8, 12, 11] guard the entrance to the castle with large tridents. Since they guard this important position, they will be +2 to hit any intruders.

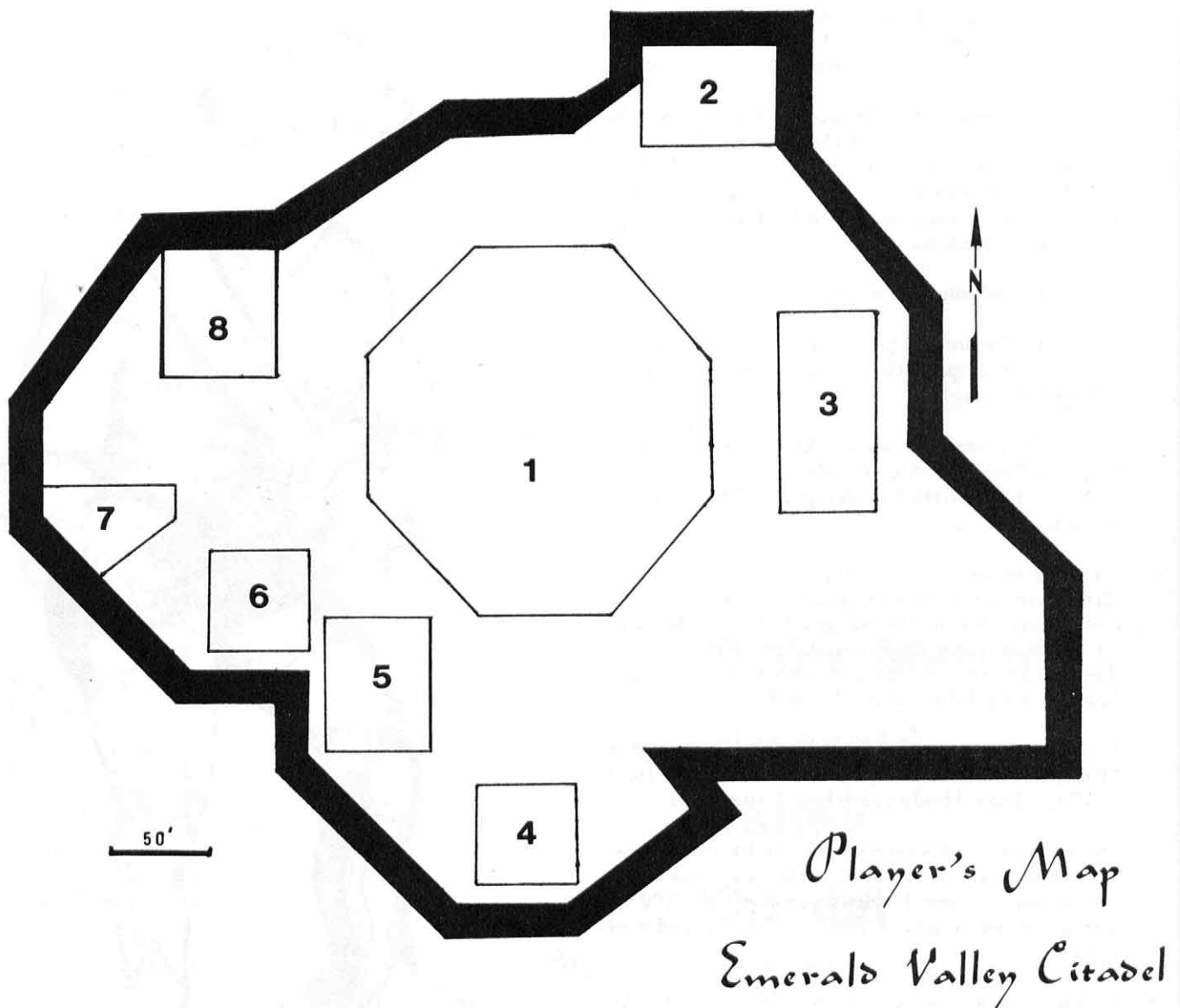

# THE CITADEL

## THE EMERALD VALLEY CITADEL

Gnrrsty's castle is heavily fortified with 20' thick walls that are 30' high. There are two gigantic wooden doors in both the north and east walls (see map). They are heavily reinforced with iron strips. Trorc guards patrol the northern and eastern walls (from Building 8 to the east gate); and Hobgorc guards patrol the rest of the wall. They will not be terribly alert unless the party has activated the warning device in Castle Crag (Fourth Floor, Room 3, Black Knob). The guards work 12 hour shifts: on duty for one hour, on semi-duty in the guard house for one hour, then back on wall duty for another hour. Gnrrsty uses this method to keep all his troops in a state of semi-readiness.

Note: For a description of Trorcs and Hoborcs, see Appendix 3: New Monsters to be Encountered.

Building 1 is made of a strange green stone that glows even in the dark. Except for the four doors, no other openings are visible. Buildings 2-8 are all made of a dark stone (basalt), as is the surrounding wall. The large open area south of Building 3 has many animal stalls filled with different types of food animals.

If the party uses a Divination spell to check the location of the Great Axe, there is only a 25% chance they will get it right. There is a 75% chance that they will be led to believe that it is in Building 1 Second Floor (see Room description for reason). If they get the right percentage roll, the Great Axe will be revealed to be in Building 8 - top floor.





## BUILDING 1

*Undead Manufacture and Storage Area/Throne Room*

### BASEMENT

This level, entered through the secret trap doors in the east and west passages, is a large laboratory for the construction of the many undead Gnrrsty uses for his evil purposes. In each of the six areas (see map) are small "wax" figures, jars of "gems," a press for creating the figures, raw materials and apparatus for precipitating the gems out of murky, liquid-filled vats, etc, etc. The wax figures are, in reality, magical containers constructed by Gnrrsty. When a gem is inserted into the chest cavity the preparation of these "substitute" undead is complete. When Gnrrsty uses his Cube of Undead Control, the color of the gem determines what type of undead will be created from the statue.

The gems, once inserted, are hard to detect (1 in 8) unless examined very closely (then 2 in 8). If the statues are cut or mutilated, they will still form undead unless the gem is removed. The statues are impervious to heat and cold, but electricity causes them (and the gem inside) to be instantly destroyed.

The gems are receptacles for the souls of evil beings Gnrrsty has trapped in the silver mirrors on the First Floor in Rooms 1-4. When the Cube of Undead Control is activated, these souls are transferred into the gems, becoming the animating force of the undead under Gnrrsty's control. If the undead is destroyed, the soul is sucked back into the mirror and can be used again. These pseudo-undead can be turned like ordinary undead, but they cannot be dispelled (this could give the clerics in the party quite a scare!). Also, as might be expected, the gems are very evil - if any party member is carrying any on his/her person when the Cube is activated, he must save vs. magic (at -1 for each five gems carried) or come under the Cube user's control. The gems have a base value of 20 gp each.

In each of the areas, a different type or types of undead are created. The gems are of different colors. The color of the gem determines what type of undead will be created when the Cube of Undead Control is used.

### GEM TABLE

Color of Gem	Location of Gem	Type of Undead
White	Area 1	Skeleton
Tan	Area 2	Zombie
Brown	Area 2	Ghoul
Puce	Area 2	Ghost
Black	Area 3	Shadow
Grey	Area 3	Wight
Green	Area 3	Wraith
Orange	Area 4	Mummy
Purple	Area 5	Spectre
Red	Area 6	Vampire

The basement is guarded by 16 Wraiths [AC: 4, HTK: 32, 23, 36, 35, 28, 35, 24, 25, 20, 25, 27, 28, 30, 28, 29, 29 (5+3D8)]. These are normal Wraiths and can be turned/dispelled. They have no treasure of their own.

## Bldg. 1

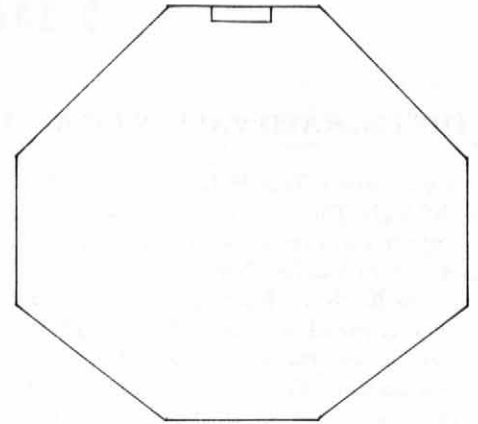

## 2nd Fl.

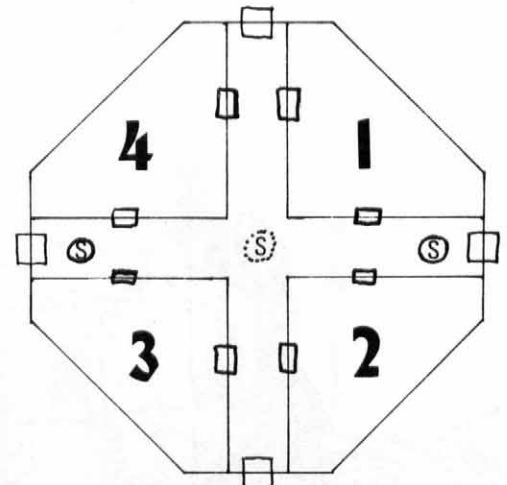

## 1st Fl.

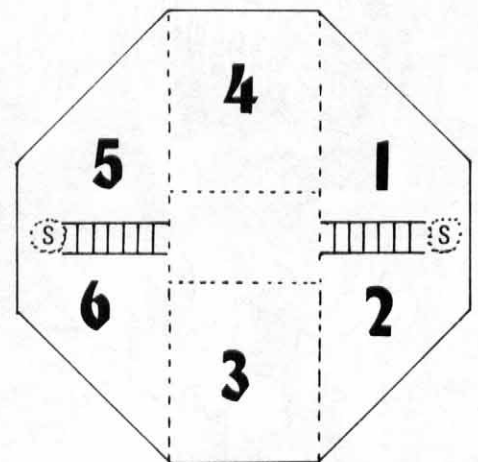

## Basement

## FIRST FLOOR

The four doors to the outside can be easily opened; the eight interior doors are very securely locked — thieves must roll half their normal percentage to get a door open (two tries per thief per door). The two secret trap doors in the floor (leading down to the basement) can be easily lifted once detected. In the ceiling at the intersection of the corridors a black gem is set; touching this gem with anything (stick, finger, etc.) will cause a spiral staircase to descend from the Second Floor. Similar black gems can be found on the upper and lower end of the bannister surrounding the staircase; pushing them will cause the staircase to reset itself up into the Second Floor (if the players are on the Second Floor — pushing a bannister gem will cause the stair to go down).

Rooms 1-4 are all identical except for the relative positioning of the rooms. Only Room 1 will be described in detail.

1 — This room has bare walls except for the northeast wall which has a curtain covering it. On pedestals in the center of the room are 124 12" high wax figures with staring, glassy eyes (the eyes will watch you wherever you go). Unless the statues are examined very closely, there is only a 1 in 8 chance that anyone will notice a gem embedded in the chest cavity. These statues are the undead troops of Gnrrsty the Evil.

Two minutes after the door is opened, the statues begin to animate. If no Ring of Undead Control is

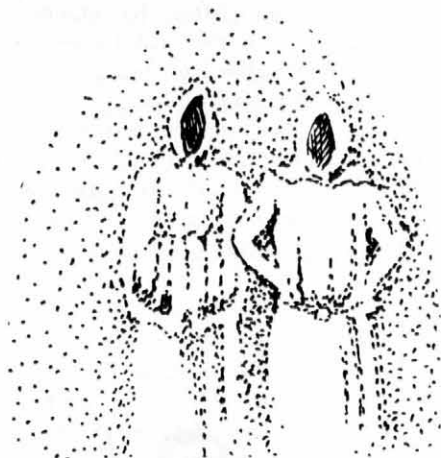

present (only Gnrrsty, Kiril, the chief Trorc, the chief Hobgorc, and a few other leaders have them), roll on the chart below to see what type of undead appear; the number on the right (i.e., the 18 on 3-18 for skeletons) is the total number of a particular type of undead that can be formed. They will continue to animate — another group every two rounds (roll percentile dice again for the new group — if you exceed the maximum number for a particular type, roll again). If the party has captured one of the Rings of Undead Control and someone is wearing it, the undead will not attack, but will animate. These “manufactured” undead can be turned (each turn last for 5 rounds) but they CANNOT be dispelled.

## UNDEAD ROLL TABLE

%	No.	Name and statistics
01-18	3 - 18	Skeletons [AC: 7, HTK: 4, 5, 5, 2, 3, 4, 1, 1, 3, 5, 5, 5, 5, 4, 7, 7, 1, 6 (1D8)]
19-33	4 - 16	Zombies [AC: 8, HTK: 13, 6, 14, 14, 7, 7, 10, 10, 11, 10, 9, 9, 14, 12, 11, 7 (2D8)]
34-45	2 - 24	Ghouls [AC: 6, HTK: 11, 6, 6, 14, 9, 6, 12, 6, 7, 9, 12, 12, 7, 7, 9, 9, 10, 11, 9, 11, 8, 9, 3, 9 (2D8)]
46-50	1 - 6	Ghasts [AC: 4, HTK: 25, 19, 14, 11, 14, 9 (4D8)]
51-60	1 - 12	Shadows [AC: 7, HTK: 12, 17, 16, 12, 11, 17, 13, 17, 19, 19, 16, 11 (3+3D8)]
61-70	3 - 18	Wights [AC: 5, HTK: 15, 20, 14, 16, 21, 17, 28, 10, 24, 10, 12, 24, 16, 20, 19, 22, 17, 16 (4+3D8)]
71-80	1 - 12	Wraiths [AC: 4, HTK: 31, 30, 27, 27, 29, 17, 31, 24, 24, 16, 20, 23 (5+3D8)]
81-89	2 - 8	Mummies [AC: 3, HTK: 38, 30, 22, 31, 25, 28, 29, 30 (6+3D8)]
90-95	1 - 6	Spectres [AC: 2, HTK: 31, 36, 32, 42, 26, 38 (7+3D8)]
96-00	1 - 4	Vampires [AC: 1 HTK: 40, 44, 43, 46 (8+3D8)]

Behind the curtain on the northeast wall is a large mirror. In the mirror, murky shapes can be seen moving about. These are the souls of evil beings that Gnrrsty uses to activate his private undead. The mirrors are made of silver and will not break if struck; if the mirror is destroyed (i.e. Disintegration spell) the undead will be released from Gnrrsty's control. If the wax figures (which will melt but not burn) are destroyed, and the gems are not, only the Shadows, Wraiths, and Spectres will be released. The gems may be easily smashed, cancelling their effectiveness.

## SECOND FLOOR

One gigantic room with a staircase in the center; all the walls are bare except for the north and south walls which are covered with tapestries.

The north tapestry shows a routed army being chased by myriad hoards of undead.

The south tapestry shows this room with a very tall, ugly Dwarf sitting on a throne and vast numbers of undead kneeling in obeisance to him. The players can tell it is the same room because the party can see the same throne at the south end of the room, just in front of the tapestry.

The throne, a large single seater, is mounted in the center of the south wall, ten feet from the wall.

On the west wall, mounted on a huge plaque, are three large axes — exact duplications of the Ancient Axe of the Dwarves. These extremely evil axes are a trap. Anyone handling an axe will immediately turn into a VERY CHAOTIC EVIL character whose sole purpose is to get two

other players to pick up the other two axes – then the three of them will attempt to eliminate the rest of the party (if they are successful, they will happily serve Gnrrsty for the rest of their lives!). These three axes have the following powers:

- 1 – Adds one point to major attribute.
- 2 – Color spray – three times per day.
- 3 – Fly when held – three times per day.
- 4 – Infravision as long as axe is held.
- 5 – Immune to Fear.
- 6 – Possessor will never willingly leave item.
- 7 – User is turned chaotic evil.
- 8 – Lesser undead may be summoned – three times per day.
  - a) 2 - 20 Skeletons, or
  - b) 2 - 16 Zombies, or
  - c) 2 - 12 Ghouls.

These summoned (arrive in 1 - 4 rounds) undead are under the direct control of the owner of the axe. The undead summoned are true, not manufactured, undead.

Since there are three axes in this room, there is only a 25% chance that a Divination spell will find the real axe in Building 8/Top Floor.

Behind the tapestry on the north wall is a small panel set into the wall. Opening the panel reveals five gems set in a diamond-shaped pattern.

```

      *
     * * *
    *
  
```

The gems are colorless, but glow with a green light when touched; if touched again, they cease to glow. The gems (when lit) cause various effects as shown below:

**Top Gem:** Causes a 10'x10' section to the right of the panel to disappear, leaving a passage exposed. This passage is filled with grey, swirling vapors. The passage is an illusion covering a Sphere of Annihilation. All who enter are immediately destroyed.

**Left Gem:** Causes the green gem on the arm of the throne (see below) to start flashing. When the gem on the throne is pressed, the throne will slide to the left, revealing a downward passage.

**Center Gem:** When pressed, this gem causes an alarm to be sounded in the quarters of Gnrrsty, Kiril, and the main guard stations for the Trorc and Hobgorc guards. It also causes the central stairwell to move to the down position and is locked there. This gem, when touched again will not cease to glow – it must be touched by one of the Rings of Undead Control to cancel its effect.

**Right Gem:** Causes a 10' x 10' passage to be revealed to the left of the panel. The passage appears to be 15-20' long and is illuminated with an eerie yellow light. This passage is a teleport chamber, and anyone entering it is immediately teleported to the main prisoner holding

area in Building 5/First Sub-Basement/Room 1.

**Bottom Gem:** Turns the northeast and northwest diagonal walls into Mirrors of Opposition; only those players in the extreme north, south, east, or west of the room will be free of its effects.

NOTE: Any player caught in the central area of the room will have two opposites to fight! (If you are confused about the areas affected, draw lines on your map of the second floor.) The mirrors will remain until the gem is pressed again, thus any characters not originally effected who move into a position where the mirror can reflect them, will have a duplicate to fight. The mirrors are made of polished silver and will dent, but not break upon being hit.

The Throne is made of the same green stone as the rest of the building and appears to be firmly attached to the floor. Set in the right arm of the throne are three gems: A black gem which when touched causes the stairwell to rise or descend; a reddish gem which when touched causes the stairwell to be locked in its current position, whether it be up or down; and a green gem which has no apparent function.

EXCEPTION: If the red gem is lit and the stairwell is in the up position – when the center gem behind the wall panel (see above) is touched, the stairwell will go down. The red gem overrides control of all black gems.

When the left gem behind the wall panel (see above) is pressed, the green gem will begin to flash. If the green gem is now touched, the throne will slide to the left, revealing a dark, downward passage. After five minutes (or when another green gem set in the wall below the throne is touched) the throne will slide back into its original position and the green gem will cease flashing.

The passage, an extra-dimensional warp, leads down and due west, splits after about 80°; the right passage ends at Building 8/First Floor – northeast stairwell while the left passage ends in Building 7/Basement – Room 2. There are no other exits.



## Bldg. 2

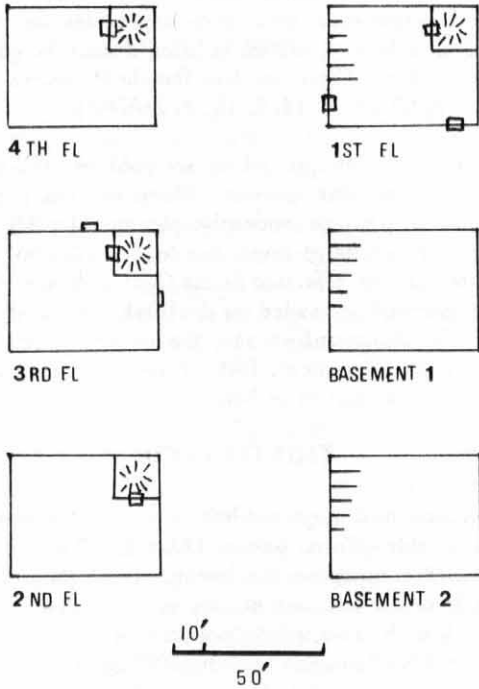

**BUILDING 2**  
*Trorc Living Quarters*

### SECOND SUB-BASEMENT

Weapon storage room. This room contains many polearms, swords, and composite bows and arrows. They are stacked in heaps all over the room. None are magical and only 60% of the weapons are useable. The room is currently unoccupied.

### FIRST SUB-BASEMENT

This area contains a small armory, forge, and fletcher's shop. There are sacks of coal, stacks of wood, bundles of arrow shafts, small bags of feathers, and bars of iron stacked about the room. Currently, the forge is being tended by four Trorcs [AC: 5, HTK: 18, 21, 23, 17 (4+2D8)] who will attack with red-hot iron rods (1-4 in damage and 4-16 in heat damage).

### FIRST FLOOR

This is a recreation room; tables are scattered about the room and benches surround each table. Three huge barrels of ale dominate the north wall. In the northwest corner are stairs leading down; a circular staircase leading upwards is in the northeast corner of the room. In the room, enjoying the heady brew, are five Trorcs [AC: 5, HTK: 26, 32, 23, 19, 19 (4+2D8)] and eight Orcs [AC: 6, HTK: 7, 5, 5, 3, 11, 9, 4, 8 (2D8)]. The Orcs are armed with swords. They each have 2-12 sp, 1-8 gp, and possibly (35%) a gem, not worth more than 50 gp.

### SECOND FLOOR

This room is the sleeping quarters for off-duty Trorc guards. It is entirely filled with nine 10' long double-decker bunks. There are fifteen Trorcs [AC: 5 HTK: 20, 28, 23, 15, 30, 19, 20, 22, 19, 27, 23, 16, 29, 18, 19 (4+2D8)] asleep in the room; another three [AC: 5, HTK: 17, 18, 15 (4+2D8)] are playing dice in the open area by the stairwell – they will awaken the others if they spot the party.

There are four small footlockers under each bottom bunk (both guard shifts use the same bunks). In each locker (most are unlocked) are some clothes, scraps of greasy meat, assorted armor, and weapons, and 1-6 cp.

### THIRD FLOOR

Office for the Trorc watch-captains; the two doors open out onto the ramparts where the guards stand watch. Each 12-hour shift is broken into halves, with half of the guards standing watch for an hour, then the other half of the guards take a one hour watch. The off-duty guards can rest in this room; there are four bunks, several musical instruments lean against the walls, several gambling tables, and two desks (for the watch-captains). The two watch-captains [AC: 4, HTK: 25, 30 (5+5D8)] are armed with swords; the larger one also has a Ring of Undead Control. The resting Trorcs [AC: 5, HTK: 22, 17, 20, 23, 24, 18, 21, 24, 25, 23, 16, 19, 22, 25, 19 (4+2D8)] are unarmed; the Trorcs watching for intruders on the battlements are armed with swords and heavy crossbows.

### FOURTH FLOOR

More sleeping quarters; basically identical in detail to the Second Floor. There are fourteen off-duty Trorcs [AC: 5, HTK: 12, 22, 18, 17, 21, 23, 22, 15, 18, 16, 20, 22, 19, 23 (4+2D8)] sleeping here – four bunks are empty. An Orc servant [AC: 6, HTK: 2 (1D8)] is cleaning up a mess in the southwest corner of the room. He will awaken the sleeping Trorcs if the party attacks.





## Bldg.3

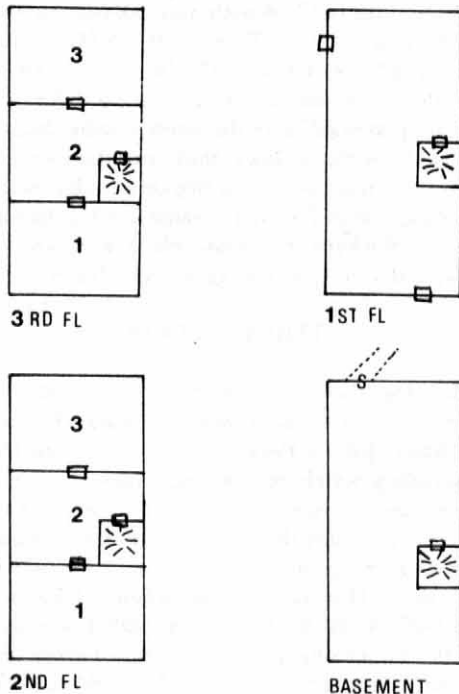

### BUILDING 3

*Dining Room and Food Preparation Areas for Guards*

#### BASEMENT

Basically a food storage area. There is a large well against the north wall; the water in it is good. Much of the rest of the room is filled with huge bags of potatoes, turnips, carrots, rutabagas, and other edible roots that grow wild in the semi-swamp outside the citadel. Ten huge kegs of ale line the west wall; cartons of dried fruit are stacked on the south wall. For each bag or carton moved, 1-12 Giant Centipedes [AC: 9, HTK: 2 each (1D8)] (75%) or 2-8 Giant Rats [AC: 7, HTK: 3 each (1D8)] (25%) will be revealed. Neither has any treasure.

#### FIRST FLOOR

A huge dining area filled with heavy wooden tables and chairs. The tables are covered with dirty dishes and half-emptied mugs; the smell is awful! There are two large fireplaces on the eastern wall. There are eleven Orcs [AC: 6, HTK: 3 each (1D8)] feebly attempting to clear away the mess; they are workers, not fighters, and will flee at any sign of aggression from the party. In each fireplace, a huge unidentifiable carcass roasts.

#### SECOND FLOOR

1 - Contains two large firepits. There is a stack of skinned fowl in one corner ready to be cooked and another larger pile of skins, innards, heads, etc., in another corner. The smell is gruesome; save vs. breath weapon or be sick for 1-3 minutes. There are two old Trorc

females [AC: 5, HTK: 16, 18 (4+2D8)] spitting the birds. They will not fight unless provoked.

- 2 - Food preparation area. Raw vegetables are piled on several tables. A carcass is being dismembered on two other tables. There are five female Hobgorcs working [AC: 5, HTK: 14, 11, 7, 16, 9 (2+3D8)].
- 3 - Contains two firepits which are cold and full of ashes. There is no one present. There are many jars and bottles of what are evidently spices and liquids to baste meat. In one large green bottle is a solution that will neutralize the effect of Giant Centipede venom; there is a centipede scrawled on the label. This fluid is drunk only by those unfortunate few chosen to get supplies out of the Basement. DM: If you use magical spices, etc., you can put them here.

#### THIRD FLOOR

- 1 - Contains four large red-hot ovens on the south wall. Three older Trorc bakers [AC: 5, HTK: 28, 21, 17 (4+2D8)] supervise the baking of very large loaves of black bread and are mixing more dough. They will attack with red-hot iron pokers (1-4 damage, plus 2-12 points heat damage). They have 27 gp between them.
- 2 - The main flour area; sacks of grain and barrels of water line the walls. Nine Orcs [AC: 6, HTK: 4 each (1D8)] are hard at work grinding wheat into flour. They will flee if attacked.
- 3 - Contains six large vats for making beer, ale, and wine. Racks on the east and west walls contain bottles of all shapes and sizes. All the bottles contain drinkable spirits; there is a 20% chance for a player to get drunk from just one glassful — the spirits are QUITE STRONG.

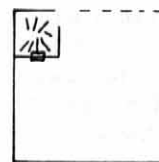

4 TH FL



3 RD FL

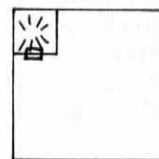

2 ND FL



1 ST FL



BASEMENT

## Bldg.4

## BUILDING 4

Main Quarters and Guard Station for Half-Orcs

### BASEMENT

A large fletcher's shop used for making crossbow quarrels. There are large bundles of arrow shafts stacked against the north wall. In the southwest corner is a small forge; the rest of the south wall is filled with four large work tables. Bags of arrowheads and feathers line the north wall. There are six Half-Orcs [AC: 6, HTK: 16, 14, 6, 10, 11, 8 (2D8)] busy making quarrels and one very large Orc [AC: 6, HTK: 34 (6D8)] is tending the forge. The Orc will attack with a red-hot poker (1-4 points damage, plus 2-8 points heat damage).

### FIRST FLOOR

A large guard and rest station. Two large Half-Orc sergeants man large desks; they maintain ledgers containing list of all Half-Orc guards hired by Gnrrsty, assign them to guard and work shifts, and maintain lists of how much pay is owed the guards. There is a small cash box chained to the east wall of the stone stairwell (behind one of the desks); it contains 150 sp and 20 gp and a Ring of Undead Control. There are three Half-Orc guards [AC: 6, HTK: 3, 5, 8 (2D8)] chatting with the Half-Orc sergeant [AC: 5, HTK: 24 (5D8)]. All are armed with swords and have 1-12 gp.

### SECOND FLOOR

The southern wall has four large beds and four large chests. These are separated from the rest of the room by a cheap, greasy, torn curtain. Two of the beds contain sleeping Half-Orc sergeants [AC: 5, HTK: 15, 24 (5D8)]. All the chests are locked (the one on the west end has a poisoned needle in the lock); each contains a few personal effects, some clothing, 2-16 sp and 3-24 gp. Chest 3 has a wand in it — it is a Wand of Polymorphing, but all the charges are gone from it. The rest of the room contains a small bar and three double-decker bunks. These bunks are empty. Under each bunk are two small footlockers containing only personal clothing (poor quality) and personal effects).

### THIRD FLOOR

The entire floor is filled with ten double-deck bunks; under each bunk are two small footlockers, which are unlocked and contain only clothing. Twelve of the bunks are occupied by sleeping off-duty Half-Orc guards [AC: 6, HTK: 12, 14, 12, 7, 10, 4, 7, 9, 14, 6, 9, 8 (6D8)]; all have swords and carry 3-24 sp and 1-4 gp (5% chance of a gem).

Since most of the Fourth Floor is missing, the bunks near the exit stairwell are weather-worn. There is a 1 in 6 chance that a character will cause a step to break, causing him to fall down the stairs for 1-3 points of damage.

### FOURTH FLOOR

Only the west and south walls are standing. There is a deep (4"-6") puddle covering most of the floor — a leftover from the last rainstorm.

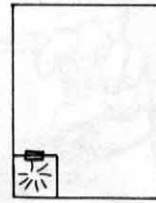

3 RD FL

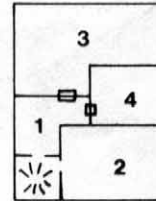

2 ND FL

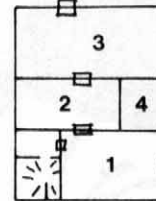

1 ST FL

## Bldg.5

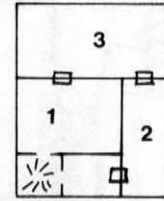

BASEMENT 1

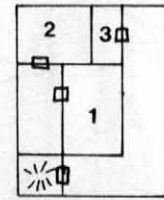

BASEMENT 2

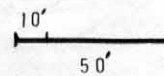

## BUILDING 5

Kiril's Quarters

### SECOND SUB-BASEMENT

- 1 — A large holding room with locked and barred doors used to hold prisoners captured in raids. They are now treated as slaves and do menial work around the castle. Currently, there are four humans and two Dwarves living within this room. They are all fighters and are in reasonably good condition (all have 6 HTK, but no armor or weapons). They know what is in most buildings — except for details of Buildings 7 and 8 (they were not allowed into them). An iron grating blocks the entrance to the tunnel in the corridor.
- 2 — Prisoner holding cell — currently occupied by a skill 5 Half-Elf Magic User (14 HTK) and a skill 3 Gnome Illusionist/Thief (11 HTK). They will assist the party, if asked.
- 3 — Prisoner holding cell. This one holds a Dwarven fighter. He has no armor or weapons and has been badly tortured. When the party treats him well, he will reveal himself to be Baron Arilan of the Emerald Valley Dwarves. He is an 8th level fighter with 18 (88) strength and a 17 stamina — due to the torture he has been reduced to 16 strength and is down to 21 hits (from his normal of 48 HTK). Arilan knows where High Priestess Asha is being held. He will willingly join the party to free her and defeat Gnrrsty.



## FIRST SUB-BASEMENT

1 – Main prisoner holding area; prisoners are held here before being questioned and/or tortured. Gnrrsty feels that the sounds of others being tortured will loosen the tongues of those being held, waiting for their turn. Both the door to the stairwell and the door to Room 3 are securely barred and locked. The room is empty at the moment.

This is where the teleport from Building 1/Second Floor (right gem) will land the party if they enter the passage – inside a locked room!

2 – Main torture room. It has all manner of torture equipment including racks, manacles on the walls, an iron maiden, and several glowing braziers of hot coals. At present, three Hobgorcs [AC: 5, HTK: 13, 14, 10 (2+3D8)] are torturing an Emerald Valley Dwarf [AC: 9, HTK: 12 (2D8)] trying to get information from her on how to locate the main caverns of the Emerald Valley Dwarves. The Dwarf has just been captured and knows nothing of the Citadel.

3 – A cell for prisoners. It is empty at the moment except for twelve Orcs [AC: 6, HTK: 2 each (1D8)] who are cleaning it with mops and pails of water. They will not

fight, but know little of the buildings; they are usually used to clean Building 3 after each meal.

## FIRST FLOOR

Stairwell: Guarded by three Trorcs [AC: 5, HTK: 22, 25, 19 (4+2D8)] who will not let anyone who is not of the castle enter this area. They know all the inhabitants and get very few visitors; thus they spend most of their time playing cards. Their large swords lie on the floor behind them; on the table are cards and 3-36 gp.

2 – Living quarters for six Half-Orc guards. There are six beds and six locked footlockers in this room; footlockers contain clothing and 1-20 gp. No one is in this room; the Half-Orcs are on guard duty.

3 – A small watch station and sleeping quarters for twelve Half-Orc guards. The sergeant of the watch, a Half-Orc [AC: 6, HTK: 20 (3+2D8)], is away from his desk. The north door is open; he is outside relieving himself. Currently five Half-Orcs [AC: 6, HTK: 15, 7, 6, 10, 5 (6D8)] are sleeping here; they all have swords close at hand. If the party makes noise fighting these Half-Orcs, the guard-commander from Room 4 will join the fight; in any case, the sergeant of the watch will be back in one minute.

- 4 – Quarters for the Half-Orc guard captain and his assistant. They have large comfy beds and large footlockers, which contain only clothing. If the captain's bed is moved and a trap door is raised (treat as finding a secret door), a brass-bound chest will be revealed. It is locked and has a spear trap in the lid (if not deactivated, three spears fire as if thrown by a fifth level fighter; if they hit, they do 1-6 points damage each). The chest contains the treasure of both men: 9696 cp, 6900 sp, 213 gp, 4 gems, a pair of Boots of Elvenkind and a +2 Giant Slaying Sword (alignment: Neutral Good) – the sword speaks Dwarvish, Common, Troll; can Locate Objects in 120' radius; Detect Secret Door in 5' radius; Detect Evil/Good in 10' radius. The Sword belonged to Baron Arilan (see Second Sub-Basement/Room 3, this building).

## SECOND FLOOR

- 1 – Guard post. There are two Half-Orcs [AC: 6, HTK: 9,



8 (2D8)] on duty. They regulate visitors to Kiril (Room 4) and to the "ladies," making sure all visitors have appointments. They are sword-armed.

- 2 – Sleeping quarters for twelve Half-Orc guards. Only three are currently in this room; they are sound asleep [AC: 6, HTK: 8, 14, 3 (2D8)]. The guards in Room 1 are to awaken them in time for visitation to the ladies. Though asleep, they have swords nearby.

- 3 – Quarters for six female Half-Orcs and four female humans. They serve as "companions" for the Half-Orc guards. Each lady has a separate area curtained off from the others by ornate rugs hanging from the ceiling (each rug is worth 10-120 gp). Each area contains a bed, an ornate chest, and a clothes closet. Each chest is locked and protected by contact poison; each contains special clothing and ornamentation and 1-12 gp per appeal point (each lady has a appeal from 10-18). Currently, only eight ladies are at home; they all have visitors – Half-Orc fighters [AC: 6, HTK: 14, 5, 12, 8, 12, 10, 3, 11 (2D8)] armed with swords. The fighters have no money, having already paid the ladies their due.



- 4 – Kiril's Room. Home of Kiril, the Magic User. This room has a very large bed, a gilded chest and clothes closet, a small rack, and manacles on the wall. The clothes closet contains (naturally!) clothing of all types and colors; in the pocket of one robe will be round Kiril's spare Wand of Fear (fully charged). The chest is wizard-locked and has explosive runes around the lock. For good measure, there is a poisoned needle in the lock. The chest contains Kiril's loot: 1,680 gp, 273 pp, a crystal ball, a pouch of Dust of Sneezing, and Choaking, a Girdle of Masculinity/Femininity, and twelve jewels – two of which are magic (if checked for), a ruby Jewel of Flawlessness and an opal Jewel of Attacks. There is a 35% chance that Kiril will be in this room; if he is here, there is an 85% chance he will be entertaining 1-3 lady friends. Kiril has a +25% Ring of Undead Control, as well as Bracers of Defense (AC: 2), and Wands of Fear and Lightning.

## THIRD FLOOR

A large barracks for 24 Half-Orc Guards. Each has a bunk and a small footlocker containing clothing and 1-12 sp, 1-8 gp; there is a 15% chance per chest for the chest lock to be trapped. Only five Half-Orc guards are sleeping here [AC: 6, HTK: 12, 8, 9, 4, 10 (2D8)].



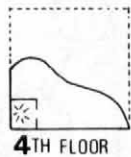

4TH FLOOR

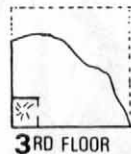

3RD FLOOR

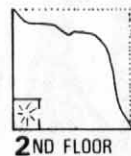

2ND FLOOR



1ST FLOOR

## Bldg. 6

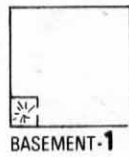

BASEMENT-1



BASEMENT-2



BASEMENT-3

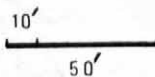

### BUILDING 6

*Food Storage and Weapon Repair*

#### THIRD SUB-BASEMENT

Storage room filled with dried fruits, nuts, vegetables, etc.

#### SECOND SUB-BASEMENT

Storage room filled with dried meat (different types of dinosaur).

#### FIRST SUB-BASEMENT

A large food preparation area. There are ovens to dry fruit and meat. Lining one wall are large barrels of water used to wash the food before drying it. Six Trorcs [AC: 5, HTK: 22, 18, 16, 19, 12, 15 (4+2D8)] are hard at work at several large work tables carving up a small dinosaur. They are armed with knives (treat as daggers).

#### FIRST FLOOR

A weapons and armor repair shop. A small forge sits in the southeast corner. Four large work tables sit against the walls; bags of coal and bars of metal line the walls between the tables. Eight Orcs [AC: 6, HTK: 5, 3, 3, 3, 4, 1, 6, 1 (1D8)] and two Trorcs [AC: 5, HTK: 25, 29 (5+5D8)] work on repairing damaged weapons and armor, and making new weapons and armor.

## SECOND FLOOR

Just north of the stairwell (on the uncollapsed portion of the floor) stands a large forge. The forge is red-hot and three Orcs [AC: 6, HTK: 12, 15, 11 (3D8)] are hard at work heating a load of iron. Bags of coal and stacks of wood line the south wall.

## THIRD FLOOR

Empty.

## FOURTH FLOOR

Lookout post for three Half-Orcs [AC: 6, HTK: 10, 17, 15 (3D8)] armed with swords and crossbows. They watch for intruders and dinosaurs.

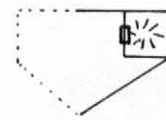

5TH FL

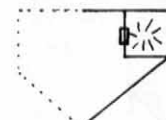

4TH FL

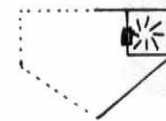

3RD FL

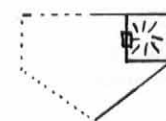

2ND FL

## Bldg. 7

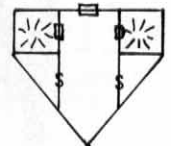

1ST FL

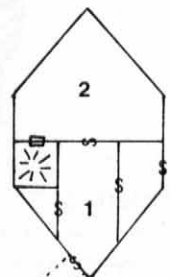

BASEMENT

### BUILDING 7

*Wine Cellar and Kiril's Laboratory*

#### BASEMENT

1 – Contains a large well in the center of the room. The walls of this cool, damp room are lined with floor to ceiling racks holding bottles of every shape, color, and size. This is the private wine cellar of Gnrrsty and Kiril. In the places where secret doors are indicated, the hinged wine racks open inward. Since (from the inside only) a hidden catch must be pressed to open the wine racks, treat finding the catch as finding a secret door. All the wine stored here is excellent! Passageway from the Troglodyte caverns is behind the wine rack.

2 – The door is wizard-locked. Kiril's laboratory is filled

with many shelves of herbs and powders and many, many miscellaneous items (i.e. basilisk blood, gorgon scales, remorhaz' teeth, beholder's eye stalks, etc., etc., . . . in other words, almost everything imaginable!) used by Kiril to prepare magic spells and to enchant magic items. Kiril will be here most (65%) of the time. It is likely (75%) that he will have his female human thief assistant (she has a appeal of 18) working with him. She is AC: 2 (bracers) and is armed with a +1 dancing sword and a Wand of Magic Missiles. She also has a Ring of Undead Control.

**Secret Doors:** In the southeast wall of Room 1; it leads to the Troglodyte caverns. The two secret doors in the eastern wall of Room 1 lead through Room 3 to the passage that goes to Building 8/Northeast stairwell and Building 1/Second Floor under the throne. The small room between them is empty.

### FIRST FLOOR

Two Hobgorc subleaders [AC: 4, HTK: 19, 14 (4D8)] and four Trorcs [AC: 5, HTK: 19, 21, 18, 25 (4+2D8)] guard the wine cellar below. They will let NO ONE below without a pass signed by either Kiril or Gnrrsty. The eastern "secret" door in this room is fairly obvious if looked for; the Hobgorc guards stationed above use it frequently.

### SECOND, THIRD, FOURTH, OR FIFTH FLOOR

On one of these floors, four Hobgorcs [AC: 5, HTK: 13, 12, 7, 9 (2+3D8)] are watching for intruders or dinosaurs. They are armed with heavy crossbows and maces. They carry from 1-6 gp each. The other floors will be found to be empty.

## Bldg.8

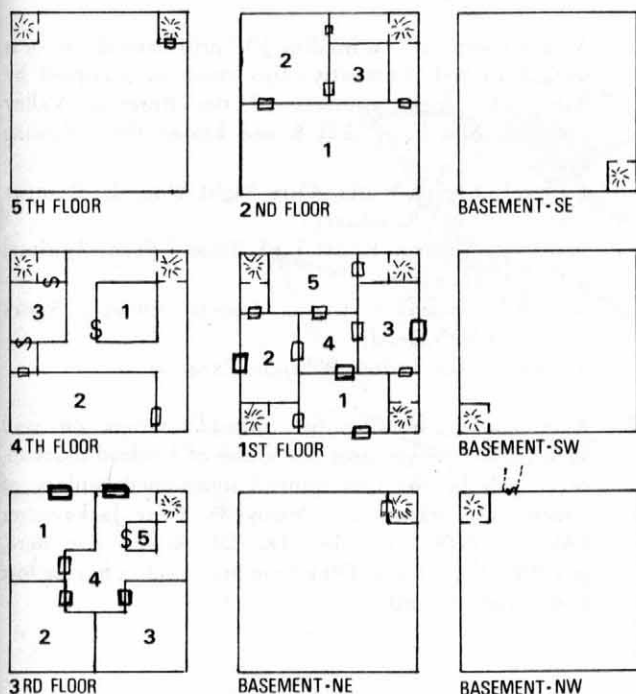

## BUILDING 8

### Gnrrsty's Headquarters

### BASEMENT

**Northwest:** This room is used mainly for extra food and weapons storage. There is a well in the northeast corner; boxes of dried meat and fruit and kegs of ale line the east, south and west walls. The secret door in the north wall (from the Troglodyte caverns) opens inward. There is a large rock kept right in front of the door to keep the Troglodytes from entering and stealing rations and/or weapons (treat as a locked door). For insurance, there are three Half-Orc fighters [AC: 4, HTK: 16, 18, 12 (3D8)] stationed here; they will allow any Troglodyte to enter the basement if the correct password is given. They are armed with swords and carry 2-24 gp each; they spend a great deal of time playing cards on this cushy assignment.

**Southwest:** Set up as a series (35 in all) of 10'x10' cubicles used as semi-private boudoirs. Each is curtained off from the others and is occupied by a female Hobgorc (10% chance for each to have a child living with her). If this room is entered at night, there is a 100% chance for all the females to be present - 85% for each to have a male Hobgorc. Each female has a mace to "protect her honor" and has (in her bed, pillow, chest, somewhere) 3-36 gp and possibly (30%) 1-2 gems. The females not in this room during the day will be out with a party of male Hobgorc guards gathering edibles from the swamps around the castle.

**Southeast:** Same as southwest basement, except that this level is for Trorc females.

**Northeast:** Same as southwest basement, except that this level is for Orc (33%) and Half-Orc females (67%).

### FIRST FLOOR

- 1 - Six Hobgorcs [AC: 5, HTK: 14, 10, 15, 13, 12, 12 (2+3D8)] guard this room and the stairwell leading to the Hobgorc females in the southwest basement. They are armed with swords and carry 1-12 sp and 1-6 gp each.
- 2 - Four Trorcs [AC: 5, HTK: 24, 22, 35, 27 (5+5D8)] armed with large two-handed swords guard this room and the stairwell leading to the storage room below. They have 1-12 gp each.
- 3 - Six more Trorcs [AC: 5, HTK: 19, 33, 25, 24, 29, 25 (5+5D8)] armed with two-handed swords guard the stairwell to the southeast basement, holding the Trorc females. They carry 1-12 gp each.
- 4 - Empty except for a fancy candle-illuminated, crystal chandelier hanging from the ceiling.
- 5 - One Half-Orc sergeant [AC: 5, HTK: 16 (3D8)] and four Half-Orcs [AC: 6, HTK: 12, 5, 10, 12 (2D8)]

guard the stairwell leading to the Half-Orc females below and to Gnrrsty's quarters above. All have +1 Swords of Cold (1-8 damage, plus 1-6 cold damage).

NOTE: only the northeast stairwell leads to the upper floors of this building.

## SECOND FLOOR

- 1 – Gnrrsty's private torture chamber. It has all sorts of torture implements and is managed by two large Orcs [AC: 4, HTK: 34, 36 (5D8)]. They are armed with swords, are completely loyal to Gnrrsty, and are +2 to hit and damage due to great strength.
- 2 – Small kitchen and food preparation area. The quality food prepared here is served to Gnrrsty and his guests (the guards eat in Building 3). Three Hobgorcs [AC: 5, HTK: 11, 9, 13 (2+3D8)] labor here.
- 3 – Holding area for prisoners en route to personal torturing by Gnrrsty and his two assistants (see Room 1). The room is filthy and is currently occupied by a dead Emerald Valley Dwarf.

## THIRD FLOOR

- 1 – Guard station manned by four Half-Orc watch sergeants [AC: 4, HTK: 18, 11, 11, 12 (3D8)] armed with swords and having 3-18gp. There will also be 1-4 Trorcs [AC: 5, HTK: 26, 15, 23, 18 (4+2D8)] and 1-6 Hobgorcs [AC: 5, HTK: 10, 13, 11, 13, 10, 14 (2+3D8)] present in this room at any time.
- 2 – Living quarters for four Half-Orc priests [AC: 5, HTK: 20 (4D8), 15, 11 (2D8), 7 (1D8)] that serve in the temple (see Room 3) All four are preparing to perform a service for Gnrrsty and the Half-Orc guards. Armed with maces, they know the following spells: fourth skill: Hold Person, Know Alignment, Sanctuary, and Cure Light Wounds (reversible); second Sskill: Sanctuary, Cure Light Wounds (reversible); first skill: Cure Light Wounds (reversible).
- 3 – Chapel with an altar in the western portion of the room. Benches fill the remainder of the room. There is nothing of value in the room except for a pair of mithril candlesticks on the altar.
- 4 – Its northern door is always kept open; will always have 1-4 Half-Orcs [AC: 5, HTK: 12, 8, 7, 10 (2D8)] and 3-6 Trorcs [AC: 5, HTK: 18, 12, 21, 24, 22, 17 (4+2D8)] in it.
- 5 – Gnrrsty's Hoard. Hiding place for Gnrrsty's treasure. No one, other than Kiril, knows of this room's existence. The door to this room is wizard-locked and twice trapped:
  - 1) There is a poisoned needle in the lock, it has concentrated Water Naga poison on it. If someone discovers the needle with his/her finger and fails to save vs. poison, he/she will take eight points of damage for eight rounds – 64 points total – plus

being paralyzed for 8-32 rounds. If the player saves vs. poison he/she takes 4 points per round for eight rounds – 32 points total – and must save vs. paralysis or be paralyzed for 4-16 rounds.

- 2) There is a gas trap in the door, which if not deactivated, will release poisoned gas into Rooms 4 and 5; all within must save vs. poison or die.

Gnrrsty's hoard consists of:

120,940 gp; 24 pieces of jewelry, a Quaal's Feather Token (roll for type); a Wand of Illumination; a Rope of Constriction; Four books (three are ledgers keeping track of pay for guards), one of which is a Vacuous Grimoire; a Ring of Fire Resistance; a Potion of Levitation; and a Scroll of Seven Magic User Spells (level of Spells in parenthesis): Locate Object (2), Water Breathing (3), Polymorph Other (4), Magic Jar (5), Stone Shape (5), Stone to Flesh (6), Wish (9).



## FOURTH FLOOR

- 1 – A very plush cell for holding VIP prisoners; the door is wizard locked. Currently, this room is occupied by Asha, the high priestess of the Emerald Valley Dwarves. She is of skill 8 and knows the following spells:
  - 1st level: Create Water, Cure Light Wounds, Remove Fear, Sanctuary;
  - 2nd level: Augury, Resist Fire, Slow Poison, Spiritual Hammer;
  - 3rd level: Continual Light, Locate Object, Speak with Dead;
  - 4th level: Cure Serious Wounds, Exorcise.
- 2 – Antechamber holding 60 undead statues on wall shelves. If Gnrrsty uses the Cube of Undead Control, these will be the first undead summoned (unless, of course, the statues are destroyed). Four Jackalweres [AC: 4, HTK: 21, 14, 18, 20 (4D8)] live here, guarding the statues. They have no treasure, having lost continually at cards.

**Trap:** Between Rooms 2 and 3 is a small chamber. On the outer wall of each room is a small button (treat as if finding a secret door). If the button is not pushed before someone enters the room, a huge stone block will fall from the ceiling dealing the first person into the room 6-48 points of damage (no save, it is a BIG block). Since the block is only 3' high, it may be climbed over.

3 - Gnrrsty keeps a family of six Rust Monsters [AC: 5, HTK: 30, 25, 20, 27, 22, 18 (4+4D8)] here to reduce the probability of his being attacked. (If he needs to get anything metal into his room, he carries the item in a bag of holding). The secret door in the north wall is partially covered with contact poison (75% chance for whoever opens the door to touch the poison); if the poison is touched, save vs. poison or die.

### FIFTH FLOOR

Gnrrsty's Room contains a large double bed, a huge clothes closet and several chests filled with dishes, silver, etc. In the center of the east wall is a huge fireplace; above the fireplace is mounted the Mighty Axe "Sejm." Gnrrsty who has the master Ring of Undead Control (+50%) is probably (80%) in the company of 1-3 Half-Orc females. If Gnrrsty looses the race to get the Axe from the wall (he doesn't want to use it, just keep the party from getting it), he will use the Cube of Undead Control to summon undead to attack the party. If Laer Redhorn has saved his Orb of "True Dwarven Essence" and uses it here, it will nullify all magic in the room (including magic items, the cube and the Axe) for 1-4 hours. Then the party must figure a way to get out of the castle.

Gnrrsty: Assassin, skill 10; Fighter, skill 10; Cleric, skill 4. AC: 0, HTK: 62 (10D10), Strength: 10, Intellect: 17, Insight: 14, Dexterity: 17, Stamina: 16, Appeal: 6.

Magic Items with him here: Cube of Undead Control, Ring of Undead Control (+50%), Ring of Flying, Rod of Smiting, +3 Dancing Sword.

### Powers of the Mighty Axe "Sejm"

*Axe is VERY Chaotic Good and may only be used by players of the same alignment!*

- 1) Blade acts as a double-edged vorpal weapon; it acts as a +3 Returning Axe if thrown. It will return 30' to its wielder.
- 2) Wielder has all natural Dwarven abilities; abilities are doubled if the wielder is a Dwarf.
- 3) Clairaudience (unlimited use).
- 4) Clairvoyance (unlimited use).
- 5) Teleportation (of up to 300 people) twice a day with no error.
- 6) Casting a spell while in possession of the axe will cause a voice loss for 2-8 days.
- 7) Death Ray (one creature; no save allowed), once per day.
- 8) Disintegration Ray (save allowed), once per day.
- 9) Time Stop (twice normal duration), once per week.
- 10) Possessor loses all interest in sex.\*
- 11) Possessor has a poisoned touch; all who touch (or are touched by him/her) must save vs. poison or die.\*

\*The last two powers are the reason why Ael Hoarfrost, King of the Dwarves, has never married.

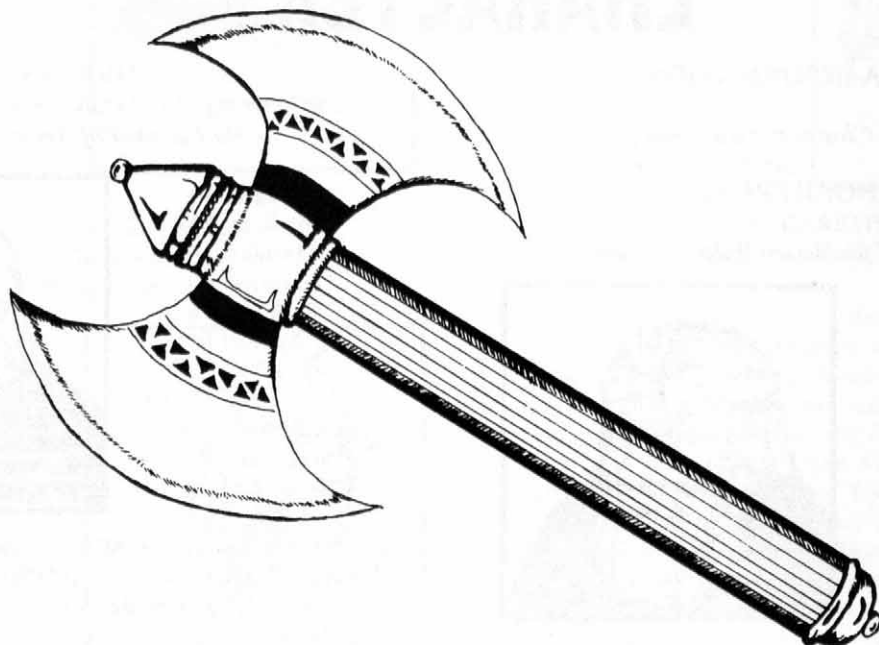



# APPENDIX ONE

## THE ADVENTURE

### SUMMARY OF THE FIRST SEVEN DAYS

*for use if the first half of the adventure is skipped*

Seven days have passed since you started on your journey to visit the Tree of Enlightenment. It has not been an easy trip, for many dangerous monsters have attacked the party. Thus far, the party is still 100% (as far as hits are concerned), but the spell-casters in the party are almost completely drained of energy.

In spite of the apparent urgency of the quest, you have decided to spend two days in Fin resting and allowing the spell-casters to regain their spells (they have all brought their spell books and spells can be re-energized with proper rest and study).

The two days have passed – the entire party is 100%.

You have set out for the Sleeping Giant Mountain. Arriving at the base of the mountain, Knorr tells you that the tunnel entrance is but a few hundred feet away. What do you do?

NOTICE TO DM: Knorr, having been through the tunnel once, would estimate that it would take twice as long to climb over the mountain, rather than using the tunnel. Proceed to Encounter 12.



# APPENDIX TWO

## CHARACTERS

### PERSONA INFORMATION

#### *Non-Player Character Summary*

#### AEL HOARFROST

FIGHTER/CLERIC

*Current King of the Barren Ridge Dwarves*

Strength: 16  
 Intellect: 10  
 Insight: 17  
 Dexterity: 11  
 Stamina: 17  
 Appeal: 14  
 HTK: 55  
 Skill: 7/7  
 Damage Dice: 9+9  
 Armor Class: 2  
 Chaotic Good



Magic Items: Bracers of AC: 2, Ring of Earth Elemental Control, +3 Ring of Protection.

#### GNRRSTY

HALF ORC ASSASSIN/FIGHTER/CLERIC

*Half brother of Ael and Gran*

Strength: 14  
 Intellect: 17  
 Insight: 14  
 Dexterity: 09  
 Stamina: 16  
 Appeal: 06  
 HTK: 62  
 Skill: 10/10/4  
 Damage Dice: 10  
 Armor Class: 0  
 Chaotic Evil



Magic Items: Bracers of AC: 2, Cube of Undead Control, Ring of Undead Control (+50%), Ring of Flying, Rod of Smiting, +3 Dancing Sword.

Spells Known:

Curse, Cause Light Wounds, Sanctuary, Purify Food/Drink, Spiritual Hammer

**KIRIL**  
**MAGIC USER**  
*Gnrnsty's Assistant and Magic User*

Strength: 07  
 Intellect: 18  
 Insight: 15  
 Dexterity: 15  
 Stamina: 12  
 Appeal: 07  
 HTK: 38  
 Skill: 12  
 Damage Dice: 11  
 Armor Class: 1  
 Chaotic Evil



Magic Items: Bracers of AC: 2, Ring of Undead Control (+25%), Wand of Fear, Wand of Lightning, Ring of Levitation

Spells Known:

For the purpose of this adventure, assume Kiril knows all spells up through 6th level spells; he can only cast the number available to him as a skill 12 Magic User.

Since he is mentally unstable, there is a 15% chance that any spell he cast will NOT work (80%), OR will have a different effect than Kiril intended (20%).

**BOMFORTH**  
**TYPE IV DEMON**  
**NOW THE TREE OF ENLIGHTENMENT**

HTK: 72 (11D8)  
 Armor Class: -1  
 Chaotic Evil



**CRIMSON PENDRAGON**  
**RED DRAGON**  
*Wife of Gran*

AC: -1  
 HTK: 60 (10D8)  
 Neutral Evil



Spells Known:

Comprehend Languages, Magic Missile, Invisibility, Stinking Cloud, Gust of Wind, Blink

**GRAN HOARFROST**  
**NOW A RED DRAGON**  
*King's Brother, Now named Geoffrey Pendragon*

AC: -1  
 HTK: 80 (10D8)  
 Neutral Evil



Magic Items: Amulet imbedded in place of one scale allows him to see anything invisible.

Spells Known:

Charm Person, Magic Missile, Mirror Image, Web, Feign Death, Protection from Normal Missiles, Polymorph Self, Polymorph Other.

*Player Character Summary*

**KNORR OF THE MURKEY MOUNTAINS**  
**DWARVEN RANGER**

Strength: 14  
 Intellect: 13  
 Insight: 15  
 Dexterity: 13  
 Stamina: 16  
 Appeal: 12  
 HTK: 55  
 Skill: 9  
 Damage Dice: 10  
 Armor Class: 0  
 Height: 4'5"  
 Weight: 132 lbs.  
 Lawful Good



Magic Items: +1 Plate, +1 Shield, +1 Flame Tongue Sword.

Since the eruption of the volcano, "Firespitter," contact between the Dwarven strongholds in the Barren Ridge and those in the Murkey Mountains have been sporadic at best. Usually, the only reason for contact is the biannual pledge of loyalty, and delivery of taxes from your ruler (also your father) Duke Kirie to Ael Hoarfrost, the current King of the Dwarves. Your grandmother was a Half Elf, a fact that neither you nor your father care to reveal. Since you are a very moody Dwarf, often preferring the out of doors to the natural rocky caverns of home, your father has chosen you to be his representative to the King.

You are assured of your father's title (you have no brothers or sisters) assuming that you perform well during the Rite of Oovra Droom. In the past year, you have met

Ivor Conecap, the human Druid. You like him very much and are determined to impress upon him your worthiness to be heir to your father's title.

You have made 26 trips for your father to the royal court and are well known there. You and your ten guards (to protect the taxes and fight monsters) ride in a large horse-drawn cart; an extra horse is tied behind the cart. You have always followed the road from Anor (capital of the Murkey Mountains) to Ostohar (capital of the Barren Ridge) except once. Though travel by road is very dangerous (many monsters, brigands, etc.), on that particular trip you lost 35 of 42 guards, the taxes, and your determination to ever travel off the main roads again. You will leave the guards from this trip at the King's court until the Rite is completed and plan to volunteer the use of the cart and horses for those participating in the Rite.

During the time you have spent exploring the Murkey Mountains, you have seen many strange wonders (i.e., Arborents [animated trees], Griffins, etc.). The most unusual natural phenomena you have seen is the mountain in the shape of a man lying on his back. It is to be found north of Fin (see map of personal explorations). The local villagers believe that the mountain is actually an enchanted giant who will arise to protect them in time of dire need. In exploring the mountain, you discovered a tunnel leading under the mountain. The passage was several miles long, wound through three large underground chambers, and finally emerged into a green valley on the other side of the mountain. You were tempted to explore the valley and the strange-looking, huge tree (it was several hundred feet tall, with purple and silver sparkling leaves) growing at the southern end of the valley (perhaps a half mile away). What really put you off, however, was the large, red dragon sleeping in the sun in front of the tree. You have never gone back.

Though a Dwarf, you are essentially a Ranger and for the duration of this adventure will be treated as such. You have no ambition to be King of the Dwarves, preferring to continue to serve the Murkey Mountain Dwarves as their leader. Also, you have developed a natural sense of direction which allows you to know which way you are going with a 95% accuracy. In addition, you have an amulet that allows you to detect magic (usable twice a day), but will not openly use it.

Since the Axe must be recovered and returned to King Hoarfrost, and you must prove your worthiness to inherit your father's title, there is much to be gained (and lost) in the days ahead.



## IVOR CONECAP HUMAN DRUID

Strength: 10  
Intellect: 13  
Insight: 16  
Dexterity: 11  
Stamina: 17  
Appeal: 17  
HTK: 72  
Skill: 12  
Damage Dice: 12  
Armor Class: 3  
Height: 5'9"  
Weight: 145 lbs.  
Neutral



Magic Items: Bracers of AC: 3, Scimitar of Sharpness, Staff of the Serpent.

Spells Known: . . . . . Choose own spells

Though human, you have been a close friend and associate of the current Dwarven King, Ael Hoarfrost, for the past 40 years. Most of the time King Hoarfrost would come to you for advice and counsel in private; thus, your association with the King is not widely known. Also not widely known is that you are an accomplished alchemist, whose potions are much better than average.

King Hoarfrost, almost 400 years old, has never married and thus has no heir. He is worried about whom to name as his successor, as there are many suitable candidates among the young Dwarven nobles. However, no one has particularly caught the King's fancy. He is hopeful that a suitable "heir" might be chosen from the current group undertaking the Rite of Oovra Droom and has asked you to accompany the party to assist them in any way needed, and to be an impartial observer to individual acts of heroism, bravery, and cunning on the part of the participants. He is evidently afraid of dying without naming an heir; afraid that war might break out between the different factions now under his rule. You, of course, have agreed to the King's request.

HOWEVER, your motives are slightly different from those proposed by the King. While you will act as an observer of the party and will make a report to the King at the completion of the mission, your main reason for accompanying the party is to locate some basalisk blood. It is the only ingredient you lack to complete a special longevity potion; you plan to give it to the King once complete, knowing that it will add about 150 years to his life. This, you hope, will be long enough for him to marry and to raise an heir of his own, and not have to depend on a young, untried Dwarven lord. Thus, while you will not reveal your real reason to the party, finding of a Basalisk (and killing it) is more important to you than the finding of the Great Axe. You have heard of the Tree of Enlightenment growing to the north of the Murkey Mountains and hope to be able to converse with it (using telepathy) to get some help in achieving your goal. You have a Reincarnation Scroll safely stored in your pack.

Of all the candidates participating in the Rite, the only one you know personally is Knorr of the Murkey

Mountains. He is an odd Dwarf, seeming to prefer the out of doors to rocky caverns. You have met him several times in the company of King Hoarfrost and have been assured that you can trust him to help you if needed.

You are quite aware that if the Dwarves are uprooted from their homes in the Barren Ridge, your peace and serenity will be the next things lost. Thus, there is much to be accomplished in the days ahead.

**FROR INGREN**  
*DWARVEN FIGHTER*

Strength: 18/00  
Intellect: 12  
Insight: 14  
Dexterity: 16  
Stamina: 16  
Appeal: 10  
HTK: 68  
Skill: 9  
Damage Dice: 9  
Armor Class: -2  
Height: 4'  
Weight: 96 lbs.  
Chaotic Good



Magic Items: +2 Splint Mail, +3 Returning Warhammer, Displacer Cloak.

You are one of the military leaders of the Dwarves; also the heir of Lord Ingren, chief spokesman of the Dwarven Council. You have chosen the military because you LOVE to fight and command others to do your bidding. You always know the best strategy when a battle is to be fought (or so you think) and love to lead others into battle. You are also quite aware that 1/3 of your intellect comes from a large Blue Diamond Amulet you're wearing (it adds +5 to your intellect and grants Protection from Normal Missiles as long as it is worn). The amulet was a gift from your father on your 100th birthday when he finally realized that you really would rather fight than think. Before you were given the amulet, you tended to go berserk with rage whenever anyone disagreed with you.

You agree that the Axe must be recovered and returned to the King. Since you have a great affection for women (and the thought of a beardless Dwarven female is very exciting!) you feel, and perhaps rightly so, that the King needs a wife. So, you're determined to bring a beardless Dwarven female back to the King (in the hopes that you might be named his successor) even if you have to search the entire valley by yourself.

You are driven by the memory of your grandfather who, so local rumors say, married one of the few beardless Dwarven women ever seen. She died shortly after your father was born and you both have been teased all your lives as having an "unnatural" mother/grandmother. Shortly after your grandmother died, your grandfather disappeared for eight years only to appear at the Barren Ridge - completely mad!

He is completely irrational except when asked about his wife, then his garbled reply is almost always the same:

*Up or down or down or up!!  
Up or down or down or up!!  
Gnolls up, Orcs below, Half-Orcs everywhere!  
Ooooooh! Through the eyes of the snake  
And to the evil below . . . .  
AAHAAHHHHH . . . .*

(and holding his head he would lapse into silence)

You're not too worried about the "evil" as there will always be evil to fight. So far you have always won, by hook or crook, but the stakes are much higher now!

**LAER REDHORN**  
*DWARVEN CLERIC*

Strength: 11  
Intellect: 13  
Insight: 18  
Dexterity: 10  
Stamina: 15  
Appeal: 17  
HTK: 50  
Skill: 8  
Damage Dice: 8  
Armor Class: 0  
Height: 4'  
Weight: 147 lbs.  
Chaotic Good



Magic Items: Orb, +1 Plate Mail, +3 Flail, Belt of Fire Giant  
Strength +4/+10

Spells Known: . . . . . Choose own spells

You are the temporary religious leader of the Barren Ridge Dwarves. Your predecessor was killed several years ago and you view the Rite of Oovra Droom as the final test to be passed before your confirmation as the true leader of the Church. However, your ambition goes further than that; already popular with many Dwarves, you feel you would make an excellent successor to the Dwarven throne.

To this end, you are determined to prove your worthiness by becoming the leader of the party undergoing the Rite. By so doing, you feel that you can insure that all will return alive (for their parent's gratitude, of course) and to acquire much treasure for the church's coffers (to gain favor with your god, too).

Being very headstrong, if you are not elected group leader, you may very well go and do what you think is best, taking your assistant Hild Wilya along. In any case, you have decided not to let party squabbling or indecisive action deter you from your goal. Should the party decide to go along with you, you will be careful to confer with all to carefully decide the group's actions. After all, you want to curry favor with the future leaders of the Barren Ridge, too.

The High Priest of the Dwarven Church (for all Dwarves everywhere) has given you an item to be used only in a DIRE EMERGENCY. It appears egg-shaped, is green, and has two gold bands set perpendicular to each other. Inserted in the top is a small replica of a Dwarven war-hammer. You were told that when the hammer is removed from the Orb, and you are in an ENCLOSED



ROOM (size of the room doesn't matter), then "true Dwarven essence" will manifest itself. If you find no need to use the Orb the High Priest will not be annoyed. Also, your Cross (made of gold and studded with rubies) acts as a +6 Appeal charm.

You know there is much to be gained (and lost) in the days to come.

**LONI ROHAN**  
*DWARVEN THIEF*

Strength: 11  
Intellect: 08  
Insight: 13  
Dexterity: 17  
Stamina: 15  
Appeal: 11  
HTK: 50  
Skill: 10  
Damage Dice: 10  
Armor Class: 4  
Height: 4'6"  
Weight: 135 lbs.  
Neutral



Magic Items: Bag of Holding, Ring of Feather Falling, Ring of Free Action, Portable Hole, (Normal Studded Leather Armor and Sword)

Your father, Baron Tael Rohan, is the Guildmaster of the local Thieves Guild. Though you are very skillful, you have chosen not to challenge your father for the Guild leadership, preferring to set your sights higher.

Since the purpose of Oovra Droom (to recover the Ancient Axe) has been given to the party as a whole, you realize that you won't be able to claim individual credit for the Axe's return unless all other party members are dead. Since it has occurred to you that your returning alone might look suspicious to the King (even if you had the Axe) you have determined to incur his favor by returning home with as much treasure as possible. You feel that an exceptionally large "gift" might convince the King to name you his heir.

To aid you in your goal, you have had a Bag of Holding sewn into your left boot (unbutton a flap between the inside lining and the outside leather to reach in) which none of the other players know of. If you intend to steal anything — either player's equipment or treasure found — pass the DM a note and he will let you know if the attempt succeeds. The bag will hold items up to 5' long and 2' wide (the mouth of the bag unfolds when the flap is unbuttoned).

When you are not busy practicing your chosen vocation, your favorite hobby is mountain climbing. You have another Bag of Holding on your belt; it contains your climbing hammer, grappling hooks, spikes, climbing rings, and 500' of the thinnest, finest rope available. You never go anywhere without them. You are also used to having people search through your climbing equipment for lost or missing items, knowing full well that pilfered items are not kept in that particular Bag of Holding. One of your best friends, a Gnome named Freca Nimloth, shares your love of

mountain climbing. He is one of the two Gnomes participating in the Rite.

There is much for you to achieve in the days ahead.

**BRYTA FINROD**  
*GNOME FIGHTER/ILLUSIONIST*

Strength: 15  
Intellect: 16  
Insight: 10  
Dexterity: 18  
Stamina: 12  
Appeal: 12  
HTK: 45  
Skill: 4/7  
Damage Dice: 7  
Armor Class: 1  
Height: 4'7"  
Weight: 110 lbs.  
Chaotic Good



Magic Items: +4 Defender Sword, +3 Ring of Protection (5' radius), Wand of Illusion (58 charges left), Iron Staff, (Normal Leather Armor)

Spells Known . . . . . Choose own spells

You are the only son of the current King of the Gnomes, Narya Finrod. Obviously, you are not concerned with any problems the Dwarves may have in choosing a new king. Your main interest presently is surviving this silly Oovra Droom Rite in order to prove your worthiness to your father. He has always considered you to be a lazy playboy and has presented you with this opportunity to earn your title as "heir to the Gnomish Throne." If he hears that you haven't conducted yourself in a manner befitting a strong monarch-to-be, he has threatened to enlist you in the Gnomish army (as a junior officer!!) and have you sent to the furthest frontier — a prospect you do not relish in the least.

The other Gnome in the party, Freca Nimloth, (in addition to being the heir of Baron Nimloth) is your personal guardian. Since the Rite is a test of individual abilities, you will do your best not to call for his assistance. Unfortunately, this may become necessary for you fear heights (acrophobia) and all winged creatures (you are deathly afraid that they will grab you, fly to a great height and drop you); you hide whenever they are in the neighborhood.

Since it is apparent that the main objective of the Rite is to recover the Ancient Axe and return it to the Dwarves, you and Freca have determined to return with some great treasure (artifact, etc.) to assist your people in resisting the evil manifesting itself throughout the countryside.

To aid you in your test, your father has given you a 4' iron rod with several magical properties:

- 1) It can make objects disappear (as disappearance dust). This can be done once per day per item. The invisibility last for 6-10 hours for inanimate objects and from 2-5 hours for living recipients (people or animals). In combat, people do become visible and cannot be rendered invisible again for the rest of the

day.

- 2) It can make any invisible monsters/objects appear if they are within 30 yards of the Rod (like Dust of Appearance). This can be attempted four times each day.
- 3) It acts as a Staff of Striking.
- 4) It will grow to any length up to 100 feet (and will grow heavier — it is made of iron) and become roughened for easy climbing.

There is much to be gained (and lost!) in the days ahead.

**FRECA NIMLOTH**  
*GNOME FIGHTER/THIEF*

Strength: 16  
 Intellect: 12  
 Insight: 09  
 Dexterity: 17  
 Stamina: 15  
 Appeal: 14  
 HTK: 49  
 Skill: 5/6  
 Damage Dice: 6  
 Armor Class: 3  
 Height: 4'  
 Weight: 85 lbs.



Chaotic Neutral

Magic Items: +1 Sword (+3 vs. Lycanthropes and Shape-changers), Ring of Regeneration, Gauntlets of Dexterity, +1 Ring of Protection, (Normal Leather Armor).

You are the sole heir to Lord Nimloth, Chancellor of the Exchequer (and guardian of all of the Gnome King's treasures). While you hope to assume your father's duties when he retires, at the present you are in the service of the Gnome King, as guardian to Bryta Finrod, his son. You feel this Rite will prove the worthiness of all of the participants to be leaders of their respective kingdoms. To this end, you are determined to do the best you can and also to make Bryta perform to the best of his capacity. You are quite aware of his overwhelming fear of heights and flying monsters and will not let him get killed because of it. Both of you have agreed that as the Rite is to regain the Ancient Axe for the Dwarves, the Gnomes must have something of extreme value for their participation in the Rite.

You are also a close friend of Loni Rohan, a Dwarven thief, and share his addiction for mountain climbing. You don't carry any climbing equipment because Loni has a Bag of Holding on his belt that contains an inordinate amount of climbing equipment (hammers, spikes, crampons, etc.). He says its best to be prepared for anything and only keeps equipment in the bag — you've never seen anything other than climbing equipment come out of the bag, and you've been on many climbing trips together.

You are also an inveterate collector of valuable objects

and are not above stealing them. You have a small Pouch of Holding in the lining of your cloak; it will hold 6-8 large gems or 1-2 pieces of jewelry. Your favorite tactic when in the field is to do your thieving when you are supposed to be on guard duty (when the others are asleep!). You know you are almost above suspicion — after all, you are the royal prince's guardian! If you decide to steal anything whether from the party or from the monsters, pass the DM a note and he will tell you if you have succeeded in your attempt. One innate ability (that you found quite by accident that you possess) is that you are naturally trusted by Dragons — they will not attack you (85% of the time). HOWEVER, those that have attacked your party have been absolutely enraged by your presence; but mad as they were, they would still allow you to talk to them (if even for a short period) before they attacked. At times you have even used this friendliness to steal from the Dragons themselves.

There is much to be gained (and lost!) in the days ahead.

**HILD WILYA**  
*DWARVEN FIGHTER/CLERIC*

Strength: 17  
 Intellect: 12  
 Insight: 16  
 Dexterity: 13  
 Stamina: 16  
 Appeal: 09  
 HTK: 57  
 Skill: 6  
 Damage Dice: 6  
 Armor Class: 2  
 Height: 4'1"  
 Weight: 98 lbs.  
 Lawful Good



Magic Items: +4 Leather Armor, Vorpal Blade, +2 Shield  
 Spells Known: . . . . . Choose own spells

You are the leading recruiter and trainer for Dwarven clerics; once they have been recruited, it is your job to teach them to fight and defend the honor and glory of the church. This is quite surprising because you are female (your real name is Hilda). Obviously, you have not revealed your sex to the members of the all-male sect you belong to. You and Laer Redhorn (the current Dwarven Patriarch) are close friends and he doesn't know!

You were given your position because you have a complete and never ending compulsion to obliterate evil from the face of the earth. You have always been able to spot evil and detect its source — then you go berserk and eliminate it (20% chance of going berserk per round, cumulative). Since you were so successful, the church recruited you for your present position and you have not let them down yet!

You like the idea of the Rite — it is obviously a good way to test the future leaders of the country. However, the idea of just recovering the silly old Axe as a "true test" doesn't make sense. You want to get to the real root of the problem and find out who (or what) is responsible for killing the King's relatives and causing havoc among the

Dwarves. If the rest of the group wants to return after just finding the Axe, that's OK with you, you'll find the source of the evil and eliminate it singlehandedly.

You have done so well against evil recently that the gods have rewarded you for your untiring service. You are now +1 on all die rolls to turn undead; if successful, you add an extra D4 (1-4) to the regular number turned.

Also, from a purely female point of view, you are

interested in meeting beardless Dwarven women. Knowing how most male Dwarves react to any beardless woman, you feel their (the beardless Dwarven women) beauty secrets would be of inestimable value to the rest of Dwarven womankind. Also, the money you would make spreading their secret would make you VERY, VERY RICH!

You know there is much to be gained in the days ahead!

## APPENDIX THREE

# THE MONSTERS

### HOBGORC

HALF ORC – HALF HOBGOBLIN

AC: 5  
HTK: 2+3D8  
Damage: 1-8 or by weapon



Hobgorcs, a cross between an Orc and a Hobgoblin, are a race unto themselves. They have both normal and infravision (60') and can fight both above and below ground with equal ease. They are only average fighters, however, and are bullies by nature; thus when faced with superior odds, it is likely (65%) that they will abandon the fight and flee unless they have strong and charismatic leadership.

When aroused, Hobgorcs emit a subliminal keening which, although it cannot be heard, can certainly be felt as a vague sense of mental uncertainty. All who face attacking Hobgorcs must save vs. spells or be -3 to hit during the ensuing melee; if a save is made, a player will only be -1 to hit. The keening causes such complete mental uncertainty that it becomes impossible for Magic Users and Clerics to cast spells during melee. Saves vs. keening are normal unless there are 25 or more Hobgorcs attacking, then they are at -2.

For every 15 Hobgorcs, there will be a subleader with 4D8 and an armor class of 4. For every 30 Hobgorcs, there will be a leader with 6D8 (AC: 3). Both leader types do an extra 1-4 points damage per attack.

Hobgorcs are quite skilled at mining and can detect new construction, sloping passages and shifting walls 25% of the time.

Hobgorcs are medium sized (6'+ tall), Lawful Evil, and of average intelligence. They are brown, green, or

black with contrasting facial colors, usually a nauseating green-orange, yellow-pink, or puce. Since their color contrasts with almost everything, they have virtually (01%) no chance of hiding in shadows.

Hobgorcs speak Orc, Hobgoblin, Hobgorc, and alignment languages. Some (35% of all Hobgorcs) speak Common. They like large, shiny, sharp-edged weapons and keep them in meticulously perfect condition. They hate Elves and will always bully weaker creatures. They live to approximately 55 years of age.

### TRIPUS

AC: 3  
HTK: 8D8 - 12D8  
Damage: 1-12/1-12/1-3  
Special: Never surprised



The Tripus was developed by Orlow, the Beastmaker. Those few of his fellow Wizards who viewed these monstrosities saw them as a symptom of strain. The exact motive for developing such a vicious and unappealing creature will probably never be known.

An adult Tripus is a formidable opponent. Its three arms are tipped by hard, sharp claws. Further, the skin of a Tripus is thick and difficult to penetrate. Besides their trilateral symmetry, the most distinctive feature of a Tripus is the unusual location of its mouth. In the center of the head, the mouth is capable of swallowing whole large objects. Little is known about the breeding or even nesting habits of the Tripus. Now that several have escaped from his Villa, it is apparent how unfortunately successful Orlow was in developing these vicious, ever-hungry creatures.

TRORC  
HALF ORC – HALF TROLL

AC: 5  
HTK: 4+2D8  
Damage: 2-12  
(or 1-4/1-4/2-8)  
Special: Regenerates  
one hit per turn.



Trorcs, an awful cross breed between an Orc and a Troll, are ferocious fighters. In combat, they usually (85%) have only one attack, a vicious bite with needle-sharp teeth for 2-12 points damage. The rest of the time, they will try three attacks, two claws for 1-4 each and then the bite for

2-8; if both claws hit, the bite (if it succeeds, it will be at +3) will do 2-24 points damage.

For each 12 Trorcs, there will be a 5+5D8 leader. The leaders usually carry both a sword and a dagger and can use both each melee round. For each 20 Trorcs, there will be one 8D8 Chief, who usually carries two swords and uses both each melee round.

Trorcs inherited improved infravision (90') and regeneration (only 1 hit per turn) from their Troll parentage. They are dextrous (+2 with bows) and make good guards as they are completely fearless. They will usually use their bows until close melee is enjoined; then the bows are discarded and they attack as outlined above. From their Orc parentage, they have inherited a complete hatred of Elves and an attitude of extreme cruelty to all weaker life forms.

Trorcs are large (8' tall), Chaotic Evil, and of average to low intelligence. They are red, green, yellow, or brown in color with dull, black eyes and are somewhat fire-resistant (+2 to save vs. fire, but -2 save vs. cold) and immune to Fear spells. Trorcs speak Orc, Troll, and the languages of chaos and evil. They live to be about 75 years of age.

## APPENDIX FOUR

# EMERALD VALLEY DWARVES

No one among the Emerald Valley Dwarves knows for sure how they came to be in the floating mountain; they were not even aware that their home hung in mid-air. The few Dwarven historians that had studied the ancient records found hints that at some time in the long forgotten past, the homes of the Dwarves were subjected to disaster, a calamity of great dimensions that changed all their lives greatly. (If the party chooses to believe that this event was the inversion of their homes . . . so be it.)

In the last thousand or so years, the Dwarves have lived a happy existence. They have never tunnelled out of the mountain; their tunnels, when they go too far in certain directions, have hit a hard surface they have not been able to drill through; much to their annoyance. This impenetrable rock was, for some reason, created to keep them from reaching the surface and discovering the truth of the situation. Who perpetrated this act is not known!!!

Currently there are 236 Dwarves living in the valley. The entrance to the main tunnel complex is several miles from Gnrrsty's stronghold. The entrance is very well hidden; the Dwarves have had to avoid the dinosaurs of all sizes for as long as anyone can remember. The leader of the Emerald Valley Dwarves is Baron Arilan. The high priestess of the Emerald Valley Dwarves, Asha, was captured several months ago by a patrol from the castle. She and her escort were returning from a visit to some Dwarves living on the far side of the valley. In attempting to bargain for her life, Baron Arilan was also captured by Gnrrsty.





The rest of the Emerald Valley Dwarves, led by Styrn Bloodaxe, will not attack Gnrrsty's castle, fearing that their participation in an assault would lead to the immediate execution of both Arilan and Asha. If they discover the party (see "The Emerald Valley" description section) the Emerald Valley Dwarves will lead them to safety in the main caverns. There the party may eat and sleep in complete safety.

The male Emerald Valley Dwarves all have beards; only the females are beardless. When female Dwarves are born, an elaborate, secret ritual is performed for them by the High Priestess and her female clerical assistants. During the climax of the ritual, held in a dark cave, the baby girl's face is bathed in water from the magical spring "Rian." This completely inhibits the growth of facial hair on Emerald Valley Dwarf females. This spring flows up from the depths of the mountain in the dark cave used for the secret services; its very location is the greatest secret, A secret held only by the High Priestess and her closest assistants. When the water from the spring Rian is used in the dark (it has not been exposed to ANY light), it will act as a permanent dipilatory for both males and females – no hair will ever grow where the water has touched.

When a beardless female marries and has children (and she doesn't have to marry an Emerald Valley Dwarf – they just haven't had much opportunity to marry outsiders before this adventure), there is a 75% chance that her female children will also be beardless. Since the Emerald Valley female Dwarves are automatically treated, the above 75% chance need not be considered for the Emerald Valley females; just on those female Dwarves born outside the Emerald Valley. Remember, the water CAN be used outside the valley; it will retain its dipilatory powers only if no light hits it.

Once light has touched the water, it is not spoiled. Far from it! Applied externally, nothing will happen, but if a player drinks the water (about half a pint) all damage he/she has incurred will immediately be healed and the player will be completely refreshed, as if he/she had just slept for seven day straight (this does wonders for Clerics, Magic Users, and other spell casters!). However, if the same person drinks water from this spring more than once per week, he/she will immediately fall into a coma (no save) lasting for 2-12 days and awaken feeling very dizzy, sick,

and weak. He/she will have been reduced to only 1 hit per hit dice (plus any stamina bonuses) and will not be able to cast any spells; all spells and hits must be regained in the normal fashion (lots of rest and cure spells!). Also, to be transported safely, the water must be carried in tightly sealed crystal flasks (very expensive!) or hollowed out gems; carrying water in anything else will cause it to lose its potency in 6-30 minutes.

The Emerald Valley Dwarves will give the party some spring water to refresh themselves, but will not tell them anything more about the spring until they return with Asha and Arilan. Any magical implements the Dwarves have, they prefer to keep for their own defense.

The Emerald Valley Dwarves will provide the party with a map of the castle buildings; they have been able to see over the walls from the surrounding hills. The Dwarves have never been inside the castle (and lived to tell of the experience). Before Gnrrsty and Kiril conquered it, the citadel was run by a large group of Orcs, Gnolls, and Hobgoblins. The Emerald Valley Dwarves also know of the three entrances to the Troglodyte caverns; having seen Troglodytes on patrol with the undead (and others) from the castle, they assume that Troglodytes live down under the castle and have no desire to venture within their domain.

The male Emerald Valley Dwarves will immediately be taken with Hild Wilya. They immediately know her to be a female, but will not openly bring the subject up. Many will propose matrimony and will want her to stay in the valley. The Emerald Valley female Dwarves will feel much the same way about the male Dwarven members of the party – somehow they are "different" from the Emerald Valley Dwarves.

They will allow the party to rest as long as needed, but will urge them to leave for the castle immediately. After all, the sooner the party starts its attack, the better chance they have of finding Asha and Arilan still alive. As mentioned above, until the party returns with Asha and Arilan and/or news of them, the Emerald Valley Dwarves will not give them any more water, not will they reveal the secrets of the spring. Once the party returns from the attack on Gnrrsty's Citadel, it will be up to you, the DM as to how much the Emerald Valley Dwarves will tell the party.

## APPENDIX FIVE SPECIAL MAGICS

### CARRIED BY PARTY MEMBERS

### Orb

#### Amulet

Adds 5 to intelligence and grants Protection from Normal Missiles when worn. (Worn by Fror Ingren.)

It is green, with two gold bands, with a small Dwarven hammer in the top. If the hammer is removed from the top of the Orb inside a closed room (in other words, not outdoors), gas will fill the room, regardless of size. This gas is prepared from "True Dwarven Essence" and will completely and irrevocably cancel ALL MAGIC whether weapons or spell ability for 1-4 hours (roll for each item to

see how long it will be before it regains its magical abilities). If an item exposed to the essence is removed from the room where it was exposed, it will still have to wait the 1-4 hours before becoming magical again. (Carried by Laer Redhorn. Note: he does NOT know what effect removing the hammer from the Orb will have, or that THIS ITEM MAY BE USED ONLY ONE TIME!)

### Iron Rod

(carried by Bryta Finrod) has the following properties:

- a) Cause inanimate objects to become invisible for 6-10 hours; once per day per item.
- b) Cause living things to become invisible for 2-5 hours; once per person per day.
- c) Cause invisible monsters/objects to appear if within 30 yards: four times per day.
- d) Acts as a Staff of Striking.
- e) Will grow to any length up to 100 feet (remember it is made of iron, so there will be a weight factor involved) and become rough for easy climbing; two times per day.

### USED BY NON-PLAYER CHARACTERS

#### Ring of Undead Control

Similar to the Cube of Undead Control, these rings empower the wearer to activate some of the undead manufactured by Gnrrsty and Kiril when a command word is spoken (see Emerald Valley Citadel, Building 1). The undead will then form from the wax statues and will proceed to you via their normal mode of locomotion (i.e., Skeletons walk, Spectres fly, etc.). This control can be cancelled by the use of the Cube of Undead Control or by the two Master Rings of Undead Control – used by Gnrrsty and Kiril, they can simply transfer control of your activated undead to their ring, or Cube, channeling the power through your ring; your ring is left active and unable to summon any more undead. Under normal circumstances, when all of your summoned undead are killed, the ring will become inactive and you may summon some more undead. The ring vibrates as long as it is active, letting you know you still have troops to command. The undead you summon will be under your direct command, and will fight for you to the death with no morale check.

For each use of one of these rings, there is a 5% – it is cumulative per individual – that the user will be turned permanently Chaotic Evil (10% chance for Kiril's Ring and 20% chance for Gnrrsty's Ring). The ring cannot then be removed (the wearer will NOT WANT it to be removed); cutting the finger off will result in the ring slipping off the severed finger and reappearing on another finger of the same individual. Only in the final death of the character may the ring be removed. The rings may be destroyed in the same fashion that artifacts are destroyed; or all the gems may be destroyed so the rings no longer have any

undead to summon.

A normal ring summons undead in the following manner: percentile dice are rolled and the following table is checked. For normal rings, no roll over 60% will have any additional benefit (treat all rolls over 50 as summoning 1-12 Shadows).

For Gnrrsty's Ring, add 50% to the die roll. Treat any roll over 100 as having summoned groups of undead – the undead summoned for a roll of "00" and the undead summoned by the number over 100 (i.e., on a roll of 75 on Gnrrsty's ring, add the 50% bonus, giving a total of 125; thus Gnrrsty will have summoned 1-4 Vampires and 4-16 Zombies to his personal command). Kiril's ring functions in a similar fashion, but only 25% is added to the roll.



### UNDEAD ACTIVATION TABLE

*for Rings and Cube of Undead Control*

%	No.	Name and statistics
01-18	3 - 18	Skeletons [AC: 7, HTK: 4, 5, 2, 3, 4, 1, 1, 3, 5, 5, 5, 5, 4, 7, 7, 1, 6, 5 (1D8)]
19-33	4 - 16	Zombies [AC: 8, HTK: 13, 6, 14, 14, 10, 7, 7, 10, 11, 10, 9, 9, 14, 12, 11, 7 (2D8)]
34-45	2 - 24	Ghouls [AC: 6, HTK: 11, 6, 6, 14, 9, 6, 12, 6, 7, 9, 12, 12, 7, 7, 9, 10, 11, 9, 11, 8, 9, 3, 9, 6 (6D8)]
46-50	1 - 6	Ghasts [AC: 4, HTK: 25, 19, 14, 11, 14, 9 (4D8)]
51-60	1 - 12	Shadows [AC: 7, HTK: 12, 17, 16, 12, 17, 13, 17, 19, 19, 16, 11 (3+3D8)]
61-70	3 - 18	Wights [AC: 5, HTK: 15, 20, 14, 16, 21, 17, 28, 10, 24, 20, 12, 24, 16, 20, 19, 22, 17, 16 (4+3D8)]
71-80	1 - 12	Wraiths [AC: 4, HTK: 31, 30, 27, 27, 29, 17, 31, 24, 24, 16, 20, 23 (5+3D8)]
81-89	2 - 8	Mummies [AC: 3, HTK: 38, 22, 31, 25, 28, 29, 30, 31 (6+3D8)]
90-95	1 - 6	Spectres [AC: 2, HTK: 31, 36, 32, 42, 26, 38 (7+3D8)]
96-00	1 - 4	Vampires [AC: 1 HTK: 40, 44, 43, 46 (8+3D8)]

#### Cube of Undead Control

Unlike the Rings of Undead Control where you must be physically present to lead or direct the actions of the undead you have summoned, the Cube allows you to take over the mind of an undead creature (replace its mind with yours) and through that body be able to see and hear and direct the actions of the other undead. When assuming control of a group of summoned undead, control is always put into the one with the most hits. All the other undead will follow to the death any commands or instructions

given by the undead commander. If the commander is killed, the remaining undead will endeavor to complete whatever task was assigned them before the leader died; a new leader may be created through further use of the Cube and all the Cube-summoned undead will automatically defer to him. Those undead that have been summoned and are being commanded by persons wearing Rings of Undead Control are not affected by the Cube, unless the person using the Cube wishes to do so.

The Cube of Undead Control greatly resembles a Cube of Force; it has 30 charges that are renewed daily, attacks effect it as they do the Cube of Force. Air inside the Cube is always fresh when activated, and the force walls keep out everything (living and inanimate matter, spells, poison gas, etc.); the only exception to this is that someone may teleport inside the Cube – teleportation shifts a person out of phase temporarily – with a 55% chance of ending up in the working parts of the Cube. Unfortunate as this would be for one of the players, it will not hinder the working of the Cube at all.

When the sides of the Cube are pressed, Gnrrsty (or a player) will find themselves inside a Cube of glowing yellow force walls 6'x6' on a side. There is a small 3'x6' area containing a seat, and in front of it, a Crystal Ball sitting on a shelf. To the player's left, he will see a row of twelve (12) small drawers; opening a drawer will reveal a pair of eye cusps.

Under each drawer are four buttons:

Button 1: Activates undead statues (2-4 times the normal number summoned by the Ring of Undead Control). Placing the eye cusps on your eyes puts you in command of the largest member of the undead summoned; they are keyed to the button pushed. From right to left, the buttons activate:

Ghouls, TRAP, Skeletons, Wights, Shadows, Spectres, Zombies, Vampires, Ghosts, Mummies, Wraiths, TRAP

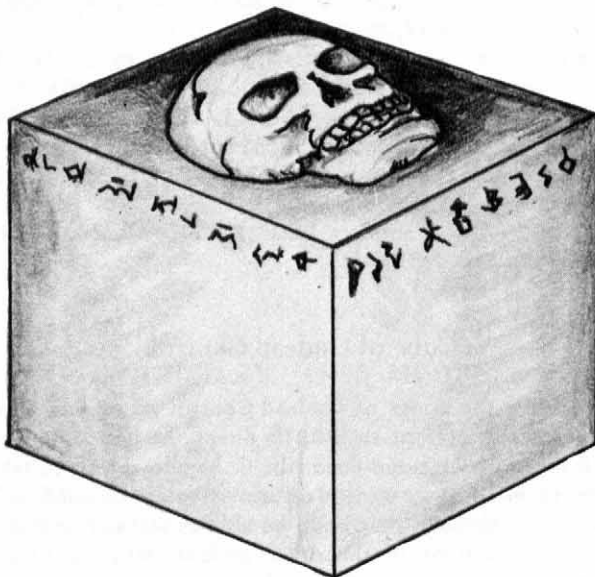

When the Cube is activated and the cusps are not worn, the undead summoned will proceed to the vicinity of the Cube and will attack anything within 100'. The two TRAPs are just that – they activate ALL the undead statues and ALL the undead proceed to the Cube, through the walls of the Cube (pushing the TRAP buttons sets the walls of force to allow them to pass), and pulverize the poor unfortunate who activated the trap. Naturally, the Cube cannot be deactivated once a TRAP button has been pushed until the activator is dead. If Gnrrsty's Ring of Undead Control is present in the Cube, the TRAP button will not function.

Button 2: Pushing this button activates the undead as does Button 1, but the Crystal Ball automatically lights up. The Ball is imbued with telepathy, clairaudience, and clairvoyance. It will show the undead activated and allow you to communicate your desire to them; you may specify a target to attack or a leader to follow – that person need not have a Ring of Undead Control, once ordered by the leader in the Cube, the undead will follow their new leader. This button may also be used to transfer control from one person to another.

Button 3: Automatically deactivates any remaining undead summoned by the Cube and teleports them and anything they had with them (living or not) back to the immediate vicinity of the Cube.

Button 4: Will allow the user of the Cube to take control of any non-Cube-activated undead of a particular type; depending on which button is used. If the button is pushed twice rapidly, the other person's Ring will become inactive, allowing him to summon more undead. Otherwise, control of the undead is passed to the Cube through the Ring, leaving the Ring active and unable to summon more undead.

The Crystal Ball in the Cube may be used by any character type; it was specifically created for Gnrrsty, by Kiril. If the Crystal Ball is activated first (there is a small switch mounted on the shelf), the Cube's user may cause any scene to appear in the Crystal Ball that he chooses. If the Crystal Ball is showing a scene the user is familiar with (i.e., not an imaginary scene) when Buttons 1 or 2 are pushed, the undead statues are first teleported to the area shown and then activated to wait their master's command.

Naturally, anyone using this Cube has a 65% chance of becoming irrevocably Chaotic Evil each time it is used. When all the undead under the control of the Cube have been deactivated (i.e., all killed or summoned back), the walls of the Cube will automatically drop after a 12-24 minute wait. As long as the charge defending the Cube have not been used up, the walls of force may be immediately raised again. The Cube must be destroyed in the same manner as other artifacts.

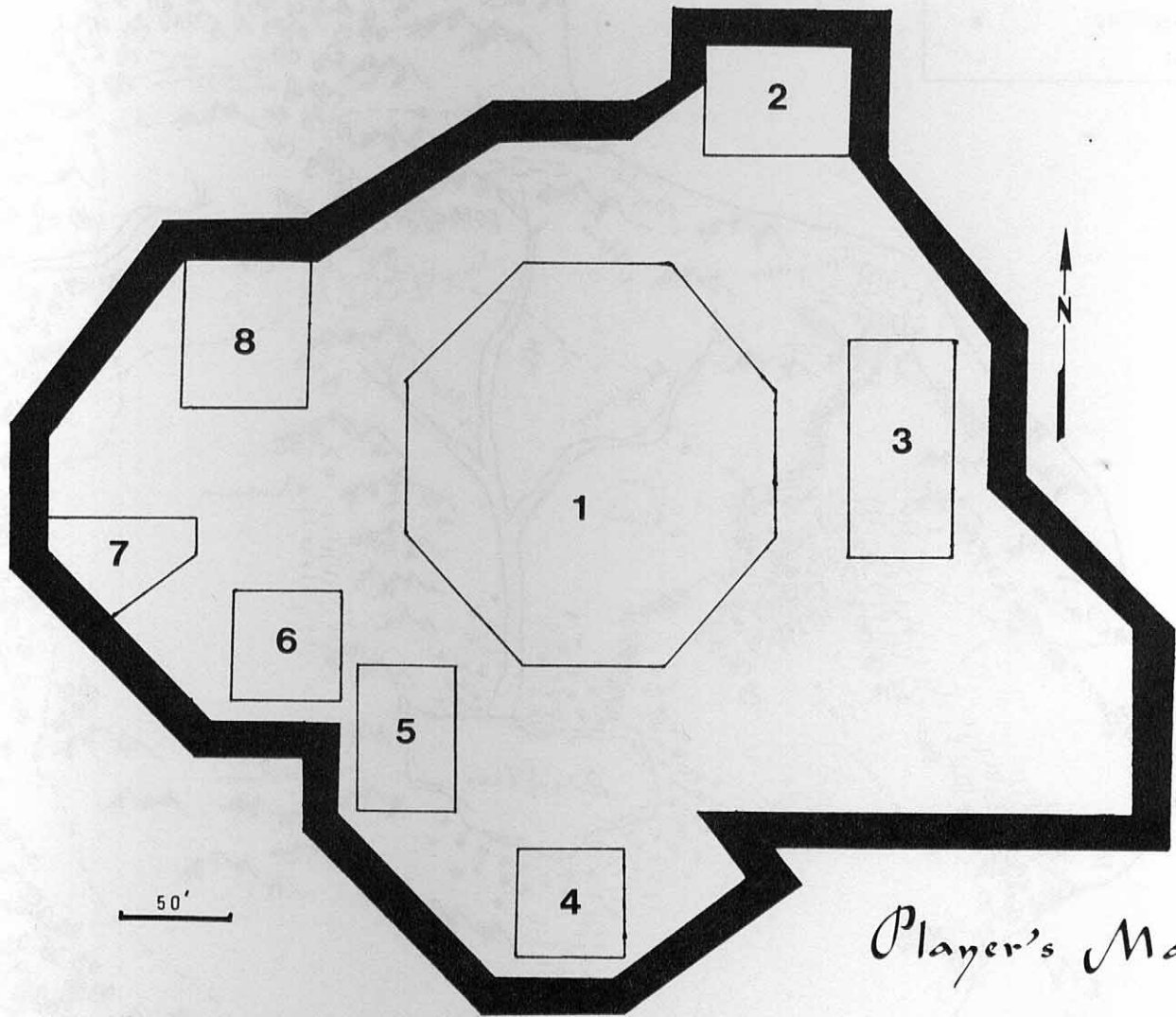

*Player's Map  
Emerald Valley Citadel*



LEGEND	
Mountain	
Non-Forested Hills	
Forest	
Swamp	
Clear/Grassland	
Lava Flow	
Lake	
Village/City	
Road	

# Knorr's Map

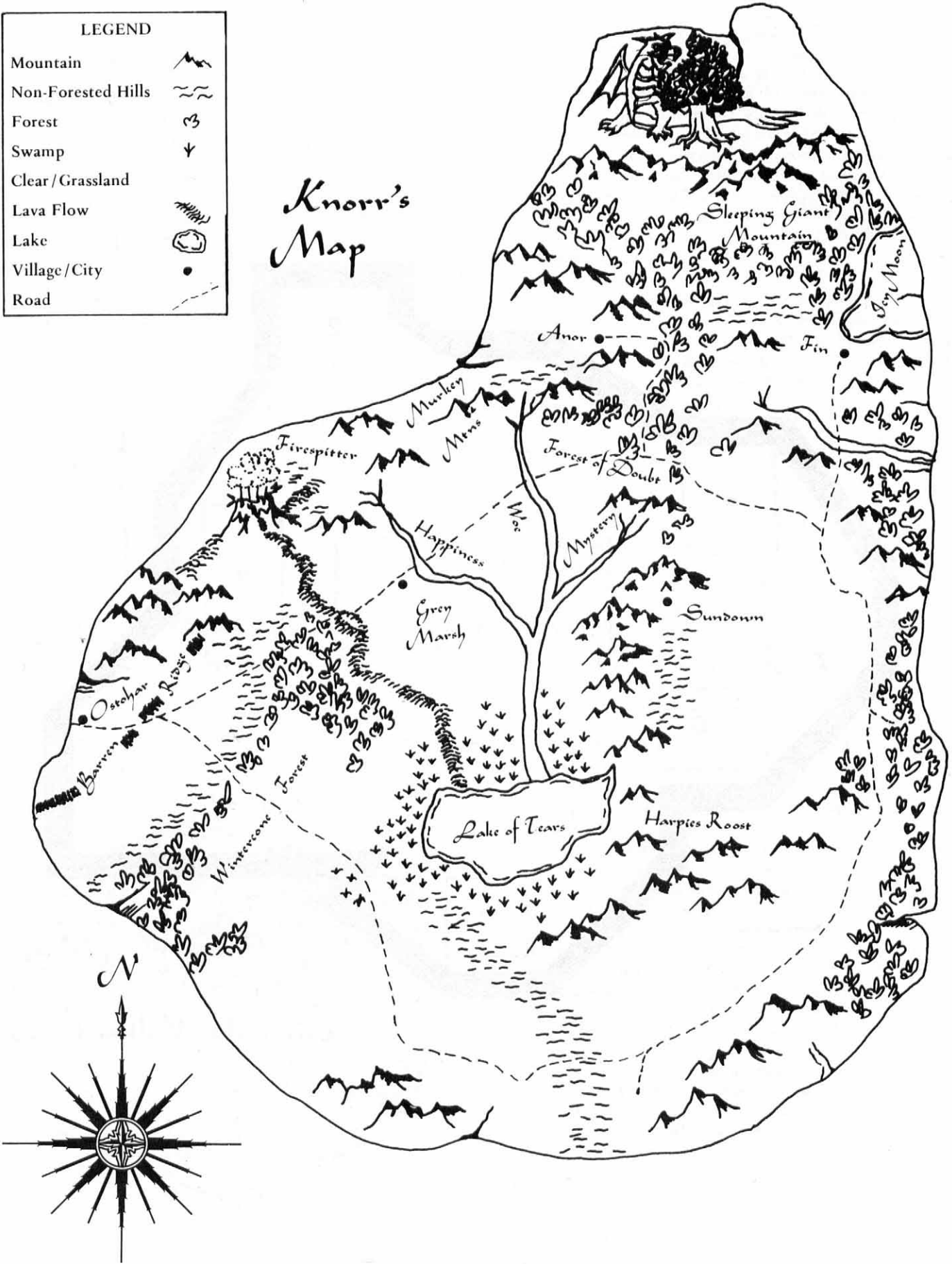



**Dwarves:** the stoutest warriors in the Age of Legend. Herein is recorded their history, gods, cultures, artifacts, wars, magics, mines, traps, and enemies. Includes a guide to the ancient cities of Ostohar and Amor, the village of Fin and featuring, *Dwarven Rite*, an epic adventure for 4 to 8 Dwarven characters of Skill Levels 5 to 10.

1085-704MFG10.00

00003



29877 01000

ISBN 0-912771-03-8

