

# 3G<sup>3</sup>

Hyper text  
version 1.1

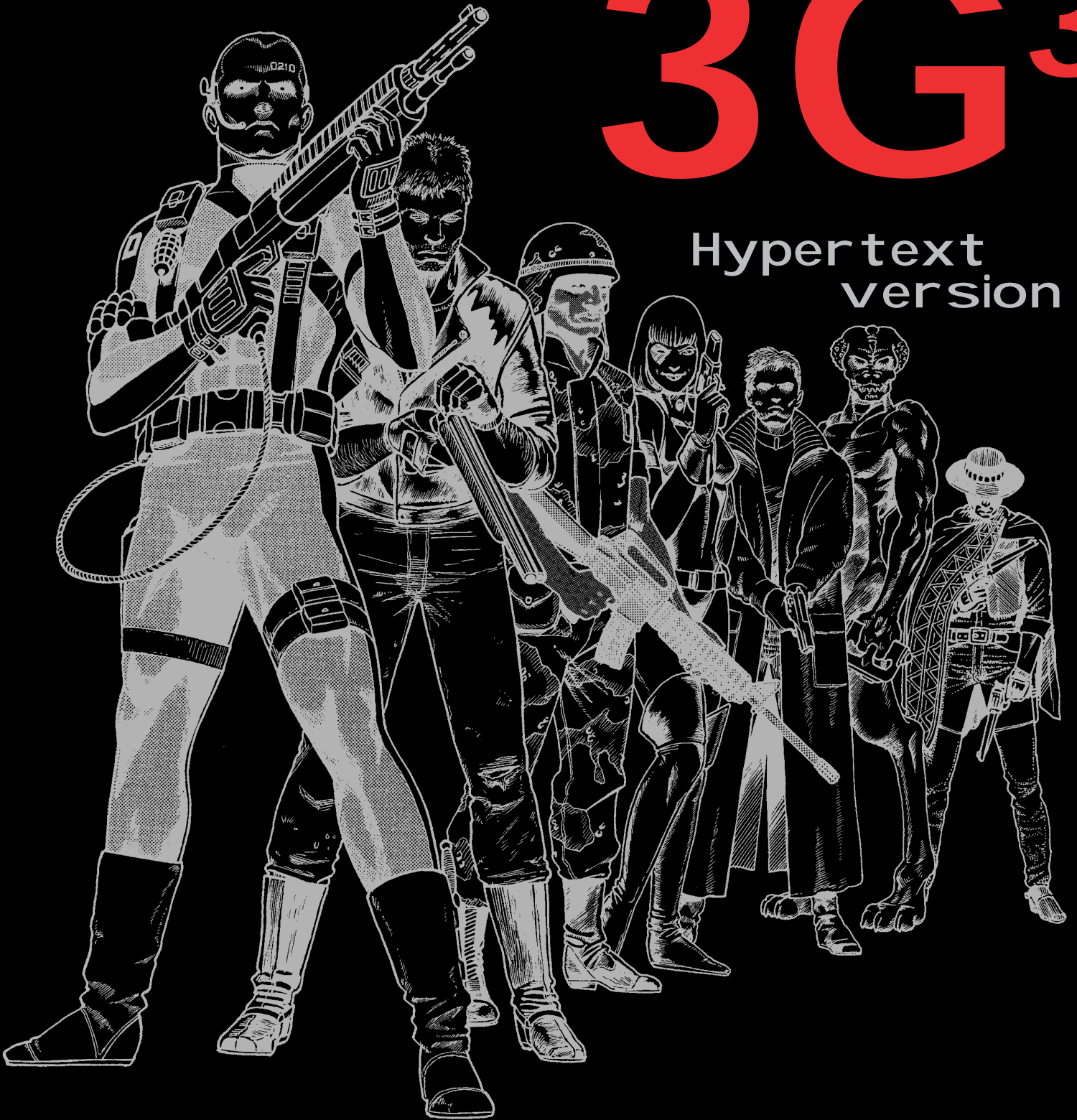

Weapon design for any RPG

# 3G<sup>3</sup>

Guns!, guns!, guns!, 3rd edition

©1991,1996 by Greg Porter

Published by:           Blacksburg Tactical Research Center  
P.O. Box 1121  
Collinsville, VA 24078 USA  
btrc@aol.com  
<http://members.aol.com/btrc>

Illustrations:         Thomas Darrell Midgette  
Computer graphics:   Greg Porter

Assistance:           Bertil Jonell, Otto Kopra, Sean Malloy, Jasper Merendino and numerous others who sent in comments and suggestions on the 1st and 2nd editions.

First edition           August 1988  
Second edition         January 1989  
Third edition          October 1991  
Revised third edition   October 1996  
1 2 3 4 5

Printed in the United States of America.

All rights reserved. Protected by the Universal Copyright Convention. Violators will be used as test subjects for ballistics experiments and other moderately stressful tasks.

**3G<sup>3</sup>** is the BTRC's trademark for its universal gun and melee weapon design system.

Most game names are trademarks of the companies publishing those games. Use of a trademark to identify a product mentioned in these rules should not be construed as implying the sponsorship of the trademark holder, nor, conversely, should use of the name of any product without mention of the trademark status be construed as a challenge to such status. So there!



# Introduction

## Intro to the hypertext edition

This is the digital version 1.1 of the **3G<sup>3</sup>** weapon design system, also known as **Guns! Guns! Guns!**. The electronic edition differs from the original only in that we've added a little color (as above), and some useful cross-referencing here and there. You won't be able to do much full-page reading of it unless you are fortunate enough to have a full page monitor, but you can print off the .pdf file to a laser or color printer and get a copy with the exact same information you would get in the printed version, for a significantly lower cost.

However, please remember that **BTRC** is a small company (i.e. one guy, me), and any copy you make that you are not going to personally use literally means that I'm less able to make a living at the marginally profitable job of game design.

Pleading aside, the best way to use these rules on-screen is to set your magnification to a comfortable reading level, set your Acrobat reader to thumbnail mode, and use the thumbnails for onscreen maneuvering. Once you become familiar with the book, you'll be able to associate the tiny thumbnails with each rules section, and jump to them as needed. If you are going to hop from section to section, a full set of bookmarks is available in bookmark mode, and if you still can't find something, go to the **Index** bookmark, which has hyperlinks to every item in it.

As in our other hypertext products, anything you see in red is probably a hyperlink to more detail on the highlighted item. For **Hypertext 3G<sup>3</sup>** we have the default magnification set to a comfortable level for reading on 15 inch monitors.

## Other BTRC info

This is the second on-line product we've made available. The first is **Slag!**, the hypertext version of our space combat and starship design system. Unlike **3G<sup>3</sup>**, it was designed expressly to be used on your computer, and is formatted for full-page reading on most monitors, is extensively hyperlinked, with web links, **NASA** technical references and other neat stuff. It took a lot of work for a product that is only US\$5-6, but if you are a space combat fan, it's certainly worth checking out.

If for some reason you didn't acquire **Hypertext 3G<sup>3</sup>** through a legitimate channel (mean person!), note that we also have a full set of spreadsheets available to almost completely automate weapon design. These are available for a number of platforms and spreadsheet programs, and are available for a nominal fee from on-line vendors of **BTRC** goods. For information on how to order these or other **BTRC** products, check out our web site, at <http://members.aol.com/btrc>.

And, as long as you are on-line and interested in **BTRC** products, note that we produce a few role-playing games of our own, the most sophisticated of which is **CORPS**. You can download a condensed version of the rules for free from our web site, so check it out. Thanks, and remember that you can always email([btrc@aol.com](mailto:btrc@aol.com)) if you have questions.



*Greg Porter*

## Intro

This is the updated 3rd edition of **Guns!, Guns!, Guns!**, otherwise known as **3G<sup>3</sup>**. It is a set of design rules and guidelines to let you construct a realistic set of melee and ranged weapons for virtually any role-playing system. They can be kept in the detailed **3G<sup>3</sup>** format, or transferred to the system you currently play, or even to systems of your own design. You have the advantage that any weapon designed with **3G<sup>3</sup>** will follow the same rules as any other weapon designed with the system, giving you a level of cross-system consistency no other weapon supplement can match. Read on!

## Designer's Notes

**3G<sup>3</sup>** has progressed from a simple black and white booklet (1988), through two printings of the 2nd edition (1989), to the third edition (1991) to what it is now (1996). Originally a hidden design tool for the 2nd edition **TimeLords** rpg, it was published in the hope that a few others would like to take advantage of its capabilities. Despite being the densest, driest, most textbook-like game supplement ever made, acceptance of **3G** was surprisingly high, and there are now enough copies in circulation to prove that it works, and people *did* want what it could give them. But it still had a few bugs. You can never get rid of them all, but you have to try. So, lessons learned have been incorporated into each new edition.

If this is the first time you have seen **3G<sup>3</sup>**, here's what it is: A system that lets you create or recreate just about any weapon that has ever existed/might exist, in a form that you can convert into the role-playing system you use. For instance, while you might not be able to *exactly* duplicate an Uzi using the design rules, you can get accurate figures for a weapon with the characteristics of a 9mm submachine gun built with 1960's technology, having a medium length barrel and a 30 round clip. You'll know how long and heavy the weapon is, how much it costs, the range characteristics, and so on. While this is no big deal, since you can just look up the real world figures, the system would also let you design a submachine gun that might be built using technology from the year 2100, or what a submachine gun might be like if built in 1800!

While these rules are mainly for hand-held weapons, the equations used can be stretched all the way out to naval guns and starship weapons with surprisingly little loss of accuracy, provided you pay sufficient attention to detail.

These rules require a bit of thought to use, and no doubt you will run into design dead-ends and compromises. Your hand-held tank cannon will end up weighing more than you do, and the recoil would knock you into next week, anyway. For computer buffs, all the **3G<sup>3</sup>** rules are based on formulas (condensed into tables for convenience), and you can design spreadsheets to virtually automate the weapon design process.

Regretfully, results are not guaranteed. Very few people can accurately predict the future, and I don't claim to be one of them. A lot of research and computer time went into these rules, but science marches to a strange drummer, and unexpected breakthroughs can make futuristic designs obsolete at any time. On the bright side, predictions can't be proven wrong until things actually happen otherwise, so any changes you make to the rules are right until science catches up with your imagination and proves you wrong (at which point we'll revise the rules). Have fun!

Last but not least, if you use **3G<sup>3</sup>** to design a weapon for any sort of *published* game, game scenario, magazine article, etc., give credit where credit is due. It lets me know that you're out there using it. Thanks!

## Basics

**3G<sup>3</sup>** makes the assumption that you are willing to do some work for your game to get realistic and consistent guns. This willingness may not necessarily be matched by a practical knowledge of ballistics, material science, terminology or a number of other pertinent factors. This section should help alleviate that problem. If you are already familiar with these terms, skip to the next section.

The terms on the following pages are used throughout the rules. If you have *any* questions while trying to design a weapon, are confused about what a term means, or are not sure where to look, please check either here or in the **index** (p.123). One of the two should provide some assistance.

## Destroy this book!

If you are going to use **3G<sup>3</sup>** on a regular basis, probably the best thing you can do is get a 3-ring binder. Then take **3G<sup>3</sup>** down to your local print shop, and tell them to cut off the binding (carefully!) and drill it for the ring binder. Then you can put index tabs in it, keep all your designs in one place, and even loan out sections in case friends want to design something from one section while you want to design from another. It would be *much* better though if they were to buy their own copy. It is also *not* nice to photocopy the entire rules for other people. BTRC tries to produce games at a price where you'd rather have an original for just slightly more than a photocopy. Be nice to us; buy our games.

## Weapon Design 101

Guns are generally designed for the purpose of killing living creatures, usually humans. The motives may be legal, illegal, moral or immoral, but dead is still dead. Guns are inherently dangerous and should be treated with great respect.

Weapons generally do damage by disruption of the target. This is usually by the application of energy. Conventional guns apply the kinetic energy of a moving projectile, and energy weapons cause the target to absorb some form of electromagnetic energy, such as a laser beam. Energy alone is not enough, however. The ability to penetrate armor is a matter of the area this energy is applied over. While you may not have realized this, it happens all the time in everyday life. While you can't stick your finger through a piece of wood, the same force concentrated into the point of a thumbtack lets you push it in up to the head. The same applies to the difference between a punch and a knife thrust. One is force applied over the area of a fist, and the other is concentrated into the tip of the blade.

As you will see later, the diameter of an attack makes a large difference in the damage that weapon does. The same energy will have a higher damage if placed behind a small bullet than a large one. An energy beam with double the diameter of a small one will have four times the area to distribute its energy over, so its ability to penetrate armor is lower than that of the small beam.



# Basic Terminology

## Tech Level

All weapons will have a Tech Level, or TL. Advanced designs may have more than one TL, but for most purposes all components on a weapon will be of the same TL.

TL is the single most important factor in any weapon design. TL's are based solely on physical, not cultural constraints, so make sure you have the background of this weapon firmly in mind before you start the design process.

Repeating cartridge firearms could have been made by the Romans in 100AD. The materials were sufficient, but the science was lacking. They had the *material science* technology to make gunpowder, mercury fulminate primers, lead bullets, bronze cartridge cases and bronze barrels. They did not have the *scientific knowledge* to create these materials and combine the various technologies in order to make them work, and they did not have any lucky accidental discoveries that would let them work these things out by chance. That had to wait another several centuries. Neon signs started appearing in 1905. Anyone who can make a neon sign can, with a little effort, make a helium-neon laser...or a CO<sub>2</sub> cutting laser. Again, the technology was there, but the knowledge of what a few simple modifications would do was not. Keep this in mind when you look at the rules and find you can make gunpowder weapons for the ancient Egyptians, or design lasers for WWI. They are possible, but not very efficient, and not very likely. The **3G<sup>3</sup>** Tech Levels are based on the following scale.

TL	Approx. date	Technology
1	Pre-history	Wood
2	10,000BC	Stone
3	3,000BC	Bronze
4	0AD	Iron, rockets
5	1400AD	Matchlock firearms
6	1700AD	Flintlock firearms
7	1800AD	Percussion firearms, airguns, steam power
8	1900AD	Cartridge firearms, HMG's, aircraft
9	1930AD	Submachine guns, atomic power, LMG's
10	1960AD	Light assault rifles, laser invented
11	1980AD	Autoburst weapons, microchips
12	2000AD	Caseless ammo, first railguns, fusion?
13	2100AD	Portable railguns, laser weapons, p-beams
14	2200AD	Advanced versions of above
15	2300AD	Peak of above technology
16+	?	Too advanced to predict

**Example** - You design a cartridge firearm at TL5 on *this* scale. If the system you play has 1400AD as TL3, this weapon would be TL3 in *that* system, but would still follow all **3G<sup>3</sup>** TL5 design rules.

The scale is not particularly regular, since it corresponds to the vagaries of Earth's history and technological progress. Other game worlds may vary. Note that TL's from 13 and up have dates which may not apply to a particular game universe. Specifically, the long intervals listed here apply to a particular timeline in which a catastrophe retarded all scientific progress for decades, beginning shortly after the start of TL12, with lingering effects caused by population decline and socioeconomic factors. Adjust the dates for any of all TL's to match the chronology of any other game system you convert your designs to.

## Damage Value

Or DV for short. This is a measure of the *penetrating* ability of a given attack. For attacks which may vary on an individual basis, each 10 points of DV represents 1d10 of damage. For attacks which are consistent (like firearms), the DV does average damage, or 5.5 points per 10 points of DV. For consistency's sake, all firearms will have the DV listed, but you should realize that the number of points of damage will be roughly half this number.

## Armor Value

Or AV for short. This is a measure of how well a material can stop attacks or resist being punctured, cut or broken. An item will stop damage up to its AV in points, the remainder going through and possibly damaging the item. As a measure of the AV scale, 10mm of the following substances will have the listed AV's:

Material	AV for 10mm	Density (water=1.0)
TL10 armor quality steel	40	7.7
TL10 mild steel	27	7.7
TL10 aluminum alloy armor	20	2.5
TL10 bulletproof glass	18	3.5
TL3 bronze	15	7.5
Cement or stone	3	2.2
Plexiglass	2	1.0
Oak or other heavy wood	2	.7

For rough comparison, historical TL10 rounds will penetrate the following amounts of these materials using **3G<sup>3</sup>** rules:

TL10 caliber	Armor steel (TL10)	Cement	Oak
.22LR	2mm	27mm	41mm
.32ACP	2mm	24mm	36mm
.380ACP	2mm	26mm	39mm
.38 Special	2mm	29mm	44mm
.45ACP	2mm	31mm	47mm
9mm	3mm	39mm	58mm
.357 Magnum	3mm	44mm	66mm
.41 Magnum	4mm	50mm	74mm
.44 Magnum	4mm	53mm	80mm
.30 Carbine	5mm	64mm	96mm
5.56mm	6mm	90mm	135mm
7.62mm	7mm	99mm	149mm
.460 Magnum	11mm	147mm	220mm
.50 cal	13mm	178mm	267mm
14.5mm	16mm	219mm	327mm
20mm	20mm	273mm	410mm

Special ammunition types may differ in penetration, and numbers for small calibers may vary due to the angle the target is struck with, tumbling or disintegration of the bullet within the material, and other situational modifiers. For instance, organic materials like wood get much of their "AV" due to resiliency, which applies much more to a low velocity attack than to a high velocity one. In most cases, supersonic projectiles (>330 meters per second) will be counted as armor-piercing vs. organic armors, and the penetration distances would therefore be double the listed amounts. Likewise, armor-piercing rounds would go through double or more the listed thickness of armor steel unless the steels were of a TL higher than the armor-piercing round.

## Action

The method by which the weapon feeds ammunition from a storage area to the part of the weapon it is fired from. These are described below, along with the abbreviation used in the rules and tables.

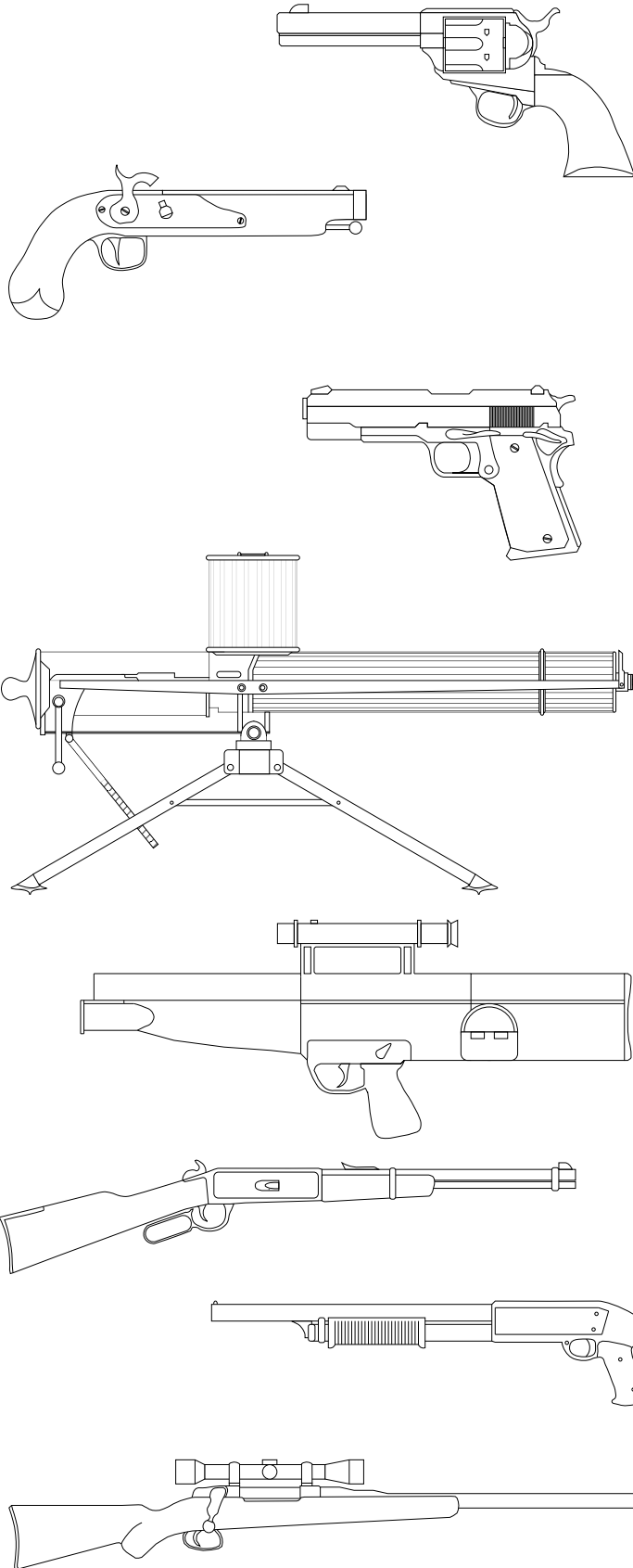

### Revolver (RV/n)

Rounds are contained in a cylindrical housing which serves as both a storage area, and firing chamber. Before firing, this cylinder is rotated to align with the barrel. Mass inefficiencies make this impractical for weapons with large ammunition capacity. The “/n” shows how many rounds the action holds, i.e. “RV/6” would mean a 6-shot revolver. Modern revolvers typically range from RV/9 for .22LR, to RV/5 or RV/6 for the .44 Magnum.

### Single shot (SS/n)

The weapon can only fire one shot for each barrel it has. Rounds must be manually inserted and removed after each shot is fired. The “/n” shows how many barrels the action has, i.e. “SS/2” means a double-barreled weapon.

### Semi-auto (SA/t)

The weapon has a magazine of some type, and each time the trigger is pulled, a single shot is fed from the magazine into the weapon and fired, or the round in the weapon is fired, and the empty chamber replenished from the magazine. The same concept applies to energy weapons, the main factor being one shot per pull of the trigger. The “/t” shows the type of magazine the weapon uses. These types apply to *all* weapons with magazines.

- /C** Clip fed. A detachable container which holds the ammunition or energy supply for the weapon. When empty, it can be removed and replaced.
- /I** Internal magazine. A supply for ammunition or energy that is an integral part of the weapon, and must be manually reloaded when empty.
- /E** External magazine. A supply for ammunition or energy which is wholly external to the weapon. When empty, it may be disconnected and replaced.

### Full-auto(AT/t)

The weapon has a magazine of some type, and when the trigger is pulled, rounds are cycled from the magazine to be fired as fast as the weapon is capable of moving them. These weapons may usually also act as semi-automatic weapons. The “/t” shows the type of magazine the weapon has.

### Auto-burst (AB/t)

The weapon has a magazine of some type, and when the trigger is pulled, rounds are cycled from the magazine to be fired as fast as the weapon is capable of moving them, up to a fixed total, usually 3 or 6, so each pull of the trigger fires a fixed number of rounds. These weapons may also act as semi-auto or full auto weapons. The “/t” shows the type of magazine the weapon has.

### Lever action (LA/t)

The weapon cycles rounds from a magazine of some type by means of manual cycling mechanism which does not require removing a hand from the weapon. This could be a lever that is operated by the firing hand (lever action), or a slide that is operated by the other hand (pump action). These weapons are almost always designed for two-handed use. The “/t” shows the type of magazine the weapon has.

### Bolt action (B/t)

The weapon cycles rounds from a magazine of some type by means of a manual cycling mechanism which requires the firing hand be removed from the trigger, such as a manually operated bolt (bolt action). The “/t” shows the type of magazine the weapon has.

# Basic Terminology

These actions can also have different ignition types, or means of igniting a powder charge on a conventional firearm. Unless otherwise specified, a conventional firearm is assumed to have an impact primer, where a sharp blow to the primer sets off a small charge of a sensitive propellant or explosive, and this in turn ignites the full powder charge.

- M** Matchlock. This is the historical ignition system for TL5 weapons. A slow burning fuse (or "match") is thrust into a touchhole when the weapon is fired. This ignites a small powder charge, which ignites the main propellant charge. The matchlock worked poorly in damp conditions, and extremely poorly in rain or snow. In addition, the match had to be lit before the weapon could be used, making constant readiness impossible.
- F** Flintlock. This is the historical ignition system for TL6 weapons. A spring-driven flint would strike sparks from a steel cover, and deflect them into a small powder charge that was opened when the cover was driven back by the force of the hammer. This small powder charge would ignite the main propellant charge. Flintlocks were more reliable than matchlocks, but a given flint would need to be replaced or adjusted after around 20 shots. They worked less well in damp or wet conditions, but could be kept ready longer.
- P** Percussion. This is the historical ignition system for TL7 weapons. Ignition was much the same as for modern weapons, except the impact sensitive primer had to be attached to the weapon separately, rather than as a combined unit, like modern rounds. Reliability was high, and if properly treated, they worked well in all weather conditions. Usually only found on revolver and single shot weapons.
- E** Electric. This ignition system may be used historically at TL10 and above. Rounds are like conventional weapon rounds, but the priming charge is ignited by electrical resistance rather than impact.

These are suffixes that are added after any other weapon formatting information. Some samples are below.

Notation	Description
SS/1-M	Single shot matchlock
SS/2-F	Double-barrel flintlock
RV/5-P	Five-shot percussion revolver
AT/E-E	Externally fed autoweapon, electric ignition

## Other Terms

Aside from the previous game terms, there are some scientific and/or technical terms that are used throughout 3G<sup>3</sup>. If you come across an unfamiliar term, refer back to this section to see what it means.

### Accessories

These are items that are added to a weapon to make it easier to operate, but are not *strictly* required in order for the weapon to function. Accessories include sights, grips, handguards, stock, or attachment points for sighting aids like a telescopic sight, or auxiliary weapons like a bayonet or grenade launcher.

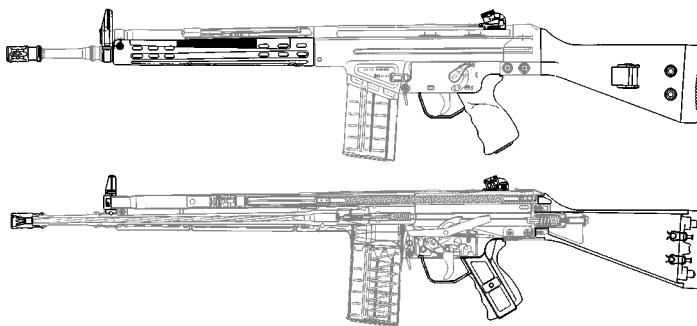

### APFSDS

**A**rmor **P**iercing **F**in **S**tabilized **D**iscarding **S**abot. The tank equivalent of a flechette, very accurate out to long ranges. The term APFSDS incorporates most of the abbreviations used for this class of projectile. For instance, APDS means **A**rmor **P**iercing **D**iscarding **S**abot. In game terms, armor piercing ammunition will reduce the protection afforded by armor, either by increasing the effective damage of the projectile, or decreasing the effective value of the armor.

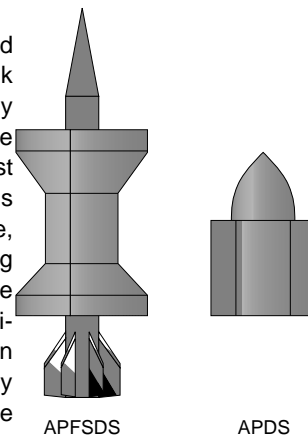

### Barrel

The part of a conventional firearm that guides the bullet and contains the expanding combustion gases from the propellant. The term in general applies to laser tubes, particle accelerators or magnetic launch rails as well.

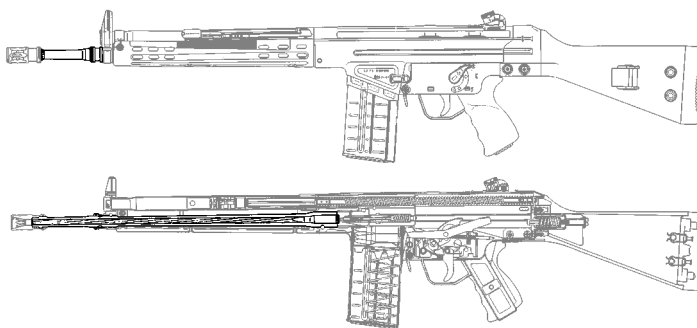

**Battery**

Any storage device (usually chemical) that can provide constant amounts of relatively low-power electrical current, usually too small to meet the high pulse demands of an energy weapon. Most electrical generators will have similar characteristics. In **3G<sup>3</sup>** terms, a battery can also represent any other means of storing energy so that it can be continually released, like coiled up springs.

**Bore**

The inside diameter of the barrel of a projectile weapon. May also be used to signify beam diameter in an energy weapon.

**Bullpup**

A name for a style of longarm where much of the machinery is placed within the usually solid parts of the stock next to the shoulder. This saves substantially on weapon length. While possible for almost any weapon, it only recently began to see use (TL11+). In general, a bullpup design is not recommended for any weapon which can have a critical malfunction in the parts right next to the firer's head.

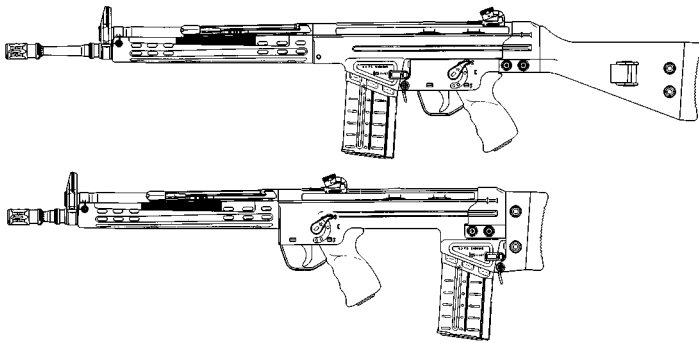
**Capacitor**

A medium-tech (TL8-12) device for storing electrical power for delivery as short, intense pulses. In game terms, it may also represent other technologies with similar discharge characteristics, such as homopolar generators.

**Casing**

Any item which is used to provide a convenient means of simultaneously handling propellant and projectile. Ammunition which is encased in solidified propellant, or which has a thin, combustible casing will generally be referred to as caseless.

**Centimeter**

Or cm. A metric unit of length, used throughout **3G<sup>3</sup>**.

An inch is 2.54cm, a foot is 30.5cm, and 100cm equals 1 meter or 39.37 inches.

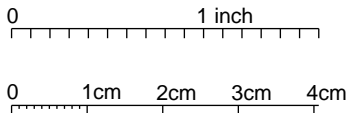
**CLGP**

**Cannon Launched Guided Projectile.** A projectile fired from a gun or cannon, which after firing is guided to the target either by a homing warhead or guidance from the firing vehicle. This gives extra versatility to existing weapons.

**Coil gun**

A means of magnetically accelerating an iron or other ferrous projectile, by alternately pushing and pulling it with electromagnetic coils surrounding the barrel of the weapon.

**Conventional weapon**

Refers to the current level of firearms technology (i.e. gunpowder or chemically propelled projectiles).

**Cubic Centimeter**

Or cc. A volume of 1cm x 1cm x 1cm. One cc of water (sg1) has a mass of 1 gram (about 1/28th of an ounce).

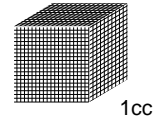
**DU**

**Depleted Uranium.** Uranium is an extremely dense element, and can be made into armor-piercing projectiles. These are made of uranium whose radioactive potential has been tapped, such as from spent reactor cores. The DU term is usually tacked onto the end of some other abbreviation. For instance, an APDU would be an **Armor Piercing Depleted Uranium** projectile.

**Flechette**

A long, narrow finned projectile, usually described as a high-tech substitute for lead or steel shot for shotguns, since it causes wounds just as bad, and retains its damage producing ability out to a greater range. The disadvantage is that it is significantly more expensive to manufacture.

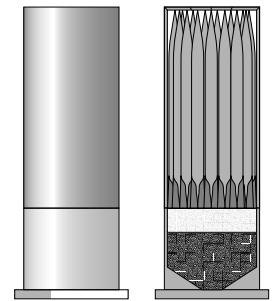
**Fragmentation**

A type of explosive shell designed to produce large numbers of high-velocity fragments, generally as an anti-personnel weapon. It will also have regular explosive effect.

**Gram**

Or g. A metric unit of mass used in **3G<sup>3</sup>**. An ounce is about 28.5 grams, and a normal sheet of paper has a mass of about 5 grams. One kilogram is 1,000 grams, or about 2.2 pounds.

**HE**

**High Explosive.** A shell with the primary purpose of delivering explosive to a target.

**HEAT**

**High Explosive Anti-Tank.** A general term for any shaped charge warhead or shell. May also be known as **High Explosive Armor Piercing (HEAP)**.

**HEDP**

**High Explosive Dual Purpose.** Rounds that are a compromise between a full high explosive payload and a dedicated fragmentation payload.

**Inherent Accuracy**

Or IA. This game stat represents how well the weapon "points", and how repeatably accurate it is capable of being at a given range. The larger the IA, the better.

**Initiative**

This game stat represents how unwieldy the weapon is. Weapons with a positive Initiative are easier to bring into play, can change targets faster and maneuver in tight places better than those with a negative Initiative.



# Basic Terminology

## Joule

Or J. A unit of energy used in **3G<sup>3</sup>**, equal to 1 watt/second. Projectiles and energy weapon beams will have an energy in Joules, which is used to find the DV.

## Kilogram

Or kg. One thousand grams (1,000g), or about 2.2 pounds. A gallon of water has a mass of about 3.6 kilograms.

## Laser

Light **A**mplification by **S**timulated **E**mission of **R**adiation. A coherent beam of light, which at high power levels can burn through virtually any material. Historically invented in late TL9/early TL10. Lasers can be tuned to emit over a large portion of the electromagnetic spectrum, from infrared, visible light, through ultraviolet and even x-rays. Most lasers in **3G<sup>3</sup>** will be a specific frequency in the infrared-visible-ultraviolet range.

## Longarm

A weapon designed to be fired with both hands, like a rifle or shotgun. Virtually any weapon which is not a pistol will be classified as a longarm.

## l/w

Short for length/width ratio, a measure of how long a projectile is compared to its diameter. A bullet 5mm in diameter with a 3:1 l/w would be 15mm long.

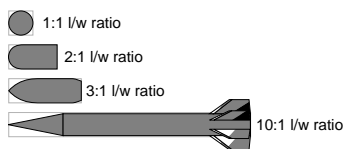

## Magazine

One of several terms for where ammunition for a weapon is stored. Magazines can be clips (see below), feed belts, hoppers, the cylinder of a revolver or the under-barrel tubes commonly used on pump and lever-action weapons.

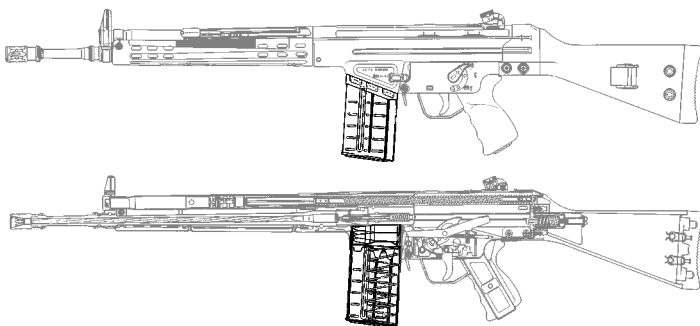

## Maser

**M**icrowave **A**mplification by **S**timulated **E**mission of **R**adiation. A coherent beam of microwave radiation, used in some game systems as a weapon, mainly against organic materials. Historically invented in late TL9/early TL10.

## Meter

One hundred centimeters (100cm), or about 39.37 inches. This book is .22m wide by .27m tall.

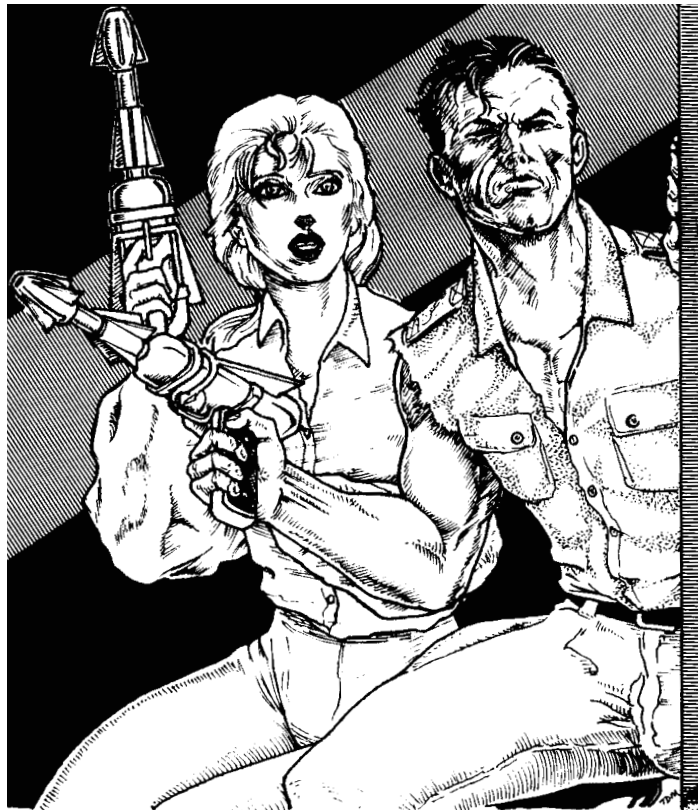

## Muzzle energy

The energy a projectile has after any mechanical losses the propellant takes from the inefficiency of the weapon design. A weapon may be considered to have a base energy, which is how much the power source of the weapon generates, but muzzle energy is how much a projectile or beam has the instant it leaves the muzzle of the weapon, hence the term.

## Particle beam

A weapon which accelerates subatomic particles to relativistic velocities. Extremely energy intensive, but has the benefit of being able to disrupt electronics and produce secondary radiation effects. Rules for particle beams may also be used to model “blasters” or “plasma guns”.

## Projectile

The item fired out of a weapon by the propellant, magnetic energy or other propulsive force.

## Propellant

A chemical compound which provides gas pressure to expel the projectile from the weapon. May also apply to compressed air for air-powered weapons. For conventional weapons of TL8 or lower, the propellant is usually black powder, a mixture of potassium nitrate, sulfur and charcoal. From late TL8 through TL12, propellant will probably be based on nitrocellulose compounds or other derivatives of high explosive compounds.

## Railgun

A means of magnetically accelerating an iron or other ferrous projectile, by using an extremely high current pulse to generate a magnetic field in an ionized region directly behind the projectile. The projectile is pushed by this field as it travels the length of the weapon.

**RAKE**

**Rocket Assisted Kinetic Energy.** A type of round developed in late TL11. In current, experimental form, it is an APDS or APFSDS round with a rocket booster on the back as a separate unit. The advantages are a higher terminal velocity and DV, and a flatter trajectory.

**Range Class**

Or RC. A number that condenses the aiming or ballistic characteristics of a weapon into a row on a table for easy reference. In general, the higher the RC, the more accurate the weapon.

**Receiver**

The part of a weapon which feeds in new ammunition and ejects spent casings. It also includes any needed mechanical linkages, power conditioning circuits or similar apparatus on energy weapons.

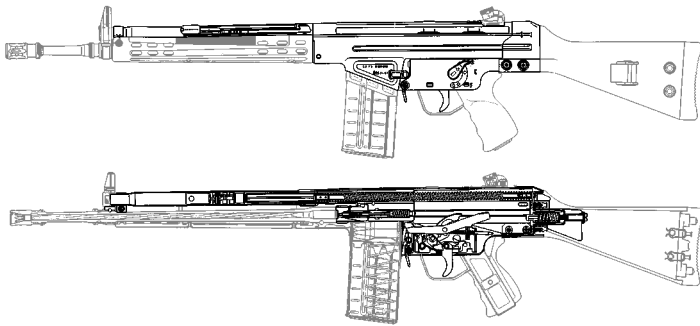
**ROF**

**Rate of Fire.** How many times a weapon can fire in a given time increment. In game terms this is usually in rounds per combat turn, and in technical literature, usually in rounds per minute.

**Round**

A complete unit of ammunition for a conventional firearm, consisting of propellant, projectile and casing.

**Sabot**

The outer part of a multiple-part projectile, designed so that the outer part separates after leaving the barrel, and the inner part continues towards the target. The main purpose of this is to provide an easy means of propelling a projectile which alone would be very difficult to design a weapon for, such as a finned dart.

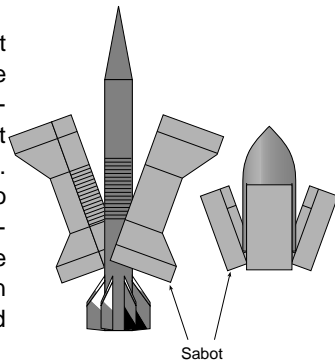
**SAM**

**Surface to Air Missile.** A ground launched missile that engages airborne targets.

**Shaped charge**

An explosive charge designed expressly for penetrating armor. Also see HEAT. Historically, shaped charges are a TL9 development, but can be developed at any TL with high explosives (late TL7 or better). Low explosives like black powder do not generate the shaped charge effect.

**Shell**

The propellant container on a conventional weapon, usually designed for convenient handling and easy loading. On archaic (less than TL9) weapons, the term is more commonly used to designate exploding projectiles (shot are solid projectiles, while shell are exploding projectiles).

**SLAP**

**Saboted Light Armor Penetrator.** Usually refers to an APDS round for a shoulder-fired weapon or light machine gun, which uses a small armor piercing projectile to get more energy over a smaller area.

**SMG**

**Submachine gun.** Usually a weapon firing a bullet originally designed for pistols, but which can fire them autofire, and which is usually capable of being fired from the shoulder. An SMG will usually have slightly better damage and long range accuracy than a pistol firing the same ammunition.

**Storage bank**

Any storage device (usually electrical), which can provide high power pulses of short duration, usually to power an energy weapon. Storage banks are usually charged by batteries. Also see Capacitor.

**(u),(d),(n)**

Round up, round down, and round nearest. All numbers in **3G<sup>3</sup>** are rounded to the three highest digits, so 1.239kg would be treated as 1.24kg, but 11.239kg would be 11.2kg.

**y<sup>x</sup>**

The number y, raised to the x power. An x of 2 means the number squared, while an x of .5 means the square root of y. Usually accessed by the y<sup>x</sup> key on most scientific calculators.

# Conventional Weapons

## Pushing the limits

A weapon may be designed at the next highest TL under certain conditions, like making prototype TL12 weapons during TL11, for instance. The first condition is that you are at least halfway through the current TL. Once you are at this point, the technological advances of the next TL are in an experimental stage. If produced in a reasonable quantity, the weapon will also have a x4.0 cost multiple, after everything else is taken into account. If produced as only a few prototypes, the research and labor involved for the weapons will make the cost phenomenal, at least 100 times the normal rate, not counting the research equipment and facilities used in the process.

Some GM's may have a single technological advance in their worlds, but not others. In such a case, the weapon is of normal cost, but one part of the weapon may use the advances of a higher TL. For instance, a structural material of higher TL than powder technology, or more advanced electronics and less advanced powder, or more advanced rockets and less advanced guns. These must be handled on a case-by-case basis, but would be more likely when characters cross between cultures with a great separation between them that hinders the flow of knowledge, or where natural resources tend to favor one weapon type over another.

## Chemically Propelled Projectile Weapons

Or as they are usually known, guns. This category covers almost every firearm, rocket or other powered weapon made up to the year 2000, and as such is the longest and most detailed section of the rules. Like all the design sections, it begins with a Tech Level reference for that weapon type.

TL1-2 (circa 10,000BC)	<b>Technical notes</b>	<b>3G<sup>3</sup></b> is a formula-based system, and while it is possible to design weapons at TL1-2, they aren't worth the effort.
	<b>Historical notes</b>	Not historically possible at this TL.
TL3 (circa 3,000BC)	<b>Technical notes</b>	The first remotely practical firearms can be made at this TL. In order to get a high velocity from projectiles, it is suggested you use wood (sg1) as the projectile material. This is allowed only for subsonic projectiles.
	<b>Historical notes</b>	Not historically possible at this TL.
TL4 (circa 0AD)	<b>Technical notes</b>	Bulky, heavy, but quite deadly repeating firearms can be made with the technology at TL4. This is "Roman Empire" technology, and is the first point where guns can be designed that successfully challenge projectile throwers like slings, bows and crossbows. For a DV of 20, the lightest way to get a 1 shot weapon is a 8mm SS/1, and for multiple shots, it is a 10mm LA/I.
	<b>Historical notes</b>	Not historically possible at this TL.
TL5 (circa 1,400AD)	<b>Technical notes</b>	The level of craftsmanship in parts of the world at this time is sufficient to make any variety of conventional firearms, although they will be bulky and heavy compared to modern counterparts. For DV20, the lightest way to get a 1 shot weapon is a 7mm SS/1, and for multiple shots, it is a 9mm LA/I.
	<b>Historical notes</b>	Give or take a few decades, this is where the first historical firearms appear. The only firearms possible at TL5 are single shot or multiple barrel firearms, using a matchlock ignition system (SS/n-M actions). Rifled barrels are not used, and all projectiles must have a 1:1 l/w ratio.
TL6 (circa 1700AD)	<b>Technical notes</b>	Cased ammunition reaches half of what can be packed into a loose powder weapon, but loose powder, single shot weapons are still the best for getting maximum hitting power and range. For DV20, the lightest way to get a 1 shot weapon is a 6mm SS/1, and for multiple shots, it is a 8mm LA/I.
	<b>Historical notes</b>	Flintlock and wheellock ignition systems are TL6 inventions, as are revolver actions. The possible new actions are SS/n-M, SS/n-F, RV/n-M and RV/n-F. Rifled barrels are still not available, and projectiles must still use a 1:1 l/w ratio. Explosive rounds are available, but are only allowed time delay fuses.
TL7 (circa 1800AD)	<b>Technical notes</b>	By spending <i>lots</i> of money compared to other period weapons, you could have something made which would be nearly equal to a normal TL11 weapon. For DV20, the lightest way to get a 1 shot weapon is a 6mm SS/1, and for multiple shots, it is a 8mm LA/I.
	<b>Historical notes</b>	Percussion caps become available at TL7, as do rifled barrels and 2:1 and 3:1 l/w ratio projectiles. Compressed air weapons are developed at TL7, and experimental cartridge weapons are available in the latter half of TL7. Semi-auto (SA), automatic (AT), pump (LA), lever (LA) and bolt (B) action weapons are all introduced by the end of TL7, and may be in production before TL8. Magazine-fed multiple barrel weapons (i.e. Gatling guns) show up in the latter half of TL7. Explosive and hollow-point rounds are available.
TL8 (circa 1900AD)	<b>Technical notes</b>	Gatling weapons at this TL may be electrically powered, where before they would have had to require some mechanical means of operation, like a hand crank or spring-wound mechanism.
	<b>Historical notes</b>	All actions except autoburst (AB) are allowed, and in limited use at the start of TL8. Automatic actions (AT) are still limited to rifle-sized weapons and/or calibers. All new weapons use self-contained cartridges. Many calibers will become standards, and used up through TL12 with some modification, mainly an increase in DV. Black powder is replaced by more advanced nitrocellulose-based propellants. Rifling is standard on all new weapons except shotguns. Projectile l/w ratio is still limited to 3:1. Incendiary and tracer rounds are available in limited quantities, for autofire weapons.

<b>Technical notes</b>	Most weapons developed between WWI and WWII are TL9. Lightweight weapons may have aluminum instead of steel in lightly stressed areas.	TL9 (circa 1930AD)
<b>Historical notes</b>	Submachine guns and machine pistols become historically available, as do subcaliber rounds and shaped charge warheads. TL9 is the first TL in which armor-piercing tungsten (sg11) projectiles may be used, all previous armor-piercing projectiles being of steel (sg7).	
<b>Technical notes</b>	This is the first TL in which semi-automatic (SA), automatic (AT) and auto-burst (AB) weapons have the same action efficiency as bolt (B), lever (LA) and single shot (SS) weapons. So, the types of weapons that can take full advantage of the propellant energy are doubled.	TL10 (circa 1960AD)
<b>Historical notes</b>	Aluminum alloy sees use as a structural material for guns, although steel is still used for barrels. The first caseless ammo is produced at TL10. Projectiles with a l/w ratio of 10:1 are first used in tank cannon (APFSDS rounds). "Bullpup" style weapons are first designed at TL10. Weapons that use electrical pulses to ignite the propellant charge appear at TL10.	
<b>Technical notes</b>	Most modern weapons are TL11, though more and more push the TL12 boundary. Computer aided design and manufacturing means that custom designs can be produced in smaller lots, giving specialty manufacturers the ability to reach a wider market than with earlier, hand-tooled designs.	TL11 (circa 1980AD)
<b>Historical notes</b>	The first autoburst weapons are produced at TL11, as are laser sights. Caseless ammunition improves to the point of being feasible by the end of this period (H&K 4.9mm). Plastic begins to see use as a structural material, and by the end of TL11, has replaced all but the mostly highly stressed parts on many weapons. The first discarding sabot rounds for civilian rifles appear on the market (.308 Winchester "Accelerators"), and discarding sabot rounds for military use are made in 5.56mm, 7.62mm and 12.7mm. Civilian rounds have lead cores for hunting purposes, while military versions have tungsten or depleted uranium (sg11) for armor-piercing effect.	
<b>Technical notes</b>	Caseless ammunition becomes eminently practical, weight and space savings allowing a soldier or weapon to carry a larger load.	TL12 (circa 2000AD)
<b>Historical notes</b>	The first caseless civilian rifles will probably appear in early TL12. Many hunters prefer custom loading their bullets, and cased technology will continue to be popular, both in lower-tech nations, and in civilian calibers.	
<b>Technical notes</b>	This is the TL in which revolver (RV) actions reach 100% efficiency converting propellant energy into projectile energy (at least for design purposes).	TL13 (circa 2100AD)
<b>Historical notes</b>	Caseless ammunition technology will become more prevalent in civilian designs, in areas which still allow possession of such weapons by those outside the police or military. In repressive areas, they may be especially prevalent, as the difficulty of manufacturing ammunition is greater, reducing the usefulness of any stolen weapons.	
<b>Technical notes</b>	Weapons have more or less reached the peak of this type of technology, and will simply continue to get lighter and more powerful as the limits of chemistry and material science technology are pushed back. The main limit is now the recoil force the soldier can endure when firing a weapon.	TL14 (circa 2200AD)
<b>Historical notes</b>	Military rifles can now pack the punch of TL11 heavy machine guns, and exotic ammunition is routinely used to counter new armor technologies. Conventional weapons begin to fall out of favor as the benefits of railguns and lasers begin to outweigh their disadvantages. In interstellar societies, large numbers of TL13 designs will be sold to less advanced worlds as surplus, thus profiting from stockpiles that would otherwise be scrapped.	
<b>Technical notes</b>	Weapons have more or less reached the peak of this type of technology, and will simply continue to get lighter and more powerful as the limits of chemistry and material science technology are pushed back.	TL15 (circa 2300AD)
<b>Historical notes</b>	While there are still uses for conventional weapons, these are growing fewer and fewer, and most applications of the technology are in the fields of security or law enforcement, or hunting weapons. The material and costs of programming a robot to make a precise mechanical action for a gun may actually be greater than that for a railgun or equivalent energy weapon.	

### Compatibility issues

Just because two weapons share a common caliber and energy does not mean they use the same ammunition. Unless expressly designed that way, assume that all weapon ammunition is *incompatible* with that for any other weapon. Naturally, most of the time families of weapons are designed to use the same ammunition, to increase the potential market for the weapon, hence common calibers like 5.56mm NATO, 7.62mm NATO, 9mm Para, .45ACP, .22 rimfire and countless others. This is as much a political issue as a technical one.

### Rifled vs. smoothbore

Most handheld weapons use rifling, or shallow spiraling grooves down the barrel to impart spin on the projectile. This improves the accuracy of the weapon. For various reasons however, weapons may have smooth instead of rifled bores. The main reason is historical. Historical weapons before TL7 rarely had rifling, for the simple reason that no one had any idea what it was or why it was useful. The modern reason is that projectiles with a l/w ratio of 10:1 or more tend to be less stable at the high rotational velocities imparted by rifling, and are more stable if they are simply stabilized by fins.

As a rough guide, the maximum aiming RC of any *handheld* weapon will be the TL, divided by 2. This rounds up for rifled weapons, and rounds down for smoothbore weapons. For instance, a TL7 rifle could theoretically reach a maximum aiming RC of 4, while a smoothbore could only reach an aiming RC of 3. Pre-TL8 mounted weapons have a maximum aiming RC of their TL.

For use as an emerging technology, rifled weapons will have a x2.0 cost multiple when first introduced.

### Minimum bore

A suggested optional rule is to say that loose powder rounds have a minimum bore of (12-TL)mm, cased rounds have a minimum bore of (14-TL)mm, and caseless rounds have a minimum bore of (16-TL)mm. Weapons below this increase one level in unreliability per TL the weapon fails this minimum by.

This represents problems like powder fouling and the lesser mechanical precision available at lower TL's.

# Conventional Weapons

## Basics

The very first thing you need to do is get a sheet of paper, a pencil, and a scientific calculator with  $x^2$ ,  $\sqrt{x}$ , and  $y^x$  keys. You can actually design a number of weapons without the calculator, but you will only be able to look things up on the provided tables rather than tweaking designs to your heart's content.

The next thing you need to do is figure out the Damage Value of your weapon. To do this, you need the TL, propellant energy, action type and diameter of the projectile. It is *extremely* important to remember the difference between *propellant* energy and *muzzle* energy. One is the raw energy of the propellant, and the other is the amount actually imparted to the projectile. The difference can be significant, so when the term energy is used, note which kind is mentioned. You can calculate Damage Value by using the following formula:

$$DV = (\text{Muzzle energy} \times .735 / \text{Projectile diam. in cm})^5 (n)$$

Or use the table below to cross-reference your bullet size and desired DV to get the muzzle energy required.

**Example** - You want a 6mm weapon with a DV of 25. This will require a *muzzle energy* of 510J.

The propellant energy is based on the TL and quantity of propellant. The "base" gunpowder energy is 4,500 Joules per gram, which is multiplied by the efficiency of the powder's TL.

$$\text{Base "gunpowder energy"} = 4,500\text{J per gram}$$

Save the base propellant energy. Multiply the propellant energy by the efficiency of the action used to get the base muzzle energy of the projectile (Hint: propellant energy is TL x 135J).

$$\text{Base muzzle energy} = \text{Prop. energy at that TL} \times \text{action efficiency}$$

Note that a round with a given propellant energy may have different DV's when fired from different weapons. The *base* energy may be the same, but *muzzle* energy may vary between weapons, and damage is based on muzzle energy.

TL	Propellant efficiency	Joules	B/SS/LA*	Action efficiency SA/AT/AB	RV*
1	.03	135J	.12	-	.08
2	.06	270J	.24	-	.16
3	.09	405J	.36	-	.24
4	.12	540J	.48	.40	.32
5	.15	675J	.60	.50	.40
6	.18	810J	.72	.60	.48
7	.21	945J	.84	.70	.56
8	.24	1080J	.96	.80	.64
9	.27	1215J	1.00	.90	.72
10	.30	1350J	1.00	1.00	.80
11	.33	1485J	1.00	1.00	.88
12	.36	1620J	1.00	1.00	.96
13	.39	1755J	1.00	1.00	1.00
14	.42	1890J	1.00	1.00	1.00
15	.45	2025J	1.00	1.00	1.00

\*Only single shot or revolver actions are allowed below TL4

**Example** - A 1cm TL9 round with a propellant energy of 1,000J will have a muzzle energy of 1,000J when fired from a single-shot weapon (SS), for a DV of 27. If fired from a semi-auto weapon with an efficiency of .9, the muzzle energy is 900J, for a DV of 26. The base propellant energy is 1,000J in *either* case.

**Note** - You can use the two tables on this page to get the muzzle energy *and* base energy for a variety of weapons. Divide the energy from the table below by the action efficiency on the table above to get the base energy required from the propellant.

**Example** - If you want a TL6 10mm revolver to have a DV of 15, it will need a muzzle energy of 306J. To get this muzzle energy requires a base energy of  $306\text{J} / .48 = 638\text{J}$ .

DV	Caliber														
	4mm	5mm	5.5mm	6mm	7mm	8mm	9mm	10mm	12.5mm	14.5mm	20mm	23mm	25mm	30mm	
8	35J	44J	48J	52J	61J	70J	78J	87J	109J	126J	174J	200J	218J	261J	
10	54J	68J	75J	82J	95J	109J	122J	136J	170J	197J	272J	313J	340J	408J	
12 (lt.pistol)	78J	98J	108J	118J	137J	157J	176J	196J	245J	284J	392J	451J	490J	588J	
15	122J	153J	168J	184J	214J	245J	276J	306J	383J	444J	612J	704J	765J	918J	
20 (med.pistol)	218J	272J	299J	327J	381J	435J	490J	544J	680J	789J	1090J	1250J	1360J	1630J	
25	340J	425J	468J	510J	595J	680J	765J	850J	1060J	1230J	1700J	1960J	2130J	2550J	
30 (hvy.pistol)	490J	612J	673J	735J	857J	980J	1100J	1220J	1530J	1780J	2450J	2820J	3060J	3670J	
35	667J	833J	917J	1000J	1170J	1330J	1500J	1670J	2080J	2420J	3330J	3830J	4170J	5000J	
40 (ft.rifle)	871J	1090J	1200J	1310J	1520J	1740J	1960J	2180J	2720J	3160J	4350J	5010J	5440J	6530J	
45	1100J	1380J	1520J	1650J	1930J	2200J	2480J	2760J	3440J	4000J	5510J	6340J	6890J	8270J	
50 (med.rifle)	1360J	1700J	1870J	2040J	2380J	2720J	3060J	3400J	4250J	4930J	6800J	7820J	8500J	10.2kJ	
60	1960J	2450J	2690J	2940J	3430J	3920J	4410J	4900J	6120J	7100J	9800J	11.3kJ	12.2kJ	14.7kJ	
70 (hvy.rifle)	2670J	3330J	3670J	4000J	4670J	5330J	6000J	6670J	8330J	9670J	13.3kJ	15.3kJ	16.7kJ	20.0kJ	
80	3480J	4350J	4790J	5220J	6100J	6970J	7840J	8710J	10.9kJ	12.6kJ	17.4kJ	20.0kJ	21.8kJ	26.1kJ	
90	4410J	5510J	6060J	6610J	7710J	8820J	9920J	11.0kJ	13.8kJ	16.0kJ	22.0kJ	25.3kJ	27.6kJ	33.0kJ	
100 (.50 cal)	5440J	6800J	7480J	8160J	9520J	10.9kJ	12.2kJ	13.6kJ	17.0kJ	19.7kJ	27.2kJ	31.3kJ	34.0kJ	40.8kJ	
120	7840J	9800J	10.8kJ	11.8kJ	13.7kJ	15.7kJ	17.6kJ	19.6kJ	24.5kJ	28.4kJ	39.2kJ	45.1kJ	49.0kJ	58.8kJ	
140	10.7kJ	13.3kJ	14.7kJ	16.0kJ	18.7kJ	21.3kJ	24.0kJ	26.7kJ	33.3kJ	38.7kJ	53.3kJ	61.3kJ	66.7kJ	80.0kJ	
160 (20mm)	13.9kJ	17.4kJ	19.2kJ	20.9kJ	24.4kJ	27.9kJ	31.3kJ	34.8kJ	43.5kJ	50.5kJ	69.7kJ	80.0kJ	87.1kJ	104kJ	
180	17633J	22.0kJ	24.2kJ	26.4kJ	30.9kJ	35.3kJ	39.7kJ	44.1kJ	55.1kJ	63.9kJ	88.2kJ	101kJ	110kJ	132kJ	
200	21.8kJ	27.2kJ	29.9kJ	32.7kJ	38.1kJ	43.5kJ	49.0kJ	54.4kJ	68.0kJ	78.9kJ	109kJ	125kJ	136kJ	163kJ	
250	34.0kJ	42.5kJ	46.8kJ	51.0kJ	59.5kJ	68.0kJ	76.5kJ	85.0kJ	106kJ	123kJ	170kJ	196kJ	213kJ	255kJ	
300	49.0kJ	61.2kJ	67.3kJ	73.5kJ	85.7kJ	98.0kJ	110kJ	122kJ	153kJ	178kJ	245kJ	282kJ	306kJ	367kJ	





**Projectiles**

The size, shape and material your projectile is made from will have a great effect on its performance. The diameter has already been chosen, and used for figuring the DV. Next, you have to decide on the **length/width** ratio (l/w), and density or **specific gravity** (sg). The l/w ratios available are spherical (l/w 1:1), length of twice the width (l/w 2:1), length of three times the width (l/w 3:1), and length of ten times the width (l/w 10:1).

Historically, most weapons at or below TL6 use round projectiles (those with an l/w of 1:1). Modern pistols usually use l/w 2:1 projectiles, and rifles use l/w 3:1 projectiles. Penetrators on discarding sabot rounds, and missiles usually use a l/w of 10:1 or more. Discarding sabot rounds for small arms are usually 3:1.

The sg of a projectile is its density. Water and propellants have an sg of 1. Aluminum has an sg of about 3, iron, steel and other iron alloys have an sg of about 7-8, and depleted uranium and lead have an sg of about 11.

Historically, low tech rounds are usually made of lead, which is sg11. Depleted uranium armor-piercing rounds are also sg11, but only available at TL's with atomic power (usually TL10+). Iron or steel armor-piercing rounds are counted as sg7, and HE rounds, aluminum projectiles, and sabot sheaths are usually sg3 (but counted as sg1 for design purposes since they have a lot of empty space). Gunpowder is sg1, so the mass is the same as the volume.



**In a nutshell** - A given powder energy will propel a light projectile faster than a heavy one, giving it better aiming characteristics. However, low density projectiles lose their velocity faster, meaning their damage at range drops more than it would for high density projectiles. Projectiles with a high l/w ratio have more mass per cross-sectional area, and retain their velocity better, but are heavier and slower than low l/w ratio projectiles, and this lower velocity may degrade their aiming characteristics. Everything will be a compromise, as you will discover through experimentation.

**Limits** - No projectiles may have diameters of less than 2mm. No lead projectile may have an l/w ratio of 10:1. No projectile with an l/w of 10:1 or may be fired from a conventional weapon without a sabot or as a cluster of projectiles (flechette round).



**Powder handling**

There are three ways to get propellant in and a bullet out of a weapon. A cartridge weapon has a casing with a bullet crimped on one end, an impact or electrically ignited primer on the other, and the space between filled with propellant. A cartridge-firing weapon can only have a casing (shell) of a limited size compared to the projectile it fires. If it is too large, it becomes too unwieldy to fit through the action, too fragile to stand up to rough use, or both. It can also have more propellant than can exit down the barrel fast enough to keep from blowing up the weapon. This depends on the TL.

Weapons using loose powder have a higher capacity, but also have a practical maximum of the amount that will fit in the weapon, or reliably ignite. These weapons load the propellant, projectile and igniter separately. An archaic flintlock is an example of this, as is a modern 16 inch naval gun.

Future weapons may use caseless ammunition, where the propellant is a solid block, with the projectile embedded inside. This eliminates the mass of the casing, making the round smaller and lighter. These also have a size limit based on the limits of the technology and the lower structural strength of the solidified powder.

In all cases, the maximum allowable propellant will be based on the volume of the projectile or projectiles fired. The table below gives the maximum propellant volume/projectile volume ratio that is allowed at a given TL. Note that rounds close to the upper limit will be less reliable than those using only a fraction of the maximum.

TL	Loose Powder	Cased Ammo	Caseless Ammo	TL	Casing as mult. of propellant mass
1	2	-	-	1	-
2	4	-	-	2	-
3	6	-	-	3	-
4	8	2	-	4	8.3
5	10	4	-	5	6.3
6	12	6	-	6	5.6
7	14	8	-	7	4.8
8	16	10	-	8	4.2
9	18	12	-	9	3.7
10	20	14	2	10	3.3
11	22	16	4	11	3.0
12	24	18	6	12	2.8
13	26	20	8	13	2.6
14	28	22	10	14	2.4
15	30	24	12	15	2.2

**Example** - A projectile 5mm in diameter with a 2:1 l/w ratio will have a volume of .164cc (from the table on the next page). At TL13, a caseless ammunition round can have a maximum ratio of propellant volume/projectile volume of 8 to 1, or a maximum of .164cc x 8 = 1.31cc of propellant. Since powder has an sg of 1, this is 1.31g of propellant. If this were a more traditional cased round, the casing would have a mass of 1.31g x 2.6 = 3.41g (if the full 1.31g of propellant capacity were used). This round would be very unreliable, as it uses the absolute maximum propellant allowed (see **Malfunctions**, p.19).

# Conventional Weapons

At this point, you need to go back and see if your original powder volume used to get the DV of the weapon is less than the theoretical maximum for that TL. If so, the weapon may be practical. If not, try again, or change your design strategy. For instance, you might try cased ammo if you exceeded the limits of caseless technology.

**Important note** - A modifier on round cost is if the casing (if any) is disposable (i.e. non-reloadable). A current example is the .22 rimfire round. Once fired, the brass casing cannot be refurbished, and is discarded. These are less expensive, *and* the casing has half the usual mass. Rocket rounds usually do not have casings, and cannot use this modifier. If you plan on extensive use of non-reloadable ammo, make sure you calculate the mass of this type of round separately, as either in a large clip or with large rounds, the weight difference can add up fairly quickly.

This table gives all the mass and volume data for most of the projectiles you will use. For ones not on the chart, you can get the stats by finding one that is on the chart, and cubing the ratio of difference.

**Example** - If you wanted the mass for a 6.3mm 3:1 sg11 projectile, you would multiply the 6mm stats by  $(6.3/6)^3$ . For very large projectiles, multiplying the diameter of a listed projectile by 10 will multiply the volume by 1,000.

**Example** - A spherical (1:1) projectile 10mm in diameter would have a volume of .524cc. If it was made of lead (count as sg11), it would have a mass of 5.76g. If it were made of iron (count as sg7), it would have a mass of 3.67g. A 100mm projectile of the same type would have a volume of 524cc, and a mass of 3,670g (1,000 times as much).

Diameter	Units volume (cm <sup>3</sup> ) or sg=1				sg=3 (HE, sabots, aluminum)				sg=7 (iron, steel)				sg=11 (lead, depleted uranium)			
	1:1	2:1	3:1	10:1	1:1	2:1	3:1	10:1	1:1	2:1	3:1	10:1	1:1	2:1	3:1	10:1
1.0mm	-	.001	.002	.008	.002g	.004g	.006g	.023g	.004g	.009g	.015g	.053g	.006g	.014g	.023g	.084g
1.5mm	.002	.004	.007	.026	.005g	.013g	.021g	.077g	.012g	.031g	.049g	.179g	.019g	.049g	.078g	.282g
2.0mm	.004	.010	.017	.061	.013g	.031g	.050g	.182g	.029g	.073g	.117g	.425g	.046g	.115g	.184g	.668g
2.5mm	.008	.020	.033	.119	.025g	.061g	.098g	.356g	.057g	.143g	.229g	.83g	.090g	.225g	.360g	1.30g
3.0mm	.014	.035	.057	.205	.042g	.106g	.170g	.615g	.099g	.247g	.396g	1.43g	.156g	.389g	.622g	2.25g
3.5mm	.022	.056	.090	.326	.067g	.168g	.269g	.977g	.157g	.393g	.629g	2.28g	.247g	.617g	.988g	3.58g
4.0mm	.034	.084	.134	.486	.101g	.251g	.402g	1.46g	.235g	.586g	.938g	3.40g	.369g	.922g	1.47g	5.34g
4.5mm	.048	.119	.191	.692	.143g	.358g	.573g	2.08g	.334g	.835g	1.34g	4.84g	.525g	1.31g	2.10g	7.61g
5.0mm	.065	.164	.262	.949	.196g	.491g	.785g	2.85g	.458g	1.15g	1.83g	6.64g	.720g	1.80g	2.88g	10.4g
5.5mm	.087	.218	.348	1.26	.261g	.653g	1.05g	3.79g	.610g	1.52g	2.44g	8.84g	.958g	2.40g	3.83g	13.9g
6.0mm	.113	.283	.452	1.64	.339g	.848g	1.36g	4.92g	.792g	1.98g	3.17g	11.5g	1.24g	3.11g	4.98g	18.0g
6.5mm	.144	.359	.575	2.08	.431g	1.08g	1.73g	6.25g	1.01g	2.52g	4.03g	14.6g	1.58g	3.95g	6.33g	22.9g
7.0mm	.180	.449	.718	2.60	.539g	1.35g	2.16g	7.81g	1.26g	3.14g	5.03g	18.2g	1.98g	4.94g	7.90g	28.7g
7.5mm	.221	.552	.884	3.20	.663g	1.66g	2.65g	9.61g	1.55g	3.87g	6.18g	22.4g	2.43g	6.07g	9.72g	35.2g
8.0mm	.268	.670	1.07	3.89	.804g	2.01g	3.22g	11.7g	1.88g	4.69g	7.51g	27.2g	2.95g	7.37g	11.8g	42.8g
8.5mm	.322	.804	1.29	4.66	.965g	2.41g	3.86g	14.0g	2.25g	5.63g	9.00g	32.6g	3.54g	8.84g	14.2g	51.3g
9.0mm	.382	.954	1.53	5.53	1.15g	2.86g	4.58g	16.6g	2.67g	6.68g	10.7g	38.7g	4.20g	10.5g	16.8g	60.9g
9.5mm	.449	1.12	1.80	6.51	1.35g	3.37g	5.39g	19.5g	3.14g	7.86g	12.6g	45.6g	4.94g	12.4g	19.8g	71.6g
10mm	.524	1.31	2.09	7.59	1.57g	3.93g	6.28g	22.8g	3.67g	9.16g	14.7g	53.2g	5.76g	14.4g	23.0g	83.5g
11mm	.697	1.74	2.79	10.1	2.09g	5.23g	8.36g	30.3g	4.88g	12.2g	19.5g	70.7g	7.67g	19.2g	30.7g	111g
12mm	.905	2.26	3.62	13.1	2.71g	6.79g	10.9g	39.4g	6.33g	15.8g	25.3g	91.8g	9.95g	24.9g	39.8g	144g
13mm	1.15	2.88	4.60	16.7	3.45g	8.63g	13.8g	50.0g	8.05g	20.1g	32.2g	117g	12.7g	31.6g	50.6g	184g
14mm	1.44	3.59	5.75	20.8	4.31g	10.8g	17.2g	62.5g	10.1g	25.1g	40.2g	146g	15.8g	39.5g	63.2g	229g
15mm	1.77	4.42	7.07	25.6	5.30g	13.3g	21.2g	76.9g	12.4g	30.9g	49.5g	179g	19.4g	48.6g	77.8g	282g
16mm	2.14	5.36	8.58	31.1	6.43g	16.1g	25.7g	93.3g	15.0g	37.5g	60.1g	218g	23.6g	59.0g	94.4g	342g
18mm	3.05	7.63	12.2	44.3	9.16g	22.9g	36.6g	133g	21.4g	53.4g	85.5g	310g	33.6g	84.0g	134g	487g
20mm	4.19	10.5	16.8	60.7	12.6g	31.4g	50.3g	182g	29.3g	73.3g	117g	425g	46.1g	115g	184g	668g
23mm	6.37	15.9	25.6	92.4	19.1g	47.8g	76.5g	277g	44.6g	111g	178g	647g	70.1g	175g	280g	1020g
25mm	8.18	20.5	32.7	119.	24.5g	61.4g	98.2g	356g	57.3g	143g	229g	830g	90.0g	225g	360g	1310g
27mm	10.3	25.8	41.2	149.	30.9g	77.3g	124g	448g	72.1g	180g	289g	1050g	113g	283g	454g	1640g
30mm	14.1	35.3	56.6	205.	42.4g	106g	170g	615g	99.0g	247g	396g	1440g	156g	389g	622g	2260g

## Completing the round

Add the mass of the projectile, propellant and any casing together. This is the mass of *one complete round* for this weapon. The round will have a base energy, which may be modified by the weapon it is fired from. The mass of a round is important, as it will contribute to the mass of a loaded magazine, and the total mass and initiative modifier of the weapon.

**Example** - A 10.5g projectile with 3.8g of propellant and an 11.4g casing will have a total round mass of 25.7g, or about an ounce.

If you design a projectile with a density not listed, you can simply add or subtract the mass of a projectile with a different density. For instance, to get the mass of a sg2 projectile (say one made of stone), simply subtract the mass of an sg1 projectile from one with an sg of 3 (or double the mass of an sg1 projectile).

**Note** - For those doing spreadsheets, the volumes here are based on spheres for 1:1 projectiles, and cylinders with hemispherical ends for other l/w ratios.

## Velocity

Now, figure out how fast your projectile will go with the energy the weapon gives it. This is important for the aiming and damage characteristics of the weapon. Weapons will only get modifiers for hydrostatic shock if they have a velocity of more than 330m/sec (roughly the speed of sound at sea level on Earth). Otherwise, the injury is treated as a puncture wound, like a crossbow bolt. If moving at less than 100m/sec, the projectiles are counted as blunt attacks. On the other end of the scale, no projectile should have a velocity of more than 4,500m/sec, otherwise it will begin to melt from atmospheric friction. If the weapon will be used in a vacuum or atmospheres too thin to breathe, this upper bound does not apply. The chart to the right has some general guidelines.

If the mass you want is not on the table, or you need the exact velocity for some other reason, it is:

$$\text{Velocity in m/sec} = (\text{Muzzle energy(J)}/\text{Projectile mass(g)})^{.5} \times 44.84$$

The result is the muzzle velocity of the projectile in meters per second. The formula and table work equally well for magnetically accelerated projectiles, where the energy used is that actually delivered to the projectile.

To reverse the equation, if you know the velocity and the mass, the energy in Joules is:

$$\text{Muzzle energy in J} = \text{Projectile mass(g)} \times (\text{velocity in m/sec})^2 / 2011$$

**Example** - A projectile with a mass of 5.0g and a velocity of 1,000m/sec would have an energy of 2,486J, which, if it had a diameter of 10mm, would give it a DV of 43.

In Earth gravity (but no atmosphere), the absolute maximum range of a projectile is its (muzzle velocity)<sup>2</sup>/10 meters. On other planets, use the square root of the local gravity in gees, times 10, instead of 10.

**Example** - Gravity on Mars is about .4 gees. The square root of .4 is .632, so on Mars, the maximum range would be (muzzle velocity)<sup>2</sup>/6.32 meters.

In an Earth-normal atmosphere, this formula is good for heavy subsonic projectiles. For small projectiles, as a *rough estimate*, take the theoretical range and multiply it by the *square root* of the projectile mass in *kilograms* and projectile density/10 (with a maximum of 1). Use a mass of 1kg for projectiles with a mass of more than 1kg.

**Example** - A projectile with a velocity of 1,000m/sec will have a theoretical range of 100,000m, or 100km. If the projectile massed 10g (.01kg), it would have a maximum range of 100,000m x .01<sup>.5</sup>, or 10,000m. A 100g (.1kg) projectile would have a maximum range of 100,000m x .1<sup>.5</sup>, or 31,600m. A 10g projectile might be an assault rifle bullet, while a 100g projectile might be a 20mm cannon projectile.

**Note** - Remember that a gun can be deadly well beyond the range where you can deliberately hit something with it.

The table below gives you a rough guide to muzzle velocities for a range or projectile masses and energies.

**Example** - A projectile with a mass of 10g and a muzzle energy of 1200J will have a muzzle velocity of 491m/sec.

Muzzle energy	Velocity of projectile with a mass of				
	2g	5g	10g	20g	50g
200J (.22)	448m/s	284m/s	201m/s	142m/s	90m/s
400J (.38 Spec.)	634m/s	401m/s	284m/s	200m/s	127m/s
600J (9mm)	777m/s	491m/s	347m/s	246m/s	155m/s
800J	897m/s	567m/s	401m/s	284m/s	179m/s
1000J (.357 Mag.)	1000m/s	634m/s	448m/s	317m/s	201m/s
1200J	1100m/s	695m/s	491m/s	347m/s	219m/s
1400J (.44 Mag.)	1190m/s	750m/s	531m/s	375m/s	237m/s
1600J	1270m/s	802m/s	567m/s	401m/s	254m/s
1800J (5.56mm)	1350m/s	851m/s	602m/s	425m/s	269m/s
2000J	1420m/s	897m/s	634m/s	448m/s	284m/s
2500J	1590m/s	1000m/s	709m/s	501m/s	317m/s
3000J (.303)	1740m/s	1100m/s	777m/s	549m/s	347m/s
3500J (7.62mm)	1880m/s	1190m/s	839m/s	593m/s	375m/s
4000J	2010m/s	1270m/s	897m/s	634m/s	401m/s
4500J	2130m/s	1350m/s	951m/s	672m/s	425m/s
5000J (.338 Mag.)	2240m/s	1420m/s	1000m/s	709m/s	448m/s
6000J	2460m/s	1550m/s	1100m/s	777m/s	491m/s
7000J	2650m/s	1680m/s	1190m/s	839m/s	530m/s
8000J	2840m/s	1790m/s	1270m/s	897m/s	567m/s
9000J	3010m/s	1900m/s	1350m/s	951m/s	602m/s
10kJ (.460 Mag.)	3170m/s	2010m/s	1420m/s	1000m/s	634m/s
12kJ	3470m/s	2200m/s	1550m/s	1100m/s	695m/s
14kJ	3750m/s	2370m/s	1680m/s	1190m/s	750m/s
16kJ	4010m/s	2540m/s	1790m/s	1270m/s	802m/s
18kJ (12.7mm)	4250m/s	2690m/s	1900m/s	1350m/s	851m/s
20kJ	4480m/s	2840m/s	2010m/s	1420m/s	897m/s
25kJ	5010m/s	3170m/s	2240m/s	1590m/s	1000m/s
30kJ (14.5mm)	5490m/s	3470m/s	2460m/s	1740m/s	1100m/s
35kJ (15mm)	5930m/s	3750m/s	2650m/s	1880m/s	1190m/s
40kJ	6340m/s	4010m/s	2840m/s	2010m/s	1270m/s
45kJ	6730m/s	4250m/s	3010m/s	2120m/s	1350m/s
50kJ (20mm)	7090m/s	4480m/s	3170m/s	2240m/s	1420m/s

# Conventional Weapons

## Range Class

Now you need to find out the RC of the projectile. Range Class (or RC) is a gross simplification of the ballistics of a round. Projectile velocity, geometry and density all affect how accurate a round is, and how well it keeps its damage at range. These factors can be broken down into some really tedious equations (trust me), which allow you to plot these factors on an accuracy vs. distance or damage vs. distance graph. An RC is a particular curve on that graph which a group of projectiles will cluster around. For instance, all projectiles with a certain ratio of mass to cross-sectional area will decelerate at a certain rate.

In real life, every projectile would have a separate curve, but for sake of design ease, eight curves are provided for aiming RC and damage RC, and any projectile or beam will fall onto one of these curves.

A number of factors will contribute to the RC of a weapon. You *always* use the *worst* RC that applies. For instance, a projectile with good accuracy will gain no benefit if fired from an inaccurate weapon. Weapons will have separate RC's for aiming (stability and velocity), and damage (how quickly the projectile decelerates). RC is in an x/y format, where x is the aiming RC, and y is the damage RC. These do not have to be the same.

Aiming RC	Typical for:
1	Snub-nosed pistols
2	Pistols
3	Carbines
4	Rifles (maximum for shoulder-fired)
5	Light cannon (small autocannon)
6	Medium cannon (tank guns)
7	Heavy cannon (artillery)
8	Superheavy cannon (siege guns)

Use the following tables to find the *maximum* theoretical RC for your weapon. This is the RC that would be used if fired from the "perfect" gun. This provides you with a set of characteristics for a family of weapons based on the same cartridge, and lets you know if the weapon will meet the criteria you designed for it.

Velocity(m/sec)	sg3 diameter(mm)				sg7 diameter(mm)				sg11 diameter(mm)										
	Aiming	1:1	2:1	3:1	10:1	Damage	Mass/Diam <sup>2</sup>	1:1	2:1	3:1	10:1	1:1	2:1	3:1	10:1				
RC1	200m/s	150m/s	100m/s	50m/s	RC1	<.050	31.0mm	12.5mm	7.5mm	2.0mm	13.5mm	5.0mm	3.0mm	.5mm	8.5mm	3.0mm	2.0mm	.5mm	
RC2	400m/s	300m/s	250m/s	100m/s	RC2	.051-.100	63.0mm	25.0mm	15.5mm	4.0mm	27.0mm	10.5mm	6.5mm	1.5mm	17.0mm	6.5mm	4.0mm	1.0mm	
RC3	750m/s	600m/s	400m/s	250m/s	RC3	.101-.150	95.0mm	38.0mm	23.0mm	6.5mm	41.0mm	16.0mm	10.0mm	2.5mm	26.0mm	10.0mm	6.5mm	1.5mm	
RC4	1100m/s	900m/s	750m/s	500m/s	RC4	.151-.300	191mm	76.0mm	47.0mm	13.0mm	81.0mm	32.0mm	20.0mm	5.5mm	52.0mm	20.0mm	13.0mm	3.5mm	
RC5	1500m/s	1300m/s	1100m/s	800m/s	RC5	.301-.500	318mm	127mm	79.0mm	21.0mm	136mm	54.0mm	34.0mm	9.0mm	86.0mm	34.0mm	21.0mm	5.5mm	
RC6	2000m/s	1750m/s	1500m/s	1150m/s	RC6	.501-.750	-	190mm	119mm	32.0mm	204mm	81.0mm	51.0mm	14.0mm	130mm	52.0mm	32.0mm	8.5mm	
RC7	2600m/s	2300m/s	2000m/s	1600m/s	RC7	.751-1.05	-	267mm	167mm	46.0mm	286mm	114mm	71.0mm	19.5mm	182mm	72.0mm	45.0mm	12.5mm	
RC8	—anything >RC7—				RC8	>1.05	—any projectile too large to be RC7—												

For aiming RC, it is based on the velocity of the projectile in m/sec, and for damage RC, based on the projectile mass in grams, divided by diameter in mm squared. The numbers are the *maximum* for that range.

**Example** - Take a 5mm lead (sg11) rifle bullet (3:1 l/w ratio) with a velocity of 700m/sec. A velocity of 700m/sec is more than the amount for aiming RC3, but less than that for RC4, so it is aiming RC4 (750m/sec is the *maximum* velocity that would be RC4). The projectile has a mass of 2.88g. Divided by 25 (5mm squared), this is .115, which falls into the RC3 range for damage. Or, you could have looked it up under 3:1 sg11 projectiles and seen that it was less than the 6.5mm *maximum* for RC3.

**Note** - Projectiles in a vacuum do not slow down, and maintain full DV until they strike something. Therefore their Damage RC is irrelevant in settings without an atmosphere. This is why space debris can be so hazardous.

For instance, a spherical 2mm (1/12th") chunk of steel travelling at 10,000m/sec (about 36,000kph or 22,500mph) has an energy of 1442J, and a DV of 73. If you were orbiting in the opposite direction and hit it, the relative velocity would be doubled, and the DV would be 146, *more than a .50 caliber machine gun!* This would be more than enough to go in one side of the Space Shuttle and send debris shooting out the other. Even flakes of paint and grains of sand can be hazardous at these velocities, the former actually taking a gouge out of a Space Shuttle window a few years back.

**Tech Geek Note** - The modifiers to hit for aiming RC are derived from a curve whose slope is roughly:

$$y = 1.95 - zr$$

where z is a constant based on aiming RC (.8 for RC1, .4 for RC4), r is the square root of the range in meters, and y is the log of the "to hit" modifier in a 1d20 game system. You'll have to manually plot it out beyond where y equals zero. For instance, the "+0" range for an aiming RC4 weapon is 23.8 meters.

The average person is *not* going to need this, but enough people have asked for the equation over the years that we are including it just for them.

At this point, you should have everything you need to know about the bullet or projectile, including its mass, width, length, density, velocity, Tech Level and optimum range characteristics. Now that you have your bullet parameters, you can move on to the weapon itself, which is made up of several subsystems.

## Receiver

The receiver is the portion of the weapon that feeds the ammunition from wherever it is stored to the chamber where it is fired, and out again. It includes the trigger assembly, safety, and so on. In muzzle-loading weapons, the receiver includes the area of the barrel that holds the powder and has the touch-hole. The mass of the receiver on a conventional gun is:

$$\text{Base propellant energy}^{.63} \times (20\text{-TL}) \times \text{Action multiple}$$

Note that this is *propellant energy*, not muzzle energy. You use the raw energy of the powder charge for determining receiver mass. The action multiple is based on the type of action the weapon has, certain advantages or disadvantages giving different masses. For instance, a revolver is lighter, but at any TL below 13, is less efficient than other actions.

Action	Mass multiplier
Autoburst	x1.50
Full-auto	x1.50
Semi-auto	x.90
Lever action	x.75
Bolt action	x.60
Revolver	x.30
Single shot	x.30

Full-auto(AT) and autoburst(AB) actions may be similar to semi-auto(SA) actions in appearance and design, but are heavier, and able to withstand more abuse from heat and stress. This extra mass represents heavier components and active or passive cooling arrangements, which may in practice cover part of the barrel as well (like a water cooling jacket). A full-auto or autoburst weapon *may* be bought with a semi-auto receiver, *but will suffer a reliability penalty later*. Most full-auto assault rifles are bought with the semi-auto receiver mass. Light machineguns may or may not, depending on manufacturer. AT/AB mass works best on weapons designed for sustained fire, like heavy machineguns.

The table on the next column has some base numbers for receiver mass for varying amounts of energy. These numbers are for TL10 receivers. For receivers below TL10, add 10% to the listed amount per TL. For receivers above TL10, add 10% to the listed amount per TL. The calibers listed beside some energies are at the closest energy bracket to the actual round, although rounds may vary due to manufacturing differences, TL's or other factors.

Propellant energy	Mass in grams of TL10 receiver				
	AT/AB	SA	LA	B	RV/SS
200J (.22)	422g	253g	211g	169g	84g
400J (.38 Spec)	654g	392g	327g	261g	131g
600J (9mm)	844g	506g	422g	338g	169g
800J	1010g	607g	506g	405g	202g
1000J (.357 Mag)	1160g	699g	582g	466g	233g
1200J	1310g	784g	653g	522g	261g
1400J (.44 Mag.)	1440g	864g	720g	576g	288g
1600J	1570g	939g	783g	626g	313g
1800J (5.56mm)	1690g	1010g	843g	674g	337g
2000J	1800g	1080g	901g	721g	360g
2500J	2070g	1240g	1040g	830g	415g
3000J (.303)	2330g	1400g	1160g	931g	465g
3500J (7.62mm)	2560g	1540g	1280g	1030g	513g
4000J	2790g	1670g	1390g	1120g	558g
4500J	3000g	1800g	1500g	1200g	601g
5000J (.338 Mag)	3210g	1930g	1610g	1280g	642g
6000J	3600g	2160g	1800g	1440g	720g
7000J	3970g	2380g	1980g	1590g	793g
8000J	4320g	2590g	2160g	1730g	863g
9000J	4650g	2790g	2320g	1860g	930g
10kJ (.460 Mag)	4970g	2980g	2480g	1990g	993g
12kJ	5570g	3340g	2790g	2230g	1110g
14kJ	6140g	3680g	3070g	2460g	1230g
16kJ	6680g	4010g	3340g	2670g	1340g
18kJ (12.7mm)	7190g	4320g	3600g	2880g	1440g
20kJ	7690g	4610g	3840g	3080g	1540g
25kJ	8850g	5310g	4420g	3540g	1770g
30kJ (14.5mm)	9920g	5950g	4960g	3970g	1990g
35kJ (15mm)	10900g	6560g	5470g	4370g	2190g
40kJ	11900g	7140g	5950g	4760g	2380g
45kJ	12800g	7690g	6410g	5130g	2560g
50kJ (20mm)	13700g	8220g	6850g	5480g	2740g

AT - Automatic weapon  
 B - Bolt-action weapon  
 RV - Revolver weapon  
 SS - Single shot weapon  
 AB - Autoburst weapon, may be fired autofire as well  
 SA - Semi-auto weapon, or light-duty autofire/autoburst  
 LA - Lever action, also applies to pump action

**Example** - A semi-auto(SA) receiver for a 3,500J weapon will mass 1,540g. For a TL12 weapon, it would mass less. Since there are two TL's of difference, and each one is a 10% decrease in receiver mass, the TL12 receiver will have a mass of  $1,540g \times .8 = 1,232g$ .



# Conventional Weapons

## Clip/Magazine

The ammunition for the weapon must be carried somewhere. This will generally be referred to as a magazine or clip, regardless of the actual form it takes.

### Internal magazine

The projectiles are stored in an integral part of the weapon, which cannot be removed. When empty, it must be refilled from an outside source, possibly one round at a time, or in small groups via "stripper clips" containing 5-10 rounds. The mass of such a system (empty) is  $(.1 \times \text{mass of one round} \times \text{number of rounds carried})$ .

**Advantages** - An internal magazine gives the lowest mass penalty of any magazine type.

**Disadvantages** - Since it must be manually reloaded each time it is emptied, the long term rate of fire is lower.

### External magazine

This is a feed box, separate from the weapon, and may include special ammo handling machinery to get the rounds from storage to weapon, like mechanical ammo links, flexible conduits, etc. The mass of such a system (empty) is  $(.3 \times \text{mass of one round} \times \text{number of rounds carried})$ .

**Advantages** - An external magazine is a must for weapons with high sustained rates of fire. Linked ammunition can be made into belts of about any size, limited only by space available.

**Disadvantages** - The external magazine is bulky and heavy compared to other types of ammunition handling, and is less suitable for hand-held weapons.

### Detachable clip

This is a spring or gravity-fed magazine that attaches directly to the weapon, which can be removed easily for reloading or replacement. The mass of such a system (empty) is  $(.2 \times \text{mass of one round} \times \text{number of rounds carried})$ .

**Advantages** - A detachable magazine is good for any weapon which will need to use a moderate quantity of ammunition, but still need the advantages of low mass and portability.

**Disadvantages** - Each extra magazine is dead weight that the user must carry in addition to the mass of the ammunition itself. This can be offset by carrying a limited number of clips, which can be reloaded between uses.

**Note** - Normal clip mass is based on *non*-disposable ammunition. However, a *disposable* clip could be based on the mass of disposable ammunition.

### Revolver clip

A revolver has a rotating cylinder which contains the rounds, which pass in front of the barrel for each shot. The mass of such a system (empty) is  $(.166 \times \text{receiver mass} \times \text{number of rounds carried})$ .

**Advantages** - Revolvers are more reliable. If a weapon has a "dud" malfunction, the weapon can be refired without losing any sighting bonuses, and jams are almost impossible.

**Disadvantages** - Revolver "clips" are heavy, as they absorb much of the firing stress, while other clips just hold the rounds. Since revolver clips are usually cylindrical, large clips are unwieldy as well as heavy.

The mass of any detachable clip is added to the mass of the rounds carried, and the result is the mass of a full clip. Mass of *internal* or *clip* magazines is added to weapon mass *before* accessories, and the mass of the rounds added *afterwards*.

## Barrel

The barrel of a weapon is separate from the receiver. This is the part the projectile travels down before exiting the weapon, where it receives its spin stabilization (if any), and where the expanding propellant gases push on the projectile. In low tech weapons, it also forms the sighting plane, with aiming points at both ends. A weapon barrel must be a minimum length in order for the propellant gases to burn completely enough to give the projectile its rated DV (from computed muzzle energy). This length is:

$$(400/\text{propellant TL}) \times (\text{powder mass}/2)^5/\text{projectile diameter(cm)}$$

**Example** - A TL10 weapon with a powder mass of 2.0g, and a bullet diameter of 9mm will need a barrel 44.4cm long.

A longer barrel will increase the effective energy of the propellant in *that weapon* by 1% per 2% increase in length, with a maximum 10% increase in DV (roughly 42% increase in barrel length). A shorter barrel will decrease the effective energy of the propellant in *that weapon* by 1% per 2% decrease in barrel length, with a minimum barrel length of 5 times the projectile diameter. The barrel must also have a certain minimum length for the weapon to have a given aiming RC.

Barrel length/projectile diameter	Minimum	Aiming RC
Length <10x projectile diameter	<10cm	RC1
Length 11-20x projectile diameter	10cm	RC2
Length 21-40x projectile diameter	20cm	RC3
Length 41-80x projectile diameter	40cm	RC4
Length 81-150x projectile diameter	80cm	RC5
Length 151-300x projectile diameter	150cm	RC6
Length 301-600x projectile diameter	300cm	RC7
Length >600x projectile diameter	600cm	RC8

Compare the ratio-based barrel length to the minimum lengths listed. If the ratio-based minimum length is two or more rows below the line for the ratio itself, the *actual* minimum barrel length is shifted down one row per two rows of difference (round down). The adjusted minimum length is the shortest the barrel may ever be, regardless of the ratio, to achieve that aiming RC.

**Example** - A 35cm barrel for a .5cm bullet is 70x bullet diameter, or the RC4 category. However, 35cm is *less* than the minimum for RC4, so the weapon is RC3 for aiming instead.

**Example** - A 10cm anti-tank gun would need a barrel over 1500cm (15 meters) long to have the 151-300x ratio needed for RC6. However, the *minimum* length listed for RC6 is 150cm. Since the ratio-based length is >600cm (*two* rows down), the *actual* minimum length is *one* row down, or 300cm.

Barrel mass is dependent on TL, *effective* energy (muzzle energy for *basic* barrel length), and its length. The mass in grams is:

$$\text{Length in cm} \times \text{Energy in J}^5 \times (20\text{-TL}) \times .1$$

The table shows barrel masses (in grams) for given lengths and energies at TL10. For each TL<10, increase mass by 10%, and for each TL>10, reduce mass by 10%. For instance, a TL5 barrel would mass 50% more, while a TL15 barrel would mass 50% less. Since barrel mass increases linearly with length, intermediate lengths are easily estimated. For instance, a 66cm barrel has 10% more length (and mass) than a 60cm barrel.

Energy	Barrel length															
	5cm	10cm	15cm	20cm	25cm	30cm	40cm	50cm	60cm	70cm	80cm	90cm	100cm	150cm	200cm	250cm
200J	71g	141g	212g	283g	354g	424g	566g	707g	849g	990g	1130g	1270g	1410g	2120g	2830g	3540g
400J	100g	200g	300g	400g	500g	600g	800g	1000g	1200g	1400g	1600g	1800g	2000g	3000g	4000g	5000g
600J	122g	245g	367g	490g	612g	735g	980g	1230g	1470g	1720g	1960g	2210g	2450g	3670g	4900g	6120g
800J	141g	283g	424g	566g	707g	849g	1130g	1410g	1700g	1920g	2260g	2550g	2830g	4240g	5660g	7070g
1000J	158g	316g	474g	632g	791g	949g	1270g	1580g	1900g	2210g	2530g	2850g	3160g	4740g	6320g	7910g
1200J	173g	346g	520g	693g	866g	1040g	1390g	1730g	2080g	2430g	2770g	3120g	3460g	5200g	6930g	8660g
1400J	187g	374g	561g	748g	935g	1120g	1500g	1870g	2250g	2620g	2990g	3370g	3740g	5610g	7480g	9350g
1600J	200g	400g	600g	800g	1000g	1200g	1600g	2000g	2400g	2800g	3200g	3600g	4000g	6000g	8000g	10000g
1800J	212g	424g	636g	849g	1060g	1270g	1700g	2120g	2550g	2970g	3390g	3820g	4240g	6360g	8490g	10600g
2000J	224g	447g	671g	894g	1120g	1340g	1790g	2240g	2680g	3130g	3580g	4030g	4470g	6710g	8940g	11200g
2500J	250g	500g	750g	1000g	1250g	1500g	2000g	2500g	3000g	3500g	4000g	4500g	5000g	7500g	10000g	12500g
3000J	274g	548g	822g	1100g	1370g	1640g	2190g	2740g	3290g	3830g	4380g	4930g	5480g	8220g	11000g	13700g
3500J	296g	592g	887g	1180g	1480g	1780g	2370g	2960g	3550g	4140g	4730g	5320g	5920g	8870g	11800g	14800g
4000J	316g	632g	949g	1270g	1580g	1900g	2530g	3160g	3800g	4430g	5060g	5690g	6330g	9490g	12600g	15800g
4500J	335g	671g	1010g	1340g	1680g	2010g	2680g	3350g	4030g	4700g	5370g	6040g	6710g	10100g	13400g	16800g
5000J	354g	707g	1060g	1410g	1770g	2120g	2830g	3540g	4240g	4950g	5660g	6360g	7070g	10600g	14100g	17700g
6000J	387g	775g	1160g	1550g	1940g	2320g	3100g	3870g	4650g	5420g	6200g	6970g	7750g	11600g	15500g	19400g
7000J	418g	837g	1260g	1670g	2090g	2510g	3350g	4180g	5020g	5860g	6690g	7530g	8370g	12100g	16100g	20900g
8000J	447g	894g	1340g	1790g	2240g	2680g	3580g	4470g	5370g	6260g	7160g	8050g	8940g	13400g	17900g	22400g
9000J	474g	949g	1420g	1900g	2370g	2850g	3800g	4740g	5690g	6640g	7590g	8540g	9490g	14320g	19000g	23700g
10kJ	500g	1000g	1500g	2000g	2500g	3000g	4000g	5000g	6000g	7000g	8000g	9000g	10000g	15000g	20000g	25000g
12kJ	548g	1110g	1640g	2190g	2740g	3290g	4380g	5480g	6570g	7670g	8760g	9860g	11000g	16400g	21900g	27400g
14kJ	592g	1180g	1780g	2370g	2960g	3550g	4730g	5920g	7100g	8280g	9470g	10600g	11800g	17700g	23700g	29600g
16kJ	632g	1270g	1900g	2530g	3160g	3800g	5060g	6320g	7590g	8850g	10100g	11400g	12600g	19000g	25300g	31600g
18kJ	671g	1340g	2010g	2680g	3350g	4030g	5370g	6710g	8050g	9390g	10700g	12100g	13400g	20100g	26800g	33500g
20kJ	707g	1410g	2120g	2830g	3540g	4240g	5660g	7070g	8490g	9900g	11300g	12700g	14100g	21200g	28300g	35400g
25kJ	791g	1580g	2370g	3160g	3950g	4740g	6330g	7910g	9490g	11100g	12600g	14200g	15800g	23700g	31600g	39500g
30kJ	866g	1730g	2600g	3460g	4330g	5200g	6930g	8660g	10400g	12100g	13900g	15600g	17300g	26000g	34600g	43300g
35kJ	935g	1870g	2810g	3740g	4680g	5610g	7480g	9350g	11200g	13100g	15000g	16800g	18700g	28100g	37400g	46800g
40kJ	1000g	2000g	3000g	4000g	5000g	6000g	8000g	10000g	12000g	14000g	16000g	18000g	20000g	30000g	40000g	50000g
45kJ	1060g	2120g	3180g	4240g	5300g	6360g	8490g	10600g	12700g	14800g	17000g	19100g	21200g	31800g	42400g	53000g
50kJ	1120g	2240g	3350g	4470g	5590g	6710g	8940g	11200g	13400g	15700g	17900g	20100g	22400g	33500g	44700g	55900g

## Accessories

All designs will need some sort of external fixtures, like stocks, trigger guards, sights and so on. These items will simply add a percentage to the mass of the unloaded weapon. This includes the weapon and any ammunition feed system, but not the ammunition. A weapon (unloaded) plus accessories will mass:

$$(\text{receiver} + \text{barrel} + \text{any internal clip}) \times \text{mass multiplier}$$

Detachable or external clips are a separate item, and do not contribute to accessory mass.

## Fixed mounts

Fixed mount weapons, or those which are a permanent part of a vehicle will have a mass multiplier of x1.1. The weapon will normally be unsuitable to be fired in any other way, although small examples may be cradled under the arm, or braced against a hip, at substantial penalties to hit a target. A fixed mount includes sights only if the firer would normally look directly over the weapon to fire it.

## Semi-fixed

A semi-fixed mount has all the features of both fixed and hand-held mounts, and is usually applied to weapons like light machine guns, which may be carried, fired from a bipod, pintle or tripod. They have a mass multiplier of x1.3. A semi-fixed mount includes all advantages of the previous types, and in addition can be assumed to have a folding bipod, allowing more accurate fire from a prone position.

## Hand-held

Weapons designed to be fired by hand, without external encumbrances will have a mass multiplier of x1.2. The weapon is not designed to be fired from or mounted in any fixed mount or movable tracking system. A hand-held weapon will include basic sights and grips for one or two hands. If a military longarm, provision for attaching a bayonet, grenade launcher (TL10+) or in some cases a telescopic (TL10+) or night sight (TL11+) may be included, and on civilian longarms, will usually include provision for mounting a telescopic sight (TL8+). These features will be less common, but available at lower TL's, depending on technical and cultural developments in that world.

**Example** - A TL11 military rifle is designed with a base mass of 4.00kg. It is hand-held, so the final mass is 4.00 x 1.2, or 4.8kg. This extra .8kg includes the stock, grip, and sights, and optionally includes a bayonet lug, grenade launcher attachment point and mounting points for a telescopic sight.

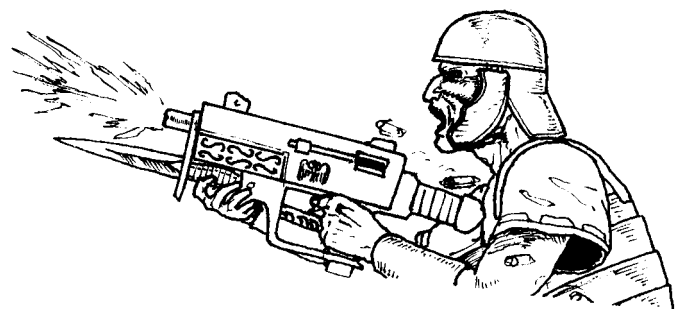

# Conventional Weapons

## Secondary characteristics

You now have all the primary characteristics of your weapon, like mass, aiming and damage RC, DV, action and so on. With these, you can figure the secondary characteristics of the weapon.

### Inherent Accuracy

The base IA of a weapon is half its aiming RC, rounding fractions up. So weapons with aiming RC of 1 or 2 have an IA of 1, those with aiming RC of 3 or 4 have an IA of 2, and so on. RC5-8 weapons only get IA's of 3 or more if mounted or solidly braced.

### Cost

The base cost for a conventional firearm is based on its DV. The price is in credits (Cr), where a credit is a generic unit of currency roughly equal to a modern US dollar in purchasing power.

$$\text{Cost} = (\text{DV of bullet fired from weapon})^2/5 + 100\text{Cr}$$

**Example** - A weapon with a DV of 20 would have a base cost of 180Cr. A cannon with a DV of 1000 would have a base cost of 200,100Cr.

**Note** - Remember that DV for cost purposes is a full-bore projectile, without any damage enhancements for ammunition type.

Cost is a TL-independent item. The Cr is supposed to apply to whatever standard of living applies in the game where this weapon is used. If average income or standard of living is lower, then prices will be correspondingly lower, but will still represent about the same amount of work by a person trying to save up for it. The amount of 100Cr represents the same fraction of an average person's income at TL7 as it does at TL13, or any other TL with money or exchange. Local scarcity, restrictions or other non-technical concerns may also modify weapon price.

The base cost of a weapon is modified by the design and firing characteristics of the weapon.

Action	Cost	Weapon		Cost	
SS	x.5, +.2 per extra barrel*	Pistol		x2.0	
B	x.7	Longarm		x1.0	
RV	x.5	Vehicle mount		x1.0	
SA	x1.0				
AT & SA	x1.3	<b>Mass</b>	<b>Cost</b>	<b>Base IA</b>	<b>Cost</b>
AT only	x1.0	x2.0	x.25	-100%	x.25
AB	x1.5	x1.5	x.50	-50%	x.50
		x1.0	x1.0	+0%	x1.0
		x.75	x2.0	+50%	x2.0
		x.50	x4.0	+100%	x4.0

$$\text{Extra clip} = \text{shots}^5 \times \text{weapon cost}/100$$

\* the +.2 applies to each extra barrel on any multi-barrel weapon

These multiply together, rather than adding, so a pistol (x2.0) revolver (x.50) has the same cost multiple as a semi-automatic (x1.0) longarm (x1.0). Weapons with detachable magazines are assumed to come with *one*. Extra clips (/C) cost as shown. This cost is halved for external magazines (/E), and multiplied by 10 for revolver "clips" (extra cylinders). Clip-fed weapons may have several clip sizes, but each alternate size is usually larger than the one the weapon is equipped with.

**Mass modifiers** - Each x2.0 multiple on cost will reduce the mass of a weapon by 25% (with maximum reduction of 50%). Each x.50 multiple on cost will increase the mass by 50% (with maximum increase of 100%). This mass modifier applies to the unloaded weapon mass, and does not apply to ammunition, although it will apply to the empty mass of any magazines (like empty clips). This modification to mass has no effect on the IA of the weapon.

**IA modifiers** - The Inherent Accuracy of the weapon may be increased by increasing the cost of the weapon. Each x2.0 multiple on cost will increase the base IA of the weapon by 50% (round nearest). Each x.50 multiple on cost will decrease the base IA of the weapon by 50% (round down). The IA of a weapon may never go below -1. Each point that IA is decreased due to cheapness is a +1 row modifier for determining malfunctions.

The IA may also be increased by increasing the mass of the weapon, *if the weapon mass was not already increased to reduce weapon cost*. Each 50% increase in mass *and* cost will increase the IA by 50% (round nearest), with a maximum increase of 200% (total of 3x mass and cost). So, if a pistol with an IA of 1 was increased in mass and cost by 50%, its IA would go to 1.5, which rounds to 2.

The maximum IA of any weapon may never exceed 3 times the base IA for that weapon.

**Example** - A semi-auto pistol with a DV of 20 has a base cost of 360Cr. For an increase in cost of 100% (+360Cr), the IA goes to 1.5. For another increase in cost *and* mass of 100% (+360Cr), the IA goes to 2.5, which rounds to 3. So, for a cost of 1,080Cr, you can have this pistol in a heavy target version, with an IA of 3 instead of 1.

### Rate of fire

All weapons will have a maximum rate of fire, or number of shots that can be fired per second. Semi-automatic weapons have a maximum of 4 shots per second, double-action revolvers have a maximum of 3, and single action revolvers have a maximum of 2. This is as fast as you can pull the trigger and fire, and accuracy is low if more than half this (round up) is used. Bolt action weapons get a maximum of 1 shot per 2 seconds, lever/pump actions get 2 shots per 3 seconds, and single shot weapons get 1 shot per barrel, with a normal maximum of 2 shots per second. Muzzle loading weapons or other weapons using loose powder charges will vary with the skill of the loader and should be according to historical guidelines, or reloading guidelines for the system you use this weapon in.

The following formula will calculate the absolute maximum rate a projectile weapon can fire at, and this usually only applies to automatic weapons.

$$\text{Max. ROF} = 10/(\text{mass of a complete round in grams}/1000)^2(n)$$

**Example** - A round massing 10g will have a maximum ROF per second of 10, divided by (.01)<sup>2</sup>, or 25 rounds per second.

The table to the right has some masses and maximum rates of fire precalculated for your convenience.

### Malfunction chance

The chance that a weapon will malfunction in use depends on the quality of the weapon, the rate of fire, and the percentage of maximum possible propellant used. A modern weapon (TL8+) will have a chance of misfiring if a 20 is rolled on the "to hit" roll (in a 1d20 system). Weapons with TL7- ignition systems (**flintlocks**, **wheellocks**, **matchlocks**) will automatically misfire on a 20, and poor handling will increase this chance even more.

Compare percentage of maximum propellant capacity used to the table below. The roman numerals are simply for reference.

	% capacity used	Second 1d20 roll			Modifiers	Amount
		Dud	Jam	Critical		
VI	Maximum	1	2-4	5+	Max. ROF	+3 rows
V	80-99%	11	12-14	15+	80-99% ROF	+2 rows
IV	60-79%	16	17-19	20	70-89% ROF	+1 row
III	40-59%	18	19+	n/a		
II	20-39%	19	20	n/a	AT using SA	+1 row
I	0-19%	19	20	n/a	Reduced cost	+1 row per

Round mass	Maximum ROF	80% ROF	60% ROF
5.0g	29 per sec.	23 per sec.	17 per sec.
10.0g	25 per sec.	20 per sec.	15 per sec.
15.0g	23 per sec.	19 per sec.	14 per sec.
20.0g	22 per sec.	18 per sec.	13 per sec.
25.0g	21 per sec.	17 per sec.	13 per sec.
30.0g	20 per sec.	16 per sec.	12 per sec.
40.0g	19 per sec.	15 per sec.	11 per sec.
50.0g	18 per sec.	15 per sec.	11 per sec.
70.0g	17 per sec.	14 per sec.	10 per sec.
100g	16 per sec.	13 per sec.	10 per sec.
150g	15 per sec.	12 per sec.	9 per sec.
200g	14 per sec.	11 per sec.	8 per sec.
250g	13 per sec.	10 per sec.	8 per sec.
300g	13 per sec.	10 per sec.	8 per sec.
400g	12 per sec.	10 per sec.	7 per sec.
500g	11 per sec.	9 per sec.	7 per sec.

A "dud" means the weapon fails to fire, and is usually the result of a defective round of ammunition, or not enough force given to initiate the charge (primer struck too light, not enough priming, bad or broken flint, extinguished match, etc.). No further fire is possible past this point. The same propellant charge can be tried again, but should roll on this table again, regardless of the "to hit" roll, *after* the weapon is recocked, or reprimed. If the old charge is unloaded and replaced, malfunction chance reverts to normal.

A "jam" means the round has fired, but something has happened to foul the mechanism of the weapon. An example would be a cartridge case failing to extract, powder residue clogging a touchhole, a subsequent round failing to feed, etc. No further fire is possible past this point. This may take longer to correct, but subsequent shots will fire at normal effectiveness.

A "critical" usually means a malfunction that causes the weapon to cease working because of internal damage. This could be a broken firing pin, an internal spring snapping, etc. No further fire is possible past this point. If the weapon has a critical chance of 15+, a roll of 20 indicates a weapon explosion. This could be due to faulty design, or something like a previous shot getting jammed in the barrel, followed by a live round. The weapon is destroyed, and does 1/4 its DV to anything touching the receiver or barrel. Explosive payload charges roll on the same table, and any critical indicates they explode as well. If this occurs, *and* there is a magazine, a *further* check must be made for it.

**Technicalities** - If a weapon has multiple barrels and a common receiver (like a double-barreled shotgun), a dud will only affect one of the barrels, but a critical will affect the machinery common to both. A jam will only be noticed when an attempt is made to reload, and only applies vs. one barrel. On a gatling gun type of weapon, a dud will have no effect except for that shot, and the weapon will continue to function. A jam will stop up the whole weapon, as will a critical. Revolvers may have duds, but this does not affect subsequent fire. Jams will only be noticed when an attempt is made to reload and only applies vs. one chamber of the revolver (the others may be reloaded normally).

**Note** - Remember that the exact effects of a weapon malfunction are dependent on the game system you convert the weapon to. The numbers in **3G<sup>3</sup>** are a guideline. In the "real world", a modern weapon in good condition should have a malfunction *less* than 1 time in 200 shots, which makes them Type I for malfunction chances. To have a modern weapon malfunction more often than this in your game would be unrealistic unless the weapon were *severely* mistreated.

### Weapon length

In general, the length of a weapon is equal to the barrel length, plus receiver length, plus stock length (if a longarm). The receiver length is equal to the propellant/projectile volume ratio, times the projectile diameter, times 2, with a *minimum* of 2 times the projectile length for single shot weapons and revolvers, and 4 times the projectile length for other actions. Most stocks will be 30cm long, and add 2 locations to the length of the weapon (which *does* apply for Initiative, AV and BP purposes). "Stockless" or "**bullpup**" designs started appearing at TL11.

**Example** - A 9mm bullet with a 2:1 powder/projectile ratio would have a semi-auto receiver length of  $.9\text{cm} \times 2.0 \times 4.0 = 7.2\text{cm}$  long.

**Note** - The length of a round of modern ammunition can be *approximated* as half the receiver length for a single shot weapon. Most people don't need this detail, but some *have* asked...



# Conventional Weapons

## Weapon bulk

The bulk of a weapon is found by dividing its length in cm by 15, rounding fractions up. This is the number of **TimeLords** hit locations the weapon would cover if carried close to the body.

Very Small (VS)	About the size of a wristwatch
Small (S)	About the size of a can of soda
Medium (M)	About the size of a small computer, or 1 hit location
Large (L)	About the size of a torso
Very Large (VL)	About the size of a person

In general, each size is four times as large as the previous one, and the examples are to give you a rough idea of scale.

The bulk of each particular location depends on the overall mass of the weapon. Weapon bulk can be used to determine how likely a weapon is to be hit by fire that might otherwise strike the owner.

**Example** - If the previous weapon had a barrel 15cm long, the total weapon length would be 15cm + 7.2cm = 22.2cm, or 2 locations long.

The size of each location of a weapon depends on the weapon mass, as per the table below. The italicized entries correspond to the weapon listed in parenthesis, for comparison purposes.

Mass per location	Bulk per location	BP per location
<.50kg	Very Small (VS)	(20-TL)/5
.51-4.0kg	Small (S)	(20-TL)/4
4.01-32.0kg	Medium (M)	(20-TL)/3
>32.0kg	Large (L)	(20-TL)/2

Mass	Length							
	15cm	30cm	45cm	60cm	75cm	90cm	105cm	120cm
.50kg	VS/1	VS/2	VS/3	VS/4	VS/5	VS/6	VS/7	VS/8
1.0kg (Luger)	S/1	VS/2	VS/3	VS/4	VS/5	VS/6	VS/7	VS/8
1.5kg	S/1	S/2	VS/3	VS/4	VS/5	VS/6	VS/7	VS/8
2.0kg (AutoMag)	S/1	S/2	S/3	VS/4	VS/5	VS/6	VS/7	VS/8
2.5kg	S/1	S/2	S/3	S/4	VS/5	VS/6	VS/7	VS/8
3.0kg	S/1	S/2	S/3	S/4	S/5	VS/6	VS/7	VS/8
3.5kg (Mac-10)	S/1	S/2	S/3	S/4	S/5	S/6	VS/7	VS/8
4.0kg (Uzi)	S/1	S/2	S/3	S/4	S/5	S/6	S/7	VS/8
4.5kg (M-16)	M/1	S/2	S/3	S/4	S/5	S/6	S/7	S/8
5.0kg (M-14)	M/1	S/2	S/3	S/4	S/5	S/6	S/7	S/8
6.0kg	M/1	S/2	S/3	S/4	S/5	S/6	S/7	S/8
7.0kg	M/1	S/2	S/3	S/4	S/5	S/6	S/7	S/8
8.0kg	M/1	S/2	S/3	S/4	S/5	S/6	S/7	S/8
9.0kg	M/1	M/2	S/3	S/4	S/5	S/6	S/7	S/8
10.0kg (Minimi)	M/1	M/2	S/3	S/4	S/5	S/6	S/7	S/8
12.0kg	M/1	M/2	S/3	S/4	S/5	S/6	S/7	S/8
14.0kg	M/1	M/2	M/3	S/4	S/5	S/6	S/7	S/8
16.0kg (M-60)	M/1	M/2	M/3	S/4	S/5	S/6	S/7	S/8
18.0kg	M/1	M/2	M/3	M/4	S/5	S/6	S/7	S/8
20.0kg	M/1	M/2	M/3	M/4	S/5	S/6	S/7	S/8

**Example** - If the previous weapon had a total mass (unloaded) of 1.20kg, it would mass .60kg per location, so each location would be Small. The size of the weapon would be S/2, since there were 2 locations.

## Armor Value

The Armor Value of the weapon is a measure of how much physical abuse the weapon can withstand, and is based on the same scale as the DV. That is, 1 point of damage is stopped by 1 point of armor. Anything that gets through AV does actual damage to the weapon. The AV is a general number, and reflects the average of the entire weapon, rather than the specific damage resistance of the stock, barrel, receiver, etc. Individual components may vary by a great deal. The AV is based on the TL and energy of the weapon, and is based on the energy that the weapon actually uses, not which is lost by TL inefficiencies, short barrel length, etc. Conventional firearms have a minimum AV of 3. Armor value goes *down* as TL goes up because there is usually less material in the weapon, even if the material is more advanced. For instance, a modern M-16 (TL10) will have a lower AV than a weapon firing a similar bullet from a WWII-era weapon (TL9), because the TL9 weapon is made from steel rather than aluminum. A TL13 weapon might be made of advanced plastics which are very strong and lightweight, but still softer (and with lower AV) than metals would be.

Not many game systems have separate stats for the AV of a weapon, so this **3G<sup>3</sup>** stat is one of the less important ones.

$$AV = \text{Effective energy of propellant}^{.15} \times ((20-TL)/3)(n)$$

Energy	Tech Level														
	1	2	3	4	5	6	7	8	9	10	11	12	13	14	15
100J	13	12	11	11	10	9	9	8	7	7	6	5	5	4	3
200J (.22)	14	13	13	12	11	10	10	9	8	7	7	6	5	4	4
300J	15	14	13	13	12	11	10	9	9	8	7	6	5	5	4
400J (.38 Spec.)	16	15	14	13	12	11	11	10	9	8	7	7	6	5	4
500J	16	15	14	14	13	12	11	10	9	8	8	7	6	5	4
600J (9mm)	17	16	15	14	13	12	11	10	10	9	8	7	6	5	4
700J	17	16	15	14	13	12	12	11	10	9	8	7	6	5	4
800J	17	16	15	15	14	13	12	11	10	9	8	7	6	5	5
900J	18	17	16	15	14	13	12	11	10	9	8	7	6	6	5
1000J (.357 Mag.)	18	17	16	15	14	13	12	11	10	9	8	8	7	6	5
1200J	18	17	16	15	14	14	13	12	11	10	9	8	7	6	5
1400J (.44 Mag.)	19	18	17	16	15	14	13	12	11	10	9	8	7	6	5
1600J	19	18	17	16	15	14	13	12	11	10	9	8	7	6	5
1800J (5.56mm)	19	18	17	16	15	14	13	12	11	10	9	8	7	6	5
2000J	20	19	18	17	16	15	14	13	11	10	9	8	7	6	5
2500J	20	19	18	17	16	15	14	13	12	11	10	9	8	6	5
3000J (.303)	21	20	19	18	17	16	14	13	12	11	10	9	8	7	6
3500J (7.62mm)	22	20	19	18	17	16	15	14	12	11	10	9	8	7	6
4000J	22	21	20	19	17	16	15	14	13	12	10	9	8	7	6
4500J	22	21	20	19	18	16	15	14	13	12	11	9	8	7	6
5000J (.338 Mag.)	23	22	20	19	18	17	16	14	13	12	11	10	8	7	6
6000J	23	22	21	20	18	17	16	15	14	12	11	10	9	7	6
7000J	24	23	21	20	19	18	16	15	14	13	11	10	9	8	6
8000J	24	23	22	21	19	18	17	15	14	13	12	10	9	8	6
9000J	25	24	22	21	20	18	17	16	14	13	12	10	9	8	7
10kJ (.460 Mag.)	25	24	23	21	20	19	17	16	15	13	12	11	9	8	7
20kJ	28	27	25	24	22	21	19	18	16	15	13	12	10	9	7

**Example** - If a TL9 weapon had an effective energy of 2000J, its AV would be  $2000J^{.15} \times (20-9)/3 = 11$ .

If you design conventional weapons at TL's of 16+, assume the AV goes up from TL16, not down (i.e. count TL16 as TL14, TL17 as TL13, etc.)



## Body Points

The Body Points (or BP) of a weapon are figured from the weapon bulk table on the previous page. Fractions are kept, and the total BP from all locations is added together, and rounded nearest.

**Example** - An S/2 weapon at TL11 would have 2.25BP per location, for a total of 4.5BP, which rounds to 5BP.

Each level of increased mass or cost for any reason (except reduced mass) will decrease the effective TL by 1 for AV and BP purposes (heavier or more expensive weapons have more), and each level of decreased mass or cost will increase effective TL by 1.

## Initiative

The Initiative of the weapon is how easy it is to swing into position, and move about in close or confined quarters. For instance, you can swing a light pistol to a certain arc faster than a heavy rifle. Initiative is function of weapon length and loaded mass in kilograms, but only if the ammunition is carried on or in the weapon (ignore external ammunition supplies). Ammunition carried in external magazines does not apply, but may encumber the character as any other dead weight would. See the table below.

Mass x Locations	Initiative	Typical for:
<.50	+4	very small pistol
.51-1.00	+3	small pistol
1.01-3.00	+2	average pistol
3.01-10.0	+1	machine pistol, large pistol
10.1-20.0	+0	submachine gun
20.1-40.0	-1	rifle, shotgun
40.1-80.0	-2	heavy rifle, large shotgun
80.0-160.0	-3	light machinegun
etc.		

Mass	Locations								
	1	2	3	4	5	6	7	8	9
.4kg	+4	+3	+2	+2	+2	+2	+2	+1	+1
.6kg	+3	+2	+2	+2	+2	+1	+1	+1	+1
.8kg	+3	+2	+2	+1	+1	+1	+1	+1	+1
1.0kg	+3	+2	+2	+1	+1	+1	+1	+1	+1
1.2kg	+2	+2	+1	+1	+1	+1	+1	+1	+0
1.4kg	+2	+2	+1	+1	+1	+1	+1	+0	+0
1.6kg	+2	+1	+1	+1	+1	+1	+0	+0	+0
1.8kg	+2	+1	+1	+1	+1	+0	+0	+0	+0
2.0kg	+2	+1	+1	+1	+1	+0	+0	+0	+0
2.5kg	+2	+1	+1	+1	+0	+0	+0	+0	-1
3.0kg	+2	+1	+1	+0	+0	+0	-1	-1	-1
3.5kg	+1	+1	+0	+0	+0	-1	-1	-1	-1
4.0kg	+1	+1	+0	+0	+0	-1	-1	-1	-1
4.5kg	+1	+1	+0	+0	-1	-1	-1	-1	-2
5.0kg	+1	+1	+0	+0	-1	-1	-1	-1	-2
6.0kg	+1	+0	+0	-1	-1	-1	-2	-2	-2
7.0kg	+1	+0	-1	-1	-1	-2	-2	-2	-2
8.0kg	+1	+0	-1	-1	-1	-2	-2	-2	-2
9.0kg	+1	+0	-1	-1	-2	-2	-2	-2	-3
10.0kg	+1	+0	-1	-1	-2	-2	-2	-2	-3

**Example** - If an S/2 weapon had a total loaded mass of 1.4kg, its mass x locations would be 2.8, so it would have an Initiative of +2.

## Recoil

In **3G<sup>3</sup>**, recoil modifiers are based on the DV of the weapon (if it has recoil). In some cases, this is inaccurate, like for low-powered or very heavy weapons with small projectiles. However, in most cases it serves. Always use the DV based on a full-bore projectile to minimize problems. How recoil is handled will depend on your system, but you might wish to add modifiers for increased or decreased weapon mass and quality, and whether or not the weapon is fired one-handed, two-handed or from a secure mount.

The base penalty for recoil is -5%, times (DV of weapon/Strength of user (in a d20 system)), rounding nearest. If both hands are used on the weapon, you usually multiply Strength by x1.5. Each level of increased mass (except from cheapness) should increase the Strength multiple by an additional x.5. In general, recoil of more than -50% will injure the firer if the force is taken against the hands or shoulder. The first damage will just be bruising, but higher DV's can produce recoil strong enough to cause serious injury or death (would *you* want to stand in the path of a recoiling artillery piece?).

**Example** - A DV20 weapon fired by a Strength 10 individual will take a -10% recoil penalty per shot. If both hands are used, effective Strength goes to 15, and recoil penalty goes to -5% per shot. If this weapon had one level of increased mass, a Strength of 10 would be counted as a Strength of 15.

# Conventional Weapons

## Gun vs. powder TL

Historically, between TL7 and TL8 there is a change in powder chemistry, from black powder to the more powerful nitrocellulose base propellants. The weapons that used nitrocellulose powder had different types of steel than older weapons, since the burning characteristics of the powder were markedly different. As an option, increase the unreliability of any TL7- weapon by *three* levels if it is used with TL8+ propellant, but you may use lesser quantities of the propellant to offset this *some-what*. This *does not* apply if the weapon is a modern *reproduction* of a TL7 weapon, *made with the correct steels*. It also does not make any difference in reliability if the TL8+ propellant is only used as warhead material, recoilless gun or rocket propellant.

If new, high energy cartridges are fired in old weapons designed to use the same type of ammo, they will work, but *in general*, increase malfunction chance by a row, like using TL11 cartridges in a TL9 weapon of the same caliber. To avoid this, design weapons for slightly more energy than they actually use.

## Bullpup vs. conventional stock

A "bullpup" design is a rifle in which much of the machinery and part of the barrel are placed inside the shoulder stock. This is more complex, but allows for a compact, lighter weapon with the same capabilities as a normal, longer rifle. Historically, this didn't happen until TL11, but could have been done at earlier TL's. In fact, there *are* commercial muzzle-loading rifles that use this design strategy. One reason *not* to do it is that the parts of the gun most likely to explode are now right next to the head of the firer, an important consideration for any weapon that has the possibility of catastrophic malfunctions.

## Advanced Design

At this point, you have covered all the basics of conventional weapon design. The last point for these designs is ammunition cost, which is on page 34. Advanced weapon design covers a number of less common or esoteric weapon types, and can get even more complex than the basic rules.

## Special Ammunition

The DV (penetrating ability) of a projectile may be modified by its shape and materials used in its construction. These may make it more or less effective vs. living creatures.

### Hollow point rounds

Hollow points are a type of projectile designed to deform in tissue and cause more damage. This makes them more effective against living creatures, but less effective vs. armor. Multiply the DV by x.7 before comparing it to armor, but multiply any damage that gets through armor by x1.8.

**Example** - A DV of 10 would go to  $10 \times .7 = 7$  before being compared to armor (even if there was none). Any portion of the DV that penetrated armor would be multiplied by x1.8, so if the target had no armor, the DV would be  $7 \times 1.8 = 13$  (about x1.25 on base DV).

### Armor piercing rounds

Armor piercing projectiles penetrate armor better, but leave cleaner wounds in tissue, for lower damage vs. living creatures. Any projectile that is sg7 is assumed to be armor-piercing. Multiply the DV by x1.5 before comparing it to armor, but multiply anything that penetrates armor by x.5. In general, the ability to negate armor-piercing projectiles is part or all of a TL behind the ammunition itself, e.g. TL10+ AP ammo pierces TL10- armor.

**Example** - A DV of 10 would go to  $10 \times 1.5 = 15$  before being compared to armor (even if there was none). Any portion of the DV that penetrated armor would be multiplied by x.5, so if the target had no armor, the DV would be  $15 \times .5 = 8$  (about x.75 on base DV).

### Exploding rounds

This is an optional subcategory of high explosive rounds. For small arms, the amount of explosive is miniscule, and designed to fragment the projectile inside the target, for increased tissue damage. Multiply the DV by x.5 before comparing it to armor, but multiply anything that penetrates armor by x3.0.

**Example** - A DV of 10 would go to  $10 \times .5 = 5$  before being compared to armor (even if there was none). Any portion of the DV that penetrated armor would be multiplied by x3.0, so if the target had no armor, the DV would be  $5 \times 3.0 = 15$  (about x1.5 on base DV).

### Discarding sabot rounds

These are a special subset of multiple projectile rounds. A heavy elongated shot is surrounded by a light sheath, which is discarded upon firing. The core is designed to have better range characteristics than a projectile of the full barrel diameter. Some energy is lost to the outer shell, or sabot (pronounced saa-bow), but the rounds are usually optimized to reduce the effect. Almost all sabots will be counted as having an sg of 1. Even though the sabot may be made from heavier materials, like aluminum (sg3), the sabot almost always has less mass than an equivalent diameter solid projectile (because the lower the mass, the less propellant energy will be wasted on it).

The sabot will have a fraction of the energy of the full assembly based on the fraction of the total mass it has, and the DV of the penetrator will be based on the subprojectile diameter and remaining energy. Subprojectiles can't be less than 25% of bore diameter. Figure the volume of a solid projectile at sg1, subtract the mass of a solid sg1 projectile of the penetrator diameter, and then add the penetrator mass. This is total projectile mass, and the muzzle energy is divided proportionately between the two.

**Example** - A 20mm weapon fires a 10mm discarding sabot round with a 10:1 l/w and an sg of 11. A 20mm 3:1 projectile has a mass of 16.8g, less a 10mm 3:1 projectile (twice to get the full length) for a sabot mass of 12.6g. To this is added the penetrator mass (83.5g), for projectile mass of 96.1g. The penetrator mass of 83.5g is 86.9% of the total mass, so the penetrator has 86.9% of the total muzzle energy.

### Multiple projectile rounds

For items like shotgun or flechette rounds, the RC and DV of the individual projectiles will need to be worked out separately. The total muzzle energy is divided by the number of projectiles to get the energy *per projectile*. This amount is used for figuring the DV, velocity and RC of each projectile. For recoil purposes, the total energy is used, and is applied to a full-bore projectile to get a DV that can be used to base recoil from.

Multiple projectiles may usually not be packed as densely as a single projectile. Assume that only 75% of the possible projectile volume can be filled with smaller projectiles, to take wasted space into account.

**Example** - An 18mm shotgun has a 2:1 l/w projectile of 7.63cc, so it can hold up to  $7.63\text{cc} \times 75\% = 5.72\text{cc}$  of shot. If this was 5mm 1:1 pellets, each one is .065cc, so it would hold  $5.72\text{cc}/.065\text{cc} = 88$  of them, and each would have 1/88th the muzzle energy.

If multiple projectiles are of differing masses, each one will get a fraction of the energy proportional to its mass, i.e. a projectile massing twice as much will get twice the energy.

### HE rounds

Modern explosive shells are usually designed as sg3 projectiles with a 3:1 l/w ratio. They have a penetration DV equal to a solid slug of that mass and diameter. Up to 75% of the projectile *volume* may be an explosive compound (use propellant energy for that TL). For shells of 20mm and less, it is simpler to just count the projectile as an exploding round. For shells larger than 20mm, count as regular projectiles with an additional, separate explosion or fragmentation effect.

The effective DV of the explosion depends on the filler material. Treat as propellant of that TL, and the DV of the explosion (at contact) as:

$$\text{Explosion DV} = (\text{Energy of filling}/40)^{-5}$$

**Example** - A 1,000g charge of TL11 propellant (1485J/gram) has an explosion DV of 193.

This DV will drop off with range according to the normal rules in whatever system the weapon is used in. HE rounds may also be fragmentation rounds at no additional mass penalty, but they will cost more. HE rounds have a minimum practical diameter, based on their TL. Below a certain size, it is no longer possible to make a reliable fuze mechanism. The lower size limit for reliable HE shells, shaped charges or exploding rounds is  $(20\text{-TL}) \times (10/\text{TL}) \times 2\text{mm}$ . Assume anything smaller has a 10% chance of failing to detonate.

### Shaped charges

Shaped charges are designed as HE rounds, but do 5 times the explosion *energy* to the impact point, which has a DV like a 1.0cm projectile. Shaped charges are always counted as being armor-piercing, but damage against living creatures is *not* reduced. The shaped charge DV is assumed to already be AP (do not multiply).

**Example** - An HE shell with an energy of 16,000J (explosion DV of 20), would do 80,000J to a target as a shaped charge. This would be a DV of 242 to the impact point, and the normal explosion damage to the surrounding area.

The penetrating ability of a shaped charge is based on the explosive material used, the charge configuration, and the diameter of the shaped charge. Shaped charges can be "stacked" to add DV's together, and each one adds to the cost of the round. A shaped charge warhead (or stack) can never have a DV of more than its TL, times the diameter of the largest charge in mm, times (TL-7)(minimum of x1), and an individual shaped charge gets no benefit from any quantity of explosive greater than a charge with a 1:1 l/w ratio, although any excess *would* count towards a regular explosive effect. *Note: The maximum DV has been altered from the first printing of 3rd ed.*

**Example** - A TL11 60mm shaped charge has a maximum possible DV of  $\text{TL11} \times 60 \times (\text{TL11}-7) = 2640$ . The largest effective *single* charge for this diameter only gives a DV of 785, or 30% of maximum. For a 200mm shaped charge, the maximum is  $\text{TL11} \times 200 \times (\text{TL11}-7) = 8800$ , and the largest effective single charge gives 4783, or 54% of maximum.

### Laser sights

A laser sight is an aiming device, historically available at TL11. It is built using the 3G<sup>3</sup> rules as a .005J continuous beam laser (5 milliwatt), with a 20,000 second (5.5 hour) battery, at the appropriate TL. The mass of these sights is below, and includes batteries, mounting brackets and switches. Cost for all of them is 300Cr. Note that at TL12+ the mass is low enough that any weapon can mount one at little penalty. TL12 is probably the first TL in which they are likely to come off the manufacturing line so equipped.

TL	Laser sight mass	Cost
8	2.14kg	300Cr
9	.57kg	300Cr
10	.22kg	300Cr
11	.11kg	300Cr
12	.06kg	300Cr
13	.05kg	300Cr
14	.03kg	300Cr
15	.03kg	300Cr

A laser sight is usually good only for fire in the RC1 or RC2 range brackets, as you must be able to distinguish the tiny laser spot at the range your target is at. A weapon with a telescopic sight would be able to use a laser sight (or laser designator) in the RC3+ range brackets.

The beam of a laser sight is normally invisible, but can be made visible by atmospheric disturbances like dust or fog. At any TL with electronic vision aids you can have laser sights tailored to that aid. For instance, a weapon with an infrared-sensitive sight could have an infrared targeting laser, so that normal human vision could not detect the beam under any conditions. At higher Tech Levels, the multiple frequency option can be used to have a sight that automatically adjusts to the frequency band of any vision aids used.

# Conventional Weapons

## Telescopic sights

These are not usually counted as part of accessories, and are a separate item. Historically, they appear during TL7, and reach modern form late in TL8. The table below gives "historical" guidelines for sighting aids. The sights below are designed for use on weapons with significant recoil (usually DV16+).

TL	Capability	Mass	AV
7	Fixed magnification	1.0kg	1
8	Fixed mag. (early TL8)	.80kg	1
8	Fixed mag. (late TL8)	.60kg	2
9	Variable mag.	.60kg	2
9	Active IR	2.0kg	2
10	Variable mag.	.50kg	2
10	Light intensification	1.7kg	2
11	Variable mag.	.40kg	2
11	Light intensification	1.0kg	2
12	Variable mag.	.30kg	2
12	Light intensification	.70kg	2
12	Thermal differential	2.0kg	2
13	Enhanced thermal	1.0kg	2
14+	?		

Exact capabilities of these sights are left to the mechanics of the game system the weapon is used in, but will generally be some bonus to hit, possibly linked to an aiming time modifier, like setting or bracing the weapon.

## Self forging warheads

These are a TL11 invention, and are a variation on shaped charge technology. An explosive charge acts against a metal plate, shaping it into an aerodynamic projectile, and simultaneously projecting it downrange. It is a cheap, albeit high-tech way of shooting a projectile from a remote location, like a self-guided or proximity fuzed round. A self-forging warhead is designed using all the restrictions that apply to shaped charges. You take 25% of the blast *energy*, and apply it to a sg7 projectile with 25% of the *charge* diameter. The aiming RC of the projectile is always 1, since there is no weapon barrel, and the damage RC is based on the projectile. The current use for these is as a "lock-on" submunition, with a proximity fuze which detonates the charge should it reach the ground without finding a target. The normal explosion effect is based on the full explosive charge, and a target can take damage from blast and fragments if close enough.

## Fragmentation rounds

These are designed like HE rounds, and will generally act like grenades. Grenades are simply projectiles that are thrown instead of fired, and always have an RC of 1/1. The damage RC applies only to impact damage, however (bonk!). Aerodynamic thrown objects have an IA of 1, and all others have an IA of 0. If you don't want to figure the exact mass of a fragmentation projectile, assume it is sg4 for muzzle velocity purposes, and sg3 for aiming RC purposes. This way, the added mass of the denser fragments may have an effect on accuracy.

Grenades are based on a default size of 60mm spheres. A 60mm sphere with one layer of fragments on the outer surface would have roughly the following stats.

Number of fragments on a 60mm sphere	2mm	4mm	6mm	8mm	10mm
	2500	700	300	150	100

Average hits on a standing human at	2mm	4mm	6mm	8mm	10mm
1m	100	28	12	6.0	4.0
2m	25	7.0	3.0	1.5	1.0
3m	11	3.1	1.3	.7	.4
4m	6.3	1.8	.8	.4	.3
5m	4.0	1.1	.5	.2	.2
6m	2.8	.8	.3	.2	.1
7m	2.0	.6	.2	.1	.1
8m	1.5	.4	.2	.1	.1
9m	1.2	.3	.1	.1	.1
10m	1.0	.3	.1	.1	.0

**Example** - A 60mm grenade covered with 4mm fragments will, on average, hit a standing human with 3.1 fragments at a range of 3 meters.

As you can see, a human-sized target (.5m<sup>2</sup>) will be hit with about 1/25th of the fragments at a range of 1m. This is quartered each time the distance is doubled. Random variation may change the number of hits. A simple variation is to add or subtract (flip a coin) 0-50% from the effective *range* for determining quantity (1d6-1) x 10%. For targets of other than human size, simply figure the approximate area compared to that of a human.

Fragmentation rounds or grenades larger than 60mm are more effective, smaller ones less so. Rounds less than 20mm will usually be treated as exploding rounds. For rounds of any other size, multiply the number of fragments by the  $2/3$  power (ratio<sup>67</sup>) of the ratio of projectile volume to the volume of a 60mm sphere (113cc). If dealing with spherical projectiles, doubling the diameter multiplies the fragments by 4.

Sphere size	Volume	Fragments	Approximate volume of
20mm	4.2cc	x.10	
30mm	14.1cc	x.25	20mm cannon shell (3:1 l/w)
40mm	33.5cc	x.45	
50mm	65.5cc	x.70	30mm cannon shell (3:1 l/w)
60mm	113cc	x1.0	40mm cannon shell (3:1 l/w)
70mm	180cc	x1.4	
80mm	268cc	x1.8	
90mm	382cc	x2.3	
100mm	524cc	x2.8	60mm mortar shell (3:1 l/w)
110mm	697cc	x3.4	
120mm	905cc	x4.0	
130mm	1150cc	x4.7	81mm mortar shell (3:1 l/w)
140mm	1440cc	x5.5	
150mm	1770cc	x6.3	
160mm	2140cc	x7.1	100mm artillery shell (3:1 l/w)
170mm	2570cc	x8.0	
180mm	3050cc	x9.0	
190mm	3590cc	x10.0	
200mm	4190cc	x11.1	120mm artillery shell (3:1 l/w)
250mm	8180cc	x17.3	155mm artillery shell (3:1 l/w)

**Example** - A 120mm sphere has 8 times the *volume* of a 60mm sphere. So,  $8^{67} = 4$ , giving the 120mm projectile 4 times the fragments of a 60mm projectile.

Fragments have a DV based on the energy you would get from any high explosive filling, divided by the number of fragments. You use this energy for blast effects as well.

**Example** - A 60mm projectile has a volume of 113cc. If it were TL11, and half filled with explosives, there would be 56.5cc of propellant, for a total energy of 83,900J. If the shell had 2,500 fragments, each with a diameter of 2mm, each one would get 33.6J. Each fragment would therefore have a DV of 11.

Fragments are usually designed to decelerate very rapidly, more so than would be indicated by a damage RC of 1 or 2. Irregularly shaped fragments will multiply damages losses due to range by 5. This would be referred to as an RC of 1f or 2f. Fragmentation rounds also do normal impact damage, based on diameter and projectile energy, in case the round fails to detonate for some reason. You can avoid tedious calculations for fragmentation rounds by applying the basic formulas for pellet quantities and explosive charges to the grenades in the system you currently use.

**Example** - Volume increases with the *cube* of the radius, while surface area increases with the *square*. A grenade twice the diameter will have 8 times the explosive, but only 4 times the fragments. So, you would base fragment DV on the square root of 8/4 (since DV is based on square root of energy, and there is 8/4 times the energy *per fragment*).

**Stacked projectiles**

A round may have up to three projectiles stacked on top of each other in the shell casing. These are usually called “duplex” or “triplex” rounds. The main purpose is to increase the chance to hit, at the sacrifice of stopping power. For cartridge design, these are usually counted as spherical projectiles, and their *total* mass and volume is used when determining powder capacity, casing mass and other factors. The projectiles are considered individually when determining RC. The DV is based on their diameter, and fraction of the muzzle energy that they have. Usually, they are of equal mass, and split the energy equally. For getting multiple hits, assume each *extra* projectile gives a -10% chance to hit *per* projectile, so a duplex round would have a -10% on each projectile, and a triplex round would have -20% on all three.

**Smoke and gas**

Payloads or filler that fill a volume with some substance will have an effective radius in meters of roughly (volume in cc)<sup>.33</sup>. At half this radius(n), effects are doubled, and from the outside the radius to double the radius(n), effects are halved. Explosive bursting charges (1/10th payload volume) will fill the area instantly, while slow release by burning will expand out at about 1 meter per second. Actual effects of the payload will vary with Tech Level and game system used, lower TL's generally having a more erratic pattern of distribution.

Volume	x.5 radius	x1 radius	x2 radius
10cc	1m	2m	4m
20cc	1m	3m	5m
30cc	2m	3m	6m
40cc	2m	3m	7m
50cc	2m	4m	7m
70cc	2m	4m	8m
100cc	2m	5m	9m
150cc	3m	5m	11m
200cc	3m	6m	12m
300cc	3m	7m	13m
400cc	4m	7m	15m
500cc	4m	8m	16m

**Example** - A 60mm spherical grenade has room for 100cc of filler and a 10cc bursting charge. So, a 60mm tear gas grenade will have a primary burst radius of 5 meters. Anyone within 2 meters will take double effect, and anyone outside of 5 meters, but within 9 meters will take half effect.

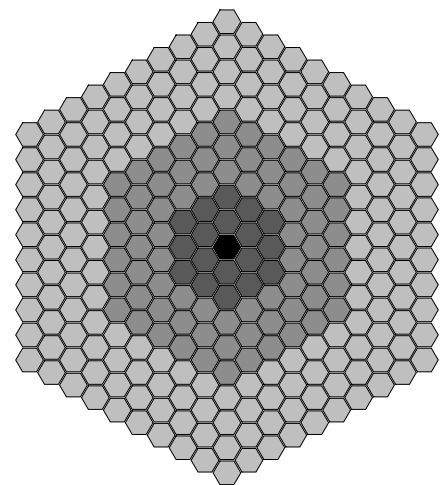



# Conventional Weapons

## Longarms vs. Pistols

While there is no technical reason for it, pistols cost as much or more than equivalent rifles. That is, a high quality hunting rifle will cost about the same as a high quality 9mm pistol, despite the rifle being more accurate, larger and more powerful.

In a more practical sense, rifles, shotguns and other longarms are assumed to be fired using both hands, and can be braced against the shoulder, while pistols can be fired using one or both hands, but cannot be braced against the shoulder.

The problem of how to design and use a given handheld weapon may be resolved as follows:

The *maximum* possible aiming RC of any handheld weapon is 1, plus the number of bracing points used. That is, a pistol fired from one hand could use an aiming RC of 2, a pistol fired using both hands could have an aiming RC of 3, and a rifle fired using both hands and a shoulder could have an aiming RC of 4. Theoretically, a rifle using both hands, a shoulder and a braced mount like a bipod or bench rest would have a maximum aiming RC of 5.

Note that this does *not* affect the weapon itself, only the degree of accuracy with which it can be used. If you try to fire a RC4 rifle one-handed, no matter how good the rifle is, you would use the RC2 table for range effects on the chance to hit. Likewise, an RC3 rifle would still be an RC3 rifle, even if you were using a bench rest.

In order to be braced against the shoulder, and held in both hands, a weapon will have to be at least a size of 4 (46-60cm long). This affects its concealability, etc. A weapon which can be used in multiple ways is bought using the *most* expensive of those ways. So, a pistol with a detachable stock that lets it be shoulder-fired would be bought using the cost for a *pistol* with a extended stock, *not* a rifle with a detachable stock.

**Low-tech reliability** - As an option to represent the physical quality of low-tech weapons, assume the maximum reliability class of a firearm is (7-TL).

## Shotguns

A shotgun is designed as a slug-thrower. That is, design the weapon as though it fires a spherical, 2:1, or 3:1 lead or steel slug. When the design is complete, you can figure out the number of smaller projectiles the weapon can fire. This is equal to 75% of the *volume* of the slug in smaller projectiles (packing losses). Total projectile mass is considered to be the same as a slug of that size due to other packing materials. The actual number varies, based on the bore of the weapon and size of the projectiles. Some combinations will be inefficient, like trying to stack 7mm projectiles in a 10mm barrel. Projectiles more than half the diameter of the barrel will reduce packing efficiency to 50% instead of 75%.

Lead projectiles must be spherical. Steel ones may be any shape. Note that flechettes (10:1 l/w) cannot be longer than the slug they are replacing.

**Example** - A 10mm shotgun can fire an iron 2:1 slug with a mass of 9.16g. 75% of this is 6.87g. So, the weapon could also fire 15 iron 5mm spherical projectiles, each with a mass of .458g (15 x .458g = 6.87g). Or, it could fire 13 iron 2mm flechettes. It could not fire 3mm flechettes, as they would be 30mm long, and the slug they replace is only 20mm long.

The range characteristics of the shot must be figured for each type of ammunition. See the table below.

Diameter	lead pellet (sg11)		steel pellet (sg7)		steel flechette (sg7)	
	Mass	Damage RC	Mass	Damage RC	Mass	Damage RC
2mm	.046g	1	.029g	1	.425g	3
4mm	.369g	1	.235g	1	3.40g	4
6mm	1.24g	1	.792g	1	11.5g	5
8mm	2.95g	1	1.88g	1	27.2g	5
10mm	5.76g	2	3.67g	1	53.1g	6

Rules for pellet hits must be taken from your game system, with a maximum number of hits equal to the quantity fired. The following table gives *rough* percentages of pellet hits within an 80cm circle using a full choke. This circle has an area of about .5m<sup>2</sup>, about equal to the silhouette of a standing person.

Range(m)	Hits in 80cm circle
1-13	100%
14-20	95%
21-30	85%
31-40	70%
41-50	55%
51-70	30%
71-100	15%

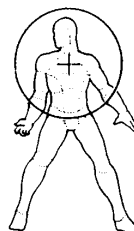

Random variation is no more than the square root of the total number of pellets, i.e. 400 pellets would vary by +/-1d20. At close range, shot may still be in a dense formation that approximates a slug. Count the DV as being that of a slug, multiplied by 4/range, with a maximum of normal DV.

**Example** - At a range of 6 meters, you could either count the attack as a large number of individual hits, or as a single hit with a DV of 4/6 that of an equivalent slug.

As a rough reference, count pellets with a volume of more than .300cc (8.3mm diameter) as #00 Buckshot. Ones from .230cc to .299cc (7.6-8.2mm) are #1 Buckshot, and ones from .100cc to .229cc (5.8-8.1mm) are #4 Buckshot. For reference, 1:1 l/w lead slugs for current (TL9-12) shotguns are below.

Shotgun	Approximate bore	Slug mass	Damage RC	TL11 energy
10ga	19.5mm	42.7g	3	2700J
12ga	18.5mm	36.5g	3	2300J
16ga	17mm	28.3g	2	1800J
20ga	15.5mm	21.4g	2	1400J
.410ga	10mm	5.76g	2	400J

### Combined weapons

Multiple barrel weapons using the same ammunition source will need less mass for the receiver and accessories. Each additional receiver has 50% the mass of the previous one. Weapons with multiple feeds for different ammunition types have receivers massing 25% more *per extra feed*, and need multiple clips or ammunition storage areas. Combinations of the two multiply together.

The advantage of multiple barrels feeding from the same ammunition sources is that for rate of fire purposes, the ROF is computed on a per barrel basis, but for total number of shots fired, you add the ROF from all barrels together.

Barrels	Receiver mass	Ammo feeds	Receiver mass	Combination	Receiver mass
1	x1.00	1	x1.00	1 barrel, 2 feed	x1.25
2	x1.50	2	x1.25	2 barrel, 2 feed	x1.88
3	x1.75	3	x1.50	3 barrel, 2 feed	x2.19
4	x1.88	4	x1.75	3 barrel, 3 feed	x2.62
5	x1.94	5	x2.00	6 barrel, 2 feed	x2.46
6	x1.97	6	x2.25	6 barrel, 3 feed	x2.96

**Example** - A weapon with two barrels has x1.5 receiver mass. A weapon with three barrels has x1.75 receiver mass. A three-barreled gatling gun with dual ammo feeds would have  $(1.75 \times 1.25) = x2.19$  receiver mass.

Full barrel mass applies for each barrel, but the mass of accessories is based on the heaviest barrel and the modified receiver mass. A malfunction is based on the receiver, not the barrel, so a jam will affect all barrels.

For multiple barrels of different calibers, or multiple barrels using separate receivers, each receiver is bought separately, but the weapon with the lower DV will have a receiver massing half as much, to reflect common components. If the larger DV is more than double the smaller one, there are no mass benefits at all. Since receivers are separate, a malfunction on one will not affect the other.

**Example** - A DV40 spotting rifle gets no benefit if mated to a DV200 cannon, since the disparity in size means there are no shared parts. However, a DV30 shotgun and a DV50 rifle would share parts, for a mass savings.

### Pepperboxes

These are small, revolver type weapons where each chamber of the cylinder is long enough to be a barrel, and none of the chambers have a common barrel. They are historically TL7-8 weapons, usually with percussion ignition systems. They should not be designed as revolvers, but as multiple barrel single shot weapons using a common receiver, with a rate of fire like a revolver.

### Lemon Squeezer

This is a nickname given to a type of concealable pistol developed during late TL7-early TL8. It was usually a revolver-type weapon with 5-6 shots, fired by squeezing the hand. The barrel protruded between the firer's fingers, and the shells were held not in a cylinder, but radiated outward from a central hub. Since they had no sights and very short barrels, they cannot have an aiming RC or IA of more than 1.

### Duckfoot

The name given to a weapon used in the TL6-TL7 period. Usually an SS/3 or SS/4 action, all barrels were fired by a single trigger pull. The barrels were spread at an angle, like the bones in the foot of a duck, hence the name. The weapon was meant to be a deterrent against a small group of foes. Against a primary target, normal aiming modifiers apply, but vs. secondary targets, count the shots as firing from the hip.

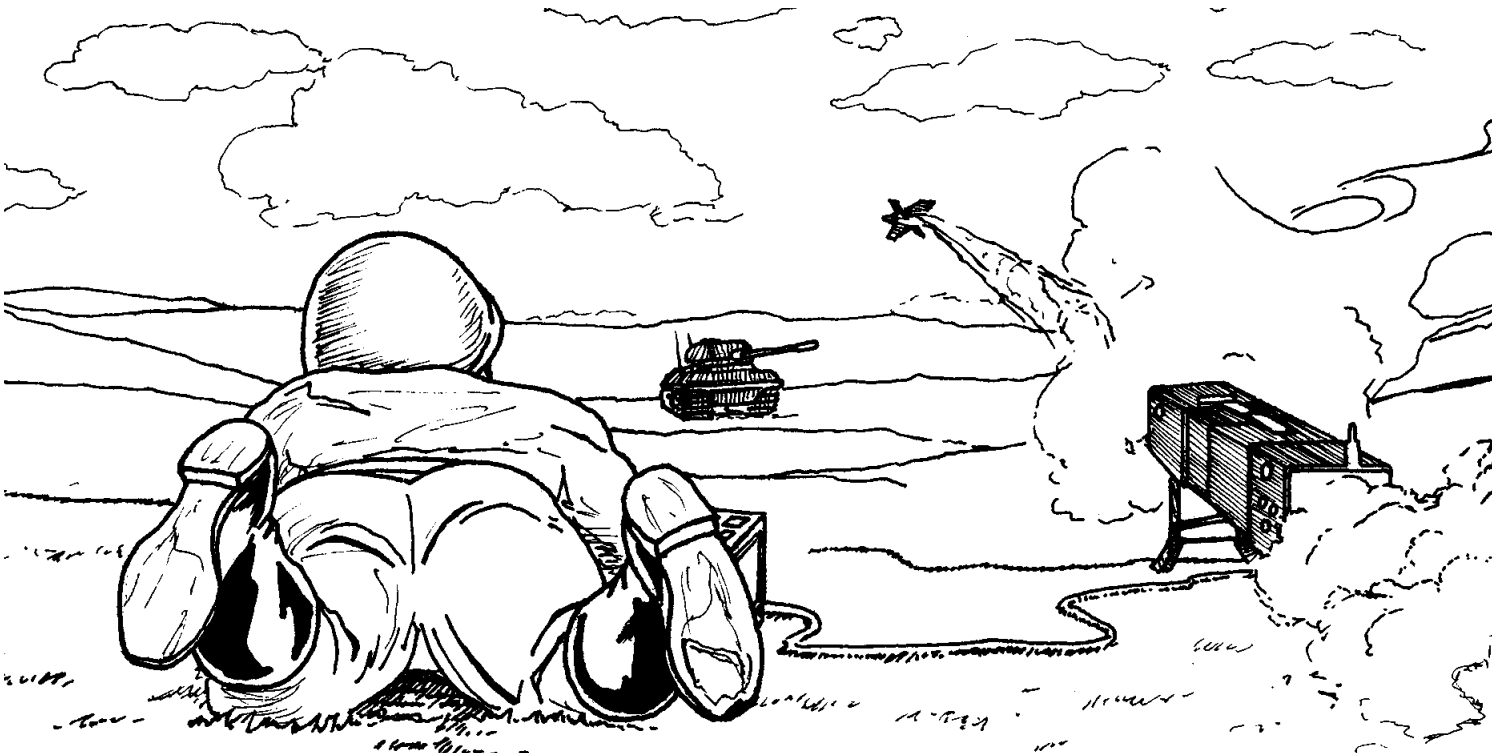

# Conventional Weapons

## Mortars

Mortars are generally not covered in detail by the 3G<sup>3</sup> rules, but can be designed. They will work best as disposable casing rounds with fairly low velocities, large bores and HE or fragmentation payloads. The shell “casing” is easily increased or decreased in size to get different ranges, and the weapon is designed to withstand the largest propellant charge regularly used. Use the maximum range for projectile velocity as the extreme maximum range of the weapon, and assume flight time to this distance is (muzzle velocity/5) seconds (so correcting aim for misses take time for each previous shot to land).

**Example** - A mortar with a muzzle velocity of 100m/sec and a 1kg shell has a theoretical range of  $(100\text{m/sec})^2/10 = 1,000\text{m}$ . Each shot of indirect fire at this muzzle velocity will take 20 seconds to arrive on target.

Mortars are usually single shot, but can be semi-auto. Mortar shells may be self-guided, but mortars cannot be smart weapons, and cannot directly control user-guided projectiles, although they could fire projectiles that would be controlled from somewhere else (like laser designated shells).

## Add-ons

This term applies to any projectile (usually HE, HEAT or frag) which is fired by sticking it on the end of a normal weapon. The maximum RC for range purposes will be that for its mass, and for aiming, based on velocity and type of projectile. Odd cases like add-on rocket assisted rounds combine velocity from each part for aiming RC purposes, and subtract 1. Add-ons always have an IA of 0.

**Example** - A 3,500J charge is used to fire a 1,000g rifle grenade. For aiming, the formula gives 83.9m/sec, which for a 3:1 grenade is an aiming RC of 1. The range formula gives a range (theoretical) of 721m, reduced to 216m by its sg of 3 (see p.13). This could be increased by using high powered “blanks” which contain only propellant. A 7,000J charge would increase the velocity to 116m/sec, the aiming RC to 2, and substantially increase the malfunction chance. Recoil would also be increased by 1.4, since DV is based on square root of energy, and the energy has been doubled ( $2^5 = 1.414$ ).

## Multiple caliber weapons

Some weapons have interchangeable barrels and clips, allowing the weapon to be converted from one caliber to another. Usually this is so you can practice using less expensive ammunition, while keeping the “feel” of the original weapon. The weapon must be designed with a mass to accommodate the *most energetic* (not necessarily highest DV) round, and will cost 10% extra.

**Example** - A revolver designed to fire .44 Magnum, .357 Magnum and .38 Special rounds must be designed to withstand the stress of the .44 Magnum round.

Conversion kits cost half the weapon cost, and consist of a new barrel, magazine, and maybe a few other small parts. The mass of the weapon will change by the difference, and this may affect weapon Initiative. The time required to change from one caliber to another will vary, but a good guideline is  $(\text{DV of most powerful round})^2/10$  seconds. Subcaliber devices inserted into the bore of a weapon *add* mass, and take  $(\text{DV of smaller round})^2/10$  seconds to install.

**Example** - A DV20 conversion on a DV50 rifle will take  $50^2/10 = 250$  seconds to install. To mount a DV50 training gun inside a DV300 cannon barrel will also take 250 seconds to install.

## Gyrostabilization

Any ranged weapon may be gyro-stabilized. This will add  $(20\text{-TL})/2$  percent to the *overall* mass of the weapon (heavier weapons require heavier gyros), and is only possible at TL9 or better. There is also a minimum mass for *any* gyrostabilization unit of  $(20\text{-TL}) \times 50$  grams.

TL	Percent extra mass for gyro	Minimum mass	Minimum power per minute
9	5.5%	550g	33kJ
10	5.0%	500g	30kJ
11	4.5%	450g	27kJ
12	4.0%	400g	24kJ
13	3.5%	350g	21kJ
14	3.0%	300g	18kJ
15	2.5%	250g	15kJ

Hand weapon gyrostabilization operates on 6 gyros, with two contrarotating gyros on each axis, near the weapon’s center of gravity. Pressure switches, inertial sensors or built-in targeting computers speed up or brake certain gyros, depending on how the weapon is moved, helping the user change it from facing to facing. If the weapon is not being pivoted, the gyros tend to keep the weapon pointed in the same direction, regardless of firer motion, like running. For vehicle mounted weapons, a gyro tends to cancel out the effect of terrain irregularities while the vehicle is moving.

A gyro system will halve negative movement modifiers on firing, but automatically makes the Initiative of the weapon 1 point worse. You could use a variant of gyro rules to counteract recoil (like contragrav recoil nullifiers).

Gyroscopes use a minimum of 1J of energy per 100g of gyro mass per second, which must be supplied by a battery or other power source. This power source is not included in the mass of the gyro. Gyros cost 2,000Cr per kilogram, with a minimum cost of 500Cr. Stopped gyros need to “warm up”, and the time this takes is equal to the square root of the gyro mass in grams. During the warm-up time, the gyro is of little or no benefit.

**Example** - A 900g gyrostabilizer requires 30 seconds to warm up from a cold start.

### Binary propellant

Weapons that use liquid propellants will be treated as “loose propellant”, but the DV can be adjusted by metering the propellant. Weapons may be “soldier-proofed” by having few or no adjustment settings.

All the different energies must be computed in advance, since they will have different RC's, DV's and recoil effects, and the propellant used will alter the number of shots per clip. If the propellant tank is internal, and the projectiles in a detachable magazine, there may be mass savings, and a liquid propellant weapon could probably be adjusted to give a “blowtorch” mode, which would burn off a certain number of Joules per second. Divided by 100, and based on weapon bore, this would give a continuous cutting DV (like a continuous beam laser for damage effects), useful for prodding or crowd control, or perhaps as a maneuvering jet in zero-g conditions. If the torch were concentrated on a point for an entire second, you could multiply DV by up to 10.

**Example** - A 5mm weapon which burned 1,000J per second of fuel would get 10J applied to a bore of 5mm, for a DV of 4 if swept over an area, or up to 40 if used to burn a hole.

Metered propellant may be used to exceed the designed DV of a weapon, at the risk of catastrophic malfunctions. For instance, if you double the energy, you increase DV by  $2^{-5}$ , or 1.414. So, if DV was increased by  $\times 1.414$ , you would only get half as many shots, and each one would be using a malfunction chance based on double the normal propellant use. This is entirely at GM option.

Compressed air weapons are designed as binary propellant weapons, using a propellant energy of 10% of that of regular propellant at that TL(n).

**Example** - A TL11 compressed air rifle would be designed as though the “propellant energy” were 149J per gram.

### Recoilless rifles

A recoilless rifle is defined as a projectile weapon where the entire powder charge is burned in the barrel, but where the recoil from the projectile is countered by venting most of the powder energy in the opposite direction. This allows you to fire large projectiles at a reasonable velocity, something not ordinarily possible because of recoil. (Note: A weapon with a recoil modifier of more than -10 will do damage to the firer. In **TimeLords** terms, each -10 from recoil counts as a Damage Level of 1, or a DV of 3. You could substitute minimum damage in other systems instead).

A recoilless round is usually designed as a cased round with a disposable casing, and the weapon as a single shot action to save mass. The projectile only receives 25% of the powder energy, after action efficiency is taken into account, and before losses or gains due to barrel length are taken into account. For quick reference, 25% of the energy halves the DV and muzzle velocity. The other 75% of the energy is vented as backblast, which has a DV of (wasted energy)<sup>25</sup>, which falls off in a 30° cone behind the weapon. This damage is reduced like it was an explosion, in whatever system you use, but since it is directed you double the range increments.

**Example** - 1,000,000J of waste energy would have a DV of 32, so anyone standing directly behind the weapon would take a flame-based DV32 attack. If explosion effects in your system are halved each hex, for the backblast they would be halved every *two* hexes.

The receiver of a recoilless weapon is based on 25% of the powder energy. Barrel *length* is based on the full propellant charge, but barrel *mass* is only 5% of the calculated amount to reflect the much lower stresses it is under.

**Example** - A TL11 50mm recoilless rifle using a 1,000g powder charge has a total energy of 1,485,000J. The receiver is based on 25% of this, or 371,350J, for a SS receiver mass of 8,715g. A barrel for 1,000g of propellant and a 50mm bore will be 163cm long, and have an adjusted mass of 8,938g. Accessories would mass 20% of the (barrel + receiver), for 3,530g, and a total unloaded weapon mass of 21.2kg.

### Disposable weapons

It is possible to design and build weapons that will work reliably for a small amount of time, and then begin to risk catastrophic failure with repeated use. Note that this is different from “cheap”. A cheap weapon may be unreliable, but never get any worse, while a disposable weapon may be extremely high-tech and expensive, but have a limited number of uses. In the context of **3G**<sup>3</sup>, disposable weapons are those whose reliability is reduced because of less attention to safety limits, usually in the form of reduced mass. In game terms, a disposable weapon might be a one-shot launcher of some type, or a weapon whose construction has some game specific effect, like invisibility to metal detectors, at a cost of long term reliability.

A disposable weapon of this type automatically has one increased level of unreliability, one level of reduced mass (25% less), and  $\times 2.0$  cost. The weapon will *permanently* gain another level of unreliability each 50 shots. Each level of reduced mass bought for the weapon will double cost, quarter the number of “safe” shots that can be fired (no change in reliability), with a maximum reduction in mass of three levels. So, you could buy a weapon with 50% mass and 12 “safe” shots, or down to 25% of original mass, and a maximum of 3 “safe” shots (and  $\times 8$  cost!). How “safe” the shots are depend on the original reliability of the weapon. A weapon with an “invisibility” to certain types of sensing equipment is a separate cost multiple of at least  $\times 2$ , depending on the sensing technology and TL of the weapon in question.

**Note** - Reduced mass for a weapon only reduces the mass and increases the cost of the weapon and empty magazine, *not* the ammunition, sights or other added features. A disposable rocket launcher still uses full mass, normal cost rockets, for instance, and may have a normal cost and mass telescopic sight that is transferred from weapon to weapon. Note also that the reliability factor applies separately to multiple weapons combinations. A two-barrel gun would apply reliability separately to each barrel, depending on how many times that barrel had been used.



# Conventional Weapons

## Problems

The rules for rockets are touchy, and work well only if the rocket follows the l/w ratios available. Many payload carrying rockets tend to run into problems.

**Example** - The warhead of an RPG-7 is 85mm in diameter, but the rocket motor is only 38mm. Designing the whole rocket at 85mm would make it much too heavy, and designing it at 38mm would make the warhead far too small.

If the payload and rocket diameter are different, they must be designed as separate components. The mass of the assembly is used for velocity, etc. For RC, the l/w ratio of the combination is based on whichever subassembly is heaviest. Irregular l/w ratios round nearest, *except for determining maximum velocity, which is based on the exact l/w ratio of the combination.*

**Example** - A 7.0cm sg1, 2:1 warhead is mated to a 4.0cm sg1, 10:1 engine for a TL10 weapon. The warhead volume is 449cc, of which 337cc (75%) is the sg1 payload (337g) and 112g is sg2 inert structure (224g) for a warhead mass of 561g. The engine volume is 486cc, of which we'll say 75% is the 365g of sg1 propellant and 121cc is the sg2 structure (242g) for a total of 607g and a total rocket/warhead mass of 1170g.

The *rocket* diameter is used for maximum velocity, since it is the heaviest. We say the rocket has 365g of propellant, which gives a launching force of 9,855J. Applied to the total assembly, this gives a base velocity of 130m/sec. The total length (54cm), divided by rocket diameter (4cm) gives an l/w of 13.5. The final velocity is multiplied by the  $(\text{diameter in cm}^{-5}) \times (\text{l/w ratio}/10) = 2.7$ , for an adjusted velocity of 351m/sec. The damage RC is based on the mass of the whole assembly (1170g) and the warhead diameter (70mm), since it has the most drag. The rocket has a final RC of 4/4.

The barrel mass of a rocket weapon may be based on the diameter of the payload, and the whole rocket fits inside, *or* on the engine diameter, in which case the warhead sticks out, and maximum *effective* barrel length is equal to the motor length. A minimum of 80cm is suggested to let the firer spray backblast over their shoulder rather than in their face.

While recoilless rifles do not have recoil (obviously), they have significant muzzle flash and backblast, so if the weapon can fire more than one shot, apply the minimum consecutive shot penalty in your system.

**Note** - Since recoilless weapons have around half the DV of their full-mass counterparts, they often use HE, frag, HEAT or other payloads to make up for it.

## Rockets

Rockets and rocket-assisted projectiles are a subclass of conventional weapons with their own special (and somewhat obnoxious) rules. Rocket projectiles launch themselves with a constant force, rather than the explosive push of a conventional propellant charge. A rocket contains all the propellant *in* the projectile, rather than having a separate casing. The limit on propellant quantity plus payload is 75% of the rocket's volume. Rockets are counted as sg2 weapons, but they may have part of their volume at lower (guidance) or higher sg. The 25% of non-payload volume in a rocket is always counted as sg2.

Since almost all the stress is placed on the projectile, the receiver, barrel, etc. can be very light. However, since the propellant gases expand in the open air rather than the confines of a barrel, they are much less efficient. A rocket projectile only gets velocity from 2% of the propellant energy. A total of 10% of the propellant energy is blown backwards on firing, with backblast similar to a recoilless rifle. Recoil for rocket weapons is negligible, but the backblast may create consecutive shot penalties.

**Example** - A 1,000g propellant charge pushing a TL11 rocket has a base energy of 1,485,000J. Only 29,700J of this counts towards accelerating the rocket, and 148,500J counts as backblast.

Rockets get a -1 row shift for reliability. That is, since the propellant doesn't all go off at once, you can cram more in with less chance of catastrophic failure. For instance, if using 100% of capacity, you would count malfunctions as being on the 80-99% row. Payloads in general *may* be treated the same way for malfunction purposes, especially if bought with reduced cost.

The receiver of a rocket weapon is based on 2% of the propellant energy. Rocket weapons do not *require* any barrels, but barrel length *does* apply for the aiming RC of an *unguided* weapon, however. Barrel mass is 2% of the *mass* for the *full* propellant charge. Note that the receiver is based on 2% of *energy*, while the barrel is based on 2% of *mass*.

The figures above apply to rockets which do not contain any of the backblast. Rockets with closed barrels are designed like recoilless rifles, but the rocket will continue to accelerate upon leaving the barrel. Any extra velocity is equal to the base velocity of that rocket. Rocket weapons designed to direct the blast to the sides use x1.5 barrel mass, and those designed to deflect it back forwards will have x2.0 barrel mass.

The distance in meters it takes a rocket to reach maximum velocity is equal to the *base* barrel length for the full propellant charge, times the l/w of the rocket *engine*, times 20.

**Example** - A 3:1 rocket that "needed" a barrel length of 30cm (.3m) would need  $(.3\text{m} \times 3 \times 20) = 18$  meters to accelerate to full speed.

Rockets will have a different terminal velocity than shown by the basic formula. Adjustment is based on the cross-sectional area and l/w of the rocket as a whole. Find the base velocity for the effective energy (2% of normal), and multiply by:

$$\text{Diameter in cm}^{-5} \times \text{l/w ratio}/10$$

**Example** - At TL11, a 1,000g propellant charge will impart 29,700J to a rocket. An 8.0cm rocket (sg3) with a 3:1 l/w ratio would mass 3,220g. According to the formula on page 10, the base velocity would be 185m/sec. However, the adjustment factor is  $8^{-5} \times 3/10 = .85$ , so the true maximum velocity is 157m/sec.

**Note** - You can use the rocket rules as a way to design "torpedoes", assuming that something other than a rocket engine is used. Velocity would be 1/50th the calculated amount.

The range at which the rocket reaches maximum velocity is counted as the “muzzle” for range effects on impact damage. So, if the rocket reached maximum velocity at 20m, you would subtract 20m from the actual range to see what any impact losses would be. If the rocket is still accelerating, multiply the impact DV by the square root of the fraction of distance covered (from the receiver). For instance, if the rocket takes 20m to accelerate, then at a range of 5m, the impact DV is  $5/20^5 = 50\%$  of normal.

Shaped charge warheads are designed for maximum efficiency at a given velocity, and if the rocket has not yet reached that velocity, any shaped charge effect is reduced by this amount as well. Fragmentation and HE warheads are unaffected, but may be designed with a minimum arming distance to protect the firer at no additional charge.

### Booster charges

A rocket may have multiple stages. The velocity given by each stage *adds* to the total velocity of the rocket, and each stage drops off once used, reducing rocket mass for the subsequent stages. Boosters may also be used to give a rocket an initial “push” out of the firing tube, and the main motor ignites safely downrange, where the backblast is less important. Rockets without boosters will probably have blast shields, which is included in the accessory mass for the weapon.

### Range Class

The damage RC of a rocket is based on mass and diameter, as for other projectiles. Aiming RC is based on velocity and l/w ratio, *if the launcher has a barrel at least as long as the base barrel length*. If shorter or non-existent, aiming RC is reduced by 1, with a minimum of 1 (the “bottle rocket” principle). A rocket or rocket-assisted shell with *any* amount of guidance takes *no* penalty for shorter barrel length. *Guided anti-tank rockets are in use where you simply lay them on the ground pointing in roughly the right direction, set up the guidance module, and fire!* For self-guided rockets, it is more convenient to have the whole package (launcher and rocket) in one piece, which necessitates a barrel to protect the user from backblast.

### Rocket-assisted projectiles

These are designed as a normal round for a normal weapon, but the projectile is also designed as a rocket. The velocity from the rocket adds to the normal projectile velocity before aiming RC is calculated, and the energy of the rocket (2% of propellant) is added to projectile energy for figuring DV. This is usually only effective with large projectiles, and the extra benefits are slight.

### Penetrators

As mentioned before, the payload of a projectile is 75% of the volume. This space must be split between propellant, payload, guidance, etc. Rocket propelled or assisted rounds may only be inert armor-piercing if less than 50% of the volume is used, *and* the entire projectile is counted as sg7 instead of sg3, like most rockets.

### Folding barrels

A common tactic to make a rocket weapon shorter is to make the barrel in two pieces which fold or telescope. In general, this halves barrel length, adds 10% to barrel mass, and requires (loaded mass in kg x 10)<sup>5</sup> seconds to prepare for firing.

### Example

A 4.0kg launcher with telescoping barrel will require  $40^5 = 6$  seconds to prepare for firing, and 6 seconds to disassemble for transport. A 500kg system with extendable launch rails will take  $5,000^5 = 71$  seconds to prepare or disassemble.

### Parachutes

A delay mechanism like a parachute will take up 25% of the space of the warhead it is supposed to slow down. So, a 1,000cc warhead would require 250cc be devoted to a parachute if it required one. This includes any machinery needed to eject the parachute or separate a warhead from part of a larger assembly. A parachute can lower the descent velocity of the payload to not less than 1m/sec, and descent speeds above this may be chosen at designer preference.

### Illumination charges

These are warheads that produce light over a time period, rather than heat and pressure virtually instantly. Use 1,000 times the energy for the charge, but assign a “burn time” of up to 100 seconds, and divide the warhead energy by the same amount. The resulting energy in J per second is compared to the distance to the ground to get the illumination potential. Illumination at ground level is assumed to be a circle twice as wide as the flare is high, quartering the illumination each time the radius is doubled.

Distance	Divide energy by
1m	12
2m	50
4m	200
8m	800
15m	3,000
30m	11,000
60m	45,000
100m	125,000
200m	500,000
400m	2,000,000
700m	6,000,000
1,000m	12,000,000

Energy/m <sup>2</sup>	Equiv. illumination
1,000	Bright sunlight
500	Cloudy day
300	Heavy overcast
50	Full moonlight
25	Half moonlight

**Example** - A TL11 rocket flare with 100g of illuminating composition and a burn time of 20 seconds would put out  $(100g \times 1,000 \times 1,485J)/20$  seconds = 7,425,000 light units per second. If launched to an altitude of 100m, it would provide an illumination of  $7,425,000/125,000=59$  units per square meter, a little more than full moonlight.



# Conventional Weapons

## Historical guidance types

TL9 is where the first guided weapons show up, and there were several varieties being experimented on or used by the end of WWII.

By the end of the war, most capital ships were equipped with radar, which was not a direct guidance system, but which was used to manually provide targeting information for the main guns. Germany had developed wire-guided missiles, radio controlled missiles and glide bombs with TV cameras in the nose. The United States had also developed weapons in the latter two categories. All of these would be considered user-guided projectiles. The largest German model massed over 1500kg, had an air-launched range of about 5km (assume it was a TL10 design), and was credited with sinking cruiser-size naval vessels.

The first radar-directed guns (anti-aircraft) were at TL10, as were the first heat-seeking missiles, including basic ones that are man-portable (although not that useful). Passive, semi-active and active homing are all in use by the end of TL10.

TL11 developments are improvements on previous weapons, and introduction of a new generation of cruise missiles. These are almost outside the scope of this supplement, but it is worth noting that internally guided weapons date back all the way to WWI, so the idea is nothing new. The accuracy gained is.

## Guidance precision

At TL9, a guidance type can indicate presence or absence of a signal, like "yes, there's a blip on the radar screen", or "no, there isn't". At TL10, extreme differences in signal can be detected and filtered with limited success. Heat seeking missiles may or may not lock onto the sun instead of a jet engine. At TL11, extreme differences can be reliably filtered, and limited differentiation of targets is possible. For instance, a radar-guided missile could be programmed to ignore targets above or below a general size range. TL12 allows finer differences in size, and some differentiation of target characteristics, such as an optical sensor being able to recognize the silhouette of an enemy ship. TL13+ will simply refine this to greater levels, with better quality sensors and more computing power to analyze signals.

## Guided weapons

This term applies to any weapon which has a targeting enhancement in the weapon, projectile or both. These can distinguish between target and background, and maneuver the weapon or projectile so as to increase the chance to hit. Guidance systems will have an sg of 1, and take up a certain volume based on their capabilities and TL. The base volume is 10,000cc, divided by (TL-8)<sup>3</sup>. This gives a +2 to hit (in a d20 system). 1,000,000cc equals 1 cubic meter.

TL	+2 bonus	+4 bonus	+6 bonus	+8 bonus	+10 bonus	+12 bonus
9	10,000cc	40,000cc	160,000cc	640,000cc	2,560,000cc	10,240,000cc
10	1,250cc	5,000cc	20,000cc	80,000cc	320,000cc	1,280,000cc
11	370.0cc	1,480cc	5,930cc	23,700cc	94,800cc	379,000cc
12	156.0cc	625.0cc	2,500cc	10,000cc	40,000cc	160,000cc
13	80.0cc	320.0cc	1,280cc	5,120cc	20,500cc	81,900cc
14	46.3cc	185.0cc	741.0cc	2,960cc	11,900cc	47,400cc
15	29.2cc	117.0cc	466.0cc	1,870cc	7,460cc	29,900cc

This guidance modifier will only be vs. broad target types at TL10 (heat, radar, etc.). At TL11, it can be narrowed down (tanks, helicopters, large animals, etc.). At TL12+, it can be vs. very specific targets (Russian tanks, people, etc.). There are three overall categories of guidance, user-guided projectiles, self-guided projectiles, and smart weapons.

## User-guided projectiles

This is the first category for guided weapons, and is the only way to give in-flight course corrections at TL9. The projectile is guided for its entire flight path by the firer. This could be by wires, radio, optical fiber, or some other mechanism, depending on TL. The mass and volume of the guidance system stays with the firer, and a volume and mass equal to 10% of guidance system must be carried in the projectile. The maximum effective skill that the firer may use is the level of bonus. A sloppy guidance system will negate high levels of user skill.

**Example** - A person firing a +6 self-guided weapon would never be able to use more than a skill of 6 with it. A person with a skill of 8 would be restricted to a skill of 6, but a person with a skill of 4 would get a +6 bonus, or enough to raise their effective skill to not more than 6. How this is implemented depends on your system, and these numbers assume a d20 skill system.

In addition to the 10% of guidance system in the projectile, an additional (20-TL)% is required for each doubling of weapon range past 500m (round up), to account for wires, radio receivers, fiberoptic cable, etc. In general, the weapon will have a maximum guided range of (TL-8)<sup>4</sup> x 500m.

Tech Level Range	TL9 .5km	TL10 16km	TL11 81km	TL12 256km	TL13 625km	TL14 1300km	TL15 2400km
% for .5km	10%	10%	10%	10%	10%	10%	10%
% for 1km	-	20%	19%	18%	17%	16%	15%
% for 2km	-	30%	28%	26%	24%	22%	20%
% for 4km	-	40%	37%	34%	31%	28%	25%
% for 8km	-	50%	46%	42%	38%	34%	30%
% for 16km	-	60%	55%	50%	45%	40%	35%
% for 32km	-	-	64%	58%	52%	46%	40%
% for 64km	-	-	73%	64%	59%	52%	45%
% for 125km	-	-	-	72%	66%	58%	50%
% for 250km	-	-	-	80%	73%	64%	55%
% for 500km	-	-	-	-	80%	70%	60%
% for 1,000km	-	-	-	-	-	76%	65%
% for 2,000km	-	-	-	-	-	-	70%

**Example** - A +4 system at TL10 has a volume of 5,000cc at the firer's end, with an *additional* 500cc in the projectile as the basic volume. This is good out to 500m. If the range were 4km, the extra volume in the projectile would be 40% instead of 10%, for a volume of 2,000cc.

### Self-guided projectiles

This is the second category, and is only possible at TL10+. The weapon only gets the bonus if the target is in the weapon sights at the time of firing. The volume of the system must be entirely in the projectile. Using a broader target class than normal for that TL will reduce the volume of the guidance system by 25% per TL reduction, with a maximum reduction of 50%. For instance, a TL11 system which would lock on to any high energy heat source (TL10) vs. jet engines (TL11) would save 25% of volume and mass, but be more susceptible to countermeasures.

The quality of the target type will affect chances for the weapon to hit. For instance, a head on shot vs. a jet would be a reduced chance to lock on/hit for a heat-seeker, but a tail shot would be an increased chance.

### Smart weapons

This is a "guided" round where all the guidance is in or on the weapon itself. These are possible at TL9+. The weapon is activated by pulling the trigger or flipping a switch, and does not fire until the appropriate target type is actually in the sights. The guidance bonus may work in one of two ways. It can either be a bonus to all shots, or the weapon will simply make "to hit" rolls, but not actually fire until one is made, in which case the target is automatically hit.

**Example** - A +4 system on a gun could either give a +4 to user skill for *all* shots fired, or it can give a +4 bonus to user skill, and ignore any "to hit" roll which is not successful. The first case would give a number of shots which may or may not hit, and the latter gives a single shot which *does* hit, eventually.

The mass and volume of a smart weapon guidance system is 25% that listed on the table. However, base cost is quadrupled. Up to half the sensor array may be separate from the weapon (belt pack, etc.). The base sensor is totally dependent on the firer, and only gives a "shoot/don't shoot" indication. The firer must move the weapon to bear on potential targets. A "console" and circuitry to go with it doubles mass, volume and cost, and giving the sensor "target seeking" ability (like a rotating radar antenna) doubles it again. A target seeking system that masses at least 10% of the weapon mass is assumed to be able to move the weapon to bear on targets the sensors pick up.

**Example** - A TL9 radar guided anti-aircraft gun with a +12 bonus will have a base volume of 2,560,000cc (about 2.5m<sup>3</sup>, 25% of the normal volume). With a console and rotating antenna, the volume is 10m<sup>3</sup>, and masses 10 metric tons. A +14 system would have a volume of 40m<sup>3</sup>, and mass 40 metric tons. This of course does not count the building to keep it in, or the generator to power it.

Usually, a smart weapon sensor type is fixed, and works only on a certain type of target or target characteristic. At TL11, different target characteristics within a group can be selected by parts replacement, and at TL12, different target characteristics within a group can be selected by software changes. For instance, a visual TL12 sensor could be reprogrammed to look for trucks instead of tanks.

Smart weapons are limited in their effective range. The bonus for a smart weapon is halved for each second of projectile flight time away from the target. For instance, a +4 system firing a projectile at 500m/sec would go to a +2 system at any range of 501-1,000m, and +1 at ranges of 1,001-1,500m.

### Tracking

The tracking procedure for all guided weapons will vary, but is generally as follows. Each time increment of play (nominally 1 second), at closest approach to whichever target it is following, it *may* have to make another targeting roll. A new targeting roll is required if the modifiers to hit have decreased the chance to hit, as compared to the previous time increment. The "skill" of the weapon for guiding itself is counted as being its guidance bonus.

### Linked guidance

Separate sensor systems may be mixed and matched, and all bonuses add together in applicable situations.

**Example** - A +4 smart weapon firing a +2 guided projectile counts as a +6 weapon for acquiring targets. Once in flight, the projectile can only use its own guidance, however.

### Indirect fire

Guided projectiles may be fired indirectly, at unknown targets. Assume the system has a sensor arc of 15°. When a possible target enters this arc, regardless of how far away it is, the system has a chance to lock on, using a skill equal to its bonus. For user-guided projectiles, the control range is independent of where the projectile was fired from. A laser designator could be the control link, and the projectile itself fired from an artillery piece many kilometers to the rear. Once the laser designator and projectile come within the guidance distance, the person with the designator can treat the projectile as though they had fired it. Guided projectiles of any type cannot usually change course by more than 15° per unit of flight time.

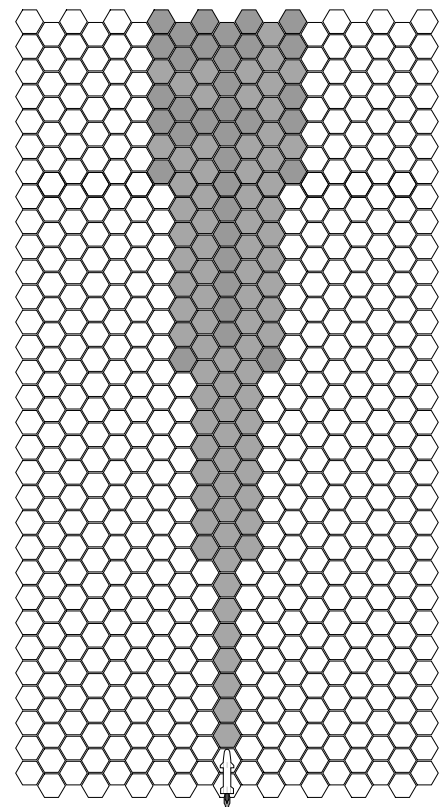

Typical sensor arc

# Conventional Weapons

## Proximity fuzing

Any guided weapon may have this capability built in at no cost, mass or space penalty. The weapon automatically detonates or performs some other action when the modifier to hit reaches a certain level, usually associated with a very short range.

For unguided weapons, it is simply a sensor array, with no guidance capability. When certain conditions are met, some function of the weapon is activated. For instance, a mortar shell could have a +2 sensor that detonates the shell the first time it makes a targeting roll that has a +30 modifier or better, which corresponds to a height of a meter or two from the ground, for optimum burst pattern. The mass and volume for a basic proximity fuze is the same as for a +2 smart weapon sensor array, but may be reduced by broadening the target category.

The conditions under which a proximity fuze detonates are limited by the TL and type of sensor. For instance, a proximity fuze based on very short range radar reflections won't detonate if the target has an anti-radar "stealth" surface. In general, countermeasures vs. a type of proximity fuze will lag 1 TL behind the sensor technology used.

A specialized type of fuze is the time fuze, which simply detonates a payload (or performs some other action) a preset time after the weapon is fired. For anti-aircraft use, this might correspond to a particular altitude that could be set before firing. This is the simplest type of "proximity" fuze, in that you hope your target is in the proximity of the warhead when it goes off. A time fuze is possible at any TL with chemical propellants, and can be nothing more than a fuze that is lit when the weapon fires (with a precision of plus or minus (7-TL) seconds. A basic time fuze has no extra mass or cost if part of an exploding round or other payload. Sophisticated fuzes that may be remotely set or changed will have the mass and cost of a regular proximity fuze (and are only available at TL's where regular proximity fuzes are possible).

**Example** - A +10 missile is tracking a jet, and decreases the range by 300m. At the same time, the jet engages in evasive maneuvers. If the penalty for evasive maneuvers was greater than the bonus for being 300m closer to the target, a new targeting roll would be needed, which would count all applicable factors (target size, range, etc.), and be based on a skill of 10, since this was a +10 missile. If the penalty for evasive maneuvers was equal to or less than the bonus for being 300m closer, no roll would be needed, and lock-on would be maintained.

For user-guided weapons, the procedure is the same. If the modifiers decrease the overall chance to hit, another targeting roll must be made. With most surface-to-surface user-guided systems, a failed roll usually means the missile hits the ground and breaks up.

**Example** - A +8 user-guided anti-tank missile is steered towards a tank, and decreases the range by 200m over the course of a second. At the same time, the tank engages in evasive maneuvers and fires a machine gun towards the person guiding the missile. If the penalty for evasive maneuvers plus making the missile operator flinch was greater than the bonus for being 200m closer to the target, a new targeting roll would be needed, which would count all applicable factors (target size, range, etc.), and be based on a skill of 8, or the user's skill with a +8 modifier, whichever is *lower*, since this was a +8 missile. If the penalty for the evasive maneuvers was equal to or less than the bonus for being 200m closer, no additional roll would be needed, and the missile would continue towards the tank.

## Power usage

Any "one-shot" sensor device is assumed to have power for one use. Sensors that will see constant or intermittent use will need a battery or power supply, which will add to the mass and volume of the system. If the power runs out, the system is useless.

In general, a guidance system will require  $(20-TL)^3$  Joules per second of operation per 100,000cc of guidance system volume.

**Example** - The +12 console-based tracking system in the previous example had a volume of 10m<sup>3</sup>, or 10,000,000cc. So, it requires  $(20-TL)^3 \times (10,000,000/100,000) = 133,100J$  per second, or 133 kilowatts of power.

## Ammunition cost

Rounds will cost a number of Cr based on their DV and complexity. The base cost is:

$$(DV^2/10,000) + .1Cr$$

**Example** - DV22 pistol rounds have a base cost of .15Cr each, or 7.5Cr for a box of 50.

Buying in quantity will sometimes get a discount, and ammunition for prototype or custom weapons will use the same multiple as the weapon itself.

The cost of a guidance system is based partially on the size of the weapon it is attached to, but has a minimum base cost of 2Cr. Fragmentation rounds have a minimum base cost of 1Cr. The DV of a rocket is the larger of 2Cr or its *impact* DV, based on effective energy and largest diameter (counting larger than 10cm as 10cm).

Round is:	Cost multiple
Disposable	x.5
Rocket	x4.0
Caseless (can't be disposable)	x2.0
Inert armor-piercing (or defeats armor at same or lower TL)	x2.0
Tungsten armor-piercing (or defeats marginally more advanced armor)	x3.0
Depleted uranium armor-piercing (or defeats some armor at +1 TL)	x4.0
Hollow-point (can't be AP)	x1.5
Exploding/HE (can be HEAT, but not inert AP)	x3.0
HEAT (must be exploding as well)	x2.0
Fragmentation (can't be hollow-point, must be HE)	x3.0
Multiple projectile	x2.0
Discarding sabot	x3.0

**Example** - DV22 hollow-points are  $.14\text{Cr} \times 1.5 = .21\text{Cr}$  each. Caseless DV50 rifle rounds are  $.35\text{Cr} \times 2.0 = .70\text{Cr}$  each. A DV200 discarding sabot tungsten cannon shell is  $4.1\text{Cr} \times 3.0 \times 3.0 = 36.9\text{Cr}$ .

### Guidance system costs

Self-guided rounds use a minimum cost of 2Cr, or the cost of the projectile/payload, whichever is higher, which generally represents system size. Guidance systems use the DV of the weapon they are part of.

Round is:	Cost multiple
Guided round	x3.0 per +2
Self-guided round	x1.0
User guided (control system)	x1.0
User guided (projectile)	x.30
Smart weapon (basic)	x4.0
Smart weapon (console)	x2.0
Smart weapon (tracking array)	x2.0

**Example** - A +8 self-guided DV200 round would cost  $4.1\text{Cr} \times 3 \times 3 \times 3 \times 3 = 332.1\text{Cr}$  ( $\times 3.0$  per +2). The +12 TL9 array listed before, if attached to control this weapon, would have a cost of  $4.1\text{Cr} \times 3 \times 3 \times 3 \times 3 \times 3 \times 3 \times 3 \times 4$  (basic)  $\times 2$  (console)  $\times 2$  (tracking) = 47,800Cr.

### Salvage

Spent casings from cased rounds are generally worth 10% of base round cost (ignore minimums and projectile type modifiers), and may be reloaded, if the market for such exists in your game. Buyers of salvaged casings will generally not deal with quantities of less than 1,000 for small arms.

### Guidance types

Depending on TL and weapon type, you need to designate a self-guided weapon as having certain characteristics. Each is a separate sensor type, with separate volume requirements. Optionally, each additional type is half the volume of the previous one, to reflect common circuitry.

### Passive homing

The weapon employs passive sensors to detect some target characteristic, like radio/radar emissions, heat signature or shape. If the target ceases to have the required characteristics, lock-on is lost, and the weapon ceases maneuvering, or use a preset maneuvering pattern.

### Semi-active homing

The weapon employs passive sensors, but detects radiations bounced off the target by the firer, such as radar pulses, laser designator, etc.

### Active homing

The weapon uses a detectable means to scan for targets. This could be an on-board radar, laser rangefinder or other active sensor.

### Modifiers

The guidance type will be further modified by certain secondary characteristics. Usually, these will be fixed into the weapon design by the manufacturer as befits the weapon objective, but they could just as easily be selected before use by means of a control panel, software, or internal circuit board changes.

### Lock-on//fire and forget

The first category requires that the weapon make a successful targeting roll *before* it can be fired. The skill of the user is modified by the bonus of the weapon to get the base lock-on roll, which is modified by circumstance (range, obscurement, jamming, etc.). The latter category means that the weapon can be fired with no skill roll needed, and it will home in on the first target that meets the targeting criteria.

### Terminal guidance

This is usually applied to a weapon which is unguided or remotely guided for most of its path. At some point in its path, it switches to on-board guidance. This may be at a time increment, a distance, a level of range bonus or target intensity, or under manual command. At this point, it gains the characteristics of a "fire and forget" weapon.

# Conventional Weapons

## Energy-enhanced weapons

An odd hybrid between a strictly electrically powered weapon and a chemically propelled conventional weapon is the energy-enhanced weapon.

This type of weapon uses a storage bank of some type to add energy to the ionized gases produced by combustion of the propellant. This keeps these gases hot and expanding, where normally they would cool and lose pressure due to the ever-increasing volume of space behind the projectile as it moves down the barrel. In design terms, the mass of a number of storage banks is added to the weapon mass (before computing for accessories). The energy of a storage bank is added to delivered propellant energy for determining muzzle velocity and DV, but *not* for purposes of basic barrel length, mass, etc. For all weapon mass purposes, treat this extra energy as being outside the normal calculations (although mass of these components does count towards accessories and other secondary characteristics, though). The maximum additional energy is 50% of the normal muzzle energy, for a maximum DV increase of 22.4%. The weapon may be used with or without this enhancement, but may have different DV's and RC's in each mode. The overall cost of the weapon gets a x2.0 multiple. If the extra energy is adjustable, use an *additional* x1.1 multiple. See the design rules for lasers to get the mass and cost of different types of electrical storage banks.

Historically, this idea is a late TL11 development (we're working on it now), and if practical, will probably first be used at TL12.

## Sample weapon design

As a quick example of the basic design rules, a simple design is below. See the various rule sections if there is *any* part you don't understand. Most of the numbers will be taken directly from tables.

### Project - 11mm Heavy Pistol, TL12

#### Specs

The final product is a 1,400J semi-auto pistol with a 10 round detachable clip and a bore of 11mm. This is more or less the energy and bore of a .44 Magnum.

#### Damage Value

The DV of an 11mm, 1,400J projectile is 31, which is very respectable for a pistol.

$$(1400J \times .735/1.1)^5 = 31$$

#### Projectile

The pistol uses a 2:1 lead (sg11) slug, with a mass of 19.2g. An energy of 1,400J would give it a velocity of 541m/sec. A 2:1 projectile moving at 541m/sec has a maximum aiming RC of 3, and a 2:1 sg11 projectile of this diameter has a damage RC of 4.

#### Propellant

1,400J of TL12 propellant is 1,400J/1,620J per gram = .864g of propellant. If you figure out the propellant/projectile volume ratio for a 2:1 11mm pistol bullet, you'll find it is less than 10%, so there is no danger of increased malfunction chance. The casing mass is 2.8 x the propellant mass, or 2.42g, so the total round mass is:

$$.864g + 2.42g + 19.2g = 22.5g$$

#### Receiver

The receiver is next. The energy of 1,400J is on the table, and is 864g, for a TL10 semi-auto weapon. Since this is TL12, we reduce this mass by 20%, to 691g.

#### Barrel

A TL12 semi-auto has an efficiency of 1.00, so we need to find the base barrel length for 1,400J. 1,400J of TL12 propellant is 1,400J/1,620J per gram = .864g of propellant. For this energy, TL and bore, the base barrel length is:

$$(400/TL12) \times (.864g \text{ powder}/2)^5/1.1cm = 19.9cm$$

Using the table on page 17, the mass of a 20cm barrel for a 1,400J weapon is 748g at TL10. Since this is TL12, we reduce this mass by 20%, to 598g. A 20cm barrel for an 11mm projectile means the final aiming RC will be 2 (18x projectile diameter), so this pistol has an RC of 2/4, and a base Inherent Accuracy of 1.

#### Accessories

Accessories will have a mass multiple of x1.2, so the unloaded weapon mass will be:

$$(691g \text{ (receiver)} + 598g \text{ (barrel)}) \times 1.2 = 1547g \text{ (1.55kg)}$$

#### Clip

This will be the mass of 10 rounds, or 225g, times a mass multiple of x1.2 for detachable clips, for a loaded clip mass of 270g, or .27kg. The loaded weapon mass is therefore:

$$1.55kg + .27kg = 1.82kg$$

#### Cost

The cost of the weapon is based on the DV, action type and the fact that it is a pistol, and is:

$$(DV31^2/5 + 100) \times 1.0 \text{ (semi-auto)} \times 2.0 \text{ (pistol)} = 584Cr$$



## Muscle-powered weapons

The  $3G^3$  system can be used to design bows, crossbows and larger weapons working on these principles. The “pull” of such a weapon is roughly  $(\text{Energy} \times .735)^{.5} \times 3$  kilograms for weapons with 10mm projectiles, and DV is based on energy and projectile diameter. Or to reverse this, the energy is  $(\text{pull weight in kilograms}/3)^2 \times 1.36$ . To build a stored energy weapon in  $3G^3$ , make the following assumptions:

1. Projectile diameter is  $(\text{Energy}/5)^{.5} \times (4/\text{TL})$ , with a minimum of 10mm for any sort of wooden shaft
2. Projectiles are always subsonic ( $<330\text{m/sec}$ )
3. Damage RC is always 1 for wood or stone projectiles

**Example** - A bow with a pull of 30kg (66lb) would have an energy of about  $(30\text{kg}/3)^2 \times 1.36 = 136\text{J}$ .

Then, use this energy to calculate “receiver” mass, and *multiply this mass by 5*. The *minimum* action multiple is x.6 for bows, x.9 for crossbows, x1.5 for torsion engines and x15 for counterweight engines. There is no “propellant efficiency” for this type of weapon, and maximum reliability is based solely on Tech Level. Bows will have only a receiver, while crossbows will have a receiver, possibly a magazine, and accessories. Note that actions other than single shot require outside energy input for each shot. The AV and BP are half(n) the calculated amounts, with a minimum AV of 2. Note that a bow does not normally require accessory mass. If the bow is going to have string silencers, sights, etc. then it *will* require an accessory mass. The bulk of these weapons is figured by dividing the weapon mass by the lowest appropriate mass (at least .2kg) in a size range appropriate to the weapon. Accessories are x.1 for fixed emplacements, x.2 for moveable but non-mobile weapons, and x.3 for weapons that are wheeled or towable.

**Example** - If a crossbow has a designed mass of 3.5kg, you could say it had Small hit locations, which have a minimum mass of .51kg each, or a size of S/7.

Projectiles are usually heavy wood (sg1), with a 20:1 ratio for bolt-throwing siege engines, 30:1 l/w ratio for crossbows, and 60:1 for bows (use 10:1, times 2, 3 or 6). Projectiles of other densities are possible if the material technology permits, but must have *at least* the mass of an appropriate wood projectile. Stone projectiles are almost always sg2 spheres, for instance.

An *average* person can generate an energy for drawing a weapon of around 150J (a somewhat optimistic 31.5kg(70lb) draw weight, for a DV of 11. How this increases with Strength in any given system will vary, but the peak of human potential would be in the range of 1,000J (draw weight of 81.3kg(180lb) and a DV of 27), and this would only be from legendary individuals. Crossbows with a high Strength (more than a person can draw) can be “charged” at a rate of whatever their Strength will allow per second, once a “recharger” is hooked up.

### Quick design example

Say you want to design a TL4, 50kJ ballista (bolt thrower). This will have a minimum projectile diameter of  $(50,000\text{J}/5)^{.5} = 100\text{mm}$ . This energy will give a DV of  $((50,000\text{J} \times .735)/10\text{cm})^{.5} = 61$ .

The receiver will be single shot, with a minimum action multiple of x.9 mass, for an adjusted mass of  $50,000\text{J}^{.63} \times (20\text{-TL4}) \times 1.5 = 21.9\text{kg}$ , which is multiplied by 5 to 109.5kg. Assuming the only other mass is accessories at x.2 of the weapon mass plus a 1 shot “internal magazine” (22.2kg), this gives us a final weapon mass of  $109.5\text{kg} + 22.2\text{kg} = 131.7\text{kg}$ . The projectiles will be 20:1 l/w wood shafts, which will have a mass of 15.2kg, and be 2.0 meters long. They'll have a velocity of  $(50,000\text{J}/15,200\text{g})^{.5} \times 44.84 = 81.3\text{m/sec}$ , for an aiming RC of 2 and a damage RC of 1. If you can find several men to crank it up for 1,000J per second, it will take 50 seconds to reload after each shot.

These guidelines are not perfect, but work reasonably well for TL4+ stored energy weapons.

## Historical siege engines

All of the following historical weapons can be designed using the following guidelines. Most are historically at TL4, though they could be constructed with more modern materials.

### Onager

The onager was a torsion engine. That is, it gained power by twisting something like rope or hair, and the rotary stress powered an arm that threw a bolt, or in this case, a stone. An onager is a single-shot stone thrower for design purposes. The traditional catapult uses the same principle. The violent swing of the throwing arm dictates that onagers have at least one level of extra mass for durability purposes. Both could throw 25-30kg stones over 300 meters. This corresponds to an energy of about 40kJ, a velocity of around 50m/sec and a DV of 50-55 with a 160mm stone.

### Ballista

This used a pair of torsion skeins to propel a spear-like shaft several hundred meters. It is built as a single-shot bolt thrower. A lightweight field ballista could shoot a 5kg bolt over 400 meters. This corresponds to an energy of about 10kJ, a velocity of around 65m/sec and a DV of around 40 with a 45mm bolt.

### Sprenal

This is a spring engine, a large flat spring pulled back and released to strike the projectile, hurling it forward. This could be used to shoot either bolts or stones, depending on design. A wide spring could be used to strike several projectiles simultaneously, allowing for SS/n actions to be used.

### Trebuchet

This is a gravity engine, using a large counterweight to hurl a stone attached to a long, relatively thin throwing arm. These are bought as single shot stone throwers. Trebuchets are the largest siege engines known, with throwing arms over 15m long in some cases, and able to hurl 130kg stones over 250 meters. This corresponds to an energy of about 160kJ, a velocity of around 50m/sec and a DV of around 110 with a 250mm stone.

All figures assume maximum range is based on a 45° trajectory. If the range was managed with a lower trajectory, velocity and energy would be higher.



# Lasers

## Ads & Disads

Lasers have a number of advantages. They are silent, untraceable, and laser beams travel at the speed of light. You don't have to lead targets because of movement, or change point of aim because of range. They rely only on energy for their damage, and can be recharged from virtually any compatible power source.

They have the disadvantage that anything which interferes with light can reduce the damage they do. Rain, fog, clouds, dust or smoke may slow or stop a laser, when they would have little or no effect on conventional weapons. For this reason, projectile weapons of some type will almost certainly be around a long time.

## Laser rifles before 2000AD?

For those of you who will doubtless use these rules to see if you can make a useful handheld laser weapon using today's technology, the answer is a qualified "yes". You can make a nasty, portable weapon. However, it is not nearly as nasty as an equivalent conventional rifle in any respect. You can go out and buy an off-the-shelf 200J continuous beam CO<sub>2</sub> laser, plug the sucker into a couple of large batteries and a power converter, and lase away for a few minutes. The whole apparatus will be about the size and weight of a network-quality camcorder, and only have a DV of 17, but you *can* do it. In TL11 terms, it will have a mass of 9.33kg (folded once to about 85cm, plus accessories), and will suck off 100,000J per second. For 100 seconds of operation, you will need 14.3kg of TL11 batteries. For an equivalent TL12 design, it masses 7.47kg, is 65cm long, and needs 7.27kg of batteries.

## Natural lasers?

Since there are creatures which can store significant amounts of electricity (electric eels), and lasers can be made from organic materials, presumably there could be alien creatures with natural laser armament. For general design purposes, assume these would be TL10 lasers. Providing a rational biology and ecosystem for such odd creatures is up to you.

## Lasers

A laser is a beam of coherent energy. Most people assume light, since laser stands for **L**ight **A**mplification by **S**timulated **E**mission of **R**adiation, but lasers can operate on any "light" frequency from infrared through visible light, ultraviolet, and into the X-ray range, although we lack the practical means to do the latter. For purposes of 3G<sup>3</sup>, lasers will be restricted to the near-infrared, visible and near-ultraviolet ranges. Most lasers will also be pulse lasers, that is, all the energy of the beam is delivered to the target almost instantly. Beam duration is a tiny fraction of a second, for for lasers at the maximum power deliverable through an atmosphere, the beam will be visible as a faint flash along its path.

<b>TL8</b> (circa 1900AD)	<b>Technical notes</b>	This is the first TL where lasers can be developed. There is technology to generate electrical power, and sufficient mechanical precision for laser alignment. Like the very low TL's for conventional weapons, TL8 lasers are not really practical when compared to any other available weapons technology. Fictional uses might be for things like the plots of Jules Verne or H.G. Wells novels.
	<b>Historical notes</b>	Not historically possible at this TL, however, neon lighting (a precursor to gas lasers) was invented in TL8.
<b>TL9</b> (circa 1930AD)	<b>Technical notes</b>	Lasers become practical in a laboratory sense. Power supplies are the limiting factor, and will remain so for several TL's. Fixed emplacements can be built to monstrous size, since electrical power generation and distribution is widespread. Secret WWII "death beams" may be developed.
	<b>Historical notes</b>	Barely historically possible at this TL. The first lasers were developed very late in TL9. These were exclusively crystal lasers, energized by light from xenon flash lamps, and the maximum DV developed was around 3.
<b>TL10</b> (circa 1960AD)	<b>Technical notes</b>	Most of the limits of TL9 apply, but transistor technology is making the power conditioning part of the power supplies smaller. Battery technology is increasing, but still not sufficient for any practical portable laser.
	<b>Historical notes</b>	The first experiments with laser weapons begin. Actual laser technology now includes crystal based, gas, liquid and gas dynamic (combustion) lasers. Military experiments with high power lasers are mainly gas and gas dynamic lasers. Laser rangefinders and laser target designators become portable.
<b>TL11</b> (circa 1980AD)	<b>Technical notes</b>	If you try very hard, you can make a useful, portable laser weapon. However, it still does not compare to any conventional weapon in terms of effectiveness. It might serve a specialized niche in terms of blinding, equipment damage or other esoteric applications.
	<b>Historical notes</b>	Emplaced laser weapons have shot down missiles in mid flight (continuous beam models), proving more the effectiveness of tracking systems than of laser power. Some Soviet naval vessels have been equipped with laser arrays whose most likely purpose is to blind enemy pilots. The "free electron" laser is developed, which can be tuned over a broad frequency range, unlike the very narrow spectrums of previous laser technologies.
<b>TL12</b> (circa 2000AD)	<b>Technical notes</b>	A semi-practical laser weapon can be assembled from off-the-shelf hardware, such as belt-mounted battery packs from network TV cameras, and lasers from established companies. The result is still heavy, fragile, and only packs the punch of a pistol, but could be made better. Efficiency of the laser itself is now fairly high, but it is still the power supply that weighs things down.
	<b>Historical notes</b>	None yet.
<b>TL13</b> (circa 2100AD)	<b>Technical notes</b>	The advent of room temperature superconductors makes portable weapons practical for the first time. They are still less effective than TL13 conventional weapons, but are effective enough to be considered for specialized battlefield roles.
	<b>Historical notes</b>	None yet.

**Technical notes** Lasers become efficient enough to become standard military weapons, especially for space-based troops, since there is no recoil, and usually a good supply of energy for recharging. Conventional weapons still have an edge in certain situations, and have not been abandoned however.

**Historical notes** None yet.

**Technical notes** This is as highly advanced as laser weapons get in **3G<sup>3</sup>**. Technically the rules can be extrapolated past this point, but TL16+ should assume some new breakthrough in weapon and/or power technology that would render TL15 technology obsolete, just as TL13 superconductors rendered TL12 capacitors obsolete.

**Historical notes** None yet.

TL14  
(circa 2200AD)

TL15  
(circa 2300AD)

**1996 power**

For more 1990's designs, the following "real-world" batteries (late TL11) store the listed power in Joules (with some rounding of figures). The actual figures will vary slightly between manufacturers, but the numbers below are a good guide.

Type	Cap.	Mass	Cost
AA battery <sup>cz</sup>	5,000J	19g	.35Cr
AA battery <sup>al</sup>	9,600J	24g	.60Cr
AA battery <sup>li</sup>	10.5kJ	14g	6.0Cr
AA battery <sup>nc</sup>	3,000J	22g	2.0Cr
C battery <sup>cz</sup>	16.0kJ	53g	.50Cr
C battery <sup>al</sup>	25.0kJ	65g	1.0Cr
C battery <sup>li</sup>	54.0kJ	47g	10Cr
C battery <sup>nc</sup>	10.0kJ	75g	4.0Cr
D battery <sup>cz</sup>	40.5kJ	106g	.75Cr
D battery <sup>al</sup>	62.8kJ	135g	1.5Cr
D battery <sup>nc</sup>	19.0kJ	141g	5.0Cr
9v battery <sup>cz</sup>	13.8kJ	38g	1.0Cr
9v battery <sup>al</sup>	17.8kJ	47g	2.0Cr
9v battery <sup>nc</sup>	16.0kJ	54g	8.0Cr
12v motorcycle <sup>la</sup>	1,000kJ	8.6kg	50Cr

cz - Carbon-zinc  
al - Alkaline  
nc - Nickel-cadmium  
li - Lithium  
la - Lead-acid

**Basics**

Laser beams can be created from optically excited solids or liquids, electrically excited gases, high energy plasmas, chemical interactions, combustion, etc. Almost anything can be made to emit a laser beam if you pump enough energy into it. The special effects of your laser are up to you. For design purposes, **3G<sup>3</sup>** will assume that all you need is electricity, and in most cases, lasers will be gas lasers, i.e. electric pulses turned into a laser beam by some form of interaction with a gas or mixture of gases.

Lasers are possible at any TL of 8 or better, although they do not become practical until TL13. At where we are now (TL11-12), laser weapons are far from practical, but still possible. All we hear about are behemoths that fill APC's or airliners, and which take several seconds to knock down target drones. Perhaps the low-tech designs in **3G<sup>3</sup>** are not impractical enough using today's technology, but even if they were possible, the research would be classified and you would never hear about it anyway.



Any hand-held lasers you design are not likely to cut people in half, or even burn holes through them. People contain a lot of water, and water absorbs a tremendous amount of heat. Most of the burn damage from a laser will be in the first few cm of tissue, and localized to the area touched by the beam. A high powered laser would be able to vaporize water at the location hit, possibly causing a steam explosion. The secondary effects of this could rip or tear tissue further away from the area hit, and set up shock waves that could travel significant distances. Laser hits should be treated as having the same special effects as bullet hits.

Against an inanimate target, damage is based on the material hit. Flammable targets will catch fire. Slightly combustible materials will smoulder, and those with a high moisture content may be cratered by steam explosions. Lasers will melt anything that can be melted, and vaporize small amounts as well. Sudden heat stresses can set up shock waves that can shatter brittle materials (like passing through a window), or cause "blowthrough", where hot bits of molten target are blasted through onto anything unlucky enough to be on the other side.

**Tech Level**

The first thing you need to decide on is the Tech Level of the weapon, tweaked to match whatever your personal perceptions are of what should and should not be possible at a given TL.

**Damage Value**

Then, you have to have some idea what you want the laser to do, and an approximate DV. Next, you need to figure out the actual DV, and the beam energy needed to get that level of damage. The DV of a laser beam is:

$$(Energy\ in\ Joules \times .735 / beam\ diameter\ in\ mm)^5$$

Beam diameter is a minimum of 5mm, or  $(Energy\ in\ J^{.9} / 31,416)^{.5} \times 20$ , whichever is larger (round to nearest .5mm).

**Example** - A 10,000J laser will have a minimum beam of  $(10,000^{.9} / 31,416)^{.5} \times 20$ , or 7.11mm, which rounds to a more convenient 7.0mm. The DV would be 102.

Just for your reference, a typical "C" size lithium battery (TL12 or fairly close) has an energy of about 1140J per gram. A "C" size alkaline battery (TL10) has an energy of 390J per gram, and an old carbon-zinc "C" cell (TL9) has an energy of about 250J per gram. A TL11 nickel-cadmium rechargeable "C" cell will only hold about 135J per gram. Very large storage banks of any type will be more "efficient", as proportionately less mass is wasted on the casing of the storage bank, but **3G<sup>3</sup>** will not deal with this, as the system is complex enough as it is.

Household electrical outlets (TL9 or better) can supply power at the rate of (TL x 2) x 100J without blowing fuses or circuit breakers.

# Lasers

Once outside an atmosphere, there is no minimum beam diameter, but design practicalities will restrict diameter to half that for an atmospheric laser of the same power, again with a minimum diameter of 5mm.

Energy	Beam diameter	DV	Energy	Beam diameter	DV
200J	5mm	17	3000J	5mm	66
400J	5mm	24	3500J	5mm	72
600J	5mm	30	4000J	5mm	77
800J	5mm	34	5000J	5mm	86
1000J	5mm	38	6000J	5.5mm	90
1200J	5mm	42	7000J	6.0mm	93
1400J	5mm	45	8000J	6.5mm	95
1600J	5mm	48	9000J	7.0mm	97
1800J	5mm	51	10000J	7.0mm	102
2000J	5mm	54	15000J	8.5mm	114
2500J	5mm	61	20000J	9.5mm	124

The best way to figure out beam power and DV is by using the previous table, which has energies, DV's and beam diameters over a range sufficient for hand-held weapons.

**Practical limits** - The  $3G^3$  limits on beam energy in an atmosphere (10,000J per square cm) mean that there is a practical limit to the DV you can get out of a laser weapon before efficiency starts to go way down because of interactions with water vapor, dust and anything else which can vaporize and hinder the beam. A 5,000J beam (DV86) is the upper limit of efficiency, but a TL15 weapon can still be practical with a 10,000J beam (DV102). Beyond that, and power consumption per shot becomes too high to carry a large clip, although vehicle mounts can "brute force" their way to high DV's. Also, if you want to use the laser rules for "blasters" or some technology that doesn't suffer from the limitations of lasers, feel free to ignore this minimum beam diameter.

## Efficiency

The efficiency of a laser will vary widely with TL, and is generally  $(TL-7) \times 5\%$ . A laser's efficiency applies to two separate steps. First, the storage bank has to power the laser directly, and second, some form of battery has to recharge the storage bank. So, efficiency cuts twice if you have to recharge the storage banks from a battery pack or other limited source.

In practical terms, it means that the beam energy you want will require a much greater input of real energy, as shown below.

TL	100J of beam energy requires	which requires	Multiple
8	2,000J of storage bank	40,000J of battery	x20.0
9	1,000J of storage bank	10,000J of battery	x10.0
10	670J of storage bank	4,490J of battery	x6.7
11	500J of storage bank	2,500J of battery	x5.0
12	400J of storage bank	1,600J of battery	x4.0
13	330J of storage bank	1,090J of battery	x3.3
14	290J of storage bank	841J of battery	x2.9
15	250J of storage bank	625J of battery	x2.5

**Example** - A TL12 laser with a beam energy of 2,000J requires a power input from storage banks of  $2,000J \times 4.0 = 8,000J$  per shot.

Almost all of the energy will be lost as heat, and lasers will need to dissipate this heat to function continuously. This will most likely be through a heat exchanger integrated into the lasing apparatus. This will use a lightweight working fluid like a fluorocarbon that is pumped through the weapon and into cooling fins. These will be mounted to minimize heat signature (probably the bottom of the weapon). This waste heat will make high-power lasers show up like beacons to anyone doing a thermal or temperature scan of an area (portable thermal scopes become available at TL11+). For instance, an 800J laser (DV34) at TL14 will vent as much waste heat as a 1500 watt space heater. **Also see p.65.**

## Energy storage

The notes for batteries and storage banks will apply equally to all energy weapons and railguns, and will not be repeated elsewhere.

## Capacitors

A laser requires large amounts of power virtually instantly for high-power pulses. At TL12 and below, this is supplied by capacitors or a functionally equivalent technology. A capacitor can store a certain amount of energy as an electrical charge, rather than chemical energy. It will not hold as much energy on a gram for gram basis, but has the advantage that it can be discharged virtually instantly, and can be recharged an infinite number of times. They will not store energy indefinitely, and will self-discharge slowly over hours or days, depending on quality and TL.

Each shot requires a capacitor bank holding the input power for *that* shot. Once fired, the bank must be recharged, or another one used. Rapid fire is only possible with multiple banks. Lower tech weapons may use a small number of banks, and endure the recharge rate. The grams of "capacitors" needed for an input pulse is:

$$\text{Capacitor mass} = \text{Energy stored} / ((TL-7) \times .4)$$

**Example** - At TL12, a 1,000J input pulse requires  $1,000J / ((12-7) \times .4) = 500g$  of capacitors.

## Superconductors

These are a theoretical technology. A superconductor capable of operating at room temperature, with an ability to tolerate high magnetic fields, may be eventually possible. A superconductor has *no* resistance, so any energy pumped into one stays there indefinitely (or until used). A small coil of such a superconductor could have a large amount of energy "pumped in", where it would sit and endlessly circle, until an electrical load was hooked up to it, at which point it would instantly discharge. In this way it functions much the same as a capacitor, but at much higher efficiency. They may also be recharged any number of times.

At TL13+,  $3G^3$  postulates room-temperature superconductors. These will store large amounts of current in a continuous loop. To shoot, the entire loop is dumped into the laser at once. One loop powers one shot, and must then be recharged from a battery or other source. The number of grams of superconductors needed for an input pulse is:

$$\text{Superconductor mass} = \text{Energy stored} / ((TL-12) \times 125)$$

**Example** - A TL13, a 1,000J input pulse requires  $1,000 / ((13-12) \times 125) = 8.0g$  of superconductor loop.

Another way of looking at it is to say that 1 gram of capacitor or superconductor stores a given amount of energy at a certain TL, as on the following table. These numbers are rounded from formula results to make things a bit easier.

TL	Capacitor	Superconductor	Battery	Solar panel
8	.4J/g	-	100J/g	.01J/g
9	.8J/g	-	200J/g	.02J/g
10	1.2J/g	-	400J/g	.02J/g
11	1.6J/g	-	700J/g	.03J/g
12	2.0J/g	-	1100J/g	.03J/g
13	2.4J/g	125J/g	1600J/g	.04J/g
14	2.8J/g	250J/g	2100J/g	.04J/g
15	3.2J/g	375J/g	2900J/g	.05J/g

### Batteries

Any TL of 8+ will have useful batteries, which are usually a means of turning chemical energy into electrical energy. A battery will contain a certain amount of energy in Joules, which can only be siphoned off at a certain rate. The maximum discharge rate of any battery will be 1% of capacity per second. So, a 10,000J battery could only discharge at the rate of 10,000J x 1% = 100J per second. This is important to note for purposes of recharging storage banks on a weapon. These batteries are *not* rechargeable. Once discharged, they must be discarded. Rechargeable batteries have 1/4 the energy capacity of non-rechargeable ones, and have double cost (*Note: This is a change from 2nd ed. rules*). The mass of a given battery is:

$$\text{Battery mass} = \text{Energy stored} / ((\text{TL}-7)/2 \times (\text{TL}-8) \times 100 + 100)$$

Some combat lasers will use a belt or backpack mounted battery pack connected to the laser itself by a small cable. This is especially true at TL13+, where it becomes more weight efficient to carry a small number of clips and a rechargeable battery, especially since a battery can recharge a clip that has been partially used, keeping it "topped off" for combat readiness. A soldier might carry a rechargeable battery and solar panel to insure that they can maintain a constant supply of fire if separated from a supply source, with a few non-rechargeable ones to provide a high rate of fire in crisis situation. Most batteries will be attached to the weapon by breakaway cables to prevent entangling, and may automatically retract when detached. Sidearms with external batteries are assumed to top off rechargeable clips when the weapon is holstered, and holsters *can* mount solar panels and batteries.

External battery packs cost 1Cr per 100g. Cost is halved for each TL below the current level, and if close enough to the next highest TL, advanced batteries will cost four times as much.

Remember that a weapon will have a charging efficiency equal to the laser efficiency, and the input pulse must be multiplied by this number to take into account charging losses.

**Example** - A TL12 laser with a 1,000J pulse needs an input pulse of 4,000J, and the storage bank supplying the 4,000J requires 16,000J to fill it.

Multiply the total energy in the clip by the power multiplier to get the battery energy needed to refill the clip. Remember that batteries may not discharge at a rate of greater than 1% of their total capacity per second (i.e. total discharge in 100 seconds).

**Example** - A 10,000J battery may only charge a storage bank at a rate of 100J per second. If the laser required 500J of input to a storage bank per shot, the clip would recharge at the rate of 1 shot per 5 seconds.

This discharge rate will allow you to figure out how long it will take to top off or recharge a weapon clip or battery from a given power source. Sources like vehicle power supplies can usually provide enough output to charge hand weapons fairly quickly. A typical TL11 auto generator will put out around 200J/second.

**Note** - A battery which exactly charges a clip will do so in 100 seconds. If the battery will charge more than one clip, divide 100 seconds by the number of clips to get the charge time per clip.

**Example** - If a battery is designed to charge 5 identical clips for a weapon, then since it can totally discharge in 100 seconds, it can charge each clip in 100 seconds/5 clips = 20 seconds.

### Solar panels

These are a way of generating small amounts of current anywhere there is a light source. The power listed is in full sunlight. Overcast conditions would cut this by at least half. Solar panels *may* be mounted on weapons.

While not too practical, small scale solar panels may be built into a weapon to recharge it in well-lit areas. The maximum panel area in cm<sup>2</sup> is equal to:

$$\text{Max. panel area} = 10 \times \text{weapon length} \times \text{beam diameter}$$

The mass of solar panels and associated hardware is assumed to be 1 gram per square cm. Like other generators, this power is supplied at a constant rate (as long as the sun shines). Panel cost is 1Cr per 10 square cm. The rules for solar panels apply to any energy-powered weapon, substituting weapon bore for beam diameter in the case of railguns. These rules can be used to construct small solar arrays separate from a weapon, with a mass of 10kg per square meter, for your reference. This mass may be reduced at increased cost, as for weapons. Solar panels are especially good for "survival" weapons, or for long-duration infiltration missions.

**Example** - A 100cm laser with a .5cm beam could have 500 square cm of solar panels *on* the weapon. This would mass .5kg, and at TL13, supply 20J of charging power (in full sunlight), and add 50Cr to the cost of the weapon. A reasonable size for the panel might be 100cm x 5cm.

# Lasers

## Cartridge lasers

It is possible to design lasers that use some sort of disposable shell or energy storage, for instance, superconductor loops that fracture under discharge stress, and are discarded to save mass. Or, you could say that the laser uses ampules of chemicals, or some other one-shot means of energy storage. In this case, clips would be designed as for a conventional firearm, and each "round" would have a casing, whose mass would be based on the mass of storage loop or other energy storage device. Cartridges for a laser might also include cooling liquids to carry away the waste heat of the weapon.

You would need to decide both mechanical and electrical compatibility between weapons if this route is used, since the "rounds" must not only feed through the mechanism, but must also generate power compatible with the weapon design.

## Blinding

Almost any laser can permanently blind a person, even a laser rangefinder or high powered laser sight. Most troops issued laser weapons or facing laser weapons will also have protective goggles that selectively filter out the wavelengths used, to protect against stray reflections. Currently, protective glasses or goggles of this type cost at least 300Cr each.

## Focusing technology

The limits of beam density in normal atmosphere can be somewhat offset by creative beam focusing arrangements. A beam can be split into several less energetic beams which are designed to converge at the target. This would have a mechanical mass and cost as though the weapon were an adjustable output laser, and in addition, the laser must be equipped with a "smart weapon" sensor suite whose bonus is *twice* the aiming RC of the weapon (e.g. an aiming RC3 weapon would have a +6 sensor). This gives no bonus to hit, but covers the rangefinders and precision optical components needed to adjust the beam convergence for each shot. The net effect is to halve the effective beam diameter (down to a minimum of 5mm), which for lasers of more than 21.3kJ will result in a DV increase of 41%.

## Laser tube

A laser weapon does not require a receiver like a conventional weapon. A laser consists of the lasing apparatus, energy storage and accessories. The lasing apparatus itself will have a mass equal to:

$$\text{Laser mass in grams} = \text{Beam energy in J}^{-5} \times 200 / (\text{TL}-7)$$

This covers the laser tube, chamber or other lasing mechanism, and any associated circuitry. This component will also be the length of the weapon. Usually, it may be optically "folded" to shorten it up to 3 times, i.e., a 300cm laser tube could be made into a 75cm long weapon. The following table gives laser masses for a variety of Tech Levels and beam energies. The term kJ stands for kilojoule, or 1,000J, so 15kJ is 15,000J. The table below has laser tube mass for a selection of energies and TL's.

**Example** - At TL13, a 9,000J lasing apparatus will have a mass of 3160g.

Mass of lasing apparatus by TL and energy								
Energy	TL8	TL9	TL10	TL11	TL12	TL13	TL14	TL15
200J	2830g	1410g	943g	707g	566g	471g	404g	354g
400J	4000g	2000g	1330g	1000g	800g	667g	571g	500g
600J	4900g	2450g	1630g	1230g	980g	816g	700g	612g
800J	5660g	2830g	1890g	1410g	1130g	943g	808g	707g
1000J	6330g	3160g	2110g	1580g	1270g	1050g	904g	791g
1200J	6930g	3460g	2310g	1730g	1390g	1160g	990g	866g
1400J	7480g	3740g	2490g	1870g	1500g	1250g	1070g	935g
1600J	8000g	4000g	2670g	2000g	1600g	1330g	1140g	1000g
1800J	8490g	4240g	2830g	2120g	1700g	1410g	1210g	1060g
2000J	8940g	4470g	2980g	2240g	1790g	1490g	1280g	1120g
2500J	10.0kg	5000g	3330g	2500g	2000g	1670g	1430g	1250g
3000J	11.0kg	5480g	3650g	2740g	2190g	1830g	1570g	1370g
3500J	11.8kg	5920g	3940g	2960g	2370g	1970g	1690g	1480g
4000J	12.7kg	6330g	4220g	3160g	2530g	2110g	1810g	1580g
4500J	13.4kg	6710g	4470g	3350g	2680g	2240g	1920g	1680g
5000J	14.1kg	7070g	4710g	3540g	2830g	2360g	2020g	1770g
6000J	15.5kg	7750g	5160g	3870g	3100g	2580g	2210g	1940g
7000J	16.7kg	8370g	5580g	4180g	3350g	2790g	2390g	2090g
8000J	17.9kg	8940g	5960g	4470g	3580g	2980g	2560g	2240g
9000J	19.0kg	9490g	6330g	4740g	3800g	3160g	2710g	2370g
10kJ	20.0kg	10.0kg	6670g	5000g	4000g	3330g	2860g	2500g
12kJ	21.9kg	11.0kg	7300g	5480g	4380g	3650g	3130g	2740g
14kJ	23.7kg	11.8kg	7890g	5920g	4730g	3940g	3380g	2960g
16kJ	25.3kg	12.6kg	8430g	6330g	5060g	4220g	3610g	3160g
18kJ	26.8kg	13.4kg	8940g	6710g	5370g	4470g	3830g	3350g
20kJ	28.3kg	14.1kg	9430g	7070g	5660g	4710g	4040g	3540g
25kJ	31.6kg	15.8kg	10.5kg	7910g	6330g	5270g	4520g	3950g
30kJ	34.6kg	17.3kg	11.5kg	8660g	6930g	5770g	4950g	4330g
35kJ	37.4kg	18.7kg	12.5kg	9350g	7490g	6240g	5350g	4680g
40kJ	40.0kg	20.0kg	13.3kg	10.0kg	8000g	6670g	5710g	5000g
45kJ	42.4kg	21.2kg	14.1kg	10.6kg	8490g	7070g	6060g	5300g
50kJ	44.7kg	22.4kg	14.9kg	11.2kg	8940g	7450g	6390g	5590g

## Adjustable frequency

Any laser of TL12+ can be manufactured to fire a beam in more than one frequency range (near-infrared, visible, near-ultraviolet). The laser tube will have x1.5 mass and cost for a laser which fires in two frequencies or bands, and x2.0 mass and cost for a laser which fires in all three ranges. The laser is also corresponding longer. The advantages of this are that the laser is less affected by adverse conditions. One frequency range might penetrate conditions that would block another. These are not necessarily widely separated parts of the spectrum, but can be just enough to make a difference. In game terms, an adjustable laser is affected by such conditions by a level less than non-adjustable lasers. If the system you are converting to does not distinguish between the two laser types, use the non-adjustable laser mass for design purposes.



**Length**

The length of the laser will be a function of the beam diameter in mm and the mass of the laser. A laser with a narrow beam will be longer than an equivalent one with a wider beam. Lasers with extremely large beams may actually be squat looking, due to concentrating mirrors, etc. The length of a laser in cm is:

$$\text{Length} = (\text{laser mass in grams}/3)^{.8}/((\text{beam diameter in mm}/5)^{-5} \times 3.1416)$$

A laser may be "folded" up to 3 times to get a weapon of reasonable length, but the mass is increased *after* folding by 10% per fold, as is laser cost.

Laser length	Folds	Laser mass
x1.0	0	x1.0
x.50	1	x1.1
x.33	2	x1.2
x.25	3	x1.3

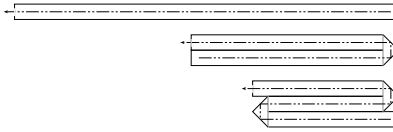

The table below lists laser lengths for a variety of masses and beam diameters.

Mass	Beam diameter							
	5mm	6mm	7mm	8mm	9mm	10mm	11mm	12mm
500g	19cm	17cm	16cm	15cm	14cm	13cm	13cm	12cm
600g	22cm	20cm	19cm	17cm	16cm	16cm	15cm	14cm
700g	25cm	23cm	21cm	20cm	19cm	18cm	17cm	16cm
800g	28cm	25cm	23cm	22cm	21cm	20cm	19cm	18cm
900g	31cm	28cm	26cm	24cm	23cm	22cm	21cm	20cm
1000g	33cm	30cm	28cm	26cm	25cm	23cm	22cm	21cm
1200g	38cm	35cm	32cm	30cm	29cm	27cm	26cm	25cm
1400g	43cm	40cm	37cm	34cm	32cm	31cm	29cm	28cm
1600g	48cm	44cm	41cm	38cm	36cm	34cm	33cm	31cm
1800g	53cm	49cm	45cm	42cm	40cm	38cm	36cm	34cm
2000g	58cm	53cm	49cm	46cm	43cm	41cm	39cm	37cm
2200g	62cm	57cm	53cm	49cm	47cm	44cm	42cm	40cm
2400g	67cm	61cm	57cm	53cm	50cm	47cm	45cm	43cm
2600g	71cm	65cm	60cm	56cm	53cm	50cm	48cm	46cm
2800g	76cm	69cm	64cm	60cm	56cm	54cm	51cm	49cm
3000g	80cm	73cm	68cm	63cm	60cm	57cm	54cm	52cm
3200g	84cm	77cm	71cm	67cm	63cm	60cm	57cm	54cm
3400g	88cm	81cm	75cm	70cm	66cm	62cm	60cm	57cm
3600g	93cm	84cm	78cm	73cm	69cm	65cm	62cm	60cm
3800g	97cm	88cm	82cm	76cm	72cm	68cm	65cm	62cm
4000g	101cm	92cm	85cm	80cm	75cm	71cm	68cm	65cm
4200g	105cm	96cm	88cm	83cm	78cm	74cm	71cm	68cm
4400g	109cm	99cm	92cm	86cm	81cm	77cm	73cm	70cm
4600g	113cm	103cm	95cm	89cm	84cm	80cm	76cm	73cm
4800g	116cm	106cm	98cm	92cm	87cm	82cm	79cm	75cm
5000g	120cm	110cm	102cm	95cm	90cm	85cm	81cm	78cm
5500g	130cm	119cm	110cm	103cm	97cm	92cm	88cm	84cm
6000g	139cm	127cm	118cm	110cm	104cm	98cm	94cm	90cm
6500g	148cm	135cm	125cm	117cm	111cm	105cm	100cm	96cm
7000g	157cm	144cm	133cm	125cm	117cm	111cm	106cm	102cm
7500g	166cm	152cm	141cm	132cm	124cm	118cm	112cm	107cm
8000g	175cm	160cm	148cm	139cm	131cm	124cm	118cm	113cm
8500g	184cm	168cm	155cm	145cm	137cm	130cm	124cm	119cm
9000g	193cm	176cm	163cm	152cm	144cm	136cm	130cm	124cm
10000g	209cm	191cm	177cm	166cm	156cm	148cm	141cm	135cm

**Example** - A 7,000g laser tube (7.0kg) with a 8mm beam will be 125cm, or 1.25m long. If folded twice, it would be a more reasonable 42cm long, but the mass would increase to 7,000g x 1.2 = 8,400g.

**Chemical Lasers**

One other technology available to designers is chemical lasers. These use the energy of a chemical reaction to start a lasing process, rather than using electricity to do the work. Typically, this is some sort of energetic reaction like combustion, which takes place inside a resonating cavity.

One advantage of such a laser is that you can use the much more energetic chemical propellant numbers instead of batteries or capacitors. A disadvantage is that you have to use the efficiency of the weapon twice. Think of the chemical reaction as being both battery *and* storage bank.

**Example** - At TL11 you would need 2500J of propellant to get a 100J beam.

**Note** - Using these numbers, efficiency between chemical and superconductor storage gives chemical lasers a mass advantage up to TL19.

Other parts of the design rules for lasers will remain the same. Heat is vented out of the system partially by the escaping gases, and partially through heat sinks. Continuous beam lasers will require much more chemical input, but their efficiency remains the same. The rules for cartridge lasers may be used with the idea of chemical lasers.

**Note** - The exhaust gases from a chemical laser can range from obnoxious to scaldingly toxic. The higher the TL, the worse things are likely to be.

**Semiconductor Lasers**

These use a specialized semiconductor junction to generate laser light without any of the complicated equipment of lower tech lasers. These are developed at TL11, and almost all laser sights of TL12+ will use these due to their small size. The coherent beam is diffused by the narrow semiconductor junction, and they require external lenses to produce a narrow beam. To use them in a weapon would require large arrays of them feeding a common optical path. Perhaps this route is feasible, but only time will tell.

**Note** - Any such array-based laser would be inherently adjustable over a wide range of outputs, and this should be reflected in the cost.



# Lasers

## Clips

A laser clip can be internal, removable, external, or some combination of the above. A clip can contain multiple power sources, so a laser clip could contain both a battery, superconductors, and a small solar panel so it recharges itself when hooked onto a belt.

### Internal magazine

Internal packs are an integral part of the weapon, and cannot be removed except by disassembly. Multiply the mass of all internal power components (batteries, capacitors, superconductors) by x1.1, and save this amount.

### Removable magazine

Removable clips can be detached and replaced when discharged. The hardware required for this multiplies the mass of all removable components by x1.2. This is the "clip mass".

### External magazine

External power packs consist of something like a belt- or backpack, connected to the weapon by a cable. The mass of this hardware multiplies the mass of all external power components by x1.3. This is also a "clip mass", but does not count towards the mass of the weapon for accessory or initiative purposes. The length of any power coupling is assumed to be at least long enough for normal use by a person carrying the weapon. Non-portable installations must be handled on an individual basis, but in these cases, the size of the power coupling will usually be small compared to the installation itself.

**Combinations** - Use the appropriate mass multiples for the different parts. If a weapon has an internal clip, *and* an external, detachable one, the mass of each one will depend on the number of shots it holds and whether it is internal or external to the weapon.

## Accessories

All designs will need some sort of external fixtures, like stocks, trigger guards, sights and so on. These items will simply add a percentage to the mass of the unloaded weapon. The base mass includes the weapon and any internal energy system, but not the mass of any external power supply. A weapon (unloaded) plus accessories will mass:

(lasing apparatus + any internal clip) x mass multiplier

Detachable or external clips are separate items, and do *not* contribute to accessory mass. Add-ons like solar panels or vision aids add to weapon mass *after* accessories are taken into account.

### Fixed mounts

Fixed mount weapons, or those which are a permanent part of a vehicle will have a mass multiplier of x1.1. The weapon will normally be unsuitable to be fired in any other way, although small examples may be cradled under the arm, or braced against a hip, at substantial penalties to hit a target. A fixed mount includes sights only if the firer would normally look directly over the weapon to fire it.

### Hand-held

Weapons designed to be fired by hand, without external encumbrances will have a mass multiplier of x1.2. The weapon is not designed to be fired from or mounted in any fixed mount or movable tracking system. A handheld weapon will include basic sights and grips for one or two hands. If a military longarm, provision for attaching a bayonet, grenade launcher (TL10+) or in some cases a telescopic (TL10+) or night sight (TL11+) may be included, and on civilian longarms, will usually include provision for mounting a telescopic sight (TL8+). These features will be less common, but available at lower TL's. Laser filtering is mandatory on any optical (rather than electronic) sight for a laser weapon. Cost would be as for **protective goggles** (see p.42).

### Semi-fixed

A semi-fixed mount has all the features of both fixed and hand-held mounts, and is usually applied to weapons like light machine guns, which may be carried, fired from a bipod, pintle or tripod. They have a mass multiplier of x1.3. A semi-fixed mount includes all advantages of the previous types, and in addition can be assumed to have a folding bipod, allowing more accurate fire from a prone position.

**Example** - A TL14 laser rifle is designed with a base mass of 5.00kg. It is hand-held, so the final mass is 5.00 x 1.2, or 6.00kg. This extra 1.0kg includes the stock, grip, and sights, and attachment points for other optional features.

## Secondary characteristics

Like conventional weapons, lasers will have secondary characteristics that you must either decide upon yourself, or are functions of the weapon design itself.

### Range Class

The aiming RC of a laser is based on the length of the completed weapon (not the unfolded laser tube). Most longarm laser weapons will be compact, "bullpup" designs.

Weapon length	Aiming RC
less than 10cm	1
11-20cm	2
21-40cm	3
40-80cm	4
81-150cm	5
151-300cm	6
301-600cm	7
601+cm	8

For damage RC, use the RC that applies to *total laser tube length*. All energy weapons get a +20% chance (+4 on d20 systems) to hit due to different aiming characteristics and shorter travel time to target. All *losses* of DV due to range are decreased by 10%. In a vacuum or where there is nothing to scatter the beam, losses are decreased by 40%.

### Inherent Accuracy

A laser weapon so designed is assumed to have a base IA of 1/2(u) the aiming RC of the weapon. So, RC1 and RC2 weapons have an IA of 1, RC3 and RC4 weapons have an IA of 2, etc. The IA of a laser weapon can be influenced by cost, just like for conventional weapons.

**Rate of Fire**

A pulsed laser weapon can have any rate of fire up to 10 shots per second per laser tube, or the number of shots in a clip, whichever is less. Civilian models may differ from military weapons only by having no autofire circuits, but are still capable of the higher rate of fire if modified by an electronics tech.

**Recoil**

Lasers or laser-based stunners do not have recoil, and take no consecutive shot modifiers that are recoil based.

**Malfunction chance**

Lasers will have a chance of malfunction on a to hit roll of 20. A second d20 is rolled. If the result is 19, the weapon fires at half DV. If a 20 is rolled, the weapon does not fire due to electrical problems. It may be fired normally on the next action. Lasers have a base reliability category of II.

**Weapon bulk**

The bulk of a weapon is found by dividing its length in cm by 15, rounding fractions up. This is the number of **TimeLords** hit locations the weapon would cover if carried close to the body.

**Example** - If the previous weapon had a lasing apparatus 50cm long, the weapon length would be 4 locations long.

The size of each location depends on the weapon mass, as per the table below.

Mass per location	Bulk per location	BP per location
<.50kg	Very Small (VS)	(20-TL)/7
.51-4.0kg	Small (S)	(20-TL)/6
4.01-32.0kg	Medium (M)	(20-TL)/5
>32.0kg	Large (L)	(20-TL)/4

**Example** - A 6kg weapon that covered 4 locations would have a mass of 1.5kg per location, for a total bulk of four Small (S/4).

**Armor Value**

The Armor Value of the weapon is a measure of how much physical abuse the weapon can withstand, and is based on the same scale as the DV. That is, 1 point of damage is stopped by 1 point of armor. Anything that gets through AV does actual damage to the weapon. The AV is a general number, and reflects the average of the entire weapon, rather than the specific damage resistance of the lasing apparatus, etc. Individual components may vary by a great deal, and you may determine that a particular lasing technology is more or less durable than others. Lasers generally have a lower AV, because electronics is not as durable as steel, regardless of what the electronics are housed in. The AV is based on the TL and energy of the weapon, and is based on the beam energy, with a minimum AV of 2.

$$\text{Energy of beam}^{.15} \times ((20\text{-TL})/5)(n)$$

**Example** - If A TL13 previous weapon had a beam energy of 2000J, its AV would be  $2000J^{.15} \times (20\text{-}13)/5 = 4$ .

**Body Points**

The Body Points of the weapon are figured from the above table as well. Fractions are kept, and the total BP from all locations is added together, and rounded nearest.

**Example** - If the previous weapon were TL9, it would have 2.25BP per location, for a total of 4.5BP, which rounds to 5BP.

Each level of increased mass or cost for any reason (except reduced mass) will decrease the effective TL by 1 for AV and BP purposes (heavier or more expensive weapons have more), and each level of decreased mass or cost will increase effective TL by 1.

**Initiative**

The Initiative of the weapon is how easy it is to swing into position, and move about in close quarters. For instance, you can swing a light pistol to a certain arc faster than a heavy rifle. Initiative is function of weapon length and loaded mass in kilograms, but only for the energy sources carried on or in the weapon. External energy supplies may penalize a character because of encumbrance, but do not directly affect weapon Initiative. **Initiative** for lasers is exactly the same as for conventional weapons (p.21).

**Cost**

The base cost for a laser weapon is based on its DV. The price is in credits (Cr), where a credit is a generic unit of currency roughly equal to a modern US dollar in purchasing power.

$$\text{Cost} = \text{DV of beam}^{2/3} + 300\text{Cr}$$

**Example** - A weapon with a DV of 20 would have a base cost of 433Cr. A laser cannon with a DV of 1000 would have a base cost of 333,633Cr.

Cost is a TL-independent item. The Cr is supposed to apply to whatever standard of living applies in the game where this weapon is used. If average income or standard of living is lower, then prices will be correspondingly lower, but will still represent about the same amount of work by a person trying to save up for it. The amount of 100Cr represents the same fraction of an average person's income at TL7 as it does at TL13, or any other TL with money or exchange.

The base cost of a weapon is modified by the design and firing characteristics of the weapon.

Action	Cost	Weapon	Cost
Continuous	x1.1	Pistol	x2.0
Stunner	x1.1	Longarm	x1.0
Multiple barrel*	x1.8	Vehicle mount	x1.0
SA	x1.0		
AT & SA	x1.3	<b>Mass</b>	<b>Cost</b>
AT only	x1.0	x2.0	x.25
AB	x1.5	x1.5	x.50
Adjust. power	x1.1	x1.0	x1.0
Folded laser	x1.1 per	x.75	x2.0
		x.50	x4.0
			+100%
			x4.0

$$\text{Extra clip} \quad \text{shots}^5 \times \text{weapon cost}/100$$

\* the multiple applies to each extra tube on any multi-tube laser

These multiply together, rather than adding, so an autoburst pistol would have a cost multiple of  $(1.5 \times 2.0) = 3.0$ . Weapons with detachable magazines are assumed to come with one. Extra clips (/C) cost as shown. This cost is halved for external magazines (/E).

# Lasers

## Ultra-tech

Many of the energy weapon design equations in **3G<sup>3</sup>** have a (20-TL), (TL-7) or other TL term in them. If you really want, designs for lasers and other weapons may be extrapolated past the limits of the system, out to Tech Level 19, whatever that is. Any odd results you get here are entirely your own fault, as are technology discrepancies based on extrapolation of today's theoretical developments.

## Efficiency

Laser efficiency goes *way* up as you approach TL20.

TL	100J beam req.	which req.	Multiple
16	220J storage bank	480J battery	x2.2
17	200J storage bank	400J battery	x2.0
18	180J storage bank	320J battery	x1.8
19	170J storage bank	290J battery	x1.7

## Power sources

The formulas for various energy sources also extend out to TL19.

TL	Capacitor	Super-conductor	Battery	Solar panel
16	3.6J/g	500J/g	3700J/g	.05J/g
17	4.0J/g	625J/g	4600J/g	.06J/g
18	4.4J/g	750J/g	5600J/g	.06J/g
19	4.8J/g	875J/g	6700J/g	.07J/g

## Armor Values

Assume the AV for a weapon at a TL of 16 or more is actually higher than those at TL15, since we are undoubtedly dealing with some new form of material science. Assume each TL past 15 *decreases* the TL of the weapon for purposes of AV and BP.

## Phazers, blasters, etc.

The design of bizarre technologies which we can't even theorize yet is left to individual designers. The weapons get fairly nasty as is. For instance, a TL19 laser pistol with a lethal DV of 24, a stun DV of 17, and 100 shots will only mass about .5kg. A more traditional design with only 20 shots and no stun function could pack a DV of 54 into a package no bigger than one of today's 9mm pistols with a DV of only 22.

## Mass modifiers

Each x2.0 multiple on cost will reduce the mass of a weapon by 25% (with maximum reduction of 50%). Each x.50 multiple on cost will increase the mass by 50% (with maximum increase of 100%). This mass modifier applies to the unloaded weapon mass, and does not apply to ammunition, although it will apply to the empty mass of any magazines (like empty clips). This modification to mass has no effect on the IA of the weapon.

## IA modifiers

The IA of the weapon may be increased by increasing the cost of the weapon. Each x2.0 multiple on cost will increase the base IA of the weapon by 50% (round nearest). Each x.50 multiple on cost will decrease the base IA of the weapon by 50% (round down). The IA of a weapon may never go below -1. Each point that IA is decreased due to cheapness is a +1 row modifier for determining malfunctions (lasers are assumed to have a base chance as per the 20-39% row).

The IA may also be increased by increasing the mass of the weapon, *if the weapon mass was not already increased to reduce weapon cost*. Each 50% increase in mass *and* cost will increase the IA by 50% (round nearest), with a maximum increase of 200% (total of x3 mass and cost). So, if a pistol with an IA of 1 was increased in mass and cost by 50%, its IA would go to 1.5, which rounds to 2.

The maximum IA of any weapon may never exceed 3 times the base IA for that weapon.

**Example** - A semi-auto pistol with a DV of 20 and an IA of 1 has a base cost of 866Cr. For an increase in cost of 100% (+866Cr), the IA goes to 1.5. For another increase in cost *and* mass of 100% (+866Cr), the IA goes to 2.5, which rounds to 3. So, for a cost of 2,600Cr, you can have this pistol in a heavy target version, with an IA of 3 instead of 1.

## Advanced design

The following rules cover advanced or optional laser design rules, and may or may not find application in the game system you use.

### Adjustable output

With an adjustable laser, the beam power in J can be adjusted to any amount by the firer, usually by some convenient control on the outside of the weapon. It could also be a "factory pre-set" adjustable by a weaponsmith, but normally inaccessible to the casual user.

This option increases total laser cost (sans external options like sights) by 10%. Since power is stored in individual banks which are entirely discharged on firing, no extra shots are normally gained this way. Continuous beam lasers will have increased firing time, however, since the drain on the battery is reduced. Beam diameter remains the same in all cases. All excess, "unused" power is dissipated through the weapon's heat sinks, which can be overloaded, so reduced power shots do not affect malfunction numbers.

**Optional** - You can "dodge" this rule by designing a clip which has many small storage banks, so one full power shot discharges several at once. You would use a smaller number of storage banks for low power shots, and get more shots per clip. However, each storage bank counts as a "shot" when computing clip cost. This dodge applies to any energy powered weapon. It does not affect the initial cost of the weapon, but will apply to the cost of any extra clips.

**Example** - Four 1,000J storage banks are used to fire a laser at full power. Using only one storage bank per shot would allow four times the number of shots per clip.

**Optional** - A fully adjustable weapon could be used as a laser rangefinder, spot welder, laser communicator, etc. Assume that any enhancement of an adjustable weapon would increase cost by an *additional* 10%.

**Note** - The ability to adjust shots is a function of the laser, as much as the clip. A non-adjustable laser cannot take advantage of an “adjustable” clip, and can only discharge 1 storage bank per shot, regardless of its energy capacity. An adjustable laser cannot take advantage of a “non-adjustable” clip, and must use whatever power a single storage bank provides. It might be able to adjust the beam, but still use the full energy. This also only applies in cases where weapons can use the clips from other weapons.

### Multiple Barrels

Laser tubes of the same or different damages in the same weapon get a 25% reduction in accessory weight, which is computed on the total of the barrels, and only applies if the smaller weapon is more than half the mass of the larger.

### Continuous Beam Lasers

Lasers designed for continuous beams must be powered by a constant power source, like a battery or generator. They are designed like a normal laser, but have all stats equal to a laser with a beam power of 100 times the actual power.

**Example** - A laser with a 200J constant output will weigh as much as a 20,000J pulsed laser.

Continuous beam lasers require power equal to 100 times the actual beam power each second of operation. Charging losses do not apply since the laser is powered directly from a battery or other power source, but the efficiency of the laser itself does.

**Example** - A TL12 continuous beam laser with a power of 200J will require  $800\text{J} \times 100 = 80,000\text{J}$  per second of operation. This must be supplied by a battery or generator. At TL12, this would require about 7.3kg of battery, taking into account the 1% discharge rate per second. At TL15, the laser would require an input power of 50,000J, and require 1.7kg of battery.

The effect of a continuous beam laser is like firing autofire, with a “rate of fire” of 10 shots per second. However, each of these hits will be more severe than normal. There are number of ways to simulate the effect. You can either count a continuous beam laser hit as 1d10 hits for purposes of penetrating armor, or assume the laser has a rate of fire of 100 shots per second for any autofire bonuses to hit in a particular game system. A low-power continuous beam laser can with time, burn through something that a short pulse might not be able to. One second of fire can apply the continuous beam DV over a line up to 10cm long, and for cutting through unresisting targets, increase the DV proportionately for shorter lengths (up to 3x normal DV).

**Example** - A DV9 cutting laser can apply a DV of 27 over a 3cm cut each second, or a DV of 18 over over 5cm.

Pulse lasers can be used as continuous beam lasers with an output of 1% of their base. This is a x1.1 multiple to the overall weapon cost.

**Example** - A 5,000J pulsed laser rifle (DV86) will probably have a switch allowing it to be used as a 50J continuous beam laser (DV9) powered from a battery pack, a useful function for crowd control, cutting through locks, etc. At TL15, this would need a minimum battery mass of .43kg (4.3g per second). At a 1% discharge rate, this would be good for 100 seconds of continuous fire.

### Stunners

A stunner can be made by focusing a laser beam to make an ionized path to the target. A high-voltage pulse is then sent down this path, shocking the target. A stun pulse from a weapon is very visible, and makes distinctive crackling sounds, as well as leaving an unmistakable ozone smell. The usual laser DV is 1-3, and the weapon will have RC1 for purposes of damage, *regardless of its RC for aiming*. The DV of a stun pulse is  $(\text{Energy} \times .735)^5$ .

**Example** - If you send a 2,500J pulse down the beam, the DV would be 43. If you used 100J, the DV would be 9.

This shock effect is at half DV if the target is struck on a conductive armor that will stop the base laser damage. If this armor is grounded, or a non-conductive armor is not penetrated, the shock does *no* damage. If the armor is penetrated by the laser, the shock usually does full damage.

A normal laser may be made into a stunner for a 10% increase in laser tube mass and overall weapon cost. In this case, each stun blast consumes at least two charges from a clip, one for the laser, the other for the stun. Or, a switch could select the number of “charges” to be dumped into the stun pulse. Or, a charge could power both the laser and stun pulse, according to a fixed or adjustable ratio.

**Example** - A laser rifle with 1000J pulses is equipped with the stunner option. A 1000J stun pulse would have a non-lethal DV of 27. If two charges were used (total of 3 “shots”, one for laser, two for stun), it would have a 2000J stun pulse, for a DV of 38. Four charges on the stun would have DV of 54, and consume 5 shots from the clip, unless the power used by the laser was negligible, in which case 4 shots would be used, the actual laser taking a few Joules from each one, the remainder being stun energy.

Weapons can also be designed as having two clips, one for the laser, the other for the stun. This might be more mass efficient, since the low DV laser beam will consume little power. Stun effects may be adjusted down as normal laser fire, and continuous beam stunners are possible, but they use huge amounts of power (100 stun pulses per second).

# Lasers

## Low-tech stunners

At low TL's, the best way to get a stun only weapon is not a laser, but a projectile weapon which fires wire-trailing darts. If these strike the flesh of the target (doing a DV of 1-4), the user can then use a battery to dump "stun charges" into the target. The maximum range of the weapon would be the wire length, and assume such wires would mass 10g per meter. The total projectile + wire mass would be used for design calculations, with the caveat that the weapon is always RC1/1.

## Other laser tricks

Lasers can be used for a number of other functions related to their use as a weapon.

A laser fence would be done with a continuous beam laser and an array of mirrors on poles. Any interruption of the beam could trigger an alarm, and optionally send a higher power pulse through the system.

Some or all of a laser beam would bypass the protections of armored glass or other transparent armors. At higher TL's, such armors would be specifically designed to absorb most weapon wavelengths, giving them an oddly tinted look.

A mirror designed to reflect a particular laser wavelength could be used as an aiming system for a remotely mounted laser. This would protect the expensive laser, and remove the easily detectable energy signature of the laser from the immediate vicinity. In extreme cases, this could allow a system to shoot over hills and other direct fire obstacles. In a personal sense, a laser rifle could have an attachment that allows it to shoot around corners without exposing the user to return fire.

On a related note, a single beam could be split into several less energetic beams by a mirror array to get a higher rate of fire, and perhaps a better chance to hit as a result of slightly divergent beams (base the DV of each shot on its minimum beam diameter and fraction of the energy it gets).

## Sample weapon design

As a quick example of the basic design rules, a simple design is below. See the various rule sections if there is *any* part you don't understand. Most of the numbers will be taken directly from tables.

### Project - 5mm Laser Pistol, TL14

#### Specs

The final product is a 800J semi-auto pistol with a 40 shot internal clip and a bore of 5mm. It can also split the energy from each shot, so that it has a 5J beam, and a 795J stun pulse.

#### Damage Value

The DV of an 5mm, 800J beam is 34, which is high for a TL11 pistol., but probably about average for a TL14 one. The 5J beam used to carry the stun pulse has a DV of 3, and the remaining 795J has a stun DV of 24.

$$(800J \times .735/.5)^5 = 34$$

#### Power

At TL14, an 800J beam requires  $800J \times 2.9 = 2,320J$  of superconductor storage, for a mass of  $2,320J/250J$  per gram = 9.28g per shot, or a total superconductor mass of  $9.28g \times 40 = 371g$ . Since the storage is internal, the mass multiplier is x1.1, for a total power supply mass of  $371g \times 1.1 = 408g$ .

#### Laser

An 800J lasing apparatus masses 808g at TL14. The mass is increased by x1.1, since it is a stunner as well, to 889g, which makes its length around 30cm (30.2cm). We'll fold the laser once for compactness, increasing its total mass to  $889g \times 1.1 = 978g$ , and decreasing its length to 15cm.

#### Accessories

Accessories will have a mass multiple of x1.2, and be based on the laser + internal clip, and the total weapon mass will be 1.66kg.

$$(978g + 408g) \times 1.2 = 1,660g$$

#### Range Class

The aiming RC is based on overall weapon length, which is about 15cm, for an aiming RC of 2. Damage RC is based on the length of the lasing apparatus (30cm), which is a damage RC of 3, giving a final RC of 2/3. The IA is half the aiming RC, or 1.

#### Weapon bulk

Since the weapon is 15cm long (exactly), it is 1 location long, and its mass of 1.66kg means this will be a Small location, or S/1.

#### AV and BP

The AV is based on beam energy and TL, and is 3. The BP are based on its bulk, and it only has 1.

$$(800J)^{.15} \times (20-TL14/5) = 3$$

#### Initiative

The pistol has a bulk of S/1 and a total mass of 1.66kg, so the table on p.36 shows it has an Initiative of +2.

**Rate of fire** - Since this was designed as a non-military weapon, the ROF will be limited to 4, with tamper-resistant electronics to make it difficult to change.

**Cost** - The cost of the weapon is based on the DV, action type and the fact that it is a pistol, and is:

$$(DV34^2/3 + 300) \times 1.0 \text{ (semi-auto)} \times 1.1 \text{ (folded once)} \times 1.1 \text{ (stunner)} \times 2.0 \text{ (pistol)} = 1,660Cr$$



## Particle Beams

Particle beams are directed energy weapons which do damage based on the effects of a small quantity of atomic or subatomic particles travelling at relativistic speeds. Just about any particle will do, but for combat you want a compromise between destruction of equipment or people and penetrating ability. For instance, a weapon which generated streams of fast neutrons would go through about anything, but not do an awful lot on the way.

The optimum beam type will interact with the target, doing damage throughout the thickness of any armor, and generating lots of heat and secondary X-rays, which do the actual damage. The secondary radiation effects can do damage even if the armor is not penetrated, which could neutralize the occupants of an armored target without actually destroying it. The damage from particle beams will be counted as bullet damage for special effects.

<b>Technical notes</b>	This is the lowest TL for particle beam weapons in the system, and they are totally unsuited for portable applications. Fixed mounts are only suitable for specialized or research applications.	TL-12 (circa 2000AD)
<b>Historical notes</b>	None yet.	
<b>Technical notes</b>	Particle beams are still inefficient, but the technology is developed enough to create reasonable, man-portable weapons, provided you have a sufficient power supply like a generator.	TL-13 (circa 2100AD)
<b>Historical notes</b>	None yet.	
<b>Technical notes</b>	Portable, self-contained particle beam weapons are possible, but unless both radiation <i>and</i> obscurement penetration are needed, a laser or railgun weapon is more practical by far.	TL-14 (circa 2200AD)
<b>Historical notes</b>	None yet.	
<b>Technical notes</b>	This is as highly advanced as particle beam weapons get in 3G <sup>3</sup> . Particle beam support weapons can be built which might see limited anti-equipment use, or for situations where lasers or other weapons are of limited use.	TL-15 (circa 2300AD)
<b>Historical notes</b>	None yet.	

## Basics

Particle beams as weapons can only be designed for TL's of 12 or better. If we started work on a ship-based anti-missile system, it might be ready by the year 2000. Maybe.

Particle beams are large, bulky and consume huge amounts of power at all TL's. Their advantages are that they are unaffected by adverse atmospheric conditions, as they literally burn a hole through the air to their target. This means that beam diameter can be kept low (and DV high), so they can generate higher DV's than possible or efficient for a laser.

Particle beams are generally point target weapons, but if the game system you use does not have them, the rules can be modified to cover plasma cannon, fusion beams, etc. Special adjustments for damage, area of effect and other special effects may be necessary, depending on individual game systems.

Particle beams are very visible when fired in an atmosphere, and will look like white-hot bolts of light, accompanied by small thunderclaps. In partial vacuum, these effects are reduced, and in a total vacuum, a beam will be invisible or barely visible.

## Tech Level

The first thing you need to decide on is the Tech Level of the weapon, tweaked to match whatever your personal perceptions are of what should and should not be possible at a given TL.

## Masers

Microwave beaming weapons are not a standard 3G<sup>3</sup> item, but if you choose to design them, you would use the particle beam rules. It is difficult to get a high DV in a portable maser weapon, and they have a number of other limitations. Things to note:

Masers will always have a damage RC of 1. While a coherent radio beam, it will still spread out more rapidly than a light beam.

Masers are affected in the same way as any other high-frequency radio energy. Anything that will stop radio waves will totally negate the maser damage, and anything that contains water (or some other asymmetric molecules) will take damage from it. For instance, aluminum foil would reflect a maser, but cement or earth would have chunks blown out of it. Most non-metallic body armors will be transparent to the energy, although thin layers of metal are likely to be included in any armor when masers are a common weapon.

Minimum "beam diameter" for a maser will be the same as for a laser of the same power, and maser damage is counted as burn damage for special effects and healing.

# Particle Beams

## Damage Value

Then, you have to have some idea what you want the particle beam to do, and an approximate DV. Next, you need to figure out the actual DV, and the beam energy needed to get that level of damage. The DV of a laser beam is:

$$(\text{Energy in Joules} \times .735 / \text{beam diameter in mm})^5$$

Beam diameter for a particle beam weapon is a minimum of 5mm, or  $(\text{Energy in J} / 314,160)^5 \times 10$ , whichever is larger (round to nearest .5mm).

**Example** - A 100,000J particle beam will have a minimum beam of  $(100,000 / 314,160)^5 \times 10$ , or 3.18mm, which rounds up to 5.0mm. The DV would be 383. You have to have an energy of more than 250,000J before beam diameter exceeds 5mm.

Once outside an atmosphere, there is no minimum beam diameter, but design practicalities will restrict diameter to half that for an atmospheric laser of the same power, again with a minimum diameter of 5mm.

Energy	Beam diameter	DV	Energy	Beam diameter	DV
1000J	5.0mm	38	15kJ	5.0mm	148
2000J	5.0mm	54	20kJ	5.0mm	171
3000J	5.0mm	66	25kJ	5.0mm	192
4000J	5.0mm	77	30kJ	5.0mm	210
5000J	5.0mm	86	40kJ	5.0mm	242
6000J	5.0mm	94	50kJ	5.0mm	271
7000J	5.0mm	101	60kJ	5.0mm	297
8000J	5.0mm	108	70kJ	5.0mm	321
9000J	5.0mm	115	80kJ	5.0mm	343
10kJ	5.0mm	121	90kJ	5.0mm	364
12kJ	5.0mm	133	100kJ	5.0mm	383

The best way to figure out beam power and corresponding DV is by using the previous table, which has energies, DV's and beam diameters over a range sufficient for any hand-held or portable weapons. You will notice that the small beam diameter makes particle beams more effective than lasers for high-energy uses.

**Margin of error** - Unlike most of the other technologies in 3G<sup>3</sup>, there isn't a lot of background data to draw from for designing particle beams as weapons. Most of the beams we now have which can do significant damage are up to tens of kilometers long, buried underground, and kept under strictly controlled environmental conditions. And, of course, they weren't designed as weapons.

This makes particle beams the most theoretical technology in 3G<sup>3</sup>, and the one with the highest likely error. Feel free to modify efficiencies, formulas and the like to suit your own particular science-fiction background that includes any non-laser energy weapons. For instance, if blasters are the norm, and no one uses lasers, increase the particle beam efficiency and/or reduce accelerator mass until you get figures you are comfortable with. If energy banks that take time to recharge are the norm, reduce the available energy from superconductors.

## Efficiency

The efficiency of a particle beam will vary with TL, and is generally  $(\text{TL}-10) \times 5\%$ . A particle beam's efficiency applies to two separate steps. First, the storage bank has to power the accelerator directly, and second, some form of battery has to recharge the storage bank. So, efficiency cuts twice if you have to recharge the storage banks from a battery pack or other limited source.

In practical terms, it means that the beam energy you want will require a much greater input of real energy, as shown below.

TL	100J of beam energy requires	which requires	Multiple
12	1000J of storage bank	10,000J of battery	x10.0
13	670J of storage bank	4,490J of battery	x6.7
14	500J of storage bank	2,500J of battery	x5.0
15	400J of storage bank	1,600J of battery	x4.0

**Example** - A TL12 accelerator with a beam energy of 2,000J requires a power input from storage banks of  $2,000\text{J} \times 10 = 20,000\text{J}$  per shot.

The waste energy will be lost as heat and electronic noise, and it is virtually impossible to camouflage the signature of a particle beam.

## Energy storage

The technical notes for **batteries, storage banks** and energy sources in general will apply to particle beams as well, and are on p.40-41.

## Accelerator

A particle beam weapon does not require a receiver like a conventional weapon. The accelerator of a particle beam consists of a particle source, and a sequence of electrostatic accelerators. Very high voltages are developed throughout the weapon, with correspondingly low tolerance to dirt and humidity. All vital areas are probably sealed and filled with an inert gas or partial vacuum. Particle beam weapons will usually function poorly if their integrity has been breached by any sort of damage, especially if foreign material gets in. The same applies if foreign material gets in the barrel, and most particle beam weapons have automatic shutters to prevent this from happening. The mass of the accelerator is based on the beam energy, and is:

$$((400 / (\text{TL}-7))^2 \times \text{Beam energy})^5$$

The table on the next page lists the masses of accelerators of given energy at different TL's. The DV column lists the DV of an accelerator of that energy.

**Length**

As with lasers, the total weapon length will probably be the accelerator length, with the other components being slung beneath or around the accelerator. The table lists the lengths for a variety of accelerator masses, *based on .5cm beam diameter*.

The length of the accelerator is based on its mass, and the length in cm is equal to:

$$(Accelerator\ mass/3)^{.8}/3.1416$$

This is for particle beams of .5cm. For particle beams of more than .5cm, the formula for length is:

$$(Accelerator\ mass/3)^{.8}/((Beam\ diameter\ x\ 2)^{-5} \times 3.1416)$$

Like lasers, the length of the accelerator may be cut by up to a factor of 4 (fold 3 times), to represent small cyclotrons or other non-linear means that may be used to accelerate the particles most of the way to maximum velocity. As for lasers, each fold will add 10% to the accelerator mass and total weapon cost.

**Example** - A 7,000g(7kg) particle accelerator will be 157cm long, which can be folded twice to a more reasonable 52cm, which would increase its mass to 7,000 x 1.2 = 8,400g. If folded once, it would be 79cm long and mass 7,000 x 1.1 = 7,700g. At TL14, an accelerator massing 7.2kg would have a DV of 153.

Energy	Mass by energy					DV	Length by mass			
	TL12	TL13	TL14	TL15	Mass		Length	Mass	Length	
200J	1130g	943g	808g	707g	17	1.0kg	33cm	7.4kg	165cm	
400J	1600g	1330g	1140g	1000g	24	1.2kg	38cm	7.6kg	168cm	
600J	1960g	1630g	1400g	1230g	30	1.4kg	43cm	7.8kg	172cm	
800J	2260g	1890g	1620g	1410g	34	1.6kg	48cm	8.0kg	175cm	
1000J	2530g	2110g	1810g	1580g	38	1.8kg	53cm	8.2kg	179cm	
1200J	2770g	2310g	1980g	1730g	42	2.0kg	58cm	8.4kg	182cm	
1400J	2990g	2490g	2140g	1870g	45	2.2kg	62cm	8.6kg	186cm	
1600J	3200g	2670g	2290g	2000g	48	2.4kg	67cm	8.8kg	189cm	
1800J	3390g	2830g	2420g	2120g	51	2.6kg	71cm	9.0kg	193cm	
2000J	3580g	2980g	2560g	2240g	54	2.8kg	76cm	9.2kg	196cm	
2500J	4000g	3330g	2860g	2500g	61	3.0kg	80cm	9.4kg	199cm	
3000J	4380g	3650g	3130g	2740g	66	3.2kg	84cm	9.6kg	203cm	
3500J	4730g	3940g	3380g	2960g	72	3.4kg	88cm	9.8kg	206cm	
4000J	5060g	4220g	3610g	3160g	77	3.6kg	93cm	10.0kg	209cm	
4500J	5370g	4470g	3830g	3350g	81	3.8kg	97cm	10.5kg	218cm	
5000J	5660g	4710g	4040g	3540g	86	4.0kg	101cm	11.0kg	226cm	
6000J	6200g	5160g	4430g	3870g	94	4.2kg	105cm	11.5kg	234cm	
7000J	6690g	5580g	4780g	4180g	101	4.4kg	109cm	12.0kg	242cm	
8000J	7160g	5960g	5110g	4470g	108	4.6kg	113cm	12.5kg	250cm	
9000J	7590g	6330g	5420g	4740g	115	4.8kg	116cm	13.0kg	258cm	
10kJ	8000g	6670g	5710g	5000g	121	5.0kg	120cm	13.5kg	266cm	
12kJ	8760g	7300g	6260g	5480g	133	5.2kg	124cm	14.0kg	274cm	
14kJ	9470g	7890g	6760g	5920g	143	5.4kg	128cm	14.5kg	282cm	
16kJ	10.1kg	8430g	7230g	6330g	153	5.6kg	132cm	15.0kg	290cm	
18kJ	10.7kg	8940g	7670g	6710g	163	5.8kg	135cm	15.5kg	297cm	
20kJ	11.3kg	9430g	8080g	7070g	171	6.0kg	139cm	16.0kg	305cm	
25kJ	12.6kg	10.5kg	9040g	7910g	192	6.2kg	143cm	16.5kg	313cm	
30kJ	13.9kg	11.5kg	9900g	8660g	210	6.4kg	147cm	17.0kg	320cm	
35kJ	15.0kg	12.5kg	10.7kg	9350g	227	6.6kg	150cm	17.5kg	328cm	
40kJ	16.0kg	13.3kg	11.4kg	10.0kg	242	6.8kg	154cm	18.0kg	335cm	
45kJ	17.0kg	14.1kg	12.1kg	10.6kg	257	7.0kg	157cm	19.0kg	350cm	
50kJ	17.9kg	14.9kg	12.8kg	11.2kg	271	7.2kg	161cm	20.0kg	365cm	

**Clips**

A particle beam clip can be internal, removable, external, or some combination of the above. A clip can contain multiple power sources, so a particle beam clip could contain both a battery, superconductors, and a small solar panel so it recharges itself when hooked onto a belt.

**Internal magazine**

Internal packs are an integral part of the weapon, and cannot be removed except by disassembly. Multiply the mass of all internal power components (batteries, capacitors, superconductors) by x1.1, and save this amount.

**Removable magazine**

Removable clips can be detached and replaced when discharged. The hardware required for this multiplies the mass of all removable components by x1.2. This is the "clip mass".

**External magazine**

External power packs consist of something like a backpack, connected to the weapon by a cable. The mass of this hardware multiplies the mass of all external power components by x1.3. This is also a "clip mass", but does not count towards the mass of the weapon for accessory or initiative purposes. The length of any power coupling is assumed to be at least long enough for normal use by a person carrying the weapon. Fixed installations are handled on an individual basis, but in these cases, the size of the power coupling will usually be small compared to the installation itself.

**Combinations** - Use the appropriate mass multiples for the different parts. If a weapon has an internal clip, and an external, detachable one, the mass of each depends on the number of shots it holds and whether it is internal or external to the weapon.

# Particle Beams

## Radiation effects

The relativistic particles produced by a particle beam do not all reach the target. Some interact with the air in the partially evacuated tunnel created by the leading edge of the beam. A side effect of this interaction is radiation. If your system has radiation rules, assume that there is a radiation exposure of 1%(n) of the DV surrounding each shot, which drops off in damage like an explosion. This exposure is reduced by armor and cover according to the rules in your system. Naturally, being hit with a particle beam causes a similar exposure, with localized effects that may hinder healing.

**Example** - A beam with a DV of 200 will cause 2 rads of exposure to anyone right next to the beam. A DV of 800 would do 8, 4, 2, 1 and 0 rads in the hexes to either side of the beam.

As a result, most particle beams have folding gun shields to protect the firer, or bell-shaped ends to produce a "cone of safety" for that person.

The secondary radiation effects may penetrate armor, even if the physical damage does not. If your system does not have special rules for this, divide the armor that was unpenetrated by a constant (100 in **TimeLords**), and apply the radiation to this.

**Example** - A particle beam with a DV of 500 hits an armored vehicle, doing an average of 275 points and 5 rads. If the armor was 300, 25 points of armor would be unpenetrated.  $25/100 = .25$ , so the occupant of the vehicle closest to the hit will probably take 5 rads -  $.25$  shielding = 4.75 rads. If the beam had a DV of 300, it would do an average of 165 points, leaving 135 unpenetrated, so radiation damage would be 3 rads -  $1.35$  shielding = 1.65 rads.

The rules for radiation exposure are entirely optional, and conversion to a particular system is at GM option.

## Accessories

All designs will need some sort of external fixtures, like stocks, trigger guards, sights and so on. These items will simply add a percentage to the mass of the unloaded weapon. The base mass includes the weapon and any internal energy system, but not the mass of any external power supply. A weapon (unloaded) plus accessories will mass:

$$(\text{accelerator} + \text{any internal clip}) \times \text{mass multiplier}$$

Detachable or external clips are separate items, and do not contribute to accessory mass. Add-ons like vision aids or solar panels add to mass *after* accessories are taken into account.

## Fixed mounts

Fixed mount weapons, or those which are a permanent part of a vehicle will have a mass multiplier of x1.1. The weapon will normally be unsuitable to be fired in any other way, although small examples may be cradled under the arm, or braced against a hip, at substantial penalties to hit a target. A fixed mount includes sights only if the firer would normally look directly over the weapon to fire it.

## Hand-held

Weapons designed to be fired by hand, without external encumbrances will have a mass multiplier of x1.2. The weapon is not designed to be fired from or mounted in any fixed mount or movable tracking system. A handheld weapon will include basic sights and grips for one or two hands. If a military longarm, provision for attaching a bayonet, grenade launcher or in some cases a telescopic or night sight may be included, and on civilian longarms, will usually include provision for mounting a telescopic sight. The mounts will include more advanced options at the higher TL's.

## Semi-fixed

A semi-fixed mount has all the features of both fixed and handheld mounts, and is usually applied to weapons like light machine guns, which may be carried, fired from a bipod, pindle or tripod. They have a mass multiplier of x1.3. A semi-fixed mount includes all advantages of the previous types, and in addition can be assumed to have a folding bipod, allowing more accurate fire from a prone position.

**Example** - A TL14 particle beam is designed with a base mass of 5.00kg. It is hand-held, so the final mass is  $5.00\text{kg} \times 1.2$ , or 6.00kg.

## Secondary characteristics

Like conventional weapons, particle beams will have secondary characteristics that you must decide upon yourself, or are functions of the design.

## Range Class

The aiming RC of a particle beam is based on the length of the completed weapon (not the unfolded accelerator). Most portable weapons will be "folded" designs.

Weapon length	Aiming RC	Weapon length	Aiming RC
less than 10cm	1	81-150cm	5
11-20cm	2	151-300cm	6
21-40cm	3	301-600cm	7
40-80cm	4	601+cm	8

For damage RC, use the RC that applies to *total accelerator length*. All energy weapons get a +20% chance (+4 on d20 systems) to hit due to different aiming characteristics and shorter travel time to target. All losses of DV due to range are decreased by 10%, but do not exceed the base damage. In a vacuum or where there is nothing to scatter the beam, losses are decreased by 40%.

### Inherent Accuracy

A particle beam weapon so designed is assumed to have a base IA of  $1/2(u)$  the aiming RC of the weapon. So, RC1 and RC2 weapons have an IA of 1, RC3 and RC4 weapons have an IA of 2, etc. The IA of a particle beam weapon can be influenced by cost, just like for conventional weapons.

### Rate of Fire

A pulsed particle beam weapon can have any rate of fire up to 10 shots per second per accelerator, or the number of shots in a clip, whichever is less. Civilian models may differ from military weapons only by having no autofire circuits, but are still capable of the high-rate of fire if modified by an electronics tech.

### Malfunction chance

Particle beams will have a chance of malfunction on a to hit roll of 20. A second d20 is rolled. If the result is 19, the weapon fires at half DV. If a 20 is rolled, the weapon does not fire due to electrical problems. It may be fired normally on the next action. Particle beams have a base reliability class of II. Critical failures will either destroy some internal electronic component or damage the accelerator in some way. Any particle beam whose sealed interior is breached will malfunction on the worst possible table (category VI), until it is repaired and resealed.

### Recoil

Particle beams do not have recoil, and take no recoil-based consecutive shot modifiers. However, the flash and sound of a beam fired in an atmosphere should cause a minimum (-1) consecutive shot penalty. Weapons designed with the special effect of being blasters, fusion beams or plasma cannon will use normal recoil rules, based on weapon DV.

### Weapon bulk

The bulk of a weapon is found by dividing its length in cm by 15, rounding fractions up. This is the number of **TimeLords** hit locations the weapon would cover if carried close to the body.

**Example** - If the previous weapon had a lasing apparatus 50cm long, the weapon length would be 4 locations long.

The size of each location depends on the weapon mass, as per the table below.

Mass per location	Bulk per location	BP per location
<.50kg	Very Small (VS)	(20-TL)/6
.51-4.0kg	Small (S)	(20-TL)/5
4.01-32.0kg	Medium (M)	(20-TL)/4
>32.0kg	Large (L)	(20-TL)/3

**Example** - A 6kg weapon that covered 4 locations would have a mass of 1.5kg per location, for a total bulk of four Small (S/4).

### Armor Value

The Armor Value of the weapon is a measure of how much physical abuse the weapon can withstand, and is based on the same scale as the DV. That is, 1 point of damage is stopped by 1 point of armor. Anything that gets through AV does actual damage to the weapon. The AV is a general number, and reflects the average of the entire weapon, rather than the specific damage resistance of the accelerator apparatus, etc. Individual components may vary by a great deal, and you may determine that a particular lasing technology is more or less durable than others. Particle beams generally have a lower AV, because electronics is not as durable as steel, regardless of what the electronics are housed in. The AV is based on the TL and energy of the weapon, and is based on the beam energy, with a minimum AV of 2.

$$\text{Energy of beam}^{.15} \times ((20\text{-TL})/4)(n)$$

**Example** - If a TL13 particle beam had a beam energy of 50,000J, its AV would be  $(50,000\text{J})^{.15} \times (20-13)/4 = 9$ .

### Power transmission

The same principle that allows a stunner to work can also be used for short range power transmission. The ionized path left by the particle beam is used as a power conduit. Energy dumped in at the firing end is siphoned off by a special apparatus at the receiving end, with losses equal to the reduction in DV for damage RC1. This could also be used as a bizarre form of "electric fence" or artificial lightning or electromagnetic pulse weapon.

**Example** - A DV3 particle beam has 10,000J of "stun" energy pumped into it, and aimed at a power receiver 300m away. The "DV" would take a -14 modifier (-70%), so the receiver picks up the remaining 30%, of  $10,000\text{J} \times .30 = 3,000\text{J}$ .

This low damage RC assumes transmission through an atmosphere. In a vacuum, presumably it could be more efficient provided you have a powerful enough beam. Just use a different damage RC to get the game-specific effect you are looking for.



# Particle Beams

## Body Points

The Body Points of the weapon are figured from the previous table as well. Fractions are kept, and the total BP from all locations is added together, and rounded nearest.

**Example** - If the previous weapon were TL13, it would have 1.75BP per location, for a total of 7BP.

Each level of increased mass or cost for any reason (except reduced mass) will decrease the effective TL by 1 for AV and BP purposes (heavier or more expensive weapons have more), and each level of decreased mass or cost will increase effective TL by 1.

## Initiative

The Initiative of the weapon is how easy it is to swing into position, and move about in close quarters. For instance, you can swing a light pistol to a certain arc faster than a heavy rifle. Initiative is function of weapon length and loaded mass in kilograms, but only for the energy sources carried on or in the weapon. External energy supplies may penalize a character because of encumbrance, but do not directly affect weapon Initiative. **Initiative** for particle beams is exactly the same as for conventional weapons (p.21).

## Cost

The base cost for a particle beam weapon is based on its DV. The price is in credits (Cr), where a credit is a generic unit of currency roughly equal to a modern US dollar in purchasing power.

$$\text{Cost} = (\text{DV of beam})^2 / 2 + 1,000\text{Cr}$$

**Example** - A weapon with a DV of 20 would have a base cost of 1,200Cr. A particle cannon with a DV of 1000 would have a base cost of 501,000Cr.

Cost is a TL-independent item. The Cr is supposed to apply to whatever standard of living applies in the game where this weapon is used. If average income or standard of living is lower, then prices will be correspondingly lower, but will still represent about the same amount of work by a person trying to save up for it. The amount of 100Cr represents the same fraction of an average person's income at TL12 as it does at TL15, or any other TL with money or exchange.

The base cost of a weapon is modified by the design and firing characteristics of the weapon.

Action	Cost	Weapon	Cost
Continuous	x1.1	Pistol	x2.0
Stunner	x1.1	Longarm	x1.0
Multiple accel.*	x1.8	Vehicle mount	x1.0
SA	x1.0		
AT & SA	x1.3	<b>Mass</b>	<b>Cost</b>
AT only	x1.0	x2.0	x.25
AB	x1.5	x1.5	x.50
Adjust. power	x1.1	x1.0	x1.0
Folded accel.	x1.1 per	x.75	x2.0
		x.50	x4.0

Extra clip       $\text{shots}^{-5} \times \text{weapon cost}/100$

\* the multiple applies to *each* extra accelerator on *any* multi-accelerator weapon

These multiply together, rather than adding, so an autoburst (x1.5) pistol (x2.0) would have a cost multiple of x3.0. Weapons with detachable magazines are assumed to come with *one*. Extra clips (/C) cost as shown. This cost is halved for external magazines (/E).

## Mass modifiers

Each x2.0 multiple on cost will reduce the mass of a weapon by 25% (with maximum reduction of 50%). Each x.50 multiple on cost will increase the mass by 50% (with maximum increase of 100%). This mass modifier applies to the unloaded weapon mass, and does not apply to ammunition (if any), although it will apply to the empty mass of any magazines (like empty clips). This modification to mass has no effect on the IA of the weapon.

## IA modifiers

The IA of the weapon may be increased by increasing the cost of the weapon. Each x2.0 multiple on cost will increase the base IA of the weapon by 50% (round nearest). Each x.50 multiple on cost will decrease the base IA of the weapon by 50% (round down). The IA of a weapon may never go below -1. Each point that IA is decreased due to cheapness is a +1 row modifier for determining malfunctions (particle beams are assumed to have a base chance of malfunction as per the 20-39% row).

The IA may also be increased by increasing the mass of the weapon, *if the weapon mass was not already increased to reduce weapon cost*. Each 50% increase in mass *and* cost will increase the IA by 50% (round nearest), with a maximum increase of 200% (total of 3x mass and cost). So, if a weapon with an IA of 1 was increased in mass and cost by 50%, its IA would go to 1.5, which rounds to 2.

The maximum IA of any weapon may never exceed 3 times the base IA for that weapon.

**Example** - A semi-auto pistol with a DV of 20 and an IA of 1 has a base cost of 2400Cr. For an increase in cost of 100% (+2400Cr), the IA goes to 1.5. For another increase in cost *and* mass of 100% (+2400Cr), the IA goes to 2.5, which rounds to 3. So, for a cost of 7200Cr, you can have this pistol in a heavy target version, with an IA of 3 instead of 1.

**Combined Example** - A semi-auto (SA) particle beam with a DV of 210 has a base cost of 23,050Cr. It has a damage and aiming RC of 6, and a base IA of 3. A three-barreled selective fire vehicle mount would cost  $1.3 \times 1.8 \times 1.8 \times 23,050 = 97,087\text{Cr}$ . Since it is a vehicle mount, it does get the RC of 6, and the chance to hit could be further increased by adding sensors.

If this weapon were built as a TL12 point defense system, it would mass about 50kg, and be about 264cm long (unfolded). Since each "capacitor bank" would mass about 150kg *per shot*, it might be powered directly from a large generator. At full ROF, it would require a power input of about 9 megawatts (a 12,000hp engine driving a 100% efficient generator).

## Advanced design

The following rules cover advanced or optional particle beam design rules, and may or may not find application in the game system you use.

### Adjustable output

With an adjustable particle beam, the beam power in Joules can be adjusted to any amount by the firer, usually by some convenient control on the outside of the weapon. It could also be a "factory pre-set" adjustable by a weaponsmith, but normally inaccessible to the casual user.

This option increases total particle beam cost (sans external options like sights) by 10%. Since power is stored in individual banks which are entirely discharged on firing, no extra shots are normally gained this way. Continuous beam particle beams will have increased firing time, however, since the drain on the battery is reduced. Beam diameter remains the same in all cases. All excess, "unused" power is dissipated through the weapon's heat sinks, which can be overloaded, so reduced power shots do not affect malfunction numbers.

**Optional** - You can "dodge" this rule by designing a clip which has many small storage banks, so one full power shot discharges several at once. You would use a smaller number of storage banks for low power shots, and get more shots per clip. However, each storage bank counts as a "shot" when computing clip cost. This dodge applies to any energy powered weapon. It does not affect the initial cost of the weapon, but will apply to the cost of any extra clips.

**Example** - Four 10,000J storage banks are used to fire a particle beam at full power. Using only one storage bank per shot would allow four times the number of shots per clip.

The ability to adjust shots is a function of the particle beam, as much as the clip. A non-adjustable particle beam cannot take advantage of an "adjustable" clip, and can only discharge 1 storage bank per shot, regardless of its energy capacity. An adjustable particle beam cannot take advantage of a "non-adjustable" clip, and must use whatever power a single storage bank provides. It might be able to adjust the beam, but still use the full energy. This also only applies in cases where weapons can use the clips from other weapons.

### Multiple Barrels

Particle beam tubes of the same or different damages in the same weapon get a 25% reduction in accessory weight, which is computed on the total of the barrels, and only applies if the smaller weapon is more than half the mass of the larger.

### Continuous Particle Beams

Particle beams designed for a continuous stream of energy must be powered by a constant power source, like a battery or generator. They are designed like a normal particle beam, but have all stats equal to a particle beam with a beam power of 100 times the actual power. The uses of such a weapon are up to the game system.

**Example** - A particle beam with a 200J constant output will mass as much as a 20,000J pulsed particle beam.

Continuous particle beams require power equal to 100 times the actual beam power each second of operation. Charging losses do not apply since the beam is powered directly from a battery or other power source, but the efficiency of the beam itself does.

**Example** - A TL12 continuous particle beam with a power of 200J will require  $200J \times 10 \times 100 = 200,000J$  per second of operation. This must be supplied by a battery or generator.

The effect of a continuous particle beam is like firing autofire, with a "rate of fire" of 10 shots per second. However, each of these hits will be more severe than normal. You can either count a continuous beam laser hit as 1d10 hits for purposes of penetrating armor, or assume the laser has a rate of fire of 100 shots per second for any autofire bonuses to hit in a particular game system. A low-power continuous beamer can with time, burn through something that a short pulse might not be able to.

**Example** - A 5,000J pulsed particle beam rifle (DV86) will probably have a switch allowing it to be used as a 50J continuous beam particle beam (DV9) powered from a battery pack, a useful function for crowd control or as a cutting tool. At TL15, this would need a minimum battery weight of .69kg (6.9g per second). At a 1% discharge rate, this would be good for 100 seconds of continuous fire.

### Stunners

A stunner can be made simply by sending a current down the ionized path a particle beam would create by its interaction with the atmosphere. A stun pulse from a particle beam weapon is not distinguishable from a regular particle beam. The usual particle beam DV is 1-3, and the weapon will have RC1 for purposes of damage, *regardless of its RC for aiming*. The DV of a stun pulse is  $(\text{Energy} \times .735)^5$ .

**Example** - If the particle beam sends a 2,500J pulse down the beam, the DV would be 43.

This shock effect is at half DV if the target is struck on a conductive armor that will stop the base particle beam damage. If this armor is grounded, or a non-conductive armor is not penetrated, the shock does no damage. If the armor is penetrated by the beam, the shock usually does full damage.

A normal particle beam may be made into a stunner for a 10% increase in accelerator mass and overall weapon cost. In this case, each stun blast consumes at least two charges from a clip, one for the beam, and one for the stun. Or, a switch could select the number of "charges" to be dumped into the stun pulse. Or, a charge could power both the accelerator and stun pulse, according to a fixed or adjustable ratio. Note that a particle beam stunner is an odd beast, in that you still dump significant radiation into a target you supposedly don't want to injure.

Weapons can also be designed as having two clips, one for the laser, the other for the stun. This might be more mass efficient, since the low DV laser beam will consume little power. Stun effects may be adjusted down as normal laser fire, and continuous beam stunners are possible, but they use huge amounts of power (100 stun pulses per second).

# Particle Beams

## Plasma cartridges

You may have in mind some technology that stores sufficient energy for a plasma pulse, and which can be loaded into a weapon like a cartridge. This could simply be a big superconductor module, complicated high-energy chemical cell, or maybe a magnetically confined bit of antimatter, monopoles, or some such. The power that can be stored in this is up to you. Particle beams in **3G<sup>3</sup>** are mainly supposed to be support weapons rather than an individual armament. The limited efficiency and number of shots is offset by the long range, radiation side effects, and near-light-speed beam velocity.

## Plasma beams

**3G<sup>3</sup>** frowns upon the notion of plasma beam weapons. Calculations for radiated energy dissipation in air seem to indicate that a plasma beam of useful power would be more like a pipe full of TNT than a point target weapon. That is, you hold onto one end, and the target of the attack holds onto the other. If you insist on designing such weapons, they would be handled like a continuous beam laser. That is, design an accelerator for a beam of 100 times the power you intend to use, and count it as firing 100 shots a second for power consumption purposes. All other special effects (like radiation) would be as for other particle beams.

Plasma weapons which fire discrete, individual shots (plasma torps) are built using normal particle beam rules. The bore diameter of the weapon should be increased by a factor of 10 as a "special effect", as you wouldn't really expect 5mm plasma balls to do all that much. For pseudo-science purposes, assume that a plasma bolt or ball is like ball lightning with a fusion plasma core, a metastable magnetic field generated by the plasma itself, which dissipates upon contact with a solid object, releasing the plasma energy onto the target. In this case, the weapon would be a plasma source and possibly a magnetic or electrostatic accelerator to speed the plasma on its way, possibly siphoning energy from the plasma ball itself for this purpose. Such a plasma ball or bolt would still radiate immense amounts of heat and light, pinpointing the firer and necessitating a blast shield to prevent the flash burns a small sun igniting in front of you would cause.

## Sample weapon design

As a medium complexity example of the design rules, see below. See the various rule sections if there is *any* part you don't understand.

### Project - 5mm Particle rifle, TL15

#### Specs

The final product is a 20,000J adjustable autoburst rifle with a 5 shot internal clip and a bore of 5mm. It has an backpack power supply for 50 shots and a .25m<sup>2</sup> solar array.

#### Damage Value

The DV of a 5mm, 20,000J particle beam is 171, which is reasonably high, but not all that impressive for TL15. It has other fixed DV settings, and can fire twice as many shots at a DV of 121, or four times as many shots at a DV of 86.

$$(20,000J \times .735/.5)^5 = 171 \quad (10,000J \times .735/.5)^5 = 121 \quad (5,000J \times .735/.5)^5 = 86$$

#### Power

At TL15, the beam requires  $20,000J \times 4.0 = 80,000J$  of storage, for a mass of  $80,000J/375J$  per gram = 213g per shot, or a total superconductor mass of  $213g \times 5$  internal shots = 1,065g. Since the storage is internal, the mass multiplier is x1.1, for a total internal mass of  $1065g \times 1.1 = 1,170g$ . The backpack supply masses 50 shots  $\times 213g$  per shot  $\times 1.3 = 13,800g$ . The solar panel has an area of 625cm<sup>2</sup>, which provides a constant output of  $625cm^2 \times .05J = 31J$  per second. This is virtually useless from a recharging standpoint, but is sufficient to offset losses from electronic sights, radios, etc.

#### Accelerator

A 20,000J accelerator masses 7,070g at TL15, taken from the table on page 51. A mass of 7,070g makes its length around 159cm.

#### Accessories

This weapon can be vehicle mounted to take advantage of a generator. Accessories have a multiple of x1.3, and are based on accelerator + internal clip. Weapon mass is 10.7kg.

$$(7,070g + 1,170g) \times 1.3 = 10,700g$$

#### Range Class

Aiming RC is based on overall length, which is about 159cm, for an aiming RC of 6 (4 if hand-held). Damage RC is based on accelerator length (159cm), which is an RC of 6, for a final handheld RC of 4/6. The IA is half the aiming RC, or 2.

#### Weapon bulk

Since the weapon is 159cm long (exactly), it is 11 locations long, and its mass of 10.7kg (.97kg per location) means these will be Small locations, for S/11.

#### AV and BP

The AV is based on beam energy and TL, and is 6. The BP are based on its bulk, and it has 1 per location, for a total of 11.

$$20,000J^{.15} \times ((20-TL15)/4) = AV6$$

#### Initiative

The rifle has a bulk of S/11 and a mass of 10.7kg, so the table on **p.21** shows it has an Initiative of -3.

#### Rate of fire

Since this is a military autoburst weapon, we say the ROF is up to 20, in up to 4 bursts of 5 shots each.

#### Cost

The cost of the weapon is based on the DV, action type, TL that it is a rifle, and is:

$$(DV1712/2 + 1,000) \times 1.5 (AB) \times 1.0 (rifle) \times 1.1 (adj.) = 25,800Cr$$

## Railguns

The term railgun will apply to any magnetically accelerated projectile, regardless of the technology used to get the job done. Railguns may also be called mag guns, gauss rifles, mass drivers or coil guns but the basic idea is the same. A ferromagnetic (like iron) projectile is accelerated down a "barrel" by a magnetic field or series of fields.

<b>Technical notes</b>	This is the first TL where railguns can be developed. Given the lack of portable power supplies, they are really only useful as science-fiction props, or stationary emplacements of some kind.	TL8 (circa 1900AD)
<b>Historical notes</b>	Not historically possible at this TL.	
<b>Technical notes</b>	If known at TL8, it could be developed as a possible weapons technology for WWII, but the technical sophistication of the end product would be too high for the average tank gunner to reliably use, and the DV would hardly be competitive with conventional weapons.	TL9 (circa 1930AD)
<b>Historical notes</b>	Not historically possible at this TL.	
<b>Technical notes</b>	Most of the limits of TL9 apply, but transistors and simple computers allow optimization of timing pulses, allowing for smaller power supplies and greater efficiency.	TL10 (circa 1980AD)
<b>Historical notes</b>	The first experiments with magnetically accelerated projectiles begin, using coilguns.	
<b>Technical notes</b>	If you try very hard, you can make a useful, portable magnetically accelerated weapon.	TL11 (circa 1980AD)
<b>Historical notes</b>	Railguns achieve muzzle velocities of over 5km per second, and research is actively funded by the government as a possible anti-missile technology. Research funding is also given to see the feasibility of vehicle-mounted railgun or coilgun artillery.	
<b>Technical notes</b>	A semi-practical railgun weapon can be made, but power supplies limit the number and power of shots.	TL12 (circa 2000AD)
<b>Historical notes</b>	None yet.	
<b>Technical notes</b>	The advent of room-temperature superconductors makes railguns practical, much more so than any other energy-powered weapon. The first real military gauss rifle is likely at TL13.	TL13 (circa 2100AD)
<b>Historical notes</b>	None yet.	
<b>Technical notes</b>	Doubling the efficiency of superconductors from 125J per gram to 250J per gram makes railguns much more effective, but increased DV's are offset by increased weapon length to get them.	TL14 (circa 2200AD)
<b>Historical notes</b>	None yet.	
<b>Technical notes</b>	This is as highly advanced as railguns get in 3G <sup>3</sup> . Provided you are willing to put up with the length, a person can carry a weapon equivalent to a small TL11 cannon. Autofire railguns can have appallingly high rates of fire, and are useful as anti-missile weapons or area-effect weapons.	TL15 (circa 2300AD)
<b>Historical notes</b>	None yet.	

## Basics

Electromagnetic projectile accelerators come in two main flavors, mass drivers and railguns. In mass drivers, the barrel is surrounded by magnetic coils. When the first coil is activated, a magnetic projectile is drawn forward slightly, at which point the second coil is activated, accelerating the projectile more, and so on. With a large number of coils, usefully high velocities can be obtained. Even higher velocities are possible if the projectile is itself a coil, powered by contacts on the launch rails. This increases the acceleration, and allows it to be pushed as well as pulled, simply by reversing the polarity at the right point. It is more or less like an electric motor, but instead of going in circles, it is laid flat. These are the first development of magnetic acceleration technology, and most designs of TL11 or less will probably work on this principle.

## Compatibility

At TL's of 12 or less, railguns will be built around a particular projectile and a particular energy. You cannot simply change projectiles or use more or less energy, and expect it to work well.

At TL13+, electronics and design technology will be advanced enough that a weapon bought with the adjustable power advantage will be able to select from a variety of energy and projectile types, so long as they will fit in the weapon, and not warp under the energy stress. Mechanically, the ammunition feeding mechanism will likely need replacement of parts to handle projectiles of different l/w ratios, although they could probably be loaded one at a time (single shot) without too much trouble. Railgun projectiles will almost always have to be the same diameter to be compatible. Beyond that, manufacturers may make their weapons deliberately more or less compatible, by having oddly shaped bores or projectiles. Whether or not any two weapons fire compatible ammunition is up to the designer.

## The matter of size

Bore size, that is. Both conventional weapons and railguns have the ability to use projectiles as small as 2mm, and you'll probably get around to designing weapons like that eventually. The problem is the mechanical complexity and precision required for such an action. The smallest projectiles in use at TL11 are 4.5mm, as a comparison. Consider that a speck of dirt 1/100th of an inch in diameter is over 10% of the diameter of your 2mm projectile. This is comparable to putting gravel in the barrel and action of a tank cannon. You can see that keeping the weapon scrupulously clean is mandatory, and that usual military conditions may not allow for this. We recommend a minimum bore diameter of 3mm for any civilian projectile weapon, and 4mm for any military weapon, even though the rules allow you to make weapons with smaller bores at the higher TL's.



# Railguns

## Railgun Design

Railgun projectiles are treated like any other conventional projectile, with the exception that all rounds will usually either be iron (sg7) or lightweight (sg3). The sg3 projectiles are either aluminum or plastic, with some form of iron or magnetic sheathing, although railguns really only require a conductor, and can throw chunks of aluminized plastic (sg1) for use in a vacuum. The only way to fire sg11 projectiles is to treat them as magnetically coated depleted uranium, with the increased cost this entails. Since a railgun can directly fire 10:1 l/w ratio projectiles, they never need to use discarding sabot rounds, and sg3 rounds are usually HE or fragmentation. For use in vacuum, sg3 rounds made of a magnetic coating on a lighter substrate are preferred, as they will mass less and go faster. Since there is no atmosphere to create drag, any projectile in a vacuum will retain full velocity indefinitely, i.e. it gets maximum damage at all ranges. For atmospheric use, 10:1 iron projectiles are preferred, as they give a good mass with a small diameter, giving a good RC for damage. Only depleted uranium is better, but it costs much more than normal.



Railguns operate by creating an intense magnetic field between two launch rails. Any flow of current creates a magnetic field, and the extremely powerful pulses of a railgun create an enormous magnetic flux. Originally, the projectile was fired between the rails at about 1,000m/sec, where it contacted the rails, and generated the initial magnetic field. This was compressed by charges of explosive on both rails, which squeezed the magnetic field like toothpaste out of a tube. The projectile rode this field, one step in front of the explosion. This had certain limits as far as weapon potential. Eventually the same effect was duplicated without having to rebuild the weapon every shot. At the time of this printing, tests have achieved velocities of over 10 kilometers per *second*. At this velocity, even tiny projectiles can do an enormous amounts of damage (see note on [p.14](#)).

Railgun or mass driver projectiles do damage like regular bullets. The projectiles can have excellent range and penetration without sabots, are quieter and lighter than particle beams, and penetrate obscuration better than lasers. However, they are noisier than lasers, not recoilless, and don't get the better range tables that energy weapons do.

## Tech Level

The first thing you need to decide on is the Tech Level of the weapon, tweaked to match whatever your personal perceptions are of what should and should not be possible at a given TL.

## Damage Value

Then, you have to have some idea what you want the railgun to do, and an approximate DV. Next, you need to figure out the actual DV, and the energy needed to get that level of damage. The same formulas and restrictions on conventional weapons apply regarding velocity, range and projectile size. The DV of various projectiles based on energy and diameter is below. The DV of a railgun projectile is:

$$((\text{Energy in Joules} \times .735) / \text{projectile diameter in mm})^5$$

A railgun has a minimum projectile diameter based on its energy. This takes into account the need of the projectile to withstand the launching stress, for the accelerator to have sufficient magnetic "grip" on the projectile to attain maximum power, and problems like simple mechanical tolerance. The minimum diameter of a railgun projectile in millimeters is:

$$(\text{Energy in Joules})^{.4/50}$$

The absolute minimum projectile diameter is 2mm, as for conventional guns, and only railguns with an energy of more than 100kJ will require projectiles larger than 2mm. Railguns designed only for vacuum use can be extraordinarily deadly by using only 2mm projectiles, but they are almost useless in atmosphere because they shed velocity so rapidly or melt due to atmospheric friction. Diameters for a given energy and corresponding DV's are on the next page.

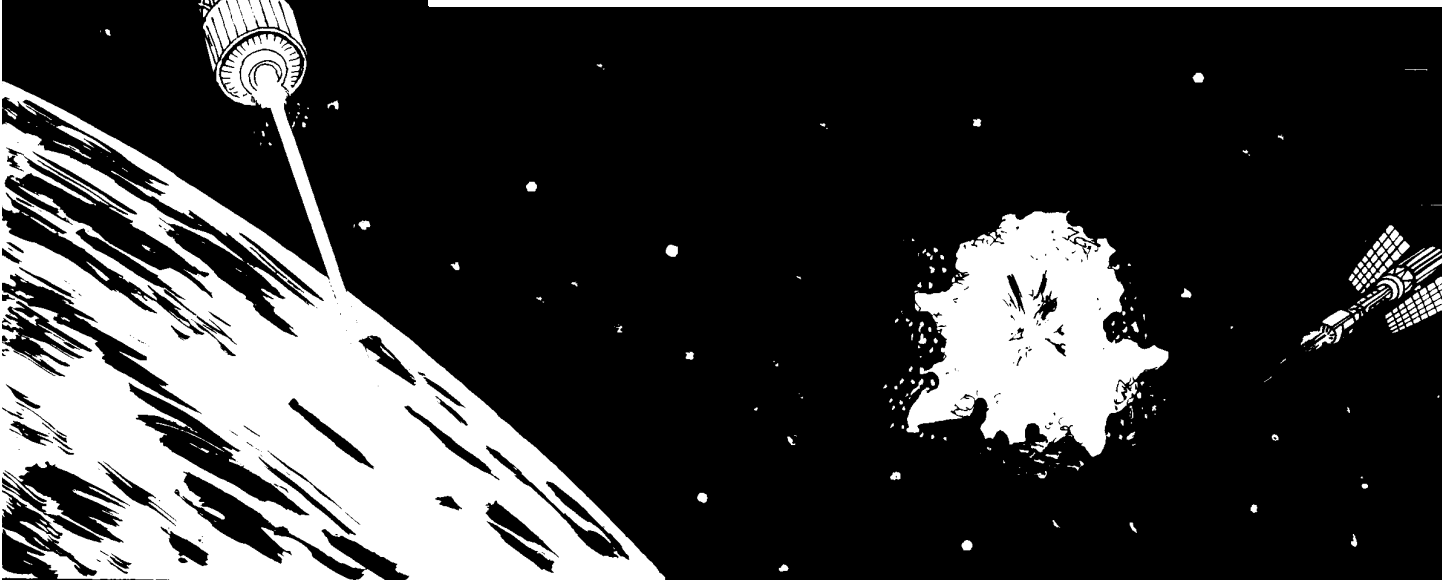



Energy	Damage Value						
	2mm	3mm	4mm	5mm	6mm	7mm	8mm
100J	19	16	14	12	11	10	10
200J	27	22	19	17	16	15	14
400J	38	31	27	24	22	20	19
600J	47	38	33	30	27	25	23
800J	54	44	38	34	31	29	27
1000J	61	49	43	38	35	32	30
1200J	66	54	47	42	38	36	33
1400J	72	59	51	45	41	38	36
1600J	77	63	54	48	44	41	38
1800J	81	66	58	51	47	43	41
2000J	86	70	61	54	49	46	43
2500J	96	78	68	61	55	51	48
3000J	105	86	74	66	61	56	53
3500J	113	93	80	72	65	61	57
4000J	121	99	86	77	70	65	61
4500J	129	105	91	81	74	69	64
5000J	136	111	96	86	78	72	68
6000J	148	121	105	94	86	79	74
7000J	160	131	113	101	93	86	80
8000J	171	140	121	108	99	92	86
9000J	182	148	129	115	105	97	91
10kJ	192	157	136	121	111	102	96
12kJ	210	171	148	133	121	112	105
14kJ	227	185	160	143	131	121	113
16kJ	242	198	171	153	140	130	121
18kJ	257	210	182	163	148	137	129
20kJ	271	221	192	171	157	145	136
25kJ	303	247	214	192	175	162	152
30kJ	332	271	235	210	192	177	166
35kJ	359	293	254	227	207	192	179
40kJ	383	313	271	242	221	205	192
45kJ	407	332	288	257	235	217	203
50kJ	429	350	303	271	247	229	214

### Efficiency

The efficiency of a railgun will vary widely with TL, and is generally  $(TL-7) \times 5\%$ , the same as a laser. However, the railgun can put its energy into a projectile less than 5mm in diameter, so it will have a better DV for that energy expenditure at any given TL. A railgun's efficiency applies to two separate steps. First, the storage bank has to power the railgun directly, and second, some form of battery has to recharge the storage bank. So, efficiency cuts twice if you have to recharge the storage banks from a battery pack or other limited source.

### General notes

Railguns are probably the most efficient of the weapons available at higher TL's using this design system. The lower efficiency of electrical energy storage is offset by the ability to use smaller projectiles for a better penetration, and the limits of small projectiles are offset by the ability to directly fire armor-piercing flechettes, which retain their damage downrange much better than other types of projectile.

Is there any reason to design any other type of hand-held weapon, then? Well, railguns *do* have their limitations. Conventional firearms will be more efficient for lobbing large, heavy payloads like conventional explosives. Railguns are by their nature a higher-tech device with much tighter manufacturing tolerances. They might not survive conditions that conventional weapons would laugh at. Would a TL14 railgun survive a trip through a cement mixer full of sand and mud as well as an old AK-47? Similarly, covert manufacture of a railgun in a repressive society would be harder, and carrying one concealed might be susceptible to remote detection because of energy leakage from its circuits.

On the other hand, a railgun would leave less forensic evidence behind than a conventional firearm, though more than a laser or particle beam, an advantage for criminal use.

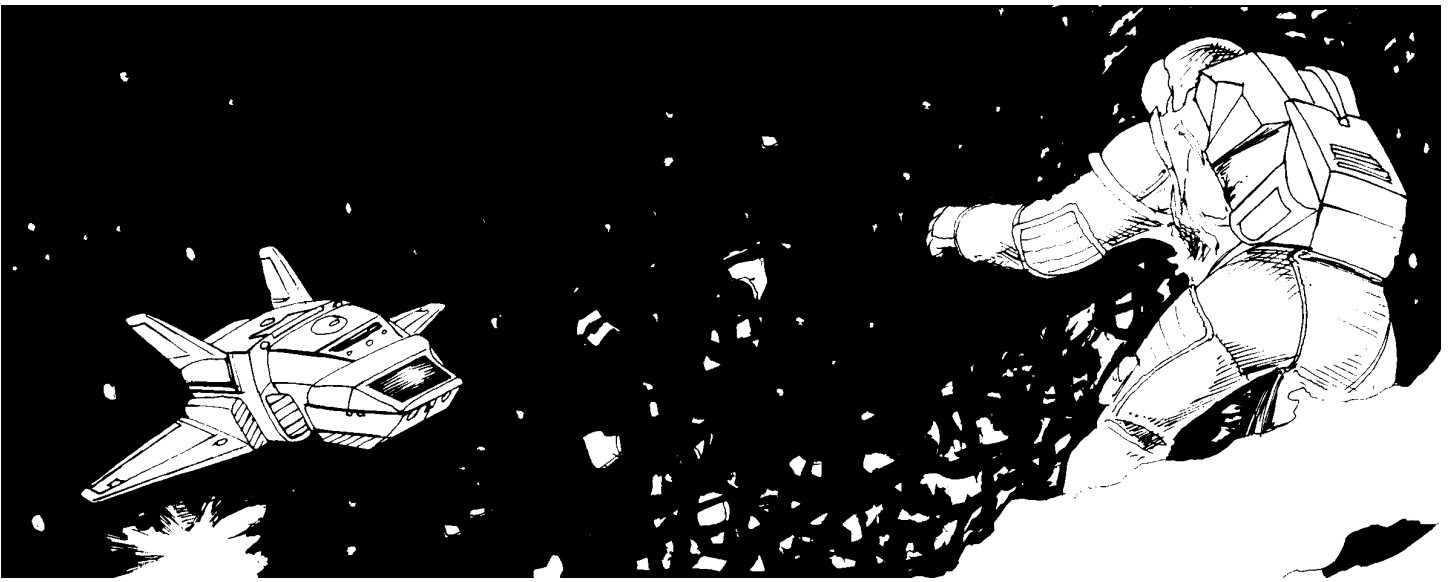

# Railguns

## Why is it so unwieldy?

The barrel or accelerator of a railgun is usually longer than on other weapons of the same DV because, unlike energy weapons, the barrel cannot be "folded" down to a shorter length. A weapon *may* have a long barrel that breaks down for transport, but it usually cannot be fired when disassembled. More than anything else, this limits the damage a hand-held weapon can generate. Conceivably, the weapon could be fired with a shorter barrel, at reduced DV, but would be more expensive than a standard take-down design. A normal take-down design costs and masses like a folded laser (+10% per "fold").

## Advanced design

Some varieties of railgun weapons will differ from the basic rules, as follows.

## Discarding Sabot Rounds

These are usually not needed for railguns, but if used, they will follow the rules for conventional guns (p.22).

## HE Rounds

As for conventional weapons (p.23).

## HEAT Rounds

As for conventional weapons (p.23).

## Frag Rounds

As for conventional weapons (p.24).

## Multiple In-line Projectiles

Not possible with railguns unless designed as a discarding sabot round, with the central penetrator instead being up to six separate spherical projectiles, three 2:1 projectiles or two 3:1 projectiles (p.25).

## Guided Rounds (all types)

As for conventional weapons (p.32).

## Rocket-assisted Projectiles

As for conventional weapons (p.31).

In practical terms, it means that the muzzle energy you want for a projectile will require a much greater input of electrical energy, as shown below.

TL	100J of beam energy requires	which requires	Multiple
8	2,000J of storage bank	40,000J of battery	x20.0
9	1,000J of storage bank	10,000J of battery	x10.0
10	670J of storage bank	4,490J of battery	x6.7
11	500J of storage bank	2,500J of battery	x5.0
12	400J of storage bank	1,600J of battery	x4.0
13	330J of storage bank	1,090J of battery	x3.3
14	290J of storage bank	841J of battery	x2.9
15	250J of storage bank	625J of battery	x2.5

**Example** - At TL15, a railgun with a projectile energy of 1,000J will need 2,500J of input, and require 6,250J to charge. At TL12, it would take 4,000J and 16,000J, respectively.

## Accelerator Mass

This is the "barrel" of the weapon. It may fire fin- or spin-stabilized projectiles. Once designed, a railgun can get no benefit from increased or decreased accelerator length, as the weapon is usually optimized for a particular projectile. The mass of the magnetic accelerator is based on the projectile energy, and its mass in grams is:

$$((\text{Energy in Joules})^{-5} \times 300) / (\text{TL}-7)$$

The table below lists a variety of accelerator masses based on energy and TL.

Energy	TL8	TL9	TL10	TL11	TL12	TL13	TL14	TL15
100J	3000g	1500g	1000g	750g	600g	500g	430g	380g
200J	4240g	2120g	1410g	1060g	850g	710g	610g	530g
400J	6000g	3000g	2000g	1500g	1200g	1000g	860g	750g
600J	7350g	3670g	2450g	1840g	1470g	1220g	1050g	920g
800J	8490g	4240g	2830g	2120g	1700g	1410g	1210g	1060g
1000J	9490g	4740g	3160g	2370g	1900g	1580g	1360g	1190g
1200J	10.4kg	5200g	3460g	2600g	2080g	1730g	1480g	1300g
1400J	11.2kg	5610g	3740g	2810g	2240g	1870g	1600g	1400g
1600J	12.0kg	6000g	4000g	3000g	2400g	2000g	1710g	1500g
1800J	12.7kg	6360g	4240g	3180g	2550g	2120g	1820g	1590g
2000J	13.4kg	6710g	4470g	3350g	2680g	2240g	1920g	1680g
2500J	15.0kg	7500g	5000g	3750g	3000g	2500g	2140g	1880g
3000J	16.4kg	8220g	5480g	4110g	3290g	2740g	2350g	2050g
3500J	17.8kg	8870g	5920g	4440g	3550g	2960g	2540g	2220g
4000J	19.9kg	9490g	6320g	4740g	3790g	3160g	2710g	2370g
4500J	20.1kg	10.1kg	6710g	5030g	4020g	3350g	2870g	2520g
5000J	21.2kg	10.6kg	7070g	5300g	4240g	3540g	3030g	2650g
6000J	23.2kg	11.6kg	7750g	5810g	4650g	3870g	3320g	2900g
7000J	25.1kg	12.6kg	8370g	6270g	5020g	4180g	3590g	3140g
8000J	26.8kg	13.4kg	8940g	6710g	5370g	4470g	3830g	3350g
9000J	28.5kg	14.2kg	9490g	7120g	5690g	4740g	4070g	3560g
10kJ	30.0kg	15.0kg	10.0kg	7500g	6000g	5000g	4290g	3750g
12kJ	32.9kg	16.4kg	11.0kg	8220g	6570g	5480g	4690g	4110g
14kJ	35.5kg	17.8kg	11.8kg	8870g	7100g	5920g	5070g	4440g
16kJ	38.0kg	19.0kg	12.7kg	9490g	7590g	6320g	5420g	4740g
18kJ	40.3kg	20.1kg	13.4kg	10.1kg	8050g	6710g	5750g	5030g
20kJ	42.4kg	21.2kg	14.1kg	10.6kg	8490g	7070g	6060g	5300g
25kJ	47.4kg	23.7kg	15.8kg	11.9kg	9490g	7910g	6780g	5930g
30kJ	52.0kg	26.0kg	17.3kg	13.0kg	10.4kg	8660g	7420g	6500g
35kJ	56.1kg	28.1kg	18.7kg	14.0kg	11.2kg	9350g	8020g	7020g
40kJ	60.0kg	30.0kg	20.0kg	15.0kg	12.0kg	10.0kg	8570g	7500g
45kJ	63.6kg	31.8kg	21.2kg	15.9kg	12.7kg	10.6kg	9090g	7950g
50kJ	67.1kg	33.5kg	22.4kg	16.8kg	13.4kg	11.2kg	9580g	8390g

**Example** - At TL14, a 2,000J accelerator would have a mass of 1,920g, or 1.92kg. Checking the previous table, it would have a DV of 86 if firing a 2mm projectile.

## Accelerator Length

The length of the accelerator is based on the mass and diameter of the projectile, and is:

$$\text{Length (cm)} = \left( \frac{\text{Mass in grams}}{6} \right)^{0.8} / \left( (\text{Projectile diameter in cm} \times 2)^{-5} \times 3.1416 \right)$$

The table below lists a variety of accelerator lengths, based on accelerator mass and the projectile diameter.

Mass	2mm	3mm	4mm	5mm	6mm	7mm	8mm	9mm	10mm
500g	17cm	14cm	12cm	11cm	10cm	9cm	9cm	8cm	8cm
600g	20cm	16cm	14cm	13cm	12cm	11cm	10cm	9cm	9cm
700g	23cm	19cm	16cm	14cm	13cm	12cm	11cm	11cm	10cm
800g	25cm	21cm	18cm	16cm	15cm	13cm	13cm	12cm	11cm
900g	28cm	23cm	20cm	18cm	16cm	15cm	14cm	13cm	12cm
1000g	30cm	25cm	21cm	19cm	17cm	16cm	15cm	14cm	13cm
1100g	33cm	27cm	23cm	21cm	19cm	17cm	16cm	15cm	15cm
1200g	35cm	28cm	25cm	22cm	20cm	19cm	17cm	16cm	16cm
1300g	37cm	30cm	26cm	24cm	21cm	20cm	19cm	18cm	17cm
1400g	39cm	32cm	28cm	25cm	23cm	21cm	20cm	19cm	18cm
1600g	44cm	36cm	31cm	28cm	25cm	23cm	22cm	21cm	20cm
1800g	48cm	39cm	34cm	31cm	28cm	26cm	24cm	23cm	22cm
2000g	52cm	43cm	37cm	33cm	30cm	28cm	26cm	25cm	23cm
2200g	57cm	46cm	40cm	36cm	33cm	30cm	28cm	27cm	25cm
2400g	61cm	50cm	43cm	38cm	35cm	32cm	30cm	29cm	27cm
2600g	65cm	53cm	46cm	41cm	37cm	35cm	32cm	31cm	29cm
2800g	69cm	56cm	49cm	43cm	40cm	37cm	34cm	32cm	31cm
3000g	73cm	59cm	51cm	46cm	42cm	39cm	36cm	34cm	32cm
3500g	82cm	67cm	58cm	52cm	47cm	44cm	41cm	39cm	37cm
4000g	91cm	75cm	65cm	58cm	53cm	49cm	46cm	43cm	41cm
4500g	100cm	82cm	71cm	64cm	58cm	54cm	50cm	47cm	45cm
5000g	109cm	89cm	77cm	69cm	63cm	58cm	55cm	52cm	49cm
5500g	118cm	96cm	83cm	75cm	68cm	63cm	59cm	56cm	53cm
6000g	126cm	103cm	89cm	80cm	73cm	68cm	63cm	60cm	57cm
6500g	135cm	110cm	95cm	85cm	78cm	72cm	67cm	64cm	60cm
7000g	143cm	117cm	101cm	90cm	83cm	76cm	72cm	67cm	64cm
7500g	151cm	123cm	107cm	96cm	87cm	81cm	76cm	71cm	68cm
8000g	159cm	130cm	113cm	101cm	92cm	85cm	80cm	75cm	71cm
8500g	167cm	136cm	118cm	106cm	96cm	89cm	84cm	79cm	75cm
9000g	175cm	143cm	124cm	111cm	101cm	93cm	87cm	82cm	78cm
9500g	183cm	149cm	129cm	115cm	105cm	98cm	91cm	86cm	82cm
10.0kg	190cm	155cm	135cm	120cm	110cm	102cm	95cm	90cm	85cm
20.0kg	331cm	270cm	234cm	209cm	191cm	177cm	166cm	156cm	148cm

**Example** - An accelerator that massed 4000g would be 91cm long if it fired a 2mm projectile, but only 58cm long if it fired a 5mm projectile.

## Receiver

Like regular firearms, railguns will require a receiver to handle the movement of ammunition from its storage area into the magnetic accelerator. It will need to handle much less stress than conventional weapons, though. The receiver can be in as many forms as for conventional guns. While it would be unusual to have a revolver gauss pistol, it could be done, so...

The mass of the receiver is a fraction of the accelerator mass, and depends on the type of action. Receiver mass equals accelerator mass x action multiple. Action multiples are:

Action	Multiple	Action	Multiple
AT/AB	x.10	B	x.04
SA	x.06	RV	x.02
LA	x.05	SS	x.02

**Example** - An accelerator with a mass of 5000g, designed as an automatic weapon, will need to have a total receiver mass of 500g.

## Shotguns and Canister Rounds

As for conventional weapons. The railgun cannot fire multiple flechettes the length of the normal projectile if the normal projectile is already a flechette (10:1 l/w), as the smaller flechettes would be far too narrow. Rounds the proper length for feeding may be engineered, but will only fire shorter flechettes of a smaller diameter. The multiple projectiles will be in a very light-weight sabot or casing which fragments harmlessly upon leaving the weapon (1/10th the DV of a slug), but is strong enough to prevent separation in the accelerator.

**Example** - A 10mm railgun would fire a single 10:1 l/w projectile 100mm long. While it could also fire 3mm flechettes, they would only be 30mm long, not 100mm, and would probably be stacked in 3 layers of 12 each.

Because railguns already have an advantage in that they can fire narrower projectiles, any multiple-projectile railgun is probably a special purpose weapon, like an assault shotgun.

The range characteristics of the smaller projectiles must be figured separately for each type of ammunition.

All other rules specific to multiple projectile rounds for regular weapons (multiple hits, close range hits, etc.) will also apply to railguns (p.23).

Flechettes will get multiple hits as for an equivalent quantity of pellets. For range effects on damage, be sure to use the proper damage RC for the flechette diameter used.

## Adjustable Output

As for lasers and particle beams (p.46).

## Combined Weapons

As for conventional weapons (p.27).

## Multiple Caliber Weapons

As for conventional weapons (p.28).

## Add-ons

As for conventional weapons (p.28).

# Railguns

## Clip/Magazine

The ammunition for the weapon must be carried somewhere. This will generally be referred to as a magazine or clip, regardless of the actual form it takes. As with binary propellant conventional weapons, the projectiles and energy supply do not have to have the same form of clip. For instance, the projectiles could be in a detachable clip, while the energy supply could be entirely internal and non-removable.

### Internal magazine

The projectiles and/or energy storage are completely in the weapon, and cannot be removed. When empty, they must be refilled from an outside source. Multiply the mass of all internally held components (batteries, capacitors, superconductors, projectiles) by x1.1 to get the loaded mass of the system. Do not count projectile mass when computing accessory mass, however.

### External magazine

This is a feed box, separate from the weapon, and may include special ammo handling machinery to get the rounds from storage to weapon, like mechanical ammo links, flexible conduits, power couplings, etc. Multiply the mass of all externally held components (batteries, capacitors, superconductors, projectiles) by x1.3 to get the loaded mass of the system.

### Detachable clip

This is a spring or gravity-fed magazine that attaches directly to the weapon, and which can be removed quickly and easily for reloading or replacement. Multiply the mass of all externally held components (batteries, capacitors, superconductors, projectiles) by x1.2 to get the loaded mass of the system.

### Revolver clip

A revolver has a rotating cylinder which contains the projectiles, which pass in front of the barrel for each shot. The mass of such a system is (.166 x receiver mass x number of rounds carried).

## Accessories

All designs will need some sort of external fixtures, like stocks, trigger guards, sights and so on. These items will simply add a percentage to the mass of the unloaded weapon. The base mass includes the weapon and any internal energy system, but not the mass of any external power supply. A weapon (unloaded) plus accessories will mass:

$$(\text{Accelerator mass} + \text{receiver mass} + \text{any internal clip}) \times \text{mass multiplier}$$

Detachable or external clips are a separate item, and do not contribute to accessory mass. Add-ons like solar panels or vision aids add to weapon mass *after* accessories are taken into account.

### Fixed mounts

Fixed mount weapons, or those which are a permanent part of a vehicle will have a mass multiplier of x1.1. The weapon will normally be unsuitable for firing in any other way, although small examples may be cradled under the arm, or braced against a hip, at substantial penalties to hit a target. A fixed mount includes sights only if the firer would normally look directly over the weapon to fire it.

### Hand-held

Weapons designed to be fired by hand, without external encumbrances will have a mass multiplier of x1.2. The weapon is not designed to be fired from or mounted in any fixed mount or movable tracking system. A handheld weapon will include basic sights and grips for one or two hands. If a military longarm, provision for attaching a bayonet, grenade launcher (TL10+) or in some cases a telescopic (TL10+) or night sight (TL11+) may be included, and on civilian longarms, will usually include provision for mounting a telescopic sight (TL8+). These features will be less common, but available at lower TL's.

### Semi-fixed

A semi-fixed mount has all the features of both fixed and hand-held mounts, and is usually applied to weapons like light machine guns, which may be carried, fired from a bipod, pintle or tripod. They have a mass multiplier of x1.3. A semi-fixed mount includes all advantages of the previous types, and in addition can be assumed to have a folding bipod, allowing more accurate fire from a prone position.

**Example** - A TL14 railgun is designed with a base mass of 5.00kg. It is hand-held, so the final mass is 5.00kg x 1.2, or 6.00kg. This extra 1.0kg includes the stock, grip, and sights, and attachment points for other optional features.

## Range Class

Range Class is determined as for conventional projectile weapons, based on accelerator length, projectile mass, diameter and velocity. The table is repeated below for your convenience.

Barrel length/projectile diameter	Minimum	Aiming RC
Length <10x projectile diameter	<10cm	RC1
Length 11-20x projectile diameter	10cm	RC2
Length 21-40x projectile diameter	20cm	RC3
Length 41-80x projectile diameter	40cm	RC4
Length 81-150x projectile diameter	80cm	RC5
Length 151-300x projectile diameter	150cm	RC6
Length 301-600x projectile diameter	300cm	RC7
Length >600x projectile diameter	600cm	RC8

## Secondary characteristics

You now have all the primary characteristics of your weapon, like mass, aiming and damage RC, DV, action and so on. With these, you can figure the secondary characteristics of the weapon.

### Inherent Accuracy

The base IA of a railgun is half its aiming RC, rounding fractions up. RC5-8 weapons only get IA's of 3 or more if mounted or solidly braced.

### Cost

The base cost for a railgun is based on its DV. The price is in credits (Cr), where a credit is a generic unit of currency roughly equal to a modern US dollar in purchasing power.

$$\text{Cost} = (\text{DV of projectile fired from weapon})^2/4 + 300\text{Cr}$$

**Example** - A railgun with a DV of 20 would have a base cost of 400Cr. A cannon with a DV of 1000 would have a base cost of 250,300Cr.

Cost is a TL-independent item. The Cr is supposed to apply to whatever standard of living applies in the game where this weapon is used. If average income or standard of living is lower, then prices will be correspondingly lower, but will still represent about the same amount of work by a person trying to save up for it. The amount of 100Cr represents the same fraction of an average person's income at TL9 as it does at TL13, or any other TL with money or exchange.

The base cost of a weapon is modified by the design and firing characteristics of the weapon.

Action	Cost	Weapon		Cost	
SS	x.5, +.8 per extra barrel*	Pistol		x2.0	
B	x.7	Longarm		x1.0	
RV	x.5	Vehicle mount		x1.0	
SA	x1.0				
AT & SA	x1.3	Mass	Cost	Base IA	Cost
AT only	x1.0	x2.0	x.25	-100%	x.25
AB	x1.5	x1.5	x.50	-50%	x.50
Adjust. pow.	x1.1	x1.0	x1.0	+0%	x1.0
		x.75	x2.0	+50%	x2.0
		x.50	x4.0	+100%	x4.0

Extra clip      shots<sup>-5</sup> x weapon cost/100

\* the +.8 applies to *each* extra barrel on *any* multi-barrel weapon

These multiply together, rather than adding, so a pistol (x2.0) revolver (x.50) has the same cost multiple as a semi-automatic (x1.0) longarm (x1.0). Weapons with detachable magazines are assumed to come with *one*. Extra clips (C) cost as shown. This cost is halved for external magazines (E), and multiplied by 10 for revolver "clips" (extra cylinders). Clip-fed weapons may have several clip sizes, but each alternate size is usually larger than the one the weapon is equipped with.

### Mass modifiers

Each x2.0 multiple on cost will reduce the mass of a weapon by 25% (with maximum reduction of 50%). Each x.50 multiple on cost will increase the mass by 50% (with maximum increase of 100%). This mass modifier applies to the unloaded weapon mass, and does not apply to ammunition, although it will apply to the empty mass of any magazines (like empty clips). This modification to mass has no effect on the IA of the weapon.

### IA modifiers

The IA of the weapon may be increased by increasing the cost of the weapon. Each x2.0 multiple on cost will increase the base IA of the weapon by 50% (round nearest). Each x.50 multiple on cost will decrease the base IA of the weapon by 50% (round down). The IA of a weapon may never go below -1. Each point that IA is decreased due to cheapness is a +1 row modifier for determining malfunctions.

The IA may also be increased by increasing the mass of the weapon, *if the weapon mass was not already increased to reduce weapon cost*. Each 50% increase in mass *and* cost will increase the IA by 50% (round nearest), with a maximum increase of 200% (total of 3x mass and cost). So, if a pistol with an IA of 1 was increased in mass and cost by 50%, its IA would go to 1.5, which rounds to 2. The maximum IA of any weapon may never exceed 3 times the base IA for that weapon.

**Example** - A semi-auto pistol with a DV of 20 has a base cost of 800Cr. For an increase in cost of 100% (+800Cr), the IA goes to 1.5. For another increase in cost and mass of 100% (+800Cr), the IA goes to 2.5, which rounds to 3. So, for a cost of 2,400Cr, you can have this pistol in a heavy target version, with an IA of 3 instead of 1.

### Rate of fire

The maximum ROF of a railgun weapon is based solely on projectile mass. Limits on ROF from action type are as for conventional weapons, and maximum possible ROF is:

$$\text{Max. ROF} = 10 / (\text{mass of a complete round in grams} / 1000)^2 (n)$$

**Example** - A round massing 10g will have a maximum ROF per second of 10, divided by (.01)<sup>2</sup>, or 25 rounds per second.

The table on page 19 has some masses precalculated for your convenience.

### Malfunction chance

Railguns will have a chance of malfunction on a to hit roll of 20. A second d20 is rolled. If the result is 19, the weapon fires at half DV. If a 20 is rolled, the weapon does not fire due to electrical problems. It may be fired normally on the next action.

Railguns have a base reliability of category II. Any critical failure result on a railgun will irreparably damage part of the accelerator.

**Technicalities** - If a weapon has multiple barrels and a common receiver, a dud will only affect one of the barrels, but a critical will affect the machinery common to both. A jam will only be noticed when an attempt is made to reload, and only applies vs. one barrel. On a gatling gun type of weapon, a dud will have no effect except for that shot, and the weapon will continue to function. A jam will stop the whole weapon, as will a critical. Revolvers may have duds, but this does not affect subsequent fire. Jams will only be noticed when an attempt is made to reload.

Railguns are assumed to have a base malfunction chance as per the 20-39% propellant row of the malfunction table.

Automatic or auto-burst weapons designed with semi-automatic receivers will get a +1 row modifier, like conventional weapons. This type of design will apply to most light duty auto weapons, like submachine guns or assault rifles. Each level of reduced cost in a weapon is a +1 row shift, as well. Increased cost will have no effect. Optionally, increased weapon cost could be a -1 row shift, *if an equal cost multiple is also applied to the ammunition cost*, i.e. a finicky weapon needs custom (expensive) ammunition to work reliably.

### Weapon length

In general, the length of a railgun is equal to the accelerator length, plus receiver length, plus stock length (if a non-bullpup longarm). The receiver length of a railgun will generally be twice the projectile length. Most stocks will be 30cm long, and add 2 locations to the length of the weapon (which *does* apply for Initiative, AV and BP purposes). "Stockless" or "bullpup" designs started appearing at TL11.

**Example** - A 3mm 10:1 l/w projectile would be 30mm long, so the receiver of the weapon would be 30mm x 2.0 = 60mm long.



# Railguns

## Past the limits

The ultimate test of a system like **3G<sup>3</sup>** is to design the most unreasonable weapon you can. In this case, we'll look at a TL12 railgun capable of lobbing 1 meter spheres into orbit as a cheap means of launching small satellites or resupplying space stations.

A 1m (100cm) sphere with an sg of 3 has a mass of 1,570kg. To get to and stay in orbit requires a launch velocity of about 8,000m/sec. Now that we have our basic parameters we can figure that this requires a projectile energy of a mere 50 billion Joules (50,000,000,000J), which should you have the misfortune to be in the way, would have a penetration DV of 60,600.

The mass of the accelerator is  $(50,000,000,000J)^{.5} \times 300 / (TL12-7) = 13,420kg$ . Its length is therefore  $(13,420kg/6)^{.8} / ((100cm \times 2)^{.5} \times 3.1416) = 2703cm$ , or 27.0 meters.

If you are at all familiar with research into this sort of thing, you'll see that these figures are *way* off the projections (by a few orders of magnitude). One reason is the need for the projectile to survive the trip into orbit. Considering that most payloads wouldn't survive the 200g acceleration that a 16 *kilometer* acclerator would need to get a payload to orbital velocity, the *119,000g's* that a 27 meter accelerator would generate are out of the question. In addition, there is the question of 200,000,000,000J of waste heat to deal with. Divided evenly over the structure of our 13 ton accelerator, this is enough to instantaneously bring 500 tons of ice water to about a boil.

What to do? The problem lies in the accelerator mass, which in turn relies on the exponent in the mass equation, since **3G<sup>3</sup>** was never meant to operate on this scale. If we assume that accelerator mass has to increase non-linearly with increasing bore size (to handle the stresses), and make the equation:

$$\text{Mass} = (\text{Energy in J})^{(\text{bore in cm}^{1/2})} \times 300 / (TL-7)$$

with a minimum exponent of .5, then you end up with better numbers, like a mass of 18,000 *tons* and a length of 8.6 *kilometers*. Of course, there is still the issue of 100,000 tons of capacitors and the electric bill to deal with...

## Weapon bulk

The bulk of a weapon is found by dividing its length in cm by 15, rounding fractions up. This is the number of **TimeLords** hit locations the weapon would cover if carried close to the body.

**Example** - If the previous weapon had an accelerator 50cm long, the weapon length would be 4 locations long.

The size of each location depends on the weapon mass, as per the table below.

Mass per location	Bulk per location	BP per location
<.50kg	Very Small (VS)	(20-TL)/6
.51-4.0kg	Small (S)	(20-TL)/5
4.01-32.0kg	Medium (M)	(20-TL)/4
>32.0kg	Large (L)	(20-TL)/3

**Example** - A 6kg weapon that covered 4 locations would have a mass of 1.5kg per location, for a total bulk of four Small (S/4).

## Armor Value

The Armor Value of the weapon is a measure of how much physical abuse the weapon can withstand, and is based on the same scale as the DV. That is, 1 point of damage is stopped by 1 point of armor. Anything that gets through AV does actual damage to the weapon. The AV is a general number, and reflects the average of the entire weapon, rather than the specific damage resistance of the accelerator apparatus, etc. Individual components may vary by a great deal, and you may determine that a particular lasing technology is more or less durable than others. Particle beams generally have a lower AV, because electronics is not as durable as steel, regardless of what the electronics are housed in. The AV is based on the TL and energy of the weapon, and is based on the projectile energy, with a minimum AV of 3.

$$\text{Energy of projectile}^{.15} \times ((20-TL)/3)(n)$$

**Example** - If a TL13 weapon had a beam energy of 50,000J, its AV would be  $(50,000J)^{.15} \times (20-13)/3 = 12$ .

## Body Points

The Body Points of the weapon are figured from the previous table as well. Fractions are kept, and the total BP from all locations is added together, and rounded nearest.

**Example** - If the previous S/4 weapon were TL13, it would have 1.4BP per location, for a total of 5.6BP, rounding to 6BP.

Each level of increased mass or cost for any reason (except reduced mass) will decrease the effective TL by 1 for AV and BP purposes (heavier or more expensive weapons have more), and each level of decreased mass or cost will increase effective TL by 1.

### Initiative

The Initiative of the weapon is how easy it is to swing into position, and move about in close quarters. For instance, you can swing a light pistol to a certain arc faster than a heavy rifle. Initiative is function of weapon length and loaded mass in kilograms, but only for the energy sources carried on or in the weapon. External energy supplies may penalize a character because of encumbrance, but do not directly affect weapon Initiative.

**Initiative** for railguns is exactly the same as for conventional weapons (p.21).

### Recoil

In **3G<sup>3</sup>**, recoil modifiers are based on the DV of the weapon (if it has recoil). In some cases, this is inaccurate, like for low-powered or very heavy weapons with small projectiles. Railguns will fall into this category much more often than conventional weapons.

Instead of using the DV/Strength calculation for the base recoil penalty, use  $(\text{Projectile energy} \times .735)^5 / \text{Strength}$ . This calculation may also be used for conventional weapons that fire very small projectiles.

The base penalty for recoil is -5%, times the result of the recoil calculation used, rounding nearest. If both hands are used on the weapon, you usually multiply Strength by x1.5. Each level of increased mass (except from cheapness) should increase the Strength multiple by an additional x.5.

*As an option*, since railguns often have high DV's and small projectiles, increase the effective Strength of the user by x1.5 for one-handed use, and by x2.0 for two-handed use. Do this only if you wish to uniformly use DV/Strength as the base recoil penalty for all weapon types.

**Example** - Using the optional rules, a DV25 railgun fired by a Strength 10 individual will take a -5% recoil penalty per shot  $(\text{DV}25 / (\text{Strength } 10 \times 1.5))$ . If both hands are used, effective Strength goes to 20, and the recoil penalty goes to zero.

### Ammunition cost

Projectiles will cost a number of Cr based on their mass and complexity, since the basic projectile is little more than a streamlined nail. The base cost is:

$$(\text{Mass in grams}^{-5} / 20) + .1 \text{ in Cr}$$

**Example** - A 4mm iron 10:1 projectile has a mass of 3.40g, so it costs .19Cr. A similar 5mm projectile would have a cost of .23Cr.

The type of round will affect the cost as well. These multipliers are cumulative. See below. Guided rounds have a minimum base of 2Cr, and fragmentation rounds have a minimum base of 1Cr.

Round is:	Cost multiple
Rocket assisted	x3.0
Inert armor-piercing (or defeats armor at lower TL)	x2.0
Tungsten armor-piercing (or defeats armor at same TL)	x3.0
Depleted uranium armor-piercing (or defeats armor at +1 TL)	x4.0
Exploding (can be HEAT, but not AP)	x3.0
HEAT (must be exploding as well)	x2.0
Fragmentation (can't be hollow-point)	x3.0
Multiple projectile	x2.0
Discarding sabot	x3.0

**Example** - A 10g projectile will cost .26Cr according to the above formula. A 50 gram, +2 guided projectile would have a base cost of 2Cr, multiplied by 3 for the +2 guidance, for a cost of 8Cr per round. Of course, this does not take any quantity discounts into account.

**Optional** - To reflect the added complexity of coilgun projectiles, if your magnetic weapon technology is determined to be coilguns rather than railguns, all ammunition gets an additional x4.0 cost multiple.

### Cooling issues

Just how badly do energy weapons need cooling systems in **3G<sup>3</sup>** anyway? Substances have a property known as *specific heat*, or the amount of energy needed to raise the temperature of 1 gram of the substance by 1°C. For water, that amount of energy is about 4.2J.

For weapons in fixed emplacements, cooling is not a severe problem. New cooling water can be pumped through the weapon continuously, and the heated waste water dumped down the drain. Or, a more efficient cooling fluid could be pumped through heat exchangers where the waste heat is transferred to water, which is then dumped. Portable weapons do not have this luxury.

If you make the *general* assumption that 20% of a weapon's lasing apparatus, accelerator, etc. is devoted to cooling, you can use specific heat numbers to get a rough idea of how quickly the weapon heats up.

**Example** - A TL14 railgun with an energy of 4000J has an accelerator mass of 2710g, of which 542g is coolant or heat dissipators. Since each 100J of beam requires 290J of input at this TL, 190J is lost as heat, for a total surplus energy of 7600J per shot. If we just use the specific heat of 542g of water, it means the temperature of the weapon's heat sinks rises by 3.3°C *per shot*. If this was an autofire weapon with an ROF of 10 shots per second, you can see that it would get *real* hot, *real* quick (boiling water after 3 seconds). Now, some of this will radiate to the surrounding air, but like conventional weapons, parts can develop *very* high temperatures.

Fortunately, it takes a *lot* more energy to vaporize (boil) water than to just heat it up to the boiling point. To vaporize 1 gram of water that is at 100°C takes 2250J. So, in our previous example, once the coolant reached 100°C, it could start to boil off water at the rate of 7600J per second over 2250J per gram = 3.4g per shot.

These numbers are meant as a side note so you can add atmosphere and detail to your weapon designs. How much of it you choose to implement in actual game rules is up to you.

# Railguns

## Battering

Since the last printing of **3G<sup>3</sup>** there have been a few changes in the world of weapons, some of which I have tried to reflect in this printing. I've also had a chance to collect more data and work on topics I haven't been entirely satisfied with, one of which is the ability of very large projectiles to penetrate through sheer momentum rather than just energy over area.

In the **Rheinmetall Handbook on Weaponry** there is a formula credited to a French naval engineer named LeMarre, which gives the penetration of hard steel by a projectile, based on its mass, diameter and velocity and type. Though different from the **3G<sup>3</sup>** formula for damage, the resulting penetration curves are remarkably similar for both normal and armor-piercing ammunition. You don't see any significant deviation until you get up to projectiles in the 90mm range, which is not a problem for most **3G<sup>3</sup>** users.

However, for those who *are* designing large weapons, I recommend that the maximum division in the **3G<sup>3</sup>** damage formula be set at 10. That is, projectiles of larger than 100mm count as 100mm, as long as they are sg2 or more. This will allow very large projectiles such as tank or naval cannon to get a higher kinetic energy DV than was possible in previous printings of **3G<sup>3</sup>**, which seems appropriate given new data. I don't know if this change is appropriate yet for energy weapons, but my gut feeling is that since it reflects momentum, and energy weapons have negligible amounts, use it only for projectiles.

For supplements like **More Guns!** using the older formula, you can adjust kinetic energy damage by multiplying the old DV by the following amounts:

Projectile	Multiplier
100mm	x1.00
105mm	x1.02
110mm	x1.05
120mm	x1.10
130mm	x1.14
140mm	x1.18
150mm	x1.22
180mm	x1.34
200mm	x1.41
250mm	x1.58
300mm	x1.73
350mm	x1.87
400mm	x2.00

## Sample weapon design

As a quick example of the basic design rules, a simple design is below. See the various rule sections if there is *any* part you don't understand. Most of the numbers will be taken directly from tables.

### Project - 3mm Gauss Machine Pistol, TL14

#### Specs

The final product is a 400J full-auto pistol with a 50 round detachable clip and a bore of 3mm. This is about the energy of a TL11 9mm pistol, but with a much smaller projectile.

#### Damage Value

The DV of a 3mm, 400J projectile is 31, which is respectable for a pistol, but light at TL14.

$$((400J \times .735)/.3)^5 = DV31$$

#### Projectile

The pistol uses a 10:1 iron (sg7) slug, with a mass of 1.44g. An energy of 400J would give it a velocity of 747m/sec. For a 10:1 projectile, this is a *maximum* aiming RC of 5, and a 3mm projectile of this type is damage RC4. Total projectile mass (50 shots) is 72g.

#### Energy

A muzzle energy of 400J for a TL14 railgun requires an input energy of  $400 \times 2.9 = 1,160J$  per shot, or  $1,160J/250J$  per gram = 4.64g of superconductor. This gives a total superconductor mass of  $50 \text{ shots} \times 4.64g = 232g$ .

#### Clip

The weapon has a detachable clip holding the storage banks and projectiles, for a mass multiple of x1.2. The loaded clip mass is  $(72g + 232g) \times 1.2 = 365g$ .

#### Accelerator

The accelerator for a 400J weapon at TL14 will mass 860g, and have a length of 22cm. This will give the weapon an aiming RC of 3 (2 if firing with 1 hand), and an IA of 2. An autofire receiver has a mass multiple of x.10, so it masses  $860g \times .10 = 86g$ .

#### Accessories

Accessories will have a mass multiple of x1.2, so the unloaded weapon mass will be  $86g$  (receiver) +  $860g$  (accelerator) +  $278g$  (unloaded clip)  $\times 1.2 = 1,469g$  (1.47kg). With the clip added on, the total loaded weapon mass is:

$$1,469g + 72g \text{ (projectiles)} = 1,541g \text{ (1.54kg)}$$

#### Weapon bulk

Since the weapon is 22cm long, plus a few cm for the receiver, it is two locations long, and has a bulk of S/2.

#### AV and BP

The AV is based on projectile energy and TL, and is 5. The BP are based on its bulk, and it has 1.166 per location, for a total of 2.

$$400J^{15} \times (20-TL14)/3 = AV5$$

#### Initiative

The pistol has a bulk of S/2 and a mass of 1.54kg, so the table on **p.21** shows it is just in range for an Initiative of +1.

#### Rate of fire

Since this is a machine pistol, we say the ROF is 10, low enough to be reliable.

#### Cost

The cost of the weapon is based on the DV, action type and that it is a pistol, and is:

$$(DV31^2/4 + 300) \times 1.3 \text{ (full-auto)} \times 2.0 \text{ (pistol)} = 1,400Cr$$

## Melee weapon design

While not one of the three “G’s” of the system, this edition of **3G<sup>3</sup>** includes rules for designing melee weapons using the same basic stats as ranged weapons. All weapon attributes are on the same scales, and can be converted to other systems using the same guidelines as for ranged weapons.

## Damage Value

The DV of any melee weapon is based on a simple equation:

$$DV = (\text{Mass in kg} \times \text{hit locations})^{.25} \times K, \text{ where } K \text{ is a constant}$$

The DV rounds to the nearest point. A “hit location” is a 15cm increment of weapon length, and may be fractional, but is always at least .5. These 15cm increments are the same as size units for ranged weapons. Note that a weapon will have different DV’s for different attack forms, that is, a sword will probably have a puncturing DV different from its cutting/slashing DV, but both will be based on the same weapon mass and length.

### K equals:

3 - for a lash weapon (i.e. whip, chain)

5 - for an improvised hand weapon (i.e. pool cue, bottle)

7 - for a centered (i.e. thrusting attack)

8 - for a cut/chop attack from a balanced weapon (i.e. sword)

9 - for a cut/chop attack from an unbalanced weapon (i.e. ax)

**Example** - A 2.0kg weapon that is 3 hit locations (45cm) long and designed to do unbalanced chopping damage would have a cut/chop DV of  $(2.0 \times 3)^{.25} \times 9 = 14.09$ , which rounds to 14. If this weapon also had a thrusting tip, its thrusting DV would be  $(2.0 \times 3)^{.25} \times 7 = 10.95$ , which rounds to 11.

## Hands

A weapon may be used in one or two hands, or require both hands, depending on its construction. This scale applies to a *human* range of strength.

An unbalanced weapon *may* be used one-handed if:  $(\text{Mass} \times \text{locations}) < 8$

A balanced weapon *may* be used one-handed if:  $(\text{Mass} \times \text{locations}) < 10$

A thrusting weapon *may* be used one-handed if:  $(\text{Mass} \times \text{locations}) < 12$ .

**Example** - The previous example has  $(\text{mass} \times \text{locations}) < 8$ , so it may be used one-handed.

DV is multiplied by 1.5 if a one-handed weapon is used two-handed, and Initiative gets 1 point better if used in this way.

## Armor Value

The AV of the weapon is based on its mass, length and material, with a minimum AV of 2. The system assumes higher tech weapons are made from stronger materials.

$$\text{Average AV} = (\text{Mass in kg/length in meters}) \times 3 \times \text{TL}^{.5} \text{ (round up)}$$

Unbalanced weapons have 1.5x AV in head, .5x AV in haft. This represents a heavier (probably metal) attacking surface, and a lighter haft. “Tools” have 1.5x AV in head, .25x AV in haft. Unbalanced weapons may have armored or partially armored hafts, while tools do not. Melee weapons usually only take half damage when blocking other weapons, and only take full damage if used inappropriately or deliberate attempts are made to break it. For AV purposes, weapons have a minimum effective length of .3m.

## Body Points

The BP of a weapon are based solely on its mass. Heavier weapons, once you penetrate the AV, are harder to break than lighter ones.

$$BP = (\text{Mass in kg} \times 5)$$

You may trade AV and BP on a 1 for 1 basis to alter these stats, i.e. reduce AV by 1 to get 1 extra BP, and vice versa.

## Melee Weapons 101

Melee weapons basically do one of three types of damage: Cutting, puncturing and blunt, and a single weapon will usually do more than one, like a knife can do cutting *or* puncturing damage. Chopping is counted as cutting, and crushing is counted as blunt. There are distinctions in practice, but that will come later.

Cutting weapons concentrate the force of an attack onto a narrow edge, which is supposed to penetrate armor (or damage flesh). The higher the velocity or momentum of this edge, the higher the damage. The momentum can be increased by making the weapon heavier, or concentrating its mass behind the cutting edge. Velocity and momentum can be increased by making the weapon longer, the velocity of the tip of the weapon increasing with length. At some point, the weapon ceases to rely solely on the sharpness of the edge, and more on the mass placed behind it. This nebulous boundary is the distinction between cutting and chopping weapons. Heavier weapons have the disadvantage that they are slower to act and react to changing situations.

Puncturing weapons rely on the force of the attack, concentrated over a sharp point, which is hopefully of sufficient hardness and force to penetrate armor. The only way to increase this damage is to increase its momentum, usually by making the weapon heavier, and this decreases their speed and reaction ability.

Crushing weapons rely on sheer momentum for their damage, which may or may not be concentrated over a relatively small area. A club relies on sheer momentum, while a hammer concentrates the force over a smaller area. Neither has an edge. Damage for a crushing or bashing weapon is increased the same way as for a cutting weapon, with the same penalties to reaction speed.

**Note** - The calculations for Armor Value have been tweaked since the last printing, and the minimum length for calculating DV and AV are also new.

# Melee Weapons

## Initiative

The Initiative scale is based on the same scale as firearms, and could be used to see who acts first in a situation where a person with a gun and a person with a melee weapon are within melee range.

### I equals:

Mass x locations x 1 for projectile weapons

Mass x locations x 5 for thrown weapons

Mass x locations x 10 for thrusting weapons

Mass x locations x 20 for cut/chop weapons

Compare "I" to the following table to get the Initiative of the weapon. Note that a weapon may have different Initiative for different types of attack.

I result	Initiative	Typical for
I < .50	Base initiative is +4	
I < 1.00	Base initiative is +3	
I < 3.00	Base initiative is +2	Shuriken
I < 10.0	Base initiative is +1	Knife
I < 20.0	Base initiative is +0	Large knife
I < 40.0	Base initiative is -1	
I < 80.0	Base initiative is -2	Sword
I < 160	Base initiative is -3	Mace
I < 320	Base initiative is -4	
I < 640	Base initiative is -5	Greatsword
I < 1250	Base initiative is -6	
I < 2500	Base initiative is -7	
I < 5000	Base initiative is -8	

Base initiative is modified as follows:

Weapon description	Initiative
Most/all of the mass in the handle/grip (brass knuckles)	default
Relatively even mass distribution (sword)	1 point worse
Mass concentrated towards end (battle ax)	2 points worse
Mass very concentrated towards end (sledgehammer)	3 points worse

**Example** - The previously designed cut/thrust weapon was an unbalanced weapon. It had a base cutting "I" of 2.0kg x 3 locations x 20, or 120, which gives it a base Initiative of -3 for cut/chop attacks. This gets an extra -2 because the mass is concentrated towards the end of the weapon, so its cut/chop Initiative is -5. For use as a thrusting weapon, the "I" is 2.0kg x 3 locations x 10, or 60, which gives it a base Initiative of -2, which goes to -4 because of the mass concentration.

## Inherent Accuracy

The IA of a melee weapon is +0 for tools or weapons at less than normal cost, +1 for weapons, and +2 for any weapon with 4x normal cost or more.

## Cost

The cost of a melee weapon is the DV<sup>2</sup>, times any modifier for time spent in construction. Use the highest DV the weapon has for this calculation.

Modifiers	Cost
Positive TL difference	(Levels difference+1) <sup>2</sup>
Negative TL difference	1/(Levels difference+1) <sup>2</sup>

The maximum differential is +3 levels and -2 levels, with the exception that "tools" can be at up to -4 Tech Levels for cost purposes. This represents that with sufficient time and money one can exceed the "Tech Level" of normal materials available, like meteoric iron in a bronze age society, Damascus steel, or katanas for example.

## Lightweight weapons

The ability of a weapon to make a fine cut is independent of TL. Obsidian flakes are sharper than steel, and harder as well. A high-tech weapon may be harder and sharper than a low-tech equivalent, but if it is lighter, it does not have the momentum to penetrate armor. Its ability to make simple cuts in material is probably better, however, which should be taken into account if the weapon is used as a tool.

## Foils

Weapons bought as having *only* a puncturing DV can also do limited cutting attacks by using the point as an "edge". The DV of such an attack is generally around 3 or less, and can only do superficial tissue damage unless directed at vital spots like eyes.

## Energy-enhanced melee weapons

A melee weapon designed to have energy-based effects will need a built-in power source, such as a battery or capacitor bank. For "stun" charges, simply use the energy per charge, and figure the DV as for a 1.0cm beam. This DV will be a separate attack, which may or may not take effect, depending on the special effects of armor, whether the weapon touched flesh, and so on. For vibroblades, the power expenditure must be continuous while the weapon is in use, and the energy required is equal to what would be needed to match the DV of the weapon. When the weapon strikes, the DV is counted as armor-piercing, but damage done to the target is *not* reduced as it might be for armor piercing ammo.

Cost of such a weapon is four times the base amount. Mass is increased by the mass of the power supply, which has a mass multiplier of x1.1. Bulk, initiative, BP, etc. are based on the final mass of the weapon. For oddities like energy swords, they are not practical at **3G<sup>3</sup>** Tech Levels, but would be designed as continuous beam lasers, set with variable optics to allow focusing to a point, about where the tip of the blade would be. Ionization of the air would prevent the beam from going further. The beam cannot block or parry, and automatically does its damage to anything the "blade" intersects. All physical stats would be as for a laser weapon, but melee Initiative would be based on a 1-2 location *melee* weapon with the mass in the handle.

## Combination weapons

If a melee weapon and some other weapon are combined, the masses are simply added together, and bulk, initiative, BP, etc. are based on the total mass, rather than the component parts.

## Strength modifiers

The DV of a weapon is based on it being wielded by an average human male. Higher or lower strengths will alter the DV when wielded by these individuals. DV changes are based on the square root of strength ability, so a person who can lift twice as much as an average person will do  $2^{.5} = x1.4$  damage, and a person who can lift half as much as an average person will do  $.5^{.5} = x.7$  damage. In **TimeLords**, this would correspond to Strengths of 14 and 7, respectively.



## General Game Conversions

**3G<sup>3</sup>** uses a slightly modified version of the **TimeLords** rules as the reference frame for all designs. This is mainly because **TimeLords** has more stats for weapons than most other games, which gives you more to work with when trying to cram it into your favorite game.

From this point, you need to find out exactly how to convert these stats into the appropriate ones for the system *you* will be using them in. Maintaining the **3G<sup>3</sup>** stats in a separate file lets you keep the information needed to convert weapons to any system, so weapons can be moved from game to game.

Going through **3G<sup>3</sup>** and your own system will also tend to give you a much better understanding of the principles that underlie your system, which will aid you both as a GM or player.

## Basics

The **TimeLords** system is a d20 system, i.e. most modifiers are in 5% increments. Any modifier on a weapon's chance to hit is multiplied by 5 to get a percentage equivalent, so a +2 modifier would be a 10% change in chance to hit. Numbers that modify chance to hit listed in **3G<sup>3</sup>** are range and bonuses for guided projectiles. Inherent Accuracy also modifies chance to hit, but each point of IA is a 10% modifier in systems where skill modifiers are a multiple of skill, and a 5% modifier in systems which directly add and subtract from skill.

Other numbers to be converted are usually in the form of an addition or subtraction, like a +1 to DV means add one to the base DV of the round fired.

In percentile systems, these +1 or -1 changes can convert directly to 5% increments. In many other systems, a "bell-curve" system is used, where the percentage difference between rolls varies, and the chances of certain numbers coming up are markedly different.

**Example** - The difference between a 2d6 roll of 2 and 3 is 5.55%, while between a 7 and 8 is 13.89%. In a 1d6 system, there is only one way to get a particular die result, while in a 2d6 system, you can get a "2" only one way, but a "7" six different ways. So, a 2d6 system would be a "bell curve" system.

Bell curves *can* simulate real-life probabilities such as chance to hit at a given range, but unfortunately, most systems implement them incorrectly.

The best way to convert the modifiers is to use the percent range around the average for that die roll, generally rounding down.

Dice type	Average roll	Percent	Bell curve?
1d6	3.5	16.67%	no
2d6	7.0	13.89%	yes
3d6	10.5	12.50%	yes
4d6	14.0	12.35%	yes
1d10	5.5	10.00%	no
2d10	11.0	10.00%	yes
1d20	10.5	5.00%	no
1d30	15.5	3.33%	no
1d50	25.5	2.00%	no
1d%	50.5	1.00%	no

**Example** - The difference between a "7" and an "8" (13.89%) is the "average" for a 2d6 roll. A +2 modifier to hit in **3G<sup>3</sup>** would be a +10% modifier, which rounds to +0 in the 2d6 system. A +3 modifier would be +15%, which would be a +1 in a 2d6 system. So, a weapon with an Inherent Accuracy of 3 would probably get a +1 bonus to hit in a 2d6 system. Also, since energy weapons have the optional rule of a +4 modifier to hit (20%), if the GM allowed it, energy weapons using this rule would have a +1 to hit in a 2d6 system.

## Data points

To convert a weapon, you need to figure out the reasoning behind the scenes in the system you will be converting to. One good starting point is to figure out how much damage the average person can take, as a scale for measuring damage. **TimeLords** and **3G<sup>3</sup>** are based on the average person (about 83kg or 183lb) having about 30 Body Points. The average damage of a **3G<sup>3</sup>** weapon will be multiplied by the ratio of difference.

**Example** - In a system where the average person has 10 hit points, a weapon will do 1/3 the average damage of a **3G<sup>3</sup>** weapon. A weapon with a **3G<sup>3</sup>** DV of 20 does an average of 11 points, since each 10 points of damage represents a d10, and the average for 2d10 is 11. Converted to this system, the weapon would do an average damage of  $11/3=3.66$  points.

You then convert this damage to whatever dice type your system uses.

**Example** - If this system used d6 for damage, a damage of 3.66 points is about average for 1d6, so this weapon would do 1d6 of damage.

Die type	Average roll	Damage range
1d3	2.0	1-3
1d4	2.5	1-4
1d3+1	3.0	2-4
1d6	3.5	1-6
1d4+1	3.5	2-5
1d8	4.5	1-8
1d6+1	4.5	2-7
1d10	5.5	1-10
1d12	6.5	1-12
1d20	10.5	1-20
1d%/1d100	55.0	1-100

If you can find three or more weapons of widely different damages that can be compared to **3G<sup>3</sup>** weapons, you can usually find an equation to convert any **3G<sup>3</sup>** damage to your system. Most computers and some calculators will have some curve fitting programs, and you can graph out what your curve looks like. The more points on your curve, the better. If you can only find information for hand-held weapons, then your curve might be accurate for them, but be grossly off for larger weapons, like cannon. For most uses, you can get a reasonably good conversion if you have the data points for a pistol, rifle, heavy machine-gun and light cannon (20-30mm).

# General Conversions

**Example** - A 9mm or .45 caliber pistol round has a DV of around 20. A heavy rifle has a DV of around 60, and a light cannon around 180. So, if pistols in your system do 1d6, and rifles do 2d6, then there are two options for conversion. Either each tripling of damage past 20 adds 1d6, or doubles the damage.

## Case 1

If the cannon does 3d6 in that system, then you would say each tripling *adds* 1d6 in that system. So, a weapon with a DV of triple the cannon (DV540) would do 4d6 damage.

## Case 2

If the cannon does 4d6 in that system, then you would say that each tripling of DV past 20 *doubles* the damage. So, a weapon with triple the DV of the cannon (DV540) would do 8d6 damage.

Once you have a general rule, compare it to a few more weapons to make sure it works. Many systems design weapons on an "it looks good" basis, and lack some internal consistency. You may need to plug loopholes, or rechoose your data point weapons because your original choices had unrealistically high or low damage to begin with (for instance, many systems give magnum pistols unrealistically high damage).

In general, the following **3G<sup>3</sup>** DV's apply to current (TL11-12) weapons, and make good comparison points.

DV	Equivalent
15	Light pistol (.22 rimfire, .25ACP, .32ACP)
20	Medium pistol (9mm Parabellum, .45ACP)
30	Heavy pistol (.44 Magnum, .41 Magnum)
40	Light rifle/Ex. heavy pistol (.221 Fireball, .454 Casull)
50	Medium rifle (5.56mm, 4.9mm caseless)
60	Heavy rifle (7.62mm, 6mm, .338 Magnum)
80	Elephant rifle (.460 Magnum)
100	Heavy machine gun (12.7mm)
130	Ex. heavy machine gun (14.5mm, 15mm)
180	Light cannon (20mm, 23mm, 25mm)

## Pains in the neck

Below are some general headaches that may occur in attempting a conversion.

### Increasing Hit Points

Some game systems have experience levels that grant extra hit points or ability to take damage. This means that a weapon that could kill a low-level character might only annoy a high-level character. If your system gives extra hit points as a result of experience, use 1/3 the maximum level an *average* character can reach as the base number of hit points. If different types of characters get different amounts, use a character type midway between the minimum and the maximum.

**Example** - If a highest level character you expect to see in a game has 12 experience levels or break points where they would get extra hit points, design weapons as though the average number of hit points was the amount for a character after reaching the 4th of these levels past the start.

For instance, if characters started with 1d10 hit points, and got 1d10 more per break point, they would have about 22 hit points upon reaching the 4th "level". This is slightly more than 2/3 the 30BP a **TimeLords** character has, so damage would be slightly more than 2/3 the **3G<sup>3</sup>** average. A 9mm or .45 does an average damage of about 11, so in this system, such a weapon would do an average of about 8. The easiest way to get this result would be to say that the weapon does 2d6+1, which gives an average of 8, and a spread of 3-13 points of damage.

This makes **3G<sup>3</sup>** weapons suitably punishing to characters at the low end of the scale, but still dangerous enough to be intimidating at the high end.

### Wide Damage Spread

Some systems assign different damage types for different projectiles from the same weapon, like increments of 1d6 for regular bullets, but 1d8+1 for hollow point rounds. There are two possibilities here. Your system may have a table of different damages for the ammunition types. A normal **3G<sup>3</sup>** weapon uses a base ammunition type, with no special effect. Convert the DV to another DV for that ammunition type, like extra tissue damage for hollow-point rounds, and then convert this DV into the other system for the special ammo type. Or, just use the same number of dice as the regular round, but use the other dice type.

**Example** - A DV20 projectile does 9 points of damage in your system. In your system, normal bullets all do multiples of 1d6+1, so this bullet would do 2x base damage (2 x (average of 1d6+1)). If hollow-point rounds did damage in 1d8+1 increments, this bullet would do 2x the base damage, since that was the multiple for normal rounds, but in this case it would be 2 x (1d8+1).

### Penetration vs. damage

Another problem is that some systems assign different numbers for armor penetrating ability and tissue damage ability. A 9mm bullet penetrates armor better than a .45, so it has a higher DV, although some feel the .45 has more "stopping power". **3G<sup>3</sup>** damages represent force over area, and are *strictly* an armor penetration ability. They just happen to work fairly well at tissue damage as well. Assume that the energy deliverable to a target is on the same scale as DV, and is (projectile or beam energy x .735)<sup>5</sup>. This way you can generate both a "penetration" value and a "damage" value that are consistent with your game.

### Cumulative damage

Some weapons assign very high damages based on cumulative effect of a number of small attacks. In this case, straight conversions will not work. You must either adjust your system to allow for a number of small attacks, or find a way to convert cumulative damage. A rough suggestion would be to double the DV for every four attacks that hit. So, if shotguns had a very high damage in your system, you could figure out the DV of each pellet, and base the damage conversion on the number that would actually hit at a given range.

### No comparable damages

It may be the case that the **3G<sup>3</sup>** weapon type you are using does not give damages consistent with weapons of the same type in your game system. For instance, particle beams may be ravaging death beams the size of pistols. In this case, you simply need to multiply or divide the designed **3G<sup>3</sup>** damage to get a figure to apply to all weapons of that type.

### Special ammo

If your system does not take special ammunition types into account, and you want to include them, you'll have to work from the DV to get penetrations for these rounds, and also a lower or higher damage for what penetrates armor (if any).

### Thresholding

Some games apply damage as a target number that has to be resisted. That is, the weapon has a fixed damage, and the target must apply some game stat to see how badly they are affected by this fixed damage.

A conversion to this type of system requires subjective evaluation. Figure out what level of damage a weapon *should* do if fired by an average person at an average target at a range where there are no bonuses or penalties to hit. Then figure out what damage actually needs to be done before it is resisted.

**Example** - If you think a pistol should do a "medium" wound to a person, and the average person can resist a "serious" wound down to a "medium" one, then the pistol should start off doing "serious" damage.

Once you have a handful of data points, you can compare these to the 3G<sup>3</sup> Damage Values for similar weapons (pistols, rifles, etc.) and make up a conversion table appropriate to this system. One potential problem is that if characters are far above "normal", then they might not be affected as much as they should. As a guideline, no unarmored person should be able to shrug off even a small caliber pistol hit without *some* game effect.

### No dice

If a system does not use dice for damage, then you need to assign a number rather than a dice type to each weapon, like 1 for pistols, 2 for heavy pistols, etc., rounding fractions nearest. How well this works depends on how coarse or fine-grained the system is. At the low end, there may be judgement calls as to which way a given value should round, and these can either be done strictly by the book, or based on game-specific ideas of a weapon's potential.

### No hit points

If your system has no hit points, bypass that method of converting damage, and just go to the weapons list. Find the closest matches to known 3G<sup>3</sup> weapons, and go from there. If your system assigns an accurate amount of damage for the weapons, then your conversion will assign an accurate amount for your own designs, and the results will be consistent with what you expect from that system.

### Non-metric

If your system still uses the archaic and confusing inches, pounds, ounces, etc., figure out the conversion from the list of terms at the start of the rules.

### Inconsistent system

Some systems seem to have no framework for weapon damages, or none that you can find. This requires some serious rethinking, as 3G<sup>3</sup> is a consistent system, and you are trying to fit the results into an inconsistent system. Why bother? Your only option is to completely throw out all the damages in that system, and start your own system from scratch, but if you do that, you might as well switch to another game system entirely!

## Other weapon characteristics

Once you figure out the damage, you need to figure out the other important characteristics of the weapons.

### Range Class

The aiming RC in 3G<sup>3</sup> represents the accurate firing range of the weapon. Although a weapon may be quite lethal well beyond this range, you can't *deliberately* hit someone that far away. In most cases, Range Class can be converted by comparing the maximum range for a given RC to the ranges in your system. The sample column is representative of the *maximum* potential of current or historical weapons.

RC	Weapon type	Example	Max. aimed range
1	Snub-nosed pistols	Derringer	30m
2	Regular pistols	Glock 19	100m
3	Carbines	Uzi	300m
4	Rifles	M-16	1,000m
5	HMG's, light cannon	30mm GAU-8	3,000m
6	Medium cannon	105mm cannon	10,000m
7	Heavy cannon	155mm artillery	30,000m
8	Siege cannon	Paris gun	100,000m

**Example** - In your system, weapons classed as pistols always fire on a given table. So, any RC2 weapon would use that table in your game.

Don't be daunted by the range tables on the Aid Sheet in the back of the rules. This provides more target information than you are ever likely to need, so your personal conversions can be as accurate as possible. Besides, most weapons will fall into limited brackets on that table. For instance, while the aiming and damage RC table goes from a range of 0 *meters* to 100 *kilometers*, you don't need any range step larger than 50m for derringers (RC1), and you are unlikely to need any range step smaller than 1km for a siege cannon (RC8).

If your system does not have range tables, but a minus to hit for a specific range increment, you first have to figure out the skill level in your system for a "professional" shooter. This would be someone who could make a living off his or her skill with the weapon, in the form of competitions or other competitive events. This person should be able to just barely *not hit* a stationary man-sized target with a weapon of a given RC, when the weapon is braced on a solid rest. Divide this range by the number of minuses needed to make this possible to get the minus per unit of distance.

**Example** - A person in a 3d6 skill system is determined to need a 15 or less roll to be a "professional". If bracing on a solid rest is a +2 in that system, this professional would have a roll of 17 or less to hit. So, if an RC2 pistol has a maximum aimed range of 100m, this person firing an RC2 weapon would need to take a -1 per 7 meters of distance (6.66m, round nearest) to have no chance of hitting a stationary target dummy at just past maximum range (Skill of 17 with -15 from range steps, because you can't roll less than a 3 on 3d6). So, in this system, RC2 weapons take a -1 to hit per 7 meters of range. If minuses due to range were halved for braced weapons, you would in actuality take a -1 per 3.5m instead.

# General Conversions

## Inherent Accuracy

In **3G<sup>3</sup>**, this is how “user friendly” a weapon is. When a person holds it, how easy are the sights to use, how naturally does it point, and so on. Since skills and range modifiers in **3G<sup>3</sup>** are based on d20 rolls, assume that each point of IA is about a 5% increase in chance to hit.

**Example** - In a percentile dice (d%) system, a weapon with an IA of 1 would give a person with a skill of 30% a base chance of 35% or less to hit.

If your system does not have an equivalent stat, you can assume that all weapons with average IA for their Range Class already have this taken into account. Only apply percentages that are greater than the average for the RC when figuring any potential bonus. For instance, an RC2 weapon with an IA of 2 would be counted as having only a 5% bonus, since an IA of 1 would have no extra effect.

If weapon have fixed range bands and no stat equivalent to IA, they might have increased range bands if they have a higher than normal IA. A 20% increase per point of IA above the base is a good guide.

**Example** - If an average pistol had a “medium” range of 20m, then a pistol with a point of increased IA would have a “medium” range of 24m.

## Guided weapons

Each +1 for a guided or targeted round or weapon is a 5% increase in chance to hit. This can be converted to your system using the previous guidelines and dice spreads. Weapons that have to make skill rolls on their own are counted as having the minimum skill possible for an average character, and any guidance bonus will apply to that skill.

**Example** - If the minimum skill an average character can buy in a 3d6 system is an 8 or less roll, then a self-guided missile will be counted as having a base skill of 8 or less. If the missile had a +5 guidance system in **3G<sup>3</sup>**, this would be a +2 in the 3d6 system, since +5 is +25%, and the average dice spread for 3d6 is 12.5%. So, this weapon would have a base roll of  $8+2=10$  or less. It is possible for a weapon to be “smarter” than its operator, which can have amusing overtones at TL’s of 13 and up, where the on-board computers may be able to hold conversations with their spare processor power.

## Rate of fire

Usually, this is a simple matter of multiplying the rate of fire per second by the turn scale in your game. If you use 2 second turns, multiply the ROF by 2, and so on. Most single-action revolvers have a maximum ROF of 2 per second, as you have to manually cock the weapon between shots. Double action revolvers have a maximum ROF of 3 shots per second, and semi-automatic firearms have a maximum ROF of 4 shots per second. Note that this means you are pulling the trigger as fast as you can. Carefully aimed shots will be around half this speed. Some games have long enough turn scales that weapon reloading is necessary. Assume that revolvers can be loaded at one shot per second, and weapons which can load ammunition in bulk (clips, etc.) can be reloaded in 3 seconds. So, a automatic weapon which can empty its clip in 2 seconds and be reloaded in 3 more would have a “5 second ROF” equal to its clip capacity.

## AV and BP

These quantities are not used in many games, and become an optional attribute, if you choose to apply them. They rate on the same scale as damage as the weapon. Divide the DV of the weapon by the average amount it converts to. Then divide the AV and BP of the weapon by the same amount (rounding nearest, but usually with a minimum of something more than 0).

**Example** - If a DV20 weapon did an average of 4 points in your system, then DV was divided by 5. So, the AV and BP would also be divided by 5.

Damage of less than or equal the AV is only cosmetic in nature. Anything that gets through is applied to the BP, and when the BP are gone, the weapon is destroyed. Any loss of BP will likely cause a malfunction.

## Malfunctions

Using the malfunction percentages listed earlier, you will need to figure out an appropriate roll for your system. Usually, rolling the maximum possible on your dice combination means a malfunction or chance of malfunction (like 12 on 2d6, or 18 on 3d6). For modern weapons in good condition, a malfunction chance of more than .5% is probably unreasonable. See the table below.

2d6 roll	Percent chance
11+	8.33%
12	2.78%
12, then 10+	.46%

3d6 roll	Percent chance
16+	4.62%
17+	1.85%
18	.46%

4d6 roll	Percent chance
20+	5.40%
21+	2.70%
22+	1.16%
23+	.39%
24	.08%

1d20 roll	Percent chance
20	5.0%
20, then 19+	.50%

2d10 roll	Percent chance
18+	6.0%
19+	3.0%
20	1.0%
20, then 11+	.50%

**Example** - On a 3d6 system, a weapon with a 5% chance of malfunction would do so on a “to hit” roll of 16 or better.

## Reverse engineering

Any real world weapon you have stats for can be converted to **3G<sup>3</sup>** with little difficulty, and then converted to your system. The mass and length of the weapon are direct conversions, although you may have to guess at things like the mass of a loaded clip, for instance. BP and Initiative can be found once you have the weapon bulk, and AV can be found by using the real-world energy of the round, noting that 1.36 Joules=1 foot-pound. Range Class will be based on round type and barrel length, and IA will be average for the RC, unless the weapon is a target weapon, in which case it will probably be 1 or maybe 2 points higher, or a cheap weapon, or one with very poor aiming characteristics, in which case it would be 1 or possibly 2 points less. Cost is a direct conversion. Guidance systems are very difficult to get a direct conversion on.

Remember that when you are designing a weapon from the ground up, you are just getting a good approximation of the real thing. When you reverse engineer a real-world weapon, you keep all the real world stats, and fit appropriate **3G<sup>3</sup>** stats to them. You can find the actual rate of fire, and get the exact DV from the listed muzzle energy and bullet size.

## Genre conversions

Rather than specific games, the next guidelines are "genre limitations". These are limits not of technology, but of certain types of fictional cultures that could apply to game worlds.

### Historical

A game setting where culture and technology are more or less identical to the historical record. All weapon developments will be as per the historical Tech Level guidelines for that weapon section. Take into account that different regions of the globe will be at different TL's for many technological developments.

### Wellsian

A world where eccentric scientists have made advances in one or two fields, or Martians, Venusians or Lunars have "wierd science". The overall TL is TL8, but electronics is at TL9 (vacuum tubes), and power storage is at TL13 (basic superconductors). Conventional weapons are more or less the same as expected at TL8, but odd and reasonably practical energy weapons can be manufactured, even if no one actually understands the science involved. They are heavy, bulky and delicate, but might still have advantages in certain situations.

### Medieval fantasy

A world where magic is more powerful than technology, and individual valor carries a battle, rather than implements of mass destruction. The TL of gunpowder and melee weapons is TL5, and since the physics and chemistry are not highly researched, the only gunpowder weapons allowed are matchlocks and flintlocks firing round projectiles. The only action types allowed are SS/n and RV/n. This form of alchemy may or may not be considered a branch of magic, and the secrets of making weapons and gunpowder may be strictly guarded. Explosive use of gunpowder is known, and crude grenades are possible.

### Post-holocaust

A world where everything went wrong, and civilization has totally collapsed. The TL of pre-collapse weapons will be the maximum attainable, but this level is seldom achieved. The best weapons that can be made are probably 1 or 2 TL's below the best weapons the designer had hands-on access to. Pre-collapse weapons are likely to now be at one or two levels worse in reliability due to age and wear, and as these slowly decay, so will the average TL builders will have to work from. Weapons of the maximum possible TL should be counted as having one level of increased cost per TL above the ambient manufacturing level.

### Alien Invasion

A world where Earth (or somewhere else) has been invaded or is under occupation by unfriendly alien forces. Depending on the hostility and duration of the invasion, the overall manufacturing TL is likely to have gone down. Much of the post-holocaust limitations apply, with the added incentive that being caught with advanced technology is punishable by death. The aliens may let us "get away" with enough technology to hurt ourselves, but not enough to be a threat to them (up to historical TL6-7 guidelines). However, there will be a very small amount of alien tech floating around. Assume that all advanced technology (ours or theirs) is double cost for every TL above the currently available level.

### Near future

Some altered reality set in the not-too-distant future. Technology may or may not have continued to accelerate in certain fields, allowing a world with multiple Tech Levels as far as weapon developments go. Most conventional weapons will be TL12, with the possibility of experimental or prototype weapons in other categories at TL13, improving measurably over the course of a long campaign (exponential technology growth will do that to you). Prices for the "latest" technology will always be steep, but will drop to more reasonable levels by the time the next advance is announced...





Universal conversion chart for 3G<sup>3</sup>

3G <sup>3</sup> DV	CORPS™	GURPS®	Hero System®	Traveller 4®	Cyberpunk 2020®	Traveller NE®	MasterBook™	Battlelords 23c™	Feng Shui™	Heavy Gear™	Fuzion®
49										28	
50		6d6									
51	17				4d6+2				15		
53		6d6+1						2d6+1		29	7d6
54	18		2d6+1				23				
55		6d6+2									
56		7d6-1									
57	19									30	
58		7d6			4d6+3	5					
60	20	7d6+1								31	8d6
62		7d6+2			5d6			2d8			
63	21										
64										32	
65		8d6		5			24				
66	22										
67		8d6+1						3d6-1	16		
69	23									33	9d6
70		9d6-1			5d6+1						
71			2d6+2					2d8+1			
72	24										
73		9d6				6				34	
75	25										
77		9d6+2					25	3d6		35	10d6
78	26										
79					5d6+2						
80		10d6									
81	27									36	
82		10d6+1	3d6-1								
84	28	10d6+2									
85		11d6-1						3d6+1			
87	29	11d6							17		
89		11d6+1			5d6+3	7	26				
90	30										
91		11d6+2								38	
92		12d6-1									
94		12d6	2d6+3	6	6d6			3d8-1			
96	32										
101		13d6								40	11d6
102	34										
104							27	3d8			
106					6d6+1	8					
108	36	14d6	3d6					4d6			
113								3d8+1			
114	38	15d6									
115									18		
120	40				6d6+2						
121		16d6				9	28				
122								3d8+2			
126	42			7						45	
131								5d6-1			
135	45	6d6x3									
136					6d6+3						
139						10	29				
141			3d6+1					5d6			
144	48				7d6						
146								4d8			
150	50								19		
155		7d6x3				11					12d6
157										50	
160							30	5d6+2			
162	54										
163					7d6+1						
166				8							
171	57										
174		6d6x4				12		6d6			



Universal conversion chart for 3G<sup>3</sup>

3G <sup>3</sup> DV	CORPS™	GURPS®	Hero System®	Traveller 4®	Cyberpunk 2020®	Traveller NE®	MasterBook™	Battlelords 23c™	Feng Shui™	Heavy Gear™	Fuzion®
510	170							12d8			
513					10d6		40				
533		6d6x14									
540	180										
543				14							
557			5d6-1								
567							41				
570	190					19					
584									24		15d6
592											
600	200	6d6x16									
611								12d10			
625							42			100	
631				15							
638			4d6+3								
660	220										
661											
667		6d6x18				20					
688							43				
696											
720	240							14d10			
727				16							
732			5d6								
733		6d6x20									
755							44				
765									25		
780	260					21					
785					11d6						
798		6d6x22									
800											
826							45				
830				17							
840	280										
862		6d6x24									
865											
870											
900	300					22				120	16d6
903							46				
926		6d6x26									
945				18				1HP			
960	320										
962			5d6+1								
985							47				
990		6d6x28									
1000											
1002									26		
1020	340					23					
1044											
1053		6d6x30									
1062				19	12d6						
1073							48				
1080	360										
1115		6d6x32									
1122											
1140	380										
1153						24					
1166							49				
1177		6d6x34									
1188				20							
1200	400										
1209											
1239		6d6x36									
1260	420										
1266			5d6+2				50				
1300		6d6x38				25					

---

# TimeLords

---

## Conversions in general

The next forty pages provide relatively detailed conversion guidelines for a dozen separate role-playing systems, chosen mainly because they all have detailed rules regarding the interaction of people and technology. This is, after all, what **3G<sup>3</sup>** is about.

None of these conversions are officially endorsed by the makers of these games, and so are not "official" items that can be foisted or forced upon other players or GM's. They are guidelines that for the most part allow you a consistent way to get from **3G<sup>3</sup>** to some other system, and illustrate a number of conversion strategies which you might employ to get good results from systems that *aren't* mentioned here.

I would like to thank a number of individuals who helped with these conversions in some capacity. Steve Jackson (Steve Jackson Games) for phone assistance with heavy weapon damages in **GURPS**, Frank Chadwick (Game Designers Workshop) for similar assistance for **Twilight 2000**, Marc Miller (Far Future Enterprises) for the chance to get up close and personal with **Traveller 4th edition**, Lester Smith for assistance once I got there, and Sean Malloy (**3G<sup>3</sup>** fanatic) for most of the **Torg** conversion, which provided the basis for the **MasterBook** conversion. Other thanks go to all the **3G<sup>3</sup>** users who wrote and asked for new conversions, thus giving me the incentive to upgrade the rules to include them, and to all the companies mentioned here, most of whom donated copies of their product so that we had a good sampling of weapons to use for the conversion research.

Other conversions are *not* scheduled for publication at this time (send'em to your favorite magazine or put them on the Net), but if you create your own for personal or local use, and send us a copy, we'll keep it on hand, just in case...

## TimeLords™ Adventures into Forever...

### Basics

**TimeLords** is the base system in which **3G<sup>3</sup>** weapons are designed. No real changes are needed from the **3G<sup>3</sup>** stats to use the weapons in **TimeLords**. Users of **CORPS TimeLords** should use the **CORPS** weapon stats. **TimeLords** as a system is being discontinued by BTRC, but the game mechanics and principles will continue to be used in the background of products like **3G<sup>3</sup>**.

### Name

As per the **3G<sup>3</sup>** rules. Many company names will be abbreviated to save space.

### Caliber

For modern weapons, a common caliber name will be used. This may not necessarily be a correct military designation, but is clear enough to distinguish one type from another. Almost all black powder or muzzle loading weapons will have metric designations instead of the inch designations they historically had.

### Range Class

As per the **3G<sup>3</sup>** rules. Pistols with an aiming RC of 3 must be fired with both hands to get this level of accuracy. Otherwise they go to aiming RC2, and their IA goes down by a point as well.

### Damage Value

As per the **3G<sup>3</sup>** rules.

### Inherent Accuracy

As per the **3G<sup>3</sup>** rules.

### Initiative

As per the **3G<sup>3</sup>** rules. Remember that weapons with folding stocks may have different Initiatives depending on how the weapon is used.

### Skill

As per the **TimeLords** rules.

### Nationality

As per the **TimeLords** rules.

### Mass (loaded)

As per the **3G<sup>3</sup>** rules.

### Bulk

As per the **3G<sup>3</sup>** rules. *However, two handed firearms never have a size less than Small for each location.* This does not apply towards figuring the BP of the weapon, however. In a few cases, the Bulk of a weapon does not accurately match its actual size and encumbrance. This can only be measured for real-world weapons, of course.

### Tech Level

As per the **3G<sup>3</sup>** rules.

### Cost

As per the **3G<sup>3</sup>** rules.

---



**Clip**

As per the **3G<sup>3</sup>** rules. Semi-automatic and most other clip-fed weapons may have an additional round in the chamber. The exceptions are weapons with revolver-type clips, or where the ammunition is an integral part of the clip and cannot be removed.

**Action**

As per the **3G<sup>3</sup>** rules.

**ROF**

As per the **3G<sup>3</sup>** rules. Technically, all semi-auto weapons can be fired as fast as you can pull the trigger, but practically, large-bore weapons or those with very long or heavy ammunition cannot do this. The following numbers are used for these **3G<sup>3</sup>** weapons.

Action type	Rate of fire
Semi-auto	4
Semi-auto shotgun, large rifle	2
Single action revolver, pump action	1
Double action revolver	3
Single shot	1/3
Lever action	1/2
Bolt action	1/2
Bolt action, single shot	1/5
Muzzle loading weapon	1*

\*but has long reloading time between shots

**Hands**

As per the **3G<sup>3</sup>** rules.

**Restrictions**

This is a **TimeLords**-dependent item, and is used here just to show if a given weapon is restricted to military use or not.

**Clip mass**

As per the **3G<sup>3</sup>** rules. If a weapon has multiple sources in a clip, like a binary propellant weapon, the mass of each will be listed separately.

**Armor Value**

As per the **3G<sup>3</sup>** rules.

**Body Points**

As per the **3G<sup>3</sup>** rules.

**Reliability**

As per the **3G<sup>3</sup>** rules.

**Shotguns**

For multiple projectile weapons, their number and individual DV's are listed in an "AxB" format, so a shotgun with a DV of "15x13" would be 15 projectiles, each with a DV of 13.

**Guided weapons**

As per the **3G<sup>3</sup>** rules. Weapons with a guidance bonus will apply the bonus to user skill if within 1 seconds' flight time of the weapon.

**Explosions**

As per the **3G<sup>3</sup>** rules. Fragments will be listed as having a DV and a number of fragment hits on a human-sized target at a range of 1m. The number of hits is multiplied by 4 at point blank, and divided by 4 (round nearest) each time you double the range.

Range	Starting fragments							
	125	250	375	500	625	750	875	1000
1m	5	10	15	20	25	30	35	50
2m	1	3	4	5	6	8	9	13
3m	1	1	2	2	3	3	4	6
4m	-	1	1	1	2	2	2	3
5m	-	-	1	1	1	1	1	2
6m	-	-	-	1	1	1	1	1
8m	-	-	-	-	-	-	1	1

**Example** - A fragmentation weapon listed as 14/12 would have DV14 fragments, and on average, 12 would hit at a range of 1m. For ranges where there would be less than 1 hit, you may use a fractional chance to see if a character is struck by one fragment.

**Special ammunition**

As per the **3G<sup>3</sup>** rules.

**Sighting aids**

As per the **3G<sup>3</sup>** rules. A low-power (1-2.5x) telescopic sight will cost 50Cr, a medium power (3-5.5x) will cost 100Cr, and a high-power (6x or more) will cost 200Cr, regardless of TL. Ones rated for the military will cost 2x to reflect ruggedizing and price gouging.

**Indirect fire**

Weapons with indirect fire capability add +1 aiming RC, and may hit targets outside line of sight by using spotters or remote sensing. There is a base -10 modifier for indirect fire, fire is always at a hex-sized target (included in the -10 modifier), and normal miss distances will apply.

**Thrown weapons**

Thrown weapons have a minimum cost of 2Cr, even if they are disposable, like grenades. Weapons that are passive (like mines) are counted as thrown weapons for cost purposes (treat as ammunition only).

**Melee weapons**

As per the **3G<sup>3</sup>** rules.

**Melee TL**

Melee weapon is TL5, or actual date of introduction, whichever is higher. Tools are generally 1-2 levels below this. The TL listed on the weapon is the TL a weapon of that type became historically available, or is likely to have been made. Modern melee weapons can have much higher AV's, but usually this involves lighter, high-tech materials which tend to reduce the DV and BP of the weapon. Very seldom will a "standard" melee weapon have a manufacturing TL of more than 7 (the market is no longer there for the manufacture, thus driving up the cost).

**Improvised weapons**

Bought at 1 or 2 TL's below normal, usually with quarter AV since many are all "haft", and "tools" as well. Since they do not have a "blocking" surface, their normal AV applies vs. any damage, including that from attacking or blocking other attacks.

# CORPS



## Basics

**CORPS** is a simple, realistic and deadly RPG system with extremely streamlined rules. Originally a contemporary conspiracy game, the system can be expanded to other genres with relative ease. These conversion notes can be considered official guidelines for generating **CORPS** weapons. Any **3G<sup>3</sup>** or real-world weapon can be converted to **CORPS** using the following guidelines.

## Name

This is the common name of the weapon.

## Caliber

This is the bullet type, beam, bore or projectile diameter. For historical rounds, the common name is used. Most archaic and future rounds will use a metric designation rather than one in inches.

## Damage Value

**CORPS** weapons use the term DV as well, and the value is based on the same principles as **TimeLords** and **3G<sup>3</sup>**. The **CORPS** DV is the **3G<sup>3</sup>** DV/3, rounding fractions down.

## Initiative

The **CORPS** Initiative of a weapon is found by halving the **3G<sup>3</sup>** Initiative of the weapon, and rounding towards the lower number (towards better Initiative).

## Range Mod

The **3G<sup>3</sup>** aiming RC converts to the Range Mod. stat in **CORPS**, and subsumes both the functions of aiming RC and Inherent Accuracy. The conversion is:

$$\text{Range Mod} = (\text{aim RC}^2/3) - 1(n)$$

**Note** - Aiming RC's of 1 and 2 round to a Range Mod of 0 or 1, respectively.

The aiming RC is multiplied by 1.2 for tripod mounted weapons, by 1.8 for turreted weapons or most towed weapons, and 2.4 for fixed or limited-traverse turret weapons (like tank destroyers), rounding down. The table below has the conversions listed.

Aiming RC	Range Mod	Tripod	Turret	Fixed
1	0	0	0	1
2	1	1	3	7
3	2	3	9	16
4	4	7	16	30
5	7	11	26	47
6	11	16	38	68
7	15	23	52	93
8	20	30	68	122

## Adjustments

### Amount

Shoulder-fired, aiming RC 1,2, or 3	+1 Range Mod
Two-handed SMG fired without stock	-1 Range Mod
Each level of increased IA (up to +2)	+1 Range Mod
Each level of decreased IA (up to -2)	-1 Range Mod
Energy weapon	+1 Range Mod

A shoulder-fired aiming RC1, RC2, or RC3 weapon *does* get a +1 to its Range Mod, to give it an advantage over one-handed weapons with similar RC and IA. It is assumed for aiming RC4 weapons that there is a shoulder being used as a bracing point, but an RC3 weapon could either be shoulder fired or fire using a two-handed grip. The longer sighting plane of an RC3 weapon gives it an advantage in long range shots. With two-handed sub-machine guns, the Range Mod stat assumes that they are shoulder fired. They lose a point of Range Mod if fired any other way. If you use the **3G<sup>3</sup>** figure of +20% for energy weapons, treat them as having +1 Range Mod for all purposes.

If a **3G<sup>3</sup>** weapon is bought with increased or decreased IA, each level will increase or decrease the Range Mod by 1 point, for a maximum difference of +2 or -2 from the original Range Mod.

**Example** - An aiming RC4 rifle has a base IA of 2, and a **CORPS** Range Mod of 4. If bought with 1.5x IA, it will have a Range Mod of 5, and if with 2.0x IA, a Range Mod of 6.

With sights, bracing and preparation time, this gives a fixed, aiming RC8 weapon a maximum direct fire accuracy of about 22km. **CORPS** was designed mainly for small arms, and anything beyond an aiming RC5 weapon will start to give skewed results. To take very high Range Mods into account, there are few suggestions.

First, the size of a called shot area cannot be less than the size of the attack, which is common sense.

Second, the minimum size of a called shot area is a -4, at zero range, and for a number of range steps equal to the Range Mod of the weapon plus 1, with a minimum effective Range Mod of 1. For this purpose, Range Mod is affected by situational modifiers that normally affect Range Mod. Each multiple of this increases the minimum targeting area by 1, to -3, then -2, etc.

**Example** - A 9mm pistol probably has a Range Mod of 1. So, at a range of 0-1m, a -4 called shot is possible. At 2-9m (2 range steps), a -3 called shot is possible, at 10-25m (2 more range steps) a -2 called shot is possible, and at 26-49m (2 more range steps), a -1 called shot is possible. No matter how high the skill of a character, the weapon limits how accurate the called shot can be.

Last, all target movement penalties are increased by 1 if the difficulty for range is equal or less than the Range Mod of a tripod mounted weapon, increased by 2 for turreted weapons, and by 3 for fixed weapons. If the difficulty for range is half or less the Range Mod, these penalties are doubled, and tripled if the difficulty for range is a quarter or less the Range Mod.

**Example** - A turreted cannon with a Range Mod of 26 is tracking a running character. If the difficulty for range is 26 or less, any movement modifier is increased by 2 (stationary targets are unaffected). If the difficulty for range is 13 or less, movement modifiers are increased by 4, and if the difficulty for range is 6 or less, movement modifiers are increased by 6. This represents the lag time in tracking targets, when limited by a maximum traversing speed.

**Size**

The function of **3G<sup>3</sup>** Body Points is handled by the **CORPS** Size of the weapon. Size is based on the Bulk, as follows.

Weapon Bulk	CORPS Size
Very Small	1, +1 per location over 1
Small	1, +2 per location over 1
Medium	3, +3 per location over 1

Modifiers	CORPS Size
VS weapon with <.25kg per location	Subtract 1 from total
S weapon with >.75kg per location	Add 1 to total
Extended magazine (>20cm long)	Add 1 to total
or Bulky drum/external box magazine	Add 2 to total
Folding stock	+3/-3 Size if used

Examples	CORPS Size
Holdout pistol (VS/1)	0
Small revolver (S/1)	1
Average autopistol (S/2)	3
Large autopistol (S/2)	4
Machine pistol, stock retracted (S/3)	5
Machine pistol, stock extended	8
Pistol grip shotgun, sawed off (S/3)	5
Pistol grip shotgun (S/5)	9
Hunting rifle (S/7)	13
Assault rifle, stock retracted (S/5)	10
Assault rifle, stock extended	13
Drum fed assault shotgun (S/6)	14
Drum/box fed light machinegun (S/7)	16

The maximum effective size of most firearms is 10 for purposes of resisting damage, regardless of its overall size. A size larger than 10 simply means the weapon has multiple areas, and damage to one may not affect the other.

**Example** - A machinegun of Size 16 is hit by a bullet. It is counted as Size 10 for resisting damage, but even if damage totally destroys that part of the weapon, some other parts of the weapon may be salvageable for parts.

**Tech Level**

This is the same as the **3G<sup>3</sup>** Tech Level of the weapon. The **3G<sup>3</sup>** DV of the weapon is that for the TL it was introduced. If the weapon is available over a TL range, there is a good chance more modern ammunition will have a higher DV in the same weapon (especially the case in times of rapid technological progress). For the utmost in accuracy, use the **3G<sup>3</sup>** Damage Value, multiply it for the change in Tech Level, and then convert to a **CORPS** Damage Value. This is especially the case for low DV's. In general, you can use the table below.

**Mass**

This is the mass of the loaded weapon in kilograms, rounded to the nearest .1kg.

**Extra clip**

This is the mass of an extra clip, magazine, rocket or other removable ammunition source, rounded to nearest .1kg.

**Rate of fire**

This is converted directly from the **3G<sup>3</sup>** ROF, and needs no modification. Lasers with continuous beams are assumed to fire 10 "shots", each one of which counts as 3 hits.

**Clip**

This is the number of shots the weapon can fire from a full load of ammunition. Most clip-fed weapons can carry one extra round in the chamber.

The type of ammunition storage is designated by a letter after the quantity of ammunition.

Ammunition feed	Abbreviation
Removable clip	c
Internal magazine (non-removable)	i
External magazine or feed hopper	e

**Example** - An "8c" weapon has an 8 shot, removable magazine.

**Armor Value**

The AV of a weapon in **CORPS** is two-thirds (round up) the AV in **3G<sup>3</sup>**.

**Cost**

This is just the **3G<sup>3</sup>** cost of the weapon.

**Origin**

This is the country of origin for the weapon, if applicable.

**Reliability**

Most weapons are reliability class I or II, and the +2 modifier for random disasters reflects this. For weapons of low reliability, use the reliability class as the modifier instead of +2, and if a "10" is rolled, the failure is critical in some way. Also, weapons of low reliability will have malfunctions instead of more reliable ones if the random disasters are simultaneous.

**Example** - If using a zip gun (reliability class VI), and the weapon suffered a random disaster, the use of the weapon in this case would get a +6 Difficulty. If the user rolled a "10" to hit, the weapon will probably explode (a reliability class III weapon might just jam up badly).

**Shotguns**

Shotguns in **CORPS** have a "per pellet" damage, and get an increased or decreased number of hits based on pellet quantity. You normally get 1 hit for a success, plus 1 hit for each point the roll is made by. The bonus or penalty alters the die roll (not the chance to hit).

**CORPS Damage Value**

<b>TL8</b>	3	4	5	6	7	8	9	10	11	12	13	14	15	16	17	18	19	20	21	22	23	24	25	26	27	28	29	30
<b>TL9</b>	4	5	6	7	8	9	10	11	12	13	14	16	17	18	19	20	21	22	23	24	25	26	27	29	30	31	32	33
<b>TL10</b>	4	5	6	7	9	10	11	12	13	14	16	17	18	19	20	21	23	24	25	26	27	28	30	31	32	33	34	36
<b>TL11</b>	4	6	7	8	9	11	12	13	14	16	17	18	19	21	22	23	24	26	27	28	29	31	32	33	34	36	37	38
<b>TL12</b>	5	6	7	9	10	11	13	14	15	17	18	19	21	22	23	25	26	27	29	30	31	33	34	35	37	38	39	41

# CORPS

## Guided weapons

Weapons with bonuses to hit in **3G<sup>3</sup>** are counted as getting a +1 to skill in **CORPS** for each 20% bonus to hit (rounding down). Self guided weapons have a skill of 1 per 20% of guidance bonus. Few weapons in a modern **CORPS** campaign will have any type of guidance, although they may be relatively common in the future. The skill of a weapon or its bonus to hit will be listed after the name, like "Guided missile (skill 2)", or "Pistol (+1 skill)".

## Explosions

Blast damage is converted like any other DV, but the result is divided by 15 to get the **CORPS** blast damage. This blast damage drops off using the normal **CORPS** rules.

## Shaped charges

These are calculated normally, and do extremely large amounts of damage. The actual maximum impairment on a person is not increased, but the secondary blast damage is likely to be lethal in any case.

## Fragmentation weapons

**CORPS** has a number of tables showing the skill and damage of a few fragmentation weapons. In general, they have an initial skill, which drops by 1 per range step, and an initial damage, which also drops by 1 per range step. Fragment DV is one half the calculated value (round down).

**Example** - Fragments with a **3G<sup>3</sup>** DV of 16 would have a **CORPS** DV of 5, which would become a fragment DV of 2.

The skill of a fragmentation attack at range 0 is based on the average number of hits on a man-size target at a range of 1m (round fractions down).

Fragments	Hits at 1m	Skill	Typical for
0-24	0	-2	<TL9 grenade
25-49	1	-1	TL9 grenade
50-124	2-4	0	
125-249	5-9	1	
250-424	10-16	2	Improvised fragment bomb
425-649	17-25	3	TL10 grenade
650-924	26-36	4	
925-1249	37-49	5	Small TL11-12 grenade
1250-1624	50-64	6	
1625-2049	65-81	7	
2050-2499	82-100	8	Average TL11-12 grenade
2500-3049	101-121	9	

**Example** - A modern grenade with 3000 fragments would get 120 hits on average at a range of 1m, so it has a **CORPS** skill of 9 at a range of 0m.

## Special ammunition

These are handled using normal **CORPS** guidelines. High powered +P and +P+ ammunition will be counted as 1 or 2 TL's higher, and decrease the reliability of the weapon accordingly (random disasters usually are a point or two of extra Difficulty).

## Indirect fire

Weapons designed for or which have indirect fire capability use the normal **CORPS** rules for indirect fire.

## Lasers

These would be converted using normal **3G<sup>3</sup>** guidelines.

## Particle beams

These would be converted using normal **3G<sup>3</sup>** guidelines.

## Railguns

These would be converted using normal **3G<sup>3</sup>** guidelines.

## Melee weapons

Melee weapons in **CORPS** are converted similarly to other weapons, with the following additions.

### Name

The name of the weapon, followed by any inherent bonus or penalty to use. Clumsier weapons have negative numbers, easier ones to use have positive numbers. Each 2 points of IA (round down) is a +1 to effective skill to hit.

### Damage

Damage is either Combination (half lethal) or Lethal (all lethal), and after that, either cut, puncture or blunt. The latter categories may make a difference when determining eventually fatal results.

### Damage Value

Melee weapon damage is a bonus to damage done by STR. This is figured by dividing the **3G<sup>3</sup>** Damage Value by 4, subtracting 1, and rounding nearest.

**Example** - A knife with a **3G<sup>3</sup>** DV of 7 will end up with a **CORPS** DV of  $((7/4) - 1)(n) = +1$ .

### Initiative

Figured as for normal weapons, with possibly different Initiatives for different modes of attack.

### Length

**CORPS** weapons can have a Length, which is based off the longest dimension of the weapon, as per the **CORPS** rules.

### Size

Figured as for normal weapons. Weapons made mostly of wood have +2 Size because they are bulkier than all-metal weapons.

### Tech Level

As for normal weapons. The **CORPS** Tech Level scale is the same as the **3G<sup>3</sup>** guidelines.

### Armor Value

Figured as for normal weapons, but the haft of any hafted weapon is half the base (round up), and the haft of a tool is a quarter the base (round up). Blocks are considered to be on the haft, and parries against the head. Whether or not a weapon takes damage from blocking an attack depends on the type of attack.

### Cost

As for normal weapons.



## Basics

**GURPS** is a highly detailed generic role-playing system with a wealth of supplements covering a variety of genres and tech levels. The following rules should suffice to convert any **3G<sup>3</sup>** weapon or real-world weapon into **GURPS** terms.

## Name

This is the common name of the weapon, followed by the caliber of the weapon. If the weapon is a muzzle-loader, the caliber will usually be followed by "BP" to show that it is a black powder weapon (if a flintlock or matchlock), and "perc" if it is a percussion-fired weapon. Lasers, particle beams and railguns will also have a notation for the weapons type.

## Type

This is the damage type of the weapon, and for firearms will either be Crushing or Impaling damage. Laser, particle beams and most other energy weapons will do impaling damage. Most projectiles will do crushing damage, but any projectile travelling at >1000m/sec (3280ft/sec) will be counted as impaling damage.

## DMG

The formula for converting a **3G<sup>3</sup>** Damage Value to **GURPS** damage rounds nearest if there is any question. To convert from **3G<sup>3</sup>** to **GURPS**, the formula is:

$$\text{GURPS average damage} = .26 \times \text{DV}^{1.12}$$

For instance, a DV of 20 is an average of 7.45 points of damage, which rounds to 2d (average of 7.0). A DV of 21 is an average of 7.87 points of damage, which is 2d+1. Remember that large bore weapons may have a damage multiplier for anything that gets through DR (see **GURPS High Tech**), or use the energy-based DV for a weapon-specific multiple on what gets through DR.

## SS

The Snap Shot number for a **GURPS** ranged weapon is equal to (14 - its **3G<sup>3</sup>** Initiative), -2 more if it is a one-handed weapon. That is, the worse the initiative, the higher the Snap Shot number.

## Weapon ACC

Weapon ACC is based on the aiming RC of the weapon, and is (Aiming RC - 1)<sup>2</sup> + 2, and the base ACC's are below.

Aiming RC	Base ACC	Aiming RC	Base ACC
1	2	5	18
2	3	6	27
3	6	7	38
4	11	8	51

Modifiers	Amount
Weapon is suppose to be fired two-handed	+1ACC
Damage RC better than aiming RC	+1ACC per
Damage RC worse than aiming RC	-1ACC per
Below <b>3G<sup>3</sup></b> TL8	-1ACC
Above <b>3G<sup>3</sup></b> TL12	+1ACC
Each point of IA above the base	+1ACC
Each point of IA below the base	-1ACC
Energy weapon	+aiming RC

The bonus a weapon gets to ACC from increased IA, type of weapon or other factors cannot exceed the **3G<sup>3</sup>** aiming RC of the weapon. That is, if a weapon is aiming RC3, the maximum bonus that can apply to its **GURPS** ACC is +3. Since a weapon with an aiming RC of 3 has a base ACC of 6, this weapon could not get an ACC better than a 9, regardless. Any excess would be lost *before* applying penalties to ACC.

## 1/2D

The 1/2D number of a **GURPS** weapon corresponds to the damage RC of the weapon, and is the distance where the damage RC modifier is -9 (which turns the DV into half the number of **GURPS** damage dice). If there is no -9 entry, use whichever number is closest, going to the shorter range if equal. Make sure to translate correctly from meters to yards (multiply meters by 1.094). To give a smoother transition, and to fit in more with published **GURPS** numbers, use the numbers in the second column.

Damage RC	1/2D distance	Optional distance
1	110 yards	100 yards
2	220 yards	150 yards
3	439 yards	200 yards
4	876 yards	500 yards
5	1,640 yards	1,000 yards
6	3,830 yards	2,000 yards
7	7,110 yards	4,000 yards
8	15,300 yards	8,000 yards

Modifiers	Amount
Below <b>3G<sup>3</sup></b> TL8	-15%
Above <b>3G<sup>3</sup></b> TL12	+15%
Shotgun pellets	-75%
Flechettes	-50%

If a weapon has a low velocity and high damage RC, (a rocket or mortar, for instance), and the 1/2D range is *greater* than the maximum range, the 1/2D distance will default to half the maximum range (based on muzzle velocity) or one second's projectile travel, whichever is *shorter*.

## Max

The maximum range of a weapon is based on its damage RC, and is where the damage modifier for range is -20. See below.

Damage RC	GURPS Max
1	876 yards
2	3,830 yards
3	5,950 yards
4	7,100 yards
5	15,300 yards
6	29,500 yards
7	54,700 yards
8	110,000 yards

Modifiers	Amount
Shotgun pellets	-75%
Flechettes	-75%

For thrown weapons, Max is equal to the maximum throwing distance for the mass of the weapon in the basic **GURPS** rules, assuming a minimum of 1 pound. The 1/2D distance is the maximum throwing distance for an object that weighs twice as much (minimum of 2 pounds).



# GURPS

## Weight

All **GURPS** weights are in pounds, while **3G<sup>3</sup>** masses are in kilograms. The conversion between the two is 1.00kg = 2.21 pounds.

## ROF

The ROF of a weapon will follow **GURPS** guidelines. These are below:

Action	ROF
Semi-auto	3
Large bore semi-auto	2
Single action revolver	1
Double action revolver	3
Pump action	1/2
Lever action	1/2
Bolt action	1/2
Bolt action, single shot	1/4

## Shots

This is the number of shots that can be fired from the weapon. Most weapons with clips or detachable magazines will have a "+1" meaning that you can have 1 shot in the chamber, in addition to a full clip (e.g. 8+1 means an eight-shot clip, and you can *manually* put one extra round in the firing chamber before inserting the clip to get nine shots before having to reload).

## ST

Vehicle mounted weapons have no ST minimum. For any other weapons with recoil, the Strength needed for a **GURPS** weapon is (7 + DV/10), round nearest, with the following modifiers to the total:

Modifiers	Amount
Weapon designed to be used in both hands	-3
Shotguns/weapons firing a multiple projectile round	+1
Bipod mounted weapons	-1
Tripod mounted weapons	-2
Weapons with small muzzle brake*	-1
Weapons with medium muzzle brake*	-2
Weapons with large muzzle brake*	-3

\*subjectively figured, but large muzzle brakes will add to bulk and mass

## Rcl

The recoil of a **GURPS** weapon is the DV/10 for pistols, DV/20 for rifles, and DV/30 for bipod or tripod mounted weapons. Fractional amounts round down in all cases.

## Cost

As per the **3G<sup>3</sup>** rules.

## Tech Level

All weapons have damages appropriate for the lowest TL in a range. A weapon which exists in unmodified form over multiple TL's may have a higher damage at the higher TL due to better materials able to handle a more powerful round. So, if you design weapons that should be approximately equal, but are not, check for TL differences, like comparing a .45 cal pistol at **GURPS** TL6 with a 9mm pistol at **GURPS** TL7. It is unlikely that "conventional" weapons will have a life past the range of **GURPS** TL6-8 (which corresponds to **3G<sup>3</sup>** TL9-14). Don't get cocky, though. Antique weapons can still kill you dead.

The actual TL of a **GURPS** weapon is based on the **3G<sup>3</sup>** TL, as follows.

3G <sup>3</sup> TL	GURPS TL	Year equivalent
2	0	10,000BC
3	1	3,000BC
4	2	0AD
5	3	1400AD
6	4	1700AD
7	5	1800AD
8	late 5	1900AD
9	6	1930AD
10	early 7	1960AD
11	7	1980AD
12	late 7	2000AD
13	8	2100AD
14	late 8	2200AD
15	9	2300AD

The "ultra-tech" **3G<sup>3</sup>** TL's would correspond to **GURPS** TL10, but beyond that is too far to take any extrapolation of modern science, so you might as well just make things up.

## Initiative (optional)

This stat is not used in **GURPS**, but may be included as an option. Halve the **3G<sup>3</sup>** Initiative, rounding towards zero. This amount may be added to the Move of the user, solely for purposes of seeing who acts first as a combat action. It will not apply for actual movement or other purposes, and negative Initiatives will *not* apply in cases where the weapon is prepared already (like an ambush).

## Holdout modifier

This stat is used in **GURPS High Tech** to denote the concealability of a weapon. Use the following guidelines (round up in size).

Weapon size	Holdout
Very Small	+2, -1.5 for each loc. past 1, -2 for each past VS/6
Small	-1, -1 for each loc. past 1, -2 for each past S/6
Medium	-3, -2 for each loc. past 1, -3 for each past M/3
Extended clip	additional -1 for box clips, -2 for drum magazines

## DR (optional)

This stat is not normally figured for **GURPS** weapons, but can be calculated from the AV. These are converted just like a DV, but with a minimum value of 1. For guns, the DR represents the ability of the weapon to withstand abuse and area effect attacks. Also, it will absorb damage that might otherwise hit the character in certain circumstances.

AV or BP	DR or HT	AV or BP	DR or HT
1-4	1	13-15	5
5-7	2	16-17	6
8-10	3	18-20	7
11-12	4	21-22	8

## HT (optional)

This stat is not normally figured for **GURPS** weapons, but can be calculated from the BP of the weapon. This is converted just like a DV, with a minimum value of 1. Damage that gets through the DR of a weapon will do 1 hit per die of attack. A weapon that is damaged may or may not be functional or repairable, at GM option, but a weapon that loses all its HT is irrevocably destroyed.

**Clip wt. (optional)**

This is converted over from the **3G<sup>3</sup>** mass.

**Reliability (optional)**

These are handled in **GURPS** by the Critical Failure result. Optionally, after the result on the Critical Failure table is rolled, shift the die roll, based on the Malfunction Class of the weapon.

Malfunction	Effect
I	Shift roll by one point towards center of table
II	No change
III	Shift roll by 1 point towards nearest extreme
IV	Shift roll by 2 points towards nearest extreme
V	Shift roll by 3 points towards nearest extreme
VI	Shift roll by 4 points towards nearest extreme

This tends to make high reliability weapons have less catastrophic results than low reliability ones. Another option is to alter the number needed for critical failure by the same amount, making failures more likely for low quality (or low-tech) weapons.

**Shotguns (optional)**

The quantity of pellets in a buckshot round will round nearest for damage calculations. However, fractional damages are kept until all are added to get the final damage. **3G<sup>3</sup>** uses a single large damage to represent buckshot, like the **GURPS** rules. Take the damage of a single pellet, and add this damage each time the number of pellets is doubled. You can either count this a number of 1d attacks, as per the rules, or use the actual damage per pellet (which is halved at the 1/2D range).

Pellets	Multiply base by
1	x1
2	x2
3-6	x3
7-12	x4
13-23	x5
23-47	x6
48-95	x7
96-192	x8

**Example** - A shotgun with 15 pellets, each with a DV of 13 (4.60 points **GURPS** damage (1d+1)) will multiply this by 5, for a total of 23 points, which is average damage for 6d+2. This can either be treated as 6 hits at 1d each, or 5 hits at 1d+1. A 150 pellet load at a DV of 6 (1.93 points **GURPS** damage (1/2d)) will multiply this by 8, for a total of 15.5 points, which is average damage for 4d+1. This can either be treated as 4 hits at 1d each, or 8 hits at 1/2d each.

**Guided Weapons (optional)**

Guided weapons in **GURPS** will get a +2 to hit for each 25% guidance bonus, with 15% increments being a +1. A guidance system may also have certain special effects, like negating darkness, smoke or other obscurement.

Self-guided weapons are assumed to have a default skill of 8, plus any bonus given by guidance and target size. If being used at short range under player control instead of self-control, the skill bonus will apply to player skill instead.

If a smart weapon fires at a target further away than the 1/2D range, the bonus may be halved or lost altogether, at GM option.

**Explosives (optional)**

Explosive DV is converted normally to **GURPS** damage, and is treated like a **GURPS** explosion in all respects. Fragments in **GURPS** do 2d damage. You may change this to a converted **3G<sup>3</sup>** damage at GM option. The chance of being hit by a fragment is as in **GURPS**, assuming the weapon has a total of 500 fragments. Each time this is doubled (round down), the character will have to make an additional roll on PD to avoid another hit. Each time the number of fragments is halved (round down), the character gets a +1 on their PD to see if they avoided being hit. PD is also increased by +1 each time concussive damage is reduced by range (note that this is different than **GURPS**, and is to take very large fragmentation weapons into account).

Fragments	Roll required
8-15	PD+6
16-30	PD+5
31-61	PD+4
62-124	PD+3
125-249	PD+2
250-499	PD+1
500-999	PD
1000-1999	2@PD
2000-3999	3@PD
4000-7999	4@PD

Range	Modifier
0-1 hexes	+0PD
2-3 hexes	+1PD
4-5 hexes	+2PD
6-7 hexes	+3PD
etc.	

**Example** - A modern grenade with 3,000 fragments lands 4 hexes away from a character. Using the table above, they need to make 3 rolls on PD, and each failure means a fragment hit. However, because of the range, PD gets a +2 for each roll.

For directional fragmentation weapons, multiply actual fragments by 6 for a 30° wide attack, and 12 for a 15° wide attack, and double the ranges at which you increase PD, to take the more direct stream of fragments into account.

**Special ammunition (optional)**

This is done according to normal **GURPS** rules. Usually, a weapon will have a descriptive note if it uses ammunition that has a special effect. By **3G<sup>3</sup>** rules, all steel railgun projectiles are counted as armor piercing vs. armor of the same **GURPS** Tech Level or below. Note that only the base damage is listed here. If you wish to multiply for weapon type, make a note of it.

**Lasers (optional)**

As designed in **3G<sup>3</sup>**, most laser attacks are individual shots, and do not add damage for multiple hits. A continuous beam laser would act like those in the normal **GURPS** rules, i.e. add the damage of multiple hits.

**Melee weapons**

To convert melee weapons from **3G<sup>3</sup>** to **GURPS**, round the average **GURPS** damage down, then subtract 4 for cut/chop attacks. For thrust attacks, divide average **GURPS** damage by 2, round down, and subtract 1. This number is the bonus or penalty to the character's normal damage.

# GURPS

3G <sup>3</sup> Damage	GURPS Damage	
	Cut	Thrust
1	sw-4	thr-1
2	sw-4	thr-1
3	sw-4	thr-1
4	sw-3	thr-1
5	sw-3	thr-1
6	sw-3	thr-1
7	sw-2	thr
8	sw-2	thr
9	sw-1	thr
10	sw-1	thr
11	sw-1	thr
12	sw	thr+1
13	sw	thr+1
14	sw+1	thr+1
15	sw+1	thr+1
16	sw+1	thr+1
17	sw+2	thr+2
18	sw+2	thr+2
19	sw+3	thr+2
20	sw+3	thr+2
21	sw+3	thr+2
22	sw+4	thr+3
23	sw+4	thr+3
24	sw+5	thr+3
25	sw+5	thr+3

**Note** - Comparing it to current **GURPS** weapon lists, this is almost a perfect damage conversion, and may be useful for importing weapons from other game systems.

## Reach

The reach of a **GURPS** weapon equals length in meters, round up. Thrusting weapons only have reach at maximum distance. Unbalanced weapons only get reach at the 2 maximum levels of reach. Closer than this and they are too unwieldy to use.

**Example** - A berdiche with a length of 2.4 meters would have a reach of 3. For swinging it, it would have a reach of 2,3, and for thrusting attacks, it would have a reach of 3.

## Maximum damage (optional)

The maximum damage an edged melee weapon may inflict is the weapon's (DRx2). More than this, and the weapon itself will break or suffer damage. Blunt weapons may deliver up to (DRx3). The DR of a hafted weapon is based on the AV of the head rather than the haft for purposes of figuring DR (usually 1.5x base AV).

## DR (optional)

This is optional, and is converted as for ranged weapons. For hafted weapons, the DR is halved (round up) if the haft is struck, and for tools, it is halved again (round up).

## HT (optional)

This is optional, and is converted as for ranged weapons. Note that to do damage to a weapon, the right type of attack must be used. It would be difficult to damage a sword by thrusting at it with another sword, for instance. Both DR and HT are convenient to know in any campaign with area effect attacks like magic, or specific anti-item spells like Weaken and Shatter.

## Weapon quality (optional)

**GURPS** does not have IA as a melee weapon stat. Assume tools are "poor" or "very poor" quality weapons for purposes of breaking in use (but not if dropped, etc.), and are -3 to a weapon skill because of their unwieldy nature. Weapons with an IA of less than 1 usually qualify. Weapons with an IA of +1 are "standard", and normal rules apply. Weapons with an IA of +2 are "fine", and get the benefits normally applying to such. They might be considered to trade AV for BP, making them harder to damage, or perhaps just given +1DR and HT. In general, the DR of tools for defending against blows is half the listed amount (round up) unless the defender makes their block/parry by 3 points or more. Normally, blows would be taken on the weaker haft of a tool, but a good success means it is taken on the stronger part. Weapons with wooden hafts usually have reinforcement, and get their normal AV over the entire length.

## Min ST

Balanced **GURPS** weapons have a base minimum ST of 7, unbalanced ones have a minimum ST of 9 and automatically take 1 turn to ready. After that, the Min ST is modified as follows:

Modifier	Adjust Min ST by
Takes +1 turn to ready	-2
Takes +2 turns to ready	-4
Each +1 of damage (best type)	+2
Weapon only does impaling damage	-2

**Example** - You make up an axe that does sw+2 damage. An ax is an unbalanced weapon, so it starts with a Min ST of 9, +4 for the extra damage, for a Min ST of 13. If you say it takes an extra turn to ready, the Min ST goes to 11.

**Example** - You make a stabbing weapon that does thr+0 damage. It starts with a Min ST of 7, and drops 2 more since it only does impaling damage, for a Min ST of 5.

## Damage type

If a thrusting weapon has a point and is over about 5-6cm long, it can get impaling damage, otherwise it is crushing damage. Swung weapons either get crushing or cutting damage, depending on whether or not they have an edge.

## Weapon TL

Most melee weapons are listed as **GURPS TL3 (3G<sup>3</sup> TL5)**, which is where "standard" quality weapons of that type could be made, even if that particular weapon did not historically exist at that time. Fine or very fine weapons will become easier to make at higher TL's.

## Final Note

**GURPS** is a very detailed system, and with a large number of stats per weapon, 100% conversion accuracy is difficult. For more detail on specific firearm or weapons topics, we refer you to **GURPS** supplements that go into much more detail than the basic set. For modern, historical and near future weapons, **GURPS High Tech** is probably the best source for system specific rules on advanced topics such as ammunition types, explosives, etc. **GURPS Vehicles** will have notes on heavy weapons, explosives, guidance systems and other specialized topics.

# MASTERBOOK™

## Basics

The **MasterBook** system is an rpg system designed to work in a variety of mileus and fictional universes. These notes should have all the information you will need to convert any **3G<sup>3</sup>** or real-world design into any game using the **MasterBook** rules.

## Name

This is the common name of the weapon, and will be followed by the caliber of the weapon, just so you know which players can trade ammunition with others, or what ammunition to put in a found or stolen weapon.

## Tech

The **MasterBook** system does not have Tech Levels as such. Each individual game world has certain characteristics that will determine what technologies are available. New mileus will have to be converted on an individual basis.

World/genre	3G <sup>3</sup> TL	Year equivalent
Bloodshadows	8-9	1900-1930AD
Indiana Jones	8-9	1900-1930AD
Shatterzone	12-15	2000-2300AD

**Torg** Tech Axioms are no longer used, but modern weapons (**3G<sup>3</sup>** TL9-12) range from Tech Axiom 20 to late 23.

## Damage Value

**MasterBook** uses a logarithmic scale for measures, that is, an increase by a factor of 10 increases the **MasterBook** value by 5. **3G<sup>3</sup>** uses an inverse quadratic scale for measuring damage, the DV goes up as the square root of the weapon energy. The best fit between **3G<sup>3</sup>** and **MasterBook** Damage Values is:

$$\text{MasterBook Damage Value} = 8.3 \times (\text{3G}^3 \text{ DV})^{-25} (n)$$

$$\text{Torg Damage Value} = 8.3 \times (\text{3G}^3 \text{ DV})^{-2} (n)$$

3G <sup>3</sup> DV	MasterBook	3G <sup>3</sup> DV	MasterBook
1	8	16-19	17
2	10	20-23	18
3	11	24-30	19
4-5	12	31-37	20
6	13	38-45	21
7-9	14	46-54	22
10-12	15	55-64	23
13-15	16	65-75	24

**Really important note** - The damage scale has been changed since the original **Torg** system that this conversion was based on, to give higher **MasterBook** damages to smaller weapons. For instance, while a small pistol still has a **MasterBook** damage of 14, a heavy pistol (such as a .44 Magnum) now has a damage of 20, where before it would have had a **Torg** damage of 16-17. As a result, the numbers are different here than in the first printings of both **3G<sup>3</sup>** and **More Guns!**. Sorry to have to change things in mid-stream, but we have to keep up with the changing rules as they develop. That's what **3G<sup>3</sup>** is about!

## Autofire (optional)

If a firearm is capable of burst or autofire, the **MasterBook** Damage Value is increased, based on the usual number of rounds fired. The guidelines below are intended to supplement, rather than replace the ranged weapon optional rules in **MasterBook** for burst fire, full auto, etc. When figuring out how much lead a character can spray, assume a combat round is no more than 5 seconds, and you can't use more than one clip of ammo in that time.

3G <sup>3</sup> average ROF	Attacking Modifier
1-2	+0
3-7	+1
8-12	+2
13-17	+3
18-22	+4
23-27	+5
28-32	+6
33-37	+7
38+	+8

Weapons capable of autofire or bursts may have multiple Attack Modifiers. The first is single shot (if the weapon can fire one shot at a time), the second is autofire against a group of targets (spreading the rate of fire over the equivalent of 3 targets, round down), and the third is burst fire against a single target (a single burst against one target). The autofire bonuses listed presume that only 1 clip or magazine can be fired in a combat round, and that any extra time is spent reloading so that the weapon will be ready for the next round. If all fire from a weapon is directed at a single target, the **MasterBook** Damage Value is increased by half (round down) the Attacking Modifier. If autofire is directed against a group, the **MasterBook** Damage Value is increased by a quarter (round down) the Attacking Modifier. An Attack Modifier cannot exceed 1/3 (round nearest) the **MasterBook** Damage Value.

**Example** - A 9mm machine pistol (**3G<sup>3</sup>** DV22) with a 30 round clip has a single shot **MasterBook** Damage Value of 18. If you spread the entire clip over an area, that is an average of 10 shots per target, so you would have an autofire Attack Modifier of +2 vs. each target, but the Damage Value would stay the same, since you are unlikely to hit any given target more than once (you're spraying wildly). If you fired a 3 round burst at a single target, you would have a burst fire Attack Modifier of +1, and again, no extra damage, since you are only likely to hit once. However, if you do a 10 round extended burst at a single target, you get an Attack Modifier of +3, and a Damage Modifier of +1 (half of +3, round down).

**Note** - This means that weapons with absurdly high rates of fire (like the GE Minigun M134) which can fire 50 rounds a second(!) will have Attack Modifiers of +8 vs. a group *or* individual, with a Damage Modifier of +2 vs. a group, or +4 vs. an individual who is the most unhappy center of attention.

How you list the damage value of a burst or autofire weapon is dependent of how you see it being used. The actual damage done by a single machine gun bullet is the same, whether it is fired one shot at a time or as a burst. However, if it is always fired as a burst, you might as well just factor in the Damage Modifier to begin with, and then just subtract if it is fired single shot, and add if it is fired full auto, as per the normal rules.

# MasterBook

## Shotguns

Shotguns are a limited form of autofire weapon, in that one shot can spray a number of pellets (or a single large slug). A shotgun will count the number of pellets it has for determining both the Accuracy and Damage Modifier of the weapon, remembering the maximum Accuracy Modifier (and hence Damage Modifier) is based on the Damage Value of an individual pellet. Depending on the type of shot used, a shotgun that can fire multiple shots may be able to get an even higher bonus. Remember though, that you can only aim at one target per shot (or multiple targets very close to each other). Shotguns using shot lose 2 points of Attack Modifier at Medium range and each range past that.

**Example** - A 12ga shotgun loaded with 00 Buckshot has about 12 pellets, each with a **MasterBook** Damage Value of 15. So, it has an inherent Attack Modifier of +2, and Damage Modifier of half that, or +1. So, for all practical purposes you would give the weapon a +2 Attack Modifier and a Damage Value of 16. If it were firing a 12ga slug instead, it would get no Attack Modifier, but the Damage Value would be closer to 20. A pump action, semi-auto or double-barreled shotgun could use the numbers for 24 pellets instead of 12, and get a +5 Attack Modifier and +2 Damage Modifier at Point Blank and Short ranges, but at Medium range it would be +3 Attack and +1 Damage Modifier.

## Range

The Range Steps for weapons listed in the **MasterBook** rules are generally different for each weapon type, even within a weapon type, and may be different among roughly equivalent weapons. The best way to determine the five **MasterBook** range steps is below:

**Point Blank** - The maximum range at which the weapon's aiming RC gives a +15 or better modifier (round nearest).

**Short Range** - The maximum range at which the weapon's aiming RC gives a +2 or better modifier (round nearest).

**Medium Range** - The maximum range at which the weapon's aiming RC gives a +0 or better modifier (round nearest).

**Long Range** - The maximum range at which the weapon's aiming RC gives a -4 or better modifier (round nearest).

**Extreme** - The maximum range at which the weapon's aiming RC gives a -8 or better modifier (round nearest).

If there is no range that has the exact modifier needed, use the range step which has the closest modifier, using the shortest range if two or more bands are otherwise equal (see the aiming modifier table at the back of this book).

If a weapon has an IA different than the base for its aiming RC, shift the range steps right or less by one band for each point of IA different than the base.

**Example** - A pistol with an aiming RC of 2 has a base IA of 1, and would have Point Blank, Short, Medium, Long and Extreme ranges of 3m, 10m, 20m, 50m and 70m, respectively. If the weapon had an IA of 0 (1 point *below* base), the range steps would be 1m, 7m, 15m, 35m and 50m, and if it had an IA of 2 (1 point *above* base), the range steps would be 5m, 15m, 25m, 70m and 100m.

## Range Modifiers (optional)

The **MasterBook** system has Accuracy Modifiers and Damage Modifiers that apply within certain range bands to certain weapon types. For instance, a rifle may be harder to hit with at very short range, but if it does hit, it will do more damage. Or, it might be designed to hit targets at long range, but not do as much much damage if it does because the bullet has slowed down or the energy beam has begun to dissipate. This is in addition to any rate of fire bonus that may apply, but might also include recoil penalties on accuracy at different ranges.

The Accuracy Modifier is based on the aiming RC of the weapon, and the Damage Modifier is based on the damage RC of the weapon. Again, this is not meant to substitute for the current **MasterBook** weapon notes, but a guideline for creating your own for weapons that fall outside the listed parameters. For instance, the Aiming RC2 category matches normal pistol ranges, and RC4 matches rifle ranges, while RC1 might be a very inaccurate pistol, and RC3 a carbine or a target pistol.

Aiming RC	Point Blank	Short	Medium	Long	Extreme
1	+3	+2	+0	-2	-4
2	+2	+1	+0	-1	-3
3	+0	+0	+1	+0	-2
4	-2	+0	+2	+1	-1
5	-4	+0	+1	+1	-0
6	-6	-2	+0	+1	+1
7	-8	-4	+0	+1	+2
8	-10	-6	-2	+1	+3
Autofire wpn*	+0	+0	+0	-1	-2
Shotgun pellets	+0	+0	-2	-4	-6

\* Autofire weapons and shotguns get their bonus at close range from their rate of fire or number of pellets. At longer ranges, they take penalties due to recoil.

For damage, even Damage RC1 projectiles do not begin to lose an appreciable amount of energy until well past the range where they are likely to hit something. In general, unless you have an extremely accurate weapon firing projectiles with a low Damage RC, the easiest way to handle it is to give a -1 Damage Modifier at Long range, and a -2 Damage Modifier at Extreme Range.

## Explosions

**MasterBook** rules are somewhat vague on explosives and other area attacks. Making a lot of assumptions, the best fit equation is:

$$\text{MasterBook Explosion Value} = 6.0 \times (3G^3 \text{ DV})^{-25} (n)$$

$$\text{Torg Explosion Value} = 6.8 \times (3G^3 \text{ DV})^{-25} (n)$$

**Example** - A TL13 grenade with 200g of explosives has a **3G<sup>3</sup>** Damage Value of 94, and a **MasterBook** blast Damage of 19.

Blast damage has both a blast radius and a drop-off. The first is how far out you have to go from ground zero before blast effects drop, and the second number is how much they drop at this distance and each multiple of it. The normal blast radius in **MasterBook** is 2m for Point blank, 3-5m for Short, 6-15m for Medium and 16-25m for Long range (round nearest). Multiply these by the following to get the actual ranges:

$$\text{Multiplier} = (3G^3 \text{ DV})^{-67/28}$$

**Example** - The previous grenade with a **3G<sup>3</sup>** DV of 93 would multiply these ranges by x.74, for Point blank range of 0-1, Short of 2-4m, Medium of 5-11m and Long range of 12-19m.



Blast can drop off one of two ways. **Shatterzone** has general blast damage drop off by 5 for each 5 meters outside the primary blast radius, rounding fractional distances up.

The other way is to base the drop-off on the nature of the explosion. Explosions that are a side effect of HEAT warheads drop in damage by 1.5 times the middle range in the Short range band(u). Normal explosions drop in damage by 1.0 times the middle range in the Short range band(u), and explosions that are supposed to be diffuse or cover a very wide area (perhaps a cluster bomb) drop in damage by .70 times the middle range in the Short range band(u). If an explosion has a Point blank range of 1 meter, then it only has full effect on the actual target of the explosion. Immediately adjacent items take the Short range damage. For normal explosives, some samples are below.

3G <sup>3</sup> TL12 explos.	MasterBook DV	Short	Medium	Long
50g/DV45	16	2(-2)	3-7(-4)	8-11(-6)
100g/DV64	17	2-3(-3)	4-9(-6)	10-15(-9)
250g/DV101	19	3-4(-4)	5-12(-8)	13-20(-12)
500g/DV142	21	3-5(-4)	6-15(-8)	15-25(-12)
1000g/DV201	23	3-6(-5)	7-19(-10)	20-31(-15)
2500g/DV318	25	4-8(-6)	9-25(-12)	26-42(-18)
5000g/DV450	28	5-11(-8)	12-32(-16)	33-54(-24)

**Example** - A 5kg HEAT warhead would have a drop-off at the listed ranges of -12 at Short range and -24 at Medium range, while a fuel-air bomb the same size would only have a drop-off of -6 at Short range, -12 at Medium range and -18 at Long range.

Grenades have a separate Damage from the blast. This is based on the Damage of the individual projectiles, and is increased by the autofire bonus appropriate to the number of pellets that would hit a standing person at a range of 1m (which is total fragments/25), with a maximum damage bonus of +4. The fragment damage drops by 2 per range step, so they would have a -2 at Short, -4 at Medium and -6 to damage at Long range.

**Example** - A grenade with 1000 fragments would hit a person at 1m with 40 of them. This would be a +8 Attack Modifier, so the grenade gets a +4 Damage Modifier. The grenade does not actually get any Attack Modifier for fragments, since it is a thrown object, but the large number of fragment hits will increase the apparent damage a target takes.

#### Indirect fire (optional)

Weapons designed for indirect fire (like grenade launchers, cannon, etc) may be used as indirect fire weapons well beyond the normal aimed range. The maximum range for this is 5x the listed "Long" range. Such shots require that a specific spot be aimed at, rather than a target, and if the target is in that spot, and the attack hits, the target is affected. For instance, if you fired at a moving ship, you would fire not at the ship, but where you expected the ship to be at some time in the near future. Any skill at military tactics or knowledge of how an opponent thinks could give a bonus to such an attack. It also means that you do not roll to hit until the weapon actually reaches its target, which will usually take at least a turn, and sometimes several. An indirect attack is a -4 Attack Modifier (like a "trick shot"), but does not get the Damage Modifier for that type of shot. Most weapons which can be used in an indirect mode will have an "i" superscript after the name.

#### DV format

For weapons which can be aimed out to a certain range, and then have explosive or other effects, the Short, Medium and Long ranges may have a format like "10(0-2)" under the "Short" range column. This means that for aiming the weapon, out to 10 meters is considered Short range, and for the explosive warhead, a range of 0-2 meters is Short range for blast effects.

#### Ammo

All weapons have an ammo listing equal to the actual number of rounds carried in most cases. This is not the same as the number of combat rounds of game time. In general, for non-automatic weapons, there is a 1-to-1 correspondence between clip size and combat rounds.

**Example** - A semi-auto pistol with an Ammo of 10 probably has a 10 round clip.

Weapons that can only fire in an autofire mode will probably list the number of rounds of fire they can be used for before reloading. You would base this on the 3G<sup>3</sup> rate of fire and total ammunition carried.

#### Archaic weapons (optional)

For reality purposes, muzzle loading weapons should require at least 4 rounds of uninterrupted work to reload (per shot), otherwise they are just as fast to fire as a cartridge-based single shot weapons.

#### Price

The price is converted directly from the 3G<sup>3</sup> value of the weapon, as per the guidelines in the rules. The GM should add scarcity or legality modifiers to the price as appropriate.

#### Toughness (optional)

If you want to, the 3G<sup>3</sup> Armor Value of a weapon can be converted into a Toughness, which can be used if you try to break something. This is figured out just like the AV of the weapon was a DV, using the previous table.

**Example** - A weapon with a 3G<sup>3</sup> Armor Value of 16 has a **MasterBook** Toughness of 17.

#### Bulk (optional)

Weapon size is not used in **MasterBook**, but a general number can be figured as an optional stat.

3G <sup>3</sup> Bulk	MasterBook size
Very Small	0, +1 per extra location
Small	2, +2 per extra location
Medium	4, +4 per extra location
Large	8, +8 per extra location

A weapon's **MasterBook** bulk or a fraction of it subtracts from a character's effect whenever they try to do something where holding the weapon would get in the way. This could be hiding the weapon under a jacket (more bulk is harder to conceal), trying to climb a rope and shoot at the same time (bigger weapon is harder to aim in this case), etc. Weapons that are slung or holstered but can still get in the way use half or less of their Bulk.

# MasterBook

Weapons can have two numbers for their bulk if they have a folding stock or some other way to be more compact. The normal stats for the weapon are using the first number. If the number in parentheses is larger, the weapon gets a +1 bonus if the stock is extended. If the number in parentheses is smaller, the weapon gets a -2 penalty if fired with the stock retracted.

For the optional bulk attribute, treat any two handed weapon as having a **3G<sup>3</sup>** Bulk of Small instead of Very Small for its locations (i.e. a S/2 pistol would have a **MasterBook** bulk of 4, and a VS/5 carbine would have a **MasterBook** bulk of 10).

## Initiative (optional)

This is not used in **MasterBook**, but as an option, the side with the best overall weapon initiative may reflip the card if the result goes against them the first time.

## Reliability (optional)

If a card is played which would indicate an equipment failure of some type, it will happen preferentially to the character currently using the least reliable weapon, unless it already happened to that weapon previously, in which case you use the second least reliable weapon.

## Sighting aids

Telescopic sights give an additional +2 Attack Modifier if a character aims for a round, but otherwise give a -1 to regular fire (the sights block the view for unaimed shots). Laser sights give a +1 Attack Modifier, but are visible only indoors or in poor outdoor lighting. Gyrostabilizing cancels up to -2 in Attack Modifiers for movement.

## Guidance systems

A weapon with a user-guided guidance system gives it a **MasterBook** Attack Modifier of +1 per 10% of guidance bonus (round down). Self-guided weapons are assumed to have a Dexterity of 5, and use the guidance system as a skill bonus, noting that if the user is unskilled, they either cannot use the weapon at all, or use it with a +4 Difficulty Number.

**Example** - A character using a wire-guided missile with a +30% **3G<sup>3</sup>** sensor bonus would get a +3 Attack Modifier when using the weapon, and would probably want to take the normal +2 Attack Modifier for aiming as well. A character with a Stinger missile (+20% self-guided) would ignore their own Dexterity, and use a Dexterity of 5 and +2 Skill Mods for the weapon.

## Special ammunition (optional)

The use of special ammunition may change the Damage Value and Effect of a weapon. Hollow point or other increased tissue disruption rounds increase the **MasterBook** Damage Value by 3, but double the Toughness of any armor worn or penetrated as cover. Armor piercing rounds decrease the Toughness of **MasterBook** armor by 4, but decrease the Damage Value of the weapon by 2 points.

## Other bonuses

A ranged weapon with above average Inherent Accuracy gets a permanent +1 Attack Modifier to take its quality into account. Weapons with below average Inherent Accuracy suffer a permanent -1 Attack Modifier because they are woefully hard to hit with.

## Muscle powered missile weapons

Melee weapons apply most of the same rules as ranged weapons, but their Damage Value is computed slightly differently. The plus to **MasterBook** Damage Value is the normally converted **3G<sup>3</sup>** DV, minus 8. The maximum possible damage is either double the STR+bonus or the the bonus of the weapon plus 14, *whichever is lower*.

**Example** - A character with average Strength can pull a bow that does a **3G<sup>3</sup>** Damage Value of 10. This turns into a **MasterBook** damage value of STR+7, which is the **MasterBook** damage for a composite bow.

The Toughness of a muscle-powered weapon is based on the average AV from the **3G<sup>3</sup>** design.

## Melee weapons

Melee weapons apply most of the same rules as ranged weapons, but their Damage Value is computed slightly differently. The plus to **MasterBook** Damage Value is the normally converted **3G<sup>3</sup>** DV, minus 10. Add the IA to the converted damage value to get the **MasterBook** value. The maximum possible damage is either double the STR+bonus or the the bonus of the weapon plus 14, *whichever is lower*. Weapons with energy enhancement (shock batons, etc.) have a maximum possible damage 1 or 2 points higher. The damages on the table below assume the weapons in question have a +1 Inherent Accuracy.

<b>3G<sup>3</sup> DV</b>	<b>MasterBook</b>	<b>Sample</b>
6	STR+3	
7-9	STR+4	Dagger
10-12	STR+5	Main-gauche
13-15	STR+6	Short sword
16-19	STR+7	Broadsword
20-23	STR+8	Bastard sword

**Example** - A broadsword has a **3G<sup>3</sup>** Damage Value of 14 for cutting attacks and 12 for thrusting attacks, and an IA of +1. This gives it a **MasterBook** Damage Value of +7 for cuts and +5 for puncturing attacks. The different attack types will only make a difference if the GM chooses to have them do different special game effects.

The Toughness of a melee weapon is based on the average AV from the **3G<sup>3</sup>** design.

# HERO SYSTEM<sup>®</sup>

## Basics

The **Hero System** is a multi-genre rpg system that was originally marketed as a superhero game. Since then, it has been expanded to cover virtually every role-playing genre. It also has its own guidelines for creating equipment and weapons, and those guidelines mesh more closely with the point-based nature of the game than does this real-world oriented **3G<sup>3</sup>** conversion. The weapon list is suitable as is for inclusion in any **Hero System** campaign. These conversion notes should work for converting any **3G<sup>3</sup>** or real-world weapon into **Hero System** terms, and may also be useful because of the list of **Hero System** advantages and limitations expressly covering firearms of all TL's. The notes are updated from 1st printing **3G<sup>3</sup>** because the **Dark Champions™** supplement provided more material to work from.

## Name

This is the common name of the weapon, followed by its caliber. Scavenged weapons of the same caliber are a source of charges to replace those in a character's weapon.

## OCV

Subtract one from the IA of the weapon. This is the inherent OCV bonus or penalty of that weapon, and affects the chance to hit at all ranges.

**Example** - A pistol with an IA of +1 has an OCV of +0.

## RMod

This is the ability of the weapon to sight better at long ranges. Each point of aiming RC is a point of RMod in the **Hero System**.

**Example** - A weapon with aiming RC3 has an RMod of +3.

## Damage

The following **Hero System** damages were counted as having the following amounts of active points. Note that some of these damages are non-standard, but give the best fit for a certain average damage, even if the maximum damage possible is lower. DV's round down to closest pip.

Average **Hero System** damage =  $(8.37 \times \log DV) - 6.5$

3G <sup>3</sup> DV	Hero Sys.	Points	3G <sup>3</sup> DV	Hero Sys.	Points
6-10	1 pip(DC1)	5	36-40	1d6+3	28
11	1/2d6(DC2)	10	41-53	2d6(DC6)	30
12-13	1d6-1(DC2)	12	54-70	2d6+1(DC7)	35
14-15	1/2d6+1	13	71-81	2 1/2d6(DC8)	40
16-20	1d6(DC3)	15	82-93	3d6-1(DC8)	42
21-26	1d6+1(DC4)	20	94-107	2d6+3	43
27-31	1 1/2d6(DC5)	25	108-140	3d6(DC9)	45
32-35	2d6-1(DC5)	27	141-185	3d6+1(DC10)	50

Damage shown on these conversions is assumed to be killing damage unless otherwise specified. A physical normal attack will have a "P" after it, like "5d6P". An energy normal attack will have an "E". Otherwise, normal Hero System suffixes apply, like "X" for explosion (or KX for killing explosion), NND for No Normal Defense attacks, and AP for Armor Piercing attacks.

It is important to note that Armor Piercing is a relative term. A **Fantasy Hero** campaign might consider crossbow bolts to be Armor Piercing, but if that weapon were transferred to a high-tech setting, it would likely not apply except in special cases. Likewise, a modern armor-piercing bullet might be double Armor Piercing against low-tech armors.

## Micro damage

Some weapons convert to a DV of less than 1 pip of killing damage (less than 5 points). These will be listed as (1 pip), and normally roll 1d6, doing 1 killing BODY on a roll of 6, 1 killing STUN on a roll of 2-5, and no damage at all on a roll of 1. Yes, they are largely ineffective weapons, but against unarmored people, they are the equivalent of an NND, and an autofire or area effect attack of this type can be annoying. As crowd dispersal weapons, they may force the average bystander to make an EGO roll, and it will add dice to Presence attacks against anyone affected by it.

## Shots

This is the number of charges the weapon has. Weapons with clips often have a +1 after the number, showing that there can be an extra round in the chamber, in addition to the normal amount in the clip. For figuring a weapon cost in points, do not take this +1 into account.

Weapons powered by an external source have an infinite number of charges, but are tied to that power source. Most often, they can be bought as an END Reserve, with a high REC based on being "plugged in".

## STR Min

This is the minimum STR needed to accurately fire the weapon, and is based on the (Base cost/3), round nearest. If the weapon is used in both hands, subtract 5 from the result.

## Modifiers

The "base cost" of a given attack for purposes of STR Min is adjusted by the following:

+5	Each point of OCV
+3	Each point of RMod

**Example** - A 1d6RKA with an OCV of +1 and an RMod of +2 would have a base cost of  $15 + 5 + 6 = 26$  points. Lowered OCV and RMod would *reduce* the base cost of the weapon.

## Bracing

For the **3G<sup>3</sup>** weapons which are man-portable, but have an aiming RC of 5, the STR min is that for shoulder-fired use. Drop this by 5 if the weapon is braced or using a bipod. A one-handed ranged weapon with a folding or detachable stock gets a +1 RMod, -1 Initiative when used with the stock.

## Cost

This converts directly from the **3G<sup>3</sup>** amount.

## Loaded mass (optional)

This is simply the mass of the weapon in kilograms, and may be used in campaigns where the mass a character carries will make a difference for Long Term Endurance loss or DCV purposes.

## Clip mass (optional)

As for loaded mass.

# Hero System

## Hands (optional)

For use in campaigns where it is necessary to know how a character wields a weapon, such as needing both hands for a rifle, or whether or not a character can use a shield and a melee weapon at the same time.

## DEF (optional)

The DEF of a weapon can be calculated from the AV, and used instead of the DEF generated by the Active Points in the weapon. Instead of basing DEF and BODY directly on the AV of the weapon, base them on *double* the AV and BP, and put this number in the DV conversion equation. See below:

AV or BP	DEF or BODY	AV or BP	DEF or BODY
1	0	8-10	4
2-4	1	11-13	5
5	2	14-17	6
6-7	3	18-23	7

This is for a strictly **3G<sup>3</sup>** conversion. To be perfectly compatible with **Hero** guidelines, base DEF and BODY on the active points, as per the rules.

The DEF of a weapon applies vs. killing attacks attempting to damage the weapon. Against normal attacks or blocks or the damage done by the weapon itself, this number is doubled.

**Example** - A pistol with an AV of 9 has a DEF of 4. Against being shot or sliced, it has a DEF of 4. Against being bent, clubbed, or damaged by a normal explosion, it has a DEF of 8.

## BODY (optional)

As for DEF. Items that have lost part of their BODY have a chance of malfunction as per **Hero System** rules.

## PER Mod

The PER Mod of a weapon is a characteristic that applies as a bonus to spot it if concealed on your person or elsewhere.

Bulk	Base	per 2x locs.
VS weapon	0	+1
S weapon	1	+1
M weapon	3	+1
Has ≥.60kg per location (not doubled) or		+1
Has ≥2.50kg per location (not doubled)		+3
Longarm (shoulder fired, non-bullpup)(not doubled)		+2

The "per 2x locs." means that the PER Mod goes up by that extra amount at 2 locations, 4 locations, 8 locations, and so on, rounding up. There is no maximum size for objects, although anything Large or more is not concealable, and objects with a PER Mod of more than +10 are going to be so unwieldy that they are difficult to carry, let alone conceal.

**Example** - An S/4 shoulder-fired carbine has a PER Mod of 1 for a Small weapon, +3 for extra locations and +2 for shoulder-fired, for a total PER Mod of +6.

## Initiative (optional)

**Hero System** weapons do not have Initiative. As an optional trait, halve the **3G<sup>3</sup>** Initiative (round towards zero), and add or subtract this from the DEX (or Fast Draw skill) of the user when sequencing a combat (for attack purposes only).

## Tech Level (optional)

There are no Tech Levels as such in the **Hero System**, so you will have to decide on chronological guidelines and historical developments to figure out what TL a weapon is, or what TL a character can design a weapon for. Obviously, superheroes who are alien scientists will be much less limited than fantasy characters, with pirates, pulp heroes or modern secret agents somewhere in between. In general:

Genre	3G <sup>3</sup> Tech Level
Medieval fantasy	4-5
Swashbucklers	6-7
Old West	8
Pulp heroes	8-9
Modern adventurers	10-12
Future settings	13+

While the **Hero System** does not use TL's, weapons of one **3G<sup>3</sup>** TL, whose damage would be increased in a higher TL version, will have their damage increased by one increment if used in a more modern setting, an increment being based on the previous table.

**Example** - A Walther PPK might have a damage of 1/2d6 (at **3G<sup>3</sup>** TL9). This is suitable for a pulp adventure. If used in a modern setting, the damage would go to 1d6-1.

If a weapon from an older TL is used with high-tech ammo to get extra damage, it gets a burnout roll *and* side effect. If it had none, it is a 15-. If the weapon already had one, the burnout roll is 2 classes lower than it was before (a 15- going to 13-, for instance). The side effect is a KX of 1d6+1 or 2 1/2d6, depending on whether the active points of the weapon are more or less than 30 points (30 or 60 point side effect).

**Point Cost**

For figuring out a point cost to characters, base it on the following guidelines. Factor in cost of any extra clips if necessary.

**Pistols**

Advantages	Amount
None	+0

Limitations	Amount
OAF	-1
Independent	-2
STR Min (Base/3)	-3/4
Can't add damage with STR	-1/2
One-handed weapon	-0

**Rifles**

Advantages	Amount
-5 STR Min	+1/2

Limitations	Amount
OAF	-1
Independent	-2
STR Min (base/3)	-3/4
Can't add damage with STR	-1/2
Two-handed weapon	-1/2

**Shotguns (as rifle or pistol)**

Limitations	Amount
Reduced penetration (buckshot and flechettes only)	-1/4
Reduced by range (buckshot only)	-1/4

**Autofire weapons (any)**

Advantages	Amount
One level of autofire (3-7 shots)	+1/2
Two levels of autofire (8-15 shots)	+3/4
Three levels of autofire (16-30 shots)	+1
Four levels of autofire (31-60 shots)	+1 1/4

Note that a weapon with 3 or more levels of autofire might instead be bought as an area effect to represent the saturation effect of that many bullets.

**Area Effect weapons (any)**

Advantages	Amount
One hex	+1/2
Line effect (active points/5)	+1
Cone (active points/5)	+1
Radius (active points/10)	+1
Explosion	+1/2

**Mounted weapons**

Limitations	Amount
OAF	-1
Independent	-2
Two-handed weapon	-1/2
Immobile	-1

**Bulky weapons (>10 kilograms)**

Advantages	Amount
-5 STR Min or	+1/2
-10 STR Min	+1

Limitations	Amount
OAF	-1
Independent	-2
Two-handed weapon	-1/2
Bulky	-1/2

**Weapons at Level III-IV rel. (or percussion)**

Limitations	Amount
15- Activation roll	-1/4

**Weapons at Level V-VI rel. (or flintlock/matchlock)**

Limitations	Amount
14- Activation roll	-1/2

**Matchlocks (any)**

Limitations	Amount
Doesn't work in extreme damp	-1/2
Lit match requires tending	-1/2
Reloading takes 1 minute with gestures throughout*	-2

**Flintlocks (any)**

Limitations	Amount
Doesn't work in extreme damp	-1/2
Reloading takes 1 minute with gestures throughout*	-2

**Percussion (any)**

Limitations	Amount
Doesn't work underwater	-1/2
Reloading takes 1 minute with gestures throughout*	-2

\*Note that technically you don't lose much preparation time if interrupted while reloading, which is offset by the ammunition (open powder) being Fragile during the reloading process.

**Weapons with HE or HEAT warheads (any)**

Advantages	Amount
-5 STR Min or	+1/2
-10 STR Min or	+1
No STR Min (if weapon normally has -10 STR Min)	+0
Armor Piercing	+1/2
Explosion (optional)	+1/2

**Silenced weapons (any)**

Advantages	Amount
Invisible Power Effects (one level)	+1/2

**Lasers (any)**

Advantages	Amount
Armor Piercing	+1/2
No STR Min	+0

Limitations	Amount
Will not penetrate some Darkness	-1/4
No knockback	-1/4

**Continuous beam lasers (any)**

Advantages	Amount
Armor Piercing	+1/2
Continuous effect	+1
Line area effect	+1
No STR Min	+0

Limitations	Amount
Will not penetrate some Darkness	-1/4
No knockback	-1/4

**Particle beams (any)**

Advantages	Amount
Penetrating	+1/2
No STR Min	+0

**Limitations**

Limitations	Amount
Doesn't work underwater	-1/4
Limited effect vs. magnetic shielding	-1/4
No knockback	-1/4

**Railguns (any)**

Advantages	Amount
Armor Piercing	+1/2

Limitations	Amount
Doesn't work underwater	-1/4

**Electricity based stunners (any)**

Advantages	Amount
NND (defense is resistant ED>1)	+1

Limitations	Amount
Reduced by range	-1/4
Doesn't work underwater	-1/4

**Homing weapons (any)**

Advantages	Amount
Programmable target computer (variable limitation)	+1/2
Takes no range penalty	+1/2

Limitations	Amount
Only vs. single object (specific person, vehicle, radar signature, etc.)	-2
Only vs. single category (people, land vehicles, heat sources, etc.)	-1
Only vs. broad category (moving targets, any large metal mass, etc.)	-1/2

**Charges (as per Hero System)**

Charges	Amount	Charges	Amount
1	-2	9-12	-1/4
2	-1 1/2	13-16	+0
3	-1 1/4	17-32	+1/4
4	-1	33-64	+1/2
5-6	-3/4	65-125	+3/4
7-8	-1/2	126-250	+1

**More limitations**

Limitations	Amount
Laser designator (treat as "only vs. single object", but with a full phase of extra time and gestures)	-3/4
Radar designator with target discrim. (treat as "single category", but with a full phase of extra time and gestures (radar dish))	-3/4
Radar designator (treat as "broad category", but with a full phase of extra time and gestures (radar dish))	-3/4
Minimum arming range (active pts/5)	-1/4
Human guided (full phase of extra time and gestures)	-3/4
Man-portable, needs initial setup (1 turn extra time)	-1/2
Man-portable, needs setup per shot (1 turn extra time)	-1
Disposable wpn. (expendable focus)	-1/4

# Hero System

## Guidance systems

For weapons which have homing ability, they may either be bought as a simple bonus to hit, or treated as computer controlled vehicles. Sensor-equipped weapons get a +2OCV per 25% bonus, with 15% increments being a +1OCV. This may or may not require setting for a phase to get the bonus. The best of both worlds is to count a homing weapon or sensor-equipped weapon as a bonus to hit at ranges where it will hit in the same segment it is fired, and as computer controlled otherwise. The stats for a self-controlled weapon like a missile or point defense platform include the bonus to hit because of the guidance system in the OCV stat of the weapon. This applies if a character is in control of the weapon and is making firing decisions. Otherwise, the OCV number in parenthesis is used to represent the OCV of the targeting computer acting alone.

A simple, minimum cost tracking computer is:

Item	Cost
INT 5 (can run 1 program)	-5 points
DEX 0 (has no inherent ability)	-30 points
SPD 4 (Acts faster than most humans)	+30 points
Attack and destroy target at closest approach	1 point
Familiarity with weapon system	1 point
+1 OCV with self	3 points
Total cost	0 points

This can be used for any weapon with an inherent OCV, +/-3 points for each level of OCV over the base.

**Example** - A self-guided missile with an OCV of 4 would have a computer cost of 9 points, in addition to the cost of the weapon itself. This is added to the cost of the weapon after other factors are taken into account. For instance, without the computer, the weapon would still get the OCV bonus when a person was using it, but it would have no initiative to act on its own.

There is no good **Hero System** limitation for flight time to a random range. The "1 second" range of a "slow" weapon should be listed. The weapon will move this far each segment, and of course "hold action" so that it gets its targeting and movement decision at the best time (usually at the closest approach). Most weapons will reach their target in 1 phase.

## Shotguns

These are given point costs as per the previous guidelines, but the **3G<sup>3</sup>** damage is figured as follows. The base damage is that for one pellet, and is increased by half each time the pellet quantity is doubled (keep fractions until you reach the final total). Pellet quantity is rounded nearest for this calculation.

Pellets	Multiple	Pellets	Multiple
1	x1.0	12-23	x3.0
2	x1.5	24-47	x3.5
3-5	x2.0	48-95	x4.0
6-11	x2.5	96-191	x4.5

Any weapon with multiple projectiles automatically gets the Reduced Pen. limitation. If a weapon has a x4.0 multiple or more, it gets an *additional* level of reduced penetration as well.

**Example** - A shotgun firing 15 buckshot pellets with a DV of 13 each will have a base damage of 2.82 points in **Hero System** damage. The quantity of pellets is a x3.0 multiple, so the weapon does 8.47 points of damage, or an average of 2d6+1 (almost 2 1/2d6), with one level of Reduced Penetration. If it were firing 100 pellets of birdshot, each with a DV of 9, the base damage would be 1.49, with a x4.5 multiple for quantity, for a total damage of 7.43, or 2d6, with two levels of Reduced Penetration.

## Grenades

The simplest way to buy grenades is as a Killing Explosion (KX). **3G<sup>3</sup>** uses a variant on fragmentation from a previous edition of the **Hero System**. Grenades are bought as a 6 shot autofire attack with OCV levels based on the number of fragments hitting a 1m<sup>2</sup> target (twice an average person's area) at a range of 1" (2 meters), rounding hits down. This OCV is always vs. DCV of 0, plus any bonus to DCV for size and partial cover. The roll is made for the number of hits, and each hit does the listed damage. The OCV of the fragments drops by 2 at a range of 1", 2", 4", 8", etc. Any linked explosion is treated normally.

Fragments	Hits at 1"	OCV	Example
<100	1 or less	0	WWII grenade
100-199	2-3	2	"Bouncing Betty" mine
200-399	4-7	4	
400-799	8-15	6	Small modern grenade
800-1599	16-31	8	Modern grenade
1600-3199	32-63	10	
>3200	64+	12	Claymore mine

Powers with a 60° cone effect multiply their actual fragments by 6 to get the number the OCV is based on.

**Example** - A directional mine has 500 fragments. This is multiplied by 6 to get 3000, which corresponds to an OCV of 10. At a range of 15 hexes, the OCV will have dropped to 2, since it lost 2 points of OCV at 1", 2", 4" and 8".

Obviously, this is much more cumbersome than a normal KX, but is more accurate for a heroic campaign. For a superheroic campaign, the easiest thing to do is double the fragment damage and call it a Reduced Penetration KX.

## Grenades (any)

Advantages	Amount
Triggered (when pin is pulled)	+1/4

Limitations	Amount
One phase activation delay	-1/2
Expendable focus	-1/4

## Explosions

Explosions are treated normally, but their damage is multiplied by 3 to get a **Hero System** damage for normal dice instead of killing dice.

## STUN modifiers

Most weapons are bought as having a +0 STUN modifier. There is no easy way to tell if a weapon should have a +1 or -1 STUN modifier. Within the system, weapons often use this to represent increased "knockdown" power. Also, projectiles that do more or less tissue damage, like AP or hollow-point may have a non-zero STUN modifier.



### Continuous beams

Very high ROF weapons may be bought as Area Effect. Such attacks (line area) are also bought with the advantage Continuous, so that anyone passing through the area of effect until the character's next action is automatically hit. Many of these area attacks aren't that large, but remember that any fragile foci carried will also be affected by the attack (extra ammo, carried grenades, etc.). The special effect of the area effect is that a larger target may shield a smaller one. So, a person with a shield would get the DEF of the shield if the hit location protected by the shield was rolled. Or, a large character could interpose themselves to protect a smaller one, or stray cover might protect a character who was there when the attack occurred.

### Uncontrolled attacks

A few attacks last longer than a phase. These are usually bought as continuous, uncontrolled, lasting 1 turn.

### Special ammunition

If a weapon uses special ammunition of some type, use the special effects for that ammunition according to **Hero System** rules.

### Multipowers

If a given weapon has several variants or types of ammo listed, it is assumed to be bought as a multipower on the most expensive type, with the limitation "Takes a full action to change slots" (change the clip). If a weapon has multiple versions, the costs for the military and civilian versions will be different.

### Overlap

Some weapons you will create may overlap with ones already created and listed in the **Hero System** rules. Points of difference you will note is that **3G<sup>3</sup>** weapons tend to have *slightly* lower damages. Adjust the damage class of all weapons to match the power level of your campaign, either by a fixed addition to **Hero System** damage (e.g. +1DC to all designed weapons) or to **3G<sup>3</sup>** damage (e.g. +10 DV before converting to **Hero System** damage). Also, **3G<sup>3</sup>** weapons usually have *significantly* better accuracies, so that an average person with a slight amount of training can actually hit targets at plausible ranges. For instance, the conversions assume that a DEX 11 soldier with weapon familiarity and a rifle can hit a DCV 2 target (a surprised average person) at 100 meters after setting and bracing over 75% of the time. They also assume it is harder to do with a pistol than with a rifle, so **3G<sup>3</sup>** conversions will have a better RMod stat than rifle-class **Hero System** weapons.

### Special cases

Some weapons may have endurance batteries instead of charges, or solar panels which are limits on the recovery of END in the weapon, or a number of other special cases. This is usually only listed for weapons which have multiple powers. Others have charges which can be renewed at a high-energy power source. We have tried to take into account any power modifier that is implied in the description of a weapon.

#### END Reserve (any)

Limitations (END)	Amount
OAF	-1
Independent	-2
Linked to other power (weapon)	-1/2
Can't be pushed	-1/2

#### Limitations (REC)

Limitations (REC)	Amount
OAF	-1
Independent	-2
Linked to other power (weapon)	-1/2
Requires high energy source or	-1/2
Only works in daylight (solar panel, REC 1 only)	-1/2

Since charges or END can be transferred between weapons if needed (energy is energy, after all), you can do this with some equipment and a skill roll, but for each 5 points of difference in active cost per shot, you lose half the charges or END in the transfer (rounding in character's favor).

**Example** - A player with an extra energy clip for their laser pistol (1d6+1RKA, Armor Piercing, 30 Active points, 3 END per shot), loans it to a friend whose laser rifle (2d6RKA, Armor Piercing, 45 active points, 4 END per shot) is empty. There are 30 END in the clip, and 20 active points of difference. Only 1/8th of the charges transfer (lose half per 5 points), so draining the entire pistol clip only nets the character one shot (4 END) for the rifle. The reverse also applies, so if the rifle character gave 1 END to the one with the pistol, one charge for the rifle would give the pistol 8 END (double per 5 points). Note that this is highly optional, and is just presented as an alternate way to do things.

### Multiple powers

In some cases, a weapon description may imply that the **Hero System** version has multiple power effects. For instance, a stun grenade may say that it has an effect on the senses equal to its blast damage. In this case, the weapon acts as a Flash as well as an explosion, and you would convert the DV to the appropriate amount of Flash, taking into account that 1d6 of RKA in **Hero System** is 15 points, while 1d6 of other attacks may be more or less.

### Bulky weapons

Weapons that mass more than 10kg and are man-portable are generally considered Bulky, and get the -1/2 limitation. Weapons that are usually mounted get the Immobile limitation of -1. These can be vehicle mounted, but are very cumbersome to move when detached, and cannot be fired when dismounted. In some circumstances, very powerful characters can use the focus without limitation (powered armor, for instance).

# Hero System

## Melee weapons

All melee weapons are bought as “real weapons”, meaning that anyone can use them, they have mass to slow a character down, can be damaged, and so on.

## OCV

The **Hero System** OCV of a melee weapon equals the IA for swords and staves, and the IA-1 for axes/maces, IA-2 for polearms, IA-1 for flails, IA-1 for whips and flexible weapons, IA-1 for improvised weapons, and RMod=IA-1 for thrown weapons.

Weapon type	OCV	Weapon type	OCV
Swords	IA	Maces	IA-1
Staves	IA	Polearms	IA-2
Knives	IA	Flails	IA-1
Axes	IA-1	Whips	IA-1
Improvised weapons	IA-1		

## Damage

The best way to convert damage is to use the formula for ranged weapons, but use the DV+5 instead of the straight DV. For a massively heroic campaign, use DV+10 instead of DV. How much you add depends on how “heroic” the campaign is.

Most weapons here will do slightly less damage than their **Hero System** counterparts, but they also have lower STR Mins. The net effect is that for the same STR, the weapons are slightly less powerful (matching the guns), and also have a lower maximum damage, but don't cost as much END.

The reduced damage maximum makes it harder to carve holes in tanks or reinforced concrete walls with a greatsword. Using “real” weapons also implies you use “real” armor, which cuts the amount of armor worn. To keep things even, the amount of force fields that wizards can have needs to be kept in check, something you should do in any case.

If a weapon has an effect that adds to normal damage rather than being the main agent of damage, it is bought as extra HTH dice. If the effect is that it adds separate killing damage to normal damage, the extra HTH dice are converted to lethal damage, which cannot be affected by STR.

## STUN x

Most weapons have a default STUNx of +0. Weapons that do impaling damage only should get a -1 STUNx. Those that have small crushing surfaces or can be accelerated by virtue of a flexible hilt (war hammers and flails, respectively) should get a +1 STUNx.

## STR Min

This is based on the (active points/2), and takes into account OCV, RMod, Throwable, and +1 STUNx, but not Zero END.

## Cost

Taken directly from the **3G**<sup>3</sup> cost for the weapon. In addition, the character point cost can be listed, according the guidelines here.

## Melee Weapons (one-handed)

Advantages	Amount
Zero END cost	+1/2

Limitations	Amount
OAF	-1
Independent	-2
STR Min (active points/2)	-1

## Melee Weapons (two-handed)

Advantages	Amount
STR Min-5 (tools don't get this)	+1/2
Zero END cost	+1/2

Limitations	Amount
OAF	-1
Independent	-2
STR Min (active points/2)	-1
Two-handed weapon	-1/2

## Melee Weapons (throwable)

Advantages	Amount
Throwable (RMod is OCV+0)	+1/2

## Other

Advantages	Amount
Armor Piercing (unbalanced impaling weapons)	+1/2
+1 STUNx (unbalanced crushing weapons)	+1/2

Limitations	Amount
-1 STUNx (weapons doing impaling damage only)	-1/4

## Cost adjustments

Modifier	Cost
+1 OCV	5 points
-1 OCV	-5 points
Linked 2d6 Entangle (recoverable, transparent)	7 points
Linked 1" Stretching (in combat, grab, disarm)	2 points

## Hands

The number of hands needed to use the weapon properly.

## DEF (optional)

The DEF is converted as for other weapons, and serves the same purpose. It is based on 2 x AV, as for ranged weapons.

The DEF of a weapon applies vs. killing attacks attempting to damage the weapon. Against normal attacks, blocks or the damage done by the weapon itself, this number is doubled.

**Example** - A DEF 2 knife has a DEF of 2 if shot, or someone tries to break it with a killing attack. If hit by an explosion, or someone tries to snap it with their hands, it has a DEF of 4.

## BODY(optional)

The BODY is converted as for other weapons, and serves the same purpose. It is based on 2 x BP, as for ranged weapons.

## PER Mod

As for other weapons. Most melee weapons longer than 3 locations double the calculated PER Mod.

## Initiative (optional)

Figured as for other weapons, and serves the same purpose.

# TRAVELLER®

*The New Era*

## Basics

**Traveller: The New Era** (referred to hereafter as **TNE**) is a science-fiction role-playing game set in the distant future of a shattered Imperium. Characters can travel between worlds, and visit areas ranging from highly advanced to strikingly primitive, with a correspondingly wide variation in weapons available. This conversion is mainly for small arms and other man-portable weapons, and should be suitable for any **3G<sup>3</sup>** or real-world weapons in either **TNE** or any compatible system. While **TNE** is no longer in print due to the demise of Game Designer's Workshop, a great deal of material is still available for the system, so BTRC has decided to continue **3G<sup>3</sup>** support, at least for this printing of the **3G<sup>3</sup>** rules. You can also use these rules to help you convert **TNE** weapons to **Traveller 4th ed.** rules.

**Important note** - The **TNE** system is a refinement and expansion of the **Twilight: 2000** role-playing rules. Previous printings of **3G<sup>3</sup>** and the **More Guns!** supplement used this more limited set of rules for conversions. There also exists a weapon and equipment design supplement exclusively for **TNE**, called **Fire, Fusion and Steel**, which if you can find it should have weapon and accessory notes you should use for the **TNE** system. The numbers you get from **3G<sup>3</sup>** should be almost the same as **Fire, Fusion and Steel** numbers for small arms, we just use different ways of getting to them.

## Name

This is the common name of the weapon, and is followed by the caliber, for purposes of reference and ammunition exchange between weapons.

## Tech Level

This is the Tech Level of the weapon, and is based on the following scale:

3G <sup>3</sup> TL	TNE TL	Earth equiv.	Example
4	0	Dark ages-	
5	1	Middle ages	Hand cannon
6	2	c.1600	Flintlock pistol
7	3	c.1800	Percussion rifle
8	4	c.1900	Cartridge rifle
9	5	c.1930	Medium machinegun-5
10	6	c.1950	Light machinegun-6
11	7	c.1970	5.5mm Gatling gun-7
12	8	c.1990	Caseless ammo, laser carbine-8
12	9	Fusion era+	Laser rifle-9
13	10		
14	12		
15	13		PGMP-13
<b>Extrapolated</b>			
16	14		PGMP-14
17	15		PGMP-15

This is the same as in **Traveller 4th ed.**, and lets you design weapons for any game using the **TNE** or compatible systems.

## ROF

This is based on the weapon type, as follows:

Weapon type	ROF	Shots per fire action
Semi-auto	SA	up to 5
Single shot	SS	1 per barrel
Single action revolver	SAR	up to 2
Double action revolver	DAR	up to 3
Pump action	PA	up to 3
Bolt action/Lever action	BA/LA	1
Autofire weapons	(actual rate of fire/2)	up to ROF
Continuous beam	10, but each one is 2 hits	up to ROF

The rate of fire for automatic weapons rounds up if there are fractional amounts. For multiple barrel weapons, the number of bursts is divided by the number of barrels.

**Example** - A machine pistol firing 11 shots per second has a **TNE** ROF of 6. A tri-barrel gatling firing 30 shots per second has a **TNE** ROF of 5 (15, divided by 3 barrels).

## Damage

The DV of a **3G<sup>3</sup>** weapon will convert to a Damage stat in **TNE**. The best conversion equation for most small arms seems to be:

$$\text{TNE Damage} = (DV/10)^{.86}(n)$$

Damages rounding to zero are counted in **TNE** as -1 (1d6-1d6).

Damage Value	TNE Damage
1-4	0
5-16	1
17-28	2
29-42	3
43-57	4
58-72	5
73-88	6
89-104	7
105-120	8
121-137	9
138-153	10
154-171	11
172-189	12
190-218	13
219-276	14
277-340	15

For delivered energy that gives a DV higher than 200, an additional factor needs to go into the DV-to-Damage equation. For these weapons:

$$\text{TNE Damage} = (DV/10)^{.86} - (DV-200)/26.6 (n)$$

This gives better results out to a DV of around 3500 with some accuracy. The table above and elsewhere in the rules uses the extra term for figuring **TNE** damage.

**Note** - This system is *not* suitable for starship-type weapons with DV's that exceed 3500. On the off-chance you need to convert a weapon with a DV of more than 3500, use a Damage of 30 for a DV of 3500, and add 10% of the Damage of the remainder. Results are not guaranteed.

# Traveller: New Era

## Damage (optional)

**TNE** Damage is actually based on roughly the same factors as **3G<sup>3</sup>** Damage Value, but does not take projectile size into account. **3G<sup>3</sup>** uses the above formula exclusively, but to conform perfectly with **TNE** numbers, multiply the DV by the following before converting to the Damage stat.

Projectile is	Multiply by:	Typical for:
2mm	x.45	
2.5mm	x.50	
3mm	x.55	
3.5mm	x.59	
4mm	x.63	
4.5mm	x.67	
5mm	x.71	
5.5mm	x.74	5.56mm rifles
6mm	x.77	
6.5mm	x.81	
7mm	x.84	
7.5mm	x.87	7.62mm rifles
8mm	x.89	
8.5mm	x.92	
9mm	x.95	9mm pistols
9.5mm	x.97	
10mm	x1.00	
10.5mm	x1.03	.40S&W pistols
11mm	x1.05	
11.5mm	x1.07	.45ACP pistols
12mm	x1.10	
12.5mm	x1.12	12.7mm MG
13mm	x1.14	
14mm	x1.18	
15mm	x1.22	14.5mm-15.5mm MG
17mm	x1.30	
20mm	x1.41	20mm cannon
23mm	x1.52	
25mm	x1.58	
27mm	x1.64	
30mm	x1.73	30mm cannon

This is only likely to make a difference for rounds close to a breakpoint, or for very large rounds. The major difference this makes is that some rifles firing the 7.62mm round will go from a Damage of 5 to 4, some .45ACP pistols will go from a 1 to 2, and most heavy machine guns will go up by 1 point. Also, small-bore air rifles with a Damage of 1 will likely go to Damage of 0. In any of these events, you may have to alter the **TNE** recoil numbers.

## TL differences

If a weapon that was manufactured at multiple TL's gets a higher damage due to a more modern version of the weapon or ammunition, you should mark the name with a "°". This also applies to high-tech weapons available over a range of **3G<sup>3</sup>** Tech Levels. Note that older weapons using +P or +P+ ammunition are likely to have the same effect (increased damage), but the two are *not* cumulative. Note that this *does* increase recoil.

This also applies to weapons using hollow-point or other ammunition that increases tissue disruption, but in this case, the Pen of the weapon will be increased by 2 points. In this case, they will be marked with a "+". This will only apply to a weapon *within* its TL of manufacture, and is based on the **3G<sup>3</sup>** DV x 1.25 (round nearest), as for hollow-point rounds.

**Example** - The S&W Model 29 has a **3G<sup>3</sup>** DV of 26, which is a Damage of 2°. The "°" means the weapon was introduced well before the end of its TL, and high-power or late-TL ammunition is powerful enough to give a Damage of 3, at some reduction in weapon life and reliability. The Pen of the weapon is unaffected.

**Example** - The Desert Eagle in .357 Mag has a **3G<sup>3</sup>** DV of 24, which is a Damage of 2+. This means that with hollow-point or other increased tissue disruption rounds, the Damage will go to 3, but the Pen is increased by 2 (in this case, it stays at "nil").

Note that a weapon with a "°" is usually assumed to be "+" at its native Tech Level. So, for instance, the S&W Model 29 has a Damage of 2°, while the Desert Eagle has a 2+. The Desert Eagle does not get an increased Damage from +P ammunition, but the S&W Model 29 does, and *both* get increased damage from regular hollow-point or other rounds with increased tissue disruption (with penalty to Penetration).

## Penetration

In addition to the Damage stat, **TNE** weapons also have a Pen number, which is how affected they are by armor. The base Pen number for a slugthrower round is 1 if it is less than 7mm in diameter and 2 if it is 7mm or more. However, the maximum Pen is the Damage-1, and weapons with a Damage of 1 therefore have a Pen of "nil", as do weapons whose Pen and Damage are equal (2/2 being the same as 2/nil, for instance). Weapons have their Pen increased by 1 for each range increment past Medium (i.e. at Long and Extreme). If the damage RC of the weapon is greater than the aiming RC, the Pen is increased only at Long and Extreme ranges.

Laser weapons generally have a Pen of 7 less than their Damage. Fusion weapons generally have a Pen of 1/2-1-4, while plasma weapons have a Pen of 1-2-10. Against vehicles fusion weapons are 3-(half Damage)-(Damage), while plasma weapons have a Pen of 1-(half Damage)-(Damage).

**Note - Fire, Fusion and Steel** gives Pen numbers based on muzzle energy in Joules, as per the table below:

CPR guns	Pen	Gauss weapons	Pen
0-600J	nil	0-1000J	nil
601-2000J	1-nil	1001-3000J	1-nil
2001-3000J	2-nil	3001-5000J	1-2-nil
3001-5000J	2-3-nil	5001-10kJ	1-3-5
5001-10kJ	2-4-6	10kJ-20kJ	1-2-4

**Note** - Penetration numbers for fusion and plasma weapons have changed since the first printing of the conversion notes in **3G<sup>3</sup>** and **More Guns!**.

## Reload

Most modern weapons will have a "-" here, showing that they can be fully reloaded in a single turn. Archaic weapons, especially muzzle loaders, will take longer.

Weapon type	Reload time
Muzzle loader	3 per barrel or shot
Muzzle loading rifle	+1 turn
Breech loading weapon	-1 turn
Internal magazine	3 bullets per turn
Using stripper clip	10 bullets per turn

## Bulk

Initiative is based directly on weapon bulk directly, rather than indirectly through the Initiative stat. The number of locations a weapon has translates into the Bulk stat, as follows (weapons with bulky magazines may have +1 Bulk):

Weapon locs.	Bulk	Weapon locs.	Bulk
1	0	6	4
2	1	7	5
3	2	8	6
4-5	3	9	7

**Note - Fire, Fusion and Steel** lists bulk as weapon length in cm/15, rounding down, while **3G<sup>3</sup>** uses the same figure, but rounds up. However, **FFS** does not apply modifiers for weapon mass or bulky magazines.

## Magazine

This is the number of shots the weapon holds, and the means of storing them in the weapon.

<b>Box</b>	A detachable box-like clip, like that found on most semi-auto pistols and assault rifles.
<b>Drum</b>	Similar to a box magazine, but is usually bulkier and holds more rounds. Also be used for platter-type magazines.
<b>R</b>	Revolver. Usually a non-detachable cylinder. Generally holds from 5 (large bore pistol) to 9 (.22LR) shots, with 6 shots being the most common number. Speed loaders (the revolver equivalent of a stripper clip) allow fast reloading.
<b>i</b>	Internal magazine. The weapon holds all the ammunition in a non-removable internal tube or clip. Stripper clips allow fast feeding of ammunition into one of these, otherwise only 3 bullets per turn may be loaded.
<b>B</b>	Belted ammunition. Ammunition is held in a linked belt, which usually feeds from an open box. Usually takes 2 turns to reload. Belts may be linked for greater capacity.
<b>C</b>	Cassette. Ammunition is similar to belted types, but comes prepackaged in a certain length, and a new cassette may be fitted to a weapon in 1 turn. Reloading a cassette or belt is time consuming, and not possible in combat.
<b>PP</b>	Power pack. Ammunition is similar to a cassette, and is an external energy supply that is either carried or mounted separately from the weapon. Applies only to energy weapons or gauss weapons with separate power supplies.

## Recoil

This is the number used for calculating consecutive shot or burst penalties, and is based on the Damage of the weapon.

Attack	Base recoil
Single shot	Damage+1
Burst	(Damage+1) x 2

Modifiers to Damage	Amount
Weapon has $\geq$ .75kg per location	-1
Fired from bipod	-2
Fired from tripod	-3
Fired from pintle mount	-4
Fired from vehicle mount	no recoil
Fires $\geq$ 20 shots per second	+1
Fires $\geq$ 40 shots per second	+2
Fires $\geq$ 80 shots per second	+3
Each extra level of mass in the weapon	-1
Any extra feature to increase controllability	-1

Modifiers to total	Amount
Weapon has burst fire capability	-1
Weapon is fired using two hands	-1
Weapon has inertial stabilizers	half recoil(d)
Laser weapon	has no recoil

**Example** - Try a machine pistol with a Damage of 2, a rate of fire of 20 shots per second and a mass of 2.0kg over 2 locations.

The Single Shot recoil number is 2 (Damage of 2, plus 1, minus 1 for the mass of the weapon).

The Burst recoil number is 6 (Damage of 2, plus 1, minus 1 for the mass of the weapon, plus 1 for the high rate of fire, and the result times 2).

If the weapon were fired using both hands, the SS and Burst numbers would be 1 and 5, and if the weapon had burst fire capability, it would be 1 and 4 if fired using both hands.

**Note** - If a weapon has multiple versions firing the same cartridge, recoil is *not* increased if a longer barrel increases Damage rating or causes mass per location to drop below .75kg per location.

One thing to note with this conversion is that **3G<sup>3</sup>** uses different means to generate secondary weapon numbers than **TNE** does, specifically regarding Damage and Recoil. In **TNE**, Damage is based solely on the energy delivered, while **3G<sup>3</sup>** uses the energy and the cross-sectional area of impact. Recoil is based on the overall energy of the round, rounds fired and the mass of the weapon in **TNE**, and **3G<sup>3</sup>** bases it on the Damage stat, with different modifiers for mass and rate of fire.

# Traveller: New Era

## Range

**TNE** only has four range bands for a weapon, Short, Medium, Long and Extreme. These convert from aiming RC's as follows:

Aiming RC	Short range is:
1	5 meters
2	10 meters
3	25 meters
4	50 meters
5	100 meters
6	200 meters
7	400 meters
8	800 meters

This really does not apply well to aiming RC's greater than 5. This base "short range" will be modified by weapon and ammunition characteristics.

Characteristic	Multiply range by:
Damage RC is less than aiming RC	x.80 per RC
Damage RC is equal to aiming RC	x1.00
Damage RC is greater than aiming RC	x1.20 per RC
IA of weapon is less than base	x.80 per point
IA of weapon is equal to base	x1.00
IA of weapon is greater than base	x1.20 per point

Accessory	Add to range:
Mini telescopic sight (1-2x)	5 meters
Small telescopic sight (2.5-5.5x)	10 meters
Regular telescopic sight (6x and up)	15 meters
Electronic sights ( <b>3G</b> <sup>3</sup> Tech Level 12+)	+5 meters

**Example** - A 9mm pistol probably has an aiming RC of 2, for a Short range of 10 meters. The damage RC of a 9mm round is 3, so this is increased to 10m x 1.20 = 12m. If this were a more accurate pistol with an IA of 2, the range would be 10m x 1.20 x 1.20 = 14m (round nearest).

**Example** - A hunting rifle with an RC of 4/4 and an IA of 3 would have a Range of 50m x 1.2 = 60m. If equipped with a 6x telescopic sight, the Range would be increased to 75m (for aimed shots).

**Note** - Technically, any add-on to a weapon which improves its range does not affect the range at which the Pen changes. So, while a telescopic sight might increase the Long range of a rifle for aiming purposes, it should not affect it for Pen purposes.

## Mass

This is the loaded mass of the weapon, in kilograms, followed by the mass of any extra clip or magazine, if applicable.

## Cost

This is the **3G**<sup>3</sup> cost of the weapon.

## Armor (optional)

This has no equivalent weapon stat in **TNE**, but may be an optional quality. Treat the AV as a Damage Value, and find the equivalent Damage stat. This number will act as armor against anything that strikes the weapon. While not actual armor, it will count for deforming, deflecting or detonating rounds which strike it. Values of zero will not stop any damage, but may alter the Pen of any rounds going through it.

## Damage boxes (optional)

The BP of the weapon count directly as damage boxes, like a person's hit capacity. Any damage which penetrates the "armor" of the weapon does a number of dice damage equal to the armor of the weapon, with a minimum of 1 die. Remaining damage goes through the weapon and towards the next target. Weapons which take any internal damage are assumed to be broken in some way, and weapons which take all their damage boxes are destroyed. If you choose to allow damaged weapons to function, apply a -1 modifier to all fire for each time armor was penetrated.

## Reliability (optional)

This does not really have an equivalent in **TNE**, since it is difficult to apply in a 1d20 system without causing numerous extra die rolls each time a "20" comes up. If a character ever rolls a certain number of consecutive 20's on d20, their weapon may malfunction (for autofire weapons, roll dice in such a way as to know the order, like by color, size or one at a time).

Reliability	20's for malfunction(d20)	Roll for catastrophic
I-II	2	20
III-IV	1	20
V-VI	1	15+

If there is a malfunction, roll the same die type one more time. If more than the required number of dice come up in one string, like an autofire burst or getting unlucky with the extra die, then the malfunction is more serious.

**Example** - A pistol with Malfunction Class II rolls dice for a pair of shots, and gets two 20's in a row. The player then rolls 1 more d20, which comes up a 3 (not another 20, which would be a serious malfunction). The weapon seizes up or jams at the point in the burst where the second "20" came up, and no further ammunition is used, or further hits made on that round. Normally, the character's next action will be spent clearing the jam.

## Shotguns (optional)

For weapons like shotguns, use the base DV of 1 pellet for figuring the Damage, *keeping fractional amounts*. At the weapon's Short range, assume all the pellets hit, and the number of dice of damage is the number of pellets times the "per pellet" Damage(n), with a Pen of "nil". Maximum Damage is twice the damage for a normal shotgun slug of that caliber, minus 1. At Medium range, assume a number of autofire attacks equal to the pellet quantity (not more than 10), each one doing the rounded damage of a single pellet.

**Example** - If a 12ga slug has a Damage of 3, then point blank buckshot would have a maximum Damage of (2 x 3) - 1 = 5.



The shotgun conversions in **3G<sup>3</sup>** are meant to reflect that at point blank range, a cloud of shot has roughly the same penetration and damage as a slug, as the shot pellets are so close that they will actually hit each other upon reaching a target. However, this diffused nature makes them less able to penetrate armor, hence the reduced Pen as compared to normal **TNE** rules. Damage is treated normally at longer ranges. Note that different shotguns may have different “autofire” burst quantities for buckshot:

	Autofire dice				
	pt blank	short	med	long*	extreme*
<b>10ga (19.5mm)</b>	18	10	7	4	1
<b>12ga (18.5mm)</b>	15	10	7	4	1
<b>16ga (17mm)</b>	10	10	7	4	1
<b>20ga (15.5mm)</b>	8	8	5	2	0
<b>.410ga (10mm)</b>	3	3	2	1	0

\*not accepted ranges, but shown for reference.

If you are using only 12ga shotguns, then it is simplest to simply say they do 9 dice damage, as per the normal rules. The **More Guns!** supplement presents the buckshot damage of different weapons as per the above chart.

**Example** - A **3G<sup>3</sup>** DV of 15 is a **TNE** Damage of 1. A 20ga shotgun might therefore have its buckshot damage listed as 8x1, since it is a maximum of 8 pellets, as opposed to the larger number a 12ga might hit with, and to show that it will get less autofire dice at longer ranges.

### Guided weapons (optional)

Use all the standard guidelines in **3G<sup>3</sup>** for mass, volume, power consumption, etc. Guided weapons in **TNE** have a few important derived stats, which are Range, M/turn and Agility.

Range for guided weapons is the weapon's **3G<sup>3</sup>** bonus, times its the Range it would normally get from aiming RC, times 8.

**Example** - A +4 self-guided missile with an aiming RC of 4 has a Range of 4 (its +4 bonus), times 50 (the **TNE** Range associated with an aiming RC of 4), times 8, for a total of 1,600 meters.

M/turn is simply the maximum velocity of the missile as determined in **3G<sup>3</sup>**, rounded to the nearest 10m/sec.

Agility is based on the guidance system of the missile, and is half the **3G<sup>3</sup>** bonus, rounding down.

Cost and other stats are computed normally.

### Explosions (optional)

For HE charges, the DV is converted to a Pen value, and this becomes the Concussion rating of the blast. For fragmentation weapons, you need to use **3G<sup>3</sup>** to figure the range at which a human-sized target is hit by 0.6 fragments. Basically, a 40% chance of not getting hit at all. Round this to the nearer meter if there is any question as to the distance. The result is the primary burst radius of the charge.

**Example** - A weapon with 1000 fragments would have 40 hits at 1 meter, 10 hits at 2 meters, 2.5 hits at 4 meters and .625 hits at 8 meters. Therefore, this weapon would have a rating of B:8.

Total fragments	TNE burst radius
15	B:1
60	B:2
150	B:3
250	B:4
360	B:5
550	B:6
750	B:7
1000	B:8
1500	B:10
2250	B:12
3000	B:14
4000	B:16

You may either use **TNE** rules for frag damage, or apply the number in parentheses as the damage of the fragment. If this range is not convenient for the grid scale chosen, round to the nearest unit.

**Example** - A rating of C:6, B:4(2) would mean a concussive rating of 6, and a primary burst radius of 4, where each fragment hit has a Damage of 2.

### Special ammunition (optional)

This will affect the Damage stat of the weapon, in that the ammunition type will affect the tissue or structural damage done to the target. Modify the DV as per the normal rules for unarmored target damage (not armor or target alone), and recalculate the Damage rating.

Armor piercing ammunition decreases the Pen rating by 1. In addition, there is a difference between a non-armor piercing Pen of 1, and an armor-piercing Pen of 1. The former will deform after passing through any incidental cover or protection, and its Pen will increase by 2 points (or to “nil” if greater or equal to the Damage) for any subsequent hits, like hitting an armored person after going through a car door. Armor piercing ammunition retains its Pen after passing through other armor.

**Example** - A 5.56mm armor piercing round has a Pen of 1 and a Damage of 4. After going through a car door with an Armor of 1, it has a Damage of 3 and Pen of 1. A normal round after going through a car door would have a Damage of 3 and a Pen of 3 (or nil).

Hollow-point increases the Pen rating by 1, and in addition, a hollow point round which passes through any armor has its Pen rating increased by 3 points (or to “nil” if greater or equal to the Damage) for any subsequent hits.

Exploding ammunition increases the Pen rating by 2, and in addition, an exploding round which strikes any armor automatically detonates, and is assumed to do no damage to targets not immediately adjacent to the armor. It is likely however, to take a chunk out of the protection at that location.

If the Pen ends up the same or more than the Damage, it becomes “nil”, or instead of subtracting all the dice, it can be treated as a weapon with a Damage of -1. This is especially likely with small caliber AP rounds. Weapons with a base Pen of 1 that goes to 0 because of ammunition type are still counted as Pen 1. Using the **3G<sup>3</sup>** special ammunition multiples, the Damage and Pen of common **3G<sup>3</sup>** TL12 small arms rounds are below.

# Traveller: New Era

Weapon	DV	Damage	Damage/Pen		Expl.
			AP round	Hollow pt.	
.22LR	16	1/nil	1/nil	2/nil	2/nil
.38 Spec.	17	2/nil	1/nil	2/nil	2/nil
.45ACP	18	2/nil	1/nil	2/nil	2/nil
9mm Para	22	2/nil	2/1	2/nil	3/nil
.357 Mag	25	2/nil	2/1	3/nil	3/nil
10mmACP	26	2/nil	2/1	3/nil	3/nil
.44 Mag.	30	3/2	2/1	3/nil	4/nil
4.73mm/c	46	4/1	3/1	5/2	5/3
.30-30	50	4/2	3/1	5/3	6/3
5.56mm	51	4/1	3/1	5/2	6/3
7.62mm	56	4/2	3/1	5/3	6/4
.30-06	61	5/2	4/1	6/3	7/4
12.7mm	107	8/2	6/1	9/3	11/4
20mm	164	11/2	9/1	13/3	16/4

Only when rounds get out of the handgun range do you really see any advantage to using certain ammunition types. Otherwise, the fractional points of Damage and Pen round to the same number, regardless of ammunition type, and there is no noticeable game effect. What it does do is provide a “wider” scale, so that a particular caliber with a particular ammo type can be more effective than another weapon that happened to round to the same Damage and Pen.

**Example** - While a .357 Magnum and 9mm both have a base Damage of 2, the .357 is clearly superior when you load hollow-point ammunition.

## Indirect fire

The IFR range of a projectile is either the maximum range of the projectile based on mass and velocity, or the maximum range indicated by its damage RC, whichever is shorter.

## Energy weapons

Batteries in the **TNE** system have the following energies, compared to their equivalents in **3G<sup>3</sup>**.

TNE TL	Energy/gram	3G <sup>3</sup> TL	Energy/gram
5	108J	9	200J
6	144J	10	400J
7	180J	11	700J
8	360J	11+	900J
9	720J	12	1100J
10	1080J	13	1600J
11	1440J	13+	1800J
12	1800J	14	2100J
13	2880J	15	2900J
14	3600J	16	3700J
15	4320J	17	4600J

The weapons in the **More Guns!** supplement that use stored energy use the **3G<sup>3</sup>** numbers.

## Lasers

Lasers in the **TNE** universe become available at **TNE TL8**. At TL8-12, lasers use integral or worn power packs, using standard **3G<sup>3</sup>** energy storage rules, and the mass of the power supply is assumed to also cover any cooling apparatus needed. At **TNE TL12+**, lasers may use chemical cartridges which use chemical energy instead of electrical energy to create the laser beam. These would be designed as regular lasers, but the “ammunition” uses the *half* the energy of conventional propellant at that TL (the other half of the energy represents coolant mass). Do *not* use the efficiency twice as indicated in the **chemical lasers** sidebar (p.43). Such rounds must be cased, and are usually not reloadable. The chemicals involved are usually pretty toxic as well. They have the advantage that they are not prone to overheating as most of the waste heat is vented in the exhaust gases.

**Example** - At **TNE TL13 (3G<sup>3</sup> TL15)**, chemical laser storage will have an energy of 1010J per gram (half the propellant energy at **3G<sup>3</sup> TL15**), to which laser efficiency at that TL is applied.

**Note** - All the lasers listed in **More Guns!** use conventional electrical storage mediums.

## Particle beams

These come in two flavors in the **TNE** universe, plasma guns and fusion guns. Plasma guns (**TNE TL12-14**) use energy or a chemical reaction to heat hydrogen into a plasma, which expands with explosive force down an evacuated channel created by a laser or other ionizing beam (not necessary in space). Fusion guns (**TNE TL14-15**) use more advanced technology and presumably deuterium or tritium to hold the plasma until it begins to fuse, for better penetration of armor.

Such weapons can be designed using normal energy storage rules, or may use chemical cartridges as lasers may, with the same base efficiency. If this efficiency is halved, the cartridge itself may be considered to have built-in recoil compensation (retro-rockets), which will halve recoil, and the energy would be applied as normal backblast. At **TNE TL14+**, computer-controlled gyro-stabilizers may be mounted to halve the recoil penalty.

Both plasma and fusion weapons have a primary burst radius from splatter equal to the square root of the Damage, and fragments within that radius are treated normally within the rules system. Plasma weapons have no radiation side effects, but fusion weapons might. The radiant heat from the side of the beam may set fire to nearby flammables.

## Railguns

These exist at **TNE TL's** of 12+, and are known as gauss weapons. They are designed using normal rules, but often use disposable clips which contain the projectiles and a charged energy source. This would usually be treated as the mass of superconductor storage plus projectiles, with the clip mass based on the total.

## Energy pulses

For lasers and particle beams, the delivered pulse energies for a single shot have the following **TNE** damage after being converted from **3G<sup>3</sup>**. This is solely for reference so that you can decide what fudge factors to use for applying weapon damage at large scales. For instance, subtracting 2 from the listed laser Damage and 6 from the particle weapon damage seems to give a good comparison to existing high-tech weapons in this system.

Energy	Laser	Damage	Particle beam	Damage
.01mJ	7.0mm	7	5.0mm	9
.02mJ	9.5mm	9	5.0mm	11
.05mJ	14.5mm	11	5.0mm	14
.1mJ	20mm	13	5.0mm	16
.2mJ	27.5mm	14	5.0mm	18
.5mJ	41.5mm	15	6.5mm	20
1mJ	56.6mm	16	9.0mm	22
2mJ	77mm	17	12.2mm	23
5mJ	117mm	18	18.4mm	25
10mJ	159mm	20	25.2mm	26

**Example** - If you wanted to design a plasma bazooka at **TNE** TL13, you could design a chemical cartridge with 4mJ of energy (about 3.96kg, plus 8.71kg for the "casing"), and this would have an output energy of 1.0mJ, for a Damage of 22, and you would subtract 6 from this to get the final result of 16. This is a quick way to get approximate numbers without actually designing the whole weapon.

## Melee weapons (optional)

The melee weapon list for **TNE** is not very large, but enough data exists to generate a good conversion from **3G<sup>3</sup>** stats, and to expand the rules slightly.

## Swing

Weapons have both a Swing and Thrust damage. Swing Damage is a base of 1 for a DV of 5, and each +10DV (round nearest) adds 1. Unbalanced weapons get to add (STR/2) if used in one hand, and add STR if used in both hands. Balanced weapons  $\geq .60\text{m}$  long may get to add (STR/2) if they are used in both hands.

## Thrust

Thrusting weapons get a base Damage of 1 for a DV of 5, and each +10DV (round nearest) adds 1. A thrusting weapon used with both hands may add (STR/2). A weapon which can both swing and thrust is not considered unbalanced when used in a thrusting fashion.

3G <sup>3</sup> DV	Swing Bal.	Unbal. 1 hand	Unbal. 2 hand	Thrust 1 hand	Thrust 2 hand
0-4	0	0	0	0	0
5-9	1	1+(STR/2)	1+STR	1	1+(STR/2)
10-19	2	2+(STR/2)	2+STR	2	2+(STR/2)
20-29	3	3+(STR/2)	3+STR	3	3+(STR/2)

Weapons with a Damage of 0 are only good for generating Scratch results in combat, although they can be used as Damage 1 against a helpless opponent. The difference between swing and thrust damage is campaign dependent. Some attack types may be more effective in close quarters, or against certain types of targets. For instance, some bizarre alien creature in a dark future game might only take damage from Swing attacks that hack it to bits, or the GM has certain types of armor be more effective against one type of attack than the other, like puncturing melee attacks vs. ballistic cloth.

## Energy enhanced weapons

Melee weapons with an electrical charge to do extra damage get Damage as normally converted **3G<sup>3</sup>** DV, but usually require penetration of armor to have any effect. Non-insulated metal armors do not count vs. electrical damage, nor do armors too thin to have a rating vs. ballistic attacks.

## Hit modifier

This is the bonus or penalty to user skill inherent in the use of this particular weapon. This is based on the IA, length and type of weapon.

Weapon type	Hit Modifier
Any, $\leq 3$ meters (Short range)	IA+1
Any, .31-.60 meters (Long range)	IA
Any, .61-1.00 meters (Long range)	IA-1
Any, $> 1.01$ meters	IA-2
Unbalanced, with +STR damage	additional -2
Unbalanced, with +(STR/2) damage	additional -1
Flexible weapon	additional -1

Articulated weapons are counted as unbalanced, as are flexible weapons with a mass at the end. Thrown weapons have a Hit Modifier of 0.

**Example** - An unbalanced mace, .8 meters long, with an IA of 1, and +1/2STR damage will have a Hit Modifier of 1 (for the IA), -1 (for length), and -1 for being unbalanced with +1/2STR, for a total of -1.

## Range

Based on length, as on above table. For sequencing purposes, assume Short weapons have a Bulk of 2, and Long ones have a Bulk of 4. Add the inverse of any Hit Modifier to this amount.

**Example** - The mace in the previous example has a "Bulk" of 4, which goes to 5 because it has a -1 Hit Modifier.

## Mass

Mass of the weapon in kilograms.

## Armor

Figured as for other weapons. Counts vs. normal assaults on the weapon, and multiply by 2 if the weapon is used to block a melee attack.

## Damage boxes

Any damage getting past armor will damage the weapon, as for other weapons if struck by a ranged attack, and by all excess hits from a melee attack. These will damage the weapon, and it breaks when all boxes have been marked off.

# Traveller

# TRAVELLER<sup>®</sup>

## Basics

**Traveller, 4th edition (T4)** is a science fiction rpg with a wide variety of tech levels and technologies, set in an alternate future history, with widely available interstellar travel, a long history and extraordinary amounts of background material. The new edition of **Traveller** contains a number of different mechanics than previous incarnations of the game, but strives for the same feel of the original version.

## Name

This is the common name of the weapon, and is followed by the caliber, bore or beam diameter. All measurements are in metric units, and historical rounds that had an inch designation have been converted to mm instead.

## Ammunition compatibility

Since **Traveller** TL's are more widely spread than the ones in **3G<sup>3</sup>**, it is reasonable to say that among weapons of the same caliber, ammunition is only compatible if from the same TL and manufactured on the same world, and even this may not apply in some cases.

## Tech Level

Since TL is an overriding factor in all weapon designs, an accurate conversion scale is needed.

<b>3G<sup>3</sup> TL</b>	<b>Traveller TL</b>	<b>Earth equiv.</b>	<b>Example</b>
4	0	Dark ages-	
5	1	Middle ages	Hand cannon
6	2	c.1600	Flintlock pistol
7	3	c.1800	Percussion rifle
8	4	c.1900	Cartridge rifle
9	5	c.1930	Medium machinegun-5
10	6	c.1950	Light machinegun-6
11	7	c.1970	5.5mm Gatling gun-7
	8	c.1990	Caseless ammo, laser carbine-8
12	9	Fusion era+	Laser rifle-9
13	10		
14	12		
15	13		PGMP-13
<b>Extrapolated</b>			
16	14		PGMP-14
17	15		PGMP-15

As you can see, the basic **3G<sup>3</sup>** scale doesn't go past the **Traveller** TL13. This is based on the premise that antigrav stabilization of hand weapons (i.e. PGMP-14 and 15) is not available at the **3G<sup>3</sup>** TL15 level. You can use the "ultratech" options in **3G<sup>3</sup>** to get values for weapons past this point.

Likewise, a slight anomaly exists at the lower TL's. The high-energy storage postulated in **3G<sup>3</sup>** does not become available until **3G<sup>3</sup>** TL13, which corresponds to **Traveller** TL10. However, the first laser weapons theoretically become available at **Traveller** TL8. You can assume that either the weapons are built according to TL12 guidelines, or use the TL13 energy storage, and lasing apparatus of the lower TL.

Other variances are due to short time ranges for a given TL, or overlap between eras. For instance, **Traveller** TL8 and TL9 represent Terran technology advances by 1990 and 2010, while **3G<sup>3</sup>** has TL11 at 1980 and TL12 at the year 2000.

## Historical Accuracy

This is kind of pointless, as most current weapons are from a time period well before any **Traveller** campaign. Nonetheless, these archaic weapons do provide a variety that **Traveller** lacks, and can give personality to otherwise featureless possessions. For modern (circa 2000AD) weapons, weapons that have a **3G<sup>3</sup>** TL range that goes to TL12 will only go up to **Traveller** TL8, which presumes they will be in use up to around **Traveller** TL9 (mid 21st century), but would be superceded by newer designs by that point.

## Penetration

The DV in **3G<sup>3</sup>** is a measure of the armor penetrating ability of a projectile or beam, and so translates into the Penetration rather than damage of a **Traveller** weapon. The damage done by most weapons is 3d or its Penetration, whichever is *lower*. Exceptions are for shotguns or other multiple projectile weapons which may have a low Penetration but higher damage.

The numbers on the Universal Conversion Table are based on the equation below. Note that all Penetrations are listed for the *bottom* of the appropriate DV range on that table. The actual best fit equation is:

$$\text{Penetration} = \text{DV}^{.43} - 1(d)$$

This works well for any DV in normal use, out to a Penetration of 30 for a **3G<sup>3</sup>** DV of around 3000.

<b>3G<sup>3</sup> DV</b>	<b>Traveller 4th ed. Penetration</b>	<b>Traveller 4th ed. Damage</b>
0-4	0	1/2d (optional)
5-12	1	1d
13-25	2	2d
26-42	3	3d
43-64	4	3d
65-92	5	3d
93-125	6	3d
126-165	7	3d
166-211	8	3d
212-263	9	3d
264-323	10	3d
324-389	11	3d
390-462	12	3d
463-542	13	3d
543-630	14	3d
631-726	15	3d
727-829	16	3d
830-940	17	3d
941-1060	18	3d
1061-1187	19	3d
1188-1323	20	3d

For calculating Penetration, use any modifiers to DV that would apply to ability to penetrate armor. For instance, armor piercing rounds would have a higher effective DV for calculating Penetration. For weapons that would do *less* tissue damage, the damage done by the weapon is unaffected as long as its “penetration” is 3 or more. If lower than 3, the damage is reduced by the *lowest* die for each point less.

**Example** - A 3G<sup>3</sup> weapon with a DV of 30 and armor-piercing ammunition would have an effective DV of 45 for Penetration purposes, but a 22 for damage purposes. A DV of 45 is a Penetration of 4, and a DV of 22 is a Penetration of 2, which is still 3d of damage, but you don't count the lowest of the die results. So, a 3d roll of 3,4,6 would do 10 points of damage, not 13 points (ignore the “3”).

Weapons that would do *more* tissue damage, reduce the Penetration appropriately, and if the adjusted “penetration” for damage is *more* than 3, then the damage is still 3d, but is increased by the *lowest* die that penetrates armor.

**Example** - A 3G<sup>3</sup> weapon with a DV of 60 and exploding ammunition would have an effective DV of 30 for Penetration purposes, but a 90 for damage purposes. A DV of 30 is a Penetration of 3, and a DV of 90 is a Penetration of 5. If this went through an armor of 1, then the target takes 2d damage, but you increase this by the lowest die. A 2d damage of 3,5 would be 11 points, not 8 (add the “3” twice).

### TL adjustments

Due to the wide spread in DV's between **Traveller** penetration values, very few weapons will change between TL's. Those that have a higher penetration (1 point increase) for weapons and ammunition in the upper half of a TL range should be given a separate listing at the higher TL.

**Example** - If a weapon has a DV of 25 at **Traveller** TL7, it is almost certain that the weapon will have a DV of 26 or more should it still be made at TL8, so the weapon should have two versions, one with TL7 stats and one with TL8 stats.

### Range

All weapons in **Traveller** will have a Range stat, which determines how accurate the weapon is with *aimed fire*. This is based on the Aiming RC and Inherent Accuracy of the weapon, as per the following table. Go up 1 row if the damage RC of the weapon is *less* than the aiming RC.

Aiming RC	Range stat	Task	Inherent Accuracy	Adjustment
1	Contact(3m)	1.5D	lower than base	-1 row
2	Very short(15m)	2D	base or +1 base	no change
3	Short(45m)	2.5D	base +2 or more	+1 row
4	Medium(150m)	3D		
5	Long(450m)	3.5D		
6	Very long(1.5km)	4D		
7	Ext. long(3km)	4.5D		
8	Sub-regional(10km)	5D		

**Example** - A 3G<sup>3</sup> weapon with an aiming RC of 2 would have a **Traveller** Range of Very short. If this were a cheap weapon with an IA of 0 (1 point less than base for RC2), it would instead have a Range of Contact. If it were a target pistol with an IA of 3 (2 points more than base for RC2), it would have a Range of Short.

**Optional** - To reflect the maximum usable range of a weapon, you can say that it can't be used at all at more than 1 range bands past its Range stat. So, a Short range weapon has a maximum effective range of Medium. Shots can still kill past this range, but fire for a special game effect is not possible.

### Rounds

This is the normal ammunition load of the weapon. Weapons that are clip fed will often be able to carry one extra round in the chamber. If a weapon has this capability, the number of rounds will have a +1 after it.

### Shotguns

Shotguns can have a Damage of higher than 3 to reflect a large number of individual hits, but slugs should only have a Damage of 3 (but with a higher Penetration).

Projectiles	Damage	Example
5-10	3	12ga 000 Buckshot
11-20	4	12ga 00 Buckshot
21-40	5	12ga #4 Buckshot
41-80	6	12ga Birdshot

The Penetration of buckshot or flechettes is based on that of a single projectile. In addition, the Damage dice from a shotgun or similar weapon drops by 1 for each range band past Very short.

### Indirect fire

If a weapon is capable of indirect fire, it usually does not have the maximum effective range limit of a direct fire weapon. It gets a -1DM for each range band past Contact, with a miss of 1 range band per point the total is off by and with a maximum miss of half the total negative DMs (round up).

**Example** - A grenade launcher whose aiming RC of 2 gives it Very short range fires at a target at Long range. This is a -4DM to the roll. If there are no other negative DMs, the maximum miss is 2 range bands, or Very short range or less.

### Autofire

Autofire is a -DM of the range category the target is at, and double the -DM for adjacent targets. High or low rates of autofire may be a *separate* DM from this, and adjust the damage done *after* armor is penetrated (round down). The type designation is usually part of the weapon name, like “VRF gauss rifle”.

**Example** - Very short range is range band 1, so autofire at this range is a -1DM against the main target and -2DM vs. adjacent targets. Any RoF DM would apply *after* doubling the -DM.

Rds/second	Rds/turn	Damage	RoF DM	Weapon type
4-	<30	1.5x	-1	
5-10	30-60	2x	+0	
11-20	61-120	2.5x	+1	
21-50	121-300	3x	+2	RF
51+	>300	4x	+4	VRF

Autofire is based on the *sustainable* rate of fire. If a weapon runs out of ammunition during a 6 second combat round, it is not reloaded to get a higher rate of fire. So, a machine pistol that empties a 30 round clip in 2 seconds still only fires an average of 5 rounds a second during a 6 second turn, for a +0 autofire DM after range is taken into account.

# Traveller

## HE rounds

For high explosives, *double* the Penetration you calculate from the **3G<sup>3</sup>** Damage Value. In general, the **Traveller** damage of an HE charge from a weapon will be equal to its Pen. The Danger Space for a blast will be whatever distance it takes for the Penetration to drop to zero. Penetration in **Traveller** is quartered (round down) each outdoor square, or halved (round down) each indoor square (1.5m) from the center of the explosion.

Damage Value	HE Penetration	Danger Space
5-12	2	3m
13-25	4	4.5m
26-42	6	4.5m
43-64	8	6m
65-92	10	6m

**Example** - A 1.0kg charge of **3G<sup>3</sup>** TL11 explosive has a DV of 193. This converts to a Penetration of 16. It drops to a Penetration of 8 at 1.5m, 4 at 3m, 2 at 4.5m, and 1 at 6m, so the charge has a Danger Space of 7.5m (since a Penetration of 0 can still do 1 pip of damage). Outdoors, everyone in the same square would take a Penetration of 4, and a Penetration of 1 in the adjacent squares.

## Fragmentation rounds

If a weapon has fragmentation effects as well as blast, figure the Penetration of an average fragment. Double this amount at Contact range, and halve it each square outside this range. If the fragmentation weapon has less than 1000 fragments, subtract 1 from the Contact range Penetration, and if it has less than 500, subtract 2.

**Example** - A **Traveller** TL8 grenade with fragments having a **3G<sup>3</sup>** DV of 13 would have a Penetration of 2, so it has a Penetration of 4 in the Contact square, 2 in the next square, 1 in the next square and 0 in the next square. A **Traveller** TL5 “pineapple” grenade with fragments having a **3G<sup>3</sup>** DV of 30 would have a Penetration of 3, so it has a Penetration of 6 in the contact square. However, it has much less than 500 fragments, so it is counted as also having a Penetration of 4 in the Contact square.

Directed fragmentation weapons have normal blast effects, but Penetration for fragments is quadrupled at Contact range, and halved every 5 squares (7.5m). Fragment damage only applies in an arc that gets wider by one square to either side for each 3 squares of range.

**Example** - A **Traveller** TL8 claymore mine with fragments having a **3G<sup>3</sup>** DV of 23 would have a Penetration of 2, so it has a Penetration of 8 in the Contact square and next four squares, 4 in the next five squares, 2 in the next five squares and so on.

## Signature (optional)

Signature is not used in basic **Traveller**, but is still a useful concept to have around, and represents how easy it is to spot the user of the weapon with human senses. Signature is based on a variety of factors, such as the means of damage (photons vs. lead), the means of propelling a projectile (gauss vs. CPR), and projectile velocity (sub- vs. supersonic). The signature of a weapon can generally be classed according to the table below.

Weapon type	Signature
CPR with subsonic projectile	Low
CPR with supersonic projectile	Medium
CPR with Penetration of 5+	High
Silencer (if possible)	-1 level
Shotguns	Base on Pen of slug
Recoilless rifle	High
Rocket	Medium
Railguns or gauss weapons	Low
<b>Traveller</b> TL8 laser	High
<b>Traveller</b> TL9-12 laser	Medium
<b>Traveller</b> TL13+ laser	Low
Particle beam or plasma weapon	High

Assume Low signature weapons are -3DM to spot, Medium ones are +0DM, and High signature weapons are +3DM to spot.

## Recoil

Due to the turn and action structure of **Traveller**, recoil penalties on weapons are unnecessary. If a weapon has exceptional recoil, the user might complete the firing task with Strength instead of Dexterity.

## Armor (optional)

Another optional term for **Traveller**. Multiply the AV by 2 and check on the DV vs. Penetration chart. If the Penetration of the attack is equal or less than this, the weapon only takes superficial damage. If the Pen is greater, the weapon takes internal damage and is probably broken.

## Initiative (optional)

This is another optional rule for **Traveller**. The Initiative of a weapon is added or subtracted from the tactical point pool. So, a person with a bulky weapon (poor Initiative) is likely to act after a person with a compact weapon (good Initiative). Weapons already trained on a target (ambush) use their Initiative or 0, whichever is better.

## Reliability (optional)

**Traveller** now has “spectacular failure” rules for skill use. On a standard weapon (Malfunction class I or II), this is usually just a malfunction or unlucky miss. Unreliable weapons *will* count half dice for spectacular failure results, and very unreliable weapons will roll a special extra die *only* to see if it comes up a “6”. If a failure occurs because of the extra die, the weapon breaks.

Reliability	Spectacular Failure	Typical result
I	two 6's (no half dice)	Bad miss
II	two 6's (no half dice)	Malfunction (1 action to clear)
III	two 6's (count half dice)	Malf. with -2DM to clear
IV	two 6's (count half dice)	Malf. with -4DM to clear
V	two 6's (roll extra die)	Malf. with -6DM to clear
VI	two 6's (roll extra die)	Malf. with -8DM to clear



**Example** - A character with a zip gun (class VI) rolls an Average task (2D), getting a “6” and a “3”, but also rolls an extra die, which doesn't count towards the total, but which may be a “6” for spectacular failure results. If it does come up “6”, the weapon automatically breaks and cannot be fixed in combat.

### Guided weapons

At short ranges, guided weapons simply count as direct fire weapons with a bonus to hit. The bonus is generally a +2DM per 25% of guidance bonus, with increments of 15% needed per +1DM (i.e. a 40% bonus would be +3DM). Most of the time, a rocket will reach its target in one round (6 seconds), if not, another roll must be made for each round of flight time.

Once on its own, a self-guided weapon will get a Dexterity of half the TL (round down) and its inherent DM. It will apply this total to the Difficulty for *current* range (which should decrease each turn), and roll once for each turn it is in flight.

**Example** - A **Classic Traveller** TL10 manpack SAM with a +3DM is fired at a Very long range target (1.5km). The character's Dexterity and skill plus the weapon DM and aiming DM send it towards the target. If this were an “air mine”, programmed to fire at the first target that entered its airspace, it would be counted as having a Dexterity of 5 (half the TL) with a +3DM and its aiming DM if programmed to spend time doing so.

Remember that the user's skill in initial aiming helps, as do special effects of the guidance system at a particular TL.

### Smart weapons

These simply provide a +DM to hit, which is figured the same way as for guided rockets, and is subject to the same target acquisition and tech level limits. The maximum +DM is the weapon's normal aiming DM, and this is halved (round down) for shots in each range band past the weapon's Range. The bonus provided by such a sensor is cumulative with aiming DM's and other sighting aids. Smart weapons do not *require* an aiming action, but without aiming, any valid target in the weapon arc may be targeted and fired on. So, waving it around if there are any friendlies out there is a big no-no.

**Example** - A Short range SMG can have a maximum +2DM sensor. This gives a +2DM out to Short range, and +1DM at Medium range.

### Proximity rounds

If a weapon has a proximity fuze and misses hitting its target directly, assume the miss is by a number of range bands equal to each point the roll is failed by. The absolute maximum distance for a miss is half the number of range bands to the target.

**Example** - A +1 proximity fuzed round will detonate if it misses by 1, which is within 3m of the target. A weapon with a +2 proximity sensor will go off if it misses by 1 or 2, which is anywhere within 15m of the target.

### Stabilized weapons

Anti-grav stabilization will be bought as gyrostabilization, but only affects recoil (halve autofire -DM's). Any recoiling handheld weapon with a Penetration of 6+ will require this. Regular gyrostabilization must be bought as a separate item, so a weapon which has both antigrav compensators and gyroscopic stabilizations will have double the normal mass in gyros or related technologies. A weapon must be “stabilized” in order to use fire control computers.

### Lasers

These are designed normally, but with the option of creating stunners and continuous beam lasers. Continuous beam lasers are simply counted as having the maximum autofire DM.

### Stunners

These involve two damage-producing technologies, the beam and the high-voltage pulse. The laser will probably have a Penetration of 0 or 1. The Damage of the small laser will be equal to its Penetration, with a maximum Damage of 3. The high-voltage pulse has no Penetration, only Damage (non-lethal), which is calculated like it was a DV, with a maximum damage of 3D. Such a stunner would not have any effect on a target with armor greater than the Penetration of the laser, or through any sort of cover.

**Example** - A DV10 laser with a stun DV of 40 would have a Pen of 0 for the laser, and a non-lethal damage of 3d for the electrical pulse.

### Particle beams

A **3G<sup>3</sup>** particle beam will become a **Traveller** plasma gun (like the PGMP series), since particle beams are not used in the game as hand weapons. Penetration is based on *5 times* the designed DV (minimum designed DV of 100), and the Damage is equal to 3D. But, treat a quarter (round down) the Penetration as an explosive Penetration vs. that and nearby targets. The “splash” of the plasma can finish off lightly armored targets.

**Example** - A DV of 200 becomes 1000 before conversion. This gives a Penetration of 18, and a damage of 3D. The target hit and nearby targets are treated as though a Penetration 4 explosive with 4D Damage had gone off where the plasma gun hit.

**Optional** - You may use radiation side effects to create a linear Danger Space to either side of the plasma beam. Count the radiation from the multiplied DV as a DV, and figure the Penetration and Damage from this amount.

**Example** - The previous example had an adjusted DV of 1000, so would do 10 rads of radiation damage. A DV of 10 is a Penetration of 1, so the plasma beam has a Danger Space of 1, with a Penetration of 1 and Damage of 1D to each side.

### Gauss weapons

These are built according to the guidelines for **3G<sup>3</sup>** railguns, and no changes are necessary.

### Melee weapons

These convert **3G<sup>3</sup>** DV to **Traveller** Penetration like other weapons. Weapons with an IA of 2 get a +1DM to use, and those with an IA of 0 get a -1DM to use. Appropriate secondary characteristics are handled as for ranged weapons.

# Cyberpunk 2020



## Basics

**Cyberpunk 2020** is set in a near-future cyberpunk world, where violence is commonplace, and everyone who is anyone carries firepower. Where the term “hostile corporate takeover”, and “bloodbath in the market” have entirely different meanings than they do today. Characters in this world need every edge they can get, and GM's need to keep the players on their toes with new and deadly gadgets.

This conversion should have all the information you need to convert any **3G<sup>3</sup>** or real-world weapon into **Cyberpunk 2020** terms, including changes made for the 3rd edition printing.

Note that most real-world weapons are woefully under-powered for the **Cyberpunk** future, as modern technology has not anticipated that armor-plated cyborgs will be walking the streets within the next 30 years. However, for those GM's who want to use the game and combat system for other genres, the weapon list in **More Guns!** should fit the bill perfectly. As another option, you can simply upgrade everything. Adding 1d6 to all damages tends to increase them to a more useful level for this ultra-violent game universe.

## Tech Level

**Cyberpunk 2020** is solidly in TL12, in **3G<sup>3</sup>** terms. Most 20th century weapons listed are TL11, although many designs from 1990 on may qualify as TL12, like the H&K G-11 and variants, or the aborted Olin/H&K CAWS project. The cutting edge of new technology might have some TL13+ parts, but items like this are the sole property of the GM. Players won't get hold of it unless they steal it. Silent, long range lasers and other deadly toys are best left in the responsible hands of the megacorporations...

## Name

This is the common name of the weapon.

## Type

Based on the **Cyberpunk 2020** weapon classifications, with a few additions.

Abbreviation	Weapon
P	Pistol
RIF	Rifle
SHT	Shotgun
SMG1	Machine pistol (one-handed SMG)
SMG2	Submachinegun (two-handed SMG)
HVY	Heavy weapons
MEL	Melee

## Weapon Accuracy

Inherent Accuracy of a **3G<sup>3</sup>** weapon translates into the **Cyberpunk 2020** WA (weapon accuracy) stat. The closest match is obtained by converting directly from IA to WA, and subtracting 1 if the weapon has an aiming RC of 2, or subtracting 2 if it has an aiming RC of 1. So, an IA of +2 becomes a WA of +2 for an RC3 rifle, but a +1 for an RC2 pistol, and +0 for an RC1 pistol. Inaccurate weapons with low RC's *can* have a negative WA.

## Concealability

A VS, S or VS/2 **3G<sup>3</sup>** weapon is easily concealable in a pocket, pants leg or sleeve (P), although the S and VS/2 weapons are pushing it for the sleeve mount. An S/2 or S/3 weapon will fit in a jacket or shoulder holster (J). An S/4 or S/5 weapon can be hidden under a long coat (L) in casual situations, although sitting, running and close contact are definitely out. Anything larger is not concealable (N). Note the advantages and disadvantages of folding stocks. They are smaller when folded (by 2 locations), but take time to unfold (1 action), and if you don't, you are counted as using a shoulder-fired arm from the hip (-2). You also can't use a telescopic sight very well if the stock is folded.

## Availability

This is always a GM call, but we will assume that civilian 20th century weapons are Common (C). Light military weapons are also Common. Antique, specialized, or extremely deadly devices are Poor (P), or Rare (R), depending on a number of subjective factors like period of manufacture, quantity made and country of origin.

## Damage

This is the damage of the weapon in **Cyberpunk 2020**, followed by the caliber of the weapon. For **Cyberpunk 2020**, the DV's of weapons follow a compressed curve. Plotting it out from the “20th century” weapons listed, and comparing them to **3G<sup>3</sup>** counterparts, the best conversion equation is:

$$\text{Average Cyberpunk 2020 damage} = (19 \times \log_{DV}) - 16.5(n)$$

That is, you enter the **3G<sup>3</sup>** DV on your calculator, hit the “log” key, multiply the result by 19, and then subtract 16.5. The result is the *average* damage the weapon does in **Cyberpunk 2020**. This rounds to the nearest dice type, which may be a full die, half die (for small damages) or a pip added to a full die type.

**Example** - A DV of 30 converts to an average damage of 11.57. The average for 3d6+1 is 11.5, so the damage rounds to that amount. To make things easier on you, the table to the right has all the conversions you'll ever need.

In a perfect world, there would be no problems with this scale, but in reality, some of the converted numbers don't match too well in comparison with **Cyberpunk 2020**. The .44 Magnum is a powerful pistol cartridge, but it does not match the modern 5.56mm in penetrating power, so either one has to be lowered, the other raised, or both. Next, the .45ACP has a higher damage than the 9mm. There are many arguments on the merits of the venerable .45ACP vs. the 9mm, but **3G<sup>3</sup>** works on penetrating power, and modern body armors that are rated to stop all .45ACP bullets (Level IIA protection) will not stop all 9mm's (which require Level II protection), so the .45ACP needs to be dropped a notch or the 9mm increased a bit.

Last, the 21st century 7.62mm NATO round is probably too powerful at its current level, being the equivalent of a modern .50 caliber machinegun. Modifications to the scale that take these into account would make it look as follows. A few non-standard pistol calibers have been added to take up slack between 6mm and 9mm rounds. All rounds are TL12 unless otherwise specified.

Cyberpunk 2020	Average	3G <sup>3</sup> DV	Equivalent wpn.
1/2d6	2	9	
1d6-1	2.5	10	
1/2d6+1	3	11	
1d6	3.5	11	5mm autopistol
1/2d6+2	4	12	6mm autopistol
1d6+1	4.5	13	
1d6+2	5.5	14	.38 Special <sup>1</sup>
2d6-1	6	15-16	7mm autopistol <sup>2</sup> , 00 buckshot <sup>1</sup>
2d6	7	17-18	8mm autopistol <sup>2</sup>
2d6+1	8	19-20	.45 ACP <sup>1</sup> , 00 buckshot
2d6+2	9	21-23	9mm autopistol <sup>1</sup>
2d6+3	10	24-25	10mm autopistol
3d6	10.5	26-28	11mm autopistol
3d6+1	11.5	29-31	.44 Magnum <sup>1</sup> , 12ga slug <sup>1</sup>
3d6+2	12.5	32-35	12mm autopistol
3d6+3	13.5	36-39	12ga slug
4d6	14	40-42	
4d6+1	15	43-48	
4d6+2	16	49-54	5.56mm rifle <sup>1</sup>
4d6+3	17	55-69	7.62mm rifle <sup>1</sup>
5d6	17.5	60-65	5.56mm rifle
5d6+1	18.5	66-73	7.62mm rifle
5d6+2	19.5	74-83	
5d6+3	20.5	84-91	
6d6	21	92-99	
6d6+1	22	100-112	.50 cal machine gun <sup>1</sup>
6d6+2	23	113-127	.50 cal machine gun
6d6+3	24	128-139	
7d6	24.5	140-152	
7d6+1	25.5	153-172	20mm cannon <sup>1</sup>
7d6+2	26.5	173-194	20mm cannon
7d6+3	27.5	195-213	
8d6	28	214-233	
9d6	31.5	326-356	
10d6	35	484-545	Miltech RPG-A
11d6	38.5	739-832	Scorpion 16 Miss.
12d6	41	1000-1127	

<sup>1</sup>20th century round

<sup>2</sup>Non-standard Cyberpunk 2020 round

For upgrading weapons across a TL range, or using +P ammunition in a **Cyberpunk 2020** weapon, the table at the bottom of the page should help immensely. Just find the die type the weapon is at one TL, and then move up or down as many rows as needed. This will also help figure damage for 21st century versions of 20th century weapons.

**Example** - A 20th century weapon (TL11) doing 3d6 would do 3d6+1 if loaded with more powerful TL12 ammo.

**Armor layering**

Note that SP protection for layered armor is now roughly the same as the scale used in **3G<sup>3</sup>**. Doubling a thickness of armor in **3G<sup>3</sup>** doubles the AV, but when converted to **Cyberpunk 2020** terms, double the AV is only a 5-6SP increase.

**Example** - **3G<sup>3</sup>** DV40 is 4d6 of **Cyberpunk 2020** damage, with average damage of 14 points, while a DV80 is 5d6+2, with average damage of 19.5 points, or 5.5 points difference. An armor that stops a DV of 80 (5d6+2) is twice as thick as an armor that stops DV of 40 (4d6). Adding a pair of SP14 armors together (which individually stop around 4d6) would only get you an SP of 19 (which stops around 5d6+2).

**Explosives (optional)**

**Cyberpunk 2020** explosives are changed in the latest edition, and so are also adjusted in **3G<sup>3</sup>**. Explosives are rated in a damage per unit (.25kg to 1kg), a blast radius (usually the **3G<sup>3</sup>** TL/3 (round up)) and a multiplier based on the number of "units" used.

Explosives	TL factor	1kg	Notes
TL8 (Guncotton)	x.3	3d10	Can become unstable with time
TL9	x.5	3d10+3	
TL10 (TNT)	x.6	4d10	Generally stable, not moldable
TL11	x1.0	5d10	
TL12 (Plastique)	x4.1	7d10	Easily moldable, very safe
TL13 (C6)	x7.3	8d10	Requires explosive detonator

For conversions, blast DV converts just like any other type of DV, but damage is usually measured in d10 rather than d6. To match current **Cyberpunk 2020** numbers for explosives, you need to multiply the DV of the explosive by a **3G<sup>3</sup>** TL modifier.

**Example** - Ripperjack whips up a batch of TL12 explosives. In **3G<sup>3</sup>**, a kilogram of TL12 explosive has a DV of 201. For **Cyberpunk 2020**, you multiply this by x4.1 to get 825, which is converted using the normal formula to get an average **Cyberpunk 2020** damage of 38.9, or about 7d10 of damage.

**3G<sup>3</sup> TL**

**Cyberpunk 2020 Damage**

8	1/2d6	1d6-1	1/2d6+1	1d6	1/2d6+2	1d6+1	1d6+2	2d6-1	2d6	2d6+1	2d6+2	2d6+3	3d6	3d6+1	3d6+2	3d6+3
9	1d6-1	1d6	1/2d6+2	1/2d6+2	1d6+1	1d6+2	2d6-1	2d6-1	2d6	2d6+2	2d6+3	3d6	3d6	3d6+2	3d6+3	4d6
10	1/2d6+1	1/2d6+2	1/2d6+2	1d6+1	1d6+2	2d6-1	2d6-1	2d6	2d6+1	2d6+2	3d6	3d6+1	3d6+1	3d6+2	4d6	4d6+1
11	1d6	1d6+1	1d6+1	1d6+2	2d6-1	2d6-1	2d6	2d6+1	2d6+2	2d6+3	3d6	3d6+1	3d6+2	3d6+3	4d6+1	4d6+1
12	1/2d6+2	1d6+1	1d6+2	2d6-1	2d6-1	2d6	2d6+1	2d6+1	2d6+2	2d6+3	3d6+1	3d6+2	3d6+2	4d6	4d6+1	4d6+2

**3G<sup>3</sup> TL**

**Cyberpunk 2020 Damage**

8	4d6	4d6+1	4d6+2	4d6+3	5d6	5d6+1	5d6+2	5d6+3	6d6	6d6+1	6d6+2	6d6+3	7d6	7d6+1	7d6+2	7d6+3
9	4d6+1	4d6+2	4d6+3	5d6	5d6+1	5d6+2	5d6+3	6d6	6d6+1	6d6+2	6d6+3	7d6	7d6+1	7d6+2	7d6+3	8d6
10	4d6+1	4d6+2	5d6	5d6+1	5d6+1	5d6+2	6d6	6d6+1	6d6+1	6d6+2	7d6	7d6+1	7d6+1	7d6+2	7d6+3	8d6+1
11	4d6+2	4d6+3	5d6	5d6+1	5d6+2	5d6+3	6d6	6d6+1	6d6+2	6d6+3	7d6	7d6+1	7d6+2	7d6+3	8d6	8d6+1
12	4d6+2	5d6	5d6+1	5d6+2	5d6+3	6d6	6d6+1	6d6+2	6d6+2	7d6	7d6+1	7d6+2	7d6+2	8d6	8d6+1	8d6+2

# Cyberpunk 2020

## #Shots

This is the normal ammunition load of the weapon and for clipped weapons is usually followed by a +1 to show that an extra round can be held in the chamber.

## Rate of fire

The ROF of a **Cyberpunk 2020** weapon is based on the guidelines in the rules and the type of weapon. **Cyberpunk 2020** is based on 3 second turns, while **3G<sup>3</sup>** rate of fire is on 1 second increments. Normally, you would assume a simple tripling, but **Cyberpunk 2020** takes into account the fact that you are moving and being shot at while you are trying to use a weapon, and this tends to slow things down. In situations where you have no opposition and can simply let loose, triple the **3G<sup>3</sup>** rate of fire. Otherwise:

Weapon	Shots per turn
Semi-auto	3
Revolver (any type)	1
Bolt action, lever action, pump action	1
Autoburst	3 bursts of 3 or 2 bursts of 5
Autofire	2 seconds at <b>3G<sup>3</sup></b> rate

**Example** - A machine pistol which can fire 10 shots per second would have an ROF of 20 when fired full-auto, and an ROF of 3 if fired semi-auto.

## Reliability

Weapons in category I or II are "Very Reliable". Weapons in category III and IV are "Standard" and anything in category V and VI are "Unreliable". Keep track of the exact range it is in, as poor handling may move a weapon down a notch or two of reliability.

**Note** - Many 20th century weapons are more reliable than their 21st century counterparts using this scheme, odd when you consider that people depend on them more to save their lives. Note that many people will be using high-powered ammunition to get the most from their weapons, and this will tend to drop the reliability by a level (a class I weapon will go to class III if using +P+ ammunition, for instance, or a TL10 weapon using TL12 ammo).

## Range

The **Cyberpunk 2020** Range stat is the "full range" of the weapon, where the "to hit" number is 25. For aiming RC, this converts as follows:

Aiming RC	Cyberpunk 2020 Range
1	25m
2	50m
3	100m
4	200m
5	400m
6	800m
7	1600m
8	3200m

Adjustments	Amount
Each point of IA over/under base	+25%/-25%

All ranges round to the nearest 5 meters. These don't exactly match the **Cyberpunk 2020** ranges. For instance, even the cheap "polymer one-shots" have a Range of 50m in **Cyberpunk 2020**, just as good as heavy pistols like the Armalite 44. This new scale spreads things out a little more. Remember that only vehicle weapons have an aiming RC of 5+. This range is a "direct fire" range. Weapons with indirect fire capability go much further (usually up to 10 times as far). This requires aiming at a spot rather than a moving target, and the attack will take at least a turn to get there.

For damage RC, this weapon function is not covered in **Cyberpunk 2020**. As an optional rule, find the "Range" on the above table for the damage RC. Subtract 2 points from the rolled damage at this range and each multiple of it.

**Example** - A 5.56mm round has a Damage RC of 3, so it loses 2 points of damage every 100 meters.

## Cost

This is just the **3G<sup>3</sup>** cost of the weapon, and can be measured in any currency desired, or multiplied by a fixed amount to fit your campaign.

## Mass

This is the loaded mass of the weapon in kilograms, followed by the mass of any clip or detachable ammunition supply.

## Initiative (optional)

The **3G<sup>3</sup>** Initiative of your weapon can optionally be added to your REF stat for determining turn order, unless you are on the good side of an ambush situation. People with unwieldy weapons tend to act and react slower, unless they already have their weapon aimed and finger on the trigger.

## SP (optional)

**Cyberpunk 2020** does not have stats for breaking things like weapons. Multiply the AV of the weapon by 2, pretend it is a DV, and see what the "average damage" for it is. This number (rounding up) is the SP of the weapon. So, a weapon with an AV of 11 would have an SP rating of 9. Double this SP vs. area effect attacks like explosives.

## Body (optional)

The BP of a weapon converts directly into an "average damage" (don't multiply by 2), so a weapon with 11BP would have 4 Body. Weapons will always have at least 2 Body. Each time the weapon takes internal damage (its SP is exceeded), the weapon has to make a "Death Save" vs. the amount of Body it has left.

**Example** - A weapon with 4 Body that took 1 point of internal damage would have to roll a 3 or less to remain functional. Failure means the poor thing gives up the ghost after throwing itself in front of a bullet to save you. Any damage that exceeds the SP and Body of the weapon continues on its merry way, striking the character with anything that remains.

Now you know *exactly* how much damage it takes to shoot that gun right out of your enemy's hands...

### Shotguns (optional)

**Cyberpunk 2020** shotguns can only be loaded with 00 Buckshot, which does 4d6 damage. If using the revised damage (2d6+1 for 21st century models), assume you get one hit on the target for each point you make your roll by, and adjacent targets in the pattern subtract 1 "hit" for each meter of lateral distance from the primary target. Shotguns using slugs are treated like any other rifle, and may have an increased Range stat for damage purposes.

**Example** - Shooting a target at Long range, you make the roll by 2, so the thug gets peppered with 3 hits, one for making the roll, plus two more for making it by 2. A target 2 meters to the side, but in Medium range, will take a single hit, since he is still in the pattern, and the side-to-side distance subtracts 2 hits from the total.

### Guided weapons (optional)

Smart weapons and add-ons like laser sights will add to your chance to hit when used properly. The bonus is equal to 1/4 the **3G<sup>3</sup>** bonus to hit, rounding fractions down. So, a +4 sensor array attached to your weapon is a +1 to hit. Bonuses do combine if multiple types apply, so a +4 scanner which provides target acquisition for a +4 homing round gives a total of +2 to hit, and a +2 scanner and a +2 round would give a +1, although separately, they would have no effect. All electronics are TL12 in **Cyberpunk 2020**, although experimental TL13+ items might be possible to obtain, and if any technology is ahead of the curve, it will be in the realm of electronics.

Self-guided weapons have a skill of their bonus, and use any combat modifiers that would normally apply to the shot.

### Special ammo (optional)

Armor-piercing ammo uses the normal **Cyberpunk 2020** rules. Armor SP is halved before applying damage, and the damage done to the person after armor penetration is also halved. HEAT rounds or other shaped charges do not halve damage done after armor penetration.

Exploding, hollow-point or increased tissue disruption rounds use the normal converted DV, but subtract 1 point from the total for each die before comparing to armor SP. Any damage that gets through armor is increased by 2 points per die in the attack, with a maximum increase of double the amount that originally penetrated.

**Example** - A DV68 round has a **Cyberpunk 2020** damage of 5d6+1. If armor-piercing, the damage stays at 5d6+1, but armor SP is halved before you apply it, and only half of what gets through affects the character. If it were a hollow-point round, the damage would be 5d6-4, but you could add up to 10 to any damage that got through (2 points per die). Against unarmored targets, hollow-point rounds generally do 1 extra point of damage per die in the attack.

Other types of special ammunition may increase the Range stat of the weapon, or increase the DV by using discarding sabots, shaped charges, etc. Shaped charge rounds can be extremely nasty, but at TL12 cannot be made reliable at a size of less than 13.5mm.

The **More Guns!** supplement assumes the DV is based on the type of ammunition in the weapon description. HEAT rounds are automatically considered armor-piercing.

### Grenades (optional)

Grenades do 7d6 damage in **Cyberpunk 2020**, which is serious "ouch!" territory. It is actually more appropriate in **3G<sup>3</sup>** to assign each fragment a base DV, which gets converted to **Cyberpunk 2020** d6 of damage, probably somewhere between 1d6+2 and 2d6 per fragment. The number of fragments is as listed in **3G<sup>3</sup>** for minimum range, and is quartered every time you double the range. Rather than rolling for hundreds of hits, simply add 1d6 of damage for 2 hits, and each time you double it (round nearest), with a maximum of +6d6.

Granted, figuring this may be too cumbersome for a fast-moving firefight. So, the stats for a fragmentation weapon will simply give you the bonus dice for that weapon at a range of 2m, and drop it by 2d6 each time you double the range (round up). Optionally, add 2d6 if the grenade lands right next to a character (ouch!).

Fragments	2 meters	3-4 meters	5-8 meters	9-16 meters
1-149	+0d6	-2d6	-4d6	-6d6
150-299	+1d6	-1d6	-3d6	-5d6
300-599	+2d6	+0d6	-2d6	-4d6
600-1199	+3d6	+1d6	-1d6	-3d6
1200-2399	+4d6	+2d6	+0d6	-2d6
2400-4799	+5d6	+3d6	+1d6	-1d6
4800+	+6d6	+4d6	+2d6	+0d6

**Example** - You've got a grenade with a frag rating of 2d6(+5). So, at 2m, you do 7d6. At 3-4m, you do 5d6, at 5-8m you do 3d6, at 9-16m you do 1d6, and nothing after that.

The damage the character takes should be based on their average armor, with actual location of the impairment leaning towards the areas with the least protection.

# Cyberpunk 2020

## Lasers

Laser tech in **Cyberpunk 2020** is crude. In **3G<sup>3</sup>** terms, they do not have high-energy superconductors. The only pulsed power storage available is TL12 capacitor banks, which make lasers barely practical. **Cyberpunk 2020** does not provide for portable batteries to recharge these, but there is no reason why they couldn't be included. Note that in **Cyberpunk 2020**, all lasers have adjustable power levels, since you can vary the number of dice used, and any laser built in **3G<sup>3</sup>** must be able to handle the maximum DV you intend to use. That is, if you make a 5d6 laser, you can't dump 10d6 worth of energy into it and expect to have anything but a cloud of toxic smoke when you are done. Whether or not the laser will actually fire is up to the GM. Another point is that energy out is not a linear function of energy in. Each laser "clip" will have a given number of energy units, or EU, which are in convenient 500J increments. For a 5mm laser, the damage progression would look like this:

EU burned	3G <sup>3</sup> DV	Cyberpunk 2020 damage
1	16	2d6
2	22	2d6+2
3	27	3d6
4	32	3d6+1
5	36	3d6+3
6	39	4d6
8	45	4d6+1
11	52	4d6+2
14	59	4d6+3
17	65	5d6
20	71	5d6+1

As you can see, a laser can be good for a number of low damage shots, but when you really need to pack a punch, expect to drain your clip almost instantly. The only real use for lasers in **Cyberpunk 2020** is that they are silent, untraceable, and optionally get a bonus to hit due to being energy weapons. At GM option, TL13 superconductors are available, but only as parts of experimental weapons, and never as a commercial product.

## Electrothermal enhancement

This is available as an option in both **3G<sup>3</sup>** and **Cyberpunk 2020** designs. The **Cyberpunk 2020** rules allow a greater damage bonus. In **3G<sup>3</sup>**, the maximum energy increase available is about 50%, which translates into a 22% gain in DV, or about 2 extra pips of damage, regardless of the initial energy of the weapon. This is a slight revision from **More Guns!** and 1st printing **3G<sup>3</sup>**.

## Railguns

Railguns in **Cyberpunk 2020** are just out of the experimental stage as hand weapons, and are available as vehicle weapons, using either TL12 or early TL13 technology.

## Particle beams

These simply do not exist in the **Cyberpunk 2020** universe. If you want, you can substitute the design rules for making your own maser weapons, although the efficiency of converting DV to d6 burn damage is up to you. The only example in the rules is flashlight-sized, and does 1d6, which compares to a normal DV-to-damage conversion, as per the previous table. The inherent inefficiency and power-guzzling nature of these weapons should keep them from getting out of hand at TL12. Assume that shielding against masers works on any hit that does not penetrate the armor of the shielded part.

## Melee weapons

Melee weapons are not a big part of the **Cyberpunk 2020** universe, but can be converted.

## Type

All melee weapons use Melee skill (MEL), unless you have customized skills for each weapon type.

## Accuracy

Melee weapons use their IA-1 as their Weapon Accuracy (WA) stat.

## Concealability

As for ranged weapons.

## Availability

Common(C) for street weapons, Poor(P) for archaic melee weapons.

## Damage

Convert as for ranged weapons, but add 5 to the DV first. Use the best damage type (cut, thrust, etc.) the weapon can do.

## Reliability

Melee weapons are always Very Reliable (VR).

## Range

For thrown weapons, their normal throw range. For melee weapons, their length in meters, rounding up.

## Cost, Mass, Initiative, SP, Body

As for ranged weapons. Average any multiple initiative types, and round towards a better initiative.



# BATTLELORDS OF THE 23<sup>RD</sup> CENTURY

## Basics

**Battlelords of the 23rd Century** (referred to hereafter as **BL23c**) is a futuristic ultraviolet role-playing system set in a universe that takes cyberpunk ideas to their natural extreme. Exponential technology growth has led to galaxy-wide expansion, with numerous alien contacts and conflicts. Giant corporations own virtually everything, and compete with each other for markets on all fronts, including corporate armies and use of freelance mercenary outfits.

**BL23c** is not the most realistic of systems, but it is *very* weapon heavy, and thus a natural for what **3G<sup>3</sup>** was designed to do. At the "human" level of things, **BL23c** does a reasonable job of portraying the effects of weapons, armor and people, and **3G<sup>3</sup>** will work well with it. At the upper end of the scale, you can design weapons of various types consistent with those already available, and new ones to surprise people with. These conversion notes will not be a *perfect* match, but do a pretty good job overall.

## Type

This is the common name of the weapon, and is followed by the caliber, for purposes of reference and ammunition exchange between weapons.

## Tech Level

This is the Tech Level of the weapon, and is based on the following scale:

3G <sup>3</sup> TL	BL23c TL	Example
1-2	0	Bows, slings
3-8	1	Crossbows to Gatlings
9-10	2	Thompson SMG
11-12	3	M-16, Steyr AUG, H&K G-11
13-15	4	?
16-18	5	?
19	6	?

It seems that most of the **BL23c** universe is around the upper end of TL5 on their scale, with the capitals of the major races with TL6, and the lesser interstellar races at perhaps TL4. Obviously, weapons of considerable power can be designed. TL7 weapons such as implosion torpedoes and attractor/repressors aren't covered by these conversion notes, nor are neuro cannons, meson cannon or any other really strange weapons.

It would be wise for would-be battlelords not to discount the lethal potential of low-tech weapons. Your armor salesman may say that heavy armor is proof against all archaic projectile weapons, but they have never been hit with a 32-pounder, either. That is, a 32 *pound* chunk of iron moving at supersonic velocity (oof!). Sure, it might not actually *penetrate* your armor (after all, it only does 10-60 damage), but it *will* rattle your head against the inside of your helmet hard enough to turn your brains to oatmeal...

## Range Brackets

**BL23c** uses a series of range brackets for hand-held and vehicle-mounted weaponry. This will give the base percentage chance to strike a target in that range bracket. This percentage will be based on the aiming RC of the weapon, and modified by its Inherent Accuracy and damage RC.

		Range Brackets										
<b>SAMS</b>		1	2	3	4	5	6	7				7
<b>Anti-tank</b>		1	2	3	4	5	6	7	8			
<b>Heavy wpn</b>		1	2	3	4							
<b>Hand-held</b>		1	2	3	4	5	6	7	8			
Aim RC1	70	55	35	05	-30	-	-	-	-	-	-	-
Aim RC2	70	60	50	30	05	-25	-	-	-	-	-	-
Aim RC3	75	65	55	35	15	-05	-30	-	-	-	-	-
Aim RC4	80	70	60	45	30	10	-10	-30	-	-	-	-
Aim RC5	100	90	80	70	55	30	05	-15	-30	-	-	-
Aim RC6	100	100	95	90	80	60	40	20	00	-30	-	-
Aim RC7	100	100	100	95	85	70	55	35	10	-10	-30	-
Aim RC8	100	100	100	100	90	80	70	50	20	00	-10	-30

## Modifiers

IA -2	-05	-05	-10	-10	-15	-15	-15	-15	-20	-20	-20	-20
IA -1	-00	-00	-05	-05	-05	-05	-05	-05	-10	-10	-10	-10
IA +1	+05	+05	+05	+05	+05	+05	+05	+10	+10	+10	+10	+10
IA +2	+05	+05	+05	+05	+10	+10	+10	+10	+15	+15	+15	+15
<b>BL23c TL1</b>	-00	-00	-05	-10	-15	-20	-25	-30	-35	-40	-45	-50
Dam RC1	+00	+00	+00	+00	-05	-20	-50	-90	-90	-90	-90	-90
Dam RC2	+00	+00	+00	+00	+00	-05	-20	-50	-90	-90	-90	-90
Dam RC3	+00	+00	+00	+00	+00	+00	-05	-20	-50	-90	-90	-90
Dam RC4	+00	+00	+00	+00	+00	+00	+00	-05	-20	-50	-90	-90
Dam RC5	+00	+00	+00	+00	+00	+00	+00	+00	-05	-20	-50	-90
Dam RC6	+00	+00	+00	+00	+00	+00	+00	+00	+00	-05	-20	-50
Dam RC7	+00	+00	+00	+00	+00	+00	+00	+00	+00	+00	-05	-20
Dam RC8	+00	+00	+00	+00	+00	+00	+00	+00	+00	+00	+00	-05
Gatling wpn.	+20	+10	+00	-10	-20	-30	-40	-50	-60	-70	-80	-90
Laser	+00	+10	+15	+20	+25	+30	+30	+30	+30	+30	+30	+30
Maser	+10	+20	+20	+20	+20	+20	+20	+20	+20	+20	+20	+20
Pulse wpn	+05	-10	-30	-30	-30	-30	-30	-30	-30	-30	-30	-30
Metal gun	+10	+05	+00	-30	-50	-60	-70	-80	-90	-90	-90	-90
Disruptor	+10	-20	-30	-40	-50	-60	-70	-80	-90	-90	-90	-90
Disintigr.	+00	-10	-30	-40	-50	-60	-70	-80	-90	-90	-90	-90
Omega	-05	-10	-20	-30	-40	-50	-60	-70	-80	-90	-90	-90
Th.bolt	+40	+10	-20	-40	-60	-80	-90	-90	-90	-90	-90	-90
Sonic	+05	-10	-40	-60	-80	-90	-90	-90	-90	-90	-90	-90

If the range brackets have a "-", or the final adjusted modifier ever gets to *worse* than -30 for a particular bracket, the weapon cannot be used at that range, and that bracket should be marked with a "-". Exception: Omega weapons, Metal Guns and Disintegrators can go to -50 in a range bracket.

**Example** - A high quality 9mm pistol is in **3G<sup>3</sup>** terms, a **BL23c** TL3 weapon with an aiming RC of 2, a damage RC of 3, and an IA of 2 (+1 normal). This gives it a range bracket profile of:

<b>Hand-held</b>	1	2	3	4	5	6	7	8				
Aim RC2	70	60	50	30	05	-25	-	-	-	-	-	-
IA +1	+05	+05	+05	+05	+05	+05	+05	+10	+10	+10	+10	+10
Dam RC3	+00	+00	+00	+00	+00	+00	-05	-20	-50	-90	-90	-90
Final	75	65	55	35	10	-20	-	-	-	-	-	-
in <b>BL23c</b>	78	68	60	35	25	-15	-	-	-	-	-	-

# Battlelords of the 23rd Century

**Example** - Someone designs a gatling laser carbine with an aiming RC of 3, damage RC of 4, and an IA of 3 (+1 normal):

Hand-held	1	2	3	4	5	6	7	8				
Aim RC3	75	65	55	35	15	-05	-30	-	-	-	-	-
IA +1	+05	+05	+05	+05	+05	+05	+05	+10	+10	+10	+10	+10
Dam RC4	+00	+00	+00	+00	+00	+00	+00	-05	-20	-50	-90	-90
Gatling wpn.	+20	+10	+00	-10	-20	-30	-40	-50	-60	-70	-80	-90
Laser	+00	+10	+15	+20	+25	+30	+30	+30	+30	+30	+30	+30
Final	100	90	75	50	25	00	-	-	-	-	-	-

The preceding table will let you design good range brackets for most classes of weapons used in **BL23c**.

## Malfunction Number

All weapons will have a percentage chance to malfunction when used, depending on their quality and technology. Check the following matrix to get the Malfunction Number:

	Archaic	Laser	Maser	Pulse wpn.	Omega wpn.	Disruptor	Disintegrator	Gauss	Metal	Thunderbolt	Sonic
<b>3G<sup>3</sup> Rel. I</b>	99	-	-	-	-	-	-	99	-	-	-
<b>3G<sup>3</sup> Rel. II</b>	98	94	99	96	97	98	98	98	98	97	99
<b>3G<sup>3</sup> Rel. III</b>	97	-	-	-	-	-	-	97	-	-	-
<b>3G<sup>3</sup> Rel. IV</b>	95	-	-	-	-	-	-	95	-	-	-
<b>3G<sup>3</sup> Rel. V</b>	93	-	-	-	-	-	-	93	-	-	-
<b>3G<sup>3</sup> Rel. VI</b>	90	-	-	-	-	-	-	90	-	-	-
<b>IA-2</b>	+00	-06	-04	-12	-06	-08	-10	-00	-04	-03	-03
<b>IA-1</b>	+00	-03	-02	-08	-03	-04	-05	-00	-02	-01	-01
<b>IA+1</b>	+01	+03	+01	+01	+01	+01	+01	+01	+01	+01	+01
<b>IA+2</b>	+02	+06	+01	+02	+03	+02	+02	+02	+02	+03	+01
<b>Autofire</b>	-02	+00	-	+00	+00	-	-	+00	-	-	-

Naturally, the adjusted malfunction number cannot exceed 100% reliability.

## System Shock

Weapons in **BL23c** have a System Shock number, which corresponds roughly to its reliability and its **3G<sup>3</sup>** Armor Value. Weapons that have a lower value will have lower System Shock numbers than heavier, more durable models.

	Archaic	Laser	Maser	Pulse wpn.	Omega wpn.	Disruptor	Disintegrator	Gauss	Metal	Thunderbolt	Sonic
<b>3G<sup>3</sup> Rel. I</b>	100	97	99	90	90	85	98	97	97	96	85
<b>3G<sup>3</sup> Rel. II</b>	99	94	97	88	88	80	97	95	95	94	80
<b>3G<sup>3</sup> Rel. III</b>	98	89	93	75	84	75	85	93	93	92	75
<b>3G<sup>3</sup> Rel. IV</b>	95	80	87	65	80	65	73	90	90	89	65
<b>3G<sup>3</sup> Rel. V</b>	90	60	81	55	76	50	60	85	85	85	55
<b>3G<sup>3</sup> Rel. VI</b>	80	40	75	45	72	35	45	80	80	75	45
<b>AV 1-4</b>	-03	-03	-05	-05	-05	-05	-05	-03	-03	-06	-05
<b>AV 5-8</b>	+00	+00	+00	+00	+00	+00	+00	+00	+00	+00	+00
<b>AV 9-12</b>	+01	+01	+01	+02	+02	+01	+01	+01	+01	+01	+01
<b>AV 13-16</b>	+03	+04	+02	+04	+04	+02	+02	+02	+02	+02	+02
<b>AV 17-20</b>	+05	+07	+05	+06	+06	+04	+04	+03	+03	+03	+04
<b>AV 20+</b>	+07	+10	+08	+08	+08	+06	+06	+05	+05	+04	+06

**Note** - Company reputation and technical (in)competence may be counted as one or more levels of (un)reliability.

As with Malfunction Numbers, the System Shock number cannot exceed 100%. With Malfunction numbers, reduced reliability for many weapons is taken into account in the IA modifier, since decreased IA automatically drops reliability. For System Shock, the changes from reduced IA are applied to reliability directly, and increased or decreased Armor Value from cost is figured from the final AV of the weapon.

**Example** - Let's say you design a Thunderbolt weapon. These are energy weapons with a default **3G<sup>3</sup>** Reliability Class of II. You spend a bit less money to make it affordable, which drops the IA to a point below normal, but without affecting the mass. This means you start with a Malfunction Chance of 97, -01 for a point of IA below normal, for an adjusted value of 96. If the final weapon has a **3G<sup>3</sup>** AV of 11, it will have a base System Shock number of 92 (because the reduced cost made the **3G<sup>3</sup>** Reliability Class a III). This is increased by +01 because of the Armor Value, for a final System Shock number of 93.

## Rate of Fire

The ROF stat in **BL23c** is pretty easy to figure out. Semi-auto weapons have an ROF of 1. Weapons with autoburst capability use their burst size as the ROF. Full-auto weapons use their normal ROF (shots fired per second), except for gatling weapons, which use a third (round down) their actual ROF, because the extra rounds are taken into account in the bonus to hit at short range.

## Q

Or **Quantity**. This is the size of the clip or power pack. A "+1" indicates that the weapon can carry an extra round in the chamber, and usually only applies to archaic weapons.

## Cost

This is difficult to get a good fix on, but there are a few overall guidelines. First, ignore the x2.0 cost multiple for pistols in **3G<sup>3</sup>**. Second, there are some overall cost modifiers that will apply to all weapons:

Experimental weapons	50x normal cost
The latest thing	20x normal cost
Current issue equipment	10x normal cost
Surplus issue ( <b>BL23c</b> TL4)	5x normal cost
Really old stuff ( <b>BL23c</b> TL3)	2x normal cost

After this, there are some modifiers for weapons type:

Archaic weapons	1x normal <b>3G<sup>3</sup></b> cost
Lasers	1x normal <b>3G<sup>3</sup></b> cost
Masers	10x normal <b>3G<sup>3</sup></b> cost
Pulse weapons	1x normal <b>3G<sup>3</sup></b> cost
Omega weapons	2x normal <b>3G<sup>3</sup></b> cost
Disruptors	1x normal <b>3G<sup>3</sup></b> cost
Disintegrators	1x normal <b>3G<sup>3</sup></b> cost
Gauss	4x normal <b>3G<sup>3</sup></b> cost
Metal guns	10x normal <b>3G<sup>3</sup></b> cost
Thunderbolts	2x normal <b>3G<sup>3</sup></b> cost
Sonics	2x normal <b>3G<sup>3</sup></b> cost

**Example** - A surplus issue gauss weapon would have a cost of 20x the **3G<sup>3</sup>** designed price. A really old archaic weapon design would be 2x the **3G<sup>3</sup>** designed price, and an experimental omega weapon would be 100x the **3G<sup>3</sup>** designed price.

## Damage

Ah, damage. The stat most near and dear to any **BL23c** character's heart (one way or the other). Damage converts from **3G<sup>3</sup>** to an *average* amount of **BL23c** damage. How the Battlemaster turns this into an actual dice spread is up to them, but we recommend using multiples of d6, d8 and d10, with bonuses to dice as appropriate. For instance, a range of 1-6 is obviously 1d6, and 2-7 is a roll of 1d6+1.

Damage from **3G<sup>3</sup>** converts to the **BL23c** game system via the equation:

$$\text{BL23c average damage} = (3\text{G}^3 \text{ DV})^{-25} + 3\text{G}^3 \text{ DV}/10 \text{ (round down)}$$

Round down to .5 if appropriate to get a good dice match. The table below will list some general conversions, comparison to modern weapons (**3G<sup>3</sup>** TL11-12), and suggested **BL23c** damage ranges.

3G <sup>3</sup> DV	20th cent. example	BL23c average	Suggested
5	Knife	2	1-3 (1/2d6)
12	.25 cal pistol	3	2-4 (1/2d6+1)
16	.22 cal rifle	3.5	1-6 (1d6)
20	9mm, .45 cal pistol	4	2-6 (1d6)
24	.357 Mag. pistol	4.5	2-7 (1d6+1)
27	.44 Mag. pistol	5	2-8 (1d8)
36	12ga slug	6	1-11 (2d6-1)
45	5.56mm rifle (M-16)	7	2-12 (2d6)
53	7.62mm rifle (H&K G3)	8	3-13 (2d6+1)
62	6mm hunting rifle	9	2-16 (2d8)
71	.300 Mag. sniper rifle	10	3-17 (2d8+1)
85	Elephant rifle	11.5	4-19 (3d6+1)
108	.50 cal machine gun	14	4-24 (4d6)
141		17.5	5-30 (5d6)
174	20mm cannon	21	6-36 (6d6)
289	30mm cannon	33	6-60 (6d10)
503	75mm cannon	55	8-80 (8d10)
945	LAW rocket	100	1HP
1440	RPG-7 rocket	150	1.5HP
1930	105mm cannon	200	2HP (1/2d6)
2930	120mm cannon	300	2-4HP (1/2d6+1)
3430		350	1-6HP (1d6)
3930		400	2-6HP (1d6)
4420		450	2-7HP (1d6+1)
4920	Heavy anti-tank rocket	500	2-8HP (1d8)
5920		600	1-11HP (2d6-1)
6910		700	2-12HP (2d6)
7910		800	3-13HP (2d6+1)
8910		900	2-16HP (2d8)
9900		1000	3-17HP (2d8+1)
13900		1400	4-24HP (4d6)
17400		1750	5-30HP (5d6)
20900		2100	6-36HP (6d6)
32900		3300	6-60HP (6d10)
54900		5500	8-80HP (8d10)
99900		10000	10-100HP (10d10)

As you can see, the advances in technology make really hideously large damages possible. Now, all you have to do is figure out how to use the system to get those damages.

## Archaic Hand Weapons

Those that have range are converted using the tables for archaic ranged weapons. Purely melee weapons have a few additional stats:

**P** - This is the percentage chance for the weapon to parry an attack. Base it on the following table.

Size	Length								
	1	2	3	4	5	6	7	8	9+
VS	05	15	25	35	40	45	35	30	25
S	07	17	27	37	45	43	32	25	15
M	10	20	30	40	50	40	30	20	10

## Modifiers

IA-1	-01	-02	-03	-04	-05	-04	-03	-02	-01
IA+1	+01	+02	+03	+04	+05	+04	+03	+02	+01
Flexible	-02	-04	-07	-10	-10	-10	-10	-10	-10

**Example** - A katana in **3G<sup>3</sup>** is a VS/7 weapon with IA of +1 normal. This means it has a parry chance of 38. A flail is a VS/11 weapon with normal IA, so it has a parry chance of 15.

**ROF** - The ROF for a melee weapon is how fast you can swing it. Weapons who best Initiative is -1 or better have an ROF of 1. Those with Initiatives of -2 to -3 have an ROF of 1/2, Initiatives from -4 to -5 have ROF of 1/3, from -6 to -7 is ROF 1/4 and anything with an Initiative of -8 or worse is ROF 1/6.

**IR** - The Integrity Reduction for a melee weapon is its average damage before any Strength bonuses, with a minimum of 1.

## Explosives

Explosives and fragmentation weapons use the same DV to average damage scale as other weapons. The number of fragments and dropoff of concussive damage may vary, though.

3G <sup>3</sup> fragments	BL23c fragment hits
<100	3
100-200	4
201-400	5
401-800	6
801-1600	7
1601-3200	8
3201-6400	9
6401+	10

For each 100 points of **3G<sup>3</sup>** explosive damage (round down) and every time this is doubled, add 1 meter to each range at which **BL23c** explosive effects are dropped. For instance, if an explosion had a DV of 100, concussive effects would drop at 2 meters, 4 meters and 6 meters, instead of at 1, 2 and 3 meters.

# Battlelords of the 23rd Century

## Archaic Powder Weapons

These are converted using the stats and tables previously listed. Effects of special ammunition are handled as in **BL23c**. Note that normal **3G<sup>3</sup>** Damage Values are used for the conversion, but all **BL23c** archaic weapons are assumed to be firing armor-piercing ammunition. *Do not* adjust the **3G<sup>3</sup>** figures to take armor-piercing ammo into account. Effects of special archaic ammunition are as per the **BL23c** rules. Archaic weapon technology ranges from really old to surplus issue (**BL23c** TL3-4), but remakes of these models are common due to the market on TL3 worlds and the easy availability of the plans and programs needed for automated manufacture.

## Lasers

Lasers are converted using the basic tables provided, and no adjustments are needed for damage. Impact lasers are treated as adjustable, variable frequency lasers for purposes of cost and weight, to take into account their advantages. These advantages must be bought again if those features are required, e.g. An impact laser with variable damage must have it twice, once as part of the impact laser package, and once for variable damage. Laser technology ranges from surplus issue (**BL23c** TL4) up to experimental models (**BL23c** upper TL6 to TL7), with corresponding variance in cost and capability. Bargain basement lasers are *usually* surplus issue technology (**BL23c** TL4) and almost always have one level of reduced Inherent Accuracy (half cost and Inherent Accuracy (round down), and reliability goes from Class II to Class III).

**Note** - Many energy weapons use a standardized "Juice Box" as the power pack. These would probably be a **BL23c** TL5 item, and in **3G<sup>3</sup>** terms, would hold the following amounts of energy in *non-rechargeable* superconductor loops (divide energy by 4 for rechargeable versions):

---

<b>Pistol Juice Box</b>	.5kg (Encumbrance: 1)	341kJ
<b>Rifle Juice Box</b>	1.5kg (Encumbrance: 3)	1.02mJ
<b>Heavy Weapon Juice Box</b>	5.0kg (Encumbrance: 10)	3.41mJ

---

If the energy figures don't mean much to you, 1.0mJ is enough to run a carbide tipped 2 horsepower power drill for over 11 minutes. Divide that by 20 shots from a rifle, and each shot is the equivalent of someone trying to drill a hole in your armor for 30 seconds...

A Ms. Fusion could be designed as a battery with a total capacity of 8.5mJ (output of 85kJ per second), or just treated as in **BL23c** like a small power plant that runs more or less forever. Increase output to 10.0mJ (100kJ per second) if the unit is **BL23c** TL6.

## Masers

Masers are designed as lasers in **3G<sup>3</sup>** terms, and have no adjustments aside from their special range brackets, MN and SS numbers. Maser technology ranges from a few surplus issue (**BL23c** TL4) up to state of the art (**BL23c** upper TL6), with corresponding variance in cost and capability.

## Pulse Cannons

Pulse weapons include static pistols and pulse cannons, both of which are designed to hit the target with superheated plasma. These are designed as **3G<sup>3</sup>** particle beam weapons. The fact that **3G<sup>3</sup>** particle beams are heavy, expensive power hogs means that one special adjustment is needed. Assume fusion storage packs in **BL23c** have 10 times the efficiency of **3G<sup>3</sup>** superconductors, and that raw fuel (before it is turned into plasma) is counted as batteries of similar efficiency. We recommend that such an external fusion pack have a minimum mass of 2kg (Encumbrance of 4). The fusion pack can be represented by a battery or superconductor bank, depending on the rate of fire desired. The stored plasma units of static pistols are counted as superconductor loops of *regular* **3G<sup>3</sup>** efficiency. Pulse weapon technology ranges from cheap knockoffs of surplus issue (**BL23c** TL4) up to experimental models (**BL23c** upper TL6 to TL7), with corresponding variance in cost, capability and lifetime of the operator.

## Omega Cannons

Omega weapons have their own special game effects in **BL23c**, but are designed in **3G<sup>3</sup>** as particle beam weapons, with the limitation that the **3G<sup>3</sup>** DV of the weapon has to be at least 100 for the weapon to qualify as an Omega-type weapon. Omega weapons use standard **3G<sup>3</sup>** efficiency for power storage. In addition, small Omega weapons are less energy efficient. Omega weapons of 10,000J or less have 5x power consumption. This multiple is reduced by 1 each time output energy is doubled (20,000J is 4x power, 40,000J is 3x power, and so on, down to 1x power consumption for 160,000J models and up). Omega weapon technology ranges from standard issue (**BL23c** TL5) up to experimental models (**BL23c** upper TL6 to TL7), with corresponding variance in cost and capability.

## Disruptors & Disintegrators

These are variations on the same weapon principle. Disruptors use replaceable energy clips, while Disintegrators use backpack-mounted power supplies. These are also designed as particle beam weapons, but have their own range brackets, MN, SS numbers and particular game effects. The listed damage of a disruptor or disintegrator is vs. hard targets or inanimate objects. Against soft targets or body tissue, damage is doubled. Disruptor technology ranges from standard issue (**BL23c** TL5) up to experimental models (**BL23c** upper TL6 to TL7), with corresponding variance in cost and capability.

## Gauss Weapons

These are designed using the **3G<sup>3</sup>** railgun rules, and require no modifications. Mag guns are gauss weapons firing large, specialized projectiles. These projectiles have costs and game effects as per **BL23c**, but in **3G<sup>3</sup>** terms, they are assumed to be 40mm projectiles with an sg of 3 (mass of about 400g), and all **3G<sup>3</sup>** weapon parameters should be based on this. Note that it is possible to fire Mag Gun projectiles from virtually *any* type of projectile launcher, even archaic ones like crossbows if you can find a way to arm the warheads on launch...

Carousel guns are designed as gauss weapons, but may buy a “folded” accelerator (once) like a laser or particle beam in **3G<sup>3</sup>**, with the normal cost for this option. The carousel gun must also have adjustable output, and the weapon can fire projectiles with variable damage as per the **BL23c** rules for carousel guns. The default projectile for gauss weapons is assumed to be the armor-piercing projectile.

Gauss weapon technology ranges from surplus issue (**BL23c** TL4) up to experimental models (**BL23c** upper TL6 to TL7), with corresponding variance in cost and capability. Lower-tech models may not have the full range of projectile options.

### Metal Guns

These weapons fire a pulse which is designed to destroy the molecular structure of metallic objects. For **BL23c** purposes, design them as **3G<sup>3</sup>** continuous beam lasers. No other modifications are needed. Note that all metal guns have an ROF of 1/3, which reflects having to engage a target long enough for the disruption field to have an effect. Metal gun weapon technology ranges from standard issue (**BL23c** TL5) up to experimental models (**BL23c** upper TL6 to TL7), with corresponding variance in cost and capability.

### Thunderbolts

These are static discharge weapons, dumping a massive arc of electricity into whatever they are aimed at. These are designed as a **3G<sup>3</sup>** laser/stunner combination, noting that the laser part of the weapon has to have a **3G<sup>3</sup>** DV of 10% of the **3G<sup>3</sup>** DV of the electrical discharge pulse. The effects of this weapon on equipment and people are as per the normal **BL23c** rules, and thunderbolts have a maximum ROF of 1. Thunderbolt technology ranges from surplus issue (**BL23c** TL4) up to experimental models (**BL23c** upper TL6 to TL7), with corresponding variance in cost and capability.

### Sonic Disruptors

Sonic disruptors do no penetrating or armor damage in **BL23c**, so are more difficult to quantify. Treat a sonic disruptor as a **3G<sup>3</sup>** laser/stunner combination, with the same limits as Thunderbolt generators. However, the minimum discharge energy to get a sonic disruption effect is 5000J. Each time you double this discharge energy, you may subtract -03% from the SMR vs. sonic attacks. Sonic disruptors have a maximum ROF of 1.

**Example** - A sonic disruptor with a 20,000J discharge (i.e. putting on a pair of 20,000 watt headphones!) will be a -06% from the sonic SMR. Even if you make the saving throw, you *will* have a ringing in your ears...

Sonic disruptor technology ranges from surplus issue (**BL23c** TL4) up to standard issue models (**BL23c** TL6), with corresponding variance in cost and capability.

### Weapon options

**BL23c** weapons as previously converted just get you the weapon, with no frills attached. Many weapons are assumed to have certain targeting or ergonomic options, which you have to pay extra for.

**Folding stock** - This has negligible cost and adds Enc 1 to a pistol class weapon. When unfolded, the weapon can use RC3 range brackets if the aiming RC of the projectile/beam is RC3 or better and the weapon is fired from the shoulder with both hands. Or, it adds +10 accuracy at all ranges *if* the weapon is aimed.

**Gyrostabilized hip mount** - This allows a person to use aiming RC5 for determining the range brackets of a weapon, *if* that weapon could have an aiming RC of 5+ if mounted on a vehicle or other fixed point. For instance, many heavy (but carryable) weapons would normally be aiming RC4 because that is the limit for shoulder-fired weapons, even if the weapon is capable of greater accuracy (aiming RC5 or more). This has 1x cost and 10x mass of **3G<sup>3</sup>** gyrostabilization for the appropriate Tech Level. At **BL23c** TL5, this is 10% of weapon mass (minimum of 1kg) and costs 2000Cr per kilogram. A **3G<sup>3</sup>** power supply that will last for 10000 seconds will power the unit more or less indefinitely.

**Folding tripod** - This is included in the accessory mass of any weapon with a semi-fixed mount. This allows the weapon to use aiming RC's greater than 4 if the weapon is capable of them. For instance, an archaic sniper rifle might be aiming RC4 if fired from the shoulder, but aiming RC5 if fired from a prone position with a bipod or tripod.

**Computerized telescopic sight** - A standard accessory for any shoulder-fired weapon. Adds 1000Cr to the cost of any **BL23c** TL4+ shoulder-fired weapon. If missing or broken, the weapon takes a -05 penalty at all range brackets past 3. If a **BL23c** TL3 weapon mounts one of these (or a high-quality TL3 sight) it gets a +10 bonus at all range brackets past 3 (+05 for pistols).

**Antigrav stabilizers** - Any **BL23c** weapon of TL4+ may mount these to reduce the apparent encumbrance. A small powerpack generates a metastable antigrav field to negate part of a weapon's encumbrance. The net effect is to reduce the actual Encumbrance of the weapon by half. This has 2x cost and 10x mass of **3G<sup>3</sup>** gyrostabilization for the appropriate Tech Level. At **BL23c** TL5, this is 10% of weapon mass (minimum of 1kg) and costs 4000Cr per kilogram. The mass of the agrav unit is added to the weapon *before* the Encumbrance is modified. Weapon initiative is altered, based on the apparent mass of the weapon. A **3G<sup>3</sup>** power supply that will last for 10000 seconds will power the unit more or less indefinitely.

---

# Battlelords of the 23rd Century

---

**Countermeasures** - These include sound suppressors, field dampeners, thermal maskers and ECM generators. All of these are subject to Battlemaster approval, but each -01 to the appropriate detection check is a 2% cost increase on the weapon and a 1% mass increase. The mass is halved (round up) for each **BL23c** Tech Level the weapon is past its introduction.

**Example** - An archaic weapon (**BL23c** TL3) is modified at an Alliance capital (TL6) with a sound suppressor that gives it a -50 to sound detection checks. This would normally be a 50% increase in weapon mass, but since it is such an advanced design (3 TL's higher), the mass is halved three times, to a 7% mass increase. The cost, however, is still 100% of the base weapon price.

**Note** - It is fair to assume that only certain parts of some weapons need to be shielded, like the power packs of plasma weapons, the barrel of an archaic firearm (silencer), and so on.

## Secondary Stats

After you've gone through all this, there are still a few stats you might want to apply to your weapons.

**Armor Value** - How tough is it to scrag that weapon of yours, anyway? The **3G<sup>3</sup>** AV of a weapon translates into an "average damage" just like the nasty that comes out the working end. This amount (round down to nearest whole number) is the Threshold of the weapon for purposes of resisting damage.

**Body Points** - This is converted just like the Armor Value, and becomes the amount of **BL23c** Body Points the weapon has. Once it takes this amount, it's slag and gives up the ghost in whatever means is fashionable for that weapon type (plasma users beware!). Until then, it continues to work, more or less.

**Example** - A typical 9mm pistol has a **3G<sup>3</sup>** AV of 8 and BP of 5. This gives it a **BL23c** Threshold of 2 and 2 Body Points. A Barrett 82 has a **3G<sup>3</sup>** AV of 13 and BP of 23. This gives it a **BL23c** Threshold of 3 and 4 Body Points. A 120mm tank cannon has a **3G<sup>3</sup>** AV of 33, and BP of 167. This gives it a **BL23c** Threshold of 5, and 20 Body Points (enough to survive at least 1 hit from most heavy weapons...).

The only benefit of having your weapons shot out from under you is that it means the damage didn't hit *you*...Naturally, weapons mounted under armor get the full protection of the armor in addition to their natural Threshold.

**Initiative** - As an option, half (round down) the **3G<sup>3</sup>** Initiative stat can be applied to **BL23c** Initiative rolls.

**Encumbrance** - **BL23c** Encumbrance is measured in pounds. To get the **BL23c** Encumbrance from **3G<sup>3</sup>** mass, multiply by 2, rounding fractions nearest unless Encumbrance is below 1.

**Example** - An M-16A3 has a loaded mass of about 3.85kg, for an Encumbrance of 8. A Colt Python has a loaded mass of about 1.1kg, for an Encumbrance of 2.

**Final note** - **BL23c** has an extraordinary variety of weapons and the system thrives on new and esoteric technologies. If you come up with results that seem a little skewed on occasion, think of a good reason why things turned out that way. Is it a breakthrough in technology? Does the performance of the weapon stem from some corner-cutting in the safety department? Is it imported from some little-known corner of the galaxy? You decide...

---





and



### Basics

**Nexus** is a cool game set in the interdimensional Infinite City, where different neighborhoods have differing laws of nature regarding technology and magic, and portals open to realities which may be more or less advanced than the one you came from. While the system is fairly simple, the background is custom made for the variety that **3G<sup>3</sup>** can provide. **Feng Shui** is perhaps cooler, and is set in the fast-paced world of Hong Kong action flicks, with appalling amounts of carnage, ancient magic and wierd high tech all over the place. These notes give you everything you need to create and convert weapons for use in **Nexus** or **Feng Shui**, which basically use the same rules mechanics.

### Tech Level

**Nexus** Tech Levels operate on a 1-10 scale that converts to **3G<sup>3</sup>** Tech Levels as follows:

3G <sup>3</sup> TL	Nexus TL	Example
1	1	Basic agricultural societies with no metal tools
2		Bows
3	2	Basic metalworking
4		Crossbows, first crude firearms
5		Matchlocks
6	3	Flintlocks
7		Percussion firearms, airguns, steam engines
8	4	Cartridge firearms, machineguns
9	5	Submachineguns, radar, light machineguns
10		Light assault rifles, first lasers
11		Autoburst weapons, useful laser sights
12	6	Caseless ammo, advanced ceramics, composites
13	7	Superconductor storage, first energy weapons
14	8	Useful energy weapons
15	9	Maximum development of known theories
16+	10+	?

A **3G<sup>3</sup>** TL of 1-7 corresponds to **Nexus** Low Tech. **3G<sup>3</sup>** TL8-12 is **Nexus** Mod Tech, **3G<sup>3</sup>** TL13-15 is **Nexus** High Tech, and anything above this is **Nexus** Super Tech. It is worth repeating that technological developments need not be uniform in **Nexus**. A culture could have High Tech electronics and Mod Tech weapons, develop caseless ammunition and never bother with regular cartridges, or any permutation the GM desires. For purposes of **Feng Shui** crossovers, the 69AD juncture is **Nexus** TL2, the 1850AD juncture is **Nexus** TL3 and the 2056AD juncture is **Nexus** TL6.

### Weapon types

The **3G<sup>3</sup>** weapon types correspond fairly well to **Nexus** types, with the exception that **Nexus** disintegrators are counted as **3G<sup>3</sup>** particle beam weapons, and can only be designed at **Nexus** TL's of 8 and up. All other weapons can be designed or imported from anywhere you can find them.

### Damage

Weapons in **Nexus** have a Damage and Penetration. These will convert from **3G<sup>3</sup>** as the energy-based DV (do not factor in projectile diameter) and normal DV (do factor in projectile diameter). The best conversion equation is:

$$\text{Nexus Damage (or Penetration)} = \log_{3G^3 DV} \times 8.5 \text{ (round nearest)}$$

### 3G<sup>3</sup> DV Nexus DV Example

3G <sup>3</sup> DV	Nexus DV	Example
10	9	
14	10	7.65mm pistol
18	11	9mm pistol
23	12	.357 Magnum pistol
30	13	.44 Magnum pistol
39	14	
51	15	5.56mm rifle
67	16	7.62mm rifle
88	17	Elephant rifle
115	18	Heavy machine gun
151	19	20mm cannon

As you can see, the scale is rather compressed, so that even anti-tank weapons are unlikely to have a Penetration of more than 30 or so. Also, some weapons will, depending on barrel length or powder load, be on the edge of a range. For instance, some 5.56mm/7.62mm rifles will be a point less than listed above due to TL or barrel length. **Feng Shui** characters don't give a damn about penetration, and go for pure energy delivery. Only use Damage numbers in **Feng Shui**, but subtract 1 from the **Nexus** equivalent (and only exceed 13 with GM permission).

**Example** - A Walther P-38 pistol (**Nexus** TL5) has a muzzle energy in **3G<sup>3</sup>** of about 400J and a DV of 18. Discounting the bore size, it has a energy-based DV of 17. This would give it a **Nexus** Dam/Pen rating of 11/10, and a **Feng Shui** Damage of 9.

### Str Req.

This is the minimum Strength attribute needed to fire the weapon accurately. This is equal to the square root of the **3G<sup>3</sup>** energy-based DV, or its **Nexus** Mass Value + 8, whichever is greater. Subtract 2 if the weapon is fired two-handed, and subtract 1 if the weapon has gained any accuracy from being a heavier than normal model (round fractions down). Weapons mounted on proper tripods or fixed mounts never require more than a Strength of 5, and weapons without recoil always use the Mass Value for the Str Req. **Feng Shui** weapons only have Str. Req. if needed to keep it out of character's hands because it is too nasty.

**Example** - A modern 9mm pistol has a **3G<sup>3</sup>** energy-based DV of around 19, and a loaded mass of 1.2kg. The square root of 19 is 4.35, so it has a Str Req. of 4. A 7kg disposable rocket has a Mass Value of -2, so it has a Str Req. of 4 (start at -2, then subtract 2 because it is fired with both hands, then add 8).

### Ammo

This is simply the number of shots the weapon has, and will vary according to weapon type. Clip-fed weapons may have an optional "+1" designation to show that they can carry one round in the chamber in addition to the clip capacity.

### Concealability (Feng Shui)

This is how easy the weapon is to conceal, and can be based off the **Feng Shui** rules, using either **3G<sup>3</sup>** or real-world weapon stats.

# Nexus: The Infinite City

## RoF

How fast a weapon fires depends on the **Nexus** Initiative of the person firing it. **Nexus** combat rounds are 3 seconds long, and weapons may be fired multiple times in this period. In general, firing either a single shot or a burst of up to the **3G<sup>3</sup>** rate of fire of the weapon is 3 Initiative Points (or Shots). Any weapon with a manual reload cycle will take 3 Initiative Points/Shots to reload and fire (without aiming). This includes single action revolvers, bolt, lever and pump action weapons. Muzzle loading and archaic weapons take at least 10 full turns to reload.

## Nifty options

The previous page covers all the **Nexus** stats you need, except for obvious things like how much the weapon weighs, costs, etc. From here, everything is optional. Don't worry about most of these stats for **Feng Shui**.

## Range Class (optional)

All **Nexus** weapons operate on the same range brackets for hit determination. The **3G<sup>3</sup>** Range Class and Inherent Accuracy can be used to modify this. Add the Inherent Accuracy and aiming RC together, and subtract 3. The result is the **Nexus** "Range Class", which increases/decreases the Action Value modifier for range, noting that it cannot get better than +0. That is, a rifle with a **Nexus** Range Class of +3 will be +0 at point blank range, *not* +3. The +3 only serves to counteract range penalties.

## AV and BP (optional)

Weapons in **Nexus** can be rated with a Penetration Resistance, like armor. The **3G<sup>3</sup>** Armor Value is converted like *half* a Damage Value, and **3G<sup>3</sup>** Body Points is converted like *twice* a Damage Value to **Nexus** Wound Points. Any Wound Points a weapon takes are a penalty to the Action Value when using it (if it survives any Death Check), and if the weapon takes Wound Points of equal or more than its total, it is destroyed. The AV of a Death Check for most guns is 5, and 10 for most melee weapons.

**Example** - A **3G<sup>3</sup>** pistol with an AV of 9 and 5BP would have a PProf 6 and a maximum capacity of 9WP.

## Malfunctions (optional)

Normally handled by the outcome of a **Nexus** task check (outcome of -10 or worse). Optionally, add the **3G<sup>3</sup>** (Reliability Class - 2) to all tasks involving the weapon after such a failure.

**Example** - A **3G<sup>3</sup>** Reliability Class III weapon would suffer a permanent 1 point penalty to **Nexus** actions after a malfunction (at least until field stripped and adjusted).

## Ammunition options

These are handled as per the normal **Nexus** rules (page 168).

## Shotguns (optional)

Shotguns are handled as a special case of autofire. Use an Action Value bonus appropriate for half the number of pellets in the load, and the Damage of each individual pellet that hits. One shotgun blast cannot hit multiple targets unless they are very close, and increased Difficulty would be as for normal autofire. There is no increased Str required to fire a single shotgun shell. Autofire shotguns *do* have increased Str requirements, but get Action Value bonuses based on the half the *total* number of pellets fired. Non-shotgun multiple projectile rounds such as duplex ammunition are handled in the same way as shotgun shells.

**Example** - A shotgun firing 16 buckshot pellets would have a +6 AV, since this is the bonus for an autofire attack of 8 shots. An autofire shotgun firing 3 such shots per burst (total of 48 pellets) would have a +3 Str requirement, and get a +9 AV, since this is the bonus for 24 shots. Such a 3 shot burst could also be spread to 3 discrete targets, at the normal penalty to Action Value.

## Guided weapons (optional)

Weapons with a **3G<sup>3</sup>** guidance bonus will get a +1 Action Value for each 10% of **3G<sup>3</sup>** bonus, cumulative with any other bonuses a character may have. If a weapon is automated, count it as having an appropriate attribute (usually Ref:Spd) equal to its bonus, and to have a skill equal to its attribute. This lets you sequence it normally for Initiative purposes. Proximity or contact-fuzed weapons simply go off when triggered, regardless of when it happens.

## Telescopic sights (optional)

A telescopic sight will increase the maximum aiming bonus a character can get by the optional **Nexus** Range Class of the weapon, and at **Nexus** TL6+ might reduce or negate penalties like darkness. A weapon with telescopic sights will take a -1 Action Value if it is *not* aimed, since the telescopic sight interferes with the manual sights.

**Example** - A telescopic sight on a weapon with a **Nexus** Range Class of +2 could aim to a +5 Action Value instead of a +3.

## Explosives

Damage for **Nexus** explosives is based on a quantity of 1 gram, and the damage bonus is increased by +2 each time the quantity is doubled. To convert from **3G<sup>3</sup>**, use half of the **3G<sup>3</sup>** explosive Damage Value to convert to a **Nexus** damage for 1 gram, and then increase for the quantity, as per normal **Nexus** rules.

## Archaic projectile weapons

These are converted normally, and have a Strength requirement of half their Pen, rounding down. Crossbows have a minimum Strength of 1 point less, which is required to ready the weapon in 3 turns (each point less *doubles* the time needed). The Strength to *fire* a crossbow without penalty is usually no more than 5.

## Melee weapons

The physical stats of melee weapons, such as mass, Armor Value and so on convert from **3G<sup>3</sup>** using the rules for other weapons. Weapons with a **3G<sup>3</sup>** Inherent Accuracy of +2 or more get a +1 Action Value, and those with **3G<sup>3</sup>** Inherent Accuracy of +0 or worse get a -1 Action Value to reflect their unwieldiness.

## Damage

The **Nexus** Damage and Penetration of a melee weapon are the same, and is the converted **3G<sup>3</sup>** Damage Value (use highest value for multiple attack types), minus 6 (round nearest). The minimum Strength for a melee weapon is its **Nexus** damage bonus, with a penalty of half (round down) its worst **3G<sup>3</sup>** Initiative.

**Example** - A sword with a **3G<sup>3</sup>** DV of 14 and Initiative of -4 would have a **Nexus** Dam/Pen of Bod:Str+4 and Strength min of 6.

## Enhanced melee weapons

Enhanced melee weapons (like armor-piercing vibroblades) will be treated as **3G<sup>3</sup>** equivalents if possible. Additions to damage add to the basic **3G<sup>3</sup>** DV *before* conversion, and damage enhancements (like a stun baton) are treated as separate damage.



## Basics

**Heavy Gear™** is a far future science fiction roleplaying game which is based on the **Silhouette™** game engine. The game engine features a fully compatible vehicular combat system that can be played as a stand-alone tactical wargame. This **3G<sup>3</sup>** conversion covers most of what you need for both systems.

## Name

The commonly used name of the weapon.

## Tech Level

Tech levels in **Heavy Gear** vary depending on the technologies concerned. For example, many weapons are at **3G<sup>3</sup>** TL11, yet humanoid walker vehicles and efficient laser weapons are available. For design purposes, assume that conventional projectile weapons are **3G<sup>3</sup>** TL10-12 while “advanced” weapons (lasers, particle beams and railguns) can go up to **3G<sup>3</sup>** TL13 or TL14 in some extreme cases. The higher TL's also apply to electronics such as sensors, batteries and other storage technologies.

## Damage Value

**Silhouette** damage is based on the square root of the maximum thickness of armor steel that can be completely penetrated. This yields a stat called Damage Multiplier (DM), which is multiplied by the Margin of Success of the attack (the difference between the attacker's and defender's rolls) to give a damage point total.

This damage point total is compared to the Stamina (for people) or Armor (for vehicles and objects) of the target. Stamina or Armor represent the toughness of the most sturdy location on the target, given an optimum defense (perfect sloping, maximum projectile tumbling, etc.). The damage total (DM times Margin of Success) represents the increased damage caused by hitting other less well-protected locations, the hydrostatic shock, the reduced tumbling, etc.

To keep the game manageable when dealing with vehicle and people, two damage “scales” are used. Personal DM and Stamina values are worth one-tenth of the Vehicular Damage Multiplier and Armor. For example, a handgun will have a DM of x15 versus humans and x1.5 (rounded nearest for simplicity, x2 in this case) against vehicles. While this is not an accurate conversion, since damage is based on an exponential curve, it is good enough for game purposes and simplify things greatly.

Given that the **3G<sup>3</sup>** DV and the **Silhouette** DM are both based on material penetration, the conversion is fairly simple. To convert a **3G<sup>3</sup>** DV to a **Silhouette** Personal DM, take the square root of the DV and multiply by 4, rounding down.

$$\text{Silhouette Personal DM} = (3G^3 \text{ DV})^{.5} \times 4 \text{ (round down)}$$

Melee weapons use the Personal DM, but add the character's Armed Damage (AD) rating to the amount.

3G <sup>3</sup> DV	Example	Personal DM	Vehicle DM
7	Knife	x10	x1
15	Light pistol, sword	x15	x2
25	Medium pistol	x20	x2
39	Heavy pistol, light rifle	x25	x3
57	Medium rifle	x30	x3
77	Heavy rifle	x35	x4
100	Sniper rifle	x40	x4
156		x50	x5
400	Light autocannon	x80	x8
625		x100	x10
900	Heavy autocannon	x120	x12
1407	Light vehicle bazooka	x150	x15
2025		x180	x18
2500	Medium vehicle bazooka	x200	x20
3025	Light field gun	x220	x22
3907	Heavy vehicle bazooka	x250	x25
4900	Heavy field gun	x280	x28
5625	Heavy AT missile	x300	x30

## Range

**Silhouette** uses range bands that double the previous one, like 1/2/4/8 for Short/Medium/Long/Extreme range. Compare the **3G<sup>3</sup>** aiming RC of the weapon to the following table to get the **Silhouette** range bands.

Aiming RC	Short range	Modifier	Multiply by
1	2 meters	Damage RC < aiming RC	x.80 per RC
2	5 meters	Damage RC = aiming RC	x1.00
3	15 meters	Damage RC > aiming RC	x1.20 per RC
4	50 meters		
5	100 meters		
6	200 meters		
7	500 meters		
8	1000 meters		

Round numbers to nearest meter. If using the tactical rules, round range to nearest 50 meters. Items like advanced weapon sights are counted as sensors, and would use the appropriate rules (+1 modifier per 20% of **3G<sup>3</sup>** bonus). Gear mounted weapons suffer the usual penalties for attacking infantry targets.

## Accuracy

**3G<sup>3</sup>** Inherent Accuracy would be closest to the **Silhouette** Accuracy stat. Accuracy is a zero-average modifier, meaning that zero is a standard accuracy, negative are inaccurate weapons and positive values are accurate weapons. Accuracy never goes much beyond -2 to +2 (most weapons have 0). Weapons with **3G<sup>3</sup>** IA of zero or 1 point more than normal get no **Silhouette** bonus or penalty, but any amount in excess of this will apply in either direction. Energy weapons get +1IA for purposes of this calculation, and indirect fire weapons get -1IA.

**Example** - A **3G<sup>3</sup>** IA of 2 more than the base for that weapon would get a **Silhouette** Accuracy of +1, while one with an IA of 1 less than normal would get a **Silhouette** Accuracy of -1.

## Initiative (optional)

There is no equivalent to **3G<sup>3</sup>** Initiative in **Silhouette**, but the stat can be applied to the initiative roll if it seems appropriate.

# Heavy Gear

## ROF

**Silhouette** combat rounds are six seconds long. Almost all weapons in **Heavy Gear** are at least semi-auto, and are treated as ROF 0. Higher ROF weapons are mostly special effect weapons: they can increase damage, can saturate an area to increase to-hit chances and can attack multiple targets. Ammo consumption is different for projectile and missile weapons, and is not quite realistic (10 shots/ROF point, or 2/4/8 etc. rockets for ROF 1/2/3 etc.). In this case, simplicity was chosen over realism, but more accurate ammo consumption figures can be used if the players so choose. For a good **3G<sup>3</sup>** conversion, an autofire weapon can get a +1 ROF for each 30 shots it can fire in a six-second interval, and each time this is doubled. If a weapon runs out of ammo in less than six seconds, average total clip capacity over the six second turn. So, a machine pistol with a 30 round clip is never going to have a **Silhouette** ROF of more than 1.

Rounds per second	Silhouette ROF
<6	0
6-9	1
10-19	2
20-40	3

Autofire weapons deemed exceptionally controllable may get +1 ROF to reflect the ability to keep a burst of fire on target.

## Armor Value/Body Points (optional)

There is no **Silhouette** equivalent for either of those. A **3G<sup>3</sup>** AV could be converted to a regular **Silhouette** Armor value based on half (round up) the DM its **3G<sup>3</sup>** AV would generate, or the DM half its mass in kilograms would generate (whichever is larger), with appropriate damage thresholds following from this.

**Example** - A 2kg weapon with a **3G<sup>3</sup>** AV of 10 would have a **Silhouette** Armor of 7, while a 25kg weapon with the same AV would have a **Silhouette** Armor of 10.

## Concealability (optional)

In **Silhouette**, concealability is decided by the Gamemaster rather than a few numbers. For example, a sawed-off shotgun is easier to conceal under a trenchcoat in a dimly lit alley than under a suit jacket in broad daylight. For those who want numbers, subtract 2 from the number of **3G<sup>3</sup>** weapon locations, and use half the result (round down) as desired vs. attempts to spot a hidden weapon.

## Shotguns (optional)

Shotguns haven't been published yet in **Heavy Gear**, but they will likely use the vehicular's Fragmentation ammunition rules (**Heavy Gear**, page 133).

## Special ammunition

The **Heavy Gear Tech Manual** lists many new types of ammunition, most of which can be directly converted from their **3G<sup>3</sup>** equivalents. Most special ammunition works to increase the **3G<sup>3</sup>** DV of the weapon, and therefore its **Silhouette** DM.

## Reliability (optional)

A weapon must be maintained a certain number of minutes per day or suffer from a possible breakdown. In general, halve the **3G<sup>3</sup>** Malfunction Class and multiply this by the normal maintenance time for that weapon, e.g. a Class III(Class 3) weapon requires 1.5 times as much maintenance as normal.

## Explosives

The **Silhouette** DM is figured as for other weapons, with a normal Primary radius of 1/3 (round down) the DM. Military fragmentation weapons have a Secondary radius equal to the DM, and improvised fragmentation weapons have a Secondary radius equal to 1/2 the DM (round down).

**Example** - A 1kg block of **3G<sup>3</sup>** TL11 explosive has a DV of 193, or a **Silhouette** DM of 55, giving it a Primary radius of 18. If wrapped with nails and barbed wire it would have a Secondary radius of 27.

## Lasers

**Heavy Gear** lasers are extremely efficient. Design them according to the normal **3G<sup>3</sup>** rules, but base the final **3G<sup>3</sup>** DV on a beam diameter of not more than 10mm, regardless of the size of the weapon. **Heavy Gear** lasers lose damage multiplier equal to 10% of the DM (round up) per range band to represent atmospheric interactions with the beam.

## Particle Beams

**Heavy Gear** particle beams are designed with the same notes as lasers but roll twice on the Damage Table to represent the collateral radiation and haywire effect. Against humans, this is represented by an additional electrical attack with an Intensity equal to the DM plus the Margin of Success (ouch!). **Heavy Gear** particle beams lose damage multiplier equal to 10% of the DM (round down) per range band to represent atmospheric interactions with the beam, with a minimum of -1 per range band.

## Railguns

Like other "advanced" weapons in HG, railguns are extremely efficient. Design them normally in **3G<sup>3</sup>**, but base the final DV on 10% of the actual projectile size or 3mm, whichever is larger. Very large railguns should use the optional rules on page 64 of the **3G<sup>3</sup>** rules.

**Example** - An 80,000,000J TL14 railgun with a bore of 100mm would be 4040kg and 10.3m long. However, its DV for **Silhouette** purposes is based on a bore of 10mm, and would be 7670, or a DM of 350 (vehicular of 35). Each shot from this heavy railgun would require 928kg of TL14 superconductors, so if it carried the normal energy load of 24 shots (**Heavy Gear**, page 142) it would have a mass of around 29 tons, or have a minimum size of 10 (compared to the **Heavy Gear** version at minimum size 12).

## Melee weapons

These are designed and converted normally from **3G<sup>3</sup>**. Additions like vibroblades increase the effective DV for penetrating armor would result in a higher **Silhouette** DM.

## Sensors

In the **Heavy Gear** universe, each 20% bonus from **3G<sup>3</sup>** sensors will be a +1 modifier to the attack roll, as appropriate for the particular sensor type. Non-sensor aids like telescopic sights will simply increase the maximum possible aiming bonus by 1 or 2.



### Basics

**Fuzion** is a metasystem rather than a multisystem, a way to use similar game mechanics that can mutate from game setting to game setting to provide the best results by means of 'switches', 'dials' and other whistles and bells. The **Fuzion** rules can be downloaded from <http://www.best.com/~rtg1/rtginfo.html>.

This conversion should have all the information you need to convert any **3G<sup>3</sup>** weapon into basic **Fuzion** terms. Additional special effects will depend on your game setting.

### Tech Levels

There aren't really any Tech Levels in **Fuzion**. A weapon is either appropriate to a genre, or it isn't. If **Fuzion** is used in a background originally part of some other system, use that system's Tech Levels as a guide.

### Name

This is the common name of the weapon.

### Caliber

This is some notation for personal reference as to the ammunition type it uses.

### Weapon Accuracy

Inherent Accuracy of a **3G<sup>3</sup>** weapon translates into the **Fuzion** WA (weapon accuracy) stat. The closest match is obtained by converting directly from IA to WA, and subtracting 1 if the weapon has an aiming RC of 2, or subtracting 2 if it has an aiming RC of 1. So, an IA of +2 becomes a WA of +2 for an RC3 rifle, but a +1 for an RC2 pistol, and +0 for an RC1 pistol. Inaccurate weapons with low RC's *can* have a negative WA. Yes, this stat is derived exactly as for **Cyberpunk 2020**, since the **Fuzion** stat is as well.

### Damage

**Fuzion** uses a discontinuous scale for damage. Things are fairly linear up to about elephant rifle range, then the curve gets much steeper, with much greater energies required for increased Damage Class. For a **3G<sup>3</sup>** Damage Value of 80 or less, the **Fuzion** Damage Class (killing damage) is:

$$\text{Fuzion Damage Class} = 3G^3 \text{ Damage Value} / 8(n)$$

For a **3G<sup>3</sup>** Damage Value of 81 or more, the **Fuzion** Damage Class is:

$$\text{Fuzion Damage Class} = (\log_{DV} \times 5.25)(n)$$

In addition, **Fuzion** uses two separate damage types, Damage Class, and 'Kills'. The latter is usually restricted to vehicle weapons, or conventional weapons of 30mm or larger. To go from Damage Class to Kills, use the **Fuzion** guidelines for the genre you are playing.

### Dialing for Damage!

How much damage you can do with a weapon in **Fuzion** is largely dependent on the genre you are playing. A hand-held weapon in a high-tech "real world" game would be far less capable than the same weapon in an "anime power-armor" game. To take this into account set your own "Damage Dial" based on the genre you are playing. *Suggestions* are below:

Genre	Add to converted damage:
Real world	nothing
Slightly heroic	1DC per 4DC past DC2 (d)
Heroic	1DC per 3DC past DC2 (d)
Massively heroic	1DC per 2DC past DC2 (d)
Mindboggling heroic	1DC per 1DC past DC2 (d)

**Example** - A heavy pistol that converts from **3G<sup>3</sup>** to DC5 would be DC6 in a heroic campaign and DC8 in a mindboggling heroic campaign. An assault rifle that converted from **3G<sup>3</sup>** to DC7 would be DC8 in a heroic campaign and DC12 in a mindboggling heroic campaign.

### Maximum Range

**Fuzion** weapons all take the same range penalties out to their listed range. What this range is depends on the **3G<sup>3</sup>** Range Classes for aiming and damage.

Aiming RC	Range	Damage RC	Shift
1	10m/yds	>2 less than aim RC	2 rows up
	20m/yds	2 less than aim RC	1 row up
2	30m/yds	1 less than aim RC	0 rows
	50m/yds	equal to aim RC	1 row down
3	70m/yds	1 more than aim RC	1 row down
	100m/yds	2 more than aim RC	2 rows down
4	150m/yds	>2 more than aim RC	3 rows down
	200m/yds		
5	300m/yds	<b>Weapon Accuracy</b>	<b>Shift</b>
	400m/yds	If WA is less than 1	1 row up
6	700m/yds	If WA is more than 1	1 row down
	1000m/yds		
7	1500m/yds		
	2000m/yds		
8	3000m/yds		
	4000m/yds		

**Example** - A shoulder-fired rocket with a **3G<sup>3</sup>** Range Class of 2/5 and an Inherent Accuracy of 1 would end up with an effective range of 70m/yds (base of 30m/yds, +3 rows for damage RC, minus 1 row for a **Fuzion** Weapon Accuracy of zero).

**Optional** - If a weapon loses damage with range, subtract 1DC at half the effective range, and 2DC at the effective range or greater.

**Optional** - **Fuzion** ranged weapons do not usually have a Minimum Strength, but if they would, it would be the DC of the weapon minus 1, with an additional -2 if the weapon is held with both hands. Using a weapon you don't have the Strength for will be a -1 penalty per point of Strength that is lacking, which will apply only to weapons with a rate of fire of more than 1.

# Fuzion

## Melee weapons

Melee weapons convert their damage the same way ranged weapons do, but if the weapon is designed to be used two-handed, add +2DC to the final amount, and if it is highly unbalanced, add +1DC to the final amount.

Minimum Strength is usually the Damage Class minus 1, +1 if the weapon is two-handed, +1 if it is unbalanced, +2 if it is highly unbalanced, and +1 if Weapon Accuracy is 0 or lower, and -1 if Weapon Accuracy is +2 or better.

To get Weapon Accuracy for melee weapons, use the IA, then apply -1 if the weapon has 1 or 2 locations, +0 if it has 3 or 4, -1 if it has 5 or more. Apply an extra -1 if it is highly unbalanced.

**Example** - An S/5 broadsword has a **3G<sup>3</sup>** Damage Value of around 14 and an IA of 1. This gives it a **Fuzion** Damage Class of 2 if used one-handed, and Damage Class 4 if used in both hands. It has a final Weapon Accuracy of +0, and Minimum Strength of 5.

This gives reasonable results for most melee weapons, though it is difficult to get exact matches with **Fuzion** stats for weapons with a high Damage Class.

## Rate of Fire

Most weapons will have a RoF of 1 or 2, or one or two shots per 3 second **Fuzion** phase. Weapons with an RoF of 1 include bolt, lever, pump, single-action revolver and single shot weapons with one barrel. Weapons with an RoF of 2 include double-action revolvers and semi-automatic weapons. Autoburst weapons have an RoF of 2, but may fire either single shots or 3-round bursts. Autofire weapons in **Fuzion** can fire twice a phase, and will use the **3G<sup>3</sup>** rate of fire as the maximum shots per firing action, the number of hits based on the dial setting for the genre in question.

## Guided weapons

Guided weapons in **Fuzion** are given a rating from Dumb(8) to Genius(20), as a difficulty number the target has to beat to avoid getting hit. A **3G<sup>3</sup>** guidance bonus will correspond to each type of **Fuzion** guidance for self-guided weapons. For a user-guided weapon or targeting aids, they are just counted as bonuses to hit.

<b>3G<sup>3</sup> guidance</b>	<b>Fuzion targeting bonus</b>	<b>Missile intelligence</b>
+2	+0	-
+4	+1	Dumb
+6	+2	Dumb
+8	+3	Smart
+10	+4	Smart
+12	+5	Smart
+14	+6	Brilliant
+16	+7	Brilliant
+18	+8	Genius
+20	+9	Genius

**Example** - A **3G<sup>3</sup>** guidance system with a bonus of +6 would be a Dumb missile in **Fuzion**, or a +2 bonus to skill on a user-guided missile. The **3G<sup>3</sup>** limits on guidance systems can optionally be applied in **Fuzion**, so a user-guided missile with a +2 bonus could not gain any benefit from more than 2 levels of user skill.

**Note** - Most of the 1990's-era anti-tank and air-to-air missiles would be considered "Smart" missiles in **Fuzion** terms.

## SDP and KD (optional)

Personal devices like weapons generally are not rated in terms of their defense and ability to withstand damage, but you can use **3G<sup>3</sup>** stats to generate the appropriate **Fuzion** terms. The **Fuzion** KD of a weapon is the Damage Class that would be generated by twice the weapon's **3G<sup>3</sup>** Armor Value, and the final result multiplied by 3.5. The **Fuzion** SDP of the weapon is the Damage Class that would be generated by twice the weapon's **3G<sup>3</sup>** Body Points, and the final result multiplied by 3.5. To rate these in Kills, you get 1 Kill per 50 points in either stat, and +1 Kill per 3.5 points over this. This reflects that a 1 Kill attack (Damage Class 14) does an average of 49 points of damage, which 1 Kill of armor (50 points) should just be able to stop, with +1 Kill per extra d6 in the attack (average of 3.5 points damage).

**Example** - A Beretta 92F has an Armor Value of 8 and 5 Body Points, which translates into a KD of 7 and SDP of 4. A tank cannon might have an Armor Value of 33 and 167 Body Points, which translates into a KD of 29 and 35 SDP. A battleship cannon would have about 1 Kill of armor and require 5 Kills worth of damage to destroy, roughly the same as an armored personnel carrier.

For simplicity's sake, a damaged item continues to function until it has lost all its SDP, but GM-induced malfunctions or staged penetration on damaged weapons are entirely appropriate. In general, most weapons will be unaffected or less affected by area effect attacks like explosions, unless hit directly. And to generalize damage, weapons that are not rated in Kills are unlikely to ever destroy something whose armor *is* rated in Kills, no matter how many shots you fire or how well you roll.

## Explosives

Damage from explosives is converted normally. If the explosion has an effect radius, it is the same as other **Fuzion** weapons with the same Damage Class.

## Cost

How you pay for something in **Fuzion** depends on the genre. If equipment has cost in dollars or credits, just use the **3G<sup>3</sup>** amount. Otherwise, you need to convert the final **Fuzion** stats based on the type of power created.

**Example** - You convert a **3G<sup>3</sup>** pistol into a **Fuzion** weapon with a Damage Class of 3 (a medium pistol). Since this is a ranged killing attack, it would be bought as a Damage Class 5, which loses 2 Damage Class because it is a ranged killing attack, dropping it to 3.



<b>A</b>	
2000AD Laser rifles	38
2000AD power	39
<b>B</b>	
Accessories	17,44
Conventional weapons	17
Lasers	44
Laser sights	23
Particle beams	52
Railguns	62
Telescopic sights	24
Action	3
Auto-burst	3
Bolt action	3
Full-auto	3
Lever action	3
Mass multiplier	15
Reliability penalty	15,19
Revolver	3
Semi-auto	3
Single shot	3
Aiming RC	
Longarms vs. Pistols	26
Rifled vs. smoothbore	9
Armor Value	2,20,37,45,53,64,67
<b>B</b>	
Barrel	5
Aiming RC	16
Mass	16
Minimum length	16
Battering effects	66
Battery	4,41
Binary propellant	29
Blinding	42
Bore	4
Bows	37
Body Points	21,37,45,54,64,67
Bullpup	5,22
<b>C</b>	
Capacitor	5
Cartridge lasers	42
Caseless ammunition	11
Casing	5
Centimeter	5
Coil gun	5,57
Combined weapons	27
Compatibility issues	9
Compressed air weapons	29
<b>Conversion guides</b>	<b>78</b>
3G <sup>3</sup> to <b>Battlelords 23c</b> <sup>™</sup>	113
3G <sup>3</sup> to <b>CORPS</b> <sup>™</sup>	80
3G <sup>3</sup> to <b>Cyberpunk 2020</b> <sup>®</sup>	108
3G <sup>3</sup> to <b>GURPS</b> <sup>®</sup>	83
3G <sup>3</sup> to <b>Heavy Gear</b> <sup>™</sup>	121
3G <sup>3</sup> to <b>Hero System</b> <sup>®</sup>	91
3G <sup>3</sup> to <b>MasterBook</b> <sup>™</sup>	87
3G <sup>3</sup> to <b>Nexus</b> <sup>™</sup>	119
3G <sup>3</sup> to <b>TimeLords</b> <sup>™</sup>	78
3G <sup>3</sup> to <b>Traveller 4th ed.</b> <sup>®</sup>	104
3G <sup>3</sup> to <b>Traveller: New Era</b> <sup>®</sup>	97
Cost	18,45,54,63,68
Ammunition	34,65
IA modifiers	18,45,54,63
Mass modifiers	18,45,54,63
Crossbows	37
Cubic Centimeter	5
<b>D</b>	
Damage	1
Damage Value	2,10
Disposable weapons	29
<b>E</b>	
Efficiency	
Conventional weapons	10
Lasers	40
Particle beams	50
Railguns	59
Energy-enhanced weapons	36
Energy storage	39,41
Batteries	39,41
Capacitors	41
Solar panels	41
Superconductors	41
<b>F</b>	
Flechette	5,23
Folding barrels	
Railguns	60
Rockets	31
Fragmentation	5,24
<b>G</b>	
General Conversion Notes	69
Gram	5
<b>Guided weapons</b>	<b>32</b>
Active homing	35
Cost	34
Fire and forget	35
Historical guidance types	32
Indirect fire	33
Linked guidance	33
Passive homing	35
Power usage	34
Proximity fuzed	34
Self-guided projectiles	33
Semi-active homing	35
Smart weapons	33
Terminal guidance	35
Tracking	33
User-guided projectiles	32
Gyro stabilization	28
<b>H</b>	
HE	5,23
HEAT	5,23
<b>I</b>	
Ignition systems	
Electric	4
Flintlock	4
Matchlock	4
Percussion	4
Illumination charges	31
Inherent Accuracy	6,18
Initiative	21
<b>J</b>	
Joule	6
<b>K</b>	
Kilogram	6
<b>L</b>	
Laser (definition)	6
Laser communicator	46
Laser rangefinder	46
<b>Lasers</b>	<b>38</b>
Adjustable frequency	42
Adjustable output	46
Advanced focusing	42
AV	45
Blinding	42
BP	45
Cartridge lasers	42
Chemical lasers	43
Continuous beam	47
Cost	45
Damage Value	39
Inherent Accuracy	44
Initiative	45
Lasing apparatus	42
Length	43
Folding	43
Limits on beam energy	40
Malfunction chance	45
Range Class	45
Rate of Fire	45
Semiconductor lasers	43
Tech Level	38
Weapon bulk	45
Length/width ratio	6
Low-tech stunners	48
<b>M</b>	
Magazine	
Detachable	16,62
External magazine	16,62
Internal magazine	16,62
Removable magazine	16,62
Malfunction chance	19
Malfunctions	72
Maser (definition)	6
Masers	49
Mass driver	57
Maximum allowable propellant	11
<b>Melee weapons</b>	<b>67</b>
AV	67
BP	67
Cost	68
Damage Value	67
Energy-enhanced	68
Inherent Accuracy	68
Initiative	68
Meter	5
Minimum bore size	9
Mortars	28
Multiple caliber weapons	28,61
Conversion kits	28
Muscle-powered weapons	37
Muzzle energy	6,10
<b>N</b>	
Non-reloadable ammunition	12
<b>P</b>	
Parachutes	31
<b>Particle Beams</b>	<b>50</b>
Accelerator length	51
Accelerator mass	50
Accessories	52
Adjustable output	55
AV	53
BP	54
Continuous beam	55
Cost	54
Damage Value	50
Efficiency	50
Energy storage	50
Inherent Accuracy	53
Initiative	54
Magazine	51
Malfunction chance	53
Margin of error	50
Radiation effects	52
Range Class	52
Rate of Fire	53
Recoil	53
Tech Level	49
Weapon bulk	53
Pepperboxes	27
Phazers	46
Plasma beams	56
Plasma cartridges	56
Power transmission	53
Projectile	6
Characteristics	12
Velocity	13
Maximum range	13
Propellant	6
Propellant energy	10
<b>R</b>	
Radiation	52
Railgun (definition)	6
<b>Railguns</b>	<b>57</b>
Accelerator length	61
Accelerator mass	60
Accessories	62
Adjustable output	61
Ammunition cost	65
AV	64
BP	64
Compatibility	57
Cost	62
Damage Value	58
Discarding sabot	60
Efficiency	59
Fragmentation rounds	60
HE rounds	60
HEAT rounds	60
Inherent Accuracy	62
Initiative	65
Length	63
Magazine	62
Malfunction chance	63
Minimum projectile diameter	58
Projectiles	58
Range Class	62
Rate of fire	63
Receiver	61
Recoil	65
Tech Level	58
Weapon bulk	64
Range Class	7
Projectiles	14
Rate of fire	18
Receiver	7,15
Recoil	21
Recoilless rifles	29
Rifle grenades	28
Rocket-assisted projectiles	31,60
Rockets	30
Backblast	30
Booster charges	31
Problems	30
Terminal velocity	30
Round	7
<b>S</b>	
Sabot	7
Salvage	35
Shaped charge	7,23
Shell	7
Shotguns	26,61
Bore	26
Close range	26
Flechettes	26
Pellet hits	26
Smoke grenades	25
<b>Special ammunition</b>	<b>22</b>
Armor piercing rounds	22
APFSDS	4
Depleted uranium	5,11
Discarding sabot rounds	22
Exploding rounds	22
Fragmentation rounds	24
HE rounds	23
Hollow point rounds	22
Multiple projectile rounds	23
RAKE	6,31
Self forging warheads	24
Shaped charges	7,23
Stacked projectiles	25
Special payloads	
Illumination charges	31
Parachutes	31
Spot welder	46
Storage bank	7
Stunners	47,48,55
<b>T</b>	
Tech Level	2
Conventional Weapons	8
Gun vs. powder TL	22
Pushing the limits	2
Ultra-tech	46
Telescopic sights	24
<b>U</b>	
Universal conversion chart	74
<b>V</b>	
Weapon bulk	20
Weapon length	19
Bullpup vs. regular stock	19,22

---

# Web Links

## Web Links

While the following is not an exhaustive list, the web links below are certainly a good starting point for anyone who wants to do their own weapon research. BTRC has no connection to any of these pages and doesn't vouch for any commercial products made available on them, but they are probably worth looking at if you have the time to surf them. These links will be updated as needed in future .pdf printings of **3G<sup>3</sup>**, but at the time of this printing all of the links are active.

### The Spyzone

<http://www.spyzone.com>

A private company specializing in personal protection products. Lots of neat stuff that you'll probably never use.

### NASA Thesaurus

<http://gopher.sti.nasa.com/thesaurus/a/>

An online listing of definitions and cross-linked terms, many of which are applicable to weapons development. Substitute the letter you wish to peruse for the "a" when searching.

### Ballistics and Tech Reference

<http://michp753.redstone.army.mil/hotlinks/ball.html>

Lots of useful links on a number of weapon topics. Certainly worth checking out.

### The Electromagnetic Propulsion Home Page

<http://www.rovers.net/~geoffk/railgun.html>

A page dedicated to railguns, coilguns and the like, with emphasis on orbital cargo launchers. A good technical reference for what we can do now and in the near future.

### The GDW-betalist archive

<http://www.qrc.com/~wildstar/gdw-beta/threads/>

An archive of various postings, mostly referring to the **Traveller** game universe, but often delving into extremely technical issues of spaceflight, weapon design and other high-tech issues.

### Jane's Information Group Home Page

<http://www.thomson.com/janes/jtext.html>

By the publisher of the **Jane's** series of reference works (**Jane's Infantry Weapons**, **Jane's Armor and Artillery**, etc.), one of the world's leading weapon reference works. Constantly updated and with a bit of useful free material.

### Cannon Limited Artillery Manufacturers

<http://www.florentine.com/cannonltd/cannon.htm>

The home page of a manufacturer of reproduction cannons, from scale models to full-size working pieces. May provide useful information on weights and measures of TL7- artillery pieces.

### Police Resource List - Firearms

<http://police.sas.ab.ca/prl/gun.html>

A page containing links to image archives, manufacturer home pages, firearms organizations and a number of police department home pages. Extremely useful for any gamemaster looking for cultural reference material or local laws.

### ArmsCalc - Ballistics Calculator

<http://www.saskia.com/~arms/calc.htm>

A page selling a ballistics software program that can calculate muzzle velocities, trajectories and other useful information.

## Other references

In addition to the web references, there are a number of print sources you may find useful for further research on your own. The first of these is the nearest large library. Using the Library of Congress classification system, there should be any number of books in the TX through U section that will give you something to read for a few weeks. Other good sources are:

### Jane's Infantry Weapons

#### Jane's Armor and Artillery

#### Jane's Security and Co-in Equipment

Each of these is a 500+ page tome packed with the latest equipment, including prototypes and weapons that may never see actual service. They are printed yearly, and cost about US\$200 each, so you won't be buying many of them. However, you may find them in some libraries, and a number of book clubs sell copies that are a year or two out of date for prices down to US\$30, and these older books are still an excellent reference, given the slow turnover of most military hardware.

### International Defence Review

A special interest magazine covering political and technological developments regarding weapons and military organizations. Has user tests of new hardware, the latest procurement contracts, rumors, news and other good stuff. Unfortunately, it also costs about US\$200 for a one-year subscription, too rich for most gamer's tastes. Your best source for library copies is at a college with an ROTC or similar military training program. The December issue has an index of all articles for the year, making searches for a particular topic easier.

### Gun magazines

There are several "buyer's guides" that show up on magazine racks each year. While the previous sources cover military weapons in detail, you won't find too much in the way of civilian weapons there. These buying guides usually list dimensions, caliber, weight, cost and some other physical characteristics for hundreds of civilian weapons like pistols, shotguns, rifles and black powder firearms.

### Weapons

"An International Encyclopedia from 5000BC to 2000AD". Published by St. Martin's Press. If you only have the budget for one general-purpose weapon reference, I recommend this one. It covers almost every weapon and weapon development in some detail, is good for technical and non-technical readers, is well-illustrated and has a good bibliography. And, it's only about US\$20 in softcover.

# Historical Ammunition

Historical rounds - 3G<sup>3</sup> representations of TL8 to early TL12 ammunition

Round name	DV*	TL	Energy	Max. RC	Round	Propellant	Projectile	l/w	sg	Velocity	Rcvr. mass	Barrel len./mass	Malf.
.25 ACP (6.35mm)	10/8	10	90J	2/2	3.9g	.07g	3.55g	2:1	11	226m/sec	170g	11.5cm/109g	I
.25 ACP (6.35mm)	11/9	11	100J	2/2	3.8g	.07g	3.55g	2:1	11	238m/sec	164g	10.5cm/94.6g	I
.22 short	12/9	11	110J	3/2	2.3g	.08g	1.98g	2:1	11	334m/sec	174g	12.6cm/119g	I
.32 ACP (7.65mm)	12/11	8	150J	2/3	7.2g	.14g	6.44g	2:1	11	218m/sec	282g	16.2cm/238g	I
.32 ACP (7.65mm)	13/11	9	170J	2/3	7.1g	.14g	6.44g	2:1	11	231m/sec	280g	14.5cm/207g	I
.32 ACP (7.65mm)	13/12	10	190J	2/3	7.0g	.14g	6.44g	2:1	11	244m/sec	273g	13.1cm/180g	I
.32 ACP (7.65mm)	14/12	11	210J	3/3	7.0g	.14g	6.44g	2:1	11	256m/sec	261g	11.9cm/155g	I
.22 long rifle	14/11	9	155J	3/2	3.1g	.13g	2.46g	2:1	11	356m/sec	264g	20.2cm/277g	I
.22 long rifle	15/11	10	175J	3/2	3.0g	.13g	2.46g	2:1	11	378m/sec	259g	18.2cm/241g	I
.22 long rifle	16/12	11	190J	3/2	3.0g	.13g	2.46g	2:1	11	394m/sec	245g	16.5cm/204g	I
9mm short	13/12	8	195J	2/3	11.3g	.18g	10.4g	2:1	11	193m/sec	333g	16.7cm/280g	I
9mm short	13/13	9	220J	2/3	11.2g	.18g	10.4g	2:1	11	205m/sec	329g	14.9cm/242g	I
9mm short	14/13	10	245J	2/3	11.2g	.18g	10.4g	2:1	11	216m/sec	320g	13.4cm/210g	I
9mm short	15/14	11	265J	2/3	11.1g	.18g	10.4g	2:1	11	226m/sec	303g	12.1cm/177g	I
.45 ACP	15/16	8	355J	2/4	23.2g	.33g	21.5g	2:1	11	183m/sec	485g	17.7cm/401g	I
.45 ACP	16/17	9	400J	2/4	23.1g	.33g	21.5g	2:1	11	194m/sec	479g	15.8cm/347g	I
.45 ACP	17/18	10	445J	2/4	22.9g	.33g	21.5g	2:1	11	204m/sec	466g	14.2cm/300g	I
.45 ACP	18/19	11	490J	2/4	22.8g	.33g	21.5g	2:1	11	214m/sec	446g	12.9cm/257g	I
9mm Para	19/18	8	430J	3/3	12.6g	.40g	10.5g	2:1	11	288m/sec	547g	24.8cm/617g	I
9mm Para	20/19	9	485J	3/3	12.4g	.40g	10.5g	2:1	11	305m/sec	541g	22.1cm/535g	I
9mm Para	21/20	10	540J	3/3	12.2g	.40g	10.5g	2:1	11	322m/sec	527g	19.9cm/462g	I
9mm Para	22/21	11	595J	3/3	12.1g	.40g	10.5g	2:1	11	337m/sec	504g	18.1cm/397g	I
9mm caseless	23/22	12	650J	3/3	10.9g	.40g	10.5g	2:1	11	352m/sec	473g	16.6cm/338g	I
.41 Action Express	21/22	11	630J	3/4	13.1g	.42g	11.4g	2:1	11	333m/sec	522g	16.1cm/364g	I
.357 Magnum	24/23	10	730J	3/3	13.0g	.54g	10.7g	2:1	11	370m/sec	637g	22.9cm/620g	I
.357 Magnum	25/24	11	800J	3/3	12.9g	.54g	10.7g	2:1	11	388m/sec	607g	20.8cm/530g	I
10mm auto	26/26	11	900J	3/3	13.4g	.61g	11.0g	2:1	11	406m/sec	654g	20.0cm/540g	I
.41 Magnum	26/27	10	970J	3/4	15.3g	.72g	12.2g	2:1	11	400m/sec	761g	23.0cm/716g	I
.41 Magnum	28/28	11	1070J	3/4	15.1g	.72g	12.2g	2:1	11	420m/sec	729g	21.0cm/618g	I
5.7mm FN	28/21	12	600J	3/1	3.1g	.37g	1.67g	3:1	3	850m/sec	450g	25.2cm/494g	I
12ga shotgun slug	26/35	8	1650J	2/3	44.5g	1.53g	36.5g	1:1	11	301m/sec	1280g	23.6cm/1150g	I
12ga shotgun slug	27/37	9	1860J	2/3	43.7g	1.53g	36.5g	1:1	11	320m/sec	1260g	21.0cm/996g	I
12ga shotgun slug	29/39	10	2060J	2/3	43.1g	1.53g	36.5g	1:1	11	336m/sec	1220g	18.9cm/858g	I
12ga shotgun slug	30/41	11	2270J	2/3	42.6g	1.53g	36.5g	1:1	11	353m/sec	1170g	17.2cm/738g	I
.44 Magnum	29/31	10	1270J	3/4	24.1g	.94g	20.1g	2:1	11	356m/sec	902g	24.6cm/875g	I
.44 Magnum	30/32	11	1400J	3/4	23.9g	.94g	20.1g	2:1	11	374m/sec	864g	22.3cm/752g	I
12ga disc. sabot	35/41	11	2270J	3/4	35.6g	1.53g	29.5g	2:1	11	393m/sec	1170g	17.2cm/738g	I
.30 carbine	36/31	9	1320J	4/4	12.3g	1.09g	7.14g	2:1	11	607m/sec	1020g	43.1cm/1722g	I
.221 Fireball	37/28	11	1070J	4/3	7.0g	.72g	4.10g	3:1	11	724m/sec	729g	38.9cm/1150g	I
.454 Casull	42/45	11	2800J	4/4	23.2g	1.89g	15.6g	2:1	11	610m/sec	1340g	30.7cm/1460g	I
4.92mm caseless	46/32	12	1400J	5/3	3.27g	.86g	2.41g	3:1	11	1080m/sec	768g	44.4cm/1330g	III
5.56mm NATO	46/35	10	1640J	5/3	9.2g	1.21g	4.00g	3:1	11	906m/sec	1060g	56.1cm/2270g	I
5.56mm NATO	49/36	11	1790J	5/3	8.8g	1.21g	4.00g	3:1	11	950m/sec	1010g	50.8cm/1930g	I
5.56mm NATO	51/38	12	1960J	5/3	8.6g	1.21g	4.00g	3:1	11	993m/sec	949g	46.6cm/1650g	I
7.62mm NATO	54/47	10	2990J	5/4	19.7g	2.22g	10.2g	3:1	11	769m/sec	1550g	55.2cm/3020g	I
7.62mm NATO	56/49	11	3290J	5/4	19.1g	2.22g	10.2g	3:1	11	806m/sec	1480g	50.2cm/2590g	I
7.62mm disc. sabot	59/44	11	3290J	6/3	13.9g	2.22g	5.0g	3:1	11	1150m/sec	1480g	50.2cm/2590g	I
7.62mm NATO	59/51	12	3590J	5/4	18.6g	2.22g	10.2g	3:1	11	842m/sec	1390g	46.1cm/2210g	I
6mm Remington	60/46	11	2890J	5/3	12.8g	1.95g	5.0g	3:1	11	1080m/sec	1360g	59.8cm/2890g	I
.338 Magnum	67/62	11	5300J	5/4	29.4g	3.57g	14.6g	3:1	11	854m/sec	2000g	56.6cm/3710g	I
.460 Magnum	82/89	11	10800J	5/4	65.8g	7.27g	36.7g	3:1	11	769m/sec	3130g	59.4cm/11500g	I
12.7mm (.50 cal)	92/104	9	14700J	5/4	86.8g	12.1g	29.9g	3:1	7	993m/sec	4650g	86.1cm/11500g	I
12.7mm (.50 cal)	97/110	10	16400J	5/4	81.9g	12.1g	29.9g	3:1	7	1050m/sec	4520g	77.6cm/9940g	I
12.7mm (.50 cal)	102/115	11	18000J	5/4	78.3g	12.1g	29.9g	3:1	7	1100m/sec	4320g	70.5cm/8510g	I
12.7mm (.50 cal)	107/120	12	19600J	6/4	75.9g	12.1g	29.9g	3:1	7	1150m/sec	4050g	64.6cm/7230g	I
14.5mm Soviet	113/136	9	25100J	6/4	142g	20.7g	44.3g	3:1	7	1060m/sec	6500g	98.5cm/17200g	I
14.5mm Soviet	119/143	10	27900J	6/4	133g	20.7g	44.3g	3:1	7	1120m/sec	6320g	88.7cm/14800g	I
14.5mm Soviet	125/150	11	30700J	6/4	127g	20.7g	44.3g	3:1	7	1180m/sec	6040g	80.6cm/12700g	I
15mm Milo	143/176	12	42000J	6/4	148g	25.9g	49.2g	3:1	7	1310m/sec	6540g	80.0cm/13100g	I
20mm Oerlikon	149/211	10	60800J	5/4	311g	45.0g	117g	3:1	7	1020m/sec	10300g	94.9cm/23400g	I
20mm Oerlikon	157/222	11	66800J	5/4	297g	45.0g	117g	3:1	7	1070m/sec	9860g	86.2cm/20100g	I
20mm Oerlikon	164/231	12	72900J	6/4	288g	45.0g	117g	3:1	7	1120m/sec	9260g	79.1cm/17100g	I

\*Damage Value is formatted as normal 3G<sup>3</sup> value (penetration), followed by the delivered energy value (without projectile diameter factored in).

# Historical Ammunition

## Historical rounds - 3G<sup>3</sup> representations of TL6 to TL8 ammunition

Round name	DV*	TL	Energy	Max. RC	Round	Propellant	Projectile	l/w	sg	Velocity	Rcvr. mass	Barrel len./mass	Malf.
.36 Boot pistol	16/15	7	300J	2/2	-	.32g	4.05g	1:1	11	344m/sec	473g	25.0cm/563g	I
.45 Rochatte Duel.	18/19	7	500J	2/2	-	.53g	8.04g	1:1	11	319m/sec	652g	25.7cm/747g	I
.45 Colt	23/25	8	820J	2/4	23.7g	.76g	16.6g	2:1	11	236m/sec	822g	27.0cm/928g	I
.50 Hawken pistol	23/25	7	860J	2/2	-	.91g	11.1g	1:1	11	353m/sec	918g	30.4cm/1160g	I
.74 Brown Bess	24/32	6	1360J	2/3	-	1.68g	31.0g	1:1	11	247m/sec	1320g	32.5cm/1680g	I
.32-40 Win.	28/26	8	900J	3/4	15.1g	.83g	10.8g	3:1	11	366m/sec	872g	39.5cm/1420g	I
.44 Dragoon	29/30	7	1230J	2/2	-	1.30g	8.83g	1:1	11	387m/sec	1150g	41.2cm/1880g	I
.36 Hawken rifle	29/27	7	1020J	3/2	-	1.08g	4.05g	1:1	11	636m/sec	1022g	45.9cm/1910g	I
.50 Hawken rifle	35/39	7	2050J	3/2	-	2.17g	11.1g	1:1	11	547m/sec	1590g	46.9cm/2760g	I
.58 Enfield	36/43	7	2550J	2/2	-	2.70g	18.1g	1:1	11	353m/sec	1820g	45.1cm/2960g	I
.45-70 Gov't	38/41	8	2310J	3/4	37.5g	2.14g	26.4g	2:1	11	375m/sec	1580g	45.1cm/2600g	I
.53 Hawken rifle	38/44	7	2660J	3/2	-	2.81g	13.3g	1:1	11	571m/sec	1870g	46.0cm/3080g	I
3 pd. Whit. (2.8")	125/332	7	150kJ	3/6	-	159g	3.29kg	2:1	7	302m/sec	23.7kg	71.6cm/36.0kg	I
6 pounder (3.7")	140/429	6	250kJ	3/5	-	309g	2.73kg	1:1	7	429m/sec	35.2kg	88.2cm/61.7kg	I
12 pounder (4.6")	192/606	6	500kJ	3/5	-	617g	5.45kg	1:1	7	429m/sec	54.5kg	100cm/99.0kg	I
20 pd. Parrot (4.2")	220/696	7	660kJ	3/7	-	703g	11.1kg	2:1	7	346m/sec	60.3kg	100cm/106kg	I
32 pounder (6.4")	374/1180	6	1.9mJ	3/6	-	2350g	14.5kg	1:1	7	513m/sec	126kg	141cm/272kg	I
68 pounder (8.0")	514/1630	6	3.6mJ	3/6	-	4440g	30.9kg	1:1	7	484m/sec	189kg	155cm/412kg	I
40 pd. Parrot (6.4")	562/1780	7	4.3mJ	3/8	-	4550g	39.3kg	2:1	7	469m/sec	196kg	168cm/453kg	I
9" Armstrong rifle	831/2630	7	9.4mJ	3/8	-	9950g	113kg	2:1	7	409m/sec	321kg	176cm/701kg	I

## Historical rounds - 3G<sup>3</sup> representations of TL12 to TL15 new or extrapolated ammunition

Round name	DV*	TL	Energy	Max. RC	Round	Propellant	Projectile	l/w	sg	Velocity	Rcvr. mass	Barrel len./mass	Malf.
2mm Screamer	19/9	14	100J	8/1	.21g	.05g	.03g	1:1	7	2590m/sec	109g	23.2cm/139g	III
2mm Screamer	20/9	15	110J	8/1	.20g	.05g	.03g	1:1	7	2720m/sec	96.6g	22.0cm/115g	III
9mm Para max.	23/22	12	650J	3/3	12.0g	.40g	10.5g	2:1	11	353m/sec	473g	16.6cm/339g	I
9mm caseless	24/23	13	700J	3/3	10.9g	.40g	10.5g	2:1	11	366m/sec	434g	15.3cm/283g	I
9/5mm APDS	26/18	12	650J	4/2	4.11g	.40g	2.59g	2:1	11	710m/sec	473g	16.6cm/339g	I
10mm pistol	27/27	12	990J	3/2	16.7g	.61g	14.4g	2:1	11	372m/sec	617g	18.4cm/463g	I
4mm Police	27/17	12	400J	5/2	1.53g	.25g	.59g	2:1	11	1170m/sec	349g	29.3cm/469g	I
5mm electric	34/24	12	800J	5/2	3.66g	.49g	1.80g	2:1	11	945m/sec	540g	33.0cm/747g	I
5mm electric	36/25	13	870J	5/2	3.56g	.49g	1.80g	2:1	11	986m/sec	498g	30.6cm/632g	I
5mm caseless	52/37	13	1840J	6/3	3.88g	1.05g	2.88g	3:1	11	1130m/sec	798g	44.6cm/1340g	III
5mm caseless	54/38	14	1980J	6/3	3.88g	1.05g	2.88g	3:1	11	1180m/sec	716g	41.4cm/1110g	II
7mm assault	62/52	12	3690J	5/4	16.6g	2.28g	7.90g	3:1	11	969m/sec	1410g	50.8cm/2470g	I
7mm assault	65/54	13	4000J	5/4	16.1g	2.28g	7.90g	3:1	11	1010m/sec	1300g	46.9cm/2080g	I
7mm caseless	65/54	13	4040J	5/4	10.2g	2.30g	7.90g	3:1	11	1010m/sec	1310g	47.1cm/2100g	II
7/4.5mm APDS	69/47	12	3690J	7/3	11.2g	2.28g	2.63g	3:1	11	1680m/sec	1410g	50.8cm/2470g	I
7/4.5mm APDS	72/48	13	4000J	7/3	10.7g	2.28g	2.63g	3:1	11	1750m/sec	1300g	46.9cm/2080g	I
10mm big game	94/94	14	12.0kJ	5/4	44.6g	6.35g	23.0g	3:1	11	1020m/sec	2230g	50.9cm/3350g	I
15mm HEAT	103/12	12	200J	2/2	13.8g	.12g	13.3g	2:1	3	174m/sec	225g	5.52cm/62.5g	I
12.7/9mm APDS	123/117	12	20.0kJ	6/4	64.3g	12.3g	18.0g	3:1	11	1493m/sec	4100g	65.1cm/7370g	I
15mm MG	207/254	13	87.8kJ	6/4	245g	54.2g	49.5g	3:1	7	1890m/sec	9110g	107cm/22.2kg	I
15mm MG	215/264	14	94.5kJ	6/4	234g	54.2g	49.5g	3:1	7	1960m/sec	8180g	99.1cm/18.3kg	I
23mm cannon	197/299	12	122kJ	6/5	463g	75.0g	178g	3:1	7	1170m/sec	12.8kg	88.7cm/24.8kg	I
23/15mm APDS	225/276	12	122kJ	8/4	341g	75.0g	58.3g	3:1	7	2050m/sec	12.8kg	88.7cm/24.8kg	I
23/15mm APDS	234/287	13	132kJ	8/4	325g	75.0g	58.3g	3:1	7	2130m/sec	11.8kg	81.9cm/20.8kg	I

### Notes:

- All loose powder weapons have numbers for the maximum safe recommended load for that weapon mass, that is, any extra propellant should increase the malfunction chance. Many loose powder weapons (esp. cannon) were built to handle much greater stresses than the listed energy (the gun and mount would be 4-10x the listed mass of barrel & receiver).
- Action inefficiencies have *not* been applied to the energy figures or DV for *any* round, i.e. you will need to adjust for action type (only applies for SS of TL8-, SA of TL9- and RV of TL12-).
- Base receiver mass, barrel length and mass are all correct for listed energy and propellant quantity. Due to the fact that energies have been slightly rounded, and loose powder projectiles are actually slightly smaller than the bore of the weapon, numbers will not match exactly when reverse calculations are performed. Especially on larger weapons, barrel lengths were typically longer, up to the maximum practical to increase DV.
- All weapon stats are already adjusted for Tech Level. Barrel length is for the propellant mass listed and will give the listed DV for weapons with efficiencies of 1.00. Weapons whose efficiencies are less will have the DV and possibly the aiming RC adjusted downwards, but will be the same mass because they channel the same energy. Receiver mass is for a "generic" receiver, and the action multiple is applied to this number. Discarding sabot rounds use the energy listed for receiver mass, etc., but DV is based on the penetrator (in parenthesis), which has less energy.
- The 5.7mm FN round is lead with a plastic core, and is *not* armor-piercing.

# Conventional Round Design Sheet

## A. Basic Information

- 1a. Basic Description: \_\_\_\_\_
- 2a. Tech Level: \_\_\_\_\_  Cased  Caseless  Binary propell.  Loose
- 2b. Propellant energy at this TL: Line 2a x 135J = \_\_\_\_\_ Joules per gram

## B. Projectile information

- 3a. Projectile diameter \_\_\_\_\_ cm
- 3b. Projectile l/w ratio: \_\_\_\_\_
- 3c. Projectile volume: \_\_\_\_\_ cc
- 3d. Projectile sg: \_\_\_\_\_
- 3e. Projectile mass: \_\_\_\_\_  grams  kilograms
- 3f. Damage RC: \_\_\_\_\_

## C. Propellant information

- 4a. Maximum propellant to projectile volume ratio at this TL for this ammunition type: \_\_\_\_\_
- 4b. Maximum propellant volume: Line 4a x Line 3c = \_\_\_\_\_ cc
- 4c. Maximum propellant mass: Line 4b = \_\_\_\_\_  grams  kilograms
- 4d. Maximum propellant energy: Line 4c x Line 2c = \_\_\_\_\_ Joules
- 4e. Casing mass as multiple of propellant mass: \_\_\_\_\_

## D. Round information

- 5a. Propellant actually used: \_\_\_\_\_  grams  kilograms
- 5b. Propellant energy: Line 5a x Line 2b = \_\_\_\_\_ Joules
- 5c. Projectile velocity:  $(\text{Line 5b}/\text{line 3e})^5 \times 44.84 =$  \_\_\_\_\_ m/sec (assuming 100% efficiency)
- 5d. Aiming RC: \_\_\_\_\_
- 5e. Damage Value:  $((\text{Line 5b} \times .735)/\text{Line 3a})^5 =$  \_\_\_\_\_
- 5f. Casing mass (if any): Line 4e x Line 5a = \_\_\_\_\_  grams  kilograms
- 5g. Total round mass: Line 3e + Line 5a + Line 5f = \_\_\_\_\_  grams  kilograms
- 5h. Propellant fraction used: Line 5a/Line 4c = \_\_\_\_\_ %
- 5i. Reliability Class: \_\_\_\_\_

## E. Payload (if applicable)

- 6a. Type: \_\_\_\_\_ 6b. Volume: \_\_\_\_\_ cc 6c. Effects: \_\_\_\_\_
- 6d. Type: \_\_\_\_\_ 6e. Volume: \_\_\_\_\_ cc 6f. Effects: \_\_\_\_\_
- 6g. Type: \_\_\_\_\_ 6h. Volume: \_\_\_\_\_ cc 6i. Effects: \_\_\_\_\_

## F. Cost

- 7a. Base round cost:  $(DV^2/10,000) + .1 =$  \_\_\_\_\_ Cr 7b. Multipliers: x \_\_\_\_\_ for \_\_\_\_\_  
 x \_\_\_\_\_ for \_\_\_\_\_
- 7c. Total cost/round: Line 7a x Line 7b = \_\_\_\_\_ Cr x \_\_\_\_\_ for \_\_\_\_\_

## G. Summary

- 8a. Tech Level: \_\_\_\_\_ 8b. Caliber: \_\_\_\_\_ mm 8c. Base energy: \_\_\_\_\_ J 8d. Base DV: \_\_\_\_\_
- 8e. Aiming/Damage RC: \_\_\_\_\_ 8f. Cost per round: \_\_\_\_\_ Cr 8g. Mass per round: \_\_\_\_\_  grams  kilograms

## H. Characteristics of weapons firing this round

- 9a. Receiver mass at TL10 (AT/AB): \_\_\_\_\_  grams  kg Receiver mass at TL\_\_\_\_ (AT/AB): \_\_\_\_\_  grams  kg
- 9b. Receiver mass at TL10 (SA): \_\_\_\_\_  grams  kg Receiver mass at TL\_\_\_\_ (SA): \_\_\_\_\_  grams  kg
- 9c. Receiver mass at TL10 (LA): \_\_\_\_\_  grams  kg Receiver mass at TL\_\_\_\_ (LA): \_\_\_\_\_  grams  kg
- 9d. Receiver mass at TL10 (B): \_\_\_\_\_  grams  kg Receiver mass at TL\_\_\_\_ (B): \_\_\_\_\_  grams  kg
- 9e. Receiver mass at TL10 (SS/RV): \_\_\_\_\_  grams  kg Receiver mass at TL\_\_\_\_ (SS/RV): \_\_\_\_\_  grams  kg
- 9f. Receiver length (AT,AB,SA,B, LA): \_\_\_\_\_ cm
- 9g. Base barrel length at TL10: \_\_\_\_\_ cm Base barrel length at TL\_\_\_\_: \_\_\_\_\_ cm
- 9h. Base barrel mass at TL10: \_\_\_\_\_  grams  kg
- 9i. Base reliability class of this weapon: \_\_\_\_\_
- 9j. Maximum rate of fire (+3 Reliability Class): \_\_\_\_\_
- 9k. 80% of maximum rate of fire (+2 Reliability Class): \_\_\_\_\_
- 9l. 60% of maximum rate of fire (+1 Reliability Class): \_\_\_\_\_



# Rocket Round Design Sheet

## A. Basic Information

- 1a. Basic Description: \_\_\_\_\_  
 2a. Tech Level: \_\_\_\_\_  
 2b. Propellant energy at this TL: Line 2a x 135J = \_\_\_\_\_ Joules per gram

## B. Warhead information (if a separate item)

- 3a. Projectile diameter: \_\_\_\_\_ cm  
 3b. Projectile l/w ratio: \_\_\_\_\_  
 3c. Projectile volume: \_\_\_\_\_ cc  
 3d. Projectile sg: \_\_\_\_\_  
 3e. Warhead mass: \_\_\_\_\_  grams  kilograms  
 3f. Damage RC: \_\_\_\_\_  
 3g. Payload description: \_\_\_\_\_  
 3h. Payload volume: \_\_\_\_\_ cc  
 3c. Payload cost: \_\_\_\_\_ Cr

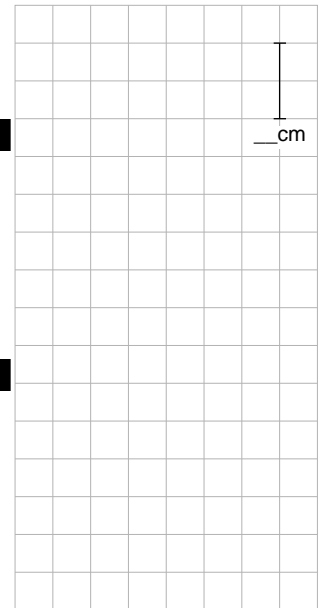

## C. Rocket information

- 4a. Rocket diameter: \_\_\_\_\_ cm  
 4b. Rocket l/w ratio: \_\_\_\_\_  
 4c. Rocket volume: \_\_\_\_\_ cc  
 4d. Rocket sg: \_\_\_\_\_  
 4e. Useable volume: Line 4c x .75 = \_\_\_\_\_ cc  
 4f. Rocket mass: \_\_\_\_\_  grams  kilograms  
 4g. Propellant actually used: \_\_\_\_\_  grams  kilograms  
 4h. Percentage of maximum: \_\_\_\_\_  
 4i. Effective propellant energy: Line 4g x Line 2b/50 = \_\_\_\_\_ Joules  
 4j. Base velocity:  $(\text{Line 4i} / (\text{Line 4f} + \text{Line 3e}))^5 \times 44.84 =$  \_\_\_\_\_ m/sec  
 4k. Adjusted velocity:  $\text{Line 3a}^5 \times \text{total l/w ratio} / 10 \times \text{Line 4j} =$  \_\_\_\_\_ m/sec  
 4l. Aiming RC: \_\_\_\_\_  
 4m. Damage RC: \_\_\_\_\_  
 4n. Total mass: Line 4f + Line 3e = \_\_\_\_\_  grams  kilograms

## D. Damage

- 5a. Impact Damage Value:  $(\text{Line 4i} \times .735 / \text{Line 4a})^5 =$  \_\_\_\_\_  
 5b. High explosive Damage Value:  $((\text{Line 3h} \times \text{Line 2b}) / 40)^5 =$  \_\_\_\_\_  
 5c. Shaped charge Damage Value:  $(\text{Line 3h} \times \text{Line 2b} \times 5)^5 =$  \_\_\_\_\_  
 5d. Number of fragments (if any): \_\_\_\_\_  
 5e. Fragment diameter: \_\_\_\_\_ cm  
 5f. Frag. DV:  $((\text{Line 3h} \times \text{Line 2b} \times .735) / \text{Line 5d}) / \text{Line 5e}^5 =$  \_\_\_\_\_  
 5g. Fragment hits on average person at: \_\_\_\_\_ 0m \_\_\_\_\_ 1m \_\_\_\_\_ 2m \_\_\_\_\_ 3m \_\_\_\_\_ 4m \_\_\_\_\_ 5m \_\_\_\_\_ 6m

## E. Cost

- 6a. Base round cost:  $(\text{DV}^2 / 10,000) + .1 =$  \_\_\_\_\_ Cr  
 6b. Multipliers: x \_\_\_\_\_ for \_\_\_\_\_  
 x \_\_\_\_\_ for \_\_\_\_\_  
 6c. Total cost/round: Line 6a x Line 6b = \_\_\_\_\_ Cr  
 x \_\_\_\_\_ for \_\_\_\_\_

## F. Summary

- 7a. Tech Level: \_\_\_\_\_ 7b. Caliber: \_\_\_\_\_ mm 7c. Base energy: \_\_\_\_\_ J 6d. Base DV: \_\_\_\_\_  
 7e. Aiming/Damage RC: \_\_\_\_\_ 7f. Cost per round: \_\_\_\_\_ Cr 7g. Mass per round: \_\_\_\_\_  grams  kilograms

## G. Characteristics of weapons firing this round

- 8a. Receiver mass at TL10 (AT/AB): \_\_\_\_\_  grams  kg Receiver mass at TL\_\_\_\_ (AT/AB): \_\_\_\_\_  grams  kg  
 8b. Receiver mass at TL10 (SA): \_\_\_\_\_  grams  kg Receiver mass at TL\_\_\_\_ (SA): \_\_\_\_\_  grams  kg  
 8c. Receiver mass at TL10 (LA): \_\_\_\_\_  grams  kg Receiver mass at TL\_\_\_\_ (LA): \_\_\_\_\_  grams  kg  
 8d. Receiver mass at TL10 (B): \_\_\_\_\_  grams  kg Receiver mass at TL\_\_\_\_ (B): \_\_\_\_\_  grams  kg  
 8e. Receiver mass at TL10 (SS/RV): \_\_\_\_\_  grams  kg Receiver mass at TL\_\_\_\_ (SS/RV): \_\_\_\_\_  grams  kg  
 8f. Receiver length (AT,AB,SA,B, LA): \_\_\_\_\_ cm  
 8g. Base barrel length at TL10: \_\_\_\_\_ cm Base barrel length at TL\_\_\_\_: \_\_\_\_\_ cm  
 8h. Base barrel mass at TL10: \_\_\_\_\_  grams  kg  
 8i. Base reliability class of this weapon: \_\_\_\_\_ 8j. Maximum rate of fire: \_\_\_\_\_ rounds per second













# Design Aids

## 3G<sup>3</sup> Design Aid Sheet #1

### Tech Level information

TL	Date	Powder	Propellant ratio				Action efficiency			Electrical power			
			Loose	Cased	Caseless	Casing	B/SS/LA	SA/AT/AB	RV	Capacitors	Supercond.	Batteries	Solar
1	Prehistoric	135J/g	2	-	-	-	.12	n/a	.08	n/a	n/a	n/a	n/a
2	10,000BC	270J/g	4	-	-	-	.24	n/a	.16	n/a	n/a	n/a	n/a
3	3,000BC	405J/g	6	-	-	-	.36	n/a	.24	n/a	n/a	n/a	n/a
4	0AD	540J/g	8	2	-	8.3	.48	.40	.32	n/a	n/a	n/a	n/a
5	1400AD	675J/g	10	4	-	6.3	.60	.50	.40	n/a	n/a	n/a	n/a
6	1700AD	810J/g	12	6	-	5.6	.72	.60	.48	n/a	n/a	n/a	n/a
7	1800AD	945J/g	14	8	-	4.8	.84	.70	.56	n/a	n/a	n/a	n/a
8	1900AD	1080J/g	16	10	-	4.2	.96	.80	.64	.4J/g	n/a	100J/g	.01J/cm <sup>2</sup>
9	1940AD	1215J/g	18	12	-	3.7	1.00	.90	.72	.8J/g	n/a	200J/g	.02J/cm <sup>2</sup>
10	1960AD	1350J/g	20	14	2	3.3	1.00	1.00	.80	1.2J/g	n/a	400J/g	.02J/cm <sup>2</sup>
11	1980AD	1485J/g	22	16	4	3.0	1.00	1.00	.88	1.6J/g	n/a	700J/g	.03J/cm <sup>2</sup>
12	2000AD	1620J/g	24	18	6	2.8	1.00	1.00	.96	2.0J/g	n/a	1100J/g	.03J/cm <sup>2</sup>
13	2100AD	1755J/g	26	20	8	2.6	1.00	1.00	1.00	2.4J/g	125J/g	1600J/g	.04J/cm <sup>2</sup>
14	2200AD	1890J/g	28	22	10	2.4	1.00	1.00	1.00	2.8J/g	250J/g	2200J/g	.04J/cm <sup>2</sup>
15	2300AD	2025J/g	30	24	12	2.2	1.00	1.00	1.00	3.2J/g	375J/g	2900J/g	.05J/cm <sup>2</sup>

### Projectile information

Diameter	Units volume (cm <sup>3</sup> )				sg=3 (HE, sabots, aluminum)				sg=7 (iron, steel)				sg=11 (lead, depl. uranium)			
	1:1	2:1	3:1	10:1	1:1	2:1	3:1	10:1	1:1	2:1	3:1	10:1	1:1	2:1	3:1	10:1
1.0mm	-	.001	.002	.008	.002g	.004g	.006g	.023g	.004g	.009g	.015g	.053g	.006g	.014g	.023g	.084g
1.5mm	.002	.004	.007	.026	.005g	.013g	.021g	.077g	.012g	.031g	.049g	.179g	.019g	.049g	.078g	.282g
2.0mm	.004	.010	.017	.061	.013g	.031g	.050g	.182g	.029g	.073g	.117g	.425g	.046g	.115g	.184g	.668g
2.5mm	.008	.020	.033	.119	.025g	.061g	.098g	.356g	.057g	.143g	.229g	.83g	.090g	.225g	.360g	1.30g
3.0mm	.014	.035	.057	.205	.042g	.106g	.170g	.615g	.099g	.247g	.396g	1.43g	.156g	.389g	.622g	2.25g
3.5mm	.022	.056	.090	.326	.067g	.168g	.269g	.977g	.157g	.393g	.629g	2.28g	.247g	.617g	.988g	3.58g
4.0mm	.034	.084	.134	.486	.101g	.251g	.402g	1.46g	.235g	.586g	.938g	3.40g	.369g	.922g	1.47g	5.34g
4.5mm	.048	.119	.191	.692	.143g	.358g	.573g	2.08g	.334g	.835g	1.34g	4.84g	.525g	1.31g	2.10g	7.61g
5.0mm	.065	.164	.262	.949	.196g	.491g	.785g	2.85g	.458g	1.15g	1.83g	6.64g	.720g	1.80g	2.88g	10.4g
5.5mm	.087	.218	.348	1.26	.261g	.653g	1.05g	3.79g	.610g	1.52g	2.44g	8.84g	.958g	2.40g	3.83g	13.9g
6.0mm	.113	.283	.452	1.64	.339g	.848g	1.36g	4.92g	.792g	1.98g	3.17g	11.5g	1.24g	3.11g	4.98g	18.0g
6.5mm	.144	.359	.575	2.08	.431g	1.08g	1.73g	6.25g	1.01g	2.52g	4.03g	14.6g	1.58g	3.95g	6.33g	22.9g
7.0mm	.180	.449	.718	2.60	.539g	1.35g	2.16g	7.81g	1.26g	3.14g	5.03g	18.2g	1.98g	4.94g	7.90g	28.7g
7.5mm	.221	.552	.884	3.20	.663g	1.66g	2.65g	9.61g	1.55g	3.87g	6.18g	22.4g	2.43g	6.07g	9.72g	35.2g
8.0mm	.268	.670	1.07	3.89	.804g	2.01g	3.22g	11.7g	1.88g	4.69g	7.51g	27.2g	2.95g	7.37g	11.8g	42.8g
8.5mm	.322	.804	1.29	4.66	.965g	2.41g	3.86g	14.0g	2.25g	5.63g	9.00g	32.6g	3.54g	8.84g	14.2g	51.3g
9.0mm	.382	.954	1.53	5.53	1.15g	2.86g	4.58g	16.6g	2.67g	6.68g	10.7g	38.7g	4.20g	10.5g	16.8g	60.9g
9.5mm	.449	1.12	1.80	6.51	1.35g	3.37g	5.39g	19.5g	3.14g	7.86g	12.6g	45.6g	4.94g	12.4g	19.8g	71.6g
10mm	.524	1.31	2.09	7.59	1.57g	3.93g	6.28g	22.8g	3.67g	9.16g	14.7g	53.2g	5.76g	14.4g	23.0g	83.5g
11mm	.697	1.74	2.79	10.1	2.09g	5.23g	8.36g	30.3g	4.88g	12.2g	19.5g	70.7g	7.67g	19.2g	30.7g	111g
12mm	.905	2.26	3.62	13.1	2.71g	6.79g	10.9g	39.4g	6.33g	15.8g	25.3g	91.8g	9.95g	24.9g	39.8g	144g
13mm	1.15	2.88	4.60	16.7	3.45g	8.63g	13.8g	50.0g	8.05g	20.1g	32.2g	117g	12.7g	31.6g	50.6g	184g
14mm	1.44	3.59	5.75	20.8	4.31g	10.8g	17.2g	62.5g	10.1g	25.1g	40.2g	146g	15.8g	39.5g	63.2g	229g
15mm	1.77	4.42	7.07	25.6	5.30g	13.3g	21.2g	76.9g	12.4g	30.9g	49.5g	179g	19.4g	48.6g	77.8g	282g
16mm	2.14	5.36	8.58	31.1	6.43g	16.1g	25.7g	93.3g	15.0g	37.5g	60.1g	218g	23.6g	59.0g	94.4g	342g
18mm	3.05	7.63	12.2	44.3	9.16g	22.9g	36.6g	133g	21.4g	53.4g	85.5g	310g	33.6g	84.0g	134g	487g
20mm	4.19	10.5	16.8	60.7	12.6g	31.4g	50.3g	182g	29.3g	73.3g	117g	425g	46.1g	115g	184g	668g
23mm	6.37	15.9	25.6	92.4	19.1g	47.8g	76.5g	277g	44.6g	111g	178g	647g	70.1g	175g	280g	1020g
25mm	8.18	20.5	32.7	119.	24.5g	61.4g	98.2g	356g	57.3g	143g	229g	830g	90.0g	225g	360g	1310g
27mm	10.3	25.8	41.2	149.	30.9g	77.3g	124g	448g	72.1g	180g	289g	1050g	113g	283g	454g	1640g
30mm	14.1	35.3	56.6	205.	42.4g	106g	170g	615g	99.0g	247g	396g	1440g	156g	389g	622g	2260g

For larger diameters: For double diameter, multiply all figures by 8, for triple diameter, multiply by 27, for quadruple, multiply by 64. For diameter in cm: Multiply all figures by 1000.

### Range Class information

Aiming	Velocity(m/sec)				Damage	Mass/Diam <sup>2</sup>	sg3 diameter(mm)				sg7 diameter(mm)				sg11 diameter(mm)			
	1:1	2:1	3:1	10:1			1:1	2:1	3:1	10:1	1:1	2:1	3:1	10:1	1:1	2:1	3:1	10:1
RC1	200	150	100	50	RC1	<.050	31.0	12.5	7.5	2.0	13.5	5.0	3.0	.5	8.5	3.0	2.0	.5
RC2	400	300	250	100	RC2	.051-.100	63.0	25.0	15.5	4.0	27.0	10.5	6.5	1.5	17.0	6.5	4.0	1.0
RC3	750	600	400	250	RC3	.101-.150	95.0	38.0	23.0	6.5	41.0	16.0	10.0	2.5	26.0	10.0	6.5	1.5
RC4	1100	900	750	500	RC4	.151-.300	191	76.0	47.0	13.0	81.0	32.0	20.0	5.5	52.0	20.0	13.0	3.5
RC5	1500	1300	1100	800	RC5	.301-500	318	127	79.0	21.0	136	54.0	34.0	9.0	86.0	34.0	21.0	5.5
RC6	2000	1750	1500	1150	RC6	.501-750	-	190	119	32.0	204	81.0	51.0	14.0	130	52.0	32.0	8.5
RC7	2600	2300	2000	1600	RC7	.751-1.05	-	267	167	46.0	286	114	71.0	19.5	182	72.0	45.0	12.5
RC8	—anything higher than RC7—				RC8	>1.05	—any projectile too large to be RC7—											

# Design Aids

## 3G<sup>3</sup> Design Aid Sheet 2

### Receiver and barrel information

Energy	Conventional weapon receiver, TL10					Laser TL10	P-beam TL12	Railgun TL10	Conventional weapon barrel mass, TL10							
	AT/AB	SA	LA	B	RV/SS				5cm	10cm	15cm	20cm	30cm	40cm	50cm	100cm
200J (.22LR)	422g	253g	211g	169g	84g	943g	1130g	1410g	71g	141g	212g	283g	424g	566g	707g	1410g
400J (.38 Spec.)	654g	392g	327g	261g	131g	1330g	1600g	2000g	100g	200g	300g	400g	600g	800g	1000g	2000g
600J (9mm Para)	844g	506g	422g	338g	169g	1630g	1960g	2450g	122g	245g	367g	490g	735g	980g	1230g	2450g
800J (.357 Mag.)	1010g	607g	506g	405g	202g	1890g	2260g	2830g	141g	283g	424g	566g	849g	1130g	1410g	2830g
1000J (.41 Mag.)	1160g	699g	582g	466g	233g	2110g	2530g	3160g	158g	316g	474g	632g	949g	1270g	1580g	3160g
1200J	1310g	784g	653g	522g	261g	2310g	2770g	3460g	173g	346g	520g	693g	1040g	1390g	1730g	3460g
1400J (.44 Mag)	1440g	864g	720g	576g	288g	2490g	2990g	3740g	187g	374g	561g	748g	1120g	1500g	1870g	3740g
1600J	1570g	939g	783g	626g	313g	2670g	3200g	4000g	200g	400g	600g	800g	1200g	1600g	2000g	4000g
1800J (5.56mm)	1690g	1010g	843g	674g	337g	2830g	3390g	4240g	212g	424g	636g	849g	1270g	1700g	2120g	4240g
2000J (12ga slug)	1800g	1080g	901g	721g	360g	2980g	3580g	4470g	224g	447g	671g	894g	1340g	1790g	2240g	4470g
2500J (.454 Casull)	2070g	1240g	1040g	830g	415g	3330g	4000g	5000g	250g	500g	750g	1000g	1500g	2000g	2500g	5000g
3000J (.303)	2330g	1400g	1160g	931g	465g	3650g	4380g	5480g	274g	548g	822g	1100g	1640g	2190g	2740g	5480g
3500J (7.62mm)	2560g	1540g	1280g	1030g	513g	3940g	4730g	5920g	296g	592g	887g	1180g	1780g	2370g	2960g	5920g
4000J	2790g	1670g	1390g	1120g	558g	4220g	5060g	6320g	316g	632g	949g	1270g	1900g	2530g	3160g	6320g
4500J	3000g	1800g	1500g	1200g	601g	4470g	5370g	6710g	335g	671g	1010g	1340g	2010g	2680g	3350g	6710g
5000J (.338 Mag.)	3210g	1930g	1610g	1280g	642g	4710g	5660g	7070g	354g	707g	1060g	1410g	2120g	2830g	3540g	7070g
6000J	3600g	2160g	1800g	1440g	720g	5160g	6200g	7750g	387g	775g	1160g	1550g	2320g	3100g	3870g	7750g
7000J	3970g	2380g	1980g	1590g	793g	5580g	6690g	8370g	418g	837g	1260g	1670g	2510g	3350g	4180g	8370g
8000J	4320g	2590g	2160g	1730g	863g	5960g	7160g	8940g	447g	894g	1340g	1790g	2680g	3580g	4470g	8940g
9000J	4650g	2790g	2320g	1860g	930g	6330g	7590g	9490g	474g	949g	1420g	1900g	2850g	3800g	4740g	9490g
10kJ (.460 Mag.)	4970g	2980g	2480g	1990g	993g	6670g	8000g	10.0kg	500g	1000g	1500g	2000g	3000g	4000g	5000g	10.0kg
12kJ	5570g	3340g	2790g	2230g	1110g	7300g	8760g	11.0kg	548g	1110g	1640g	2190g	3290g	4380g	5480g	11.0kg
14kJ	6140g	3680g	3070g	2460g	1230g	7890g	9570g	11.8kg	592g	1180g	1780g	2370g	3550g	4730g	5920g	11.8kg
16kJ	6680g	4010g	3340g	2670g	1340g	8430g	10.1kg	12.7kg	632g	1270g	1900g	2530g	3800g	5060g	6330g	12.6kg
18kJ (12.7mm)	7190g	4320g	3600g	2880g	1440g	8940g	10.7kg	13.4kg	671g	1340g	2010g	2680g	4030g	5370g	6710g	13.4kg
20kJ	7690g	4610g	3840g	3080g	1540g	9430g	11.3kg	14.1kg	707g	1410g	2120g	2830g	4240g	5660g	7070g	14.1kg
25kJ	8850g	5310g	4420g	3540g	1770g	10.5kg	12.6kg	15.8kg	791g	1580g	2370g	3160g	4740g	6330g	7910g	15.8kg
30kJ (14.5mm)	9920g	5950g	4960g	3970g	1990g	11.5kg	13.9kg	17.3kg	866g	1730g	2600g	3460g	5200g	6930g	8660g	17.3kg
35kJ (15mm)	10.9kg	6560g	5470g	4370g	2190g	12.5kg	15.0kg	18.7kg	935g	1870g	2810g	3740g	5610g	7480g	9350g	18.7kg
40kJ	11.9kg	7140g	5950g	4760g	2380g	13.3kg	16.0kg	20.0kg	1000g	2000g	3000g	4000g	6000g	8000g	10.0kg	20.0kg
45kJ	12.8kg	7690g	6410g	5130g	2560g	14.1kg	17.0kg	21.2kg	1060g	2120g	3180g	4240g	6360g	8490g	10.6kg	21.2kg
50kJ (20mm)	13.7kg	8220g	6850g	5480g	2740g	14.9kg	17.9kg	22.4kg	1120g	2240g	3350g	4470g	6710g	8940g	11.2kg	22.4kg

#### For other TL's:

Conventional weapons: Multiply receiver mass by (10-TL)x10%, barrel length by 10/TL, barrel mass by (10-TL)x10%.  
Lasers - Multiply laser tube mass by 3/(TL-7), laser length = (Mass/3)<sup>3/5</sup>((Beam diameter x 2)<sup>5</sup> x 3.1416).  
Particle beams - Multiply accel. mass by 5/(TL-7), accelerator length = (mass/3)<sup>3/5</sup>((Beam diameter x 2)<sup>5</sup> x 3.1416)  
Railguns - Multiply accel. mass by 3/(TL-7), accelerator length = (Mass/6)<sup>3/5</sup>((Projectile diameter x 2)<sup>5</sup> x 3.1416)

#### Common factors:

Accessories are 20% of weapon + receiver + any internal clip (empty).  
Energy weapon maximum ROF is 10 shots per second per barrel/tube  
Batteries cost 1Cr per 100g, solar panels 1Cr per 10cm<sup>2</sup>  
Rechargeable batteries have x.25 energy, x2.0 cost.

Aiming RC	Min. length	Max. ROF		Malfunction chance						Weapon bulk		Initiative	
		Mass	ROF	Class	% propellant	Dud	Jam	Crit.	ROF	Mass per loc.	Bulk	Mass x locs.	Initiative
1	<10cm												
2	10cm	3g	32	VI	Maximum	1	2-4	5-20	+3	<.50kg	VS	<.50kg	+4
3	20cm	5g	29	V	80-99%	11	12-14	15-20	+2	.51-4.0kg	S	.51-1.00kg	+3
4	40cm	10g	25	IV	60-79%	16	17-19	20	+1	4.01-32.0kg	M	1.01-3.00kg	+2
5	80cm	20g	22	III	40-59%	18	19-20	n/a	+0	>32kg	L	3.01-10.0kg	+1
6	150cm	30g	20	II	20-39%	19	20	n/a	+0			10.01-20.0kg	+0
7	300cm	50g	18	I	0-19%	19	20	n/a	+0			20.01-40.0kg	-1
8	600cm	100g	16		+1 class for AT/AB using SA action							40.01-80.0kg	-2

Range (in meters)	0	1	2-3	4-5	6-7	8-10	11-15	16-20	21-25	26-35	36-50	51-70	71-100	101-150	151-200	201-300	301-400	401-600	601-800	801-1000	1.0-1.5K	1.5-2.5K	2.5-3.5K	3.5-4.5K	4.5-6.5K	10K	14K	20K	27K	35K	50K	70K	100K	
RC1 Aiming (snubnose)	+80	+30	+8	+4	+1	+0	-1	-3	-6	-13	-30	-70	-100	-150	-200	-300	-400	-600	-800	-1000	-1.5K	-2.5K	-3.5K	-4.5K	-6.5K	-10K	-14K	-20K	-27K	-35K	-50K	-70K	-100K	
RC1 Damage	+0	+0	+0	+0	-1	-1	-1	-1	-2	-3	-4	-5	-7	-9	-11	-14	-16	-18	-19	-20	-	-	-	-	-	-	-	-	-	-	-	-	-	
RC2 Aiming (regular pistol)	+80	+35	+13	+8	+3	+2	+1	+0	-1	-2	-5	-9	-17	-30	-	-	-	-	-	-	-	-	-	-	-	-	-	-	-	-	-	-	-	
RC2 Damage	+0	+0	+0	+0	+0	-1	-1	-1	-2	-2	-3	-4	-5	-7	-9	-11	-14	-16	-18	-19	-20	-	-	-	-	-	-	-	-	-	-	-	-	-
RC3 Aiming (carbine)	+80	+40	+18	+12	+6	+4	+2	+1	+0	+0	-1	-2	-4	-7	-12	-20	-30	-	-	-	-	-	-	-	-	-	-	-	-	-	-	-	-	-
RC3 Damage	+0	+0	+0	+0	+0	+0	-1	-1	-1	-1	-2	-2	-3	-4	-5	-7	-9	-11	-14	-16	-18	-19	-20	-	-	-	-	-	-	-	-	-	-	-
RC4 Aiming (rifle)	+80	+45	+20	+16	+9	+6	+4	+2	+1	+1	+0	+0	-1	-2	-4	-6	-9	-14	-20	-30	-	-	-	-	-	-	-	-	-	-	-	-	-	-
RC4 Damage	+0	+0	+0	+0	+0	+0	+0	+0	+0	+0	-1	-1	-1	-2	-2	-3	-4	-5	-7	-9	-11	-14	-16	-18	-19	-20	-	-	-	-	-	-	-	-
RC5 Aiming (light cannon)	+80	+50	+26	+19	+13	+9	+6	+4	+3	+2	+1	+1	+0	-1	-1	-2	-3	-5	-8	-11	-16	-24	-34	-48	-	-	-	-	-	-	-	-	-	-
RC5 Damage	+0	+0	+0	+0	+0	+0	+0	+0	+0	+0	+0	-1	-1	-1	-2	-2	-3	-4	-5	-7	-9	-11	-14	-16	-18	-19	-20	-	-	-	-	-	-	-
RC6 Aiming (medium cannon)	+80	+50	+30	+23	+16	+12	+9	+6	+4	+3	+2	+1	+1	+0	-1	-1	-2	-3	-5	-7	-9	-13	-18	-25	-34	-47	-	-	-	-	-	-	-	-
RC6 Damage	+0	+0	+0	+0	+0	+0	+0	+0	+0	+0	+0	+0	-1	-1	-2	-2	-3	-4	-5	-7	-9	-11	-14	-16	-18	-19	-20	-	-	-	-	-	-	-
RC7 Aiming (heavy cannon)	+80	+55	+33	+26	+19	+15	+11	+8	+6	+4	+3	+2	+1	+1	+0	+0	-1	-1	-2	-3	-4	-6	-8	-11	-15	-20	-26	-35	-46	-	-	-	-	-
RC7 Damage	+0	+0	+0	+0	+0	+0	+0	+0	+0	+0	+0	+0	+0	+0	+0	-1	-1	-1	-2	-2	-3	-4	-5	-7	-9	-11	-14	-16	-18	-19	-20	-	-	-
RC8 Aiming (superhvy cannon)	+80	+55	+36	+29	+21	+17	+13	+10	+9	+6	+4	+3	+2	+1	+1	+1	+0	+0	-1	-1	-1	-2	-3	-4	-5	-7	-9	-12	-16	-21	-27	-35	-46	-
RC8 Damage	+0	+0	+0	+0	+0	+0	+0	+0	+0	+0	+0	+0	+0	+0	+0	+0	+0	+0	-1	-1	-1	-2	-2	-3	-4	-5	-7	-9	-11	-14	-16	-18	-19	-



# Illustrations

---

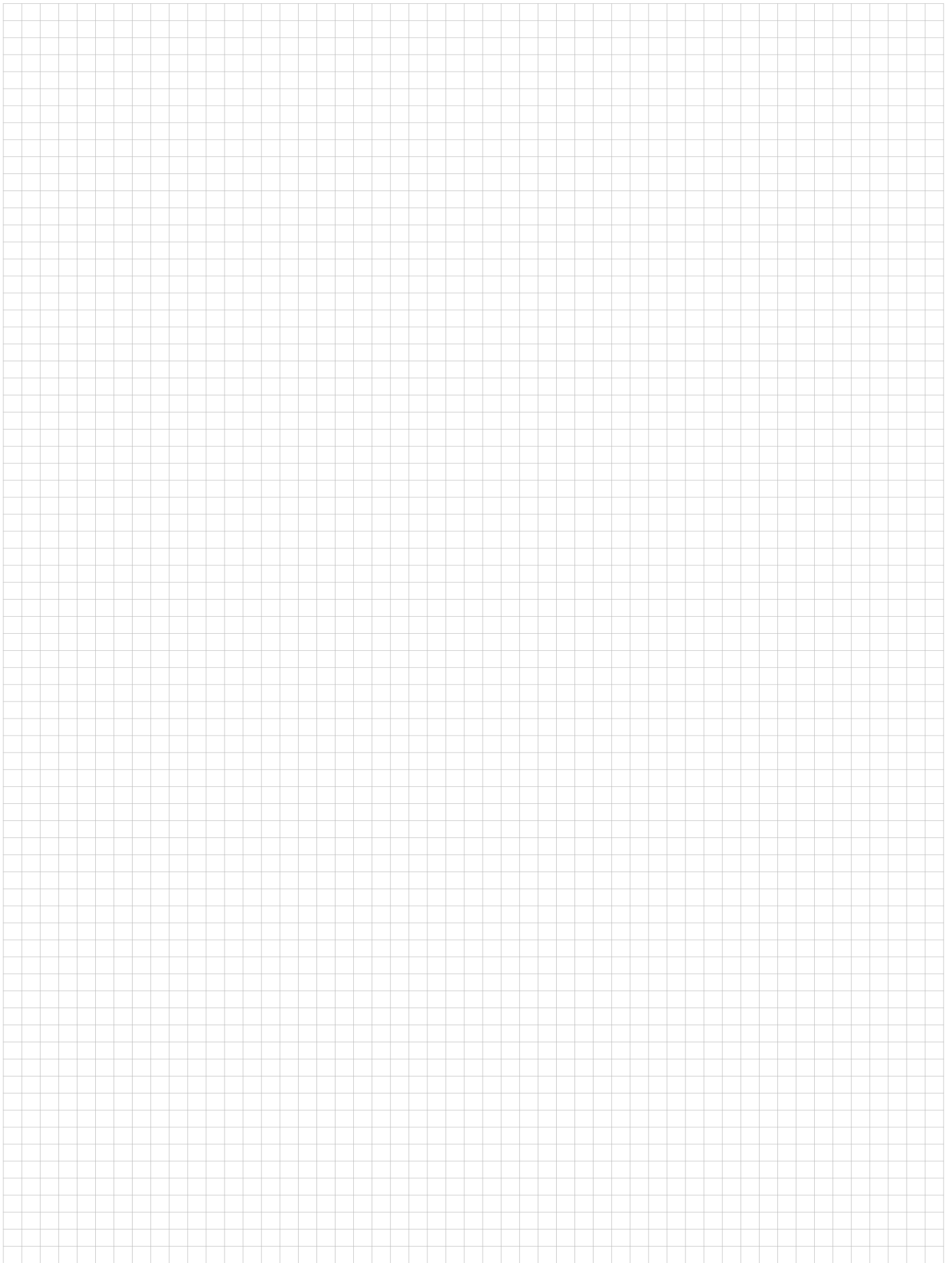

# Size Comparisons

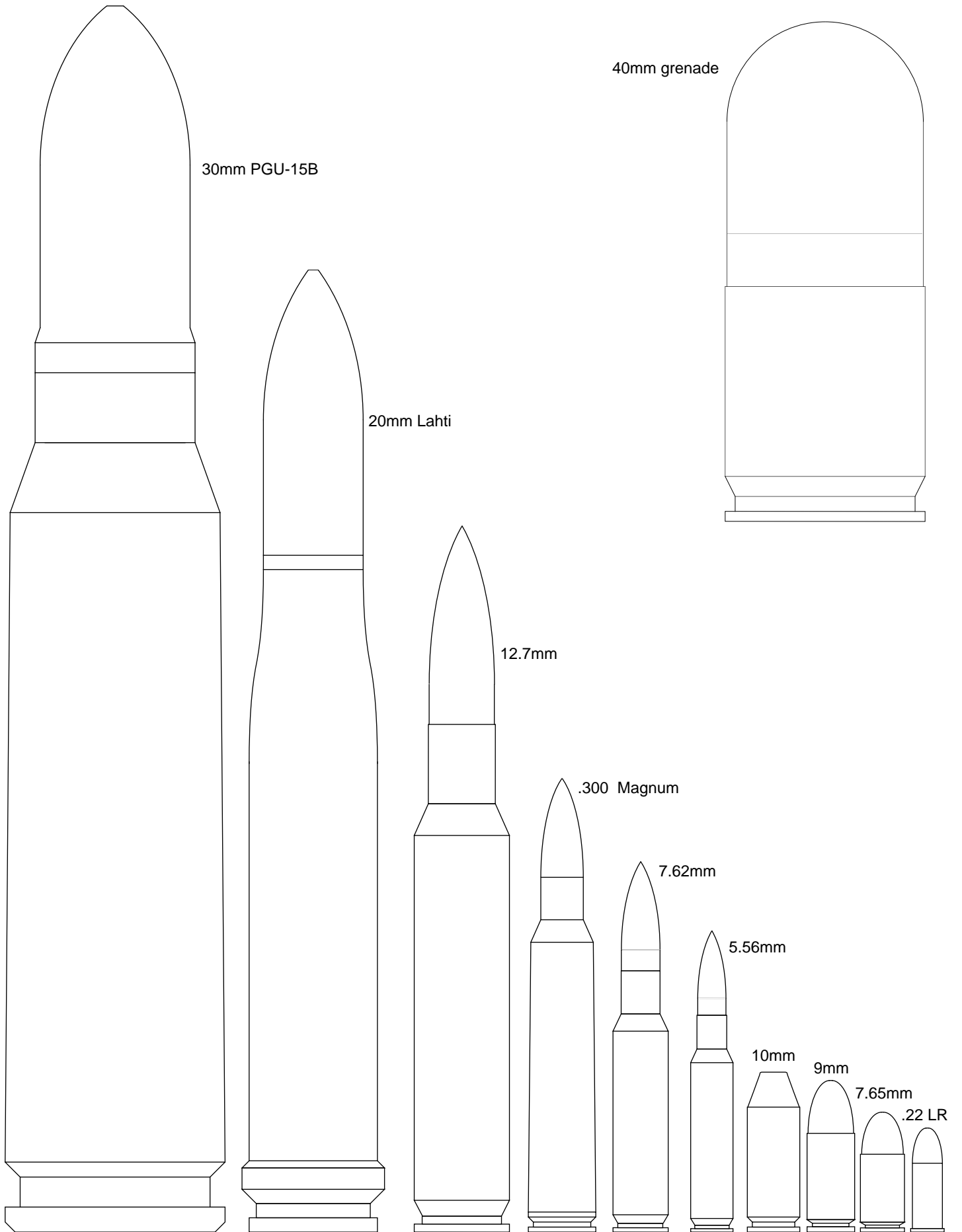



**CORPS**<sup>TM</sup>

Nutshell Edition 1.3

©1994 by Greg Porter

Published by:

BTRC

P.O. Box 1121

Collinsville, VA 24078 USA

All Rights Reserved, etc., etc.

*"Part of being a game designer is the grim knowledge that at any moment you could be replaced by an infinite number of monkeys..."*

Greg Porter

## What is this?

This is the "nutshell" edition of **CORPS**, the **Complete Omniversal Role-Playing System**. It's free for the taking. However, it is copyrighted and you may not sell it, modify it and claim it as your own, and so forth. You may give it away, put it on public access bulletin boards and Internet sites, and write anything you want for the system, so long as you aren't abusing the "personal use" clause of the copyright laws, or charging anyone else for using it or any derivative materials without our written permission.

## The Rules

Enough legal mumbo-jumbo. We don't have a lot of space, so you aren't getting *all* the rules, just enough to design basic characters and get a feel for things. It also shows you just how little you *really* need to learn to use the system.

## Character Generation

Characters are built with Attribute Points (AP) and Skill Points (SP), which are not interchangeable. Everything your character is will be bought with these points. Around 100AP and 50SP is an "average" person, while a heroic fantasy character might start off with 150AP & 150SP. Attribute *and* skill costs are below:

Level	Cost	Average man*	Average woman*
1	1	STR 5	STR 4
2	4	AGL 4	AGL 5
3	9	AWR 4	AWR 4
4	16	WIL 4	WIL 4
5	25	HLT 5	HLT 5
6	36	POW 1	POW 1
7	49		
8	64	*Based on 99AP	
9	81		
10	100		

**Example** - A player wishes their character to have an above average STR attribute, and buys a level of 6. This costs 36 of their AP, points which are used up and no longer available to put towards other attributes or character advantages.

People will usually range in level from 1-10 in each of these attributes, which represent the following:

<b>STR</b>	<b>Strength</b> - physical strength
<b>AGL</b>	<b>Agility</b> - dexterity, coordination
<b>AWR</b>	<b>Awareness</b> - IQ, perception
<b>WIL</b>	<b>Will</b> - toughness, personality, looks
<b>HLT</b>	<b>Health</b> - constitution, recovery, stamina
<b>POW</b>	<b>Power</b> - psychic potential

Each attribute represents raw potential or broad, non-specific experience. This potential gives the characters a low level of skill in *all* areas governed by that attribute. This level of skill is called Aptitude, and is equal to 1/4 the level in the attribute, rounding nearest.

**Example** - A person with AGL 6 (Aptitude 2) would be naturally better at swinging a sword than a person with AGL 4 (Aptitude 1), but would still not be as good as a person who actually had formal training to the mediocre level of 3.

This is important because you buy your skills up from this Aptitude level, so your Aptitude makes skills based off that attribute 1SP cheaper for an Aptitude of 1 (Attribute of 2-5), and 4SP cheaper for an Aptitude of 2 (Attribute of 6-9).

## Skills

Skills are mostly those abilities which you have deliberately trained yourself in, but which often have a physical component or limit, like how good a dancer you are is dependent on your agility. Attributes represent the potential, while skills represent the reality.

Total skill	Description	AWR sample	AGL sample
1	Aptitude	Untrained	Untrained
2	Good Aptitude	Grade school	Yellow belt
3	Hobbyist	High school	Green belt
4		Trade school	Blue belt
5	Serious amateur	Assoc. degree	Red belt
6	Low professional	Bachelor's deg.	
7	Professional		Black belt
8		Master's deg.	3rd level belt
9		Ph.D.	5th level belt
10+	World class	Nobel laureate	

## Skill types

Characters can have several types of skills, with different game effects:

**Free Skills** - You get your native language at your AWR, and your native culture at half your AWR (round up), free of charge. These are considered Primary skills. The GM may also allow other free "everyone has this" skills.

**Familiarity** - Costs 2SP. It represents minimal formal training, and the skill level is still the character's Aptitude. It lets the character use the "out of combat" skill bonus, something characters with just Aptitude may not apply. Familiarity only applies to Primary skill categories, and you may not get Secondary or Tertiary skills if you only have Familiarity.

**Primary Skill** - The broadest skill category, like "Projectile weapons". It has the normal skill cost, *which you subtract your Aptitude bonus from (1 or 4SP)*. You may not have a Primary skill higher than the governing attribute for that skill.

**Secondary Skill** - This is a specialization of a Primary, like "Pistols" is a Secondary of "Projectile weapons". This *adds* to the Primary, but the maximum level you can have is half the Primary, round down (min. of +1). Aptitude *does not* apply to Secondary or Tertiary skills. With GM permission, (skills) may be bought as Primary instead of Secondary skills.

**Tertiary Skill** - This is a specialization of a Secondary, like "Beretta 92F" is a Tertiary of "Pistols". This *adds* to the Secondary, but the maximum level you can have is half the Secondary, round down (min. of +1).

### Difficult Skills

If a skill is harder/easier to learn than normal, the cost to buy the skill is different. This difficulty will add or subtract to the effective level for determining SP cost. For instance, a (+1) skill bought at level 4 would cost like it was bought at level 5. You must spend *some* SP to learn even an easy (-1) skill.

### Skill Trees

Each genre will have a particular set of skills associated with it. A partial example is below.

#### High Fantasy Skill Tree

##### Category (Attribute)

###### Primary skills

Secondary skills

Tertiary skills

##### Combat skills (AGL)

###### Projectile weapons

Bows

Crossbows

Slings

###### Melee weapons

Knife

Sword

Mace/Club

Polearm

Staff

Thrown weapons

Axes

Knives

Spears

Other

###### Unarmed combat

Punch

Kick

Hold

Block

###### Martial Arts(+1)

Punch

Kick

Hold

Block

Dodge

Throw

Lethal blow

#### Vehicle Operation (AGL)

##### Land vehicles

Wagon

##### Water vehicles

Sail ship

Oared ship

##### Equestrian

Particular beast type

#### Medical (AWR)

##### First aid

Medicine(+1)

Veterinary (+1)

#### Trades (AWR)

##### Animal breeder

Purpose or type

##### Armorer

Armor or weapon type

##### Cook

Nationality or cuisine

##### Farmer

##### Mechanic

##### Shipwright

#### Trades (AGL)

##### Blacksmith

##### Carpenter

##### Jeweler

##### Stonemason

##### Locksmith

(Lockpicking)

### Ads & Disads

These are character traits that either gain you AP and/or SP (disads), or cost AP and/or SP (advantages).

**Age** - Gain 2AP & 4SP per year over age 16 (up to age 30).

**Background** - Gain 5AP or SP for a 500 word character description.

**Contacts** - Pay 15SP for a well-placed friend who can do you favors.

**Enemies** - Gain 15SP or AP if you are an outlaw.

**Natural Aptitude** - Pay 10AP to halve the cost of a single attribute (GM permission required).

**Pain Tolerance** - Pay 5AP to ignore non-lethal hits of  $\leq$ WIL Aptitude.

**Physical Ad** - Pay 5AP for +2 in a specific application of an attribute.

**Physical Lim** - Gain 4AP or SP for 2 point penalty on class of actions.

**Psych Lim** - Gain 2AP or SP for minor trait, 8AP or SP for major one.

**Wealth** - Gain 2SP for -1 year of savings, pay 2SP for +1 year.

### Money

Starting money is based on your best employable skill, times itself, times the number of years *after* age 16 where you could reasonably be employed. If you have no employable skills, use the better of STR or AWR and subtract 2 to represent using native strength or wits to make a living.

### Equipment

See the short equipment list on the character sheet at the end of the rules. Otherwise, you're on your own.

#### Academics (AWR)

##### Alchemy

Poisons

##### Architecture

Fortifications

##### Astronomy

(Astrology)

##### Biology

(Herbalism)

##### Economics

(Bribery)

##### Foreign language (specify)

Spoken or written only (-2)

Related language (-1)

##### History

Secret societies (+1)

##### Investigative research

Library research

Bureaucrats

(Streetwise)

##### Law

Nationality

Religious law

##### Military science

Unit tactics

Siege tactics

##### Music

(Specific instrument)

##### Philosophy

Arcane religions

##### Psychology

(Influence)

(Interrogation)

(Seduction)

##### Sorcery

Sorcery type

#### Theater

(Disguise)

(Catfall)

(Pickpocket)

#### Writing

Illumination

#### Area knowledge (AWR)

V.large area/subject (+2)

Large area/subject (+1)

Medium area/subject (+0)

Small area/subject (-1)

V.small area/subject (-2)

#### Environment (AWR)

##### Survival

Warm climate

Cold climate

Dry climate

Urban

##### Hunting

(Stealth)

(Tracking)

#### Environment (HLT)

##### Drinking

##### Running

##### Swimming

##### Climbing

#### Other (?)

##### Sports

##### Hobbies (-2)

## Skill Use

Your skill level in **CORPS** is compared to the adjusted Difficulty of the task being performed. If the skill is  $\geq$  Difficulty, you succeed. If not, you roll 1d10 to check for success. You succeed if you roll an 11 or less, *minus 2 for each point of difference* between your skill and the Difficulty.

**Example** - If your skill is 4 and the Difficulty is 6, you need an 11, minus 4 for the difference of 2 points, or a 7 or less.

## Task Difficulty

For AWR or long-term tasks, apply the following Difficulties:

Task	Difficulty	Base time
Extremely easy	1	1 action
Very easy	2	1 second
Easy (draw or reload a weapon)	3	2 seconds
Average	4	5 seconds
Moderate (pick an average lock)	5	10 seconds
Hard (hotwire a car)	6	20 seconds
Professional level (appraise jewelry)	7	1 minute
Impossible without training	8	2 minutes
Impossible without professional training	12	1 hour
Impossible for just about anyone	16	1 day

While many skills will have specific modifiers, the following list adjusts the Difficulty of most skills.

Task	Modifier
"Out of combat" (low pressure situations)	-2
.5x normal time spent (e.g. fast-draw a pistol)	+1
1x normal time spent (default)	+0
2-4x normal time spent (aiming an extra phase)	-1
5-9x normal time spent (aiming a full turn)	-2
10-16x normal time spent (aiming two full turns)	-3
Fortuitous circumstances (good equipment, etc.)	-1 to -2
Impairing circumstances (no idea how to do it, etc.)	+1 to +5

You can never get more time bonuses than half your Primary skill (round up). For instance, the GM says scaling a wall is Difficulty 5 vs. your AGL Aptitude of 2. If you spend 2x the normal time, the Difficulty goes to 4. Since your Aptitude is 2, you can't get more than a -1 to Difficulty from extra time.

## Combat Basics

All combat proceeds in 1 second turns. Within a turn, characters act in order from highest skill to lowest skill, on Initiative phases, with a new turn after Initiative 0. On an Initiative phase you can make an attack (punch, shoot), a defense (block, parry) or move (start, stop, crouch, dodge). Each action you do in a turn must be separated by at least 2 Initiative phases from the previous action, and each action after the first is a 2 point penalty to Difficulty if there is a skill roll involved. The highest Initiative phase in which you can change your movement status is your AGL Aptitude (usually 1 or 2). You *may* use the same skill more than once per turn. You may accelerate up to 3m during a turn, or decelerate up to 6m, with a maximum running speed of 9m per turn. Facing changes count as 1m movement, moving backwards costs double, and standing up takes all your movement in a turn.

## Ranged Combat

The base Difficulty for hitting a target with a ranged weapon is the square root of the range in meters, plus 2.

Range(m)	0	1	2-4	5-9	10-16	17-25	26-36	37-49	50-64	65-81	82-100
Difficulty	2	3	4	5	6	7	8	9	10	11	12
Firer move	-	+1	+2	+3	+4	+5	+6	+7	+8	+9	+10
Targ. move	-	+1	+1	+2	+2	+3	+3	+4	+4	+5	+5

Your weapon will have a stat called "Range Mod", which will reduce the range-based Difficulty by its level, down to a minimum Difficulty of zero. If either the firer or target is moving, apply Difficulty modifiers based on the distance moved.

## Melee Combat

In melee combat, the base Difficulty to hit is your opponent's AGL Aptitude. This is increased by any penalties *you* have for consecutive actions in a turn. They may also block, which increases the Difficulty by their skill, or parry, which increases it by their skill-1. A block or parry is "used up" once an attack is made against it, and its bonus no longer counts. A dodge allows you to add your AGL Aptitude again, and apply it vs. all types of attack over an entire turn, but you take a penalty of this amount to your own actions.

## Damage

The Damage of an attack increases the Difficulty of performing actions with the part of the body hit, and half that (round down) to adjacent locations. Hit locations are:

Roll	Location	Aim Difficulty
1	Head/neck	+2
2	Right arm	+2
3-4	Chest	+1
5	Left arm	+2
6	Abdomen	+1
7	Upper right leg	+2
8	Upper left leg	+2
9	Lower right leg	+2
10	Lower left leg	+2

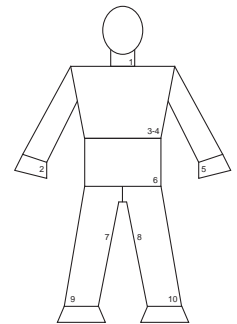

Melee attacks do damage based on STR, and weapons or attack types may adjust damage or location hit.

Melee attacks	Damage Value	Location Mod.
punch damage	STR/4(n)	-2
kick damage	STR/3(n)	+1

## Armor

Armor is rated as two numbers, like x/y. The first number subtracts from *all* damage. The second number takes any *lethal* damage that gets by the first and converts it to *non-lethal* damage. For instance, a 2/4 armor will stop 2 points of bullet damage and make 4 more non-lethal. The second number *does not* affect attacks which are *initially* non-lethal.

## Recovery

Injured characters get back their HLT per day for non-lethal injuries, and HLT per month for lethal ones.

