

# BUILDING YOUR TYPE 40

Greetings, Timelord and thank you for choosing the Type 40 Time Capsule (TARDIS) for your Time and Relative Dimensional travels in Space.

This, as you will know by now is a paper model based on the interior of the time machine, 'TARDIS' from the popular BBC TV science fiction serial, Doctor WHO which ran in the UK from 1963 to 1989 and also spawned several movies.

I have designed this paper model with several factors in mind. Primarily it is meant to be a role-playing aid, so it needed to be compatible with Harlequin miniatures' range of 25mm Doctor WHO figures, and consequently with almost all 25mm scale miniatures and models.

Secondly it needed to be easy to construct, requiring a bare minimum of fairly innocuous tools. Lastly (but not least), it should be reasonably accurate.

Trying to balance these three factors was quite a challenge. Making it 25mm scale was easy. The difficulty was in balancing the simplicity and the accuracy.

The interior of the TARDIS changed almost every time we saw it, and these were not minor changes either. Always there was the same overall scheme; A white or light grey interior of walls that featured recessed roundels of some description. This area was always centred by a hexagonal table-like control console. Beyond this the interior varied wildly.

What I have done is base my design on the early eighties interior as used by Tom Baker's Doctor and Peter Davison's. Again, this interior set changed constantly so I've based my model on the feel of the interior at that point rather than one specific layout.

In the course of making it small and accurate, the model has become somewhat fiddly, with small details and some complex angles and whilst I don't think it requires a Time Lord's intellect to construct, I don't think it'd be much fun for small children.

## WHAT YOU WILL NEED

A PC and a printer. A colour printer capable of printing at at least 150 DPI is preferable but not essential.

Paper Glue. I tend to use glue sticks such as 'Pritt' because they aren't as wet or runny as normal paper glue, however any paper glue will do.

A sharp pair of scissors and or a modelling knife/Scalpel. I tend to use a scalpel with a 10A blade for greater accuracy but scissors, I find, can be more accurate when cutting broad curves.

A straight edge for cutting and scoring. Ideally a steel ruler - especially if you are using a scalpel or modelling knife to cut with, however any straight edge will do.

A cutting mat. This isn't essential but you'll need something (such as thick card) to cut on if you are using an exceptionally sharp blade like a scalpel as it tends to cut the surface under the paper quite badly.

A blunt, pointy instrument for scoring. I tend to use the back edge of the scalpel blade, though something like an old pen with no ink left or a bradawl will do.

# HOW TO PRINT OUT YOUR MODEL SHEETS

Print the sheets off on a colour printer. I have sized each of them to fit exactly on a single sheet of A4. They are intended to be printed at 150 DPI. They are intended to be printed on standard Photocopy/Printer paper but if you can print them on to thin card they will be so much more durable. I have not tested them with card however, and you may find some joints less manageable than if they were printed on paper.

## CONSTRUCTING THE ELEMENTS

### WALL FLATS

I have made the Wall Flats double sided, firstly to make them a little sturdier and secondly so that one side has lit roundels and the other, unlit. The TARDIS walls tended to vary between the two and this way you get both.

I have included several wall sheets that you can mix and match: A sheet of two-column walls, a sheet of three-column walls, a sheet of four-column walls, a sheet of eight-column walls and finally a sheet of 16-column walls. These instructions apply to all of the wall sheets, but I'll use the four-column walls as an example.

Cut carefully around the outside edge of the wall section and then score along the lines highlighted in blue in this example:

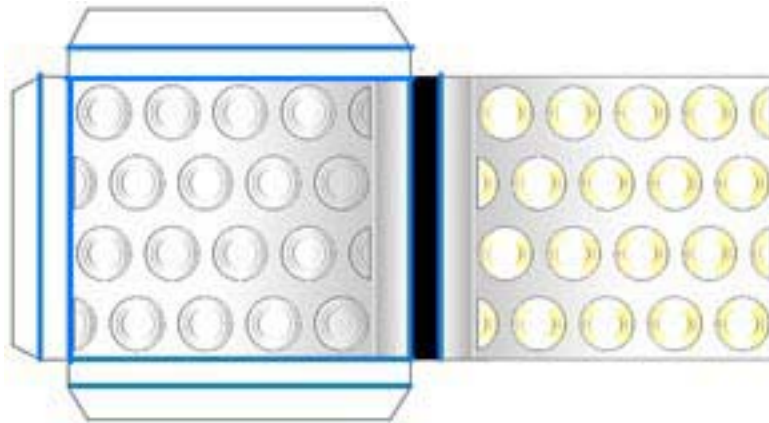

Once this is done, Fold along the scored edges so that the whole piece folds in to a narrow box like so:

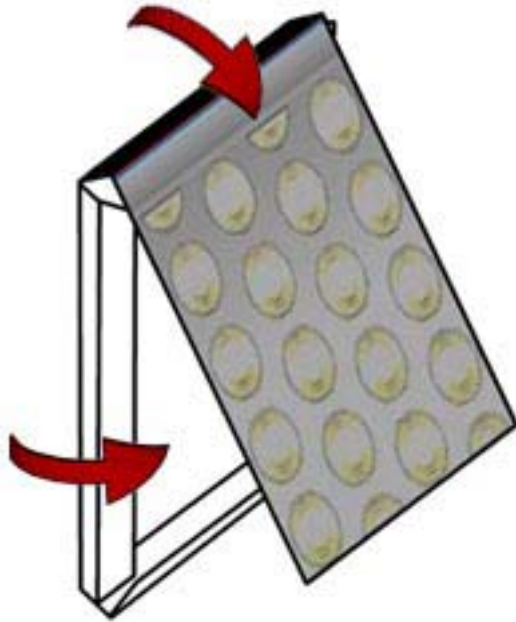

The end result should look something like this:

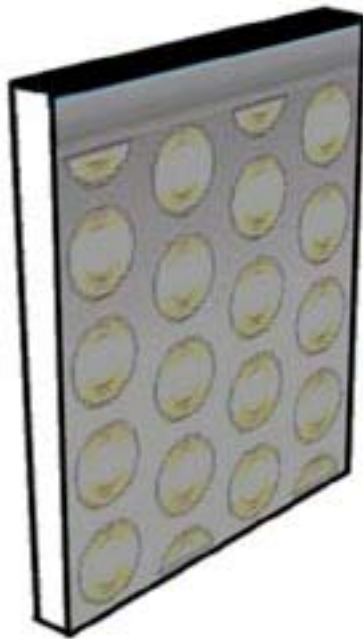

Something I found useful (but not essential) when making these walls - especially with the bigger ones - is to cut a long strip of paper 3mm wide and coil it into a zig-zag and insert it into the wall unit before I sealed up the final tab like so:

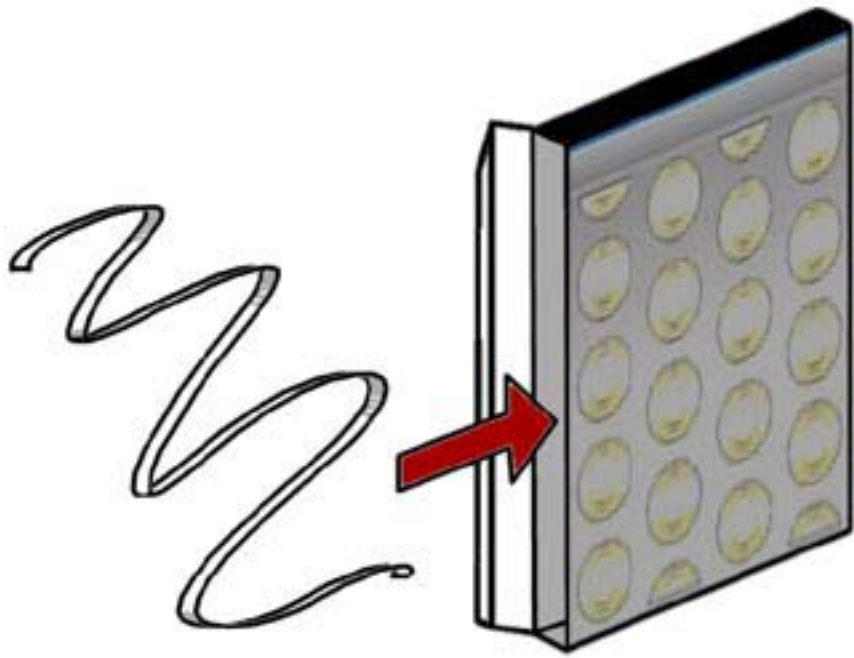

This helps strengthen the wall sections and prevents crushing.

---

## PILLARS

The Pillars are used to join wall sections and create corners. They varied in diameter in some versions of the TARDIS interior but I've created a uniform size for ease. The Pillar comes in two pieces like this:

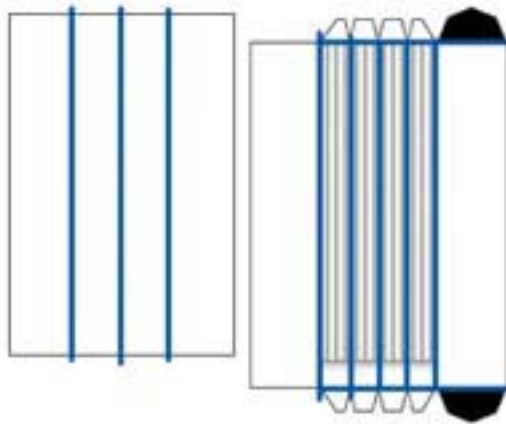

The main piece with the Pillar fluting and tabs is actually the model of the pillar. The sectioned rectangle next to it is a triangular piece that fits inside to strengthen it.

Carefully cut around the outside edge of the two pillar pieces and score along the lines indicated in blue in the above image. Now fold the pillar piece along those lines around on itself so that the two wider panels either side overlap each other at the back like

this:

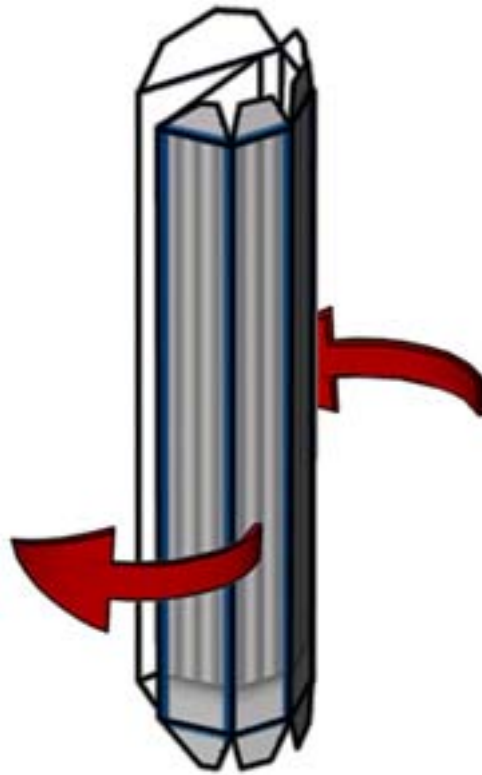

Next fold the other piece similarly like so:

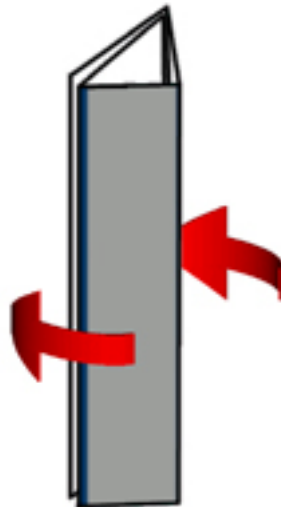

Now place this triangular piece into the centre of the pillar. The broader side of the triangle should be at the back of the pillar.

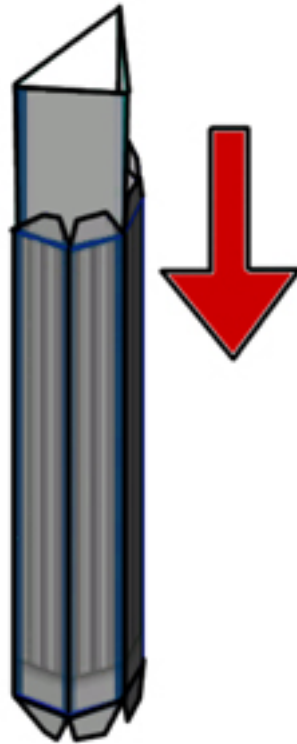

Once inside, fold down the tabs on either end, first the small ones and then the larger one over the top of them:



Your end result should look something like this:



---

## MAIN DOOR

As with the rest of the TARDIS interior the main doors changed from time to time but did stay largely the same for most of the eighties - which is the version I've used as reference.

Firstly cut carefully around the outside of the three Main Door pieces - these are two doors and the wall. Also cut where I have marked in red. Finally score the lines I have marked in blue.

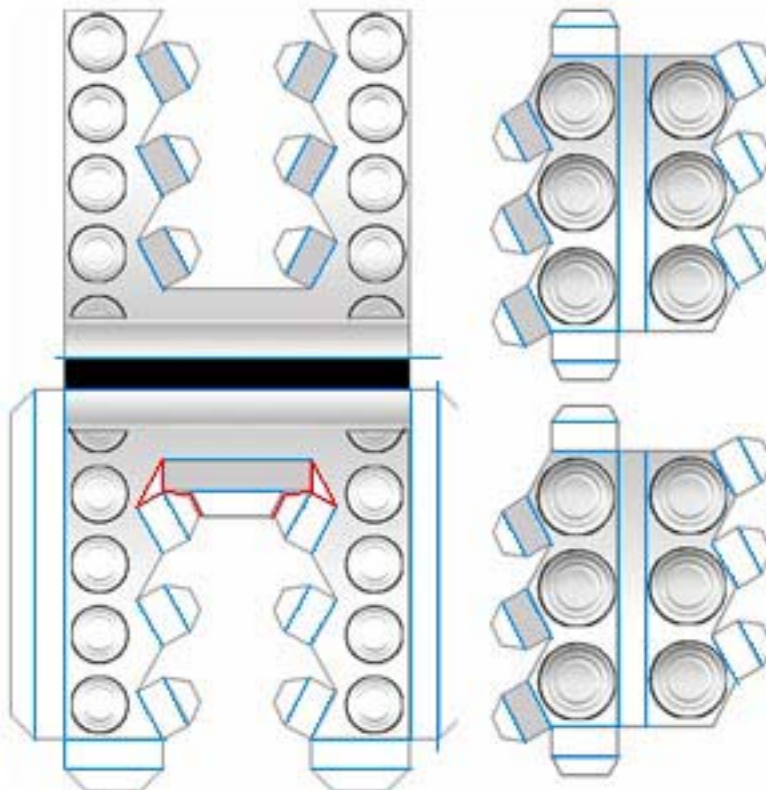

Now firstly we will deal with the wall. Fold all the scored edges starting with the centre lines like this:

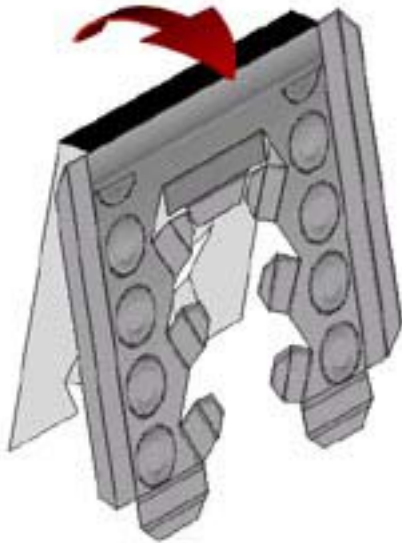

Next, fold the bottom edges under and glue the tabs inside the opposite face like so:

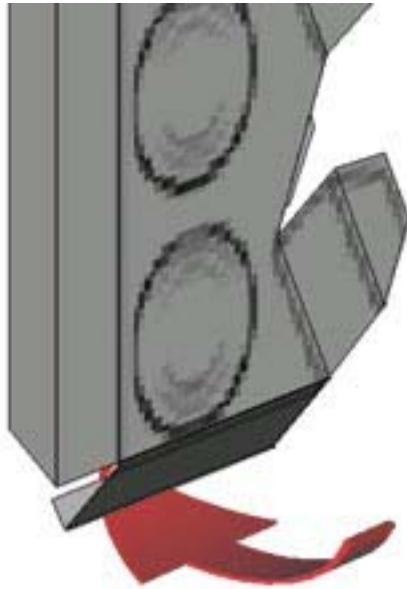

Once this is dry, repeat the process with the inner edges. They should interlock as they fold in. This can be tricky and I found the tweezers very useful here for holding the tabs down whilst the glue dried.



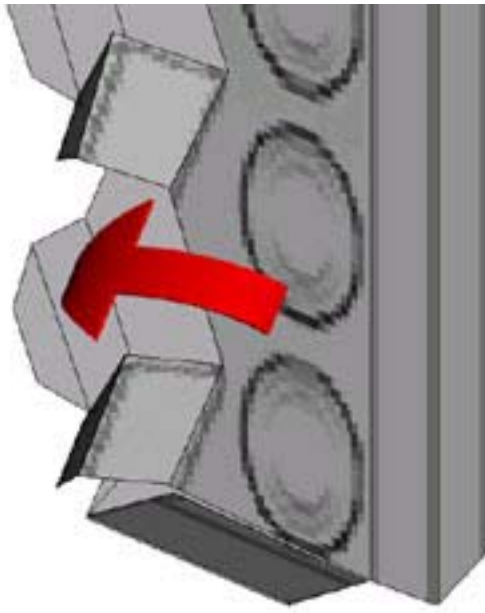

Next fold the top edge of the door frame under, once again gluing the tab inside the opposite face.



Lastly, fold in the two side edges and again, glue the tabs inside the opposite face:

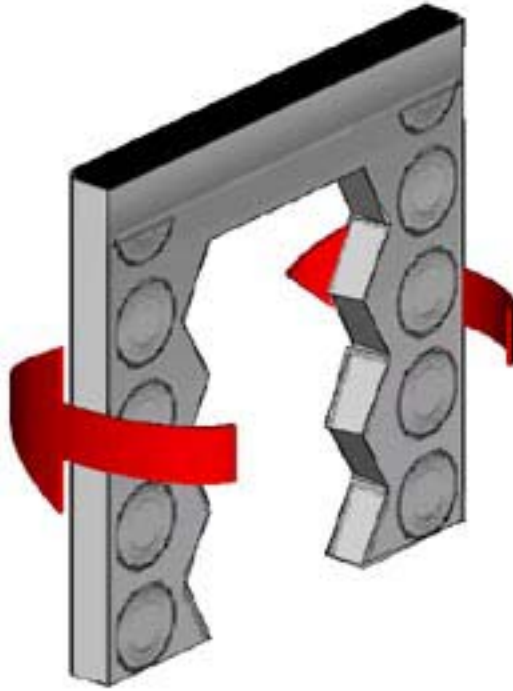

Next come the door sections. Take one of the door pieces and fold it along the centre lines like so:

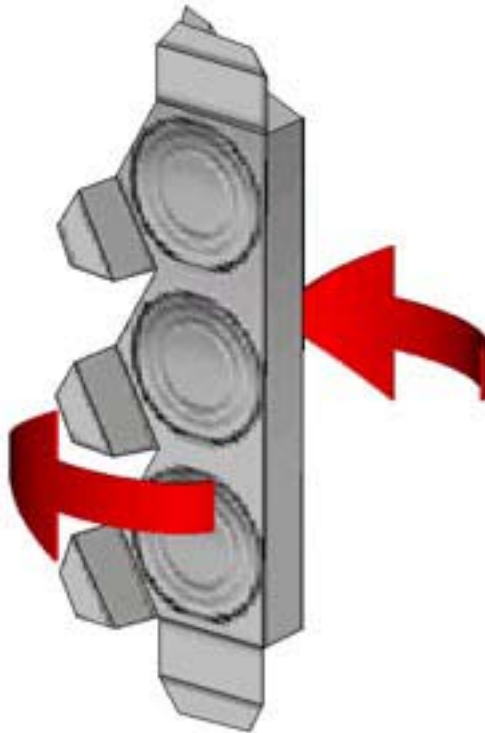

Next, fold the edge pieces in so that they interlock and glue the tabs to the inside of the opposite edge.

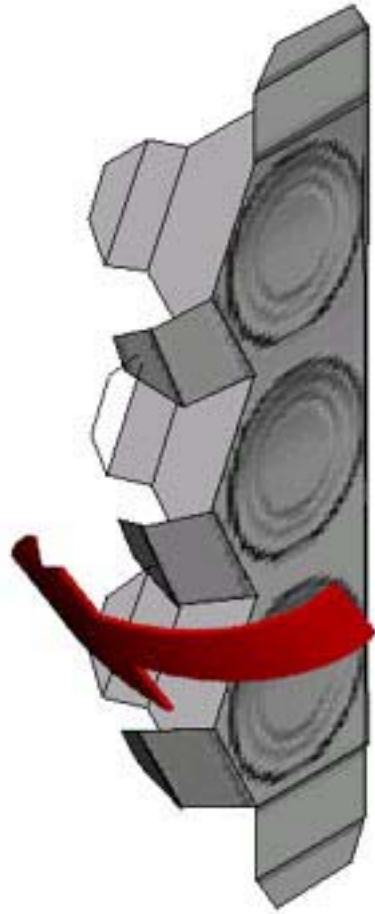

Finally fold the top and bottom pieces over and glue the tabs to the inside of the opposite face.

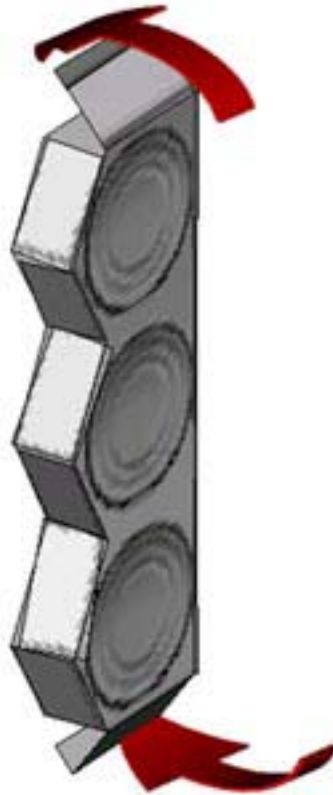

Repeat the process with the other door piece and you should end up with something like this:

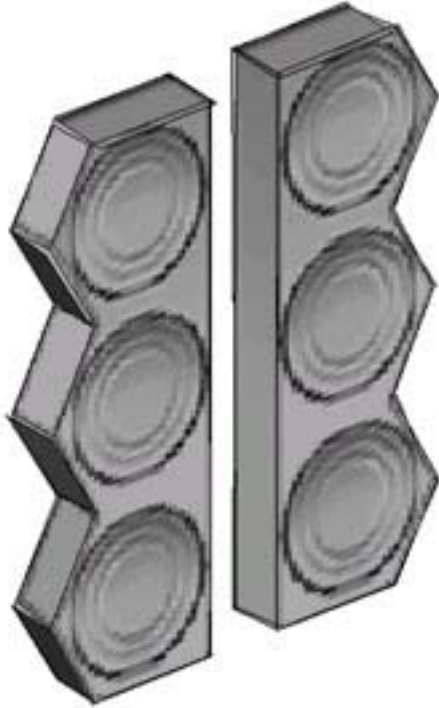

Finally Put the three pieces together. In order to make the doors work, I suggest glueing four pieces of paper to each corner to act as hinges like this:

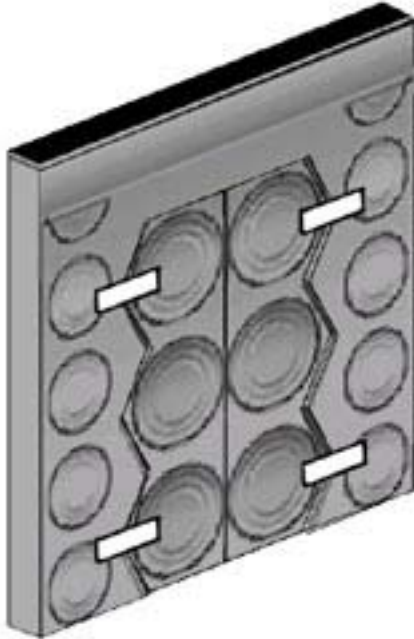

# MONITOR

The Monitor is designed to work with operational shutters and several interchangeable space exterior scenes. Begin, as usual by cutting careful around the outside of all the monitor pieces and where I have marked the pieces with red. Next score along the lines marked in blue.

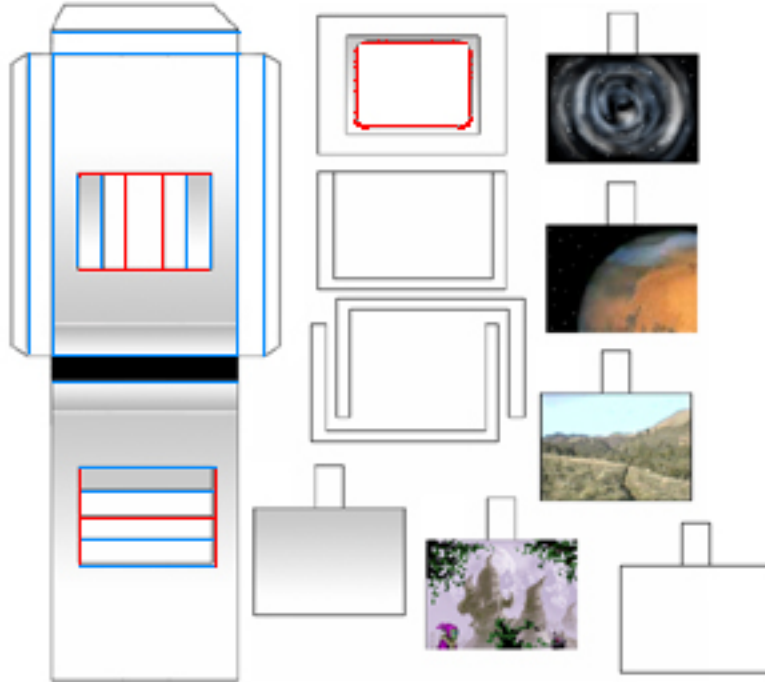

Begin by folding along the center line to create the two sides like so:

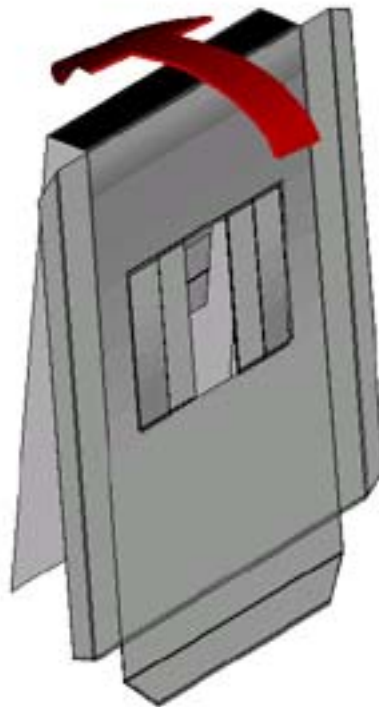

Next fold the sides of the monitor screen recess inwards and glueing the tabs to the inside of the opposite face:

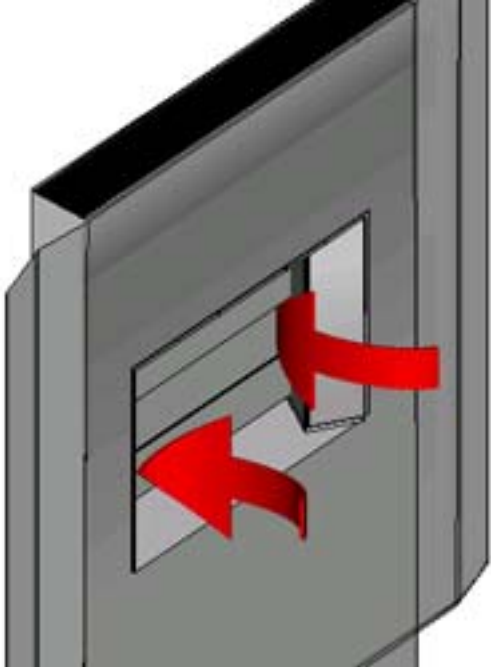

Next repeat the process on the other side with the upper and lower recess edges:

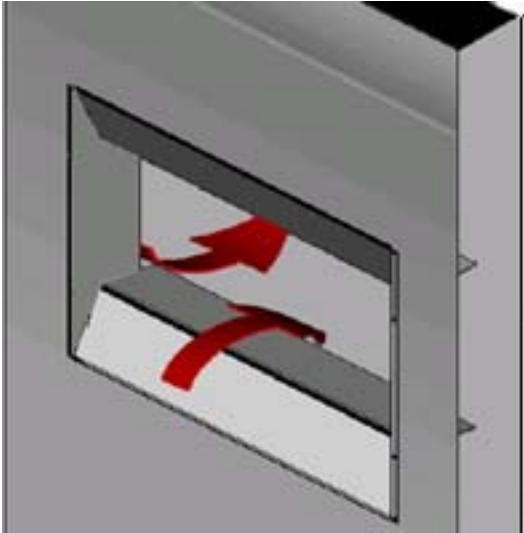

Finally fold the side and bottom pieces round and glue the tabs inside the opposite face.

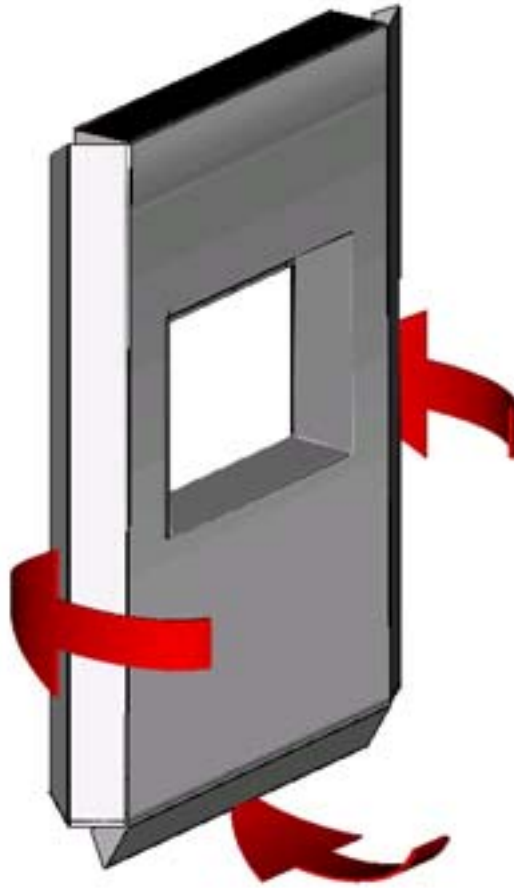

Now glue the three monitor backing pieces on in this order:

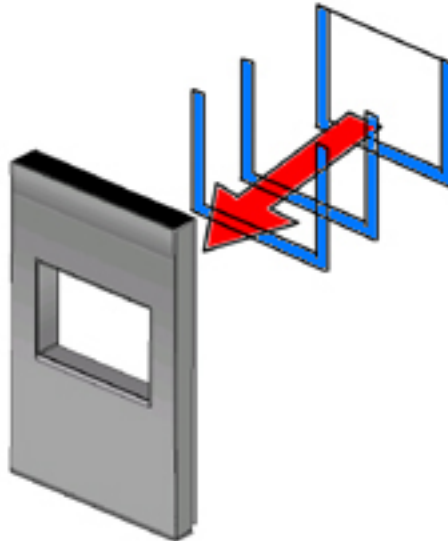

The two 'U' shaped pieces should create a reasonable gap between the Monitor wall unit and the final backing piece. Apply glue only where I have indicated in blue.

The Unit is now finished. Insert one of the Viewer images into the backing with the Viewer cover as shown. Use the tab on the Viewer cover to raise the cover and reveal the image behind.



---

## INTERIOR DOORS

There are two types of interior door: Single and Double. These instructions apply to both types, though I will use a single interior door section as an example.

First, as usual cut carefully around the two pieces of the interior door including the areas I have marked in red:

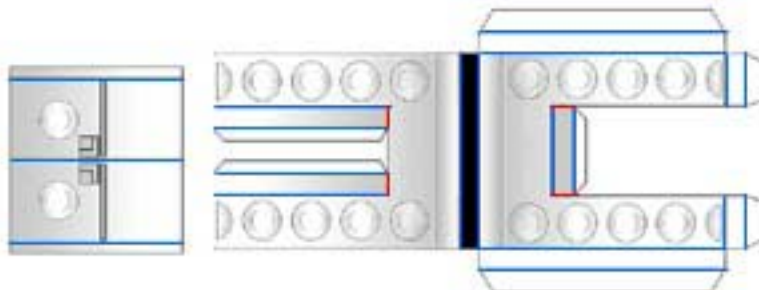

Score all the lines I have marked in blue in the above example. Starting with the main wall piece, fold it along its centre lines like



this:

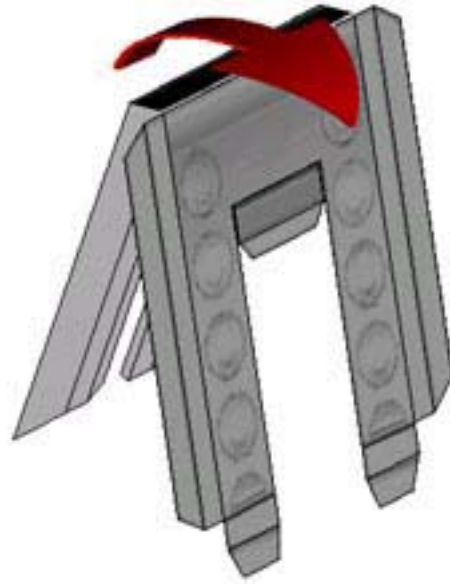

Now fold the inner doorframe edges inwards and glue their tabs on the opposite faces as shown in the diagram:

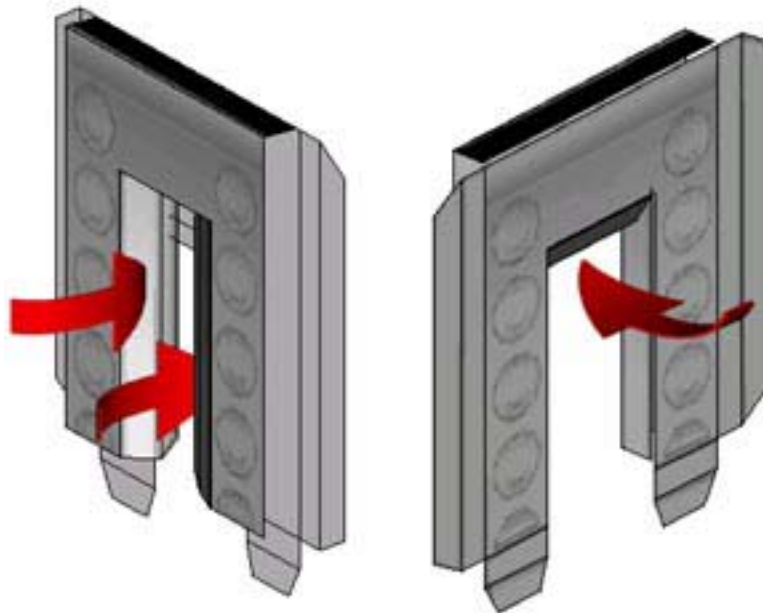

Next, Fold the bottom and sides in and do the same:

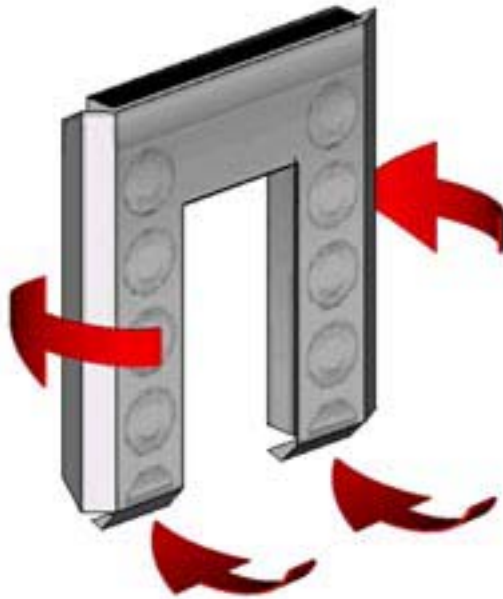

Now take the second piece and fold it in half, glueing the two broader faces together - make sure you don't get any glue on the narrower tabs yet.

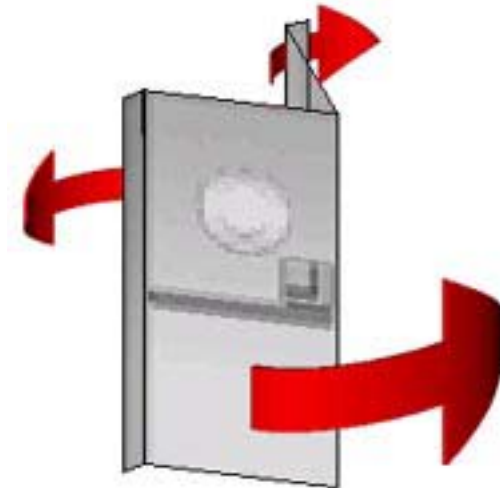

Now fold the two narrower tabs outwards at 90 degrees from the others and glue it in to the doorframe like this:

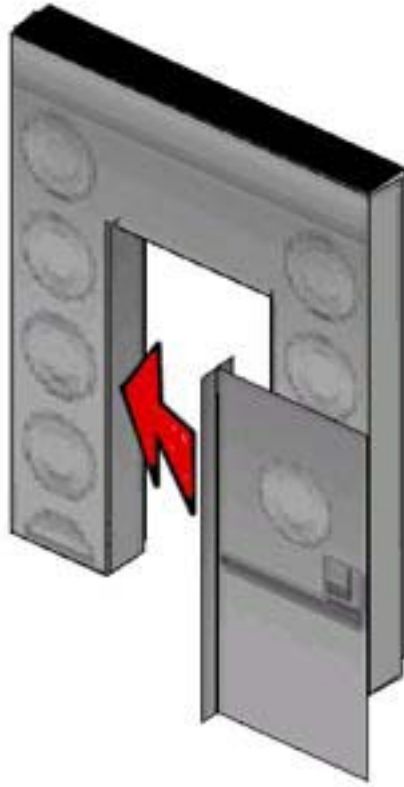

You should end up with something like this:

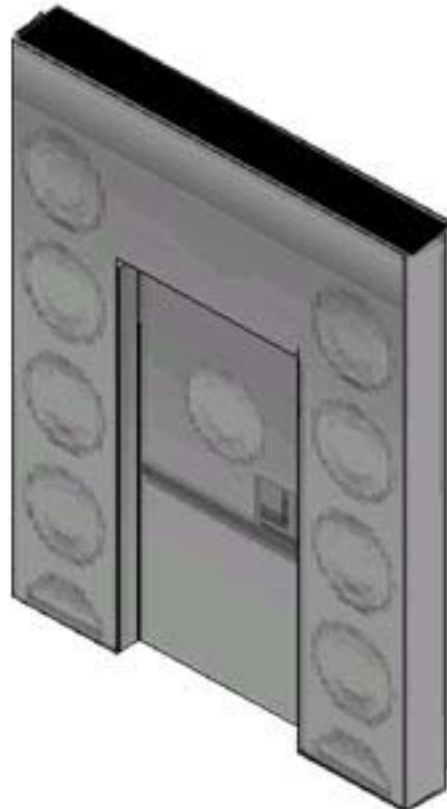

Once it is dry, the door should swing freely inwards and outwards. Several swings may be necessary to loosen it a bit and get it to move more easily.

---

## CONSOLE

As with many of the pieces of this model, the Central control console comes in two parts. Cut carefully around the outside edge of the pieces and where I have indicated in red. Next score where I have indicated with blue lines:

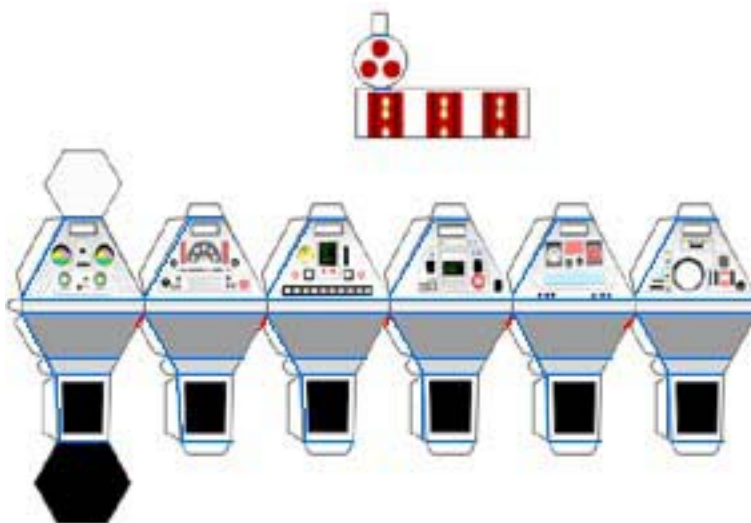

Next fold the center piece where the sections join, and tuck the tab to the first piece's right under the control panel and glue. In the example I have only shown two sections of the six that make up the control panel model. This is for my convenience, don't separate the console sections!

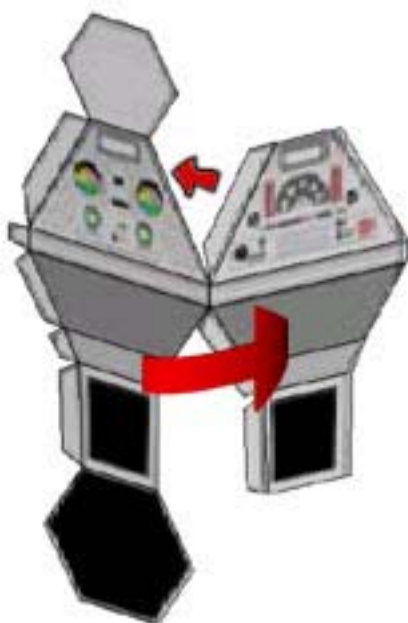

Repeat this process with all six sections. Each section should look like this:

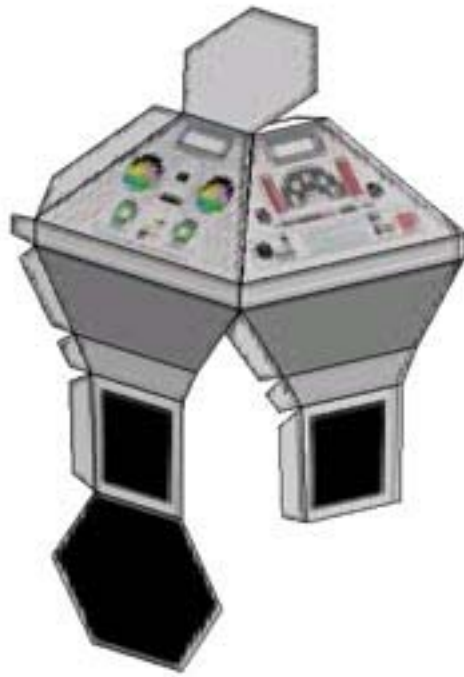

Now repeat this process underneath the console:



When all sections of the console have been glued together, fold the hexagonal cap pieces down to rest on the tabs that form a lip inside the top and bottom of the unit and glue them.

Next take the time rotor piece. Coil the long rectangular piece around a narrow shaft such as a pen - or alternatively apply pressure to each end and drag it across the corner of a table, this will coil it equally well. Once this is done, wrap the rectangular piece round in to a cylinder and fold the top and bottom circles down on to either end, gluing the tabs in place. Finally glue the time rotor on to the top of the console.

You should end up with something like this:



---

## POLICE BOX

This is quite a simple model. With the exception of the roof, it's essentially two boxes and made the same way as any paper box. First, as usual, cut carefully around the Police Box shapes and where I have indicated in red. score along the lines that I have indicated this time in yellow for clarity.

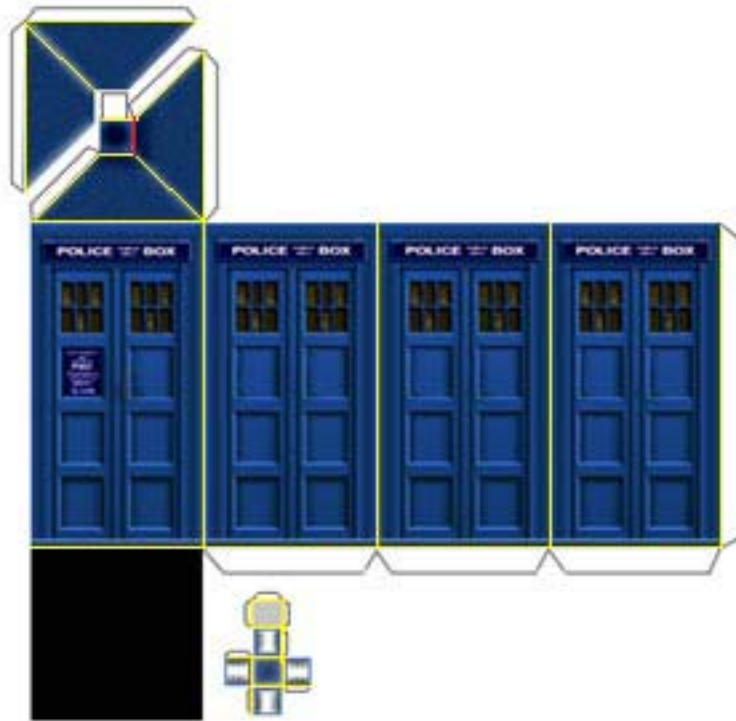

First, fold the police box round and glue the tab inside the opposite edge of the first section. Then fold up the tabs at the bottom so that they are inside the box and finally fold up the black square to create the bottom of the box.

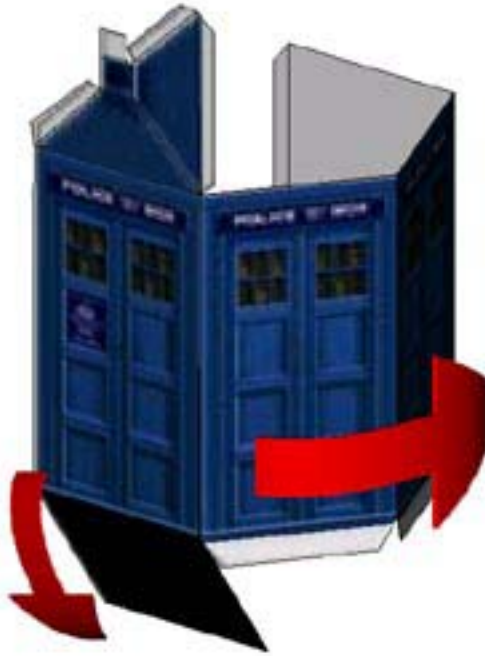

Next fold the two sections of the roof slightly to create a slight pitch. Now glue the two tabs under the two indicated edges of the other piece of roof. Glue the outer tabs to the inside top edge of the police box.

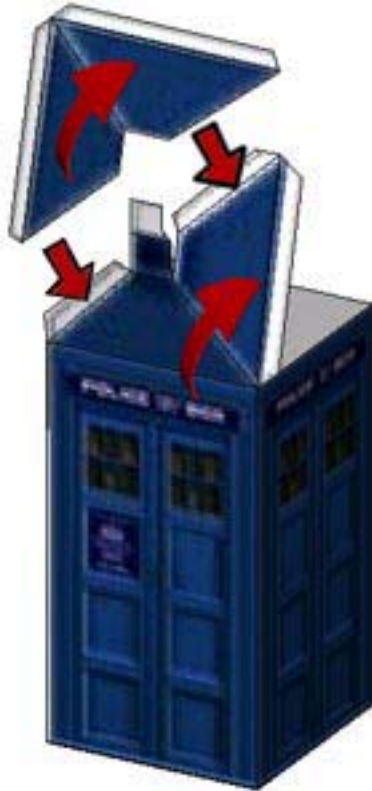

Now fold the central panel down on top of the tiny tabs to create the central flat where the light will sit. You should end up with something like this:

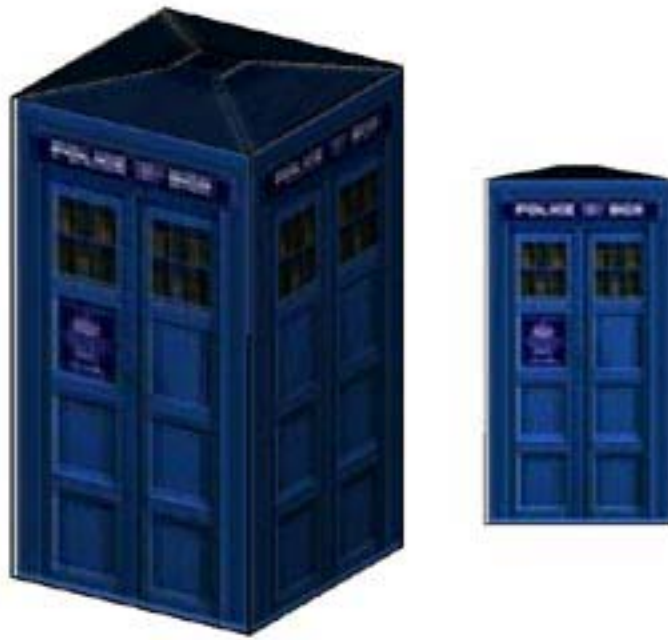

The light itself whilst being a straight forward cube box, is very very tiny and requires some extreme dexterity to make -

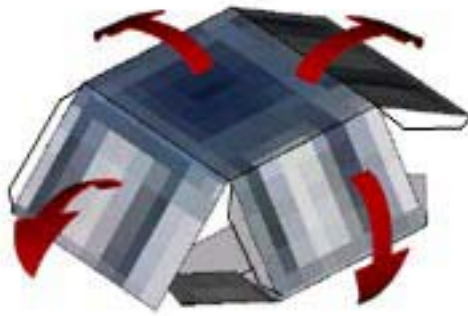

Finally glue the light on to the top of the box and the end result should look like this:





---

## Dr WHO Figure Counters

To supplement the TARDIS models, I have included several paper models of the 4th Doctor , Sarah and some Cybermen. To assemble them, simply cut carefully around the outside edge of each of the figures. and fold the tabs as so:

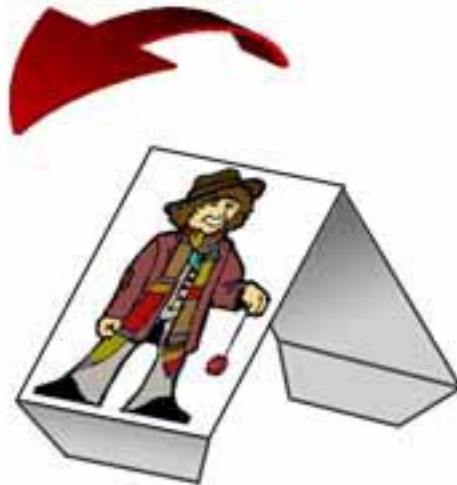

Now the tabs can be glued either way to create a base that helps the figure stay upright. Folding the tabs inwards creates a triangular cross section and gives the figure a touch more volume. Examples of both ways can be seen here:



---

## LAYOUT AND DECORATING SUGGESTIONS

How do you lay it out? Well, any way you choose really. If you're using this model for role-playing purposes then it might not necessarily be the Doctor's TARDIS. I've included some photos of how I assembled my prototype - again loosely based on the layout of the early eightees room.



Again, this tended to vary. Sometimes it had a wall of two columns next to a wall of four. My prototype has three walls of three columns and so on and so forth. The general layout from the mid-seventees onwards (and maybe even before) tended to run like this: Main doors on the extreme left. A series of walls of varying numbers of roundels along the back. Finally the monitor wall on the right followed by the interior door. The control console is always in the middle. Whatever you do, make sure you have enough room to easily move your figures about. This is how I've layed out my model.

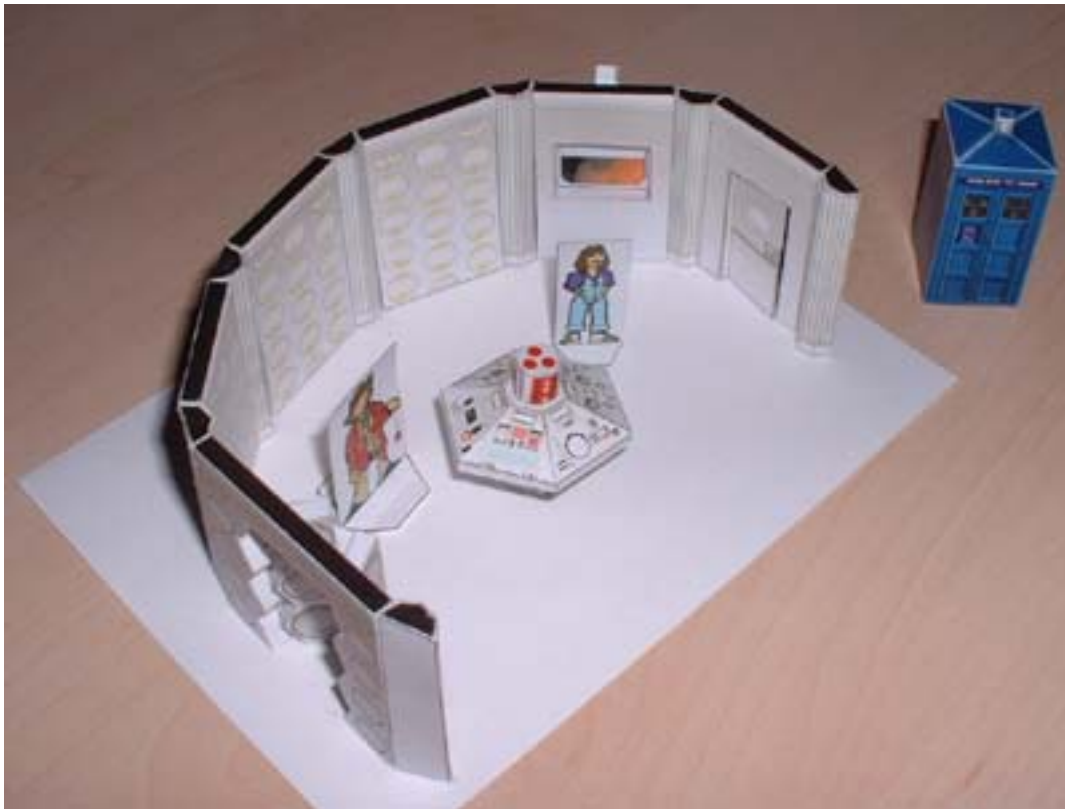

One other thing of note is that I've built my model as a stage set. If you are after a more realistic physical representation of the console room for roleplaying purposes then you have free reign to make up the nearside wall any way you choose as it was never seen in the TV series. Maybe just a series of roundels. Maybe some computer banks. In very early stories there was a glass wall in the console room with a small chamber behind it that contained machinery and controls - including the famous TARDIS fault locator - with some cling-film and some ingenuity maybe this could be built from the model parts. It's entirely up to you.

Whatever you choose to do, have fun.

Regards,

Wayne Peters

November 29th 2001

Any queries - contact me at [scarecrow@dial.pipex.com](mailto:scarecrow@dial.pipex.com)

Thanks to Craig Griswold for giving me the idea to even attempt this in the first place. Also for hosting it on his site - cheers, mate!

For those interested, I used a combination of Studio MAX to design the pieces, get them the right size and unfold them - and Photoshop with a Wacom tablet to texture and colour them. To make this instructions HTML page I used Windows notepad.